

TEAC

LE4210FHD3D EDGE-LIT LED LCD 3D TV

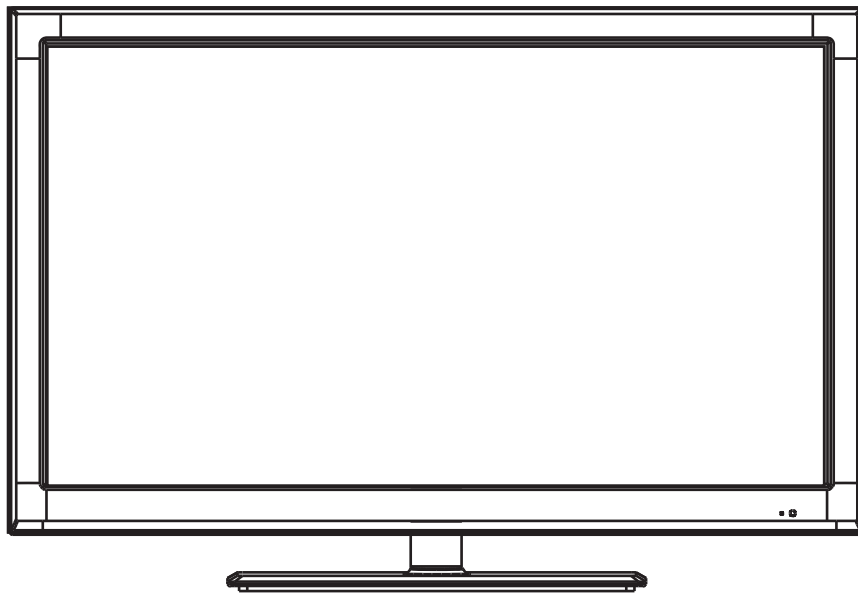

**“ For Optimum picture and sound quality,
please use TEAC Audio/Video cables ”**

TEAC High Performance Audio/Video cables and connectors have been designed to enhance your home entertainment experience.

USER MANUAL

IMPORTANT !

WARRANTY INFORMATION INSIDE. PLEASE READ

Please read the owner's manual carefully and ensure that you have followed the correct installation and operating procedures.

1. Please read this warranty card.
2. Keep your purchase receipt to enable you to proceed quickly in the event of a Warranty Service.
3. If you require Warranty Service, please contact the TEAC Customer Support Hotline at 1300 553 315 for assistance. Please ensure that you have the model number, serial number and purchase receipt ready when you call.

Please complete the section below and keep this information for your own records.

Owner's Name

Owner's Address

Postcode

Model Name/No.

Serial No.

Dealer's Name

Dealer's Address

Postcode

Authorised Service Centres in Major Australian Cities

NSW

151 Arthur Street
Homebush West, NSW 2140

Queensland

Unit 1, 320 Curtin Ave West
Eagle Farm, QLD 4009

Western Australia

Unit 2, 50 Pilbara Street
Welshpool, WA 6106

South Australia

11 McInnes Street
Ridleyton, SA 5008

Victoria

282 Normanby Road
South Melbourne, VIC 3205

Thank you for selecting a TEAC product.

If you should require assistance with your product regarding its setup or operation, or if any difficulties arise, please call us directly for advice between Monday to Friday at 8.30AM – 6PM AEST at the

TEAC Customer Support Hotline

1300 553 315

teacservicesupport@awa.com.au

www.teac.com.au

Our goods come with guarantees that cannot be excluded under the Australian Consumer Law. You are entitled to a replacement or refund for a major failure and for compensation for any other reasonably foreseeable loss or damage. You are also entitled to have the goods repaired or replaced if the goods fail to be of acceptable quality and the failure does not amount to a major failure.

Warranty Terms & Conditions

1. TEAC warrants that this product is free from defects in material and workmanship under normal domestic use with reasonable care and skill. Maintenance and cleaning (i.e. laser head) is not covered by this warranty. The TEAC warranty only applies to TEAC products purchased, used and serviced in Australia.
2. The benefits to the consumer given by this Warranty are in addition to other rights and remedies of the consumer under a law in relation to goods or services to which the warranty relates, being the Australian Consumer Law.
3. Refund or replacement via your retailer is available for a period of 14 days after purchase for goods that have been inspected and determined to have a major failure. Refund and exchange is not applicable for change of mind.
4. Subject to the terms herein, this warranty effectively covers the equipment as specified in the Warranty Periods Table below from the date of purchase.

TEAC PRODUCT	WARRANTY PERIOD
LED/LCD TV 32" (80 cm) and above	1 Year (In-Home Service/ Pick up Available)*
All other TEAC products	1 Year (Carry-in Service)

5. In Home Service/Pick up* Service

This service will only be provided as part of this warranty if all the following conditions are met;

- a) The product is indicated in the Warranty Period Table.
- b) The product is within the warranty period.
- c) The product is located within the normal service area of the local TEAC Authorised Service Centre.

If TEAC determines that the product is not repairable on site, TEAC can complete the repair by taking the product to a TEAC Authorised Service Centre.

Carry-in Service

Where In-Home service/Pick up* is not available, the purchaser is required to send the product to the nearest TEAC Authorised Service Centre for repair. In this event, proof of purchase is required to support a warranty claim. After the repair, the product will be available for collection by or return to the purchaser at a fee upon request. TEAC in-home service can be made available at a fee upon request.

6. A 12-month replacement warranty is applicable to all Accessories such as Remote, Power Adaptors and Cables.
7. TEAC will ensure to the best of its abilities that all required parts are made available for any required service/repair.
8. TEAC Australia Pty Ltd and its Authorised Service Centres will use their best endeavours to complete product repairs within a reasonable period based on available resources and workload during the time when service is requested and performed.
9. Refurbished parts may be used to repair the product. In the case of a replacement, the product may be replaced, with a refurbished unit of the same type or, if one is unavailable, a similar refurbished model with equal or better features & specifications.
10. Please be advised that if the product presented for repair is capable of retaining user-generated data, the data may be lost during servicing. Customers are strongly encouraged to back up all important information/data before sending the product in for service/repair.
11. Service will be provided only during normal business hours and under safety conditions and circumstances. TEAC and its authorised service agents can refuse any repair if safety, in relation to OH&S, becomes a concern to its staff or authorised service agents' personnel.
12. The warranty is void and warranty claims may be refused, subject to the Australian Consumer Law, if:
 - a) The product was not transported, installed, operated or maintained according to manufacturer instruction, or
 - b) The product was abused, damaged, tampered, altered or repaired by any unauthorised persons, or
 - c) Product failure is due to accidents during use, installation or transit, power surges, use of defective or incompatible external devices, exposure to abnormal conditions such as excessive temperatures or humidity, or entry of liquids, objects or creatures into the product.
13. No one is authorised to assume any liability on behalf of TEAC or impose any obligation on it, in connection with the sale of any equipment other than as stated in this warranty and outlined above.
14. TEAC reserves the right to inspect and verify whether the product is exhibiting a major failure as claimed by customers/retailers.
15. LCD dead pixel policy, please contact TEAC Customer Support Hotline on 1300 553 315 for assistance.

TABLE OF CONTENTS

1	Safety Precautions	
	1.1 Power Supply	1
	1.2 Installation	2
	1.3 Use and Maintenance	3
	1.4 Important Safety Instructions	4
2	TV Placement Setup	
	2.1 Accessories	5
	2.2 TV Stand/Wall Mounting Assembly	5-7
3	Parts & Connections	
	3.1 Front View	8
	3.2 Back View	9
4	Initial Setup & Input Sources	
	4.1 Initial Power On	10
	4.2 Selecting an Input Source	11
5	Remote Control	
	5.1 Remote Control Buttons and Functions	12
	5.2 Battery Installation	13
6	On-Screen Display (OSD) Menu	
	6.1 OSD Menu Overview	14
	6.2 Menu Map	13-15
7	TV & Electronic Programme Guide	
	7.1 ATV/DTV Mode	16
	7.2 Electronic Programme Guide (EPG)	16
	7.3 Channel Customisation	17
	7.4 Channel List and Favourite List	18
	7.5 Password Lock for Channels and Programmes	19
8	Digital Video Recording (DVR)	
	8.1 Setting up for USB Recording	21
	8.2 Instant Recording	22
	8.3 Time Shift (Pause Live TV)	23
	8.4 Scheduled Recording/Viewing Reminder	24
	8.5 Using the Recorded File List	25
9	3D Video Playback	
	9.1 Watching 3D TV	26
	9.2 3D Glasses	27
	9.3 3D Settings	27
10	USB Multimedia Playback	
	10.1 Connecting the USB Storage Device	29
	10.2 Playing Multimedia Files	29
11	Reference	
	11.1 Troubleshooting	33
	11.2 Specifications	34-35

1. SAFETY PRECAUTIONS

1.1 Power Supply

Warnings

DO NOT touch the power plug with wet hands.

- Doing so may result in electric shock.

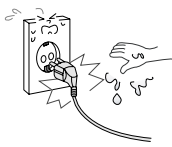

DO NOT use a damaged power cord or plug or a loose outlet.

- Doing so may result in fire or electric shock.

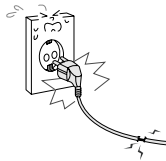

DO NOT plug several devices into the same outlet.

- A congested outlet may cause the outlet to overheat and start a fire.

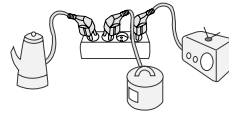

Insert the power plug fully into the outlet.

- A loose or improperly inserted power plug may result in fire.



DO NOT bend the power cord excessively or place heavy objects on it.

- Doing so may result in fire or electric shock.

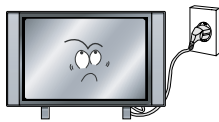

Cautions

When disconnecting the power cord from an AC outlet, always grasp it by the plug.

- Pulling on the cord can damage the internal wire and may result in a fire.

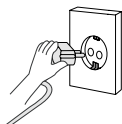

Always unplug the unit before cleaning.

- Not doing so may result in fire or electric shock.

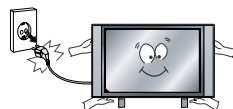

The purpose of these precautions is to ensure user safety and prevent property damage.

Be sure to read and observe all safety precautions.

It is the responsibility of the user to make sure all precautions and warnings are heeded and followed.



1. SAFETY PRECAUTIONS

1.2 Installation

Warnings

DO NOT place containers with liquids such as vases, drink cans, bottles or small metallic objects on top of the unit.

- If liquid enters the unit or any metal object falls into the unit, it may result in a short circuit, fire, or electric shock.



DO NOT place the unit where it is exposed to rain, excessive moisture or grease.

- Doing so may result in fire, electric shock, malfunction, or deformation.

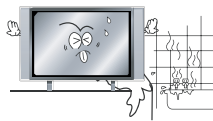

DO NOT use or store flammable or combustible materials near the unit.

- Doing so may result in fire or explosion.



DO NOT place the unit on an unstable surface, such as a sloped table, or any stand with a contact area smaller than the bottom surface of the unit stand.

- Placing the unit on a flat stable surface can prevent accidents from happening. Ignoring this precaution may result in the unit toppling over and causing injury.



DO NOT place a burning candle, burning incense, or lighted cigarette on top of the unit.

DO NOT place the unit near any heat source such as a fire-place or space heater.

- Doing so poses a serious risk of overheating and a possible fire outbreak.

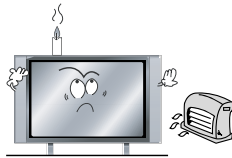

DO NOT place the unit in a poorly ventilated enclosure, such as a cabinet.

- Doing so poses a serious risk of overheating and a possible fire outbreak.

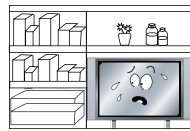

DO NOT run power cords near heat-producing appliances such as radiators, stoves, or irons.

- The excessive heat can melt the insulation and expose live wires, resulting in fire or electric shock.

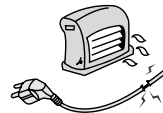

Install the antenna away from high-voltage power lines and communication cables. Make sure it is installed securely.

- If the antenna touches a power line, contact with the antenna may result in fire, electric shock, or serious injury.

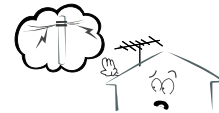

Cautions

Install the unit at an adequate distance from the wall to ensure sufficient ventilation. Insufficient ventilation may result in the unit overheating, which may cause a possible fire outbreak.

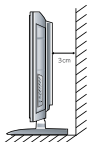

Do not cover the unit with a tablecloth, curtain, or other material.

- Insufficient ventilation may result in the unit overheating, which may cause a possible fire outbreak.

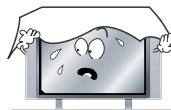

Be sure to place the unit on a level surface.



- The following precautions are divided into "Warnings" and "Cautions".

- ⚠ Disconnect this device from power by turning the power off at the AC power outlet and unplugging the AC plug.
- ⚠ Warning : Ignoring this precaution may result in death or serious injury.
- ⚠ Caution : Ignoring this precaution may result in injury or property damage.

1. SAFETY PRECAUTIONS

1.3 Use and Maintenance

Although the LCD screen is made with high-precision technology and 99.99% or more of the pixels are effective, black dots may appear or bright points of light (red, blue, or green) may appear constantly on the LCD screen. This is a property of the LCD screen and is not a malfunction.

Warnings

Disconnect the power cord from the power source during a thunderstorm.

- Not doing so may result in fire or electric shock.



DO NOT insert any metal objects, such as a screwdriver, paper clip, or a bent wire into the ventilation openings or A/V terminals.

- Doing so poses a serious risk of fire or electric shock.

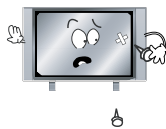

DO NOT allow children to climb onto the unit.

- The unit could topple over onto a child and result in serious injury.

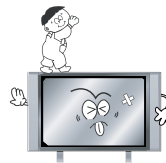

DO NOT dismantle or modify the unit in any way. Do not attempt to service the unit yourself.

- Doing so may result in fire or electric shock. If the unit requires repair, contact the service center.

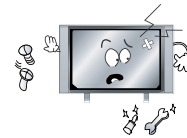

Cautions

When not using the unit for long periods of time, disconnect the power cord from the wall outlet.

- If not cleaned, clogged dust particles at ventilation holes could cause the unit to heat up, and ignite when switched on, which may result in a fire outbreak.

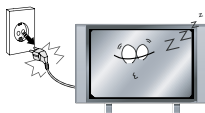

When moving the unit, be sure to turn off the unit and unplug the power cord from the wall outlet.

- Moving the unit with the power cord connected to the outlet may cause damage to the cord, resulting in fire or electric shock.

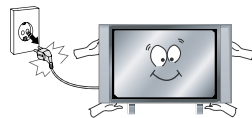

If you notice any unusual odors or smoke around the unit, immediately disconnect the unit from the outlet and contact the service center.

- Failure to do so may result in fire or electric shock.



Warnings

When removing the batteries from the remote control, make sure children do not swallow them. Keep the batteries out of the reach of infants and children.

- If a child has swallowed a battery, seek medical attention immediately.



Always have two or more people at hand to lift or move the unit.

- If the unit is dropped, it could get damaged or otherwise cause injury.



Wipe off any moisture, dirt, or dust on the power plug pins with a clean, dry cloth.

- Failure to do so may result in fire or electric shock.



Always turn off the unit and unplug the power cord when cleaning the unit. Use a soft dry cloth to clean the unit.

- Never clean with industrial strength polish, wax, benzene, paint thinner, air freshener, lubricant, detergent, or other such chemicals. Also, do not clean with a damp cloth.

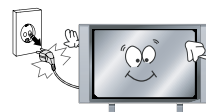

Do not display still images and partially still images on the LED panel for more than 2 hours as it can cause screen image retention. This image retention is also known as "screen burn". To avoid such image retention, reduce the degree of brightness and contrast of the screen when displaying a still image. Watching the LED TV in 4:3 format for a long period of time may leave traces of borders displayed on the left, right and centre of the screen caused by the difference of light emission on the screen. Playing a DVD or a game console may cause a similar effect to the screen. Damages caused by the above effect are not covered by the Warranty. Displaying still images from Video games and PC for longer than a certain period of time may produce partial after-images. To prevent this effect, reduce the 'brightness' and 'contrast' when displaying still images.

1. SAFETY PRECAUTIONS

1.4 Important safety Instructions

Warnings and Precautions

To prevent any injuries, the following safety precautions should be observed in the installation, use, servicing and maintenance of this device. Please read this manual carefully and keep it for future reference.

1. Read these instructions.
2. Keep these instructions.
3. Heed all warnings.
4. Follow all instructions.
5. Clean only with a dry cloth.
6. Do not block any of the ventilation openings. Install in accordance with the manufacturer's instructions.
7. Do not install near any heat sources such as radiators, heat registers, stoves or other devices (including amplifiers) that produce heat.
8. Do not defeat the purpose of the polarized or grounding type plug. A polarized plug has two blades with one wider than the other. A grounding type plug has two blades and a third grounding prong. The wide blade or the third prong is provided for your safety. If the provided plug does not fit into your power outlet, consult an electrician to replace the power socket.
9. Do not bend the power cord excessively. Prevent the cord from being walked on or pinched by weights placed on it.
10. Only use the attachments/accessories specified by the manufacturer.
11. Use only with a cart, stand, tripod, bracket or table specified by the manufacturer, or sold with the device. When a cart is used, use caution when moving the cart and device.
12. Unplug this apparatus during lightning storms or when unused for long periods of time.
13. Refer all servicing to qualified service personnel. Servicing is required when the apparatus has been damaged in any way.



This symbol indicates that dangerous voltage instituting a risk of electric shock is present within this device.



This symbol indicates that there are important operation and maintenance instructions in the documentation accompanying this device.

① NOTE:

- To prevent damage which may result in fire or hazards, do not expose the device to rain or liquids.
- Do not place objects containing liquids, such as vases on the device. If drinks and liquids have been spilled on the device, unplug the device from AC power immediately and contact the TEAC Customer Hotline for assistance.
- Servicing of this device should be conducted by qualified and certified TEAC service personnel.
- The manufacturer will not be held responsible for any damage caused by modifications done on the device without authorisation from the manufacturer's authorised service agent.

2. TV PLACEMENT SETUP

2.1 Accessories

The appearance of the components may look different from the following figures.

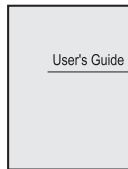

User's Guide



Mains cable



Remote Control



2 x AAA Battery

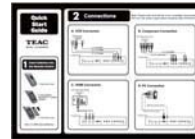

Quick Start Guide



Contact Card

2.2 TV Stand/Wall Mounting Assembly

This TV comes ready to be set up with the provided TV stand. Alternatively, opt to mount the TV on the wall by obtaining a wall mount bracket and mounting eyebolts/screws (thread size M4 x 10) from your local hardware store. For best results, we recommend that wall mounting should be performed by a professional installer.

NOTE:

- The TV should be levelled or angled directly at the viewer's eye.
- Allow a space of 10cm around the TV to reduce risk of overheating.
- The TV stand allows sideways turning of the TV to a limited degree. Do not force it to turn more than it can as you will damage the stand.

CAUTION

- Make sure the TV is completely disconnected and unplugged from power.
- To prevent damage to the TV screen, avoid touching or pressing on the screen with hands or objects at any time. Do not press on the front panel as it may damage the screen.
- To protect the TV from damage or scratching, only place the TV on a soft, flat surface like a table covered with a cotton towel or foam mat.
- Assembly, lifting and moving of the TV must be done by at least 2 people to prevent unit damage or physical injury from accidents.
- Ensure that all screws are tight and secure after assembly, so that the stand or mounting bracket is stable enough to prevent the TV from falling and causing personal injury or property damage.
- Make sure that the TV is not knocked or pulled down from its position. Prevent children and pets from playing with or climbing on the TV. If the TV falls, it may cause personal injury or property damage.
- If the TV stand or wall mounting bracket is damaged, do not use it to support the TV. Contact your dealer immediately.

2. TV PLACEMENT SETUP

TV Stand Installation/Removal

1. Place the unit face down on a soft surface.
2. Gently position the glass base to the leg at the bottom of the TV.
3. Fasten the 4 provided screws (screw size B4x16F) to secure the stand to the TV according to the diagram.
4. To remove the stand, reverse the steps above.

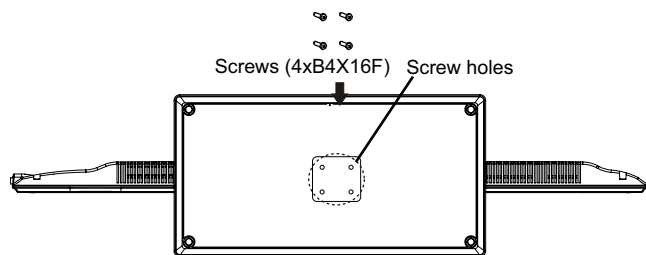
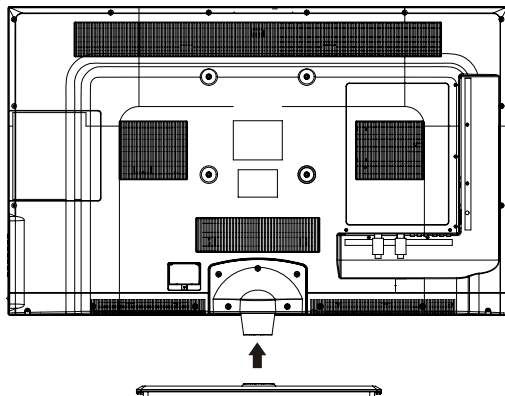

Fall Prevention

To prevent the TV from tilting forward and falling over to cause damage or injury, please secure the TV to your table or wall using screws or eyebolts and strong cord (not provided). An example on fixing the TV to a table is shown below

1. Install a wood screw or eyebolt into the table that is supporting the TV.
2. Fix a machine screw into a screw hole near the base in the back of the TV.
3. Tie the wood screw or eyebolt to the machine screw with a strong cord.

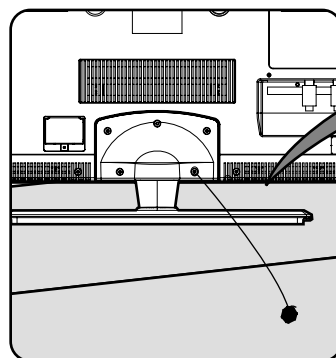
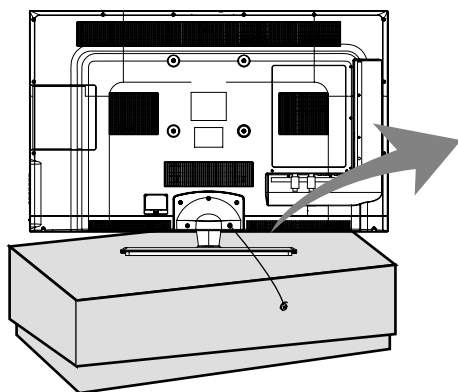

Alternatively, secure the TV to the wall directly behind it by fixing eyebolts to the wall and tying them to screws fixed on the centre of the TV back panel.

2. TV PLACEMENT SETUP

Wall Mounting

1. Ensure that the selected wall is made of appropriate material and can support the weight of the TV. Make sure there are no pipes or cables inside the wall on your chosen position.
2. Obtain a suitable wall mounting bracket and mounting eyebolts (thread size M4x10) and screws from your local hardware store.
3. Place the unit face down on a soft surface.
4. Remove the attached leg at the bottom of the TV by removing the 5 screws on the leg cover.
5. Refit the cover securely by replacing the 5 screws into their original positions.

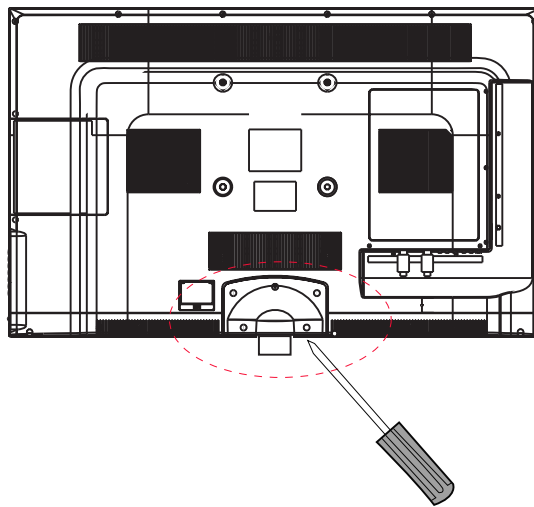

6. Fasten 4 eyebolts into the four screw holes on the TV's rear panel according to the diagram.
7. Fasten the wall mounting bracket using screws onto the wall.
8. Connect the eyebolts and the wall bracket securely with strong rope
9. Carefully check that all fastenings are secure before releasing the TV.

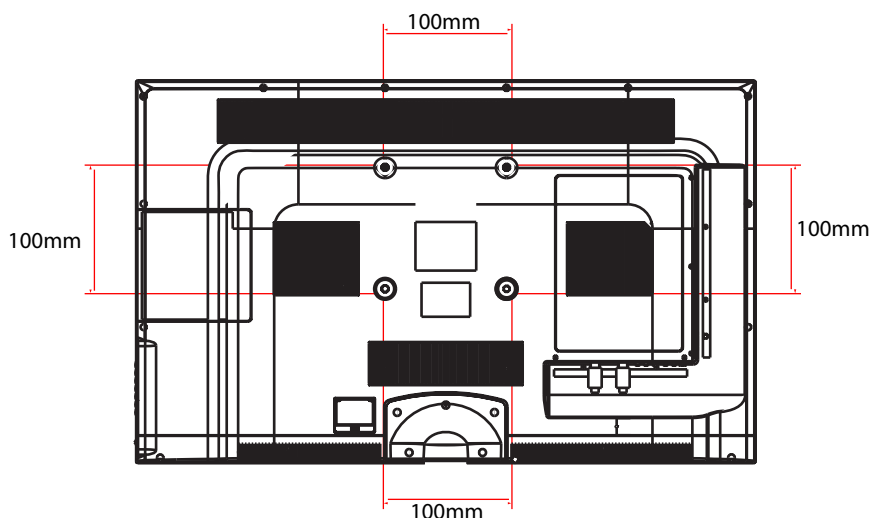

❖ Thread hole size – M4 x 10 depth (TV Mounting Screw Size) on the TV.

3. PARTS & CONNECTIONS

3.1 Front View

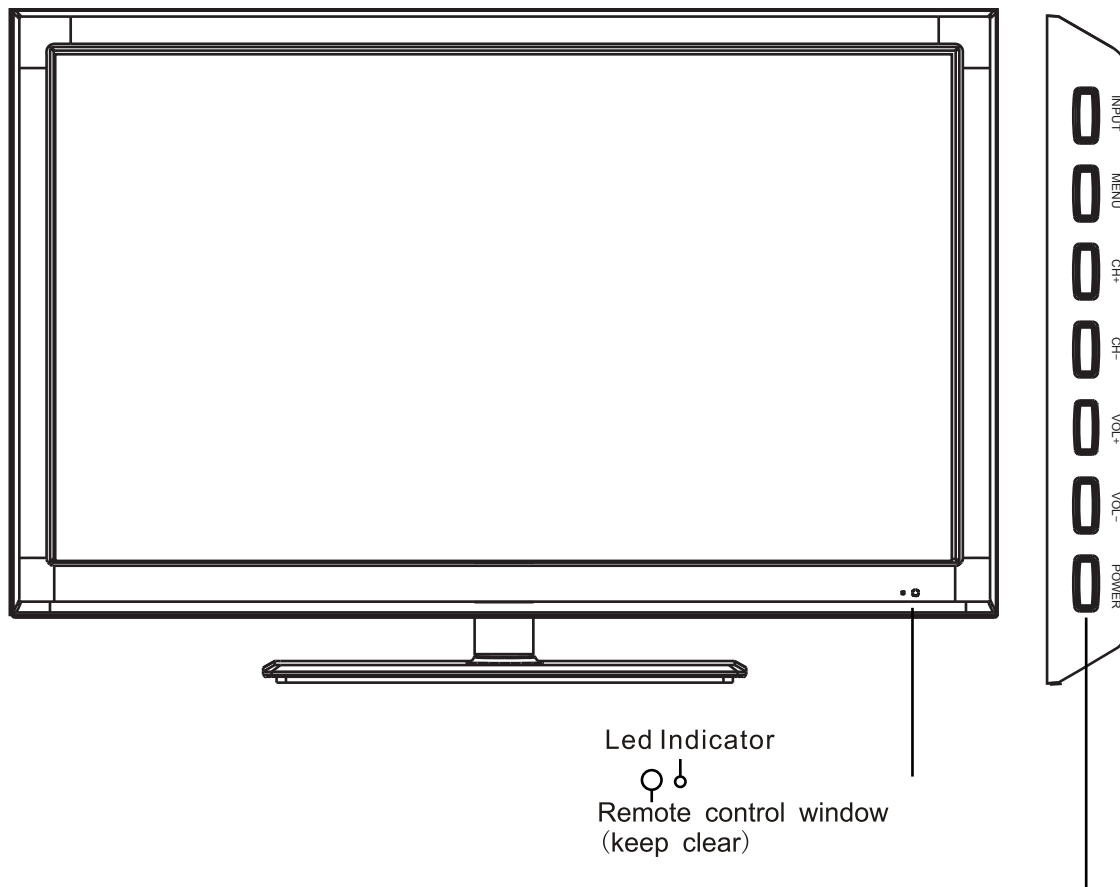

Led Indicator
Remote control window
(keep clear)

INPUT: Display the input source menu.
MENU: Display/exit the OSD menu.
CH+/-: Scan through channels.
VOL+/-: Adjust the volume.
POWER: Turn on/standby the TV set.

3. PARTS & CONNECTIONS

3.2 Back View

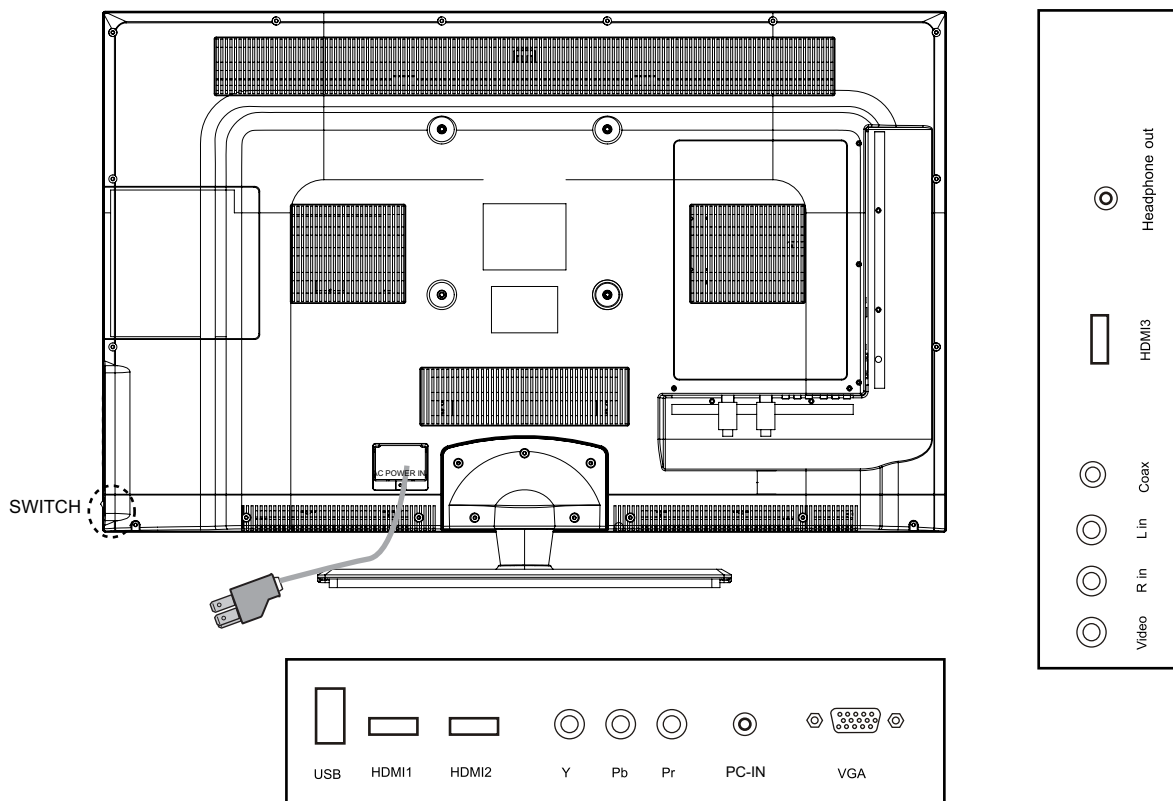

Part Name	Function
Power Switch	Turn on/off the power supply.
AC Power In	Connect to the AC power supply
USB	Connect to a USB storage device for DVR (Recording) and USB Multimedia Playback
HDMI 1/2/3	Connect to the HDMI socket of your DVD or satellite box
YPbPr	Connect to the component YPbPr output of external devices
PC IN	PC audio input
VGA	Connect to the PC VGA output to display PC graphics
Video	Connect to the composite video output of external devices
Audio L/R In	Audio signal input for AV (shared with YPbPr)
COAX	Digital output to AV receiver
Headphone	Connect to headphones
RF	Connect to antenna or cable source













CAUTION

- Make sure that the TV is completely disconnected and unplugged from power before making or changing cable connections.
- Make sure that the power output from your power source matches the power input labelled on the TV adapter.

4. INITIAL SETUP & INPUT SOURCES

4.1 Initial Power On





When the TV is turned on the first time out of the box or after a factory settings reset, it will prompt you to run auto channel tuning.



1. Connect the TV to your antenna wall socket using a coaxial TV cable.
2. After making sure all connections are secure, plug in the power cord and turn on AC power.
3. Press  on the remote control to turn on the TV.
4. The TV will initialise and prompt you to choose between Home Mode and Shop Mode. Home Mode is recommended for optimal energy saving. Choose with     and press  to proceed.
5. Next, a tuning menu will display. Adjust the settings with     and press  to start tuning.
6. After tuning is complete, the TV will display programmes from detected channels.

 **NOTE:** If no channels are detected, please check the connection and condition of your external antenna.

4.2 Selecting an Input Source

To play different media types and from any connected external device, change input sources to activate the desired connection.

1. Press  to display the list of input sources.
2. Press   to choose an input source.
3. Press  to confirm.

DTV, USB and HDMI can also be accessed using the shortcut buttons  and .

This TV starts in DTV mode by default when it is switched on for the first time. Subsequently, it will start in the most recently selected input mode.

 **NOTE:** Please make sure the device is connected before selecting the input source.,

Input Source
DTV
ATV
AV
PC
YPbPr
HDMI1
HDMI2
HDMI3
USB
 Move  Select  Quit

5. REMOTE CONTROL

The remote control uses Infrared signals. Point it at the Infrared sensor at the front of the TV.

NOTE: The remote control may not work correctly if it is operated out of range or angle, or if there are objects blocking the signal.

5.1 Remote Control Buttons and Functions



POWER: Switch the TV on or off Standby mode.
DTV/USB: Switch to DTV/USB Mode.
3D: Access the 3D Setup Menu.
INPUT: Access the Input Source Menu.
HDMI: Cycle through HDMI Modes 1-3.
P MODE: Cycle through preset picture profiles.
S MODE: Cycle through preset sound profiles.
MEDIA CENTER: Function not available.

DELETE: Delete files from the Recorded File List.
REC. LIST: Display the Recorded File List.
SCH.LIST: Display the Schedule List.
SCREEN: 1. While playing music, turn off the screen.
 2. In HDMI Mode, change between Video and PC Modes.
 3. In VGA Mode, auto-align the screen.

MENU: Switch the TV on or off Standby mode.
SUBTITLE: Choose from available subtitles.
AUDIO: Choose from available audio tracks.
EPG: Access the Electronic Programme Guide.
DISPLAY: Display detailed information or controls.
 ▲ ▼ ◀ ▶ : Directional navigation buttons.
OK: Confirm a setting.
CH+/-: Browse next/previous channel.
VOL+/-: Adjust volume level.
EXIT: Exit menu or return to last level.
MUTE: Toggle audio output muting.
Number Buttons: Key in numbers to view channels or other option inputs.
 ↶ : Return to the most recently viewed TV channel.
CH.FAV: Show Channel List, then Favourite Channels List.

5. REMOTE CONTROL



● **(REC)**: Start recording when in DTV Mode.
REPEAT: Toggle Repeat options in USB Mode.
 ▲ : No Function.
 ▶||: Play/Pause playback, or toggle DTV Time Shift.
 ■: Stop playback.
 ◀▶: Fast Rewind/Fast Forward up to 16x.
 ◀▶▶: Previous/next chapter/track.
 ◀||▶: Function not available.
D.MENU: Function not available.
D.TOPTITLE: Function not available.

Teletext operation:

Teletext is an information system broadcasted by certain channels providing news, weather forecasts, puzzles as well as subtitles. Subject to availability.

SUBPAGE: Toggle subpage.

HOLD: Hold or resume browsing the subpage.

SIZE: Cycle through page zoom-in views.

INDEX: Go to Index.

CANCEL: Cancel the Teletext Display.

REVEAL: Reveal any hidden text.

TV/TXT: Toggle Teletext viewing modes.

Colour buttons: Shortcut keys per on-screen hints.

D.SETUP: Function not available.

2nd AUDIO: Function not available.

BONUS VIEW: Function not available.

GOTO: Jump to a specific point during playback.

A-B: Define Points A and B for looping playback.

RANDOM: Function not available.

ASPECT: Cycle through different picture aspect settings.

ANGLE: Choose alternative camera angles if available.

SLEEP: Cycle through and set Timer Sleep settings.

5.2 Battery Installation

⚠ CAUTION

- To prevent damage to the remote control, make sure to install batteries correctly. Do not mix old and new batteries.
- Dispose of batteries safely and appropriately. Contact your local authorities or dealer for advice on battery disposal.
- Keep batteries out of reach of children.

1. To open the battery compartment, press on the battery cover and slide it out.
2. Insert 2 AA batteries, making sure to match +/- polarities as marked in the compartment.
3. Close the battery cover.

6. ON-SCREEN DISPLAY (OSD) MENU

6.1 OSD Menu Overview

The OSD menu system acts as the Main Menu and allows access to main feature controls as well as optional user settings.

NOTE: Certain menus are available only in their relevant input modes.



Navigating the OSD

1. Press **MENU** to display the OSD.
2. Use **◀ ▶** to navigate to different menus via the tabs at the top.
3. Use **▲ ▼** to enter a menu and select available settings or submenus.
4. Use **◀ ▶** or press **OK** on a selected item to adjust settings or enter a submenu.
5. Press **OK** or **◀** to confirm a setting and continue browsing the menu. If you have entered a submenu, please follow the hints at the bottom of the screen, or refer to the relevant sections in this user manual for operation details.
6. Press **MENU** again to exit the menu, or **EXIT** to exit the OSD completely.

6.2 Menu Map

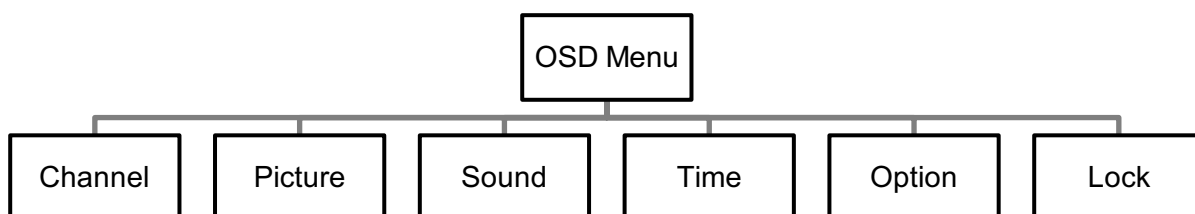

6. ON-SCREEN DISPLAY (OSD) MENU

Menu	Option	Description
CHANNEL	Auto Scan	Tune channels automatically. This will overwrite any previously saved channels and channel settings.
	DTV Manual Tuning	Tune digital TV channels manually.
	ATV Manual Tuning	Tune analogue channels manually.
	Channel Edit	Customize channel list display and channel access.
	Signal Information	Display detailed channel signal information.
	Record Start	Start recording the current DTV channel at once.
	Recorded List	Display the Recorded File List.
	Record Mode	Schedule a future recording.
	Schedule List	Display the Schedule List.
	Free Record Limit	Set a recording limit between 1 – 6 hours.
	DVR File System	Access the DVR File System Menu.
	<ul style="list-style-type: none"> ▪ Select Disk 	Select a connected USB storage device.
	<ul style="list-style-type: none"> ▪ Check DVR File System 	Check if the selected USB storage device is compatible.
	<ul style="list-style-type: none"> ▪ USB Disk 	Show if the selected USB storage device is compatible.
	<ul style="list-style-type: none"> ▪ Format 	Format the selected USB storage device.
<ul style="list-style-type: none"> ▪ Time Shift Size 	Available data storage space for Time Shift recording	
<ul style="list-style-type: none"> ▪ USB Speed 	Shows the speed of the selected USB storage device.	
PICTURE	Picture Mode	Choose from preset picture settings profiles. Choose 'User' for manual customisation.
	Contrast	Adjust picture contrast.
	Brightness	Adjust picture brightness.
	Colour	Adjust picture colour.
	Sharpness	Adjust picture sharpness.
	Tint	Adjust picture tint. (NTSC format only)
	Colour Temperature	Adjust colour temperature.
	Red	Adjust Red colour level.
	Green	Adjust Green colour level.
	Blue	Adjust Blue colour level.
	Aspect Ratio	Adjust picture aspect ratio.
	Noise Reduction	Adjust noise reduction settings.
	SCREEN	PC Mode: Access the submenu to adjust the Horizontal/Vertical position, Size or Phase of the picture.
	Over Scan	HDMI Mode: Choose between Video and PC.
	3D Setup	Access the 3D Setup Menu.
	<ul style="list-style-type: none"> ▪ 3D Detect 	Auto detect 3D for 3D Blu-ray discs.
	<ul style="list-style-type: none"> ▪ 3D Type 	Off, Side by Side, Top Bottom, Frame Packing, Line by Line
<ul style="list-style-type: none"> ▪ Exchange 3D L/R 	Adjust this if the 3D depth is reversed.	
<ul style="list-style-type: none"> ▪ 3D to 2D 	Toggle 3D to 2D video conversion.	

6. ON-SCREEN DISPLAY (OSD) MENU

SOUND	Sound Mode	Choose from preset sound setting profiles. Choose 'User' for manual customisation of Treble and Bass.
	Treble	Adjust the relative intensity of higher pitched sounds.
	Bass	Adjust the relative intensity of power pitched sounds.
	Balance	Adjust the balance of the Left and Right audio tracks.
	Auto Volume	Turn on/off automatic programme volume control.
	Surround Sound	Turn Surround Sound off/on.
	SPDIF Mode	Select between Off, PCM and Auto.
TIME	Clock	Set the current time. In DTV Mode, the time is set according to broadcaster signals and cannot be changed.
	Off Time	Set a time of day and frequency for the TV to turn off.
	On Time	Set a time of day and frequency for the TV to turn on.
	Sleep Timer	Set the TV to turn off after a certain amount of time.
	Auto Sleep	Set the TV to turn off after it has not received any control signals for a certain amount of time.
	Time Zone	Select the time zone.
OPTION	OSD Language	Set the language for the OSD Menus.
	Audio Language 1 st / 2 nd	Select the 1 st /2 nd preferred language track to be selected if it is available from the broadcaster.
	Subtitle Language 1 st / 2 nd	Select the 1 st /2 nd preferred language track to be selected if it is available from the broadcaster.
	OSD Duration	Adjust the time needed before the OSD Menu auto hides.
	Blue Screen	Turn on/off the blue screen display during 'No Signal'.
	Country	Shows current country that was set during Auto Tuning.
	Auto Software Update	Turn automatic software update on if you wish the TV to automatically scan for new firmware updates at night.
	Restore Factory Default	Reset all settings to factory defaults. All channels and personalised settings will be erased.
	Backlight	Adjust backlight settings.
LOCK	Lock Channel	Set channel/programme locking on/off with a password.
	Set Password	Change the password.
	Block Program	Password-lock all programmes from chosen TV channels.
	Parental Guidance	Password-lock all programmes at and beyond a chosen programme rating.

7. TV & ELECTRONIC PROGRAMME GUIDE (EPG)

7.1 ATV/DTV Mode

Start watching TV by pressing **INPUT** to switch to the ATV (Analogue TV) or DTV (Digital TV) input source. For detailed steps on changing inputs, please see the Input Source section.

ATV and DTV depends on the broadcasting services available in your locality. The quality of received channels depends on the strength of the signal reception in your location. We recommend using an external antenna connection to receive channels.

Tune to TV channels using Auto Scan or Manual Tuning.

Auto Tuning

Run a complete scan for channels and save all detected channels into the Channel List.

1. Press **MENU** and navigate to the CHANNEL Menu.
2. Use **▲ ▼** and **OK** to select the Auto Tuning option.
3. Use **◀ ▶** to adjust Country and Tune Type options.
4. Press **OK** to start scanning.

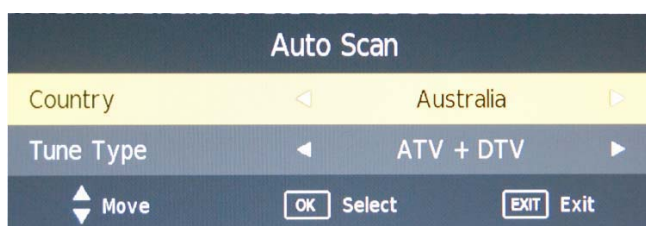

NOTE:

- Auto Tuning will overwrite all previously saved channels and channel settings.
- If the ATV+DTV option is selected, the first 50% of the scan represents ATV tuning, while the other 50% represents DTV tuning.
- Press **EXIT** if you wish to stop tuning halfway through the process.

DTV Manual Tuning

Scan a specific DTV frequency and save detected channels into the Channel List.

1. Press **MENU** and navigate to the CHANNEL Menu.
2. Use **▲ ▼** and **OK** to select the DTV Manual Tuning option.
3. Use **◀ ▶** to select a DTV channel.
4. Press **OK** to start scanning.



ATV Manual Tuning

Scan a specific ATV frequency and save detected channels into the Channel List.

1. Press **MENU** and navigate to the CHANNEL Menu.
2. Use **▲ ▼** and **OK** to select the ATV Manual Tuning option.
3. Use **▲ ▼ ◀ ▶** to adjust scanning options.
4. Press **OK** to start scanning.
5. Press **DELETE PROG** to save any changes.

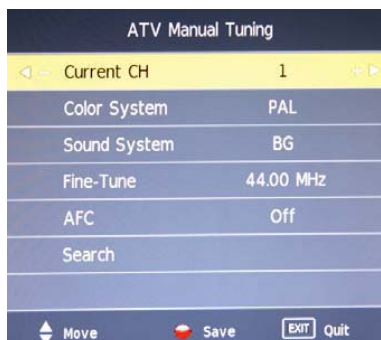







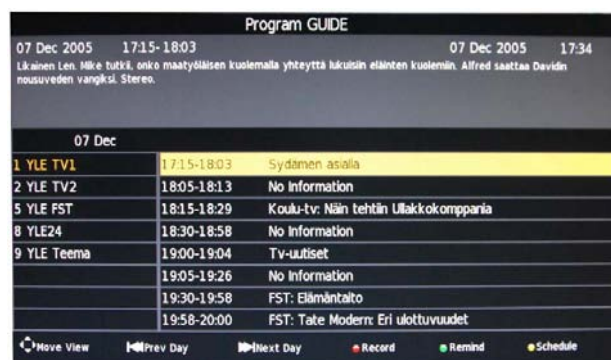

7. TV & ELECTRONIC PROGRAMME GUIDE (EPG)

7.2 Electronic Programme Guide (EPG)



While using DTV Mode, press  to display the EPG. EPG is not available in ATV Mode.



Browsing the EPG







1. Change channels using   to navigate and press  to tune into a highlighted channel.
2. View channel guides when tuned in to the relevant channels by using  .
3. Browse channel schedules up to 7 days in advance with  and .
4. Press  or  to exit the EPG.

NOTE:

- You need to tune in to a channel before its schedule is displayed.
- EPG schedules are available up to 7 days in advance from the broadcaster.
- While a future programme is highlighted, press  to schedule automatic timed recording, or press  to schedule a viewing. Please see the DVR section for detailed instructions.

7.3 Channel Customisation



Make personal changes to the channel list in the Channel Edit menu. Different options are available for ATV and DTV channels.

1. Press  to display the OSD.
2. Use   to navigate to CHANNEL Menu \rightarrow Channel Edit and press .
3. If password locks are enabled, key in the password to enter the Channel Edit menu.
4. Customise your channels according to the instructions below.
5. Press  again to exit the menu, or  to exit the OSD completely.





7. TV & ELECTRONIC PROGRAMME GUIDE (EPG)

Favourite Channels

1. Use ▲ ▼ ◀ ▶ to highlight a desired channel.
2. Press  to mark it as a Favourite Channel. This channel will now be listed in the Favourite Channel List.
3. To remove it from the list, press  again to remove the 'Favourite' mark.

Skip Channels

1. Use ▲ ▼ ◀ ▶ to highlight a desired channel.
2. Press  to mark it to be skipped. This channel will now be skipped when you browse TV channels with . It will still be accessible from the Channel List and EPG.
3. To remove the channel's Skip status, press  again to remove the 'Skip' mark.

Delete Channels

1. Use ▲ ▼ ◀ ▶ to highlight a desired channel.
2. Press  to delete it.
3. Press ◀ to confirm or ▶ to cancel the deletion.



❗ **NOTE:** To add a deleted channel into the list again, you will have to scan for it via Auto or Manual Tuning. See the Tuning section for detailed instructions.

Rename Channels

This feature is only available for ATV channels. DTV channels cannot be deleted.



1. Use ▲ ▼ ◀ ▶ to highlight a desired channel.
2. Press  to start renaming and use ▲ ▼ ◀ ▶ to enter the new channel name.

Move Channels

1. Use ▲ ▼ ◀ ▶ to highlight a desired channel.
2. Press  to mark it to be moved, then use ▲ ▼ to move it to a desired position.
3. Press  again to confirm the new position.

7.4 Channel List and Favourite List

Use the Channel List and Favourite Channel List to change channels with ease.

1. Press  to display the Channel List.
2. Press  a second time to display the Favourite Channel List.
3. Use ▲ ▼ to select a channel and  to tune into the channel.

7. TV & ELECTRONIC PROGRAMME GUIDE (EPG)

7.5 Password Lock for Channels and Programmes

Use the LOCK Menu in the OSD for password settings. This menu requires password access. The default password is 0000. If you have forgotten your password, use the master password 4711.

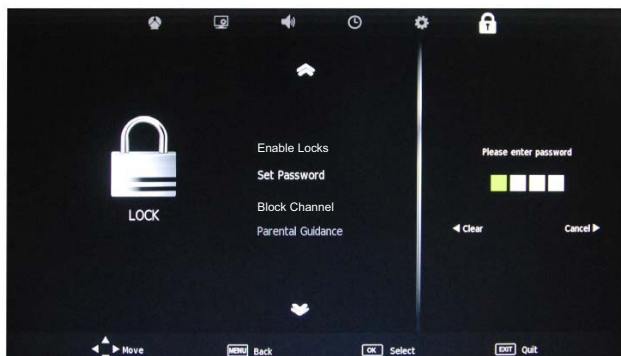

Enable Locks

This option MUST be turned on to use any password locks for channels and other settings.

1. Press **MENU** to display the OSD.
2. Use **◀ ▶ ▲ ▼** to navigate to LOCK Menu. You will need the password for access.
3. Select Enable Locks and use **◀ ▶** to turn it On or Off as desired.

Password Customisation

Set your personal password with the following steps.

1. Press **MENU** to display the OSD.
2. Use **◀ ▶ ▲ ▼** to navigate to LOCK Menu. You will need the password for access.
3. Navigate to Set Password and press **OK**.
4. Key in the current password (the default password is 0000).
5. Key in the new password carefully.
6. Key in the new password once more to confirm and save the new password.

i NOTE:

- The default password is 0000. If you have forgotten your password at any time, use the master password 4711 to reset your personal password.

Channel Locking

Lock specific TV channels so that they can only be viewed after using the right password.

1. Press **MENU** to display the OSD.
2. Use **◀ ▶ ▲ ▼** to navigate to LOCK Menu. You will need the password for access.
3. Select Enable Locks and set it to 'On'.
4. Select the Block Channel option and press **OK**. The Channel Lock list will display.
5. Highlight a desired channel with **▲ ▼** and press **REC.LIST** **BookMark** to lock it. Press again to unlock.
6. Press **EXIT** to exit.



7. TV & ELECTRONIC PROGRAMME GUIDE (EPG)

Parental Control for Rated Programmes

Lock specific TV programmes by rating so that they can only be viewed after using the right password.

1. Press  to display the OSD.
2. Use ◀ ▶ ▲ ▼ to navigate to LOCK Menu → Lock Channel and set it to 'On'. A password will be required to change this setting. See the Password Customisation section for details.
3. Use ◀ ▶ ▲ ▼ to select Parental Control and choose a rating limit. Programmes with the chosen rating and any ratings beyond it will be locked.

NOTE:

- Programme ratings depend on availability from the broadcasting service.
- Locked programmes or channels cannot be recorded unless they are already being accessed using the password. Please keep this in mind when scheduling recordings.

8. DIGITAL VIDEO RECORDING (DVR)

This feature allows the recording of TV programmes to a compatible USB storage device like a hard disk drive or thumb drive. While recording is in progress, the front panel LED light will flash red and green.

NOTE:

- USB devices such as mobile phones, MP3 players and cameras do NOT support file recording.
- Recorded file sizes depend on the broadcast content, up to several GB per hour.

For best recording and playback results, we recommend using a USB storage device with:

- A. Data storage capacity up to 1.5TB
- B. Maximum disk partition size 400GB
- C. An external power supply
- D. Maximum USB extension cable length 50cm.

8.1 Setting up for USB Recording

1. Connect the USB storage device to the USB port on the back panel of the TV.
2. If the USB storage device uses its own power supply, make sure it is turned on.
3. Press **MENU** to display the OSD.
4. Use **▲ ▼** to navigate to CHANNEL Menu → DVR File System and press **OK** to access the setup options in the DVR File System Menu, as described below.

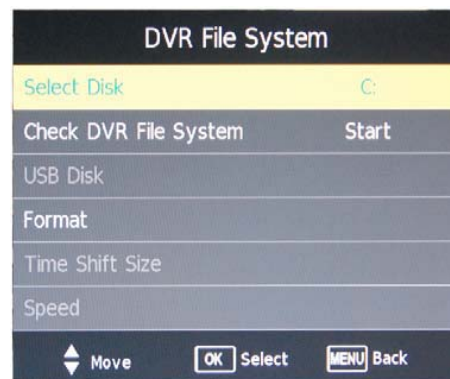

Selecting a Disk Drive and Checking Compatibility

Select a desired USB storage device for recording if multiple devices are connected. Then check if the connected USB storage device is compatible and ready for recording.

1. Select a disk drive using the Select Disk option.
2. Select Check DVR File System in the DVR File System Menu and press **OK**.
3. One of the following messages will appear: 'SUCCESS' for a compatible device and 'FAIL' for an incompatible device.

NOTE:

- This TV will always use the first partition (C:\) for recording purposes. If your hard disk contains more than one partition, please use the first partition for recording purposes.
- Failure to identify the File System may also be due to insufficient memory space on the storage device, or a faulty USB cable. Try another USB storage device with a larger capacity or another USB cable.
- If no device is connected, this detail will be greyed out.

Formatting a Disk

You may need to format the USB storage device for reasons such as:

- A. The device is currently in an incompatible format.
- B. The device's file system is damaged and needs to be rewritten via formatting.
- C. You wish to wipe all data from the device to begin again with an empty drive.

8. DIGITAL VIDEO RECORDING (DVR)

Formatting will ensure that the USB storage device is in the FAT32 file system and that there is enough storage space available for recording programs.

⚠ CAUTION

- Formatting will erase ALL data on the storage device! Please back up all valuable data before proceeding to format. TEAC is not responsible for any lost data due to formatting.

1. Select the disk drive to be formatted.
2. Select the Format option in the DVR File System Menu and press **OK**.
3. Select the FAT32 option and press **OK** to start formatting.



ⓘ NOTE:

- The FAT32 file system is best for high speed storage devices. High Speed FS is best for low speed storage devices.
- After formatting into the FAT32 file system, you will still be able to store and share other media files on the same storage device.
- Storage devices formatted in High Speed FS system can only be used to record from this TV and cannot store other media files.



Time Shift Size

After the USB storage device is formatted into the FAT32 file system, Time Shift cannot be altered. During 'DVR File System Check', the display will show that the whole storage device space will be used for Time Shift. However, Instant and Scheduled Recording will still have priority over available storage space.

For details on using Time Shift, please see the Time Shift section.

8.2 Instant Recording



When a compatible USB (DVR) storage device is connected, you can record TV programmes at will with the press of a button. While recording is in progress, the TV's LED light will flash.

1. Press **REPEAT** while watching TV to start recording. Alternatively: **MENU** → CHANNEL Menu → Record Start
2. Press **EXIT** if you wish to display the Recording progress bar during recording. Press again to close.
3. Press **REVEAL** to stop recording.







8. DIGITAL VIDEO RECORDING (DVR)

NOTE:

- Press  to view the currently recording file while recording.
- Press  to play any other recorded files from the Recorded File List.
- It is not possible to view channels on other frequencies while recording is ongoing.
- The recorded file size depends on the broadcasted content. Please make sure your USB storage device has ample space for recording.
- Please do not turn off or unplug the USB storage device during recording. This may damage the USB storage device or cause data corruption.

Recording in Standby Mode



Continue recording after turning off the TV. (Similarly, scheduled recording can be done while the TV is turned off in Standby Mode.)

- Press  while watching TV to start recording. Alternatively:  → CHANNEL Menu → Record Start
- Press  to turn the TV off into Standby Mode.
- A prompt will appear. Choose whether to continue recording after turning the TV off, then press .



Setting a Record Limit





Set a time limit for Instant Recording. When the time limit is up, recording will stop automatically.

- Press  to display the OSD.
- Use  to navigate to CHANNEL Menu → Free Record Limit and adjust the setting between 1 – 6 hours.





8.3 Time Shift (Pause Live TV)

Pause live TV temporarily and avoid missing part of the TV show even if you are interrupted.

- Press  while watching TV to pause live TV and start Time Shift.
 - Press  to resume watching TV from where it was paused. The TV will continue recording live TV.
- When a Time Shifted programme is playing, a  sign is displayed on the screen.
- Press  if you wish to display the Time Shift progress bar during Time Shift recording. Press again to close.
- Press  to stop recording and return to live TV broadcast.

NOTE:

- Fast Forward/Rewind can be done with  , but if you reach the end of the Time Shift recording, the TV will stop recording and return to the live TV broadcast.

8. DIGITAL VIDEO RECORDING (DVR)

- The max recording time for Time Shift depends on the available data storage space and the size of the broadcast DTV content.
- Time shift recordings do not remain saved on the USB storage device.



8.4 Scheduled Recording/Viewing Reminder

Schedule an automatic programme recording or viewing event by directly selecting a programme from the EPG.

- Scheduled recording: Record a programme into a connected USB storage device.
- Viewing reminder: Show a scheduled programme on time.

NOTE: Locked channels and programmes cannot be recorded in scheduled recording.

Schedule a New Recording/Viewing Event

This feature can be used in DTV Mode.

- Press **EPG** and use **◀ ▶ ▲ ▼** to highlight a desired programme in the programme guide.
- Press **DELETEDELETE** **PROG** to schedule a recording, or **REC.LIST** **BookMark** to schedule a viewing reminder.
- A scheduling menu will appear. The desired programme details will already be automatically set. Press **◀ ▶ ▲ ▼** to change any details if desired.
- Press **OK** to save. If the new event clashes with an existing event, you will be asked whether to cancel the scheduling or overwrite the old event. The Schedule List will display and list the new event.
- Press **EXIT** to return to TV viewing. When the time is reached, a countdown will be displayed before recording or showing starts.

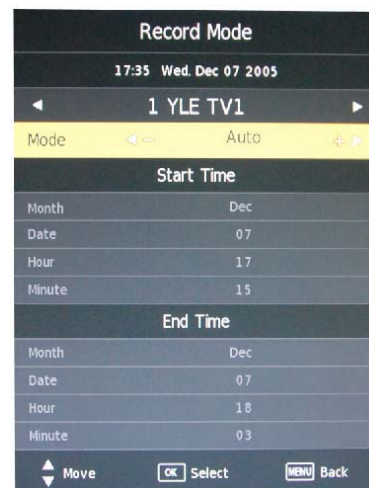

NOTE:

- If the TV is in Standby Mode, Scheduled Recording will proceed without needing to turn on.
- At least 20 events can be scheduled. If the maximum is reached, existing events must be deleted before new ones can be scheduled.
- Locked programmes or channels cannot be recorded unless they are already being accessed using the password. Please keep this in mind when scheduling recordings.

8. DIGITAL VIDEO RECORDING (DVR)

Viewing the Schedule List

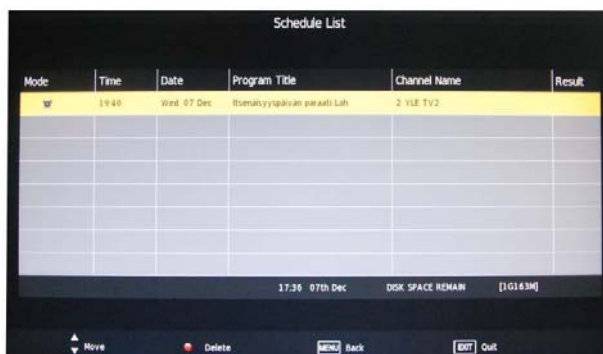

1. Press **SCH.LIST** **DIGEST** to display the Schedule List.
2. Press **▲ ▼** to scroll up and down the list. Scheduled recordings will be marked with a camera icon, and viewing reminders with a clock icon.
3. Press **EXIT** to return to TV viewing.

Deleting a Scheduled Recording/Viewing Event

1. While viewing the Schedule List, use **▲ ▼** to select the event to be deleted.
2. Press **DELETE** **PROG** to delete the highlighted event.
3. Press **◀ ▶** to confirm or **▶** to cancel the deletion.

8.5 Using the Recorded File List

Press **REC.LIST** **BookMark** to access the Recorded File List. Any recorded TV programmes will be listed if a USB storage device is connected and powered on.

Viewing and Playing Recorded Files

1. Press **REC.LIST** **BookMark** to view the Recorded File List. Press repeatedly to sort the files by Programme, Channel and Time.
2. Use **▲ ▼** to browse the list and select a file.
3. Press **DISPLAY** to display detailed information on the highlighted file.
4. Press **EXIT** to show an on-screen control bar.
5. Press **OK** to start playing the selected file.



NOTE:

- If playback is stopped, the track position is remembered and playback will resume from there.
- If the recorded programme is locked because of parental control settings, key in the correct password to view it.

Deleting Recorded Files

1. Press **REC.LIST** **BookMark** to view the Recorded File List, then use **▲ ▼** to select a file.
2. Press **DELETE** **PROG** to delete a file.

9. 3D VIDEO PLAYBACK

You can watch 3D TV when:

- A. The TV receives 3D broadcasting (subject to availability from the broadcaster), or is connected to a compatible 3D video player, and
- B. The 3D format of the video is Side by Side, Top Bottom, Frame Packing or Line by Line.

⚠ CAUTION

- Do not watch 3D TV for too long as it may harm your eyesight or cause you to experience fatigue, headaches and nausea. Take frequent breaks from watching 3D TV.
- If you feel unwell while watching 3D TV, stop and take a rest. If symptoms persist, consult a doctor.
- Stop and consult a doctor immediately if you experience the following symptoms, as you may be at risk of or experiencing seizure or epilepsy: dizziness, altered vision, eye or muscle twitching, involuntary movements, convulsion, loss of consciousness, loss of direction and confusion, cramps and nausea.
- Children and teenagers should be monitored while watching 3D TV in case they show any discomfort. If they feel unwell, have them take a break. If symptoms persist, consult a doctor.
- The following people are not recommended to watch 3D TV:
 - Young children under 5 years of age
 - Pregnant women, seniors, people with heart problems, oversensitivity to light and other medical conditions
 - People who are sick or tired
 - People with a history of epilepsy or seizures

9.1 Watching 3D TV

For optimal 3D video viewing experience, please make sure that your viewing position is within the recommended distance and angle.

● : Recommended angles to view 3D

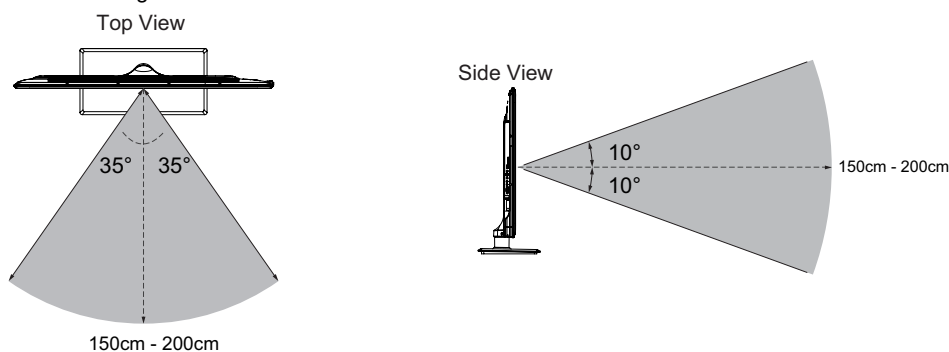

1. Start a 3D video playback from a Blu-ray disc, USB multimedia playback or 3D TV broadcasting, or turn on the 2D→3D function. For USB playback instructions, please see the relevant sections.
2. Put on compatible 3D glasses.
3. Turn on 3D Mode by pressing **3D**. The default 3D Type is Side by Side. Adjust the 3D Type setting if necessary to match the 3D video format. If the 3D picture layers look reversed or otherwise incorrect, adjust the Exchange 3D L/R setting.
4. Press **3D** again to close the 3D Setup Menu.

9. 3D VIDEO PLAYBACK

NOTE:

- If you have eyesight conditions like short-sightedness and astigmatism, please put on your corrective lenses before using the 3D glasses.
- Maintain a distance of at least 2 times the screen width or 3 times the screen height.
- Maintain a position where your eyes are on the same level as the TV screen and looking straight at the screen.

9.2 3D Glasses

Use the provided 3D Glasses when watching 3D TV. Please use your corrective lenses together with the 3D Glasses to watch 3D TV. The 3D Glasses do not have eyesight correcting properties by themselves.

CAUTION

- Please use the 3D Glasses only when watching 3D TV. Do not move around while wearing the 3D Glasses as they may alter your sense of sight, balance and distance, leading to possible physical injury or property damage.
- After watching 3D TV, remove the 3D Glasses and from possible disorientation due to the change balance and distance before moving around
- Handle the 3D Glasses with care while putting them on or taking them off to avoid causing injury with the glasses' frame or hinges.
- Clean the 3D lenses only with a clean, soft cloth to avoid scratching them.
- Avoid touching the delicate 3D lenses to avoid scratching them.
- Avoid dropping or bending the 3D glasses to prevent damage.

9.3 3D Settings

Press **3D** to display the 3D Setup Menu, and use **◀ ▶ ▲ ▼** to adjust the options. Some options may be disabled depending on the input mode.

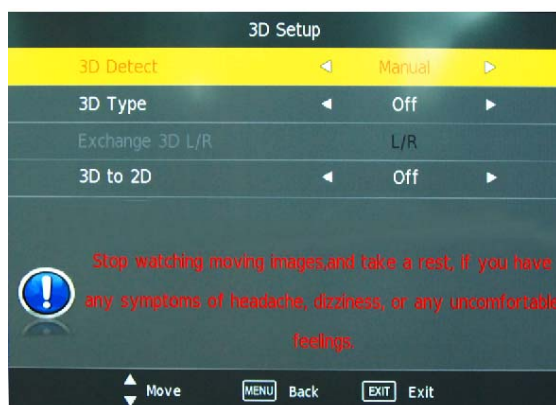

3D Auto Detect

This setting can auto detect 3D video playback from a 3D TV broadcast, or a 3D Blu-ray disc in an integrated Blu-ray player or HDMI Blu-ray video player.

NOTE: 3D Auto Detect may not work with DVD and USB 3D video playback.

9. 3D VIDEO PLAYBACK

3D Type

Choose a suitable 3D playback mode by matching the format of your 3D video to the available choices:

- Off,
- Side by Side
- Top Bottom
- Frame Packing
- Line by Line.

Exchange 3D Left/Right

Adjust this setting for the best 3D picture visibility.

3D→2D Mode

This TV can downscale 3D video or TV into 2D. Turn this option On or Off as desired.

10. USB MULTIMEDIA PLAYBACK

This TV can play movie, audio, image and text files from a connected USB device. For information on supported file formats, see the Reference section.

10.1 Connecting the USB Storage Device

Use a USB storage device such as a hard disk drive or flash drive. USB devices such as mobile phones, MP3 players and cameras are NOT supported.

1. Connect the USB storage device to the USB port on the back panel of the TV.
2. If the USB storage device uses its own power supply, make sure it is turned on.
3. When the device is detected, it will be listed in the Multimedia Menu. The TV may take a while to read the data, depending on the device's storage size and content.

NOTE: For best results, we recommend using a USB storage device with:

- Data storage capacity up to 2TB
- An external power supply
- Maximum USB extension cable length 50cm.

10.2 Playing Multimedia Files

Press **DTV/USB** or **INPUT** and switch to the USB input source. When in USB Input Mode, the USB Menu will be shown. Browse and play files using specific menus for different file types.

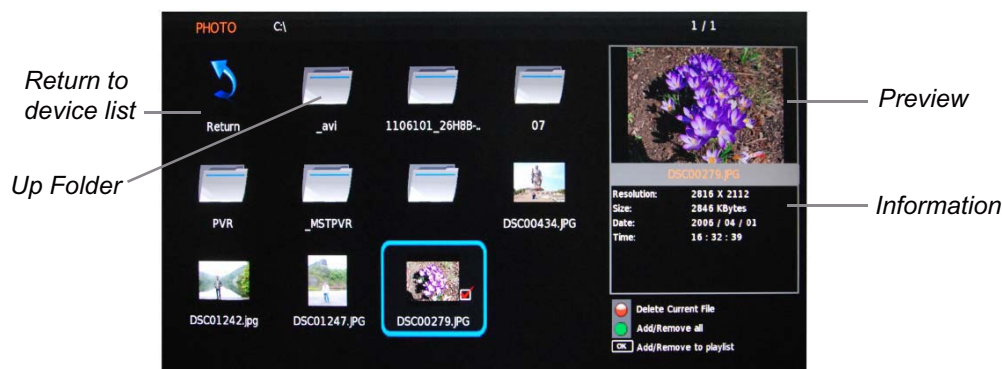

1. In the USB Menu, press **◀ ▶** to choose the desired multimedia type: **Photo** for images, **Music** for audio, **Movie** for videos, and **Text** for text files.
2. Use **▲ ▼** in the list to select the device you wish to play from, and press **OK**. Choose the 'Return' icon to return to the main USB
3. Use **◀ ▶ ▲ ▼** to navigate to desired files and folders. Press **OK** on highlighted folders to view folder contents, and choose the 'Up Folder' icon to return to the previous folder level.
4. Press **▶** to start playing the current highlighted file. Normal playback controls such as Pause, Fast Forward and Fast Rewind are available.
5. Press **○** or **OK** during Photo and Movie file playback to display a control bar for more playback controls.

NOTE: Depending on the file content, some files may not play even if they are in a supported format.

10. USB MULTIMEDIA PLAYBACK

Making a Playlist

1. While browsing files, follow the on-screen hints for button controls. Add a file to a playlist by pressing **OK** on a highlighted file and checking its checkbox. Repeat this action on other files to add them to the playlist.
2. Remove individual files from the playlist by unmarking the checkboxes with **OK**.
3. Alternatively, press **BookMark** to select or unselect all files in the folder.
4. Press **CANCEL** to start playing the highlighted file.

Photo Playback

1. In the USB Menu, choose Photo Playback with **◀ ▶** and press **OK**.
2. Add image files to a playlist by following on-screen hints for button controls.
3. Press **CANCEL** to view in full screen. Press **DISPLAY** to see the Photo Playback control bar.
4. Press **◀ ▶** and **OK** to use the buttons on the bar.



Control	Description
Repeat	Select between Repeat All, Repeat One, Repeat None.
Music	Play/Pause music in the current playlist if any has been selected.
Playlist	Show the current playlist. Use ▲ ▼ and OK to display a specific image. Press SCH.LIST DIGEST to remove a highlighted file from the list, or REC.LIST BookMark to remove all files. Press EXIT to return to the control panel.
Info	Display detailed image information.
Rotate	Rotate current image.
Zoom Out/In	Zoom out/in on current image.
Move View	Move around in a zoomed in image.

10. USB MULTIMEDIA PLAYBACK

Music Playback

1. In the USB Menu, choose Music Playback with ◀ ▶ and press (OK).
2. Add music files to a playlist by following on-screen hints for button controls.
3. Press (▶) to start playback. Press ◀ ▶ and (OK) to use the Music Playback control bar.



Control	Description
Repeat	Select between Repeat All, Repeat One, Repeat None.
Go To	Jump to a specific time in the track by keying in the format HH:MM:SS
Playlist	Press ▲ to navigate into the current playlist. Use ▲ ▼ and (OK) to choose a specific image. Press (SCH.LIST) to remove a highlighted file from the list, or (REC.LIST) to remove all files. Press (EXIT) to return to the control panel.
Screen Mute	Press (SCREEN ZOOM) to turn off the screen while continuing to play music.

Text Display

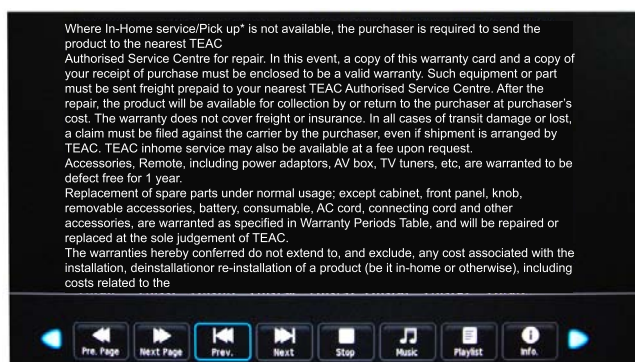

1. In the USB Menu, choose Text Playback with ◀ ▶ and press (OK).
2. Add text files (.txt) to a playlist by following on-screen hints for button controls.
3. Press (▶) to display text files in full screen. Press ◀ ▶ and (OK) to use the Text Playback control bar.



Control	Description
◀ ▶	Previous/next Page.
◀▶▶	Previous/next text document.
■	Stop viewing the text document.

10. USB MULTIMEDIA PLAYBACK







Movie Playback

1. In the USB Menu, choose Movie Playback with ◀ ▶ and press (OK).
2. Add movie files to a playlist by following on-screen hints for button controls.
3. Press  to start playback. Press  to see the Movie Playback control bar.
4. Press ◀ ▶ and (OK) to use the buttons on the bar.





NOTE:

- If playback is stopped, the track position is remembered and playback will resume from there.

Control	Description
Repeat	Select between Repeat All, Repeat One, Repeat None.
A-B	Press once to set Point A, and again to set Point B for looping playback. Press again to resume normal playback.
Playlist	Press ▲ to navigate into the current playlist. Use ▲ ▼ and (OK) to choose a specific image. Press  to remove a highlighted file from the list, or  to remove all files. Press  to return to the control panel.
Info	Display detailed video information.
Slow Fwd	Use the on-screen  button to toggle slow motion playback at different speeds. To resume normal playback, press  .
Step Fwd	Use the on-screen  button to step forward within the track in small time increments.
GOTO	Key in a specific point to jump to using the HH:MM:SS format.

Musical Photo/Text Slideshow

Play music while viewing images or text.

1. In the USB Menu, choose Music Playback with ◀ ▶ and press (OK).
2. Add music files to a playlist by pressing (OK) on a highlighted file. For details on adding files to playlists, please see the Making a Playlist section.
3. After the music playlist is done, press  to return to the USB Menu.
4. Choose Photo or Text Playback with ◀ ▶ and press (OK).
5. Add the desired image/text files to a playlist.
6. Press  to start displaying the images/text.
7. Press  to display the on-screen control bar.
8. Start simultaneous music playback by choosing the Music button in the control bar.

11. REFERENCE

11.1 Troubleshooting

Please do not use functions not mentioned in this user manual. If a problem occurs with your TV, please refer to the table below. If the problem persists, please turn the TV off and consult the TEAC Customer Service Hotline.

Problem	Action
No picture	Is the power plugged in? Insert the power plug.
The picture appears too slowly after the power is turned on	Like your computer, the TV runs diagnostic and software checks before it can display broadcast channels. The picture should appear in approximately 15 seconds.
Picture is too bright or too dark.	Adjust picture brightness or contrast settings.
Picture is too large or too small.	Adjust the aspect settings.
Picture shakes and stripes appear	Keep appliances that emit magnetic radiation away from the TV.
Picture does not move	Press the PAUSE button. Check if playback is on Pause through any other equipment.
Has picture but no sound	<ol style="list-style-type: none">1. Check if the MUTE function is on.2. Adjust the volume level.3. Check the connection of the audio input cables.4. Check all other input connections.
Remote control does not work	<ol style="list-style-type: none">1. Check if the AC power connection is switched on.2. Check that the battery installation is correct.3. Remove any obstacles between the TV and the remote control.4. If the batteries are flat, replace them with new ones.
Distorted picture	Video compression may cause distortion especially in scenes with fast action. Weak reception may cause distortion and is not a TV issue – please have the antenna assessed.
USB device not detected	Check the connection to the USB device. Please ensure that the device is compatible and the multimedia data formats are supported (for details, see the Specifications section).
TV turns off by itself	Check the Timer Sleep and Auto Sleep settings in the TIME Menu.
TV turns on by itself at night	The TV may have been set to scan for new firmware at night. Please check the Auto Software Update setting in the OPTION Menu.

11. REFERENCE

11.2 Specifications

LCD Panel	Panel Size	42"
Max. Resolution		1920x1080
Input Connector	VIDEO	1
	YPbPr	1
	AUDIO (L/R)	1
	VGA	1
	PC/AUDIO	1
	HDMI	3 (The HDMI support 1.3, the HDCP support 1.1)
	RF	1
Output Connector	HEADPHONE	1
	COAX	1
Power Source		100-240V ~ 50/60Hz
Power Consumption		100W
Standby Power Consumption		<1W
Contrast Ratio		800:1
Brightness		350cd/m ²
TV receive system		PAL BG/DK/I SECAM BG/DK L/L'
Frequency range		48.25 - 863.25 MHz
Speaker output power		2×8W
Antenna impedance		75 ohm
Supported file system		DVR Recording: FAT32 USB Multimedia Playback: FAT32 and NTFS Maximum hard disk partition size: 400GB
Recommended USB standard		USB2.0
Supported Multimedia Player formats		See the table on next page
PC Input supported resolution		WUXGA (Maximum supported resolution: 1360X768 @ 60Hz)
Dimensions	(With stand)	1019x260x689 mm
	(Without stand)	1019x49x635 mm
Weight		15.5kg
Wall mounting dimensions		200x200mm
Wall mounting screw size		M4X10
Operating temperature range		0~40°C

- Specifications are subject to change without notice.
Weight and dimensions are approximate.

11. REFERENCE

Supported File Formats

MOVIE (AVI)	Max bitrate: 6Mbps Max resolution: 720 x 576 pixels
PICTURE	Mono colour, 16-colour, 256-colour, 16-bit, 24-bit, 32-bit. Max resolution: 3000 x 3000 pixels; Min resolution: 100 x 100 pixels
MUSIC	Sample rate: 8K – 48K Bitrate: 32K – 320K
Special Notes: <ul style="list-style-type: none">▪ The Media Unit can only support USB memory devices such as hard disk drives and flash drives, and will not support multimedia devices such as mobile phones and cameras for recording purposes.▪ The unit will only support hard disk drives with additional power supply, a maximum disk partition size of 400GB and a maximum capacity of 1.5TB. For best performance, we highly recommend that a hard disk drive with an external power supply be used for larger capacities.▪ The maximum number of files that each folder can use is 5000 files.▪ When using external USB, it is suggested that high quality of USB extension cables (supported 480mHz) be used to ensure smooth video file playback.▪ The TV unit can only support audio formats of single and binary channels.	

<CT1011>

TEAC[®]

TEAC CUSTOMER SUPPORT HOTLINE (TCS)

1300 553 315

Between Monday to Friday – AEST 8.30AM to 6PM