

<http://www.datatime.co.uk>

TP 20 USER MANUAL

# USER'S MANUAL

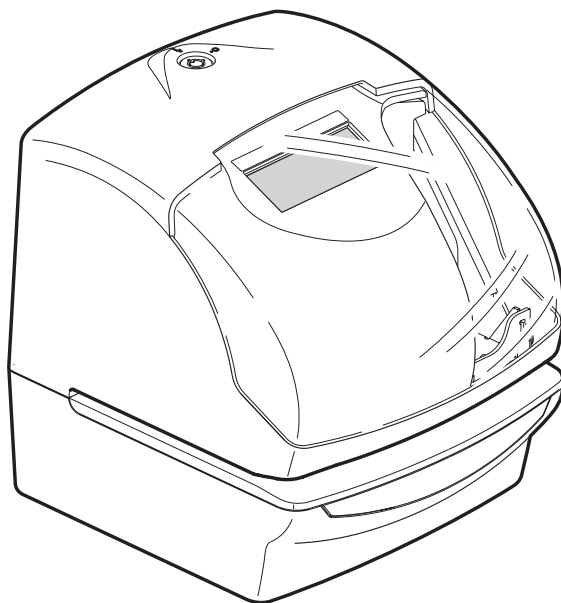

Supplier:

**DATA TIME SYSTEMS LTD**  
UNIT G. 5 LOWLANDS DR.  
KEYWORTH.  
NOTTINGHAM.  
NG12 5HG

Phone 0115 937 3368 | Fax 0115 937 6611

[info@datatime.co.uk](mailto:info@datatime.co.uk) | <http://www.datatime.co.uk>

This unit complies with the Low Voltage Directive 73/23/EEC and the EMC Directive 89/336/EEC.

This device complies with Part 15 of the FCC Rules. Operation is subject to the following two conditions: (1) this device may not cause harmful interference, and (2) this device must accept any interference received, including interference that may cause undesired operation.

1. The details of this User's Manual are subject to change without previous notification.
2. This User's Manual has been prepared with the utmost care to cover all aspects of the time recorder's use.  
If you feel, however, that some explanations are inadequate, unclear, or difficult to understand, please do not hesitate to contact Acroprint.
3. No part of this publication may be reproduced, stored in a retrieval system, or transmitted, in any form or by any means, mechanical, photocopying, recording or otherwise without the written consent of Acroprint Time Recorder.

# TABLE OF CONTENTS

<b>1. INTRODUCTION &amp; FEATURES</b>	<b>2</b>
<b>2. BEFORE USING YOUR TIME RECORDER</b>	<b>3</b>
Attached Accessories	3
Location of Name	3
Print Position on Time Card	3
<b>3. QUICK EASY SETUP</b>	<b>4</b>
<b>4. OPTIONAL FUNCTIONS</b>	<b>5</b>
<b>5. HOW TO PROGRAM THE TIME RECORDER</b>	<b>6</b>
<b>6. SETTING THE TIME</b>	<b>7</b>
<b>7. SETTING THE DATE</b>	<b>8</b>
<b>8. SETTING THE 12/24 HOUR FORMAT</b>	<b>9</b>
<b>9. SETTING THE PRINT ORDER</b>	<b>10</b>
<b>10. SETTING YEAR AND MINUTE FORMAT</b>	<b>11</b>
<b>11. SETTING THE PRE-PROGRAMED COMMENTS</b>	<b>13</b>
<b>12. SETTING THE CUSTOMIZED COMMENTS</b>	<b>14</b>
<b>13. SETTING THE LANGUAGE</b>	<b>22</b>
<b>14. SETTING THE PRINT METHOD</b>	<b>23</b>
<b>15. SETTING THE DAYLIGHT SAVING TIME</b>	<b>25</b>
Deleting the Daylight Saving Time settings	28
<b>16. SETTING THE NUMBER</b>	<b>29</b>
<b>17. SETTING THE INITIAL NUMBER</b>	<b>31</b>
<b>18. SETTING THE TIME TABLE PROGRAM</b>	<b>32</b>
<b>19. SETTING THE EXTERNAL TIME SIGNAL / BUILT-IN BUZZER</b>	<b>39</b>
<b>20. SETTING THE SLAVE CLOCK</b>	<b>40</b>
<b>21. SETTING THE PASSWORD</b>	<b>41</b>
How to change settings when the Password is set	42
Canceling the Password	43
<b>22. RE-SETTING</b>	<b>44</b>
<b>23. WALL MOUNTING</b>	<b>45</b>
<b>24. REPLACING THE RIBBON CASSETTE</b>	<b>46</b>
<b>25. CHARACTER CODE FOR ALPHANUMERIC</b>	<b>48</b>
<b>26. INSTALLING THE Ni-Cd BATTERY (OPTIONAL)</b>	<b>52</b>
<b>27. CONNECTING THE OPTIONAL FUNCTIONS</b>	<b>53</b>
Connecting the Master Clock	53
Connecting the External Time Signal	54
Attaching the Wire Clamp	55
<b>28. TROUBLE-SHOOTING</b>	<b>56</b>
<b>29. SPECIFICATIONS</b>	<b>57</b>

# 1. INTRODUCTION & FEATURES

## INTRODUCTION:

Thank you for purchasing an Acroprint Model ES900 Time Recorder. We are confident this time recorder will give you full satisfaction. Items such as the time and date are preset at the factory. After plugging in the AC power, the recorder can be used immediately. However, we recommend reading this manual before you start using your time recorder.

## FEATURES:

Main applications : Payroll/job cost recorder, time recorder or numbering machine.

- The Quartz Time Recorder
- Dot-matrix printer
- Perpetual calendar
- Automatic daylight saving time
- 4-way print activation
  - Automatic
  - Manual
  - Semi-automatic
  - Combination
- Adjustable print position
- Prints in 7 languages
- Prints numbers/date
- Time table program
- I Mark© printing (Irregular registration Mark)
- 13 pre-programmed comments
- Alphanumeric printing
- Selectable 4-digit year imprint
- 12 or 24-hour format
- Regular minute, tenths, twentieths, or hundredths of an hour
- Password for program protection
- Digital LCD (Date, Hour, Minute, Day of the week indication)
- Wall or desktop mount
- Full power reserve (optional)
- Built-in buzzer (optional)
- External time signal (optional)

## Caution:

### ***Do not use in places:***

- Subject to high humidity and dust.
- Exposed to strong or continuous vibrations.
- Exposed to direct sunlight.
- The temperature range in which all functions of the ES900 will operate correctly is from 23°F to 113°F (-5°C to 45°C). Be sure to place and use your time recorder only in locations in which this temperature range is not exceeded and there are no sharp temperature variations.

### **Daily Care**

For cleaning, turn the power off and wipe the case clean of dust and dirt with a dry cloth.

## 2. BEFORE USING YOUR RECORDER

### Package Contents

Unpack the time recorder and check its contents to ensure that the time recorder unit and all accessories shown below are included.

### Attached Accessories

- User's Manual
- Keys .....2 pcs.
- Ribbon Cassette .....1 pc.
- Wall-Mount Fittings  
Screw .....4 pcs.  
Template ....1 sheet.

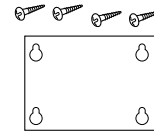
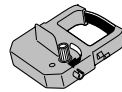
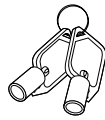
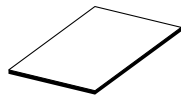

•The ribbon cassette is installed at the factory.

### Location of Name

<Front view>

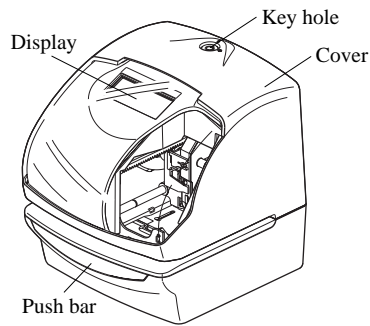

<Back view>

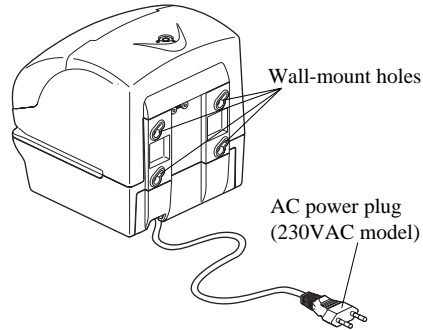

<Cover off>

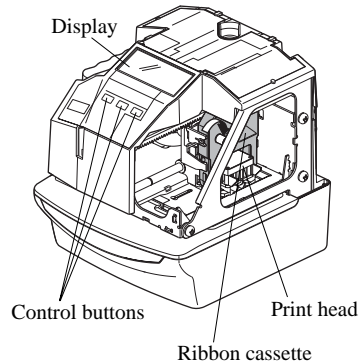

### Print Position on Time Card

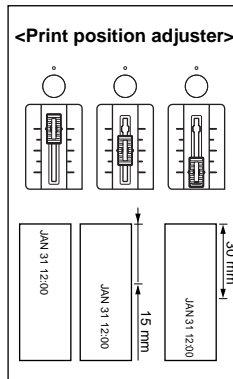

Print position from the card edge is adjustable by pressing and sliding the print position button located on the right outside bottom of the recorder. Maximum distance from edge of form to print is approximately 1 3/16" (30 mm).

### 3. QUICK EASY SETUP

**1** Unlock the key and remove the top case.

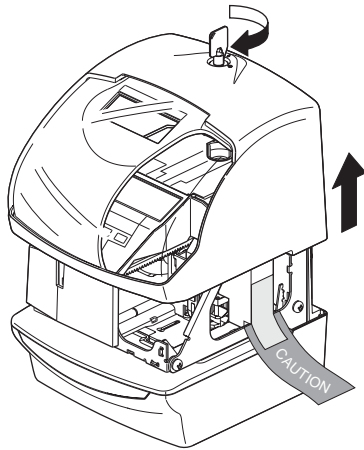

**3** Replace the cover and lock.

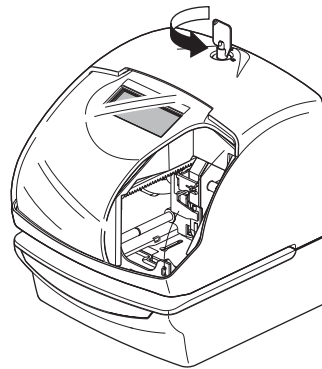

**2** Remove the **PROTECTION PAD**.

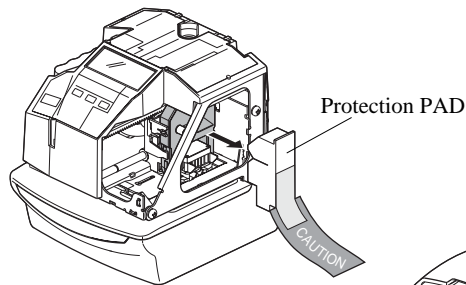

**4** Plug the AC cord into the AC outlet and insert a card.

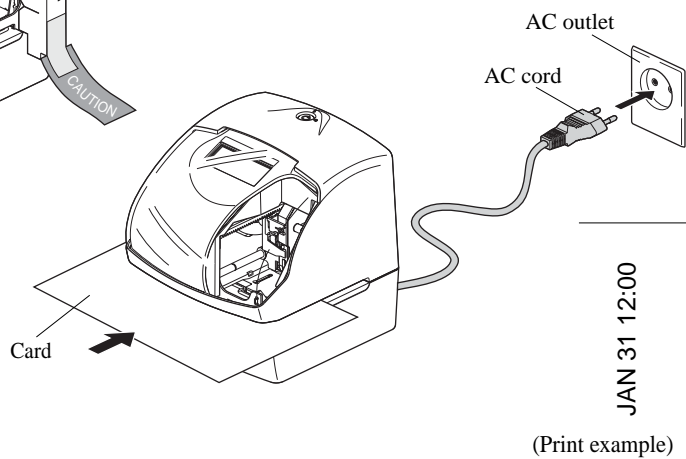

## 4. OPTIONAL FUNCTIONS

The following optional functions are available by adding an optional board:

External Time Signal for Bell, Built-in Buzzer, and the Slave Clock.

### External Time Signal and Built-in Buzzer

External time signal and Built-in buzzer shall be controlled by time table program and their duration settings.

Refer to the "18. SETTING THE TIME TABLE PROGRAM," and the "19. SETTING THE EXTERNAL TIME SIGNAL / BUILT-IN BUZZER."

#### Connection Specifications for External time signal contact

- Contact output: dry contact
- Contact capacity: 5A, 30VDC (Resistive)

### The Slave Clock

The Slave Clock is a function to synchronize the time of the time recorder and the master clock. This function operates by choosing Slave Clock by Slave Clock setup. Refer to the "20. SETTING THE SLAVE CLOCK."

#### Input signal Specifications.

- 30-second reversal.  
Since the 30-second signal (-V side) is not received, the difference from the master clock is 30 seconds or more, and the time is not modified correctly.
- 60-second reversal.  
Since the odd-numbered signal (-V side) is not received, the difference from the master clock is one minute or more, and the time is not modified correctly.
- 59-minute impulse ( 2-wire )  
From the 59th minute through the 49th minute the pulse is transmitted with line AB positive with respect to PC.  
From the 50th minute to the 59th minute the pulse is transmitted with line AB negative with respect to PC.  
During the 59th minute, the continuous pulse of 20 times is transmitted with line AB negative with respect to PC.  
As this method monitors from 5 minutes before several preset hours to input 0-minute signal, more than 5 minutes of tolerance for a master clock can not compensate time correctly.

Pulse Specification	Input sensitivity
Pulse width	0.1 second or more
Voltage	6 - 32V

## 5. HOW TO PROGRAM THE TIME RECORDER

To enter the program setting mode, you must plug the AC cord into the AC outlet and remove the cover. Next press the [SELECT] button once. Then the recorder changes into the program mode showing the "▲" on the display positioned under the "TIME" mark.

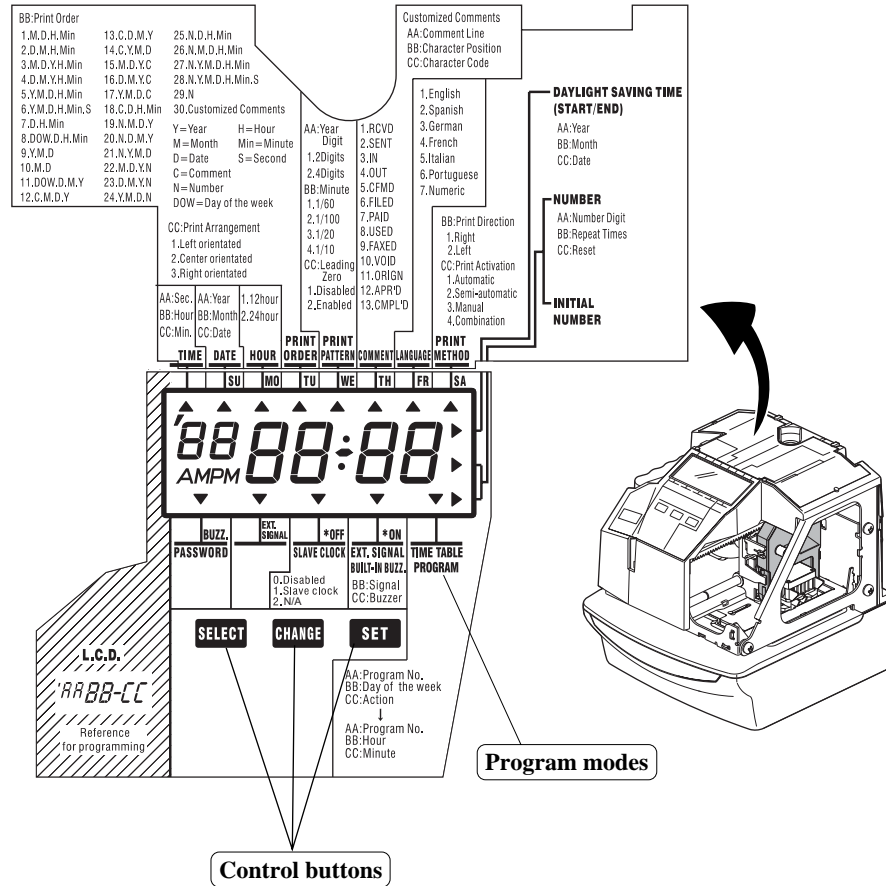

### Function of 3 control buttons

- [SELECT]:** You can select the desired program setting mode by pressing this [SELECT] button. Selected program setting mode is indicated by the "▲" on the display.
- [CHANGE]:** When you press the [CHANGE] button, you can increment the set value.
- [SET]:** You can set the value selected on the display by pressing the [SET] button. Thereafter you press this [SET] button again, you can return the Time recorder to the normal operation mode.



## 6. SETTING THE TIME

Example: Change the time from 10:08 to 10:09.

- 1 Press the [SELECT] button and position the "▲" under the "TIME" mark. At that moment, the "Hour" flashes. (The flashing means it can be changed.)

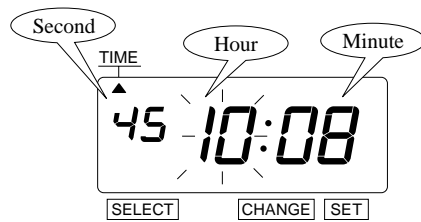

### Change the "Hour".

In case of the example, press the [SET] button because the hour is not being changed.

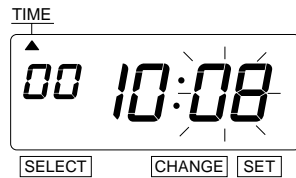

At that moment, the flashing changes from "Hour" to "Minute".

- 2 Change the "Minute".

Press the [CHANGE] button to set at "09". And then press the [SET] button.

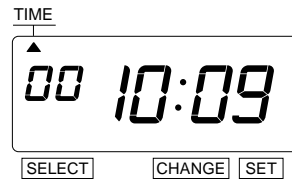

At that moment, the "Second" starts to run from "00".

- 3 After you finish setting the time, press the [SET] button once again.



Now the time setting has been completed. Replace the cover and lock.

Important: Printing will not occur unless Step 3 is completed.

## 7. SETTING THE DATE

Example: Change the date from October 20, 2003 to October 21, 2003.

- 1 Press the [SELECT] button and position the "▲" under the "DATE" mark.  
At that moment, the "Year" flashes. (The flashing means it can be changed.)

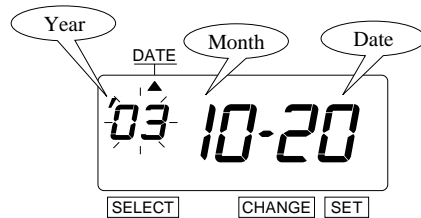

- 3 **Change the "Date".**  
Press the [CHANGE] button to set at "21". And then press the [SET] button.

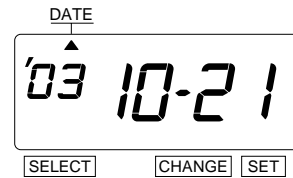

### Change the "Year".

In case of the example, press the [SET] button because the year 2003 does not need to be changed.

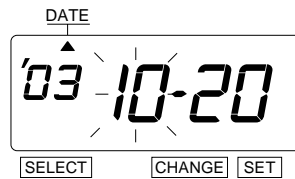

At that moment, the flashing changes from "Year" to "Month".

- 2 **Change the "Month".**  
In case of the example, press the [SET] button because the month is not being changed.

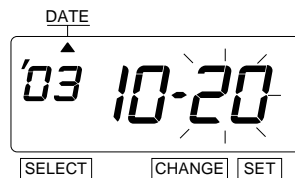

At that moment, the flashing changes from "Month" to "Date".

- 4 After you finish setting the date, press the [SET] button once again.



Now the date setting has been completed. Replace the cover and lock.

Important: Printing will not occur unless Step 4 is completed.

## 8. SETTING THE 12/24 HOUR FORMAT

Example: Change the hour format to 24 hour.

- 1 Press the [SELECT] button and position the "▲" under the "HOUR" mark.

At that moment, the flashing digit indicates "Hour Display Format Options". (The flashing means it can be changed.)

### Change the "Hour".

In case of the example, press the [CHANGE] button to set at "2". Then press the [SET] button.

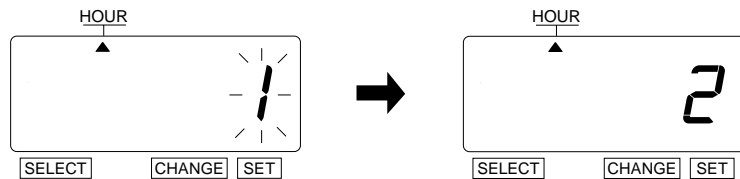

	Hour Display Format Options	Display
1.	12 hour	PM 3:00
2.	24 hour	15:00

- 2 After you finish setting the 12/24 hour format, press the [SET] button once again.



Now the 12/24 hour setting has been completed. Replace the cover and lock.

Important: Printing will not occur unless Step 2 is completed.

## 9. SETTING THE PRINT ORDER

Example: Set the print order to "Month, Date, Year, Hour, Minute."

- 1 Press the [SELECT] button and position the "▲" under the "PRINT ORDER" mark. At that moment, the flashing digit indicates "Print Order Options."  
(The flashing means it can be changed.)

**Change the "Print Order Options".**  
In case of the example, press the [CHANGE] button to set at "3". Then press the [SET] button.

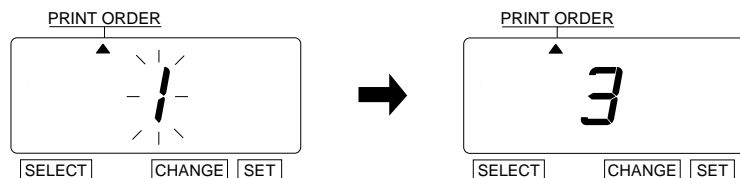

Y=Year, M=Month, D=Date, DOW=Day of the week, H=Hour, Min=Minute, S=Second  
C=Comment, N=Number

	Print Order Options	Print Example		Print Order Options	Print Example
1.	M.D.H.Min	JAN 31 10:00	16.	D.M.Y.C	31 JAN '03 SENT
2.	D.M.H.Min	31 JAN 10:00	17.	Y.M.D.C	'03 JAN 31 SENT
3.	M.D.Y.H.Min	JAN 31 '03 10:00	18.	C.D.H.Min	SENT 31 10:00
4.	D.M.Y.H.Min	31 JAN '03 10:00	19.	N.M.D.Y	000123 JAN 31 '03
5.	Y.M.D.H.Min	'03 JAN 31 10:00	20.	N.D.M.Y	000123 31 JAN '03
6.	Y.M.D.H.Min.S	'03 JAN 31 10:00:00	21.	N.Y.M.D	000123 '03 JAN 31
7.	D.H.Min	31 10:00	22.	M.D.Y.N	JAN 31 '03 000123
8.	DOW.D.H.Min	FR, 31 10:00	23.	D.M.Y.N	31 JAN '03 000123
9.	Y.M.D	'03 JAN 31	24.	Y.M.D.N	'03 JAN 31 000123
10.	M.D	JAN 31	25.	N.D.H.Min	000123 31 10:00
11.	DOW.D.M.Y	FR, 31 JAN '03	26.	N.M.D.H.Min	123 JAN 31 10:00
12.	C.M.D.Y	SENT JAN 31 '03	27.	N.Y.M.D.H.Min	123 '03 JAN 31 10:00
13.	C.D.M.Y	SENT 31 JAN '03	28.	N.Y.M.D.H.Min.S	123 '03 JAN 31 10:00:00
14.	C.Y.M.D	SENT '03 JAN 31	29.	N	000123
15.	M.D.Y.C	JAN 31 '03 SENT	30.	Customaized Comments	

- 2 After you finish setting the print order, press the [SET] button once again.

Now the print order setting has been completed. Replace the cover and lock.



Important: Printing will not occur unless Step 2 is completed.

# 10. SETTING YEAR & MINUTE FORMAT

If you have selected the recorder to print the year, this allows you to choose the number of digits in the year (two or four). You may also select the minute format: standard minutes, hundredths, twentieths or tenths of an hour. You may also choose whether to print leading zeros.

Example: Change the Year imprint to 4 digits and the Minutes to 1/100 min. and the Leading Zero to enabled.

- Press the [SELECT] button and position the "▲" under the "PRINT PATTERN" mark.  
At that moment, the flashing digit indicates "Year Digit Options".  
(The flashing means it can be changed.)

### Change the "Year Digit".

In case of the example, press the [CHANGE] button to set at "2". And then press the [SET] button.

At that moment, the flashing changes from the "Year Digit Options" to "Type of Minute".

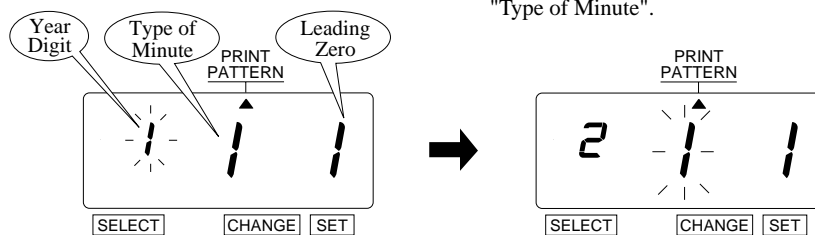

	Year Digit Options	Print Example
1.	2 Digits	JAN 31 '03 10:00
2.	4 Digits	JAN 31 2003 10:00

- Change the "Type of Minute".

In case of the example, press the [CHANGE] button to set at "2". And then press the [SET] button.

At that moment, the flashing changes from "Type of Minute" to "Leading Zero".

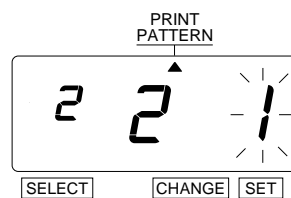

	Type of Minute	Print Example
1.	1/60 Min.	JAN 31 2003 10:10
2.	1/100 Min.	JAN 31 2003 10.17
3.	1/20 Min. (= 5/100 Min.)	JAN 31 2003 10.15
4.	1/10 Min.	JAN 31 2003 10.1

**3 Change the "Leading Zero".**

In case of the example, press the [CHANGE] button to set at "2". And then press the [SET] button.

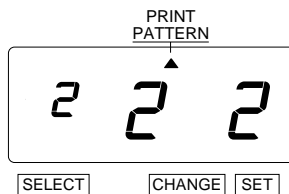

	Leading Zero	Print Example
1.	ZERO Disabled	JAN 1 3:00
2.	ZERO Enabled	JAN 01 03:00

**4** After you finish setting the print pattern, press the [SET] button once again.

Now the print pattern setting has been completed. Replace the cover and lock.

Important: Printing will not occur unless Step 4 is completed.



# 11. SETTING PRE-PROGRAMMED COMMENTS

Example: Change the comment to "SENT".

- 1 Press the [SELECT] button and position the "▲" under the "COMMENT" mark. At that moment, the flashing digit indicates "Comment Options". (The flashing means it can be changed.)

### Change the "Comment Options".

In case of the example, press the [CHANGE] button to set at "2". And then press the [SET] button.

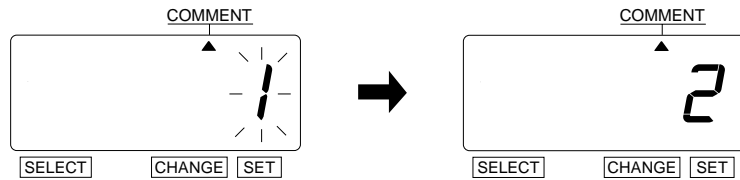

	Comment Options	Print Example
1.	RCVD (Received)	JAN 31 '03 RCVD
2.	SENT	JAN 31 '03 SENT
3.	IN	JAN 31 '03 IN
4.	OUT	JAN 31 '03 OUT
5.	CFMD (Confirmed)	JAN 31 '03 CFMD
6.	FILED	JAN 31 '03 FILED
7.	PAID	JAN 31 '03 PAID
8.	USED	JAN 31 '03 USED
9.	FAXED	JAN 31 '03 FAXED
10.	VOID	JAN 31 '03 VOID
11.	ORIGN (Original)	JAN 31 '03 ORIGN
12.	APR'D (Approved)	JAN 31 '03 APR'D
13.	CMPL'D (Completed)	JAN 31 '03 CMPL'D

- 2 After you finish setting the comment, press the [SET] button once again.

Now the pre-programmed comments setting has been completed. Replace the cover and lock.



Important: Printing will not occur unless Step 2 is completed.

## 12. SETTING THE CUSTOMIZED COMMENTS

- Maximum 3 lines comment can be set to print.
- Note: This time recorder can print a maximum of 31 characters. However, number of characters depends on font size. Refer to the "25. CHARACTER CODE FOR ALPHANUMERIC".

Example:

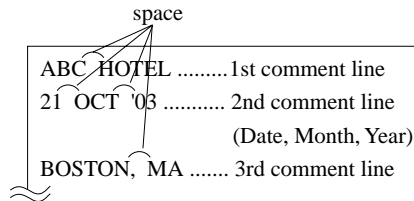

- 1 Press the [SELECT] button and position the "▲" under the "PRINT ORDER" mark.

At that moment, the flashing digit indicates "Print Order Options".  
(The flashing means it can be changed.)

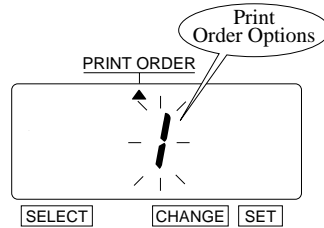

Press the [CHANGE] button to set at the "30" (Customized Comments). At that moment, a digit for "Print Position" appears next to "Print Order Options".

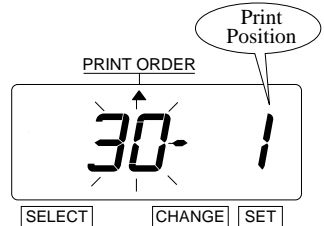

- 2 And then press the [SET] button. At that moment, the flashing digit changes from "Print Order Options" to "Print Position".

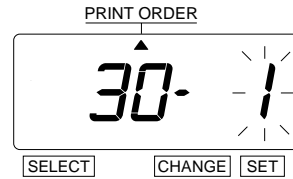

In case of example, press the [SET] button because the print position is not being changed.

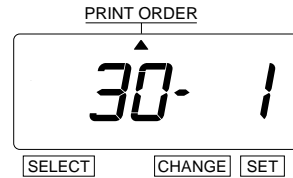

	Print Position
1.	Align Left
2.	Center
3.	Align Right



- 3** Press the [SELECT] button and position the "▲" under the "COMMENT" mark.  
**Setting the 1st comment line.**  
 At the moment, the flashing digit indicates "Character Position". And then press the [SET] button.

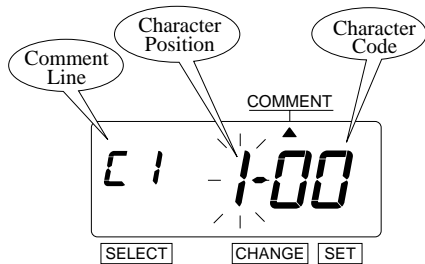

At the moment, the flashing changes from "Character Position" to "Character Code".

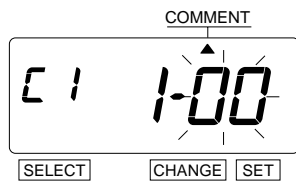

- 4 Set the "Character Code"**  
 In case of example, the 1st character is "A", then enter the character code "02".

Refer to the "25. CHARACTER CODE FOR ALPHANUMERIC"

Press the [CHANGE] button until the correct character code appears. And then press the [SET] button.

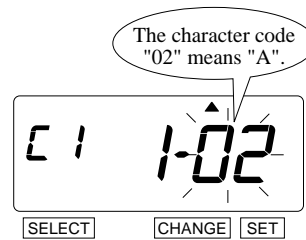

At that moment, the "Character Position" changes from the 1st character to the 2nd character.

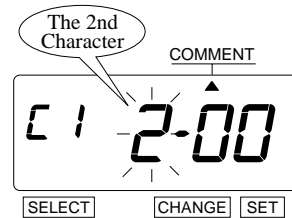

- 5** The 2nd character is "B", then enter the character code "03".



Press the [CHANGE] button until the correct character code appears. And then press the [SET] button.

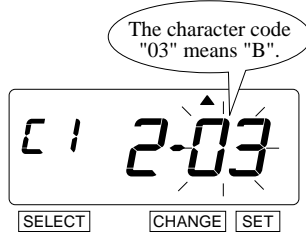

- 6** The 3rd character is "C", then enter the character code "04".

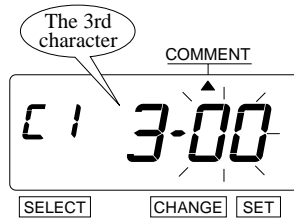

Press the [CHANGE] button until the correct character code appears. And then press the [SET] button.

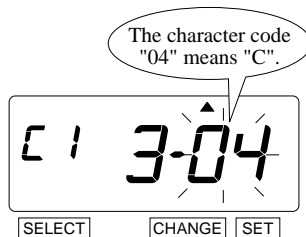

- 7** Follow the same procedure for further characters settings.

- 8** **Setting the 2nd comment line**

Press the [SET] button to change the comment line number to "C2".

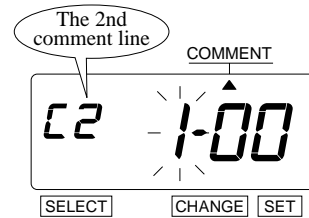

In case of example, the 1st character is "DATE", then enter the character code "28".

Press the [CHANGE] button until the correct character code appears. And then press the [SET] button.

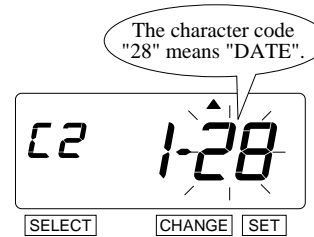

- 9 The 2nd character is "SPACE", then enter the character code "01".

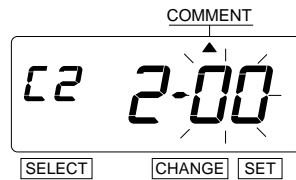

Press the [CHANGE] button until the correct character code appears. And then press the [SET] button.

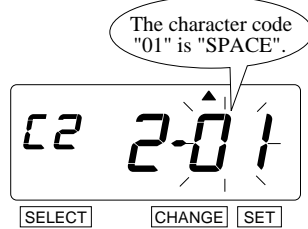

- 10 The 3rd character is "MONTH", then enter the character code "27".

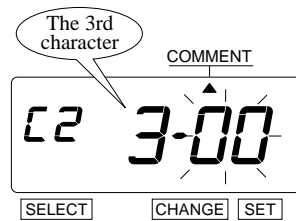

Press the [CHANGE] button until the correct character code appears. And then press the [SET] button.

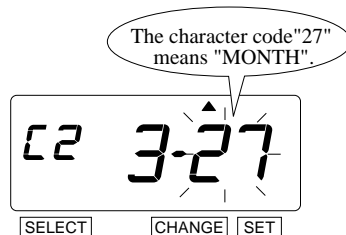

- 11 Follow the same procedure for further characters settings.

- 12 **Setting the 3rd comment line.**

Press the [SET] button to change the comment line number to "C3".

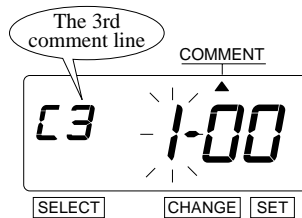

In case of example, the 1st character is "B", then enter the character code "03".

Press the [CHANGE] button until the correct character code appears. And then press the [SET] button.

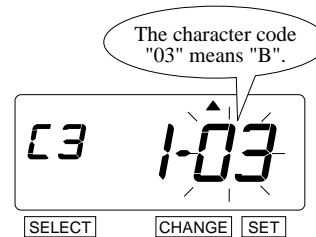

- 13** The 2nd character is "O", then enter the character code "10".

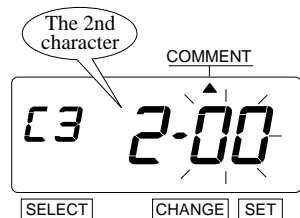

Press the [CHANGE] button until the correct character code appears. And then press the [SET] button.

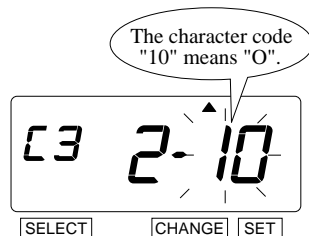

- 14** Set the last character "A" in the same manner as above.

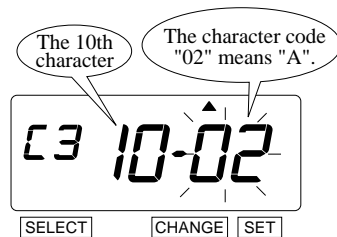

- 15** After you finish setting the customized comments, press the [SET] button three times.

Now the customized comments setting has been completed. Replace the cover and lock.

Important: Printing will not occur unless Step 15 is completed.



## HOW TO CORRECT CUSTOMIZED COMMENTS

Use below code number correction.

Code	Meaning
F8	Insert Character
F9	Delete Character
FA	Insert Line
Fb	Delete Line
FC	Exchange Line 1 to 2
Fd	Exchange Line 2 to 3
FE	Exchange Line 1 to 3
FF	Delete All

## Setting the Print Position of Customized Comments

Align Left

```

| ABC HOTEL
| 21 OCT '03
| BOSTON, MA
  
```

Center

```

| ABC HOTEL
| 21 OCT '03
| BOSTON, MA
  
```

Align Right

```

| ABC HOTEL
| 21 OCT '03
| BOSTON, MA
  
```

Example: Change the print position to "Center".

- 1 Press the [SELECT] button and position the "▲" under the "PRINT ORDER" mark.  
At that moment, the flashing digit indicates "Print Order Options".  
(The flashing means it can be changed.)

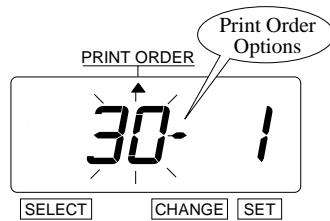

In case of the example, press the [SET] button because the "Print Order Options" are not to be changed. At that moment, the flashing digit indicates "Print position".

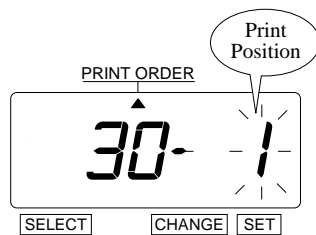

	Print Position
1.	Align Left
2.	Center
3.	Align Right

- 2 Change the "Print Position"

In case of example, press the [CHANGE] button to set at "2". And then press the [SET] button.

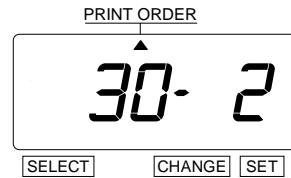

- 3 After you finish setting the print order and the print position, press the [SET] button once again.



Now the print order and the print position settings have been completed. Replace the cover and lock.

Important: Printing will not occur unless Step 3 is completed.

## Confirming and Changing the Customized Comments

Example: 1st comment line: No change.

2nd comment line: Change from "Year" to time "HH:MM".

3rd comment line: No change.

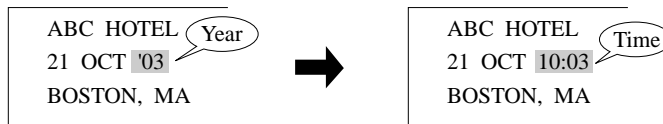

### 1 Confirming the 1st comment line

To confirm the customized comments that have been set, press the [SELECT] button and position the "▲" under the "PRINT ORDER" mark. At that moment, the "Character Position" flashes, and press the [CHANGE] button.

While the "Character Position" changes, the "Character Code" that has been set appears.

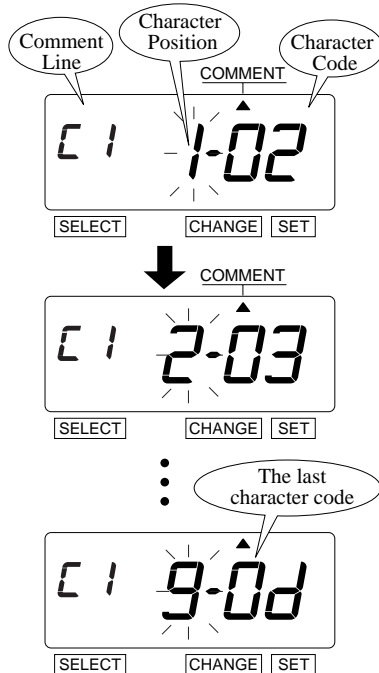

After confirming the last character code of the 1st comment line, press the [CHANGE] button once again.

At that moment, the display changes to the following figure.

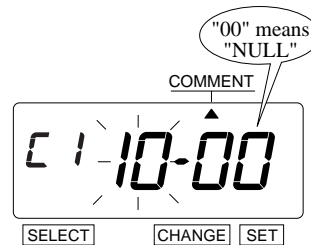

At this time, press the [SET] button twice, and the 2nd comment line is displayed.

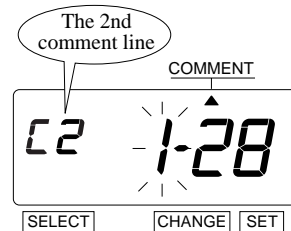

## 2 Changing the Customized Comments

In case of example, press the [CHANGE] button to set at "5". And then press the [SET] button. At that moment, flashing changes from the "Character Position" to the "Character Code".

The character code "26" means "Year".

Character Position	1	2	3	4	5
Code	28	01	27	01	26
Meaning	Date	SPACE	Month	SPACE	Year

Press the [CHANGE] button to set at "2A".

The character code "2A" means HH:MM"

Character Position	1	2	3	4	5
Code	28	01	27	01	2A
Meaning	Date	SPACE	Month	SPACE	HH:MM

Then press the [SET] button once.

Now changing the character code has been completed.

## 3 Confirming the 3rd comment line

Confirm the 3rd comment line in the same manner as Step 1.

4 After you finish confirming and changing the customized comments, press the [SET] button once again.



Now confirming and changing the customized comments have been completed. Replace the cover and lock.

Important: Printing will not occur unless Step 4 is completed.

# 13. SETTING THE LANGUAGE

This setting is available if you select "Month", "Day of the week" or "Comment" in previous "PRINT ORDER".

Example: Change the print language into Spanish.

- 1 Press the [SELECT] button and position the "▲" under the "LANGUAGE" mark. At that moment, the flashing digit indicates "Print Language Options". (The flashing means it can be changed.)

**Change the "Language".**  
 In case of the example, press the [CHANGE] button to set at "2". And then press the [SET] button.

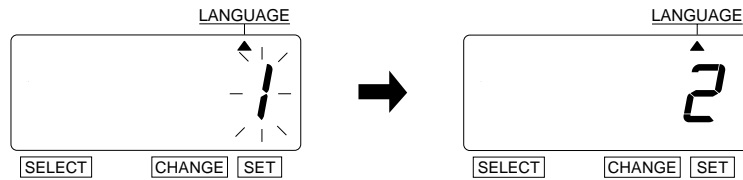

	Print Language Options	Print Example
1.	ENGLISH	TH, 25 DEC '03 OUT 31 10:00
2.	SPANISH	JU, 25 DIC '03 SAL 31 10:00
3.	GERMAN	DO, 25 DEZ '03 AUSG 31 10:00
4.	FRENCH	JE, 25 DEC '03 SORT 31 10:00
5.	ITALIAN	GI, 25 DIC '03 USC 31 10:00
6.	PORTUGUESE	QI, 25 DEZ '03 SAIDA 31 10:00
7.	NUMERIC	4, 25-12 '03 OUT 31 10:00

- 2 After you finish setting the language, press the [SET] button once again. Now the language setting has been completed. Replace the cover and lock.



Important: Printing will not occur unless Step 2 is completed.



# 14. SETTING THE PRINT METHOD

Example: Change the print direction to "Left" and the print activation to "Manual".

- 1 Press the [SELECT] button and position the "▲" under the "PRINT METHOD" mark.  
At that moment, the flashing digit indicates "Print Direction Options".  
(The flashing means it can be changed.)

### Change the "Print Direction".

In case of the example, press the [CHANGE] button to set at "2".  
And then press the [SET] button.  
At that moment, the flashing changes from the "Print Direction" to the "Print Activation".

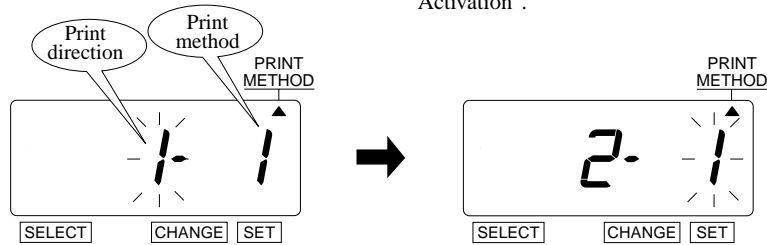

	Print Direction Options
1.	Right-hand margin of form
2.	Left-hand margin of form

### 2 Change the "Print Activation".

In case of the example, press the [CHANGE] button to set at "3".  
And then press the [SET] button.

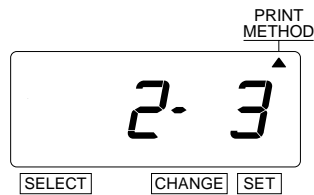

	Print Activation Options
1.	Automatic
2.	Semi-automatic
3.	Manual
4.	Combination

- 3** After you finish setting the print method, press the [SET] button once again.



Now the print method setting has been completed. Replace the cover and lock.

**Important:** Printing will not occur unless Step 3 is completed.

**Automatic** will allow the clock to print by simply inserting a card or piece of paper.

**Semi-automatic** will allow the clock to print by pressing the push bar only when a card or piece of paper is inserted. (Will print only when the card or paper reaches the sensor.)

**Manual** will allow the clock to print by pressing the push bar. (Will print even when the card or form does not reach the sensor.)

**Combination** will allow the time recorder to print by pressing the push bar or inserting a card or piece of paper.

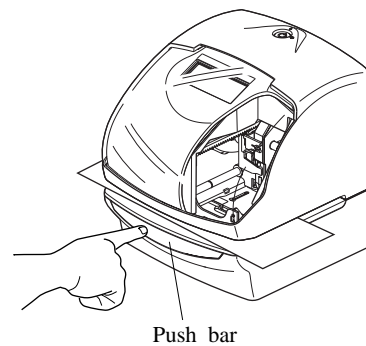

# 15. SETTING DAYLIGHT SAVING TIME

## Daylight Saving Time function

### 1 D.S.T. execution time

At 2:00 a.m. on the first day of Daylight Saving Time, the clock automatically gains one hour to show 3:00 a.m.

When 3:00 a.m. comes on the last day of the Daylight Saving Time, it loses one hour and returns to 2:00 a.m.

### 2 Setting D.S.T.

#### Example:

Start date Sunday, April 6, 2003

End date Sunday, October 26, 2003

If set as the above, **the unit remembers the start date as the first Sunday in April and the end date as the last Sunday in October.**

Once set, the unit automatically updates the settings every year thereafter. No further manual setting is necessary.

The setting for daylight saving time will be described using the following example.

#### Example

Today (present day)	Wednesday, January 29, 2003	
Starting date of daylight saving time	Sunday, April 6, 2003	The first Sunday in April
Ending date of daylight saving time	Sunday, October 26, 2003	The last Sunday in October

- 1 Press the [SELECT] button and position the "▲" next to the "DAYLIGHT SAVING TIME" mark. (The flashing means it can be changed.)

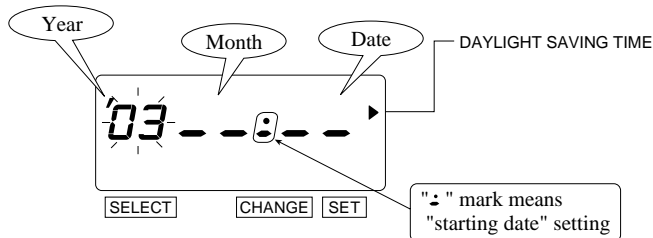

## Set the starting date.

### 2 Change the "Year"

In case of the example, press the [SET] button because the year 2003 is not being changed.

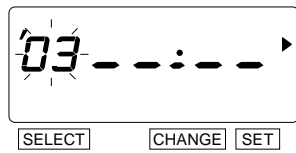

At the moment, the flashing changes from "Year" to "Month".

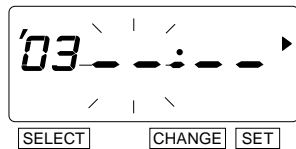

### 3 Change the "Month"

Push the [CHANGE] button to set at "4" and push the [SET] button.

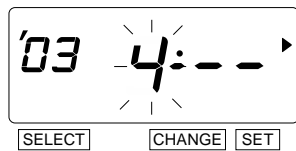

At the moment, the flashing changes from "Month" to "Date".

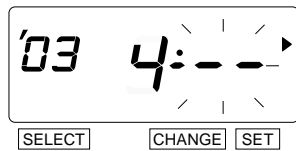

### 4 Change the "Date"

Push the [CHANGE] button to set at "06" and push the [SET] button.

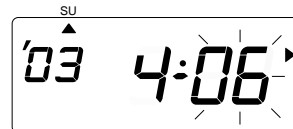

At the moment, the "starting date" of the display changes from flashing to steady and the "▲" mark is displayed under "SU".

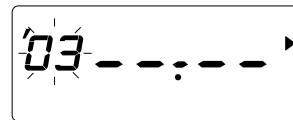

After a few seconds, go on to the "set the ending date".

Please see the following page.

## Set the ending date.

### 5 Change the "Year"

In case of the example, press the [SET] button because the year 2003 is not being changed.

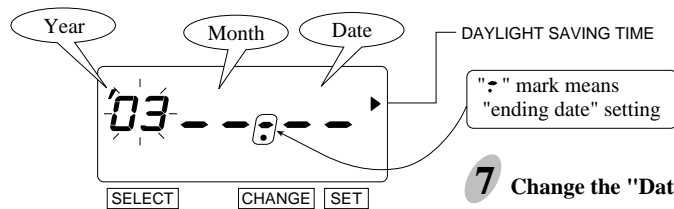

At the moment, the flashing changes from "Year" to "Month".

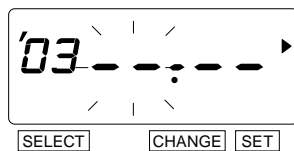

### 6 Change the "Month"

Push the [CHANGE] button to set at "10" and push the [SET] button.

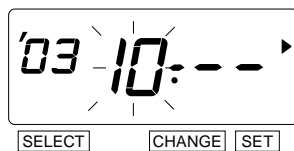

At the moment, the flashing changes from "Month" to "Date".

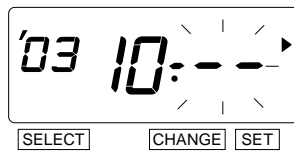

### 7 Change the "Date"

Push the [CHANGE] button to set at "26" and push the [SET] button.



At the moment, the "ending date" of the display changes from flashing to steady and the "▲" mark is displayed under "SU".



### 8 After you finish setting the daylight saving time, press the [SET] button once again.



Now the daylight saving time setting has been completed. Replace the cover and lock.

Important: Printing will not occur unless Step 8 is completed.

## Deleting the Daylight Saving Time settings

To delete and cancel the daylight saving time settings, change the display of "Month" of the starting setting to "--".

Example: To change April 6, 2003 as the "starting date" and delete daylight saving time settings.

- 1 Press the [SELECT] button and position the "▲" next to the "DAYLIGHT SAVING TIME" mark.  
(The flashing means it can be changed.)

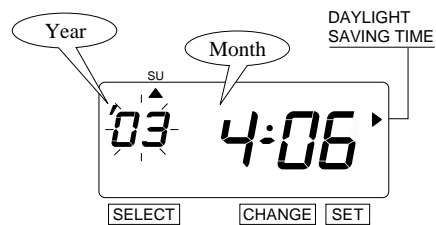

- 3 Press the [CHANGE] button to set at "--".

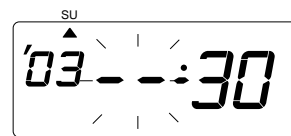

Press the [SET] button twice. This cancels the daylight saving time settings.

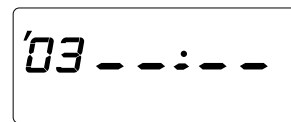

- 2 Press the [SET] button and the flashing changes from "Year" to "Month".

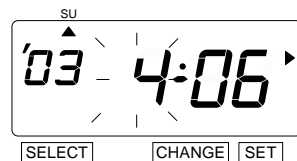

- 4 After you finish deleting the daylight saving time, press the [SET] button once again.



Deleting the daylight saving time has been completed. Replace the cover and lock.

Important: If you do not complete Step 4, the time recorder will not print.

## 16. SETTING THE NUMBER

In this setup, you can select digits of printed number, the Repeat Times of number, and type of Number Reset .

Example: Change the Number Digit to 4 digits and the Repeat Times to 2 times, and the Reset to 0.

- 1 Press the [SELECT] button and position the "▲" next to the "NUMBER" mark. At that moment, the flashing digit indicates "Number Digit". (The flashing means it can be changed.)

### Change the "Number Digit".

The Number Digit can be set to 1 to 8. In case of the example, press the [CHANGE] button to set at "4". And then press the [SET] button. At that moment, the flashing changes from the "Number Digit" to "Repeat Times".

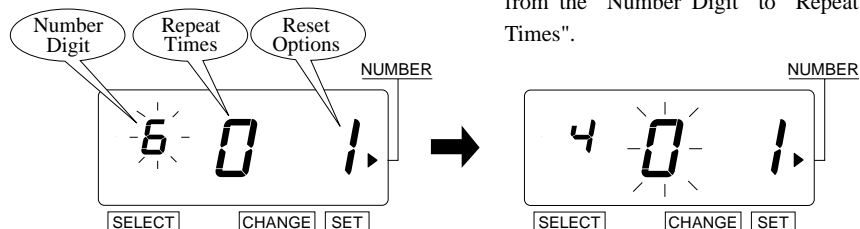

Print Example: 6 Digits of Number → 123456 JAN 31 '03  
4 Digits of Number → 1234 JAN 31 '03

- 2 Change the "Repeat Times".

The Repeat Times can be set to 0 to 9. In case of the example, press the [CHANGE] button to set at "2". And then press the [SET] button. At that moment, the flashing changes from "Repeat Times" to "Reset Options".

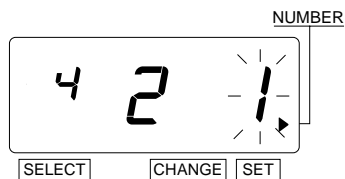

**Print Example:** 0 time repeat → (1st time) 123456 JAN 31 '03  
(2nd time) 123456 JAN 31 '03  
(3rd time) 123456 JAN 31 '03  
(4th time) 123456 JAN 31 '03  
(5th time) 123456 JAN 31 '03  
⋮

Note: If the recorder is set to repeat 0 times, the number will not advance.

2 times repeat → (1st time) 123456 JAN 31 '03  
(2nd time) 123456 JAN 31 '03  
(3rd time) 123457 JAN 31 '03  
(4th time) 123457 JAN 31 '03  
(5th time) 123458 JAN 31 '03  
⋮

**3 Change the "Reset Options".**

In case of the example, press the [CHANGE] button to set at "3". And then press the [SET] button.

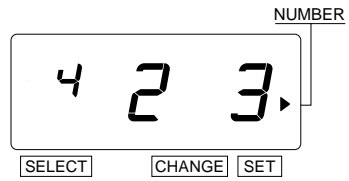

	Reset Options	Execution event of Reset.
1.	Disabled	—————
2.	Return to INITIAL NUMBER	Change of date
3.	Return to 0	Change of date

**4** After you finish setting the number, press the [SET] button once again.

Now the number setting has been completed. Replace the cover and lock.



Important: Printing will not occur unless Step 4 is completed.



# 17. SETTING THE INITIAL NUMBER

Example: Setting the initial number to "123". Refer to "16. SETTING THE NUMBER".

- 1 Press the [SELECT] button and position the "▲" next to the "INITIAL NUMBER" mark.  
At that moment, the flashing "-" indicates the 1st digit of the initial number.  
(The flashing means it can be changed.)

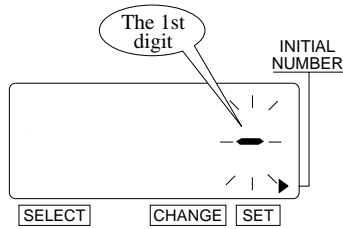

- 2 Set the "Initial Number".  
In case of the example, press the [CHANGE] button to set at "1". And then press the [SET] button.

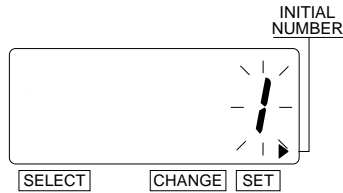

At that moment, the 2nd digit of "Initial Number" appears next to "1" (the 1st digit).

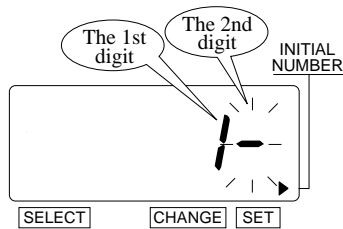

- 3 Set the correct numbers in the same manner as Step 2. And then press the [SET] button.

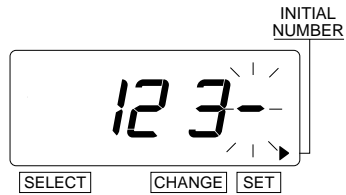

Note: Up to 8 digits can be set, however the number of digits for "Initial Number" depends on the number set in 16. Setting the Number.

Note: When the "Number Digit" has been set at "3", "-" doesn't appear next to "3" (the 3rd digit).

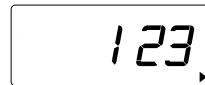

- 4 After you finish setting the initial number, press the [SET] button once again.



Now the initial number setting has been completed. Replace the cover and lock.

Important: Printing will not occur unless Step 4 is completed.

# 18. SETTING THE TIME TABLE PROGRAM

The time table program function allows I Mark® "\*" printing (Irregular registration Mark), an External Time Signal and a Built-in Buzzer. These functions can be programmed for each day of the week and each time period. Use the I Mark "\*" (asterisk prints) to indicate punches earlier or later than scheduled.

Example 1: The time table program is explained using the following example.

	0:00	9:00	17:30	0:00
<b>Monday to Friday</b>	<b>I Mark "*" OFF</b>	<b>I Mark "*" ON</b>	<b>I Mark "*" OFF</b>	

The following is time table based on the case above.

Program No.	Day of the week	Time	I Mark "*"
01	Mon. - Fri.	9:00	ON
02	Mon. - Fri.	17:30	OFF

- I Mark "\*" is not printed for the time period with no program setting.
- Up to 48 programs can be set (Program No. 1 through No. 48).

Print example: JAN 31 8:30  
 JAN 31 10:00 (\*) ← I Mark

- Press the [SELECT] button and position the "▲" over the "Time table program" mark. At that moment, the flashing digit indicates "Program No.". (The flashing means it can be changed.)

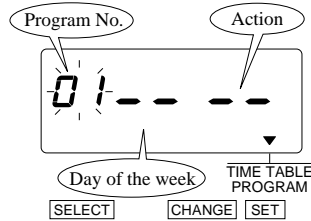

- Setting program No. 1**  
 (1) Set the "Day of the week". Press the [SET] button. At that moment, the flashing changes from the "Program No." to the "Day of the week".

In case of example, press the [CHANGE] button to set at "8". And then press the [SET] button. At that moment, the flashing changes from the "Day of the week" to the "Action".

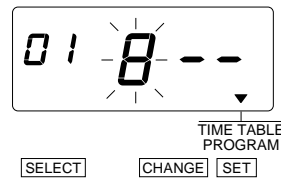

	Day of the week		Day of the week
1.	Monday only	6.	Saturday only
2.	Tuesday only	7.	Sunday only
3.	Wednesday only	8.	Monday to Friday
4.	Thursday only	9.	Monday to Saturday
5.	Friday only	10.	Every day

**(2) Set the "Action".**

Press the [CHANGE] button to set at "1". And then press the [SET] button.

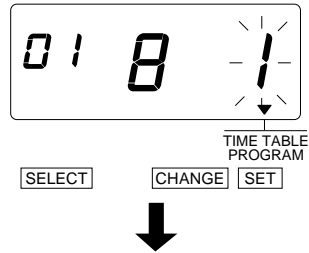

At that moment, the display changes to the following figure.

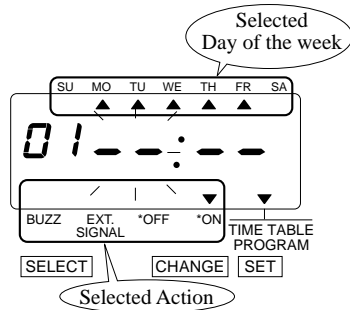

Action
1. I Mark "*" ON
2. I Mark "*" OFF
3. Ext. Signal ON
4. Built-in Buzzer ON

- The "Ext. Signal" and the "Built-in Buzzer" are available only when "Optional Board" is connected to the time recorder.

**(3) Set the "Hour".**

In case of example, press the [CHANGE] button to set at "9". And then press the [SET] button.

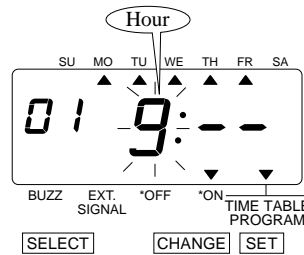

At that moment, the flashing changes from the "Hour" to the "Minute".

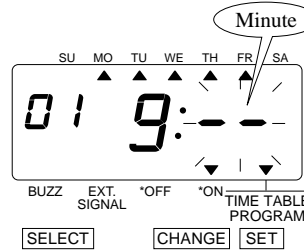

**(4) Set the "Minute".**

In case of example, press the [CHANGE] button to set at "00". And then press the [SET] button.

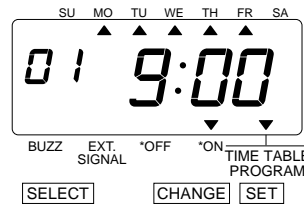

### 3 Setting program No. 2

Press the [CHANGE] button twice. At that moment, the display changes to the following figure.

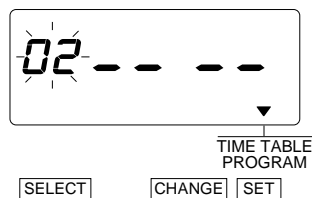

Make settings for Program No. 2 in the same manner as for Program No. 1, as illustrated in the following figure, and press the [SET] button.

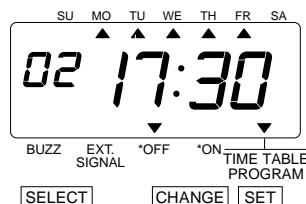

### 4 After you finish setting the time table program, press the [SET] button once again.

Now the time table program setting has been completed. Replace the cover and lock.



Important: Printing will not occur unless Step 4 is completed.

#### Example 2: The time table program is explained using the following example.

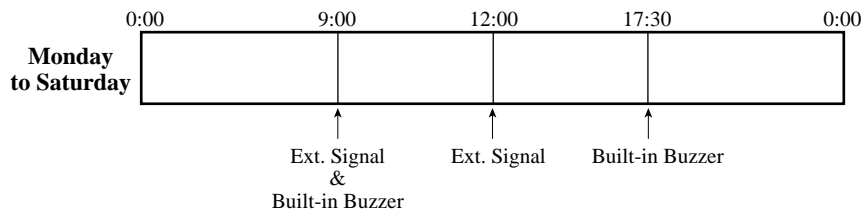

Program No.	Day of the week	Time	Ext. Signal ON	Built-in Buzzer ON
01	Mon. - Sat.	9:00	✓	
02	Mon. - Sat.	9:00		✓
03	Mon. - Sat.	12:00		✓
04	Mon. - Sat.	17:30	✓	

• Up to 48 programs can be set (Program No. 1 through No. 48).

- 1** Press the [SELECT] button and position the "▲" over the "Time table program" mark.  
At that moment, the flashing digit indicates the "Program No.". (The flashing means it can be changed.)

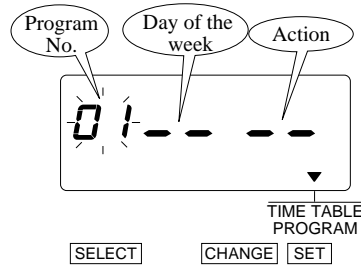

**2** Setting program No. 1

**(1) Set the "Day of the week".**

Press the [SET] button. At that moment, the flashing changes from the "Program No." to the "Day of the week".

In case of example, press the [CHANGE] button to set at "9". And then press the [SET] button. At that moment, the flashing changes from the "Day of the week" to the "Action".

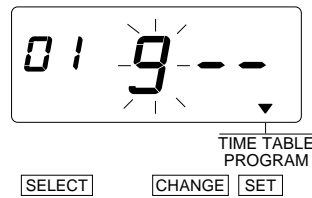

Day of the week	Day of the week
1. Monday only	6. Saturday only
2. Tuesday only	7. Sunday only
3. Wednesday only	8. Monday to Friday
4. Thursday only	9. Monday to Saturday
5. Friday only	10. Every day

**(2) Set the "Action".**

Press the [CHANGE] button to set at "3". And then press the [SET] button.

At that moment, the display changes to the following figure.

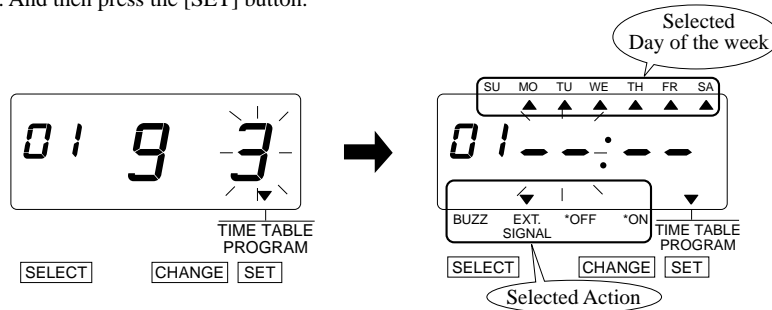

Action
1. I Mark "*" ON
2. I Mark "*" OFF
3. Ext. Signal ON
4. Built-in Buzzer ON

• The "Ext. Signal" and the "Built-in Buzzer" are available only when "Optional Board" is connected to the time recorder.

**(3) Set the "Hour".**

In case of example, press the [CHANGE] button to set at "9". And then press the [SET] button.

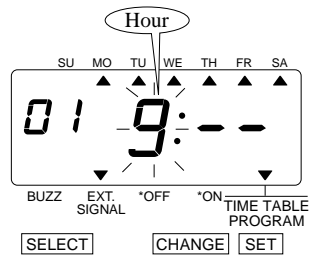

At that moment, the flashing changes from the "Hour" to the "Minute".

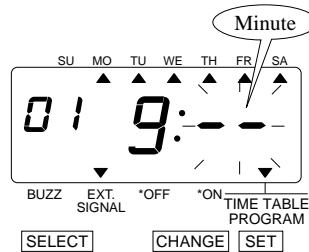

**(4) Set the "Minute".**

In case of example, press the [CHANGE] button to set at "00". And then press the [SET] button.

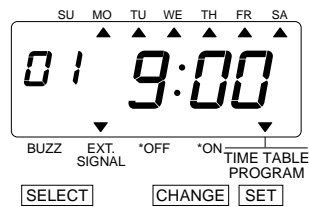

**3 Setting program No. 2**

Press the [CHANGE] button twice. At that moment, the display changes to the following figure.

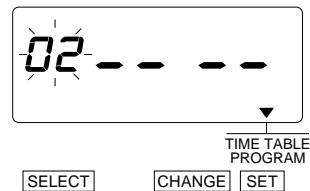

Make settings for Program No. 2 in the same manner as for Program No. 1, as illustrated in the following figure, and press the [SET] button.

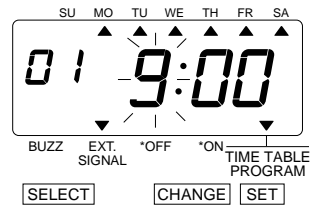

#### 4 Setting program No. 3

Make settings for Program No. 3 in the same manner as for Program No. 1, as illustrated in the following figure, and press the [SET] button.

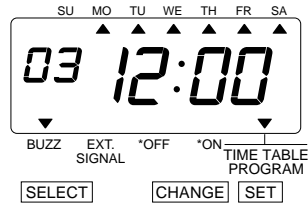

#### 5 Setting program No. 4

Make settings for Program No. 4 in the same manner as for Program No. 1, as illustrated in the following figure, and press the [SET] button.

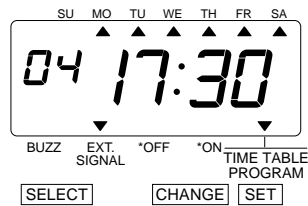

6 After you finish setting the time table program, press the [SET] button once again.



Now the time table program setting has been completed. Replace the cover and lock.

Important: Printing will not occur unless Step 6 is completed.

## Confirming the Time Table Program settings

To confirm the programs that have been set, press the [SELECT] button and position the "▲" over the "Time Table Program" mark. At that moment, the "Program No." flashes. And then press the [CHANGE] button.

After you finish confirming the program, press the [SET] button 6 times.

Now the time table program setting has been completed. Replace the cover and lock.

Important: If you do not complete confirming the settings, the time recorder will not print.

## Deleting the Time Table Program settings

Example: Deleting the "Program No. 2".

- 1 To delete a program, make the "Program No." flash, and press the [CHANGE] button until the desired program No. is displayed.

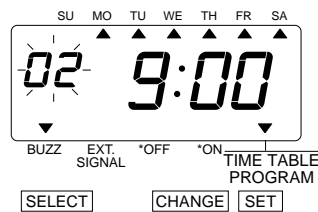

Press the [SET] button. At that moment, the display changes to the following figure.

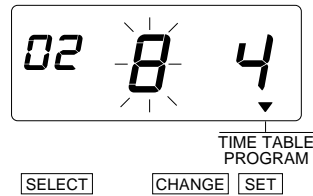

- 2 Press the [CHANGE] button to set at "--".

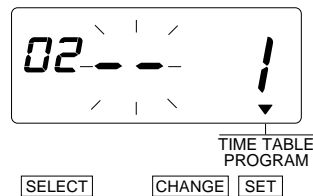

- 3 Press the [SET] button. At that moment, the display changes to the following figure.

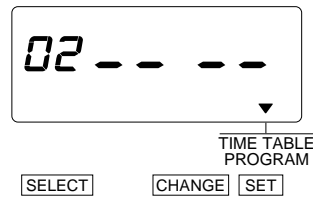

- 4 After you finish deleting a program, press the [SET] button once again.



Now the time table program setting has been completed. Replace the cover and lock.

Important: Printing will not occur unless Step 4 is completed.



## 19. SETTING THE EXTERNAL TIME SIGNAL / BUILT-IN BUZZER

With the optional board installed, the durations of External Time Signal and Built-in Buzzer can be set from 1 to 30 seconds.

Example: Change the External Time Signal to 30 seconds and the Built-in Buzzer to 10 seconds.

- Press the [SELECT] button and position the "▲" over the "EXT. SIGNAL / BUILT-IN BUZZ." mark. At that moment, the flashing digit indicates the "Ext. Signal". (The flashing means it can be changed.)

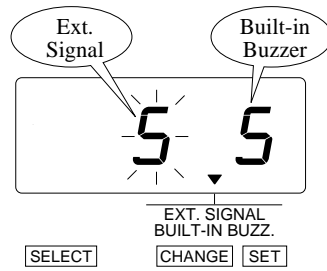

- Change the "Ext. Signal". In case of the example, press the [CHANGE] button to set at "30". And then press the [SET] button.

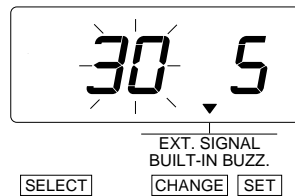

At that moment, the flashing changes from the "Ext. Signal" to the "Built-in Buzzer".

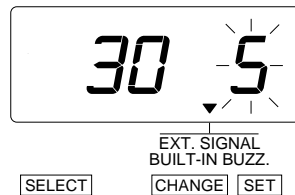

- Change the "Built-in Buzzer". In case of the example, press the [CHANGE] button to set at "10". And then press the [SET] button.

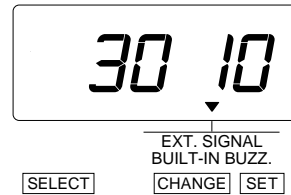

- After you finish setting the external time signal / built-in buzzer, press the [SET] button once again.



Now the external time signal / built-in buzzer setting has been completed. Replace the cover and lock.

Important: Printing will not occur unless Step 4 is completed.

## 20. SETTING THE SLAVE CLOCK

In this setup, you can select the Slave Clock.

**Note: For this feature to be functional, the optional board must be installed in the Time Recorder.**

	Clock Options
0.	Disabled
1.	Slave Clock
2.	N/A

	Signal Options (for Slave Clock)
30.	30-second reversal
60.	60-second reversal
59.	59-minute impulse

### Setting the Slave Clock

Example: Set the Slave Clock and 60-second reversal.

- 1 Press the [SELECT] button and position the "▲" up the "SLAVE CLOCK" mark. At that moment, the flashing digit indicates "Clock Options". (The flashing means it can be changed.)

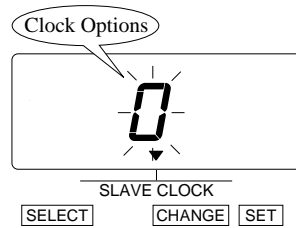

#### Set the "Clock Options".

In case of the example, press the [CHANGE] button to set at "1". And then press the [SET] button. At that moment, the flashing changes from the "Clock Options" to "Signal Options".

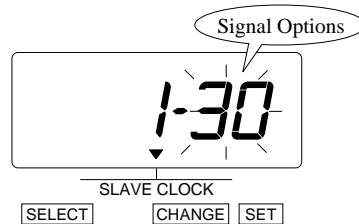

- 2 Set the "Signal Options". In case of the example, press the [CHANGE] button to set at "60". And then press the [SET] button.

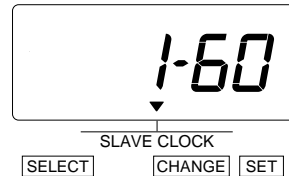

- 3 After you finish setting the slave clock, press the [SET] button once again.



Now the slave clock setting has been completed. Replace the cover and lock.

Important: Printing will not occur unless Step 3 is completed.

## 21. SETTING THE PASSWORD

When the password is set, you are asked to enter it. If the password you entered does not coincide with the setting, you cannot change the setting values.

You may select any 4-digit number from 0001 to 9998 as your password.

Note : Numbers "0000" and "9999" are not valid passwords.

**All settings must be reset if you forget the password. Refer to the "23. RESETTING".**

Example: Set the password "1234".

- 1 Press the [SELECT] button and position the "▲" over the "PASSWORD" mark. At the moment, the first two digits flash. (The flashing means it can be changed.)

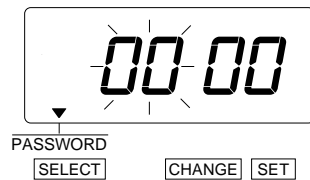

### Change the first two digits.

In case of the example, press the [CHANGE] button to set at "12". And then press the [SET] button.

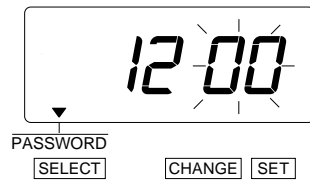

At that moment, the flashing changes to the last two digits.

- 2 **Change the last two digits.**  
In case of the example, press the [CHANGE] button to set at "34". And then press the [SET] button.

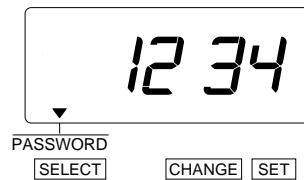

- 3 After you finish registering the password, press the [SET] button once again.



Now the password registering has been completed. Replace the cover and lock.

**Important:** Printing will not occur unless Step 3 is completed.

## How to change settings when the Password is set

Once the password is set, you are required to enter the current password before changing any settings.

"9999" will be displayed when you press the [SELECT] button.

- 1 Press the [SELECT] button, at that moment "9999" is displayed and the first two digits flash.  
(The flashing means it can be changed.)

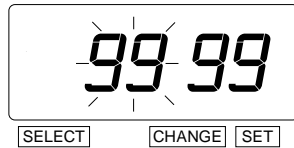

### Set the first two digits.

In the example, press the [CHANGE] button to set at "12". And then press the [SET] button.

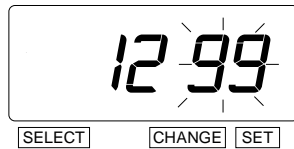

At that moment, the flashing changes to the last two digits.

- 2 Set the last two digits.

In case of the example, press the [CHANGE] button to set at "34". Then press the [SET] button.

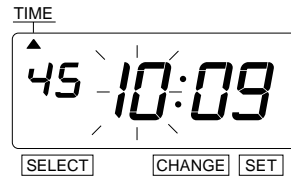
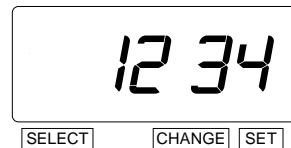

At that moment, the "▲" mark indicates the "TIME".

- 3 Select desired setting mode by pressing the [SELECT] button.  
Then make any changes to settings as explained.

## Canceling the Password

The code "0000" must be entered to cancel the password.

Example: Cancel the password "1234".

- 1 Press the [SELECT] button, at that moment "9999" is displayed and the first two digits flash.  
(The flashing means it can be changed.)

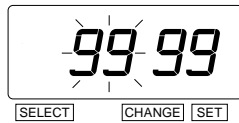

In the example, press the [CHANGE] button to set at "12". And then press the [SET] button.

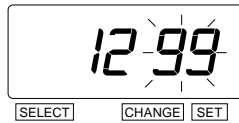

At that moment, the flashing changes to the last two digits.

- 2 In case of the example, press the [CHANGE] button to set at "34". And then press the [SET] button.

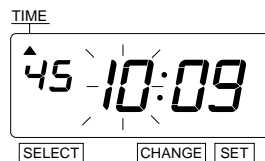
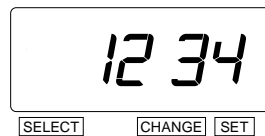

At that moment, the "▲" mark indicates the "TIME".

- 3 Press the [SELECT] button and position the "▲" over the "PASSWORD" mark. At that moment, the first two digits "12" flash.  
(The flashing means it can be changed.)

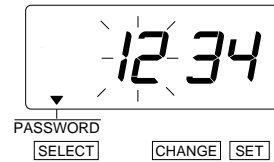

Press the [CHANGE] button to set at "00". And then press the [SET] button.

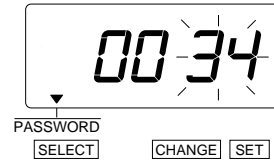

At that moment, the flashing changes to the last two digits "34".

- 4 Press the [CHANGE] button to set "00". And then press the [SET] button.

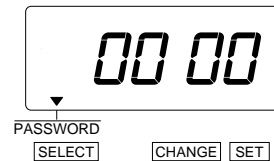

- 5 After you finish canceling the password, press the [SET] button once again.

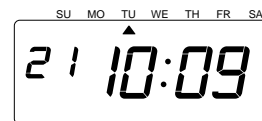

Now the password canceling has been completed. Replace the cover and lock.

Important: Printing will not occur unless Step 5 is completed.

## 22. RE-SETTING

To return all setting to the factory defaults, push the reset switch with a pointed implement.

NOTICE: All your custom settings will be deleted and will revert to the factory defaults when the reset switch is pushed. To make new settings, please refer to "Setting ...".

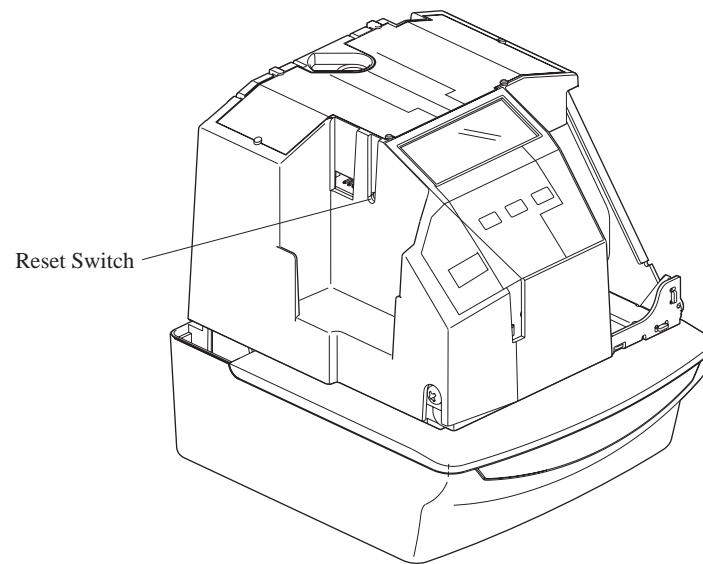

## 23. WALL MOUNTING

Caution: The supplied screws are intended for use on a thick wooden wall or wooden column. Do not use any other materials. The time clock may come off if used on other materials.

- 1** Install the supplied wall-mount screws into a wall by using the template. Be sure to keep about 6mm (1/4") of the screw head away from the wall. The recommended height from the floor to the bottom of the ES900 is 45".

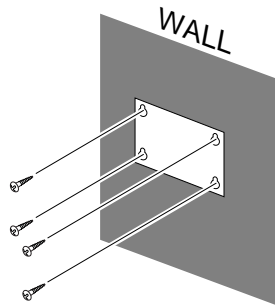

- 3** Replace cover and lock.

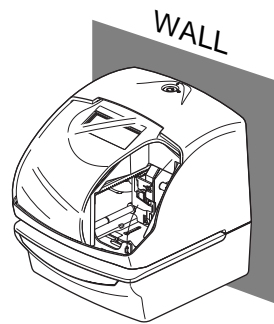

- 2** Unlock the key and remove the cover. And then hang it on the wall.

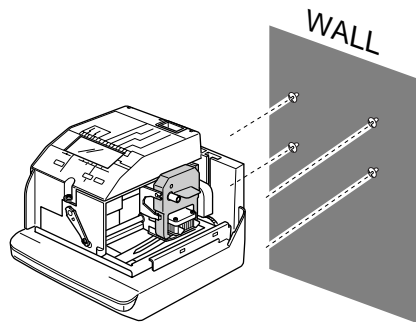

## 24. REPLACING THE RIBBON CASSETTE

**1** Unlock the key and remove the cover.

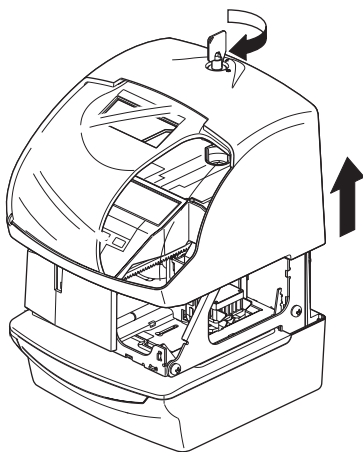

**3** Turn the knob of the new cassette in the direction of the arrow (clockwise) to tighten the ribbon.

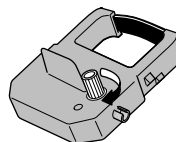

**2** Hold the ribbon cassette by its tab and pull straight out to remove it.

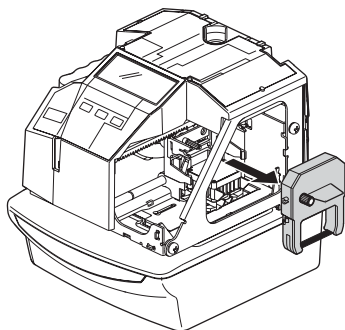

**4** Place the cassette inside the time recorder as shown in the figure. Push the ribbon until it snaps into position. Turning the knob on the ribbon cassette may make installation easier.

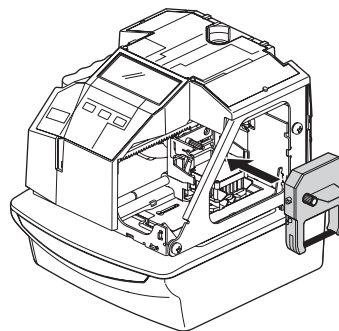



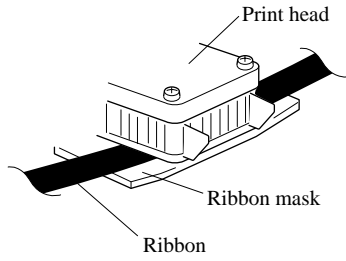

NOTE: Install the cassette so that the ribbon is between the print head and the ribbon mask. Printing will not come out properly if the ribbon is placed behind the ribbon mask.

- 5** Turn the knob of the cassette in the direction of the arrow to tighten the ribbon.

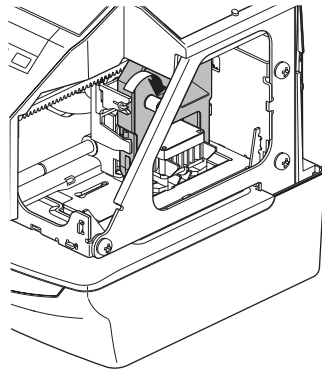

- 6** Replace the cover and lock.

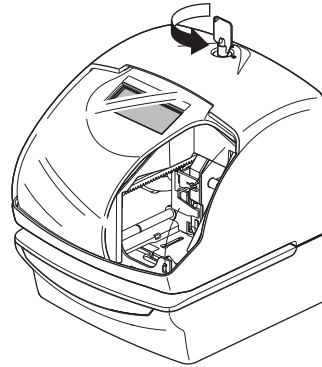

## 25. CHARACTER CODE FOR ALPHANUMERIC

Num: Sequential number HH: Hour MM: Minute SS: Second DOW: Day of the week  
 ※1~※15: Language-Specific Character

Code	Character	Max. Dots
00	NULL	-
01	SPACE	3

Code	Meaning	Code	Meaning
F8	Insert Character	FC	Exchange Line 1 to 2
F9	Delete Character	Fd	Exchange Line 2 to 3
FR	Insert Line	FE	Exchange Line 3 to 1
Fb	Delete Line	FF	Delete All

### Large (BOLD) Character

Code	Character	Max. Dots	Code	Character	Max. Dots	Code	Character	Max. Dots
02	A	8	1b	Z	8	34	※4	-
03	B	8	1c	0	8	35	※5	-
04	C	8	1d	1	8	36	※6	-
05	D	8	1E	2	8	37	※7	-
06	E	8	1F	3	8	38	※8	-
07	F	8	20	4	8	39	※9	-
08	G	8	21	5	8	3A	※10	-
09	H	8	22	6	8	3b	※11	-
0A	I	5	23	7	8	3C	※12	-
0b	J	8	24	8	8	3d	※13	-
0c	K	8	25	9	8	3E	※14	-
0d	L	8	26	Year	32(19)	3F	※15	-
0E	M	8	27	Month	24	40	'	3
0F	N	8	28	Date	16	41	*	7
10	O	8	29	DOW	16	42	+	7
11	P	8	2A	HH:MM	37(49)	43	,	5
12	Q	8	2b	HH:MM:SS	58(70)	44	-	7
13	R	8	2c	Number	8x(n)	45	.	5
14	S	8	2d	Number	8x(n)	46	/	8
15	T	7	2E	Number	8x(n)	47	:	5
16	U	8	2F	Number	8x(n)	48	;	5
17	V	8	30	Number	8x(n)	49	_	6
18	W	8	31	※1	-	4A	&	10
19	X	8	32	※2	-			
1A	Y	7	33	※3	-			

Note: ( ) is to indicate the following meanings.

Code=26: 2 digits setting of YEAR, Code=2A and 2b:AM/PM setting of HOUR,  
 Code=2C to 30: Number digits depend on the setting.

## Large Character

Code	Character	Max. Dots	Code	Character	Max. Dots	Code	Character	Max. Dots
4b	A	7	64	Z	7	7d	※4	-
4c	B	7	65	0	7	7e	※5	-
4d	C	7	66	1	7	7f	※6	-
4e	D	7	67	2	7	80	※7	-
4f	E	7	68	3	7	81	※8	-
50	F	7	69	4	7	82	※9	-
51	G	7	6a	5	7	83	※10	-
52	H	7	6b	6	7	84	※11	-
53	I	4	6c	7	7	85	※12	-
54	J	7	6d	8	7	86	※13	-
55	K	7	6e	9	7	87	※14	-
56	L	7	6f	Year	28(18)	88	※15	-
57	M	8	70	Month	22	89	'	3
58	N	7	71	Date	14	8a	*	6
59	O	7	72	DOW	15	8b	+	6
5a	P	7	73	HH:MM	32(44)	8c	,	4
5b	Q	7	74	HH:MM:SS	50(62)	8d	-	6
5c	R	7	75	Number	7x(n)	8e	.	4
5d	S	7	76	Number	7x(n)	8f	/	6
5e	T	6	77	Number	7x(n)	90	:	4
5f	U	7	78	Number	7x(n)	91	;	4
60	V	7	79	Number	7x(n)	92	_	5
61	W	8	7a	※1	-	93	&	9
62	X	7	7b	※2	-			
63	Y	6	7c	※3	-			

Note: ( ) is to indicate the following meanings.

Code=6F: 2 digits setting of YEAR, Code=73 and 74:AM/PM setting of HOUR,

Code=75 to 79: Number digits depend on the setting.

### Small Character

Code	Character	Max. Dots	Code	Character	Max. Dots	Code	Character	Max. Dots
<i>94</i>	A	6	<i>b5</i>	7	6	<i>d6</i>	HH:MM	26(37)
<i>95</i>	B	6	<i>b6</i>	8	6	<i>d7</i>	HH:MM:SS	40(57)
<i>96</i>	C	6	<i>b7</i>	9	6	<i>d8</i>	Number	6x(n)
<i>97</i>	D	6	<i>b8</i>	a	5	<i>d9</i>	Number	6x(n)
<i>98</i>	E	6	<i>b9</i>	b	5	<i>dA</i>	Number	6x(n)
<i>99</i>	F	6	<i>bA</i>	c	5	<i>db</i>	Number	6x(n)
<i>9A</i>	G	6	<i>bB</i>	d	5	<i>dC</i>	Number	6x(n)
<i>9b</i>	H	6	<i>bC</i>	e	5	<i>dd</i>	※1	-
<i>9C</i>	I	4	<i>bD</i>	f	4	<i>dE</i>	※2	-
<i>9d</i>	J	6	<i>bE</i>	g	5	<i>dF</i>	※3	-
<i>9E</i>	K	6	<i>bF</i>	h	5	<i>E0</i>	※4	-
<i>9F</i>	L	6	<i>C0</i>	i	2	<i>E1</i>	※5	-
<i>AD</i>	M	6	<i>C1</i>	j	3	<i>E2</i>	※6	-
<i>A1</i>	N	6	<i>C2</i>	k	5	<i>E3</i>	※7	-
<i>A2</i>	O	6	<i>C3</i>	l	2	<i>E4</i>	※8	-
<i>A3</i>	P	6	<i>C4</i>	m	6	<i>E5</i>	※9	-
<i>A4</i>	Q	6	<i>C5</i>	n	5	<i>E6</i>	※10	-
<i>A5</i>	R	6	<i>C6</i>	o	5	<i>E7</i>	※11	-
<i>A6</i>	S	6	<i>C7</i>	p	5	<i>E8</i>	※12	-
<i>A7</i>	T	6	<i>C8</i>	q	5	<i>E9</i>	※13	-
<i>A8</i>	U	6	<i>C9</i>	r	5	<i>EA</i>	※14	-
<i>A9</i>	V	6	<i>CA</i>	s	5	<i>Eb</i>	※15	-
<i>AA</i>	W	6	<i>Cb</i>	t	4	<i>EC</i>	'	3
<i>Ab</i>	X	6	<i>CC</i>	u	5	<i>Ed</i>	*	6
<i>AC</i>	Y	6	<i>Cd</i>	v	5	<i>EE</i>	+	6
<i>Ad</i>	Z	6	<i>CE</i>	w	6	<i>EF</i>	,	4
<i>AE</i>	0	6	<i>CF</i>	x	6	<i>F0</i>	-	5
<i>AF</i>	1	6	<i>d0</i>	y	5	<i>F1</i>	.	4
<i>b0</i>	2	6	<i>d1</i>	z	6	<i>F2</i>	/	6
<i>b1</i>	3	6	<i>d2</i>	Year	24(15)	<i>F3</i>	:	4
<i>b2</i>	4	6	<i>d3</i>	Month	18	<i>F4</i>	;	4
<i>b3</i>	5	6	<i>d4</i>	Date	12	<i>F5</i>	_	4
<i>b4</i>	6	6	<i>d5</i>	DOW	12	<i>F6</i>	&	8

Note: ( ) is to indicate the following meanings.

Code=d2: 2 digits setting of YEAR, Code=d6 and D7:AM/PM setting of HOUR,

Code=d8 to dc: Number digits depend on the setting.

## Language-Specific Character

### English

	※1	※2	※3	※4	※5	※6	※7	※8	※9	※10	※11	※12	※13	※14	※15
Character	#	\$	@	[	\	]	^	`	{		}	~	EURO		
Dots	Bold	9	9	9	7	8	7	8	5	7	5	7	7	8	
	Large	7	6	7	6	6	6	6	4	6	4	6	6	7	
	Small	6	6	6	5	6	5	4	3	5	4	5	6	6	

### Spanish

	※1	※2	※3	※4	※5	※6	※7	※8	※9	※10	※11	※12	※13	※14	※15
Character	Pt	\$	@	i	Ñ	¿	´	`	¨	ñ	}	~	EURO		
Dots	Bold	11	9	9	5	8	7	5	5	9	7	7	7	8	
	Large	8	6	7	4	7	6	4	4	7	7	6	6	7	
	Small	8	6	6	4	6	6	3	3	7	6	5	6	6	

### German

	※1	※2	※3	※4	※5	※6	※7	※8	※9	※10	※11	※12	※13	※14	※15
Character	#	\$	§	Ä	Ö	Ü	^	`	ä	ö	ü	ß	EURO		
Dots	Bold	9	9	8	8	8	8	5	7	7	7	8	8		
	Large	7	6	7	7	7	7	6	4	7	6	6	7	7	
	Small	6	6	6	6	6	6	4	3	5	5	5	6	6	

### French

	※1	※2	※3	※4	※5	※6	※7	※8	※9	※10	※11	※12	※13	※14	※15
Character	#	\$	à	°	ç	§	^	`	é	ù	è	¨	EURO		É
Dots	Bold	9	9	7	4	7	8	8	5	7	7	7	9	8	8
	Large	7	6	7	4	6	7	6	4	6	6	6	7	7	7
	Small	6	6	5	4	5	6	4	3	5	5	5	7	6	6

### Italian

	※1	※2	※3	※4	※5	※6	※7	※8	※9	※10	※11	※12	※13	※14	※15
Character	#	\$	@	°	\	é	^	ù	à	ò	è	ì	EURO		
Dots	Bold	9	9	9	4	8	7	8	7	7	7	7	5	8	
	Large	7	6	7	4	6	6	6	6	7	6	6	4	7	
	Small	6	6	6	4	6	5	4	5	5	5	5	4	6	

### Portuguese

	※1	※2	※3	※4	※5	※6	※7	※8	※9	※10	※11	※12	※13	※14	※15
Character	#	\$	@	[	\	]	^	`	{		}	~	EURO		
Dots	Bold	9	9	9	7	8	7	8	5	7	5	7	7	8	
	Large	7	6	7	6	6	6	6	4	6	4	6	6	7	
	Small	6	6	6	5	6	5	4	3	5	4	5	6	6	

### Numeric

	※1	※2	※3	※4	※5	※6	※7	※8	※9	※10	※11	※12	※13	※14	※15
Character	#	\$	@	[	\	]	^	`	{		}	~	EURO		
Dots	Bold	9	9	9	7	8	7	8	5	7	5	7	7	8	
	Large	7	6	7	6	6	6	6	4	6	4	6	6	7	
	Small	6	6	6	5	6	5	4	3	5	4	5	6	6	

## 26. INSTALLING THE OPTIONAL Ni-Cd BATTERY

This option allows for printing up to 200 registrations without AC power.

Order Acroprint Part Number 58-0108-000, optional battery pack, for this feature.

**1** Unlock the key and remove the cover.

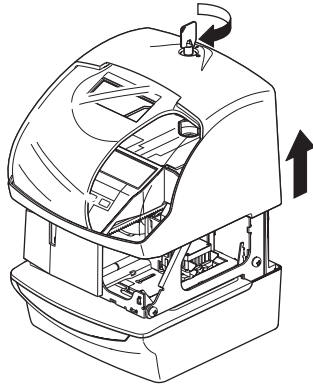

**3** Replace the cover and lock.

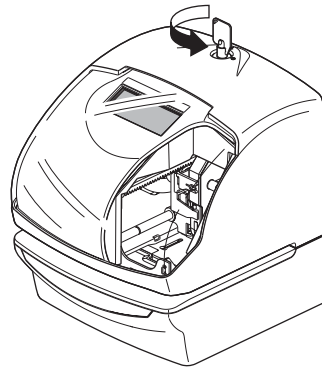

**2** Insert the battery connector into the compartment connector to install the battery.

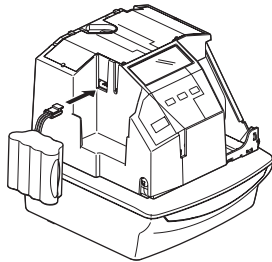

## 27. CONNECTING THE OPTIONAL FUNCTIONS

### Connecting the Master Clock

**CAUTION:** Be sure to pull out AC cord from AC outlet before connecting wires of the Master Clock.

Improper connection may cause a malfunction of the unit.

Also refer to "Attaching the Wire Clamp" to secure wires with the wire clamp.

- 1 Unlock the key and remove the cover.

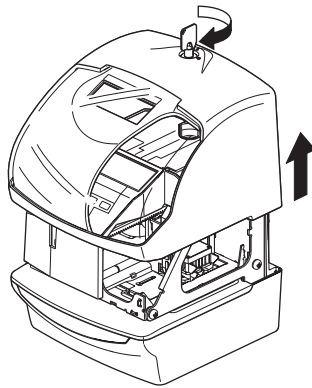

- 3 Insert wires into two left terminals for the master clock, and tighten both screws.

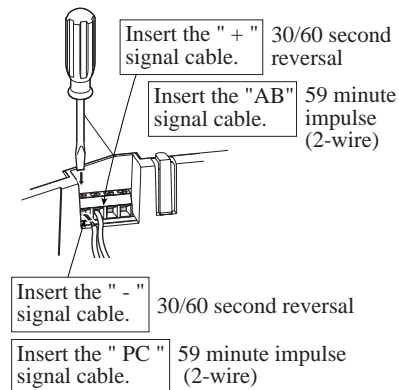

- 2 The connector for the master clock signals is on the back of the time recorder.

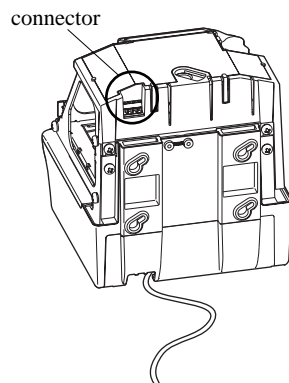

- 4 Replace the cover and lock.

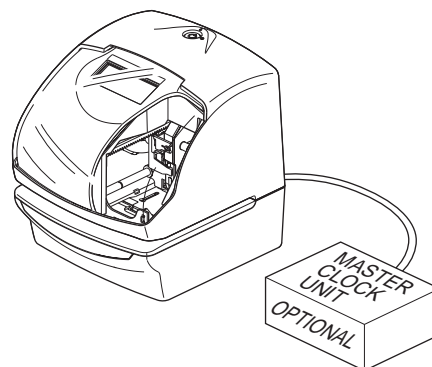

53

## Connecting the External Time Signal

If external signal(s) are required, the addition of a relay (not supplied) will be necessary. *Please consult your local electrician.*

When a signal is activated the internal contacts close completing the circuit. These internal contacts are "dry" and supply no voltage. Voltage applied to these contacts must *not* exceed 30 volts. An external relay must be used to activate signaling devices.

Recommended Relays: (Or similar line voltage switching relays)

Available at W. W. Grainger

HoneyWell	#RA89A1074	Grainger #2E866
Dayton	#809A-189	Grainger #2E553

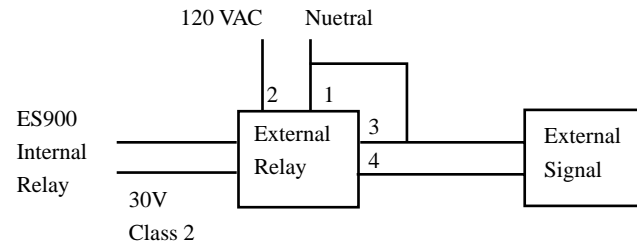

Connections shown for Dayton 2E553. Add jumper from terminals 1 to 3.

**CAUTION:** Be sure to pull out AC cord from AC outlet before connecting wires of the External Time Signal. Improper connection may cause a malfunction of the unit. Also refer to "Attaching the Wire Clamp" to secure wires with the wire clamp.

**1** Unlock the key and remove the cover.

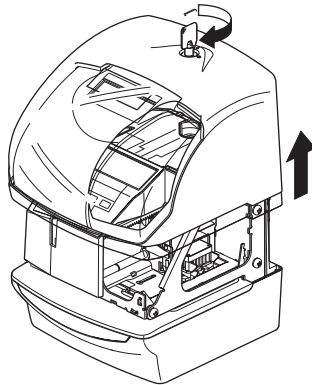

**2** Insert wires into two right terminals for external time signal, and tighten both screws.

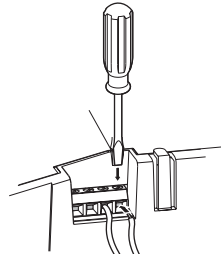



## Attaching the Wire Clamp

**CAUTION:** Be sure to pull out AC cord from AC outlet before attaching the wire clamp.

- 1 Remove two screws holding the wire clamp.

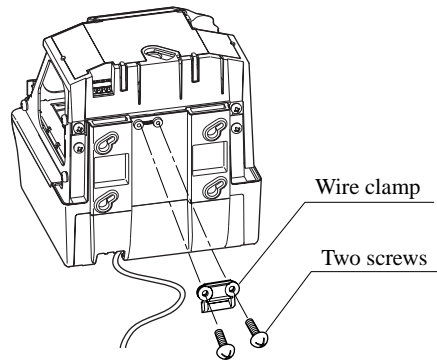

- 2 Make wires go through the hole of the wire clamp and secure it with screws. (See the Figure 1.)

If diameter of wires is too small to fix by the above method, turn the wire clamp upside down and feed wires through the clamp. Then secure it with screws. (See the Figure 2.)

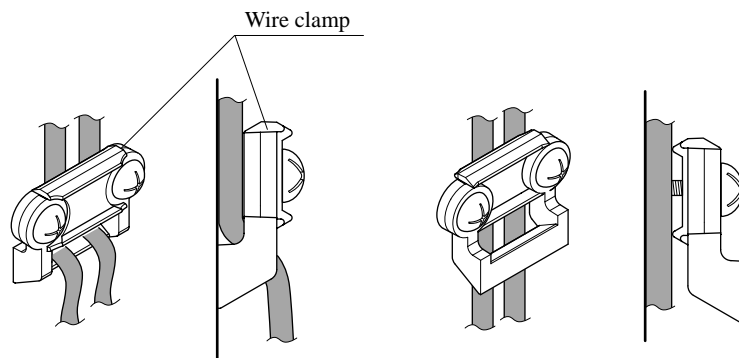

Figure 1

Figure 2

## 28. TROUBLE-SHOOTING

### Error No. appears

Refer to the following list for proper operation.

No.	Error contents	Action
E-00	CPU error	Contact Acroprint at (800) 334-7190 (in USA).
E-01	The remaining life of lithium battery for memory back-up is short.	
E-05	The card is not inserted in the Time Stamp properly.	Correctly insert the card.
E-30	Cannot print. The printer motor or home position sensor is not normal.	Make sure that the ribbon cassette is correctly inserted in place.
E-38	Cannot print. The printer head motor or the sensor does not operate properly.	Press the push bar.
E-40	Incorrect password	Enter the correct password again.
E-41	D.S.T. setting mistake	Confirm the correct starting and ending dates of daylight saving time and enter again.
E-49	Setting data you entered is not usable.	Refer to your user's manual on the page related to the item you want to set and enter correct setting data.

### OTHER FAILURES

- The time recorder does not operate.  
Ensure the power cord is properly plugged into the AC outlet and power is available.
- The time recorder does not print.  
Ensure the ribbon is installed correctly and the proper print method is set.
- The card is jammed.  
Press the push bar and try to pull out the card at the same time.
- Fails to hold memory.  
Replace lithium battery with Toshiba, part number ER3VT2.

## 29. SPECIFICATIONS

Clock accuracy	Monthly accuracy $\pm$ 15sec. (at ordinary temperatures)
Calendar	Year up to 2099. Automatically adjusted to leap years, 31-day months and months with thirty or fewer days, and the days of the week.
Printing system	Dot matrix
Power failure compensation	Three years of cumulative power failure hours after the date of shipment.
Print at power failure	Optional Ni-Cd battery, 200 print registrations or 24 hours Acroprint part number 58-0108-000
Lithium battery	Toshiba part number ER3VT2
Time program	External time signal Built-in buzzer Printing an I Mark (*)
Connection of external signal	Connection with optional functions. External Alarm device : No voltage signal output. Master Clock device : 6 to 32 V signal input.
Operating environment	Temperature: $-5^{\circ}$ to $+45^{\circ}$ C, $+25^{\circ}$ to $+113^{\circ}$ F Humidity: 20 to 80%, no condensation The unit operates normally at temperatures of $5^{\circ}$ C or below, but the print density, reaction of the liquid crystal display, and the number of prints at power failure are inferior to those at normal temperature operation.
Dimensions	6.14" (w) x 7.13" (h) x 6.97" (d) 156 (w) x 181 (h) x 177 (d) mm
Weight	Approx. 4.0 lbs. (1.8kg)
Rating	120VAC 50/60Hz 0.4A 220-240VAC 50/60Hz 0.2A

<http://www.datatime.co.uk>

<http://www.timerecordersdirect.co.uk>

P/N 06-0316-000 Rev. A