



La Silla

European Southern Observatory

Organisation Européenne pour des Recherches Astronomiques dans l'Hémisphère Austral  
Europäische Organisation für astronomische Forschung in der südlichen Hemisphäre

La Silla Observatory

High Accuracy Radial Velocity Planet Searcher

**HARPS**

**User Manual**

3P6-MAN-ESO-90100-0005

Issue: 1.3

Date: May 25th, 2006

La Silla Observatory ★ ESO ★ Chile

### Change Record

Issue	date	sections affected	Reason/Remarks
0.1	February 2003	all	First version
0.2	March 5, 2003	all	for comments
0.3	March 10, 2003	all	first public issue for P72 CfP
0.4	June 16, 2003	all	GRU → DQU
0.5	July 8, 2003	all	DRS + end of Comm2/DQU
0.6	July 31, 2003	all	DAU info DSo
0.7	Sept 17, 2003	DRS related	data format +answer to comments DQU
1.0	Nov 25, 2003	all	more information added and structure revised (GLO)
1.1	May 25, 2004	all	full update (GLO)
1.2	August 2005	Observing	overheads and asteroseismology issues (GLO)
1.3	May 2006	HARPS characteristics & EGGS	include slow readout mode, THAR3 lamp and EGGS (GLO)
Editor: G. Lo Curto: ESO La Silla			

# Contents

<b>1</b>	<b>Introduction</b>	<b>1</b>
1.1	Scope . . . . .	1
1.2	Additional information . . . . .	1
1.3	Contact information . . . . .	2
1.4	Acknowledgments . . . . .	2
<b>2</b>	<b>HARPS Characteristics</b>	<b>3</b>
2.1	Instrument Overview . . . . .	3
2.2	Operations overview . . . . .	5
2.3	Fibre links . . . . .	7
2.4	Calibration unit . . . . .	7
2.5	Fibre adapter . . . . .	8
2.6	Detector and read out electronics . . . . .	8
2.7	Exposure meter . . . . .	9
2.8	Data reduction software . . . . .	10
2.9	System efficiency . . . . .	10
<b>3</b>	<b>Observing modes</b>	<b>13</b>
3.1	Simultaneous Thorium reference method . . . . .	13
3.1.1	Performance . . . . .	13
3.1.2	Calibrations . . . . .	14
3.1.3	Observing templates . . . . .	15
3.1.4	Pipeline, data reduction . . . . .	15
3.2	Iodine self-calibration method (out of service since May 2004) . . . . .	15
3.2.1	Performance . . . . .	16
3.2.2	Calibration . . . . .	16
3.2.3	Observing templates . . . . .	16
3.2.4	Pipeline, data reduction . . . . .	16
3.3	Classical fibre spectroscopy . . . . .	16
3.3.1	Performance . . . . .	17
3.3.2	Calibration . . . . .	17
3.3.3	Templates . . . . .	17
3.3.4	Pipeline, data reduction . . . . .	17
<b>4</b>	<b>RV accuracy</b>	<b>19</b>
4.1	Photon noise . . . . .	19
4.2	Telescope focus . . . . .	20
4.3	Centering errors . . . . .	20
4.4	Thorium calibration errors . . . . .	20
4.5	EAGS RV accuracy . . . . .	20

<b>5</b>	<b>Preparing the observations</b>	<b>21</b>
5.1	Introduction . . . . .	21
5.2	Introducing Observing Blocks . . . . .	21
5.3	P2PP . . . . .	21
5.3.1	Acquisition templates . . . . .	22
5.3.2	Observing template . . . . .	23
5.3.3	Calibration templates . . . . .	23
5.4	Overheads . . . . .	23
5.4.1	Execution time overheads . . . . .	23
5.4.2	“Off-line” overheads . . . . .	23
5.4.3	Fast time series observations (asteroseismology) . . . . .	23
5.4.4	Iodine cell (out of service since May 2004) . . . . .	24
5.5	The HARPS Exposure Time and Spectral Format Calculator . . . . .	25
<b>6</b>	<b>Observing with HARPS</b>	<b>27</b>
6.1	Before the night . . . . .	27
6.2	During the night . . . . .	27
6.2.1	Target acquisition, guiding, focusing . . . . .	27
6.2.2	Pointing restrictions . . . . .	28
6.3	Night calibrations . . . . .	29
6.4	Real-time display . . . . .	29
6.5	Observing very faint stars . . . . .	29
6.6	Asteroseismology . . . . .	29
6.7	End of the night . . . . .	31
<b>7</b>	<b>Data products and archiving</b>	<b>33</b>
7.1	Data products . . . . .	33
7.2	Data archiving . . . . .	34
7.2.1	La Silla and Garching archives . . . . .	34
7.2.2	La Silla data archiving unit . . . . .	34
7.2.3	Use of archived HARPS data . . . . .	34
<b>8</b>	<b>The Reduction of HARPS Data</b>	<b>37</b>
8.1	The HARPS data reduction pipeline . . . . .	37
8.2	High accuracy radial velocities . . . . .	37
8.3	Iodine cell data . . . . .	38
<b>9</b>	<b>HARPS high efficiency mode: EGGS</b>	<b>39</b>
<b>A</b>	<b>Description of archived HARPS data</b>	<b>41</b>
A.1	Data naming rules . . . . .	41
A.2	Data formats . . . . .	41
A.2.1	Raw frames . . . . .	41
<b>B</b>	<b>Use of the Data Archiving Unit</b>	<b>45</b>
<b>C</b>	<b>List of acronyms</b>	<b>47</b>

# List of Figures

2.1	Optical layout of the spectrograph . . . . .	4
2.2	Spectral format of HARPS. Blue orders are down, red are up. . . . .	5
2.3	Table showing the spectral format of HARPS and the expected number of electrons for a 1 minute exposure on a G2V star of magnitude 6. A seeing of 0.8", airmass = 1, and new moon are the values of the selected parameters. In the table the spectral bin is defined as one pixel. This table is obtained by the HARPS Exposure Time Calculator (ETC). . . . .	6
2.4	The main components of the HARPS system . . . . .	8
2.5	Quantum efficiency of Jasmin . . . . .	12
2.6	Quantum efficiency of Linda . . . . .	12
6.1	The sky area accessible for HARPS . . . . .	28
6.2	HARPS spectrum in the RTD . . . . .	30
9.1	HARPS - EGGS comparison . . . . .	40
A.1	Raw frame format. . . . .	43

This page was intentionally left blank

# List of Tables

2.1	Level of diffuse + stray light and ghosts as a percent of the flux in the order. . . . .	5
2.2	Characteristic optical data of HARPS . . . . .	7
2.3	Exposure meter count rates . . . . .	10
2.4	Overall efficiency of the HARPS system. See text. . . . .	11
5.1	Fiber illumination scheme for each template. . . . .	22
5.2	Execution times overheads . . . . .	24
5.3	“Off-line” overheads . . . . .	24
9.1	Comparison of the HAM and EGGs performances. . . . .	39

This page was intentionally left blank



# Chapter 1

## Introduction

### 1.1 Scope

This User Manual is intended to give all necessary information to potential users of the HARPS instrument, to help them decide on the opportunity to use the instrument for their scientific applications, to be used as a reference when writing observing proposals and when preparing the observations.

For this purpose we give

- an overall description of the HARPS instrument, its performance and its observing modes;
- information on the preparation of the observations;
- information on the observing process;
- a description of the HARPS data and near real-time pipeline data reduction.

The following documents are closely related to this manual and should be consulted as well:

- the P2PP User Manual
- the HARPS Template Guide

Both are available through the “Information Sources” section of the HARPS web pages

<http://www.ls.eso.org/lasilla/sciops/3p6/harps/>.

### 1.2 Additional information

The latest information updates about the HARPS instrument can be found on the HARPS web pages

<http://www.ls.eso.org/lasilla/sciops/3p6/harps/>.

General information about observing at La Silla is available from the La Silla web pages

<http://www.ls.eso.org/>

### **1.3 Contact information**

In case of specific questions related to visitor mode observations please contact the La Silla High Resolution Spectroscopy Team, likewise for specific questions related to Service Mode observations and proposal preparation:

`ls-hires@eso.org`.

### **1.4 Acknowledgments**

Most of the contents of this manual is based on information from the HARPS Consortium (Observatoire de Genève, Observatoire de Haute Provence, Universität Bern, Service d'Aéronomie, ESO La Silla and Garching), in particular by F. Pepe and D. Queloz, and from La Silla Science Operations (G. Lo Curto and T. Dall). Releases of this documents are based on the original version edited by Gero Rupprecht.

Feedback on this User Manual from users is encouraged. Please email to `ls-harps@eso.org`.

## Chapter 2

# HARPS Characteristics

### 2.1 Instrument Overview

HARPS (High-Accuracy Radial-velocity Planetary Searcher) is an instrument designed for the measurement of Radial Velocities (RV) at highest accuracy. It was built by the HARPS Consortium consisting of Observatoire de Genève, Observatoire de Haute Provence, Physikalisches Institut der Universität Bern, Service d'Aéronomie du CNRS and with substantial contribution from ESO-La Silla and ESO-Garching. Its purpose is to reach a long term radial velocity accuracy of 1 m/s for slowly rotating G-dwarfs. Such precision enables the detection of low mass (Saturn like) extra-solar planets and low amplitude stellar oscillations.

The design of HARPS is based on the experience acquired with ELODIE (installed at the 1.93m telescope at OHP) and CORALIE (at the 1.2m Swiss Euler telescope at La Silla) during the past 10 years by the members of the HARPS Consortium. The basic design of HARPS is therefore very similar to these instruments. The efforts to increase the HARPS performance compared to its predecessors address mainly three issues:

- Increase of the instrumental stability: The spectrograph is installed in an evacuated and temperature-controlled vacuum enclosure. This allows to remove, to a very large extent, all RV drifts which would be produced by temperature variations or changes in ambient air pressure and humidity.
- Increase of the signal-to-noise ratio (SNR) on single RV measurements: The improvement is attained through different steps. First, HARPS is installed on the ESO 3.6-m telescope. Second, the spectral resolution is increased by a factor of about two. The higher spectral resolution helps also to reduce instrumental errors. Third, the spectrograph optics, which is very similar to that of UVES, is very efficient.
- Improvement of the online data reduction: includes better corrections for instrumental effects and zero point definition (wavelength calibration) and it is substantially faster.

HARPS is a fibre-fed, cross-dispersed echelle spectrograph located in the Coude' floor of the 3.6m telescope. For the sake of thermal and mechanical stability the spectrograph is enclosed in a vacuum vessel evacuated to a pressure  $< 10^{-2} mbar$  and maintained to a temperature of  $17^{\circ} C$ , constant within  $0.005^{\circ} C$  RMS. No moving parts are located inside the vacuum vessel (VV). The spectrograph itself has only one possible mechanical configuration. All necessary moving parts are located in the Harps Cassegrain Fibre Adapter (HCFA), with the exception of the shutter, which is located just outside of the vacuum vessel. The optical design, shown in figure 2.1, is similar to UVES at the VLT.

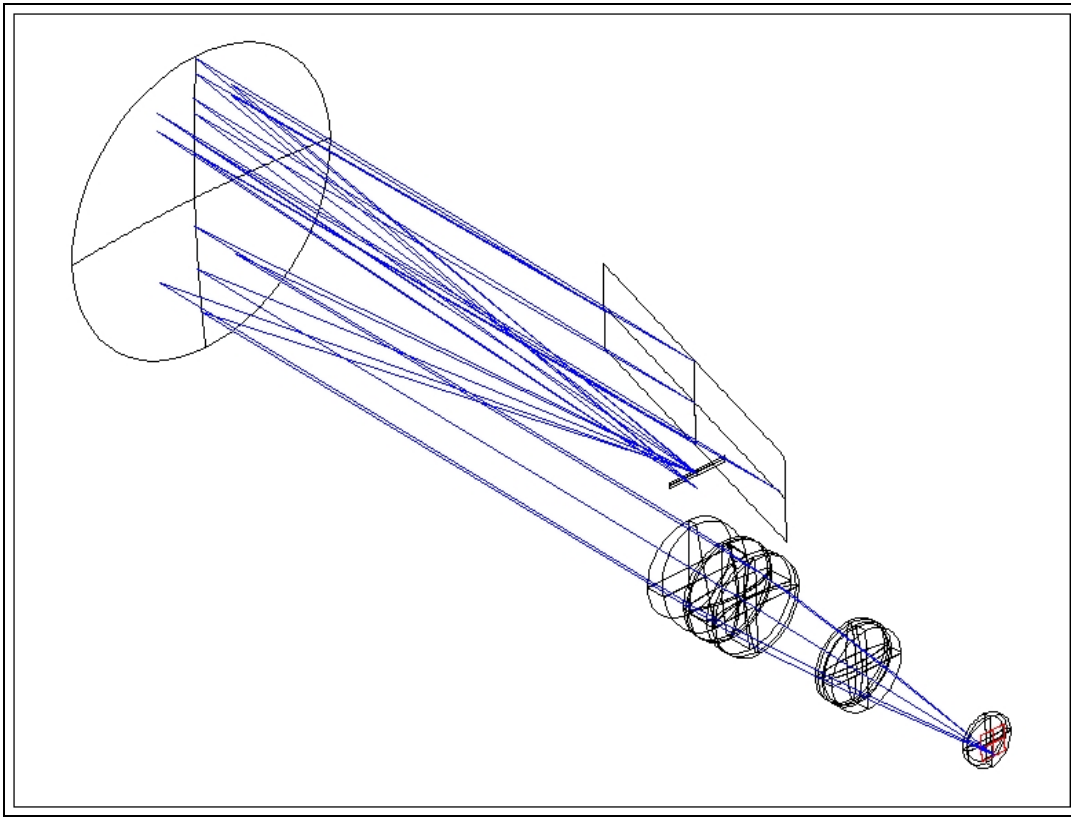

Figure 2.1: Optical layout of the spectrograph

Its echelle grating is operated in quasi-Littrow conditions (off plane angle = 0.721 deg blaze angle) and the collimator in triple pass mode. A white pupil configuration has been adopted with the cross disperser placed at the white pupil. The dioptric camera images the cross-dispersed spectrum on a detector mosaic of two CCDs. Two fibres (A and B) feed the spectrograph, one object fibre and one reference fibre (science fibres). The spectra of the light from both fibres are formed by the spectrograph side by side on the detector.

Although all care has been taken to avoid stray light and ghosts, both are present at some level, most noticeably in the blue part of the spectrum (table 2.1). Ghosts seems to be due to third order reflections in the grism.

The instrument is coupled to the telescope through an adapter: the HARPS Cassegrain Fiber Adapter (HCFA). Two calibration fibers transmit the light from the calibration unit located in the Coude' floor to the HCFA and inject it in the two science fibers for calibration.

The characteristic optical data are given in table 2.2.

The spectral format is shown in Fig. 2.2.

Since the beginning of Period 78 a new mode is offered for HARPS. In the new mode the photon collecting efficiency is increased by a factor up to two (dependent on the seeing) at the expense of Radial Velocity accuracy. The new mode could be useful for faint objects for which a radial velocity accuracy of no better than 30m/s is required. The characteristics of the new mode and its operation are described in section 9.

In the following is presented a brief description of the HARPS components: the fibre adapter on the telescope, the calibration unit, and the fibre links connecting these components. A sophisticated online data reduction pipeline is also part of the system (section 8). The hardware part of the system

Halogen lamp (3000 K)

Order n.	Wavelength (nm)	Diffused + stray light	Ghosts
90	680	0.2%	0.05%
116	527	0.4%	0.5%
160	383	$\approx 1\%$	2%

G3V star (5700 K)

Order n.	Wavelength (nm)	Diffused + stray light	Ghosts
90	680	0.2%	< 0.2%
116	527	0.3%	0.2%
160	383	< 1%	< 4%

Table 2.1: Level of diffuse + stray light and ghosts as a percent of the flux in the order.

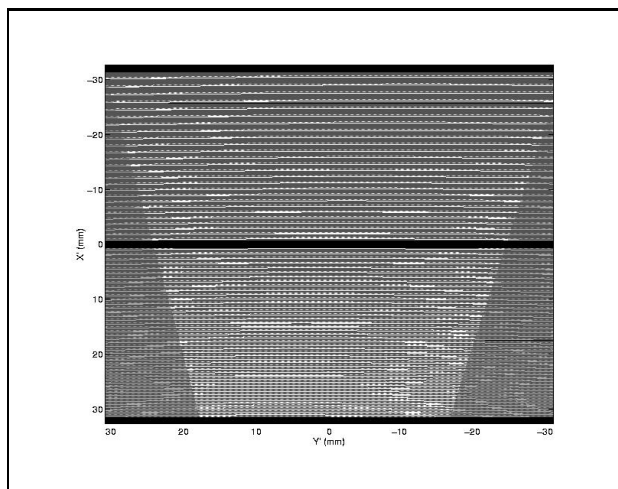

Figure 2.2: Spectral format of HARPS. Blue orders are down, red are up.

is schematically illustrated in Fig. 2.4.

## 2.2 Operations overview

The HARPS instrument is mounted on the Cassegrain focus of the 3.6m telescope in La Silla. It shares the focus with other instruments: EFOSC2 and CES (TIMMI2 retired at the end of period 77). For this reason it is not always attached to the telescope. Since the connection of the CES fibre into the HARPS adapter and the retirement of the TIMMI2 instrument (end of P77), instrument changes at the telescope are needed only when switching between EFOSC2 and HARPS (and viceversa). The instrument change is a lengthy operation that takes a full day and it is scheduled at the beginning of the period, when time allocation for the telescope and the instruments is defined. In contrast, the switch between CES and HARPS requires only the movement of the HCFA fibre carriage and it takes less than one minute. In one night it is possible to use both HARPs and CES with minimum overheads.

Since the beginning of the ESO period 78 a new mode of HARPS is made available to the users: EGGS. Usage of this mode has to be declared in the phase 1 proposal preparation, as it involves installation of the fibres in the HCFA. In this case the CES fibre will be removed and the EGGS fibres installed; instrument or mode changes during the night will be allowed depending on which

Order	Wavelength of central column						
	lambda (nm)	bin size (nm)	Eff. %	Obj e-	Sky e-	Imax e-	S/N per spectral bin
89	687.76	0.0019	3.1	1.42e+04	0.01	5.1e+03	1.2e+02
90	680.12	0.0019	3.2	1.47e+04	0.0103	5.3e+03	1.2e+02
91	672.65	0.0018	3.4	1.53e+04	0.0106	5.6e+03	1.2e+02
92	665.34	0.0018	3.6	1.6e+04	0.0108	5.8e+03	1.3e+02
93	658.19	0.0018	3.7	1.63e+04	0.011	5.9e+03	1.3e+02
94	651.19	0.0018	3.8	1.7e+04	0.0111	6.2e+03	1.3e+02
95	644.34	0.0018	4	1.74e+04	0.0113	6.3e+03	1.3e+02
96	637.63	0.0017	4.1	1.78e+04	0.0114	6.5e+03	1.3e+02
97	631.06	0.0017	4.2	1.76e+04	0.0114	6.4e+03	1.3e+02
98	624.62	0.0017	4.2	1.77e+04	0.0113	6.4e+03	1.3e+02
99	618.31	0.0017	4.3	1.82e+04	0.0112	6.6e+03	1.3e+02
100	612.13	0.0017	4.4	1.82e+04	0.0113	6.6e+03	1.3e+02
101	606.07	0.0017	4.5	1.86e+04	0.0112	6.8e+03	1.4e+02
102	600.13	0.0016	4.5	1.83e+04	0.0111	6.6e+03	1.3e+02
103	594.31	0.0016	4.5	1.85e+04	0.0109	6.7e+03	1.4e+02
104	588.59	0.0016	4.5	1.69e+04	0.0107	6.1e+03	1.3e+02
105	582.99	0.0016	4.6	1.91e+04	0.0108	6.9e+03	1.4e+02
106	577.49	0.0016	4.7	1.91e+04	0.0108	6.9e+03	1.4e+02
107	572.09	0.0016	4.7	1.9e+04	0.0106	6.9e+03	1.4e+02
108	566.80	0.0015	4.7	1.82e+04	0.0104	6.6e+03	1.3e+02
109	561.60	0.0015	4.8	1.78e+04	0.0103	6.5e+03	1.3e+02
110	556.50	0.0015	4.7	1.8e+04	0.0101	6.5e+03	1.3e+02
111	551.48	0.0015	4.7	1.75e+04	0.0098	6.3e+03	1.3e+02
112	546.56	0.0015	4.7	1.73e+04	0.00955	6.3e+03	1.3e+02
113	541.73	0.0015	4.6	1.69e+04	0.00933	6.1e+03	1.3e+02
114	536.97	0.0015	4.6	1.63e+04	0.00909	5.9e+03	1.3e+02

Order	lambda (nm)	bin size (nm)	Eff. %	Obj e-	Sky e-	Imax e-	S/N per spectral bin
116	527.73	0.0014	4.5	1.5e+04	0.0068	5.4e+03	1.2e+02
117	523.22	0.0014	4.4	1.47e+04	0.00664	5.3e+03	1.2e+02
118	518.78	0.0014	4.4	1.34e+04	0.00648	4.9e+03	1.2e+02
119	514.43	0.0014	4.4	1.39e+04	0.00631	5e+03	1.2e+02
120	510.14	0.0014	4.3	1.4e+04	0.00613	5.1e+03	1.2e+02
121	505.92	0.0014	4.3	1.41e+04	0.00595	5.1e+03	1.2e+02
122	501.78	0.0014	4.2	1.29e+04	0.00579	4.7e+03	1.1e+02
123	497.70	0.0014	4.2	1.32e+04	0.00564	4.8e+03	1.1e+02
124	493.69	0.0013	4.1	1.31e+04	0.0055	4.7e+03	1.1e+02
125	489.74	0.0013	4.1	1.31e+04	0.00536	4.7e+03	1.1e+02
126	485.85	0.0013	4	1.09e+04	0.00521	4e+03	1e+02
127	482.03	0.0013	4	1.25e+04	0.00505	4.5e+03	1.1e+02
128	478.26	0.0013	3.9	1.23e+04	0.00492	4.5e+03	1.1e+02
129	474.56	0.0013	4	1.21e+04	0.00488	4.4e+03	1.1e+02
130	470.91	0.0013	4	1.14e+04	0.00486	4.1e+03	1.1e+02
131	467.31	0.0013	4	1.14e+04	0.0048	4.1e+03	1.1e+02
132	463.77	0.0013	4	1.16e+04	0.0047	4.2e+03	1.1e+02
133	460.29	0.0013	4	1.12e+04	0.00458	4.1e+03	1.1e+02
134	456.85	0.0012	3.9	1.12e+04	0.00446	4.1e+03	1.1e+02
135	453.47	0.0012	3.9	9.9e+03	0.00435	3.6e+03	99
136	450.14	0.0012	3.8	1.09e+04	0.00424	4e+03	1e+02
137	446.85	0.0012	3.8	9.75e+03	0.00415	3.5e+03	98
138	443.61	0.0012	3.8	9.58e+03	0.00407	3.5e+03	97
139	440.42	0.0012	3.8	8.72e+03	0.004	3.2e+03	93
140	437.28	0.0012	3.7	8.53e+03	0.0039	3.1e+03	92
141	434.18	0.0012	3.7	7.43e+03	0.00378	2.7e+03	85
142	431.12	0.0012	3.6	6.66e+03	0.00365	2.4e+03	81
143	428.11	0.0012	3.5	6.92e+03	0.0035	2.5e+03	82
144	425.13	0.0012	3.4	6.72e+03	0.00333	2.4e+03	81
145	422.20	0.0012	3.2	6.38e+03	0.00315	2.3e+03	79
146	419.31	0.0011	3.1	6.22e+03	0.00298	2.3e+03	78
147	416.46	0.0011	3	6.23e+03	0.00282	2.3e+03	78
148	413.65	0.0011	2.9	5.82e+03	0.00268	2.1e+03	75
149	410.87	0.0011	2.8	5.11e+03	0.00254	1.9e+03	70
150	408.13	0.0011	2.6	5.17e+03	0.0024	1.9e+03	71
151	405.43	0.0011	2.5	4.62e+03	0.00225	1.7e+03	67
152	402.76	0.0011	2.4	4.41e+03	0.0021	1.6e+03	65
153	400.13	0.0011	2.2	3.94e+03	0.00196	1.4e+03	62
154	397.53	0.0011	2.1	3.02e+03	0.00181	1.1e+03	54
155	394.97	0.0011	2	2.26e+03	0.00166	8.2e+02	46
156	392.44	0.0011	1.8	2.12e+03	0.00152	7.7e+02	45
157	389.94	0.0011	1.7	2e+03	0.00139	7.3e+02	43
158	387.47	0.0011	1.5	1.66e+03	0.00127	6e+02	39
159	385.03	0.001	1.4	1.5e+03	0.00115	5.4e+02	37
160	382.63	0.001	1.3	927	0.00104	3.4e+02	28
161	380.25	0.001	1.2	1.37e+03	0.000938	5e+02	35

Figure 2.3: Table showing the spectral format of HARPS and the expected number of electrons for a 1 minute exposure on a G2V star of magnitude 6. A seeing of 0.8", airmass = 1, and new moon are the values of the selected parameters. In the table the spectral bin is defined as one pixel. This table is obtained by the HARPS Exposure Time Calculator (ETC).

Item	description
System	2 fibres (each 1" diameter on sky, distance 114"), spectral range 380-690nm, collimated beam diameter 208mm
Echelle grating	R4, 31.6 gr/mm blaze angle 75°, mosaic 2×1 on Zerodur monolith 840 × 214 × 125mm, efficiency > 65% in the visible
Cross disperser grism	FK5 grism, 257.17 gr/mm blazed at 480nm, 240 × 230 × 50mm, T=73% (average)
Collimator mirror	Zerodur with protected silver coating, f=1560mm, used diameter 730mm, triple pass
Camera	all dioptric, 6 elements in 3 groups, f=728mm, f/3.3, T>85%
Detector	2 2k × 4k EEV CCDs, pixel size 15 <sup>2</sup> μm <sup>2</sup>
Beam focal ratio	inside the spectrograph: 7.5
Spectral format	“upper, red” CCD (Jasmin): orders 89-114, 533-691nm “lower, blue” CCD (Linda): orders 116-161, 378-530nm
Spectral resolution	RS=115,000 (measured)
Sampling per spectral element	3.4 px per FWHM
Spectrum Separation	17.3 px (fibres A and B)
Order separation Jasmin	order 89: 1.510mm = 100.7px, order 114: 0.940mm = 62.7px
Order separation Linda	order 116: 0.910mm = 60.7px, order 161: 0.513mm = 34.2px
Spectrograph stability	±1 m/s in one night under normal conditions

Table 2.2: Characteristic optical data of HARPS

fibres are mounted in the adapter.

## 2.3 Fibre links

The spectrograph is linked to the 3.6-m telescope via two optical fibres. The fibre link incorporates an image scrambler which is fixed on the vacuum vessel and contributes to stabilize the input point spread function (PSF) of the spectrograph. The scrambler serves also as vacuum feed-through for the fibres and in addition houses the exposure shutter. The shortest useful exposure time supported by the shutter is 0.2 seconds.

A second fibre link connects the Calibration Unit (CU, section 2.4) next to the spectrograph with the HARPS Cassegrain Fibre Adapter (HCFA) on the telescope (see figure 2.1).

## 2.4 Calibration unit

The Calibration Unit (CU) contains a Tungsten flat-field lamp, three Thorium-Argon lamps for spectral calibration, and a tungsten lamp illuminating an iodine cell for tests purposes. It is connected via two optical fibres to the HCFA which redirects the light of the calibration sources into the spectrograph fibres as required. The two calibration fibres can be fed either by the same or independently by two different calibration sources. Of the three Thorium-Argon lamps, the lamp dubbed “THAR1” is the absolute reference, and its use should be minimized. Typically it is used for 5 minutes per day during the afternoon calibrations, shining on “fibre A”. The lamp named “THAR2” is used to measure the instrument drift in parallel with the science observations. “THAR3” is a “hot” spare. The lamp can be switch on at any moment. It is particularly useful when one of the other lamps burns out in the course of the night.

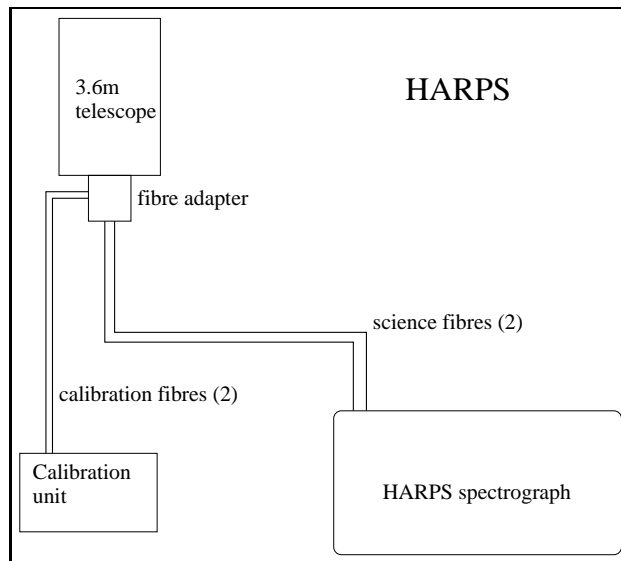

Figure 2.4: The main components of the HARPS system

Table 5.1 illustrates the fiber illumination scheme as a function of the template used.

## 2.5 Fibre adapter

All optical fibres are connected to the HCFA which forms the interface to the telescope. The HCFA provides several functions:

1. Illumination of the object and the reference fibres; each can be separately fed by the object, the sky, light from a calibration source, or it can be dark.
2. Correction of atmospheric dispersion by means of an ADC.
3. Switching between HARPS, and CES (from end 2004 on) fibres.
4. Feeding of the fibre viewer technical CCD camera for guiding.
5. Introduction of the Iodine cell into the object light path.
6. Attenuating the reference light beam from the ThAr lamp via a neutral density wheel to an equivalent exposure time of 40s at zero density. This can be done for exposure times from 40s to 5400s.

## 2.6 Detector and read out electronics

The detector is a mosaic of two  $2k \times 4k$  EEV CCDs. It is mounted in a ESO detector head and cooled to 148K by means of an ESO continuous flow cryostat (CFC). The detector is controlled by the standard ESO CCD controller FIERA. The detector head is mounted on the optical bench while the CFC is fixed on the outer wall of the vacuum vessel. They are linked by a specially developed mechanical interface which is damping the CFC vibration.

Each of the two CCDs has 50 pre-scan and 50 over-scan columns (A.1).



The two CCDs are read by two different amplifiers and a difference of up to 10% in the bias level of the two CCDs might be expected. Following we present the CCD test results as they were obtained on the test bench in Garching, before installation at the telescope.

Property	Jasmin (red)	Linda (blue)
CTE vertical (50 kpx/s)	0.999992	0.9999991
CTE horizontal (50 kpx/s)	0.999991	0.9999990
CTE vertical (416 kpx/s)	0.9999997	0.99999991
CTE horizontal (416 kpx/s)	0.9999995	0.9999990
Non-linearity	not available	$< \pm 0.298\%$
Read out noise (50 kpx/sec)	$2.87 \pm 0.1e^-$	$2.76 \pm 0.09e^-$
Read out noise (416 kpx/sec)	$7.05 \pm 0.23e^-$	$5.5 \pm 0.16e^-$
Conversion factor (50 kpx/sec)	$0.63 \pm 0.02e^-/ADU$	$0.62 \pm 0.02e^-/ADU$
Conversion factor (416 kpx/sec)	$1.42 \pm 0.04e^-/ADU$	$1.4 \pm 0.04e^-/ADU$
Dark current at $-110C$	not measured	not measured
Quantum efficiency	peak 82% at 440nm	peak 85% at 460nm
Cosmetics	science grade (grade 1)	science grade (grade 1)

Readout time (4296x4096 px)	50 kpx/s: 180s, 416 kpx/s: 23 s
Mosaic flatness (peak-to-peak)	$15\mu m$
CCD parallelism	12'
Chip to chip gap	$1215 \pm 45\mu m$

The two CCDs are nicknamed ‘‘Jasmin’’ (the ‘‘red’’ CCD) and ‘‘Linda’’ (the ‘‘blue’’ one). Their quantum efficiencies are given in figures 2.5 and 2.6, respectively.

The read out mode of  $50kpix/s$  has shown to be more noisy than expected when measured at the telescope. This mode has therefore been decommissioned and a new high-gain, low-noise, mode with a readout speed of  $104kpix/s$  has been made available. The characteristics of the two modes available for scientific purposes are spelled out in the following table:

Property	Jasmin (red, # 78)	Linda (blue, # 77)
Read out noise $104kpix/s$ ( $e^-$ )	3.0	2.8
Read out noise $416kpix/s$ ( $e^-$ )	4.5	4.8
Gain $104kpix/s$ ( $ADU/e^-$ )	2.04	2.04
Gain $416kpix/s$ ( $ADU/e^-$ )	0.74	0.76
Bias $104kpix/s$ ( $ADU$ )	198	196
Bias $416kpix/s$ ( $ADU$ )	186	248

The read out time (4296x4096 pixels) is of 87s and 23s for the  $104kpix/s$  and the  $416kpix/s$  modes respectively. The  $104kpix/s$  read out mode, or ‘‘slow’’ mode, is particularly useful when observing faint objects.

## 2.7 Exposure meter

The spectrograph possesses an exposure meter which serves to measure the stellar flux and to accurately measure the mid-time of the exposure (flux weighted mean of the time). The mean time of the exposure delivered by the exposure meter is not used (yet) to correct the RV value.

This exposure meter consists of two photomultipliers (one for each of the two fibres entering the spectrograph from the HCFA) which use the light picked up at the gap between the two sub-gratings

Stellar magnitude	total count rate (cps)	error on mean time of exposure $\epsilon_{MTE}$ (sec)	worst case RV error (m/sec)
$m_v=0$	saturated	<1	0
$m_v=3$	2 850 000	<1	0
$m_v=5$	456 000	<1	0
$m_v=9$	12 000	<4.8	0.1
$m_v=14$	120	<51	1
$m_v=16$	19	<165	2.5
$m_v=17$	8 *	<312	5

Table 2.3: Expected count rate of the exposure meter as a function of stellar magnitude and estimated errors associated with the error on the photometric mean time of the exposure. Count rates are indicative, depend heavily on atmospheric conditions and slightly on stellar spectral type. Calculated.

of the echelle mosaic; no light is lost due to this design. The flux in both photomultipliers can be read at the instrument console. It is also recorded in the FITS header (cumulative, average and center of gravity). The expected count rates as a function of stellar magnitude and the estimated errors in RV are given in table 2.3. The number of dark counts per second fluctuates between 10 and 15.

## 2.8 Data reduction software

A sophisticated Data Reduction Software (DRS) is an integral part of the HARPS system. It allows the complete reduction of all spectra obtained in all three observing modes in near real-time in about 30 seconds.

Once the “trigger” software is started, the start of the pipeline reduction is automatically triggered as soon as a new raw data file appears on the data reduction workstation (`whaldrs`) in the `/data/raw/night` directory (where *night* is the name of the subdirectory named after the day on which the observing night started, e.g. *2004-02-11*).

The output of the pipeline is archived together with the raw data in `/data/reduced/night`. For a description of the reduction performed by the pipeline in the different observing modes see sections 3.1.4, 3.2.4 and 3.3.4. Pipeline execution times are given in section 5.4.1.

For each frame that processes, the pipeline performs basic quality checks. When a problem is encountered an error message is displayed to warn the user.

Calibration frames are also processed by the pipeline. If they pass the quality check then the calibration database is updated. Otherwise an error message will be displayed and the latest entry in the calibration database will be used.

The manual of the DRS can be found online:

<http://www.ls.eso.org/lasilla/sciops/3p6/harps/manuals.html>

## 2.9 System efficiency

The overall efficiency of the HARPS system over the complete wavelength range is given in table 2.4. In this table the atmosphere+telescope transmission is standard atmospheric transmission plus aluminum reflectivity. The “slit efficiency” indicates an average value corresponding to  $z=1$  and is calculated from the HARPS 1" fibre together with the average La Silla seeing of 0.9". The instrument

efficiency includes the fibre link, scrambler and spectrograph (collimator in triple pass, echelle, cross disperser grism and camera). Instrument and CCD efficiencies are measured in the laboratory.

Wavelength	380	400	450	500	550	600	650	690	nm
Tel+atm	44	47	54	57	59	59	61	63	%
“slit”	46	47	48	49	50	50	51	52	%
instrument	10.2	15.7	20.7	22.2	24.2	21.8	19.3	16.4	%
CCD	65	78	85	85	81	79	76	72	%
total	1.35	2.67	4.44	5.18	5.70	5.07	4.58	3.81	%

Table 2.4: Overall efficiency of the HARPS system. See text.

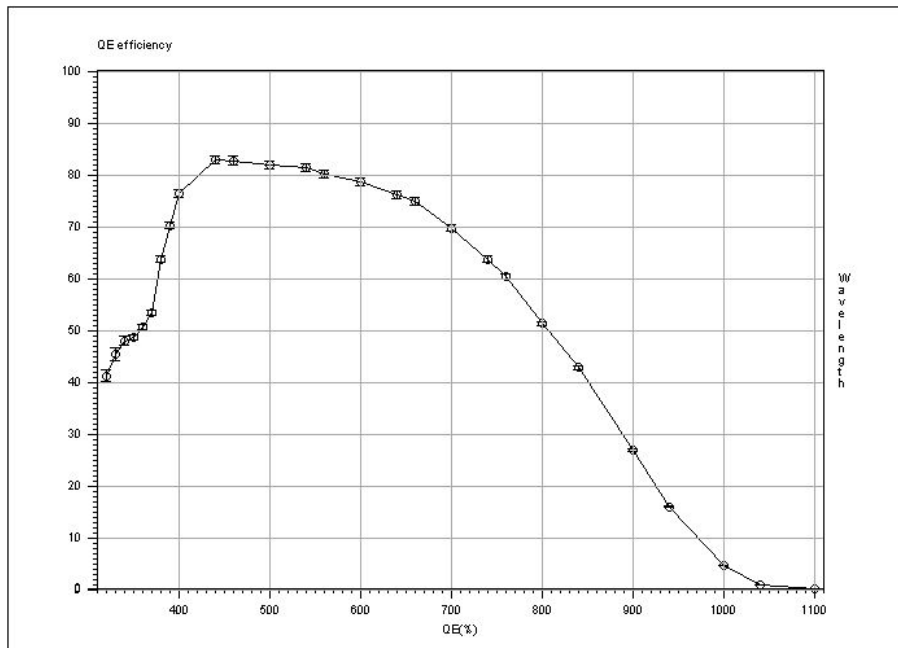

Figure 2.5: Quantum efficiency of Jasmin, the “red” CCD

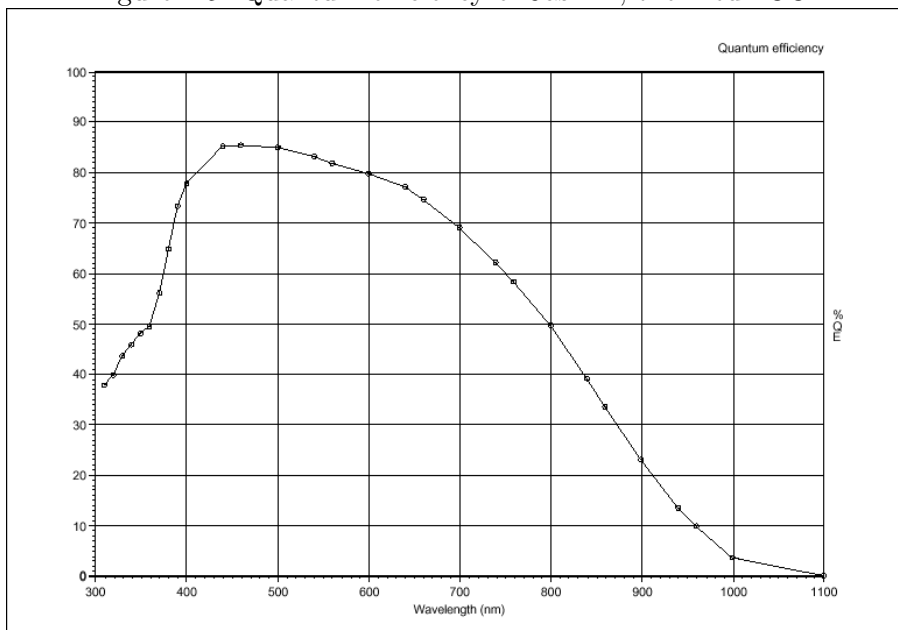

Figure 2.6: Quantum efficiency of Linda, the “blue” CCD

# Chapter 3

## Observing modes

HARPS, both in its high RV accuracy mode and in its high efficiency mode (EGGS), offers the following observing modes:

1. Simultaneous Thorium Reference observation
2. Iodine self-calibration observation (de-commissioned)
3. Classical fibre spectroscopy (with and without sky)

From the point of view operations the EGGS mode is identical to the HARPS one. Only the templates with the “eggs” prefix should be used instead than the templates with the “ech” prefix which are dedicated to the HARPS mode.

### 3.1 Simultaneous Thorium reference method

The Simultaneous Thorium Reference mode is the base-line observation mode to get the best short term accuracy in radial velocity determination from the instrument. In this mode fibre B is fed by the Thorium lamp (located in the calibration unit, see figure 2.4) while fibre A is on the stellar target.

A variable neutral density (ND) filter is used to keep the Thorium spectrum at a flux level equivalent to a 40 seconds exposure with zero density. Since the density to which the ND filter is set is computed by the instrument software from the exposure time as defined in the template, *the exposure time should not be modified from within BOB* (Broker for Observing Blocks). Otherwise the flux levels of both fibres will not be balanced.

The Thorium spectrum which is recorded simultaneously with the stellar spectrum is used to compute the instrument drift from the last wavelength calibration, usually done at the beginning of the night.

The calibration unit contains two identical ThAr lamps. For the simultaneous reference method only the lamp “ThAr2” can be used. The lamp “ThAr1” should be used as a reference only for the afternoon calibrations and switch off afterwards. Ideally this should prolong the life time of this reference lamp.

#### 3.1.1 Performance

For estimates of the SNR in the HARPS mode under given observing conditions the Exposure Time Calculator (ETC) available via the HARPS web page (<http://www.lis.eso.org/lasilla/sciops/harps>)

can be used with an accuracy of about 10% (see section 5.5). The relationship between photon noise induced radial velocity error and S/N is given by the following formula:

$$\text{rms(m/s)} \approx \frac{100}{S/N_{550\text{nm}}}. \quad (3.1)$$

As a rule of thumb, an photon noise error of 1 m/s (or  $S/N = 100$ ) can be achieved for a 6th magnitude G-dwarf in 60 seconds in the HARPS mode. Note, that due to the small fiber aperture on the sky ( $1''$ ), the performances are critically seeing dependent.

In the EGG mode the efficiency increases by up to a factor of 2 with respect to what indicated by the exposure meter with a seeing of  $1.4''$ , but the RV accuracy of this mode is hampered by systematics to  $\approx 30\text{m/s}$ .

### 3.1.2 Calibrations

The Simultaneous Thorium Reference Method needs a sequence of calibration exposures to be taken before the beginning of the night. No further calibration exposures are required during the night.

In order to produce the correct calibration sequence the available observing block “RV Standard Calibration” should be executed *without changes* before the beginning of the night. It includes:

- 1 bias exposure. The CCD bias is very stable, only one bias is therefore needed by the pipeline.  
Template: `HARPS_ech_cal_bias`
- 2 Tungsten lamp exposures where respectively fibre A and fibre B are successively fed by the Tungsten lamp.  
These exposures are used for order location which is done automatically by the pipeline. The processed products are stored in the calibration database if they pass the quality control of the pipeline, and used for the subsequent reduction of the scientific exposures of the following night.  
Template: `HARPS_ech_cal_tun`
- A sequence of 5 Tungsten lamp exposures (defined by `NREP=5`) where both fibres are simultaneously illuminated.  
This sequence is used by the data reduction pipeline for producing a spectral “master flat-field” which will be stored in the local calibration data base if it passes the quality control by the pipeline, and used for the subsequent reduction of the scientific exposures of the following night.  
Template: `HARPS_ech_cal_tunAB`
- 2 (for reasons of redundancy) Thorium exposures in which both fibres are simultaneously fed by light from the Thorium-Argon lamps.  
The ThAr1, long term reference lamp, illuminates fibre A, the ThAr2 lamp inlluminates fibre B. During the night only the ThAr2 lamp will be used as the reference. The ON time of the ThAr1 lamp is minimized in order to keep it as an absolute reference along the years. Each exposure is used to build a wavelength solution. The instrumental drift with respect to the previous calibration frames is measured (expressed in m/s). If accepted by the built-in quality control, the wavelength solution is stored in the local calibration data base and used for the subsequent reduction of the scientific exposures of the following night.  
Template: `HARPS_ech_cal_thoAB`

The user may then repeat a sequence of flat-fields with more than 5 exposures if a SNR higher than 300 is aimed at in later science exposures. As reference, 30 flat field exposures of 2.8s each suffice to reach a SNR  $\geq 1000$  in the science frames taken in the HARPS instrument mode. The “RV Standard

Calibration” acquires 5 flat exposures and reaches a Signal to Noise Ratio (SNR) of about SNR=400 at 450nm, 500 at 550nm and SNR=900 at 650nm.

In case the “RV Standard Calibration” is not taken, the DRS will use the youngest available calibration data. This might introduce offsets, and possibly have a negative effect on the achievable precision.

The pipeline performs quality checks on each frame. In case one of the frames does not pass the quality check, the youngest available calibration data will be used. In this case is however advisable to contact the support astronomer on site, in order to make sure the general health of the instrument is not compromised.

### 3.1.3 Observing templates

The necessary acquisition and observing templates are available:

- HARPS\_ech\_acq\_thosimult for star acquisition and setup of simultaneous Th exposures
- HARPS\_ech\_obs\_all for taking simultaneous Th exposures

When using the EGGs instrument mode the templates with the “eggs” prefix should be used instead than the templates with the “ech” prefix which are dedicated to the HARPS mode.

For a detailed description of the templates see section 5.3 and the HARPS Template Guide.

### 3.1.4 Pipeline, data reduction

The online pipeline does spectrum extraction, wavelength calibration, RV calculation using a template spectrum of (ideally) the same spectral type as the target star. A comprehensive library of stellar spectral templates is being built up. Currently it contains templates of the following spectral type (others are in preparation):

- G2V

The pipeline applies the following corrections: detector bias , dark , flatfield, cosmic ray removal, and rebins the spectrum according to the wavelength calibration obtained in the afternoon or in the closest successful HARPS\_ech\_cal\_thoAB exposures. The drift correction is not done. At present the drift is measured and inserted in the fits header, but is not applied to the RV value. The user can do that if he/she wishes, by simple subtraction.

Radial velocity and Julian date correction are calculated in the solar system barycenter reference (based on the Bretagnon & Francou 1988 VSOP87E planetary theory). Radial velocity computation is automatically done *for all exposure types* when a radial velocity value different from 99999 is provided by the TARG\_RV parameter. Conversely, RV calculation can be turned off by entering “99999”. The RV must be provided with an accuracy better than 1-2 km/s in order to reach the expected performance. For more details about the pipeline (Data Reduction Software, DRS) please, refer to the DRS user manual. For pipeline execution times see section 5.4.1.

## 3.2 Iodine self-calibration method (out of service since May 2004)

HARPS offers the possibility to use an Iodine cell as an alternative to the standard Simultaneous Thorium Reference method. In this mode fibre A is on the target, fibre B on DARK and the Iodine

cell inserted in front of the fibre A entrance to superimpose an Iodine absorption spectrum on the stellar spectrum.

### 3.2.1 Performance

The Iodine cell used in HARPS absorbs about 40% of the continuum from the source. Exposure times supplied by the ETC have to be scaled accordingly. The precision of HARPS using the Iodine self-calibration method is still under investigation.

### 3.2.2 Calibration

A calibration sequence similar to the Simultaneous Thorium Reference method is recommended before the beginning of the night. Moreover the 5 tungsten exposures series should be repeated with and without the Iodine cell. However, a specific sequence of observations is additionally needed during the night to later extract the Iodine information. This sequence includes the observation of a star of spectral type B with and without the Iodine cell whenever a template of the target star is produced. The target star template is produced by observing it without the iodine cell, with a high signal to noise ratio.

### 3.2.3 Observing templates

The necessary acquisition and observing templates are available:

- HARPS\_ech\_acq\_I2cell acquisition and setup for Iodine cell exposures
- HARPS\_ech\_obs\_all for Iodine cell exposures.

When using the EGGS instrument mode the templates with the “eggs” prefix should be used instead than the templates with the “ech” prefix which are dedicated to the HARPS mode.

For a detailed description of the templates see section 5.3 and the HARPS Template Guide.

### 3.2.4 Pipeline, data reduction

In the Iodine self-calibration method the pipeline does spectrum extraction and applies the wavelength calibration, . If TARG\_RV is not set to 99999 a radial velocity is computed using the CCF technique. Conversely, RV calculation can be turned off by entering “99999”. Considering that I2 lines “pollute” the spectra the radial velocity should be considered as an approximate value. For more details about the pipeline (Data Reduction Software, DRS) please, refer to the DRS user manual.

## 3.3 Classical fibre spectroscopy

Classical fibre spectroscopy can be done in two different ways, depending on the target and the goal of the program:

1. fibre A on target and DARK on fibre B (objA observation)
2. fibre A on target and fibre B on the sky (objAB observation)



`objA` observation should be preferred for objects much brighter than the sky/moon background where a careful CCD background correction may be needed. For this type of observation, the pipeline provides only the spectrum of the fibre A and uses fibre B order location to compute the CCD background.

`objAB` observation should be preferred when a sky-background correction may be needed. The data reduction pipeline provides an extracted spectrum for each fibre. The sky correction is left to the user.

The high stability of the instrument makes wavelength drifts very small. If the same calibration sequence than for the simultaneous Thorium reference method is run before the beginning of the night, a global wavelength calibration with an accuracy better than 3 m/s can be expected.

### 3.3.1 Performance

For estimates of the SNR with an accuracy of about 10% under given observing conditions the ETC available via the HARPS web pages (<http://www.ls.eso.org/lasilla/sciops/3p6/harps/>) can be used (see section 5.5).

### 3.3.2 Calibration

A calibration sequence similar to the Simultaneous Thorium Reference method is recommended before the beginning of the night.

### 3.3.3 Templates

The necessary acquisition and observing templates are available:

- `HARPS_ech_acq_objA` acquisition and setup for fibre spectroscopy with the object in fibre A
- `HARPS_ech_acq_objAB` acquisition and setup for fibre spectroscopy with the object in fibre A and sky in fibre B
- `HARPS_ech_obs_all` for fibre spectroscopy exposures

When using the EGGs instrument mode the templates with the “eggs” prefix should be used instead than the templates with the “ech” prefix which are dedicated to the HARPS mode.

For a detailed description of the templates see section 5.3 and the HARPS Template Guide (section 1.1).

### 3.3.4 Pipeline, data reduction

The pipeline performs the same reduction as for the simultaneous Thorium reference method (section 3.1.4 but it does not correct for the instrumental drift (this one not being traced by the Thorium lamp as in the simultaneous Thorium reference method). It does *not* perform sky subtraction. For more details about the pipeline (Data Reduction Software, DRS) please, refer to the DRS user manual.

Pipeline execution times see section 5.4.1.



# Chapter 4

## RV accuracy

The high RV accuracy obtainable with HARPS is a result of an extremely stable and strictly controlled instrument and a data reduction software designed and optimized for the purpose. The pipeline RV determination is optimized for data taken in the simultaneous Thorium reference method, and nothing can be said at the moment about the obtainable RV accuracy with the iodine self calibration method with HARPS. For reference, the iodine cell method could yield a long term (2 years) accuracy of 2.65 m/s with the UVES spectrograph with a S/N of 66 per pixel and a resolving power of 100000 – 120000, similar to the HARPS one of 115000 (M. Kürster et al., A&A 403, 1077, 2003).

**The short term RV accuracy of HARPS with the simultaneous Thorium reference method has been demonstrated, during the three commissioning phases, to be below 1 m/s.**

The RV accuracy can be affected by several factors external to the instrument:

- photon noise
- telescope focus
- centering errors
- Thorium calibration errors

As an example during the second HARPS commissioning (June 2003), a 7 hours series of short exposures on  $\alpha$  Cen B was recorded, yielding a RV rms of 0.52 m/s. Of these, 0.45 m/s are due to the stellar oscillation, 0.17 m/s to photon noise, 0.08 m/s to Thorium calibration errors (drift tracking) and the remaining 0.18 m/s to centering errors, telescope focus errors and any other error source not yet identified.

The following systematic study is from data obtained with the simultaneous Thorium reference method only.

### 4.1 Photon noise

For a G2 star a RV  $rms_{photon} \approx 1$  m/s due to photon noise only is reached with a S/N ratio of about 100 per pixel (at 550nm). The photon noise introduced in the RV measurement scales approximately as:

$$rms(m/s)_{photon} \approx \frac{100}{S/N_{550nm}}. \quad (4.1)$$

## 4.2 Telescope focus

A defocus of the telescope of 30 encoder units introduces a RV offset of 1 m/s. In a typical focus sequence, which can take from 5 to 10 minutes, is reached a precision in the determination of the optimum focus of 5-10 encoder units.

## 4.3 Centering errors

A de-centering of  $0.5''$  introduces a RV offset of 3 m/s. The present guiding and the dynamic centering systems introduce a RV error at most of  $\approx 0.2$  m/s (rms).

## 4.4 Thorium calibration errors

An error of about 0.5 m/s is given to the Thorium calibration (drift tracking and zero point). The zero point error is by far the dominant source.

## 4.5 EGGS RV accuracy

Radial velocity accuracy in the EGGS mode is still under study. Preliminary measurements indicate that systematics could introduce effects as strong as  $30m/s$ .

# Chapter 5

## Preparing the observations

### 5.1 Introduction

HARPS uses the standard ESO way of observing, i.e. pre-prepared Observing Blocks. This chapter describes the philosophy behind this concept, the available tools and the HARPS specific input.

In order to reach the full performance of HARPS with respect to the determination of accurate radial velocities, the following items should be noted:

1. to achieve an accurate solar system barycentric Radial velocity, correction of 1 m/s, the target coordinates must be known to within  $6''$  including proper motion
2. the RV of a star needs to be known to within 1-2 km/s to give the pipeline a reasonable starting point for the RV computation.

From the point of view preparation of the observations the EGGS mode is identical to the HARPS one. Only the templates with the “eggs” prefix should be used instead than the templates with the “ech” prefix which are dedicated to the HARPS mode.

### 5.2 Introducing Observing Blocks

An **Observing Block (OB)** is a logical unit specifying the telescope, instrument and detector parameters and the actions needed to obtain a “single” observation. It is the smallest “schedulable” entity, which means that the execution of an OB is normally not interrupted as soon as the target has been acquired and centered on the fibre. An OB is executed only once; when identical observation sequences are required (e.g. repeated observations using the same instrument setting, but different targets), a series of OBs must be built.

Usually, one OB consists of two separate entities: the acquisition template and the observation template(s). For normal science observations HARPS uses four different acquisition templates (different for the various observing modes) and one common observing template . They are described in section 5.3 and the HARPS Template Guide.

### 5.3 P2PP

P2PP is the standard tool for the building of observing blocks from the instrument specific templates. A comprehensive description including the user manual is available from the ESO web pages at

Template	Fiber A	Fiber B
HARPS_ech_acq_thosimult	star	ThAr lamp 2/3
HARPS_ech_acq_I2cell	Star	Dark
HARPS_ech_acq_objA	Star	Dark
HARPS_ech_acq_objAB	Star	Sky
ech_cal_thoAB	ThAr lamp 1	ThAr lamp 2/3
ech_cal_tun exposure 1	Tungsten	Dark
ech_cal_tun exposure 2	Dark	Tungsten
ech_cal_tunAB	Tungsten	Tungsten
ech_cal_tunAI2	HCFA I2 cell	Dark
ech_cal_tunI2AB	CU I2 cell	CU I2 cell

Table 5.1: Fiber illumination scheme for each template.

<http://www.eso.org/observing/p2pp/>.

Observers using HARPS in Visitor Mode should prepare their OBs in advance using the HARPS Instrument Package, which is automatically downloaded once P2PP is started and the HARPS program is selected from the list of the user's approved programs. OBs prepared at the observer's home institution can be quickly imported (after having ftp'ed them in the proper machine in La Silla) in the P2PP running at the telescope console and be ready for execution. Service Mode observers need to check in their OBs with ESO; see the La Silla web pages (<http://www.ls.eso.org/lasilla/sciops/>) for details.

For a concise description of all HARPS templates and the parameters selectable with P2PP consult the "HARPS Template Guide" (see section 1.1).

In table 5.1 is shown the fibers illumination scheme as a function of the template used.

### 5.3.1 Acquisition templates

HARPS uses the acquisition template to preset the telescope and to set up the instrument configuration for the selected observing mode. The following acquisition templates are available:

- HARPS\_ech\_acq\_thosimult for simultaneous Th exposures
- HARPS\_ech\_acq\_I2cell for I2 cell exposures
- HARPS\_ech\_acq\_objA for fibre spectroscopy (no sky)
- HARPS\_ech\_acq\_objAB for fibre spectroscopy (with sky)

All the acquisition templates require an initial guess of the RV. For optimum RV determination the expected radial velocity of the source should be entered with an accuracy of  $\approx 2km/s$ . In case the RV value is not known the value "-99999" will start an iterative process which will stop once the input and the output RVs differ by less than  $1km/s$ . If RV computation is not desired the RV initial guess should be set to "99999".

A concise description of the acquisition templates is given in the HARPS Template Guide (see section 1.1).

### 5.3.2 Observing template

HARPS uses one single observation template for all observing modes because all instrument setup is done by the acquisition templates:

- HARPS\_ech\_obs\_all for exposures in all observing modes

A concise description of the observation template is given in the HARPS Template Guide.

### 5.3.3 Calibration templates

Several calibration templates are available. However, all calibrations necessary for a proper data reduction with the online pipeline are performed by the ready-to-run calibration OB (named “RV Standard Calibration”). The details of this OB are described in section 3.1.2.

Only if additional calibrations are deemed necessary one needs to use one (or more) of the following templates:

- ech\_cal\_bias for taking bias frames
- ech\_cal\_dark for taking dark frames
- ech\_cal\_thoAB for taking a wavelength calibration through both fibres
- ech\_cal\_tun for taking order location frames through fibres A and B
- ech\_cal\_tunAB for taking spectral flat field exposures simultaneously through fibres A and B
- ech\_cal\_tunAI2 for taking spectral flat field exposures through the iodine cell using fibre A
- ech\_cal\_tunUSER for taking user defined tungsten exposures

If the number of exposures is set different from one in the ech\_cal\_tunAI2, ech\_cal\_tunAB or ech\_cal\_thoAB templates, the pipeline will wait for the last exposure, sum all the exposures and then process the resulting frame. A concise description of the observation template is given in the HARPS Template Guide.

## 5.4 Overheads

### 5.4.1 Execution time overheads

### 5.4.2 “Off-line” overheads

The pipeline overheads are for reference only, observations can proceed without the need for waiting the pipeline results. ThAr lamp and iodine cell pre-heating overhead have to be considered before the start of the afternoon calibrations.

### 5.4.3 Fast time series observations (asteroseismology)

The shortest exposure time possible with the HARPS shutter is 0.2 seconds, while the shortest exposure in simultaneous thorium exposure mode is 15 seconds (minimum exposure time to achieve a 15 cm/sec instrument drift tracking). For each CCD frame there is an overhead (readout, attachment

Item	time
telescope preset incl dome rotation	5 min (upper limit for large, more than 180deg, dome rotation) 2 min (typical for new pointing within a few degrees from the previous position)
Fibre automatic redefinition and centering of object on the fibre, start of guiding	1 min
instrument configuration	<30 s
readout time (incl writing of FITS headers and transfer to IWS)	23s with 416kpx/s readout speed, 87s with 104kpx/s readout speed
minimum time between successive exposures	32 sec (416kpx/s)
switching between ThAr and Iodine modes	5 min
telescope focusing (at the beginning of the night, to be repeated 4-5 times during the night)	10 min
HARPS/EGGS or HARPS/CES instrument change	≈ 1 minute

Table 5.2: Execution times overheads

Item	time
DRS pipeline for <code>thosimul</code> without RV computation	110 sec
DRS pipeline for <code>objA</code> without RV computation	50 sec
DRS pipeline for <code>objAB</code> without RV computation	70 sec
DRS pipeline extra time for each RV calculation	30 sec/spectrum
ThAr lamp pre-heating (once at the beginning of the night)	2 min minimum, 10 min recommended, 15 min maximum
Iodine cell pre-heating (once at the beginning of the night)	2 hours

Table 5.3: “Off-line” overheads

of fits header etc.) of  $\sim 32$  seconds in the fast readout mode (416 kpx/sec). With 15 sec exposure time on sky, 50 seconds cycles have been achieved. The pipeline presently implemented is able to reduce this flood of data in nearly real-time. Reduction of one frame lasts about 24 seconds, the pipeline: no frames will be left behind.

#### 5.4.4 Iodine cell (out of service since May 2004)

The Iodine cell needs to be in a thermally stable state before it can be safely used. This means that it has to be switched on at least two hours before the first exposure through the cell should be done. This constraint holds both for science and for calibration exposures.

Target acquisition with the Iodine cell is done through the cell. This makes that the position of the fibre hole image on the guide camera changes when the iodine cell is inserted in the light path. In addition the focus position of both the auto-guider and the telescope change and have to be re-adjusted. This takes about 5-10 min once during the night. If more changes (cell on / cell off) are required during the night the previously defined optimum values of the guide camera and telescope focus, as well as the fiber position can be re-set very quickly (overhead  $\approx 30$  s).



For a proper reduction of the data taken with the Iodine cell it is necessary to obtain the following spectra:

- target through the iodine cell ( $S/N_{approx}200$ );
- target without iodine cell (“template”,  $S/N \approx 400$ );
- B star with and without the iodine cell ( $S/N \approx 400$ )

The spectra of the B star are only needed when the template spectra is obtained. In this case they must be taken in the same night during which the template spectra are recorded. Sufficient time for obtaining these spectra must be foreseen.

## 5.5 The HARPS Exposure Time and Spectral Format Calculator

The HARPS Exposure Time Calculator (ETC) models the instrument and detector in their different configurations (the EGGS mode is not included yet, but take as a reference a gain of 2 in flux with a seeing of  $1.4''$ ). It can be used to compute the detailed spectral format (wavelength and order number as function of position on the detector) and the expected SNR for the specified target under given atmospheric conditions as a function of exposure time. It is available via the HARPS web pages <http://www.lis.eso.org/lasilla/sciops/3p6/harps/>.



# Chapter 6

## Observing with HARPS

### 6.1 Before the night

Depending on the observing method applied (simultaneous Thorium reference, Iodine self-calibration, classical fibre spectroscopy) different sets of calibration exposures need to be taken before the start of the science observations.

For all three methods it is necessary to take a series of calibration exposures (Bias, Tungsten, Thorium) because they are needed for the pipeline to produce optimum results. A calibration OB (“RV Standard Calibration”) is available at La Silla and ready for execution to take these exposures. Details are described in section 3.1.2. More calibration exposures are necessary during the night when using the Iodine self-calibration method, see section 3.2.2.

### 6.2 During the night

Observations are performed in the standard VLT way, i.e. OBs are selected by the Visiting Astronomer (VA) with P2PP and fetched by the Telescope and Instrument Operator (TIO) into BOB.

#### 6.2.1 Target acquisition, guiding, focusing

Target acquisition is done by the TIO. The object is centered on the entrance of the science fibre and kept there by an automatic dynamic centering algorithm with an accuracy of better than 0.2 pixels (0.05”). This guiding accuracy introduces radial velocity errors of the order of 20 cm/s and is therefore negligible within the accuracy attainable with HARPS. Users with crowded fields, close binaries, faint objects etc., should prepare finding charts. The guide camera can guide on stars of magnitude up to 17.

In the fibre AB spectroscopy mode (object + sky) the observer should verify that the sky fibre is not contaminated by light from other sky objects. This should in the first place be done by checking on the Digital Sky Survey. At the telescope it can be verified by

- offsetting the telescope: the sky fibre entrance is exactly 114” west of the target fibre;
- watching the count rate of the exposure meter (photometer B).

It is important that the telescope is well focused at all times. It is recommended to have a through focus sequence performed using the guiding camera and the exposure meter two to three times per

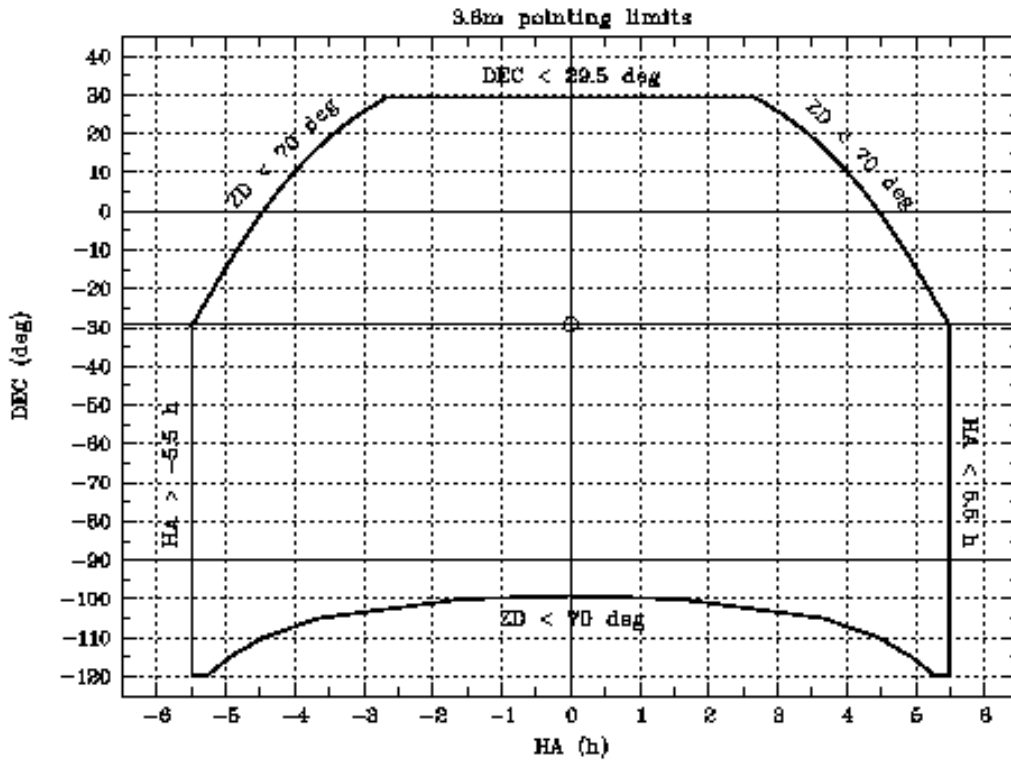

Figure 6.1: The sky area accessible for HARPS

night or whenever the image quality observed on the guiding camera deteriorates significantly, or whenever there is a significant temperature change (few °C). A defocusing of  $\pm 30$  encoder units introduces an RV error of  $\pm 1\text{m/s}$ . The accuracy of the telescope focus determination is within 10 encoder units.

### 6.2.2 Pointing restrictions

The usual pointing limit restrictions of the 3.6m telescope apply, see Fig. 6.1.

The telescope dome shall be closed when any of the following weather conditions occur :

- Wind speed  $> 20$  m/sec (on the 3.6m monitor)
- Humidity  $> 90\%$  (on the 3.6m monitor)
- Temperature within  $2^\circ$  of dew point (on the MeteoMonitor)
- Dew on the dome (the TIO will check the dome in person when there is reason to believe that condensation may occur)

The telescope shall not be pointed into the wind when the wind speed is more than 14 m/sec (3.6m monitor).

Note: Weather conditions at the 3.6m telescope may be significantly different from those near the RITZ. In particular the wind speed is a few meters per second higher and the humidity lower.

The TIO will make the decision to close the dome as necessary. VAs should accept the decision since the reason is exclusively the protection of the telescope from damage. At any rate, in case of a

disagreement the dome should first be closed and subsequently the VA may take up the issue with the support astronomer and finally the La Silla shift leader - though it is highly unlikely that the decision will be altered.

The dome may be re-opened if weather conditions improve and stay below the operating limits for at least 30 minutes. This waiting period is particularly important in case of humidity. The TIO will further confirm that the condensation on the dome has completely evaporated.

### 6.3 Night calibrations

Night calibrations in addition to the calibration observations taken before the start of the science observations are only necessary when using the Iodine self-calibration method, see section 3.2.2.

### 6.4 Real-time display

Raw data coming from the instrument are displayed on a FIERA Real-Time Display (RTD). Both CCDs are displayed in the same RTD (fig. 6.2).

### 6.5 Observing very faint stars

As explained in section 3.1 a variable neutral density filter is used to balance the intensity of the Thorium-Argon calibration spectrum depending on the exposure time. This works correctly for exposure times up to 2700 s.

For very faint stars which require even longer exposures this may lead to an overexposure of the calibration spectrum with contamination of the stellar spectrum. As the ultimate accuracy of HARPS (1 m/s) will usually not be reached on such faint stars, it is recommended not to use the simultaneous Thorium reference method but to rely on the excellent short-term stability of HARPS and take separate wavelength calibration exposures immediately before and after the science exposure to interpolate and remove possible instrumental drift errors. The additional time spent on this is negligible given the long science integration.

### 6.6 Asteroseismology

Asteroseismology observations are particularly demanding from the point of view of data transfer and storage. Users are recommended to use USB disks as a storage media.

Asteroseismology observers need to pay special attention to the guiding parameters. Guiding corrections should be faster if the exposure time is short. For example, if the exposure time is less than 5 seconds, guiding correction time should be no more than 2 seconds; this is also the maximum correction frequency we can use for guiding, due to the telescope reaction time.

The dynamic fibre centering correction time should be set to 10 - 15 minutes (maximum 30 minutes), however a quite long time interval which shall not be the same, nor a fraction of the period of the star's oscillations which are being measured. The rationale behind this choice is to diminish the low frequency noise in the RV power spectrum. The minimum correction time for the dynamic fibre centering algorithm is 30s.

As from June 2004, a periodic signal is detected in the RV power spectrum at 2.8mHz and aliased

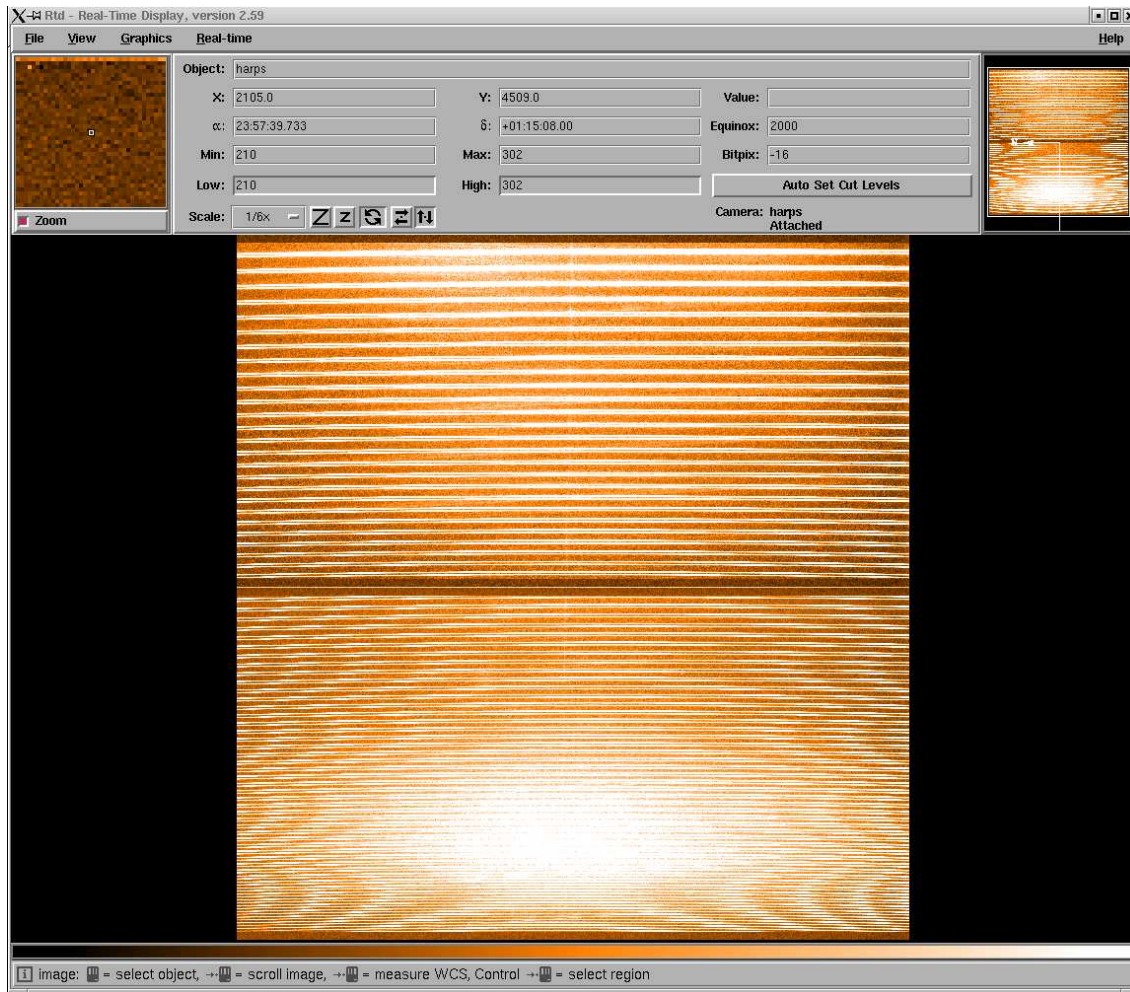

Figure 6.2: The Real Time Display of a HARPS spectrum taken with the tungsten lamp illuminating both fibers. The lower part is the blue chip (“Linda”), the upper one is the red chip (“Jasmin”). Wavelength increases from lower left to upper right.

at about 6 and 9 mHz. This is possibly due to a hard point in the right ascensions main gear or motor and we are trying to fix it. The users however should be aware of it. The amplitude of this signal can reach  $30\text{cm/s}$ . This noise is only noticed in short ( $< 20$  seconds) exposures. When using exposure times larger than  $\approx 20$  seconds the guiding is able to compensate the glitch introduced by the gear/motor.

Observers should ask the operators proper setting of the guiding and dynamic centering parameters.

## 6.7 End of the night

No further calibrations are necessary after the end of the science observations. To prolong the life of the calibration lamps HARPS is switched to the so-called “Dark” mode. All lamps still in use at the time are thereby switched off and the dust cover in the fibre adapter is put in place to protect the fibre entrance. The  $\text{I}_2$  cell will be left on until it is turned off manually. All electronics are in stand-by, all internal house-keeping functions (temperature and pressure control, logging) continue to operate.





# Chapter 7

## Data products and archiving

### 7.1 Data products

HARPS writes FITS files with extensions containing the data of both CCDs. The size of one raw data file is approximately 32Mb.

By default the data products of the online pipeline are archived as well. Following is an example of the files that are included in the archiving of one exposure:

- Raw data file:  
HARPS.2003-11-01T02:40:09.824.fits
- Cross correlation function summary table with extracted RV per each order:  
HARPS.2003-11-01T02:40:09.824\_ccf\_G2\_A.tbl
- Cross correlation function matrix in fits format for mask G2:  
HARPS.2003-11-01T02:40:09.824\_ccf\_G2\_A.fits
- 2D extracted spectrum, one row per order:  
HARPS.2003-11-01T02:40:09.824\_e2ds\_A.fits
- 1D extracted full spectrum, wavelength calibrated, in the solar system barycentric frame:  
HARPS.2003-11-01T02:40:09.824\_s1d\_A.fits
- Bisector from the cross correlation computed with a G2 mask:  
HARPS.2003-11-01T02:40:09.824\_bis\_G2\_A.fits
- Sample of Th lines intensities and FWHM (only for TH calibration frames):  
HARPS.2007-02-11T20:21:01.144\_spot\_thAB.tbl

Other summary tables are produced at the end of each night:

- **cal\_loc\_ONE\_result.tbl**: order localization table;
- **cal\_FF\_result.tbl**: flat field table;
- **cal\_TH\_result.tbl**: Thorium table (for wavelength calibrations);

- **drift\_result.tbl**: Th lines drift in m/s measured on fiber B, filled only in the simultaneous Thorium reference mode;
- **CCF\_results.tbl**: results of the CCF, with measured RV and RV sigma, filled only when the *RADVEL* field in the template is different by 99999.

All files with extension “.tbl” are ASCII files, not MIDAS tables !

For details and format description see the DRS user manual available in:

<http://www.ls.eso.org/lasilla/sciops/3p6/harps/manuals.html>

## 7.2 Data archiving

### 7.2.1 La Silla and Garching archives

HARPS raw data are compliant with the requirements of ESO’s Data Interface Control Board (DICB). They are stored locally at La Silla and in the central Garching Science Archive (however, see 7.2.3). Since the amount of raw data generated by HARPS can be quite substantial (exceeding 20Gb/night in case of asteroseismology ) HARPS will use the Next Generation Archive System (NGAS).

### 7.2.2 La Silla data archiving unit

For convenient archiving of raw observation data and pipeline products a dedicated Data Archiving software (DAU) is available at La Silla. It allows the observers to write the results of their observing runs on DVDs or on their own USB disks, choosing the data product they want (raw data, reduced data or both, log files). Appendix B contains the instructions on how to do this. ESO will make available the necessary blank DVDs for “normal” observing runs (e.g. planet search, classical fibre spectroscopy) to store the raw and reduced data in visitor and service mode.

However, due to the enormous amount of raw data produced during a typical asteroseismology run (>20Gb/night), the backup media will be a user’s USB disk. In case only the pipeline products are requested they can fit in a single DVD, and the standard procedure will be used to back up the data.

### 7.2.3 Use of archived HARPS data

HARPS data can be requested from the Garching Science Archive. Data taken by observers in Visitor or Service Mode are subject to the usual proprietary period of 1 year.

According to the Agreement between ESO and the HARPS Consortium the data taken by the Consortium during their Guaranteed Time are subject to special protection:

- Raw data and reduced spectra ( $I=f(\lambda)$ ) in the Earth reference frame at the time of the observation will be made public one year after observations
- All raw data and radial velocity measurements obtained by the Consortium will be made public one year after the end of the 5 year Guaranteed Time period.

In practice this means that data obtained by the Consortium can be requested from the Garching Science Archive as usual one year after the observations. However, in order to make recovery of precise radial velocities impossible, the keywords containing information about the exact time of the

observations will be filtered from all file headers (raw and reduced) by the Archive during the de-archiving process. This filtering will be applied until one year after the end of the 5 year Guaranteed Time period.



## Chapter 8

# The Reduction of HARPS Data

### 8.1 The HARPS data reduction pipeline

Every HARPS frame is processed by the online pipeline. Depending on the observation, the pipeline uses different reduction recipes. Results of the reduction are:

- extracted spectrum (all modes)
- precise radial velocity (only if parameter TARG\_RV is defined and different from 99999)
- cross correlation function (CCF; only if parameter TARG\_RV is defined and different from 99999).

If the parameter TARG\_RV is defined equal to  $-99999$  the software will compute the radial velocity in an iterative manner. This is useful when the RV of the object is not known a priori with an accuracy of  $\approx 2\text{km/s}$ .

The pipeline output is available immediately after the processing is finished (see section 5.4.1). It can then be transferred to the offline workstation for further analysis. It can also be saved to disk and CD/DVD using the “Data Archiving Unit” (see 7.2.2) available with HARPS. This is typically done next morning by the telescope operator or the Data Handler Administrator. The visitor is not requested to produce a backup of the raw data and of the pipeline products, such a backup will be delivered to the user on the day of departure from La Silla. However results of analysis made outside of the scope of the HARPS pipeline should be back’ed up separately by the visitor.

### 8.2 High accuracy radial velocities

The reduction concept applied by the pipeline for the calculation of high accuracy radial velocities using the Thorium reference method is described in the paper “ELODIE: A spectrograph for accurate radial velocity measurements” by Baranne, Queloz, Mayor et al., A&AS **119**,373(1996).

In order to get the full performance of the pipeline with respect to the determination of accurate radial velocities, the following items should be noted:

1. to achieve an accurate solar system barycentric Radial velocity, correction of 1 m/s, the target coordinates must be known to within  $6''$  including proper motion
2. the RV of a star needs to be known to within 1-2 km/s to give the pipeline a reasonable starting point for the RV computation.

### 8.3 Iodine cell data

On I2 cell data the DRS provides to the user a wavelength calibrated spectrum. For further analysis the observer should consider the following input data:

1. high SNR template spectrum of the science object (without  $I_2$  cell)
2. high SNR spectrum of a B star taken through and without the  $I_2$  cell during the same night as the template spectrum of the science object,
3. Fourier transform spectrum of the Iodine cell. For the HARPS Iodine cell this FTS is available from the HARPS web site (<http://www.lis.eso.org/lasilla/sciops/3p6/harps/>).

The extraction of the I2 information itself is left to the observer.

The description of one method to model the  $I_2$  data is given in the paper: “The planet search program at the ESO Coudé Echelle Spectrometer. I. Data modeling technique and radial velocity precision tests.” Endl M., Kürster M., Els S., 2000, A&A, 362, 585

also available from the web:

<http://aa.springer.de/bibs/0362002/2300585/small.htm>

## Chapter 9

# HARPS high efficiency mode: EGGs

Since October 2006 the high efficiency mode of HARPS, dubbed EGGs, has been made available to the users. This new mode uses a set of fibres with a projected aperture on the sky of 1.4 arcsec and a diameter of  $100\mu m$ , while the standard HARPS fibres, used for optimum radial velocity accuracy, have an aperture of 1 arcsec and a diameter of  $70\mu m$ . The light injection mechanism is via image injection for the High Accuracy Mode (HAM) and pupil injection for the high efficiency mode. Moreover, in order to minimize light losses, the EGGs mode does not use the image scrambler. The EGGs mode gains a factor of 1.75 in flux with respect to the base HARPS mode with a seeing of 0.8 arcsec (see fig. 9).

The best RV accuracy reachable with the EGGs mode is of  $30m/s$ , due both to the different injection mechanism and the absence of the image scrambler.

The ghost contamination is higher in EGGs than in HAM. In particular the reflected order which crosses the detector perpendicularly to the main dispersion direction, has an intensity, in EGGs, ranging from 10% to 1% of the flux of the regular echelle orders, the higher value being in the blue side. The same reflected order in HAM has an intensity generally below 1% of the flux of the regular echelle orders.

The diffuse light at  $590nm$  is about 2.5% for EGGs, to be compared to  $\approx 1\%$  of HAM.

In table 9.1 the HAM and EGGs mode performances are compared.

The EGGs mode may prove particularly useful to RV programs studying faint objects where the RV accuracy is strongly limited by the photon noise.

Users willing to use this mode should declare it in the proposal, as this requires a change in the instrument configuration.

	HAM	EGGS
flux (seeing=0.8")	1	1.75
best RV accuracy	$\leq 1m/s$	$30m/s$
diffuse light at $590nm$	1%	2.5%
strongest ghost intensity	$\leq 1\%$	1% – 10%

Table 9.1: Comparison of the HAM and EGGs performances.

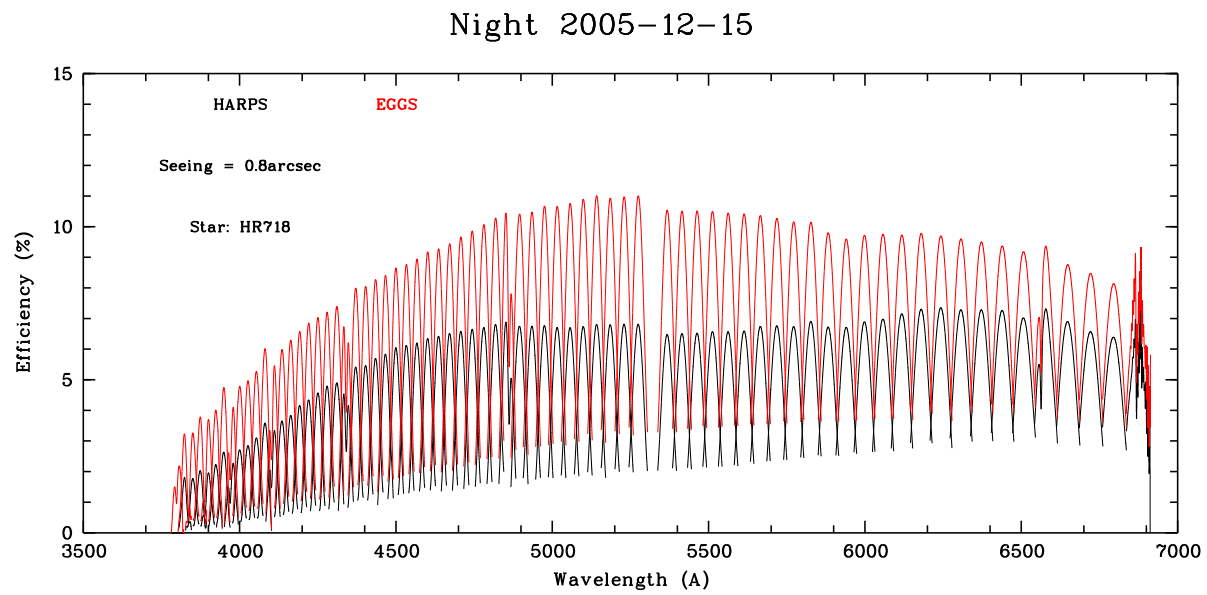

Figure 9.1: HARPS - EGGS comparison



# Appendix A

## Description of archived HARPS data

### A.1 Data naming rules

The raw frames are stored in FITS format by the DFS with the ESO-VLT standard naming rules: `HARPS.YYYY-MM-DDTHH:MM:SS.SSS.fits` with `YYYY-MM-DD` and `HH:MM:SS.SSS` being respectively the date and time of the start of the observation. Raw frames are written in extended fits format, each CCD being on a different plane of the frame. This is effective as of January 1st, 2004.

Pipeline products are stored in FITS format with the same generic names plus an additional suffix describing its format (see next section for details) and the specific fibre name (A or B). For example: `HARPS.YYYY-MM-DDTHH:MM:SS.SSS_E2DS_A.fits` is an E2DS format image of the fibre A product by the DRS derived from the `HARPS.YYYY-MM-DDTHH:MM:SS.SSS.fits` raw frame.

Tables in ASCII format are also produced by the DRS.

The relevant log-books of the DRS is named `DRS-whadrs.YYYY-MM-DD`. It is stored with all the other logs in the `/msg` directory. It is automatically archived by the DAU on the DVD.

### A.2 Data formats

#### A.2.1 Raw frames

The raw frame corresponds to a  $4296 \times 4096$  integer (35'242'560 bytes) matrix written on disk in extended FITS format (see Fig. A.1), each CCD being on a different plane of the frame. This image includes a  $4096 \times 4096$  sensitive zone plus 4 overscan zones of 50 pixels each. The following generic descriptors are used by the DRS:

<b>MJD-OBS</b>	Modified Julian Day start [float]
<b>EXPTIME</b>	Total integration time (s) [float]
<b>DATE-OBS</b>	Date and Time of observation [string]
<b>RA</b>	RA of the target [float]
<b>DEC</b>	DEC of the target [float]
<b>EQUINOX</b>	Equinox of observation [float]

The DRS needs as well the following **HIERARCH ESO** descriptors:

<b>DET1 READ SPEED</b>	CCD Readout mode (speed, port and gain) [string]
<b>DET OUTi GAIN</b>	Conversion from electrons to ADUs of port i [float]
<b>DET OUTi RON</b>	Readout noise of port i (e-) [float]
<b>DET WIN1 DIT1</b>	Actual sub-integration time (s) [float]
<b>DET WIN1 DKTM</b>	Dark current time (s) [float]
<b>DET DPR CATG</b>	Observation category [string]
<b>DET DPR TYPE<sup>1</sup></b>	Observation type [string]
<b>INS DET1 TMMEAN</b>	Normalized mean exposure time on fibre A [float]
<b>INS DET2 TMMEAN</b>	Normalized mean exposure time on fibre B [float]
<b>INS OPTI5 NAME</b>	Lamp name on fibre A [string]
<b>INS OPTI6 NAME</b>	Lamp name on fibre B [string]
<b>OBS NAME</b>	OB Name [string]
<b>OBS START</b>	OB Start Date and time [string]
<b>TPL ID</b>	Template signature ID [string]
<b>OBJECT TYPE<sup>2</sup></b>	What is on fibre A and B [string]
<b>OBJECT SP<sup>2</sup></b>	Object spectral type [string]
<b>OBJECT RV<sup>3</sup></b>	Object expected RV [string]
<b>TEL TARG RADVEL<sup>4</sup></b>	Object expected RV [string]

<sup>1</sup> the use of this keyword made by the DRS is wrong, the keyword shall be later replaced by OBJECT TYPE (not yet implemented by the DICB);

<sup>2</sup> shall replace some of the DPR TYPE current function, not implemented yet in the DICB;

<sup>3</sup> not implemented yet but needed for optimum RV computation;

<sup>4</sup> this keyword shall be later replaced by OBJECT RV

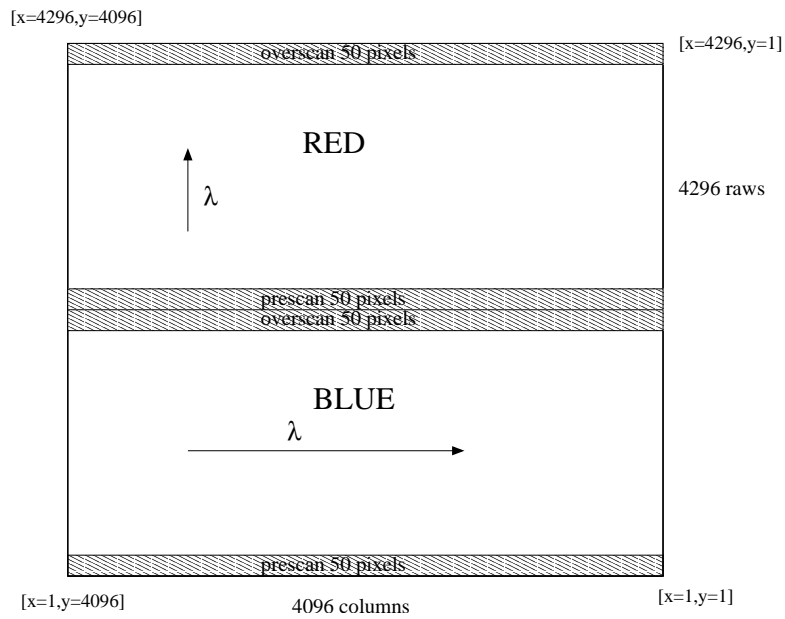

Figure A.1: Raw frame format.



## Appendix B

# Use of the Data Archiving Unit

This appendix describes the use of the Data Archiving Unit (DAU). This unit allows the VA to write his/her data (raw and reduced) to DVD **The disks have to be DVD-R “General”**.

In order to archive the data of one night the following has to be done:

1. launch the Data Archiving Unit on the `warch` machine as `harps` user, the command is: `dau.csh`;
2. put a writable DVD (DVD-R “General”) in the burner;
3. indicate the night date in the “Night” field (the only one which is white); pressing the “Enter” key validates the entered value;
4. wait until all the sizes are calculated (it takes a minute or two);
5. check the check-boxes for the files to be backed up;
6. click the “Go” button to start copying the files (may take up to 30 minutes);
7. de-select all the boxes;
8. press the “Compute size” button to see the total size of the files;
9. select the box “Prepare DVD”;
10. press “Go” to start creating the image (may take 15 minutes);
11. de-select the Prepare DVD box, select the “Make DVD” one;
12. press “Go” to start burning the DVD (may take 45 minutes).

If the total data size is too big for one DVD, the raw files will be automatically compressed (by about 50%; approximately 170 gzipped FITS files fit on one DVD). If the volume is still too large the user has to split the night in two, e.g `< date > _1` and `< date > _2` directories. To archive both directories the complete name of the directory has to be put in the “Night” field. Both directories have to be archived separately. The DAU will automatically search `/data/raw/<dir_name>`, `/data/reduced/<dir_name>` etc.

The “Compute size” button computes the total size of the data saved in the BACKUP under the `< date >` directory once the data are copied in the warch disk.



# Appendix C

## List of acronyms

ADC	Atmospheric Dispersion Compensator
AG	Auto-Guider
BOB	Broker of Observing Blocks
CCD	Charge Coupled Device
CCF	Cross Correlation Function
CES	Coude Echelle Spectrograph
CFC	Continuous Flow Cryostat
CU	Calibration Unit
DAU	Data Archiving Unit
DFS	Data Flow System
DHS	Data Handling System
DICB	Data Interface Control Board
DIMM	Differential Image Motion Monitor
DRS	Data Reduction Software
E2DS	Extracted 2-Dimensional Spectrum
ESO	European Southern Observatory
ETC	Exposure Time Calculator
FIERA	(name for ESO's standard CCD controller)
FITS	Flexible Image Transport System
HCFA	HARPS Cassegrain Fibre Adapter
HARPS	High Accuracy Radial velocity Planet Searcher
ICS	Instrument Control Software
IWS	Instrument WorkStation
ND	Neutral Density
NGAS	Next Generation Archive System
NTT	New Technology Telescope
OB	Observing Block
OG	Observatoire de Geneve
OS	Observation Software
P2PP	Phase 2 Proposal Preparation
PSF	Point Spread Function
RITZ	Remote Integrated Telescope Zentrum
RTD	Real Time Display
RV	Radial Velocity
SA	Support Astronomer
SNR	Signal to Noise Ratio
TBC	To Be Confirmed

TBD	To Be Determined
ThAr	Thorium Argon
TIO	Telescope and Instrument Operator
UVES	Ultraviolet/Visible Echelle Spectrograph
VA	Visiting Astronomer
VLT	Very Large Telescope
XTC	eXtended exposure Time Calculator



--Ω--