

---

# **pagepro 1480MF**

## **User's Guide**

---

# Dear customer

For your security and comfort, we urge you to carefully read the chapter **Security** before attempting use.

In buying this multifunction machine, you have opted for a quality Konica Minolta product. Your device satisfies all of the different needs of a modern office automation tool.

This machine allows you to scan in colour, print and copy in black and white. You can connect the multifunction device to your PC (Microsoft Windows 2000/XP/Vista).

Install the software included to use the multifunction device as a printer. Besides, you can scan, edit and save documents through your PC. If you have a WLAN adaptor (optional) you can communicate with a personal computer wirelessly.

WLAN is an optional working only with a specific adaptor that you can obtain from your retailer.

Thanks to its navigator and its multitask access, it is powerful, user-friendly and easy to use.

The MFP Laser multifunction machines come with a 600 dpi scanner and a black and white laser printer offering a printing speed of 20 ppm. The Companion Suite Pro software provided allows you to use your multifunction machine as a scanner and a printer from a personal computer. It also gives you the ability to manage your multifunction machine.

## ***Consumables***

---

Refer to section **Specifications**, page 49.

# Contents

<b>Dear customer</b>	<b>1</b>	<b>Copy</b>	<b>18</b>
Consumables	1	Simple copy	18
<b>Security</b>	<b>1</b>	ECO mode copy	18
Security directives	1	Advanced copying	18
EMC	1	ID Card Copy mode	18
Note to users in the United States		Special setup for the copying	19
of America	1	Resolution setup	19
Declaration of Conformity	1	Zoom setup	19
EME Compliance for Canada	2	Analysis origin setup	20
Laser Safety Information	2	Contrast setup	20
For Europe/Asia	2	Brightness setup	20
For North America	2	Paper type setup	20
Positions of Safety labels on the machine	3	Paper tray selection	20
Symbols for the main power switch	3	Flat-bed analysis margins setup	20
Regulatory Information	4	Left and right printing margins setup	20
Certifications in Europe	4	Top and bottom printing margins setup	21
		Format paper setup	21
<b>Environment</b>	<b>5</b>	<b>Parameters/Setup</b>	<b>22</b>
The packaging	5	Language	22
Batteries and rechargeable batteries	5	Technical Parameters	22
The product	5	Printing the functions guide	23
		Print the list of setups	23
<b>Software use license</b>	<b>6</b>	Lock the machine	23
Definition	6	Lock the keyboard	23
License	6	Lock the Media service	23
Property	6	Read the counters	23
Duration	6	Scanned pages counter	23
Warranty	6	Printed pages counter	23
Responsibility	6	Display the consumables status	24
Development	6	Calibrate your scanner	24
Applicable law	7	<b>Games</b>	<b>25</b>
Registered trademarks	7	Sudoku	25
Prohibited reproductions	7	Print a grid	25
		Print the solution to a grid	25
<b>Installation</b>	<b>8</b>	<b>Network features</b>	<b>26</b>
Location conditions	8	Type of radio network	26
Cautions of use	8	Radio infrastructure network	26
Safety information	9	Radio ad-hoc network	26
Safety During Operation	9	Radio networks (WLAN)	26
Power Supply	10	Connect your WLAN adaptor	27
Paper recommendations	10	Configure your network	27
Loading paper in the main unit tray	10	Creating or rejoining a network	27
Handling of paper	10	Referring to or changing your network	
Humidity control	10	parameters	28
Handling the unit	10	An example of how an AD-HOC	
Operator shocks	10	network may be set up	29
Moving the unit	10	Setting up a multifunction machine	29
Handling the Toner Cartridge	10	Setting up the PC	30
Rules for use symbols	11	<b>USB memory key</b>	<b>31</b>
Terminal description	12	Use of the USB memory key	31
Command panel	13	Print your documents	31
Accessing terminal menus	13	Print the list of files located in the key	31
Packaging contents	14	Print the files located in the key	31
Device installation	14	Delete your files located in the key	32
Feed cassette paper insertion	14	Analyse the USB memory key content	32
Cartridge installation	15	Save a document on a USB memory key	32
Paper delivery stop	15	<b>PC Features</b>	<b>34</b>
Starting your device	16	Introduction	34
Device connection	16	Configuration requirements	34
Device initial setup	16	Software installation	34
Paper insertion in the manual input tray	16	Installing the full software package	34
Use of envelopes	16	Installing drivers only	36

Installing the drivers using the Companion Suite Pro software	36
Installing the drivers manually	37
Connections	38
Multifunction Terminal's Supervision	39
Checking the connection between the PC and the multifunction machine	39
Companion Director	39
Graphical presentation	39
Utilities and applications activation	39
Companion Monitor	39
Graphical presentation	39
Device management	39
Selecting the current device	39
Status of the connection	40
Device parameters	40
Removing a device	40
Display the consumable status	40
Companion Suite Pro functionalities	41
Document analysis	41
Analysis with Scan To	41
Printing	41
Printing on the multifunction machine	41
Printing in duplex mode with the multifunction machine	42
Software Uninstallation	43
Uninstall the software from your PC	43
Uninstall the drivers from your PC	43
Uninstall the drivers using the Companion Suite Pro software	43
Uninstall the drivers manually	43
<b>Maintenance</b>	<b>45</b>
Service	45
General information	45
Toner cartridge replacement	45
Issues with smart cards	46
Cleaning	46
Scanner reading system cleaning	46
Printer cleaning	46
Printer external cleaning	46
Printer issues	46
Error messages	46
Paper jam	47
PC printing issues	47
PC printing via USB connection	47
PC printing via WLAN connection	48
Firmware update	48
Specifications	49
Physical specifications	49
Electrical specifications	49
Environmental specifications	49
Peripheral specifications	49
Consumable specifications	50

# Security

## Security directives

Before turning on your device, check that the outlet that you are going to plug it into conforms to the indications shown on the information plate (voltage, current, power network frequency) located on your device. This device shall be connected to a single phase power network. The device shall not be installed on bare ground.

Batteries and rechargeable batteries, packaging and electric and electronic equipment (EEE), shall be thrown away, as specified by the Instructions of the ENVIRONMENT chapter of this manual.

Because of the device model, the power connector is the only way to disconnecting the device from the power network, that is why it is imperative to apply the following safety measures: your device shall be connected to a power outlet located nearby. The outlet shall be easily accessible.

Your device is delivered with a grounded power cord. It is imperative to connect a grounded connector to a grounded outlet connected to the building earthing.

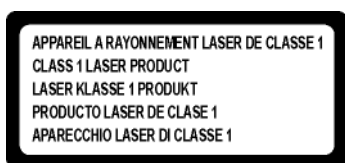

**Repairs-maintenance:** Repairs and maintenance should only be carried out by a qualified technician. No user serviceable parts inside the machine. To reduce the risk of electrical shock, you shall not proceed with these operations yourself, because by opening or removing the lids, you could expose yourself to two hazards:

- The laser beam can cause irreversible eye damage.
- Avoid contact with powered parts because it can lead to electrical shock with unfortunate consequences.

For installation conditions and safe use precautions, refer to chapter **Installation**, page 8.

## EMC

### Note to users in the United States of America

This equipment has been tested and found to comply with the limits for a Class B digital device, pursuant to Part 15 of the FCC Rules. These limits are designed to provide reasonable protection against harmful interference in a residential installation.

This equipment generates, uses and can radiate radio frequency energy and, if not installed and used in accordance with the instructions, may cause harmful interference to radio communications. However, there is no guarantee that interference will not occur in a particular installation.

If this equipment does cause harmful interference to radio or television reception, which can be determined by turning the equipment off and on, the user is encouraged to try to correct the interference by one more of the following measures:

1. Reorient or relocate the receiving antenna.
2. Increase the separation between the equipment and receiver.
3. Connect the equipment into an outlet on a circuit different from that to which the receiver is connected.
4. Consult the dealer or an experienced radio / TV technician for help.

### Declaration of Conformity

This device complies with Part 15 of the FCC Rules. Operation is subject to the following two conditions:

1. This device may not cause harmful interference, and
2. this device must accept any interference received, including interference that may cause undesired operation.

## EME Compliance for Canada

---

This Class "B" digital apparatus complies with Canadian ICES-003.

Cet appareil numérique de la classe "B" est conforme à la norme NMB-003 du Canada.

## Laser Safety Information

---

**CAUTION:** Use of controls, adjustments, or performance of procedures other than those specified in this guide may result in hazardous light exposure.

This equipment complies with international safety standards and is classified as a Class 1 Laser Product.

With specific reference to lasers, the equipment complies with laser product performance standards set by governmental, national, and international agencies as a Class 1 Laser Product. It does not emit hazardous light, as the beam is totally enclosed during all phases of customer operation and maintenance.

## For Europe/Asia

---

This machine complies with IEC 60825-1:1993+A1:1997+A2:2001 standard, is classified as laser class 1 product and is safe for office/EDP use. It contains one class 3B laser diode, 10.72 mW max, 770-795 nm and other class 1 LEDs (280  $\mu$ W at 639 nm).

Direct (or indirect reflected ) eye contact with the laser beam might cause serious eye damage. Safety precautions and interlock mechanisms have been designed to prevent any possible laser beam exposure to the operator.

## For North America

---

CDRH Regulations.

This equipment complies with the FDA performance standards for laser products except for deviations pursuant to Laser Notice No.50, dated 24 June 2007 and contains 1 class 3B laser diode, 10.72 milliwatt, 770-795 nanometer wavelength and other class 1 LEDs (280  $\mu$ W at 639 nm).

This equipment does not emit hazardous light, since the beam is totally enclosed during all customer modes of operation and maintenance.

## Positions of Safety labels on the machine

The device has warning labels at the positions shown below. For your safety, you must never touch these surfaces when you remove a paper jam or when you replace the Toner cartridge.

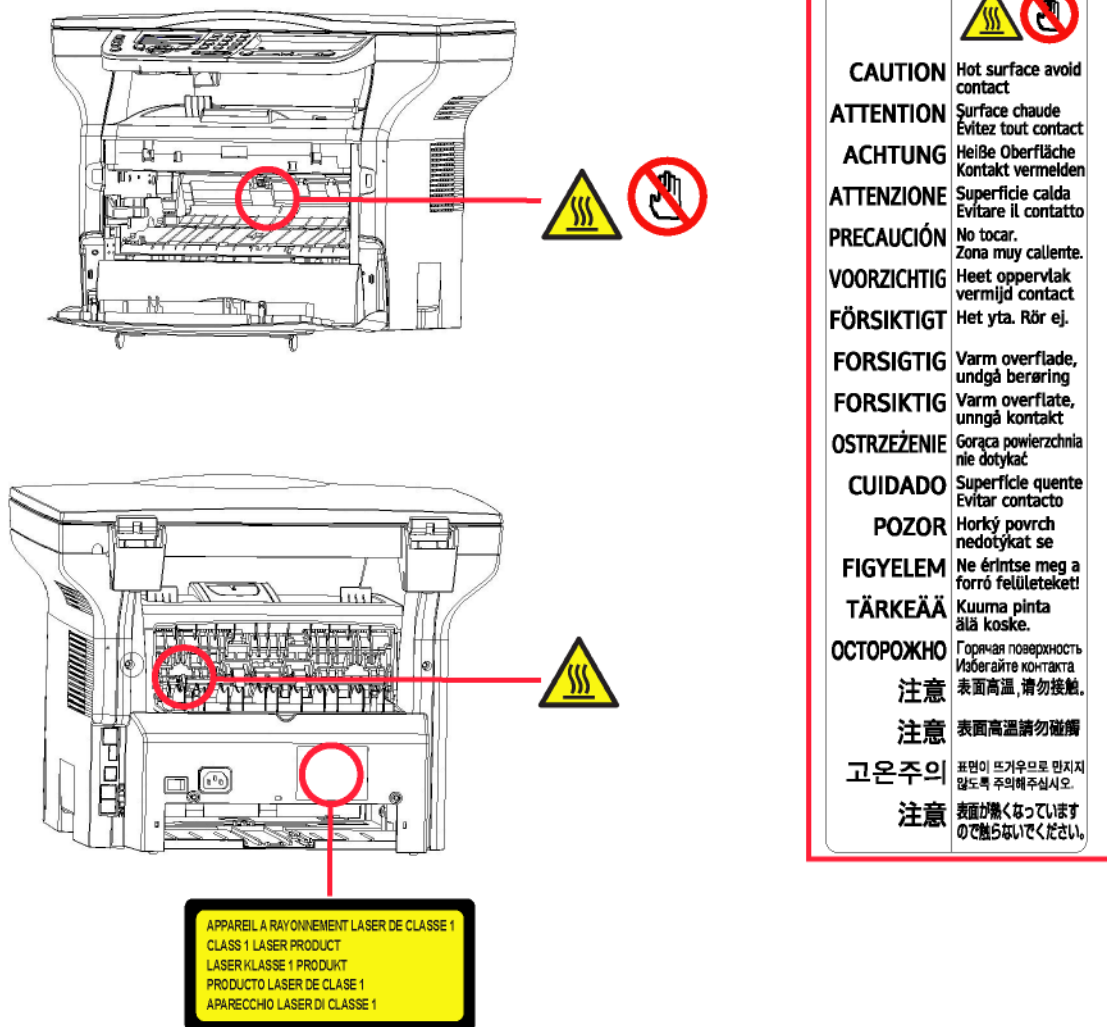

## Symbols for the main power switch

In accordance with IEC 60417, this machine uses the following symbols for the main power switch:

- **I** means POWER ON.
- **O** means POWER OFF.

## Regulatory Information

---

### Certifications in Europe

---

**CE** The CE mark applied to this product, symbolizes declaration of conformity with the following applicable European Union Directives, as of the dates indicated:

**December 12, 2006:** Council Directive 2006/95/EC as amended. Approximation of the laws of the member states related to low voltage equipment.

**December 15, 2004:** Council Directive 2004/108/EC as amended. Approximation of the laws of the member states related to electromagnetic compatibility.

**March 9, 1999:** Council Directive 99/5/EC, on radio equipment and telecommunications terminal equipment and the mutual recognition of the conformity.



# Environment

The preservation of the environment is of importance to the manufacturer. The manufacturer wishes to service the installations with respect to the environment and has chosen to integrate the environmental performance in the whole lifecycle of its products, throughout manufacturing, release, use and disposal.

## The packaging



The (green point) logo indicates that a contribution is given to an approved national organization to improve the packaging salvage and recycling infrastructures.

To make recycling easier, follow local rules and regulations concerning sorting and disposal of such waste.

## Batteries and rechargeable batteries

If your product contains batteries or rechargeable batteries, these shall be disposed of at the designated collecting centers.

## The product



The crossed bin symbol on the product indicates that it belongs to the electric and electronic equipment family.

Therefore, according to European regulations you are requested to dispose of it at the selected collection areas:

- to distribution centers in case of equivalent equipment purchase,
- to the available local collecting centers (dump, selective collection, etc.).

In doing so, you will participate in the "Waste of Electric and Electronic Equipment reuse and development scheme" which will help prevent potential effects on the environment and human health.



*The purpose of the International ENERGY STAR® Program is to promote the development and popularization of energy-efficient office equipment. As an ENERGY STAR® Partner, the manufacturer has determined that this product meets the ENERGY STAR® guidelines for energy efficiency.*

# Software use license

CAREFULLY READ ALL THE TERMS AND CONDITIONS OF THE PRESENT LICENSE BEFORE OPENING THE SEALED ENVELOPE CONTAINING THE SOFTWARE. OPENING THIS ENVELOPE INDICATES THAT YOU ACCEPT THESE TERMS AND CONDITIONS.

In case you should not accept the terms of this license, the DVD-ROM packaging should be returned to the retailer unopened, along with the other components of the product. The purchase price of this product will be refunded. No refunds will be made for products if the DVD-ROM packaging have been opened, if components are missing or if the reimbursement request is made after ten (10) days from the purchase date, your receipt is the proof of purchase.

## Definition

---

The Software designates programs and associated documentation.

## License

---

- This license allows you to use this Software on personal computers on a local network. You only have permission to use this Software to print on one multifunction machine; you can not lend the Software or authorize anyone to use it.
- You are allowed to make a back up copy.
- This license is non-exclusive and non-transferable.

## Property

---

The manufacturer or its providers hold the Software property right. You only become the owner of the DVD-ROM. You shall not modify, adapt, decompile, translate, create any derived piece, rent or sell the Software or the documentation. Any rights not explicitly approved are reserved by the manufacturer or its providers.

## Duration

---

This license remains valid until cancelled. You can cancel it by destroying the program and the documentation as well as any other copies of them. This license will automatically be canceled in case you do not respect the terms of this license. If the license is rendered invalid, you agree to destroy all copies of the program and the associate documentation.

## Warranty

---

The Software is provided "as is" with no warranties what so ever, whether expressed or implied, including without limitation, any warranties of merchantability or fitness for a particular purpose; all the risks concerning the results and performance of this Software are assumed by the buyer. In case the program should appear defective, all the repair and service expenses will be covered by the buyer.

Nevertheless, the license holder benefits from the following warranty: we guarantee that the DVD-ROM on which the Software is recorded is free from hardware or manufacturing faults if used in normal conditions, the guarantee is valid for ninety (90) days from the delivery date, the copy of the receipt being the proof of purchase. In case of a DVD-ROM fault that due to accident or misuse, the DVD-ROM will not be replaced as per the warranty.

## Responsibility

---

If the DVD-ROM is not working properly, send it to the retailer together with a copy of the receipt. It is the retailer's sole responsibility to replace the DVD-ROM. Nobody, not even the manufacturer who is involved in the creation, realization, merchantability and delivery of this program would be responsible for direct, indirect or immaterial damages, such as, but not limited to, loss of information, loss of time, execution loss, loss of revenue, loss of customers, due to the use or inability to use the program.

## Development

---

With a constant concern for improvement, the manufacturer reserves the right to modify the Software specifications without any notice. In case of modification, your user right does not give you access to free updates.

## **Applicable law**

---

This license is under the French law. Any dispute following the interpretation or execution of this license will be submitted to the Paris Court.

Given the continuous technology development, the manufacturer reserves the right to modify the technical specifications indicated for this product, at any time, without prior notice, and/or to stop manufacturing of the product. All the names of the products and brands that could be trademarks registered by their respective owners are recognized in the present document.

## **Registered trademarks**

---

Given the technical evolution, the manufacturer reserves the right to modify the technical specifications of this product and/or to stop its manufacturing at any time and without notice. Companion Suite Pro is a registered trademark of Sagem Communications.

Adobe® and the Adobe® products referred to here are registered trademarks of Adobe Systems Incorporated.

PaperPort11SE is a registered trademark of ScanSoft.

Microsoft® Windows 2000®, Microsoft® Windows Server 2003®, Microsoft® Windows XP®, Microsoft® Windows Vista® and any other Microsoft® product referred to here are registered trademarks of Microsoft Corporation registered and/or used in the United States and/or in other countries.

All the other brands or products referred to as examples or in order to give additional information are registered trademarks of their respective owners.

The informations contents of this user manual are subject to change without notice.

## **Prohibited reproductions**

---

Do not copy or print any item for which reproduction is prohibited by law.

Copying or printing the following items is generally prohibited by local law:

- bank notes;
- checks;
- bonds;
- stock certificates;
- bank drafts;
- passports;
- driver's licenses.

The preceding list is meant as a guide only and is not inclusive. If you have any questions concerning the legality of copying or printing certain items, consult with your legal advisor.

# Installation

## Location conditions

---

By choosing an appropriate location, you preserve the longevity of the machine. Check that the selected location has the following characteristics:

- Choose a well ventilated location.
- Make sure not to obstruct the ventilation grids located on the left and right sides of the device. During the installation, make sure to place the machine thirty centimeters away from the surrounding objects so all the lids can be easily opened.
- Make sure that this location does not present any ammonia nor any other organic gasses emission hazard.
- The ground outlet (refer to the security notices presented in the **Security** chapter) to which you plan to connect the machine must be located close to this one and have an easy access.
- **Make sure that the machine is not directly exposed to sun light.**
- Make sure not to place the machine in an area exposed to an air flow generated by an air conditioning, heating or ventilation system, nor in an area subject to large temperature or humidity variations.
- Choose a solid and horizontal surface on which the machine will not be exposed to intense vibrations.
- **Keep the machine away from any object that could obstruct its ventilation ports.**
- Do not place the machine close to hangings or any other flammable objects.
- Choose a location where splashes of the water and other liquids are limited.
- Make sure that this location is dry, clean and dust free.

## Cautions of use

---

Take into account the important precautions below when using the machine.

### Running environment:

- Temperature: 10 °C to 27 °C [50 °F to 80.6 °F] with an ambient humidity included between 15 to 80% (up to 32°C [89.6 °F] with an ambient humidity included between 15 to 54%).

### Terminal:

The section below describes the precautions to be taken when using the machine:

- Never turn the machine off and never open the lids while printing.
- Never use gas or flammable liquids, or objects generating magnetic field close to the machine.
- When you unplug the power cord, always hold the connector without pulling the cord. A damaged cord presents a potential fire hazard or an electric shock hazard.
- Never touch the power cord with wet hands. You risk getting an electric shock.
- Always unplug the power cord before moving the machine. Otherwise, you could risk having the cord damaged and create a fire hazard or an electric shock hazard.
- Always unplug the power cord when you plan not to use the machine for a long period of time.
- Never put objects on the power cord, never pull it and never fold it. This could cause a fire hazard or an electric shock hazard.
- Always make sure that the machine is not sitting on the power cord or any other electric device communication cables. Make sure also that neither cord nor cable is introduced to the machine inner mechanism. This would expose you to a machine malfunction risk or to a fire hazard.
- Make sure that the printer is unplugged from the power outlet before connecting or disconnecting an interface cable to the printer (use a shielded interface cable).
- Never try to remove any fixed pane or hood. The machine contains high voltage circuits. Any contact with these circuits can cause an electric shock risk.
- Never try to modify the machine. This could cause a fire hazard or an electric shock hazard.
- Always make sure that paper clips, staples or other small metallic items do not get inside the machine via the ventilation ports or other ports. Such items create fire hazards or electric shock hazards.
- Prevent water and any other liquid from spilling on the machine or near to it. Any contact of the machine with water or liquid can cause a fire hazard or an electric shock hazard.

- If liquid or metallic item gets accidentally inside the machine, turn it off immediately, unplug the power cord and contact your retailer. Otherwise, you will face a fire hazard or an electric shock hazard.
- In case of heat, smoke, unusual smell or abnormal noise emissions, turn the machine off, unplug the power cord immediately and contact your retailer. Otherwise, you will face a fire hazard or an electric shock hazard.
- Avoid using the machine during an "electric storm", this can cause an electric shock hazard due to lightning.
- Never move the terminal during printing.
- Always lift the terminal when you wish to move it.





Make sure to place the machine in well ventilated premises. When in operation, the printer generates a small amount of ozone. An unpleasant smell can come from the printer if it is used intensively in poorly ventilated premises. For a secure use, make sure you place the machine in well ventilated premises.

## Safety information

When using your product, the following safety precautions should always be followed.

### Safety During Operation

In this information slip, the following symbols are used:

 <b>WARNING:</b>	Indicates a potentially hazardous situation which, if instructions are not followed, could result in death or serious injury.
 <b>CAUTION:</b>	Indicates a potentially hazardous situation which, if instructions are not followed, may result in minor or moderate injury or damage to property.

#### **WARNING**

- Connect the power cord directly into a wall outlet and never use an extension cord.
- Disconnect the power plug (by pulling the plug, not the cable) if the power cable or plug becomes frayed or otherwise damaged.
- To avoid hazardous electric shock or laser radiation exposure, do not remove any covers or screws other than those specified in the Operating instructions.
- Turn off the power and disconnect the power plug (by pulling the plug, not the cable) if any of the following conditions exists:
  - You spill something into the product.
  - You suspect that your product needs service or repair.
  - Your product's cover has been damaged.
- Do not incinerate spilled toner or used toner. Toner dust might ignite when exposed to an open flame.
- Disposal can take place at our authorised dealer or at appropriate collection sites.
- Dispose of the used toner cartridge (or bottle) in accordance with the local regulation.

#### **CAUTION**

- Protect the product from dampness or wet weather, such as rain, snow, and so on.
- Unplug the power cord from the wall outlet before you move the product. While moving the product, you should take care that the power cord will not be damaged under the product.
- When you disconnect the power plug from the wall outlet, always pull the plug (not the cable).
- Do not allow paper clips, staples, or other small metallic objects to fall inside the product.
- Keep toner (used or unused), toner cartridge (or bottle), ink (used or unused) or ink cartridge out of reach of children.

- Be careful not to cut yourself on any sharp edges when you reach inside the product to remove misfed sheets of paper or masters.
- For environmental reasons, do not dispose of the product or expended supply wastes at household waste collection point. Disposal can take place at our authorised dealer or at appropriate collection sites.
- Our products are engineered to meet the high standards of quality and functionality, and we recommend that you only use the expendable supplies available at an authorised dealer.

---

## **Power Supply**

---

The socket-outlet shall be installed near the product and shall be easily accessible.

---

## **Paper recommendations**

---

---

### **Loading paper in the main unit tray**

---

- Insert paper with the face down, and adjust paper guides to the paper format to avoid feed failure, skewing, and paper jams.
- Amount of loaded paper must not exceed the loading mark. If the loading mark is exceeded, this may cause feed failure, skewing, and paper jams.
- Adding paper in the pile must be avoided because it may cause double feeding.
- When withdrawing the cassette from the main unit, always support it with both hands to avoid dropping it.
- If you use paper already printed by your machine or another printer, the printing quality may not be optimal.

---

### **Handling of paper**

---

- Curling must be corrected before printing.
- Curls must not exceed 10 mm.
- Care must be taken with storage to prevent feed faults and image defects due to leaving the paper in conditions of high humidity.

---

### **Humidity control**

---

- Paper which has become damp, or paper which has been left unused for a very long time, must not be used.
- After opening the paper, it must be kept in a plastic bag.
- Paper with wavy ends, paper which is creased, paper with crumples, and any other non-normal paper must not be used.

---

### **Handling the unit**

---

---

#### **Operator shocks**

---

During printing, shocks must not be applied to the paper feed cassette, tray, cover, and other parts of the machine.

---

#### **Moving the unit**

---

When moving the unit on a desk, it must be lifted, and not dragged.

---

#### **Handling the Toner Cartridge**

---

- Must not be stood on the side, or held upside down.
- Must not be shaken strongly.

## Rules for use symbols

---

### **WARNING**

Indicates important safety notes.

Ignoring these notes could result in serious injury or death. Be sure to read these notes. They can be found in the Safety information section of this manual.

### **CAUTION**

Indicates important safety notes.

Ignoring these notes could result in moderate or minor injury, or damage to the machine or to property. Be sure to read these notes. They can be found in the Safety information section of this manual.

### **Important**

Indicates points to pay attention to when using the machine, and explanations of likely causes of paper misfeeds, damage to originals, or loss of data. Be sure to read these explanations.

### **Note**

Indicates supplementary explanations of the machine's functions, and instructions on resolving user errors.

**Terminal description**

**Front and Back sides**

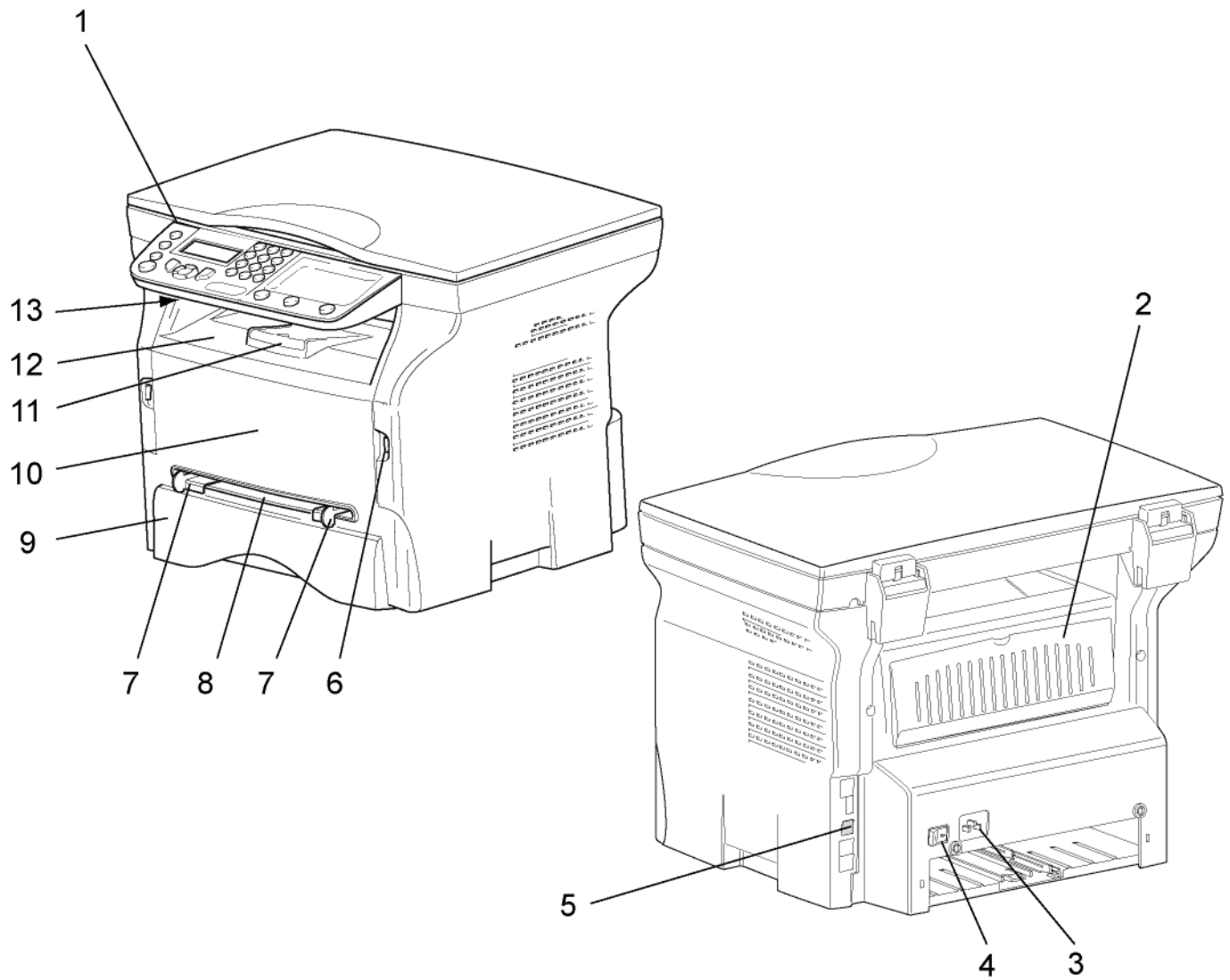







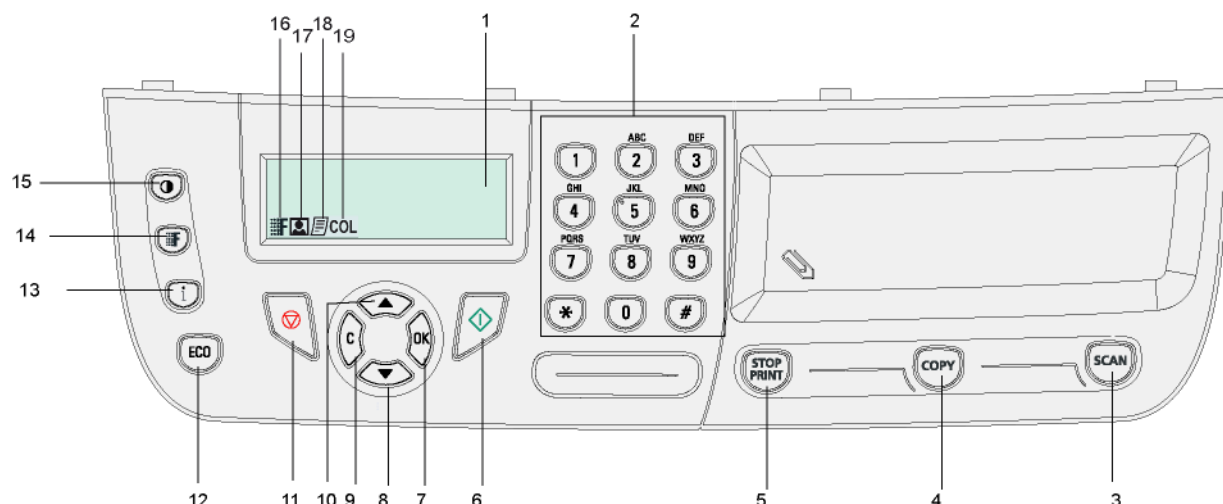

- |                                    |  |
|------------------------------------|--|
| 1. Control panel                   | 8. Manual input tray                     |
| 2. Paper jam cover                 | 9. Paper tray                            |
| 3. Power supply cord connection    | 10. Cartridge access cover               |
| 4. On/Off switch                   | 11. Fold-down stopper for paper delivery |
| 5. Slave USB connection (for PC)   | 12. Paper output                         |
| 6. Master USB connection (USB key) | 13. Smart card insertion point           |
| 7. Manual paper feed setup guides  |  |



## Command panel



1. Screen.
2. Digital keypad.
3. Key **SCAN**: document analysis to the PC or a media (USB key).
4. Key **COPY**: local copy.
5. Key **STOP PRINT**: stops the current PC print job.
6. Key : Validation.
7. Key **OK**: confirms the displayed selection.
8. Key **▼**: menu access and navigation down the menus.
9. Key **C**: back to the previous menu and input correction.
10. Key **▲**: navigation up the menus.
11. Key : stops the current operation.
12. Key **ECO**: sets up the activation delay and toner save in copy mode.
13. Key : access to print menu (print functions list, machine settings, etc.).
14. Key : analysis resolution setup.
15. Key : contrast setup.
16. Icon : resolution "Quality Text".
17. Icon : resolution "Photo".
18. Icon : resolution "Text".
19. Icon **COL**: colour mode.

## Accessing terminal menus

All terminal functions and settings are available via the menu and are associated to a specific menu command. For example, the menu command 51 launches the printing of the functions list (the functions list stores the list of all terminal menus, sub-menus and their identification number).

Two methods are available to access menu items: the step by step method or the shortcut method.

To print the functions list with the Step by step method:

- 1 Press **▼**.
- 2 Use the **▼** or **▲** button to browse the menu and select **5 - PRINT**. Confirm with **OK**.
- 3 Use the **▼** or **▲** button to browse the menu **PRINT** and select **51-FUNCTIONS LIST**. Confirm with **OK**.

To print the functions list with the shortcut method:

- 1 Press **▼**.
- 2 Enter 51 with the numerical keypad to directly print the functions list.

## Packaging contents

The packaging contains the items listed below:

### Multifunction device

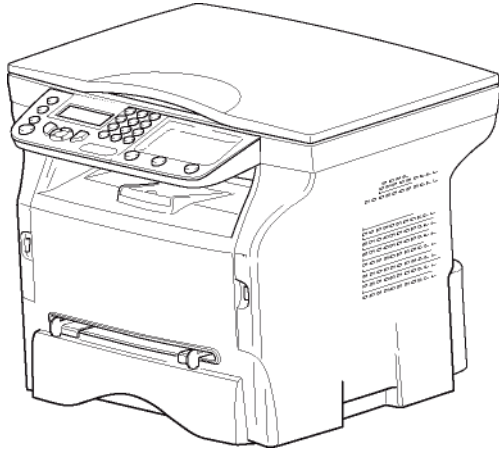

### 1 toner cartridge

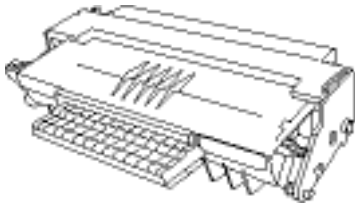

### 1 Installation guide



### 1 DVD-ROM



### 1 power cord



## Device installation

- 1 Unpack the device.
- 2 Install the device respecting the security notices stated at the beginning of this booklet.
- 3 Remove all stickers from the machine.
- 4 Remove the plastic protection film from the screen.

## Feed cassette paper insertion



**Important**

Before inserting paper, refer to the paragraph **Paper recommendations**, page 10.

Your device accepts a number of formats and types of papers (refer to the paragraph **Specifications**, page 49).



**Important**

You can use paper weighing between **60 and 105 g/m<sup>2</sup>**.

- 1 Remove the paper feed cassette completely.

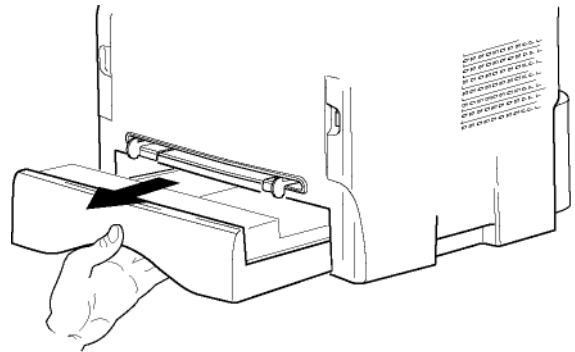

- 2 Push the lower panel down until it clicks.

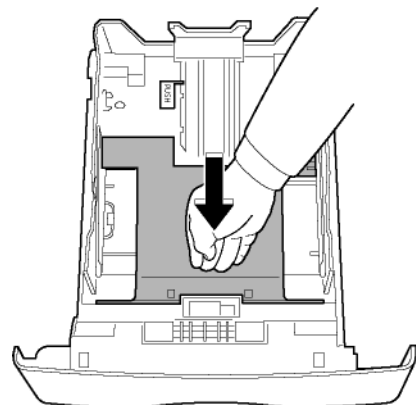

- 3 Setup the back side feed cassette stop by pushing the "PUSH" lever (A). Then adjust the lateral paper guides to the paper format by pushing lever (B) located on the left guide. Adjust the length paper guide to the paper format by pushing lever (C).

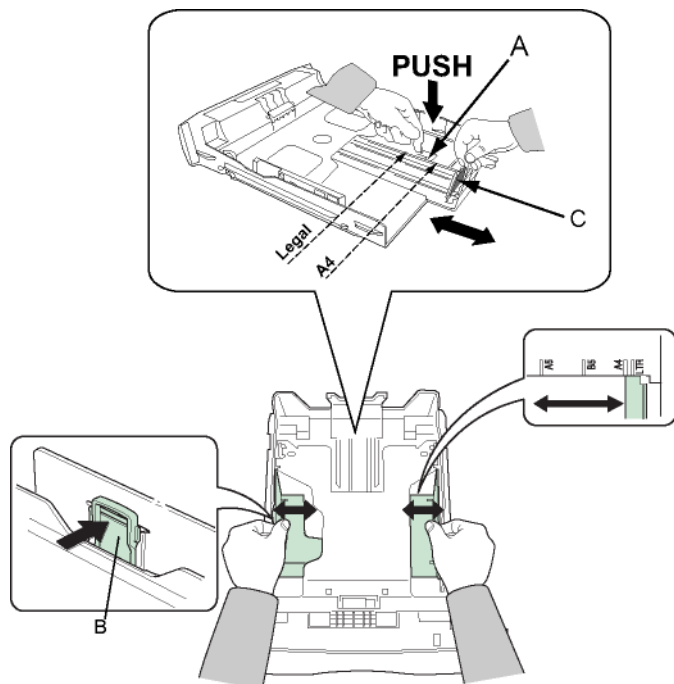

- 4 Take a paper stack, pull the paper off and align it on a flat surface.

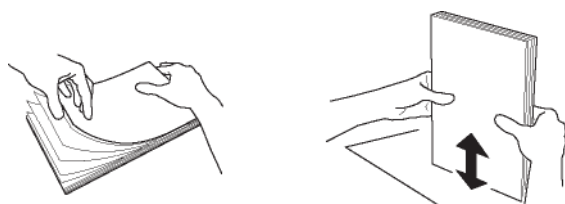

- 5 Put the paper stack in the feed cassette (200 sheets of 80 g/m<sup>2</sup> paper for instance).  
6 Put the feed cassette back in its location.

assure the maximum copies per cartridge. Hold it by its handle.

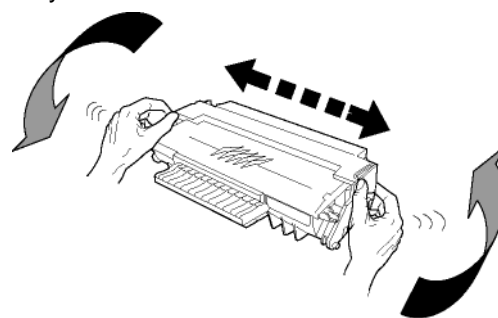

- 4 Insert the cartridge in its slot by pushing it until it clicks (last move down) as shown on the picture below.

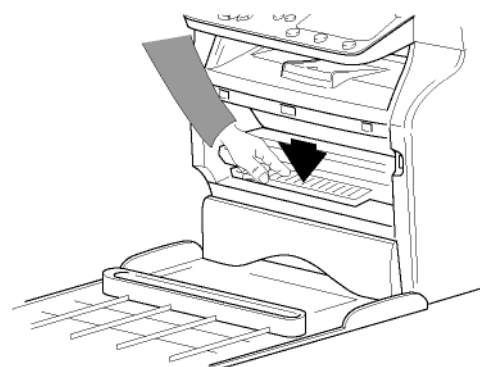
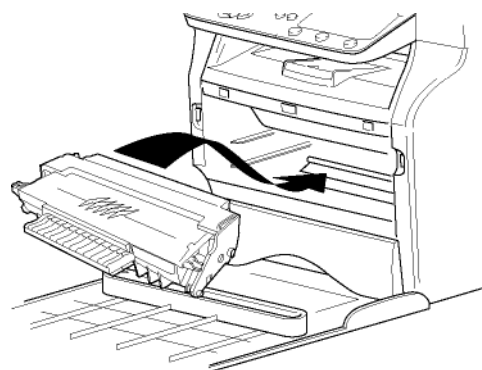

- 5 Close the cover.

### Cartridge installation

- 1 Stand in front of the machine.  
2 Push the left and right sides of the cover and pull it towards you at the same time.

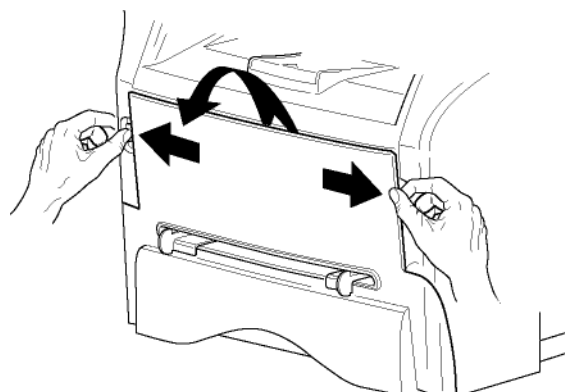

- 3 Unpack the new cartridge. Gently roll the cartridge 5 or 6 times to distribute the toner evenly inside the cartridge. Thoroughly rolling the cartridge will

### Paper delivery stop

Adjust the paper delivery stop, depending on the format of the document to be printed. Do not forget to raise the flap to prevent the sheets from falling down.

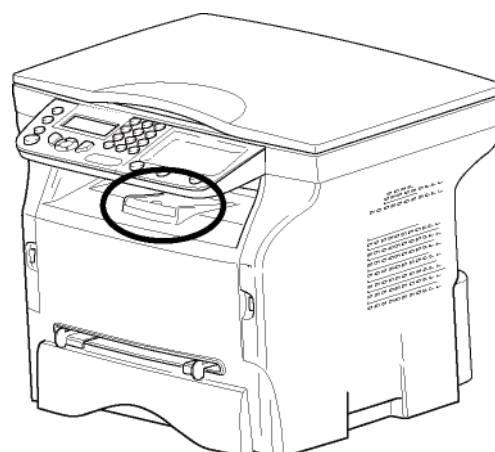

## Starting your device

### Device connection



#### WARNING

Before plugging the power cord, it is imperative to refer to the **Security directives**, page 1.

- 1 Make sure that the On/Off switch is on Off (O position).
- 2 Connect the power cord to the device. Plug the power cord to outlet on the wall.

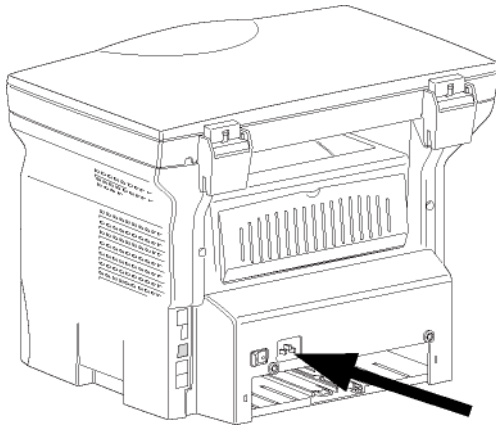

#### WARNING

The power cord is used as a power unit cut off. As a precaution, the outlet shall be located close to the device and be of easy access in case of danger.

- 3 Press the On/Off button to turn on the device (I position).

### Device initial setup

After a few seconds, when the machine has warmed up, the **Easy Install** function is launched and the LCD screen displays the following message:



1 - FRANCAIS  
2 - ENGLISH

The **Easy Install** function will help you configure your machine by guiding you through the basic settings.

If you wish to modify the setting displayed, press the **OK** button. If you do not want to modify the displayed setting, press the **C** button: the **Easy Install** function then displays the next basic setting.



#### Note

If you do not want to carry out the initial setup, press the  button. A confirmation message appears. Press the  button again to confirm. To manually modify and customise the machine settings, refer to **Parameters/Setup**, page 22.

- 1 Select the desired language using the **▲** or **▼** buttons and confirm with **OK**.

The setup is now complete and the functions list is automatically printed out.

The LCD screen displays the message **PAPER EMPTY** if no paper has been loaded in the paper tray (see **Loading paper in the main unit tray**, page 10). Once paper has been loaded, printing will resume.

### Paper insertion in the manual input tray



#### Important

Before inserting paper, refer to the paragraph **Paper recommendations**, page 10.

The manual input tray allows you to use various paper formats with greater grammage than the one used in the paper feed cassette (refer to the paragraph **Specifications**, page 49).

Only one sheet or envelope can be fed at a time.



#### Important

You can use paper weighing between **52 and 160 g/m<sup>2</sup>**.

- 1 Spread the manual feed guides to the maximum.

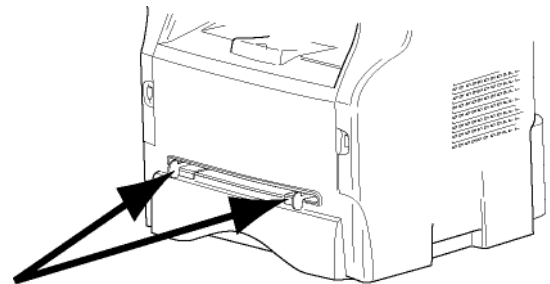

- 2 Insert a sheet or an envelope in the manual input tray.
- 3 Adjust the paper guides against the right and left edges of the sheet or the envelope.
- 4 Print making sure that the chosen paper format corresponds to the selected format on the printer (refer to **Copy**, page 18).

### Use of envelopes

- Feeding can be done only through the manual feed.
- Recommended area should be the area which excludes 15 mm from the leading edge, 10 mm from both the left and right edges, and the rear edge.
- A few lines may be given in solid print at the part of being overlapped.
- Envelopes which are not recommended may lead to improper printing (refer to the paragraph **Specifications**, page 49).
- Curled envelope after printing should be fixed manually.
- Small crumples on the edge of the wide side of envelopes, smearing, or less clear printing may

appear on the reverse side.

- Set envelope by pressing the folding line of four edges properly after releasing air inside.
- Set envelope in a proper position after aligning in case it is bent or warped.
- Paper conditioning is not allowed. And it should be used under normal office environment.

# Copy

Your machine has the function to make one or more copies.

You can also set up several parameters in order to make copies at your will.

## Simple copy



In this case, the default parameters are applied.

- 1 Place the document to be copied face down on the glass, respecting the indications around the glass.
- 2 Press the  button twice. The copy is made using the default parameters.

## ECO mode copy

The ECO mode enables you to reduce the amount of toner consumed on the page so as to save your printing costs.

When the ECO mode is used, the toner consumption is reduced and the print density becomes lighter.

- 1 Place the document to be copied face down on the glass, respecting the indications around the glass.
- 2 Press the  button.
- 3 Press the  button.

## Advanced copying

The sophisticated copy allows to do custom setups for the current copy.



You can start copy by pressing the  button at any time in below steps.

- 1 Place the document to be copied face down on the glass, respecting the indications around the glass.



After step 1, you can directly enter the number of copies with the numerical keypad and press the **OK** button to validate. Then refer to step 4.

- 2 Press the  button.
- 3 Enter the number of copies that you want and confirm with the **OK** button.
- 4 Choose the paper tray **AUTOMATIC** or **MANUAL** with the buttons  $\blacktriangle$  or  $\blacktriangledown$ , then confirm with the **OK** button.

- 5 Choose with the buttons  $\blacktriangle$  or  $\blacktriangledown$  the printing option (see examples below) depending on the copy mode that you want: **1 Page to 1**, **1 Page to 4** or **1 page to 9**.

### POSTER Copy mode

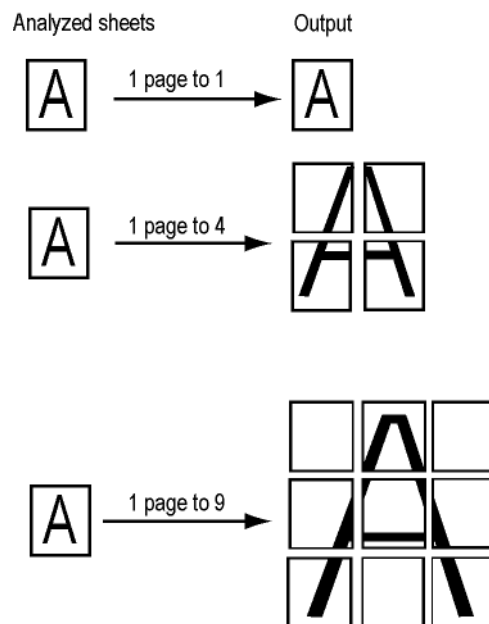

Confirm with the **OK** button.

- 6 Adjust the desired zoom level, from **25% TO 400%** with the buttons  $\blacktriangle$  or  $\blacktriangledown$ , confirm with the **OK** button (only available in **1 Page to 1** copy mode).
- 7 Adjust the desired origin values with the digital keyboard buttons  $\blacktriangle$  or  $\blacktriangledown$  then confirm with the **OK** button.
- 8 Choose the resolution depending on the printing quality that you want **AUTO**, **TEXT**, **QUALITY TEXT** or **PHOTO** with the buttons  $\blacktriangle$  or  $\blacktriangledown$ , then confirm with the **OK** button.
- 9 Adjust the contrast level with the buttons  $\blacktriangle$  or  $\blacktriangledown$ , then confirm with the **OK** button.
- 10 Adjust the desired brightness level with the buttons  $\blacktriangle$  or  $\blacktriangledown$ , then confirm with the **OK** button.
- 11 Choose the paper type **NORMAL**, **THICK** with the buttons  $\blacktriangle$  or  $\blacktriangledown$ , then confirm with the **OK** button.

## ID Card Copy mode

The ID CARD copy function is used for copying both sides of an identity card or driver's license type document on an A4 format sheet (original document size < A5) or on a Letter format sheet (original document size < Statement).

The LCD screen displays useful operating instructions (when the original document should be placed, when the document should be turned over, etc.) and asks for your confirmation to proceed with the operation.



**Important** Zoom and Origin adjustments are not available in this copy mode.

- 1 Press the  button.

- 2 Enter the desired number of copies and confirm with the **OK** button.
- 3 Choose the paper tray **AUTOMATIC** or **MANUAL** with the buttons **▲** or **▼**, then confirm with the **OK** button.

### ! Important

*Copying in ID Card mode is only possible on A4 (original document size < A5) or Letter (original document size < Statement) paper size. Make sure that the selected paper tray uses the correct paper size.*

- 4 Choose the copying option **ID CARD** with the buttons **▲** or **▼** and confirm with the **OK** button.
- 5 Choose the resolution depending on the desired printing quality **AUTO**, **TEXT**, **QUALITY TEXT** or **PHOTO** with the buttons **▲** or **▼**, then confirm with the **OK** button. For optimal results with ID documents, select the **PHOTO** resolution.
- 6 Adjust the contrast level with the buttons **▲** or **▼**, then confirm with the **OK** button.
- 7 Adjust the desired brightness level with the buttons **▲** or **▼**, then confirm with the **OK** button.
- 8 Choose the paper type **NORMAL**, **THICK** with the buttons **▲** or **▼**, then confirm with the **OK** button. The LCD screen displays the following message:

**PUT ID CARD  
THEN OK**

- 9 Place your identity card or any other official document against the glass of the flatbed scanner, as shown below:

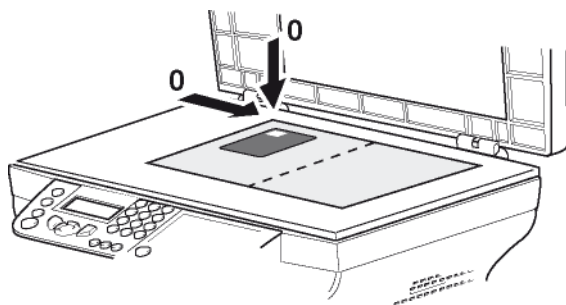

- 10 Press the **OK** button. The document is scanned then the LCD screen displays the following message:

**TURN UP DOC  
THEN OK**

- 11 Turn your document over then confirm with the **OK** button.

The machine prints out a copy of your document.

## Special setup for the copying

Setups done through this menu become the device **default setups** after you confirm.

### ! Important

*When the quality of the printing is not satisfying, you can proceed to a calibration (see **Calibrate your scanner**, page 24).*

## Resolution setup

The **RESOLUTION** parameter allows you to setup the photocopy resolution.

### ▼ 841 - ADVANCED FCT/COPY/RESOLUTION

- 1 Press **▼**, enter **841** using the keypad.
- 2 Choose the resolution with the buttons **▲** or **▼** according to the following table:

Parameter	Signification	Icon
<b>AUTO</b>	Low resolution.	none
<b>TEXT</b>	Standard resolution for documents containing text and graphics.	
<b>QUALITY TEXT</b>	Optimal resolution for documents containing text.	
<b>PHOTO</b>	Optimal resolution for documents containing photographs.	

- 3 Confirm your choice by pressing the **OK** button.
- 4 Quit this menu by pressing the button.

### Note

*You can also change the resolution by pressing the button.*

## Zoom setup

The **ZOOM** parameter allows you to reduce or enlarge an area of a document by choosing the origin and the zoom level to apply to the document, from 25 to 400 %.

### ▼ 842 - ADVANCED FCT/COPY/ZOOMING

- 1 Press **▼**, enter **842** using the keypad.
- 2 Enter the desired zoom level with the alphanumerical keypad or choose among predefined values with the buttons **▲** and **▼**.
- 3 Confirm your choice by pressing the **OK** button.
- 4 Quit this menu by pressing the button.

## Analysis origin setup

If you want, you can change the origin of the scanner.

By entering new values for X and Y in mm ( $X < 209$  and  $Y < 280$ ), you move the analysed area as shown on the diagram below.

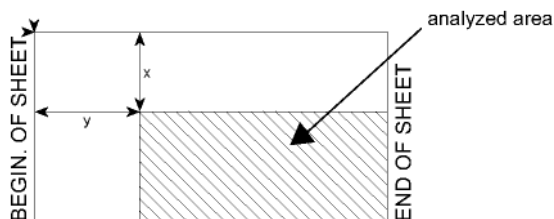

### ▼ 843 - ADVANCED FCT/COPY/ORIGIN

- 1 Press **▼**, enter **843** using the keypad.
- 2 Select the X and Y coordinates with the buttons **▲** or **▼**.
- 3 Setup the desired coordinates with the numerical keypad or the buttons **▲** and **▼**.
- 4 Confirm your choice by pressing the **OK** button.
- 5 Quit this menu by pressing the  button.

## Contrast setup

The **CONTRAST** parameter allows to choose the photocopy contrast.

### ▼ 844 - ADVANCED FCT/COPY/CONTRAST

- 1 Press **▼**, enter **844** using the keypad.
- 2 Setup the desired level of contrast with the buttons **▲** and **▼**.
- 3 Confirm your choice by pressing the **OK** button.
- 4 Quit this menu by pressing the  button.

## Brightness setup

The **BRIGHTNESS** parameter allows to lighten or darken your output.

### ▼ 845 - ADVANCED FCT/COPY/BRIGHTNESS

- 1 Press **▼**, enter **845** using the keypad.
- 2 Setup the desired brightness with the buttons **▲** and **▼**.
- 3 Confirm your choice by pressing the **OK** button.
- 4 Quit this menu by pressing the  button.

## Paper type setup

### ▼ 851 - ADVANCED FCT/SCAN. & PRINT/PAPER TYPE

- 1 Press **▼**, enter **851** using the keypad.
- 2 Select the paper **NORMAL** or **THICK** that you use with the buttons **▲** and **▼**.
- 3 Confirm your choice by pressing the **OK** button.
- 4 Quit this menu by pressing the  button.

## Paper tray selection

The **Automatic** selection can have two meanings depending on the paper format defined on the paper trays. The following table describes the different cases.

	Default tray	Tray used for copy
Same paper format in the trays	<b>AUTOMATIC</b>	Selection between the main tray and the manual tray.
	<b>MANUAL</b>	The manual tray is used.
Different paper format in the trays	<b>AUTOMATIC</b>	The main tray is used.
	<b>MANUAL</b>	The manual tray is used.

### ▼ 852 - ADVANCED FCT/SCAN. & PRINT/TRAY PAPER

- 1 Press **▼**, enter **852** using the keypad.
- 2 Select the default paper tray to use, **AUTOMATIC** or **MANUAL**, with the buttons **▲** and **▼**.
- 3 Confirm by pressing the **OK** button.
- 4 Quit this menu by pressing the  button.

## Flat-bed analysis margins setup

If you want to, you can offset the lateral margins of the document to the left or right during the analysis with your flat-bed scanner.

### ▼ 854 - ADVANCED FCT/SCAN. & PRINT/FLATBED MARG

- 1 Press **▼**, enter **854** using the keypad.
- 2 Setup the left / right margins offsets (by 0.5 mm steps) with the buttons **▲** and **▼**.
- 3 Confirm by pressing the **OK** button.
- 4 Quit this menu by pressing the  button.

## Left and right printing margins setup

If you want to, you can offset the lateral margins of the document to the left or right during printing.

### ▼ 855 - ADVANCED FCT/SCAN. & PRINT/PRINTER MARG

- 1 Press **▼**, enter **855** using the keypad.
- 2 Setup the left / right margins offsets (by 0.5 mm steps) with the buttons **▲** and **▼**.
- 3 Confirm by pressing the **OK** button.
- 4 Quit this menu by pressing the  button.



## Top and bottom printing margins setup

If you want to, you can offset the lateral margins of the document towards the top or the bottom during printing.

### ▼ 856 - ADVANCED FCT/SCAN. & PRINT/TOP PRINT.

- 1 Press ▼ , enter **856** using the keypad.
- 2 Setup the top / bottom margins offsets (by 0.5 mm steps) with the buttons ▲ and ▼ .
- 3 Confirm by pressing the **OK** button.
- 4 Quit this menu by pressing the  button.

## Format paper setup

This menu allows you to define the default paper format of the manual tray and the main tray. You can also setup the default scanning width.

### ▼ 857 - ADVANCED FCT/SCAN. & PRINT/PAPER FORMAT

- 1 Press ▼ , enter **857** using the keypad.
- 2 Select the paper tray for which you want to define a default paper format with the buttons ▲ and ▼ .
- 3 Confirm by pressing the **OK** button.
- 4 Choose the paper format with the buttons ▲ or ▼ according to the following table:

Paper tray	Available paper format
<b>MAN. TRAY</b>	A5, Statement, A4, Legal and Letter
<b>AUTO. TRAY</b>	A5, Statement, A4, Legal and Letter
<b>SCANNER</b>	LTR/LGL and A4

- 5 Confirm by pressing the **OK** button.
- 6 Quit this menu by pressing the  button.

# Parameters/ Setup

You can setup your machine as you like depending on the use. You will find in this chapter description of the functions.

You can print the functions guide and the available setup of your multifunction machine.



## Note

You can also use the update function available with the Companion Suite Pro software to download the latest online updates (see **Firmware update**, page 48).

## Language

This setting enables you to choose the menu language of your choice. By default, the multifunction machine is set to English.

To select the language:

### ▼ 203 - SETUP / GEOGRAPHICAL / LANGUAGE

- 1 Press ▼, enter **203** using the keypad.
- 2 Select the required language using ▼ and ▲, then press the **OK** key to confirm.
- 3 To exit this menu, press .

## Technical Parameters

As delivered your machine is preset by default. However, you may adjust it to meet your requirements by resetting the technical parameters.

To set the technical parameters:

### ▼ 29 - SETUP / TECHNICALS

- 1 Press ▼, enter **29** using the keypad.
- 2 Select the desired parameter and confirm with **OK**.
- 3 With the keys ▼ or ▲, modify the parameter settings by following the table below and press **OK**.

Parameter	Signification
<b>8 - Eco energy</b>	Choosing the printer standby delay: the printer will switch to standby after a delay (in minutes) of NON-operation or during the period of time of your choice.  <b>Note:</b> you can also access this parameter by pressing the  key from the idle screen.
<b>80 - Toner save</b>	Makes printing lighter to save toner cartridge ink.
<b>90 - RAW Port</b>	RAW network print port connection.
<b>91 - Printer error timeout</b>	Time-out before document being printed is deleted following a print error in PC print mode.
<b>92 - Printer wait timeout</b>	Wait time-out for data from PC before the task is deleted in PC print.
<b>93 - Replace format</b>	Page format change. This parameter allows you to print a LETTER format document on A4 pages using the LETTER/A4 setting.
<b>96 - NBR. WEP Keys</b>	Number of WEP keys allowed (from 1 to 4).

## Printing the functions guide

 **Important** *The printing is not possible on A5 (or Statement) paper format.*

### ▼ 51 - PRINT / FUNCTIONS LIST

Press ▼, enter **51** using the keypad.

The printing of the functions guide starts.



*You can also access the **PRINT** menu by pressing the  button.*

## Print the list of setups

 **Important** *The printing is not possible on A5 (or Statement) paper format.*

To print the list of setups:

### ▼ 56 - PRINT / SETUP

Press ▼, enter **56** using the keypad.

The printing of the list of setups starts.



*You can also access the **PRINT** menu by pressing the  button.*

## Lock the machine

This function prevents non-authorized people from accessing the machine. An access code will be required every time someone wants to use the device. After each use, the device will lock automatically.

Before that you have to enter a lock code.

### ▼ 811 - ADVANCED FCT / LOCK / LOCKING CODE

- 1 Press ▼, enter **811** using the keypad.
- 2 Enter your lock code (4 digits) with the keyboard, confirm with **OK**.

 **Important** *If a code is already registered, enter the old code before typing the new one.*

- 3 Enter again your lock code (4 digits) with the keyboard, confirm with **OK**.
- 4 Quit this menu by pressing the  button.

## Lock the keyboard

Every time you use your machine, you will have to enter your code.

### ▼ 812 - ADVANCED FCT / LOCK / LOCK KEYBD.

- 1 Press ▼, enter **812** using the keypad.
- 2 Enter the four-digit locking code with the keypad.

- 3 Press **OK** to confirm.
- 4 With the buttons ▼ or ▲, choose **ON** and confirm with **OK**.
- 5 Quit this menu by pressing the  button.

## Lock the Media service

This function prevents access to the Media service. The access code will be required every time someone wants to use the USB key functions:

- analyse the contents of a connected USB key,
- print from a USB key, delete files.

To access the Media service locking menu:

### ▼ 816 - ADVANCED FCT / LOCK / LOCK MEDIA

- 1 Press ▼, enter **816** using the keypad.
- 2 Enter the four-digit locking code with the keypad.
- 3 Press **OK** to confirm.
- 4 With the buttons ▼ or ▲, choose **ON** and confirm with **OK**.
- 5 Quit this menu by pressing the  button.

## Read the counters

This function allows you to view the activity counters for your machine at any time.

According to your needs, you can read the counters for:

- scanned pages,
- printed pages.

## Scanned pages counter

To view the number of pages scanned on your machine:

### ▼ 823 - ADVANCED FCT / COUNTERS / SCANNED PAGE

- 1 Press ▼, enter **823** using the keypad.
- 2 The number of scanned pages appears on the screen.
- 3 Quit this menu by pressing the  button.

## Printed pages counter

To view the number of pages printed on your machine:

### ▼ 824 - ADVANCED FCT / COUNTERS / PRINTED PG

- 1 Press ▼, enter **824** using the keypad.
- 2 The number of printed pages appears on the screen.
- 3 Quit this menu by pressing the  button.

## ***Display the consumables status***

---

You can read at any time the remaining toner in the cartridge. This level appears in percentage.

### **▼ 86 - ADVANCED FCT / CONSUMABLES**

- 1 Press ▼ , enter **86** using the keypad.
- 2 The available toner percentage appears on the screen.
- 3 Quit this menu by pressing the  button.

## ***Calibrate your scanner***

---

You can do this operation when the quality of photocopied documents is not satisfactory anymore.

### **▼ 80 - ADVANCED FCT / CALIBRATION**

- 1 Press ▼ , enter **80** using the keypad. Confirm with **OK**.
- 2 The scanner is triggered and a calibration is done automatically.
- 3 At the end of the calibration, the machine comes back to the screen saver.

# Games

## Sudoku

Sudoku is a Japanese puzzle. The game is in a grid format of three squares by three squares to be distributed in fields in zones of 3 x 3. Depending on the level of difficulty, more or fewer numbers are already entered at the start of the game. The aim of the game is to distribute the numbers 1 to 9 between the boxes in such a way that each number appears only once in each row, column and in each of the nine grids. There is only one solution.

### Print a grid

There are 400 Sudoku grids available in total, 100 for each difficulty level.

 **Important** *The printing is not possible on A5 (or Statement) paper format.*

▼ **521 - PRINT / SUDOKU / PRINT GRID**

- 1 Press ▼, enter **5** using the keypad. Confirm with **OK**.

 **Note**

*You can also access the **PRINT** menu by pressing the  button.*

- 2 Select **SUDOKU** using the ▼ or ▲ button.
- 3 Confirm with **OK**.
- 4 Select **PRINT GRID** using the ▼ or ▲ button.
- 5 Select the level of difficulty **EASY, MEDIUM, HARD, EVIL** using the ▼ or ▲ button.
- 6 Confirm with **OK**.
- 7 Choose the grid you want by entering the number on the numeric keypad (1 to 100).
- 8 Confirm with **OK**.
- 9 Choose the number of copies you want by entering a number from 1 to 9 on the numeric keypad.
- 10 Confirm with **OK**.

The number of copies of the grid requested is printed.

### Print the solution to a grid

 **Important** *The printing is not possible on A5 (or Statement) paper format.*

▼ **522 - PRINT / SUDOKU / PRT SOLUTION**

- 1 Press ▼, enter **5** using the keypad. Confirm with **OK**.

 **Note**

*You can also access the **PRINT** menu by pressing the  button.*

- 2 Select **SUDOKU** using the ▼ or ▲ button.
- 3 Confirm with **OK**.
- 4 Select **PRT SOLUTION** using the ▼ or ▲ button.
- 5 Select the level of difficulty **EASY, MEDIUM, HARD, EVIL** using the ▼ or ▲ button.
- 6 Confirm with **OK**.
- 7 Choose the grid you want by entering the number on the numeric keypad (1 to 100).
- 8 Confirm with **OK**.
- 9 Choose the number of copies you want by entering a number from 1 to 9 on the numeric keypad.
- 10 Confirm with **OK**.

The number of copies of the solution to the grid requested is printed.

# Network features

You may connect your multifunction terminal to a wireless network.

However, practical knowledge of your computer configuration is required to set up a network.

You can connect your machine to a PC using a USB cable or make a wireless connection (via radio) with a PC or network.

## ! Important

If you have a WLAN adaptor, you can incorporate your machine as a network printer into a radio network. This works only with an approved adaptor that you can obtain from our ordering department.

## Type of radio network

A radio network or WLAN (Wireless Local Area Network) is created when at least two computers, printers or other peripheral devices communicate with each other in a network via radio waves (high frequency waves). The transmission of data in the radio network is based on the standards 802.11b and 802.11g. According to how the network is set up, it may be described as an infrastructure network or an ad-hoc network.

## ! CAUTION

Beware, when you are using a wireless connection, that certain items of medical equipment, sensitive or security systems may be affected by the radio transmissions of your device; in all cases, please follow safety guidelines closely.

## Radio infrastructure network

In an infrastructure network, several devices communicate via a central access point (a gateway or router). All data is sent to the access point (gateway or router) from where it is re-distributed.

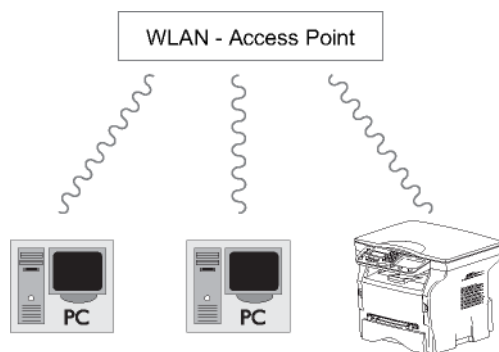

## Radio ad-hoc network

In an ad-hoc network, the devices communicate directly with each other without passing through an access point. The speed of communication across the whole radio network is as fast as the weakest connection in the network. The speed of communication is also dependent on spatial distance between transmitter and receiver, as well as the number of barriers, such as walls or ceilings.

## ! Important

Please note that in ad-hoc mode, the WPA/WPA2 encryption method is not available.

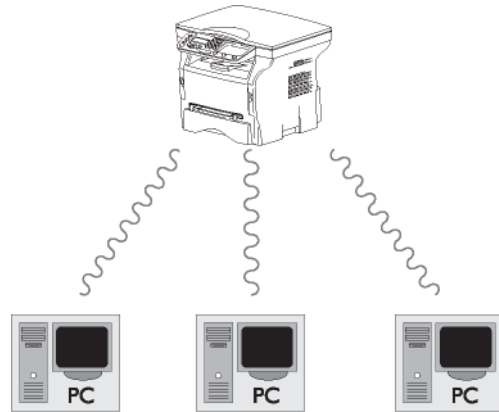

## Radio networks (WLAN)

Three steps are necessary to incorporate your machine into a radio network (WLAN):

- 1 Configure the network to your PC.
- 2 Set up the parameters for your machine so that it can function in a network.
- 3 Having set up the parameters for your device, install the Companion Suite Pro software onto your PC with the necessary printer drivers.

Once the machine is incorporated into a WLAN network, you can from your PC:

- print documents on the multifunction machine from your usual applications,
- scan colour, grey scale or black and white documents on your PC.

The PC and all other devices must have their parameters set up to the same network as the multifunction machine. All the details needed for setting up the device, such as the network names (SSID), type of radio network, encryption key, IP address or subnet mask, must match the specifications of the network.

## ! Important

You will find these details on your PC or on the Access Point.

To find out how to set up the parameters for your PC, please consult the users' manual for your WLAN adaptor. For large networks, please seek the advice of your network administrator.



You can be sure of perfect communication if you use an approved adaptor in conjunction with your PC.

## Connect your WLAN adaptor

Your machine belongs to a new generation of terminals that you can incorporate into a WLAN network using a WLAN USB key.

Your machine's network radio adaptor transmits data using the radio protocol IEEE 802.11g; it can also be incorporated into an existing IEEE 802.11b network.

When connecting to your machine, only use the approved adaptor. Other transmitting or receiving adaptors may damage your device.



Irrespective of whether you use your machine in an infrastructure or ad-hoc network, you must set up certain network and security parameters (for example, the Service-Set-ID (SSID) and the encryption key). These must match the network's specifications.

- 1 Plug your WLAN USB key into the USB port of your machine.

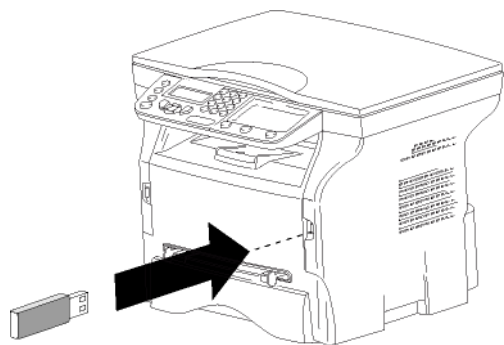

## Configure your network



We recommend that the settings of your WLAN network should only be changed by a person with a good knowledge of the configuration of your computer.

## Creating or rejoining a network

Before attempting to use a WLAN adaptor on your

machine, you must enter the parameters that will allow a WLAN network to recognise your machine.

On your machine you will find simple instructions that guide you step by step through the set-up of your network. Just follow them!

▼ 281 - **SETUP / WLAN / CONFIG. ASS.**

- 1 Type in ▼, select the menu **SETUP** using the keys ▼ or ▲ and confirm with **OK**.
- 2 Select **WLAN** using the keys ▼ or ▲ and confirm with **OK**.
- 3 Select **CONFIG. ASS.** using the keys ▼ or ▲ and confirm with **OK**.  
The machine searches for existing networks.
- 4 Select your existing network, or select **NEW NETWORK** to create it, using the keys ▼ or ▲ and confirm with **OK**.



If you choose an existing network, steps 5 and 6 (and possibly 7) are carried out automatically.

- 5 **SSID** appears on the screen, enter the name of your network using the numerical keypad, pressing the keys one after the other until you obtain the name you want (32 characters maximum) and confirm with **OK**.
- 6 **AD-HOC MODE** or **INFRA. MODE** appear on the screen. Go back to the beginning of the chapter and make your choice.  
Select one of these modes and confirm with **OK**.
  - If you choose AD-HOC mode, the sub-menu **CHANNEL** appears, enter a figure between 1 and 13 (1 to 11 for the US) and confirm with **OK**.
- 7 Select your encryption method, **OFF**, **WEP** or **WPA**, and confirm with **OK**:



Please note that in ad-hoc mode, the WPA/WPA2 encryption method is not available.

- If you choose **WEP**, enter the WEP key that you are using on your network.



The WEP key number may be configured in the menu: ▼ 29 - **SETUP / TECHNICALS / WEP KEYS NBR.**

- If you choose **WPA**, enter the WPA or WPA2 key that you are using on your network.
- 8 **IP CONF.: MANU** or **IP CONF.: AUTO** appear on the screen.  
If you choose to set up the system manually, go to the next paragraph and enter the parameters IP ADDRESS, SUBNET MASK and GATEWAY.
  - 9 At the end of this procedure, you return to the main menu of **CONFIG. ASS.**
  - 10 Exit this menu by pressing the key.

Once the network has been set up, the LED of the WLAN USB key should be on.

## Referring to or changing your network parameters

Each of the parameters of your network may be changed as your network develops.

### ▼ 2822 - SETUP / WLAN / PARAMETERS / IP ADDRESS

- 1 Type in ▼, select the menu **SETUP** using the keys ▼ or ▲ and confirm with **OK**.
- 2 Select **WLAN** using the keys ▼ or ▲ and confirm with **OK**.
- 3 Select **PARAMETERS** using the keys ▼ or ▲ and confirm with **OK**.
- 4 Select **IP ADDRESS** using the keys ▼ or ▲ and confirm with **OK**.
- 5 The number of your IP address will appear in the format **000.000.000.000**. Enter the new IP address for your machine in the format displayed and confirm with **OK**.
- 6 Exit this menu by pressing the  key.

### ▼ 2823 - SETUP / WLAN / PARAMETERS / SUBNET MASK

- 1 Type in ▼, select the menu **SETUP** using the keys ▼ or ▲ and confirm with **OK**.
- 2 Select **WLAN** using the keys ▼ or ▲ and confirm with **OK**.
- 3 Select **PARAMETERS** using the keys ▼ or ▲ and confirm with **OK**.
- 4 Select **SUBNET MASK** using the keys ▼ or ▲ and confirm with **OK**.
- 5 The number of your subnet mask will appear in the format **000.000.000.000**. Enter the new submask of your machine in the format displayed and confirm with **OK**.
- 6 Exit this menu by pressing the  key.

### ▼ 2824 - SETUP / WLAN / PARAMETERS / GATEWAY

- 1 Type in ▼, select the menu **SETUP** using the keys ▼ or ▲ and confirm with **OK**.
- 2 Select **WLAN** using the keys ▼ or ▲ and confirm with **OK**.

- 3 Select **PARAMETERS** using the keys ▼ or ▲ and confirm with **OK**.
- 4 Select **GATEWAY** using the keys ▼ or ▲ and confirm with **OK**.
- 5 The number of your gateway will appear in the format **000.000.000.000**. Enter the new gateway for your machine in the format displayed and confirm with **OK**.
- 6 Exit this menu by pressing the  key.

### ▼ 2825 - SETUP / WLAN / PARAMETERS / SSID

- 1 Type in ▼, select the menu **SETUP** using the keys ▼ or ▲ and confirm with **OK**.
- 2 Select **WLAN** using the keys ▼ or ▲ and confirm with **OK**.
- 3 Select **PARAMETERS** using the keys ▼ or ▲ and confirm with **OK**.
- 4 Select **SSID** using the keys ▼ or ▲ and confirm with **OK**.
- 5 The name of your network will appear on the screen. Enter the new name of your network and confirm with **OK**.
- 6 Exit this menu by pressing the  key.

### ▼ 2826 - SETUP / WLAN / PARAMETERS / MODE

- 1 Type in ▼, select the menu **SETUP** using the keys ▼ or ▲ and confirm with **OK**.
- 2 Select **WLAN** using the keys ▼ or ▲ and confirm with **OK**.
- 3 Select **PARAMETERS** using the keys ▼ or ▲ and confirm with **OK**.
- 4 Select **MODE** using the keys ▼ or ▲ and confirm with **OK**.
- 5 The symbol >>, tells you that your network is in active mode.
- 6 Select one of the modes and confirm with **OK**.
  - If you choose the AD-HOC MODE, the sub-menu **CHANNEL** will appear; enter a number between 1 and 13 (1 to 11 for the US) and confirm with **OK**.
- 7 Exit this menu by pressing the  key.

#### Important

*In an AD-HOC network, the devices communicate directly with each other without passing through an access point. The speed of communication across the whole AD-HOC radio network is as fast as the weakest connection in the network. The speed of communication is also dependent on spatial distance between transmitter and receiver, as well as the number of barriers, such as walls or ceilings.*



### ▼ 2827 - SETUP / WLAN / PARAMETERS / SECURITY

This parameter allows you to make your network secure by setting the encryption method to use in your WLAN network.

- 1 Type in ▼ , select the menu **SETUP** using the keys ▼ or ▲ and confirm with **OK**.
- 2 Select **WLAN** using the keys ▼ or ▲ and confirm with **OK**.
- 3 Select **PARAMETERS** using the keys ▼ or ▲ and confirm with **OK**.
- 4 Select **SECURITY** using the keys ▼ or ▲ and confirm with **OK**.
- 5 Choose **WEP**, **WPA** or **OFF** and confirm with **OK**.
  - If you choose **WEP**, enter a password:
    - In a 64 bit security configuration, the password must contain five characters exactly.
    - In a 128 bit security configuration, the password must contain 13 characters exactly.

*You may also enter the password using the hexadecimal system, if this is the case:*

- For a 64 bit security configuration, the password must contain exactly 10 hexadecimal characters.
- For a 128 bit security configuration, the password must contain exactly 26 hexadecimal characters.



#### Note

- If you choose **WPA**, enter a WPA or WPA2 password (min. 8 characters to 63 characters max.). The password can contain alphanumerical characters - numbers and letters - and any other symbol available on the keypad. The only invalid character is "€" (euro currency sign).

- 6 Exit this menu by pressing the  key.

### ▼ 2828 - SETUP / WLAN / PARAMETERS / HOSTNAME

The machine name allows you to identify your machine on the network via a PC (for example with the name "PRINT-NETWORK-1").

- 1 Type in ▼ , select the menu **SETUP** using the keys ▼ or ▲ and confirm with **OK**.
- 2 Select **WLAN** using the keys ▼ or ▲ and confirm with **OK**.
- 3 Select **PARAMETERS** using the keys ▼ or ▲ and confirm with **OK**.
- 4 Select **HOSTNAME** using the keys ▼ or ▲ and confirm with **OK**.
- 5 Type in the desired name (15 characters maximum) and confirm with **OK**.
- 6 Exit this menu by pressing the  key.

Once your connection has been set up, you must install the network printer driver on your PC so that you can print your documents.

Refer to the paragraph **Software installation**, page 34.

### An example of how an AD-HOC network may be set up

An example of how to configure an Ad-hoc network without security protection using the following parameters:

- network name: "house"
- radio type: "ad-hoc"
- channel: "1"
- PC's IP address: "169.254.0.1"
- PC's subnetwork mask: "255.255.0.0"
- PC's gateway: "0.0.0.0"
- IP address of the multifunction machine: "169.254.0.2"
- subnetwork mask of the multifunction machine: "255.255.0.0"
- multifunction machine's gateway: "0.0.0.0"

### Setting up a multifunction machine

- 1 Plug the WLAN USB key into the USB connector of the multifunction machine.
- 2 Type in ▼ , select the menu **SETUP** using the keys ▼ or ▲ and confirm with **OK**.
- 3 Select **WLAN** using the keys ▼ or ▲ and confirm with **OK**.
- 4 Select **CONFIG. ASS.** using the keys ▼ or ▲ and confirm with **OK**.
- 5 Select **NEW NETWORK** using the keys ▼ or ▲ and confirm with **OK**.
- 6 **SSID** appears on the screen, enter "house" using the numerical keypad and confirm with **OK**.
- 7 Select the mode **AD-HOC MODE** and confirm with **OK**.
- 8 Enter "1" in the field **CHANNEL** and confirm with **OK**.
- 9 Select **OFF** and confirm with **OK**.
- 10 Select **IP CONF.: MANU** and confirm with **OK**.
- 11 Enter "169.254.0.2" in the field **IP ADDRESS** and confirm with **OK**.
- 12 Enter "255.255.0.0" in the field **SUBNET MASK** and confirm with **OK**.
- 13 Enter "0.0.0.0" in the field **GATEWAY** and confirm with **OK**.
- 14 At the end of this process, you return to the main menu of **ASS. CONFIG.**
- 15 Exit this menu by pressing the  key.

Once the network has been set up, the LED of the WLAN USB key should be on.

You must now set up the PC.

## Setting up the PC

---

For this section, refer to the instructions supplied by the manufacturer of the WLAN USB key to help you to find and join the "house" network.

- 1 You may need to install the software for the WLAN USB key on the PC, if this has not already been done.
- 2 Plug WLAN USB key into a USB port on the PC.
- 3 Use the software of the WLAN USB key to detect the network.
- 4 Join the network "**house**" once this has been detected.
- 5 Now set up the WLAN network connection of your PC.

**Note**

*To guide you through this stage, refer to the paragraph "Setting the parameters for a connection" in the manufacturer's instructions.*

---

To do this, you must configure the element **Protocol Internet (TCP/IP)** for the WLAN connection that has been created. If this element is set up in such a way as to obtain an IP address automatically, you must change it to manual mode to set up the TCP/IP address ("169.254.0.1" in our example), the subnet mask ("255.255.0.0" in our example) and the default gateway ("0.0.0.0" in our example).

- 6 Enter **OK**.

# USB memory key

You can connect a USB memory Key on the front side of your machine. The files stored in TXT, TIFF and JPEG formats will be analysed and you will be able to use the following actions:

- print the stored files contained in your USB memory key<sup>1</sup>,
- delete the files contained in your USB memory key,
- run an analysis on the contents of the inserted USB memory key,
- digitalise a document on your USB memory key.

## Use of the USB memory key



### Important

Always respect the insertion way when you connect a USB memory key to the machine.

Do not disconnect your USB memory key while the machine is reading its contents or writing contents.

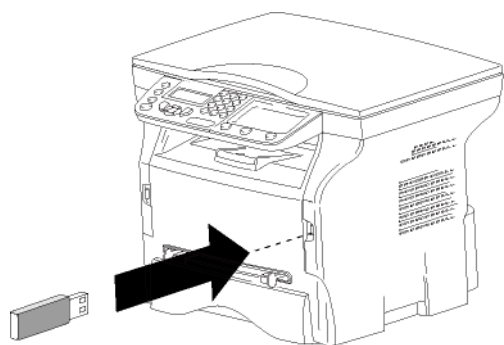

## Print your documents



### Important

The printing is not possible on A5 (or Statement) paper format.

You can print the stored files or a list of the files located in the USB memory key.

### Print the list of files located in the key

To print the list of files located in the key:

#### ▼ 01 - MEDIA / PRINT DOC. / LIST

- 1 Insert the USB memory key on the front side of the machine respecting the insertion way. **MEDIA ANALYSIS** appears on the screen.
- 2 Select **PRINT DOC.** with the ▼ or ▲ buttons and confirm with **OK**.
- 3 Select **LIST** with the ▼ or ▲ buttons and confirm with **OK**.

1. It may be possible that some TIFF files of your USB memory key cannot be printed due to data format limitation.

- 4 The list is shown in a table with the following information:

- the analysed files are indexed in an incremental 1 by 1 order,
- the files name with their extension,
- the date of the files last save,
- the files size in Kbytes.

### Print the files located in the key

To print the files located in the key:

#### ▼ 01 - MEDIA / PRINT DOC. / FILE

- 1 Insert the USB memory key on the front side of the machine respecting the insertion way. **MEDIA ANALYSIS** appears on the screen.
- 2 Select **PRINT DOC.** with the ▼ or ▲ buttons and confirm with **OK**.
- 3 Select **FILE** with the ▼ or ▲ buttons and confirm with **OK**.
- 4 You have three possibilities to print your files:
  - **ALL**, to print all the files located in the USB memory key. Select **ALL** with the ▼ or ▲ buttons and confirm with **OK**. The printing is started automatically.
  - **SERIES**, to print a series of files located in the USB memory key. Select **SERIES** with the ▼ or ▲ buttons and confirm with **OK**. **FIRST FILE** and the first indexed file appears on the screen. Select with the ▼ or ▲ buttons the first file of the series to print and confirm with **OK**. A star (\*) appears on the left side of the file. **LAST FILE** appears on the screen. Select with the ▼ or ▲ buttons the last file of the series to print and confirm with **OK**.

Press the  button.

**COPIES NUMBER** appears on the screen, enter the desired number of copies with the numerical keypad and confirm with **OK**. Select the printing format (for JPEG files): **A4** or **LETTER** (depending on model), or **PHOTO** and confirm with **OK**. Select the printing format: **THICK** or **NORMAL** and confirm with **OK** to start printing.

- **SELECTION**, to print one or several files located in the USB memory key. Select with the ▼ or ▲ buttons the file to print and confirm with **OK**. A star (\*) appears on the left side of the file. Repeat this step for each file you want to print.

Press the  button.

**COPIES NUMBER** appears on the screen, enter the desired number of copies with the numerical keypad and confirm with **OK**.

Select the printing format (for JPEG files): **A4** or **LETTER** (depending on model), or **PHOTO** and

confirm with **OK**.

Select the printing format: **THICK** or **NORMAL** and confirm with **OK** to start printing.

- 5 Quit this menu by pressing the  button.

## Delete your files located in the key

You can delete files located in your USB memory key.

### ▼ 06 - MEDIA / DELETE / MANUAL

- 1 Insert the USB memory key on the front side of the machine respecting the insertion way.  
**MEDIA ANALYSIS** appears on the screen.
- 2 Select **DELETE** with the ▼ or ▲ buttons and confirm with **OK**.
- 3 Select **MANUAL** with the ▼ or ▲ buttons and confirm with **OK**.
- 4 You have three possibilities to delete your files:
  - **ALL**, to delete all the files located in the USB memory key.  
Select **ALL** with the ▼ or ▲ buttons and confirm with **OK**.  
You come back to the previous menu.
  - **SERIES**, to delete a series of files located in the USB memory key.  
Select **SERIES** with the ▼ or ▲ buttons and confirm with **OK**.  
**FIRST FILE** and the first indexed file appears on the screen. Select with the ▼ or ▲ buttons the first file of the series to delete and confirm with **OK**. A star (\*) appears on the left of the file.  
**LAST FILE** appears on the screen, select with the ▼ or ▲ buttons the last file of the series to delete and confirm with **OK**. A star (\*) appears on the left side of the file.

Press the  button.

You come back to the previous menu.

- **SELECTION**, to delete only one or several files located in the USB memory key.  
Select with the ▼ or ▲ buttons the file to delete and confirm with **OK**. A star (\*) appears on the left side of the file.  
Repeat this step for each file you want to delete.

Press the  button.

You come back to the previous menu.

- 5 Quit this menu by pressing the  button.

## Analyse the USB memory key content

After a period of inactivity, your machine will return to the main menu. To view the USB memory key again please proceed as follows:

### ▼ 07 - MEDIA / MEDIA ANALYSIS

- 1 Press ▼, enter **07** using the keypad.
- 2 The USB memory key analysis is started.
- 3 You can print or delete the detected files located in your USB memory key. Refer to the previous chapters.

## Save a document on a USB memory key

This function allows you to digitise and save a document directly in the folder MFPrinter Laser Pro LL2\SCAN on a USB memory key. The folder MFPrinter Laser Pro LL2\SCAN is created by the application.

### Important

*Before digitalising a document, make sure that your USB memory key has sufficient disk space. If not, you can delete manually the files, see section **Delete your files located in the key**, page 32.*

- 1 Place the document to be copied face down on the glass.
- 2 Insert the USB memory key on the front side of the machine respecting the insertion way.  
The USB memory key analysis is started.  
When the analysis is finished, the **MEDIA** menu is displayed.
- 3 Select **SCAN TO** with the ▼ or ▲ buttons then confirm with the **OK** button.

*You can also access this function in two other ways:*

### Important

- by pressing the  button then by selecting **SCAN-TO-MEDIA**.
- by pressing the ▼ button from the screen saver then by typing **03** on the numerical keypad.

- 4 Choose between **B&W SCAN** or **COLOUR SCAN** with the ▼ or ▲ buttons and confirm with **OK**.
- 5 With the alphanumerical keypad, give a name to the scan file (up to 20 characters) and confirm with **OK**.
- 6 Choose the scan format between **IMAGE** and **PDF**, and confirm to start the scan and the recording of the document.  
**IMAGE** allows to have the same kind of file as a photo. **PDF** is a format for the digital documents creation.

---



With the **IMAGE** format, if you have selected:

- **BLACK&WHITE**, the picture will be saved in TIFF format.
- **COLOUR**, the picture will be saved in JPEG format.

You can choose the image resolution that will be digitized to the USB memory key; the default resolution is AUTO.

### Important

Press the  button several times and select the resolution you require:

- Scanning in **BLACK&WHITE**:
    -  icon: text resolution.
    -  icon: photo resolution.
    - no icon: auto resolution.
  - Scanning in **COLOUR**:
    -  icon: text resolution.
    - no icon: auto resolution.
- 

The beginning button  immediately starts the scan and sends a file to the support with the parameters defined in the analysis format.

# PC Features

## Introduction

The Companion Suite Pro software allows the connection of a personal computer with a compatible multifunction machine.

From the PC, you can:

- manage the multifunction machine, allowing you to set it up according to your needs,
- print your documents on the multifunction machine from your usual applications,
- scan colour, grey scale or black and white documents and edit them on your PC.

## Configuration requirements

The minimum configuration requirements for your personal computer are:

Supported operating systems:

- Windows 2000 with at least Service Pack 4,
- Windows XP x86 (Home and Pro) with at least Service Pack 1,
- Windows 2003 server for printing driver only,
- Windows Vista.

Processor:

- 800 MHz for Windows 2000,
- 1 GHz for Windows XP x86 (Home and Pro),
- 1 GHz for Windows Vista.

A DVD-ROM drive

A free USB port

600 Mbytes of available disk space for the installation RAM memory:

- 128 Mbytes minimum for Windows 2000,
- 192 Mbytes minimum for Windows XP x86 (Home and Pro),
- 1 GByte for Windows Vista.

## Software installation

This section describes the following installation procedures:

- full installation of the Companion Suite Pro software,
- installation of the drivers only.

### Installing the full software package

Turn your PC on. Open an account session with the administration rights.

- 1 Open the DVD-ROM drive, insert the installation DVD-ROM and close the drive.
- 2 An installation procedure is automatically run (Auto run). If it does not, double-click on setup.exe at the DVD-ROM's root.
- 3 A screen titled **COMPANION SUITE PRO LL2** appears. This screen allows you to install and uninstall the software, access the product's user guides or browse the DVD-ROM contents.
- 4 Place your cursor on **INSTALL PRODUCTS** and confirm with left-click of the mouse.



- 5 The Products Installation screen appears. Place your cursor on **ALL PRODUCTS** and confirm by left-click with the mouse.

*The full installation copies on your hard disk the software required for the good execution of the Companion Suite Pro kit, which is:*

- Companion Suite Pro (machine management software, printer drivers, scanner, ...),
- Adobe Acrobat Reader,
- PaperPort.

*You may already be the owner of a version of the software available in the installation DVD-ROM.*

*In this case use the **CUSTOMIZED** installation, select the software that you want to install on your hard drive and confirm your choice.*



### Note



- 6 The welcome screen appears. Click on the **NEXT** button to launch the installation of the Companion Suite Pro in your PC.



- 7 To continue, you need to accept the proposed license agreement.



- 8 Click on the **NEXT** button.

- 9 The final installation is ready to be executed. Click on the **INSTALL** button.

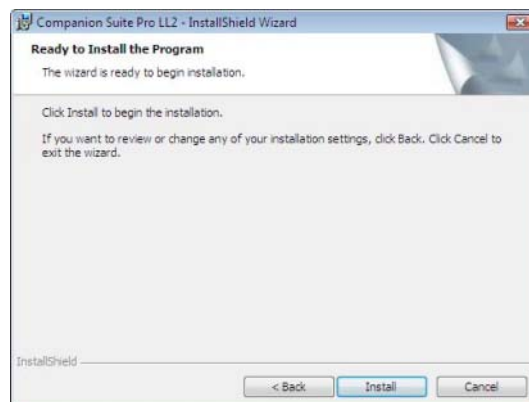

The following screen appears to indicate the progression of the installation.



- 10 Click on **OK** to finish the installation.

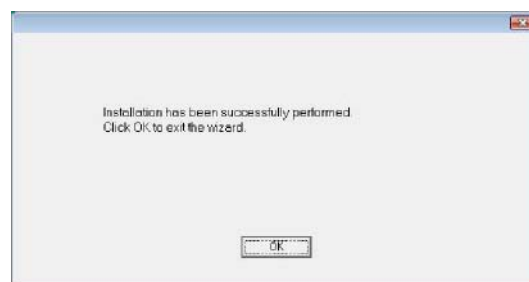

Your Companion Suite Pro kit is successfully installed on your PC.

You can now connect your multifunction machine, refer to paragraph **Connections**, page 38.

You can start the multifunction machine's management software from the menu **START > ALL PROGRAMS > COMPANION SUITE > COMPANION SUITE PRO LL2 > COMPANION DIRECTOR** or by clicking on the icon **COMPANION - DIRECTOR** located on your desktop.

## Installing drivers only

This section describes the following installation procedures:

- installation of drivers using the Companion Suite Pro software,
- manual installation of drivers.

### Installing the drivers using the Companion Suite Pro software

Turn your PC on. Open an account session with the administration rights.

- 1 Open the DVD-ROM drive, insert the installation DVD-ROM and close the drive.
- 2 An installation procedure is automatically run (Auto run). If it does not, double-click on setup.exe at the DVD-ROM's root.
- 3 A screen titled **COMPANION SUITE PRO LL2** appears. This screen allows you to install and uninstall the software, access the product's user guides or browse the DVD-ROM contents.
- 4 Place your cursor on **INSTALL PRODUCTS** and confirm with left-click of the mouse.



- 5 The Products Installation screen appears. Place your cursor on **CUSTOMIZED** and confirm by left-click with the mouse.



- 6 Place your cursor on **COMPANION SUITE PRO LL2** and confirm with left-click of the mouse.



- 7 The welcome screen appears. Click on the **NEXT** button to launch the installation of the Companion Suite Pro kit on your PC.



- 8 To continue, you need to accept the proposed license agreement.



- 9 Click on the **NEXT** button.
- 10 Select **INSTALL DRIVERS** in the list and click on the **NEXT** button.

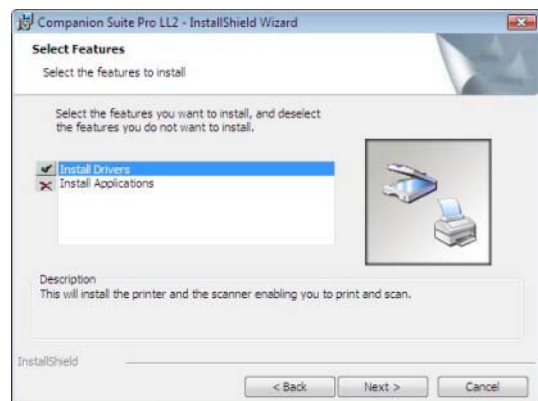



- 11 Select the destination folder for installation and click on the **NEXT** button.

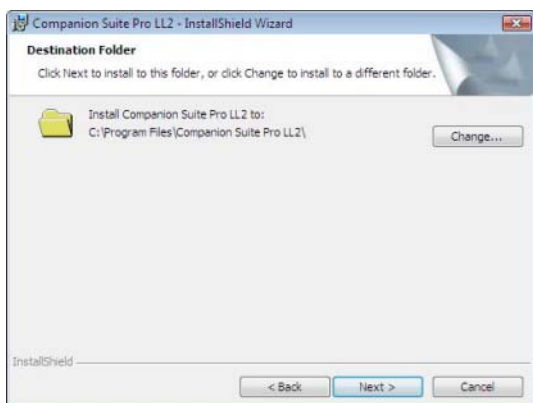

- 12 The final installation is ready to be executed. Click on the **INSTALL** button.

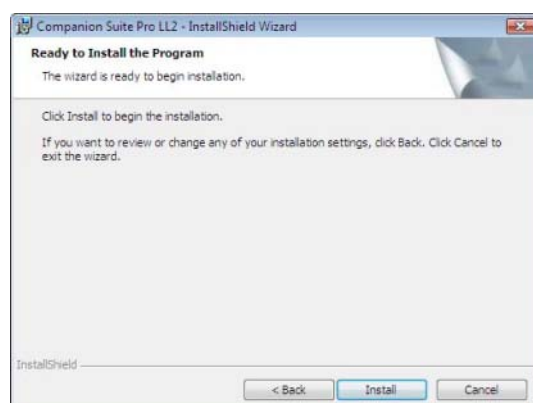

- 13 A screen informs you of the installation progress.

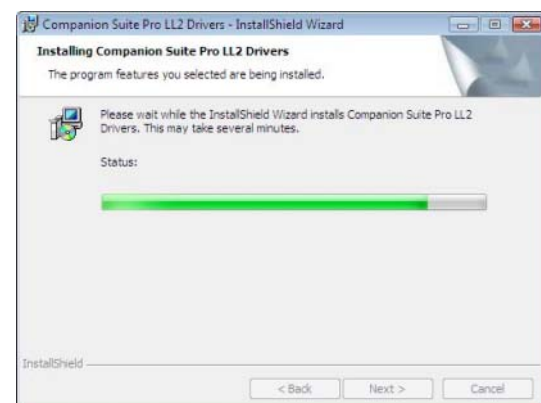

- 14 Click on **OK** to finish the installation.

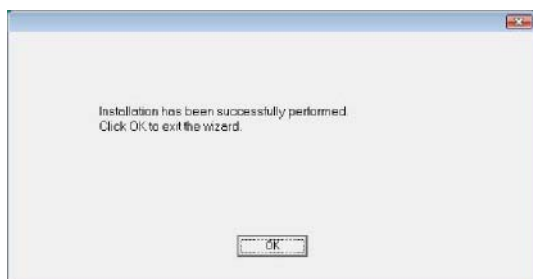

The Companion Suite Pro software is now installed on your PC.

You can now connect your multifunction machine, refer to paragraph **Connections**, page 38.

## Installing the drivers manually

You can install the printer and scan drivers manually without running any setup software.

**Note** This installation mode is only possible on Windows 2000, XP and Vista.

- 1 Locate your USB cable connectors and connect as shown below on the picture.

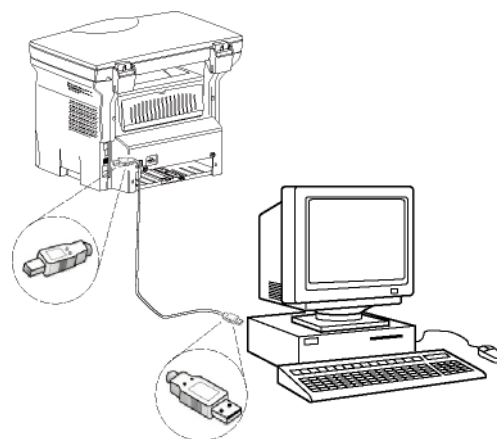

- 2 Power on your multifunction machine. The PC detects the device.
- 3 Click on **LOCATE AND INSTALL DRIVER SOFTWARE (RECOMMENDED)**.



The following screen appears:

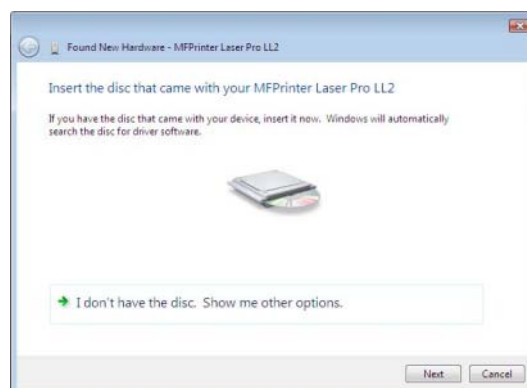

- 4 Open the DVD-ROM drive, insert the installation DVD-ROM and close the drive. The drivers are detected automatically.

- 5 Select LASER PRO LL2 in the list and click on **NEXT**.

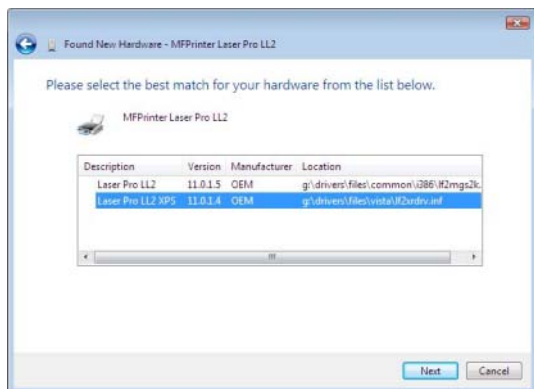

- 6 A screen informs you that the drivers have been installed. Click on the **CLOSE** button.

- 2 Power on your multifunction machine. The PC detects the device and the drivers are automatically installed.
- 3 Once the installation is finished, a message indicates that the drivers are installed correctly.



You can now use the multifunction machine to print or scan your documents.

You can now use the multifunction machine to print or scan your documents.

## Connections

Make sure that your multifunction machine is powered off. The connection between the PC and the machine requires a USB 2.0 shielded cable no more than 3 meters long.

*It is recommended to install the Companion Suite Pro software first and then to connect the USB cable to your machine (see **Installing the full software package**, page 34).*

### ! Important

*If you connect the USB cable before installing the Companion Suite Pro software the recognition system (plug and play) identifies automatically that new hardware has been added. To start your machine drivers installation, refer to paragraph **Installing the drivers manually**, page 37 and follow the instructions on screen. When you use this procedure, only printing and scanning functions are activated.*

- 1 Locate your USB cable connectors and connect as shown below on the picture.

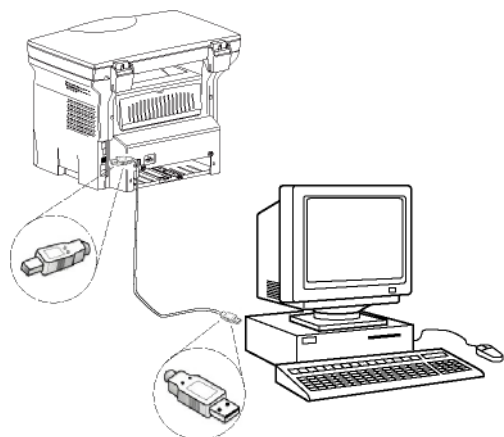

## Multifunction Terminal's Supervision

The software that you have installed contains two multifunction machine management applications, **COMPANION DIRECTOR** and **COMPANION MONITOR**, which allow you to:

- check whether the multifunction machine is connected to your PC,
- monitor the multifunction machine activities,
- monitor the status of the multifunction machine consumables from the PC,
- quickly access the graphic editor applications.

To manage the multifunction machine, run the Companion Director application by clicking on the icon located on your desktop or from the menu **START > ALLPROGRAMS > COMPANION SUITE > COMPANION SUITE PRO LL2 > COMPANION DIRECTOR**.

### Checking the connection between the PC and the multifunction machine

To check if the connection between the devices is good, run the **COMPANION MONITOR** software from the icon located on the desktop and check that the same information is displayed on the multifunction machine.

## Companion Director

This graphical Interface allows you to run the utilities and the software to manage your multifunction machine.

### Graphical presentation

Run the application by clicking on the **COMPANION DIRECTOR** icon located on your desktop or from the menu **START > ALLPROGRAMS > COMPANION SUITE > COMPANION SUITE PRO LL2 > COMPANION DIRECTOR**.



### Utilities and applications activation

The Companion Suite Pro graphical interface allows you to run the following utilities and software:

- get **HELP** from the current documentation,
- run the **PAPERPORT** software (Doc Manager).

To run a software or utility contained in the Companion Suite Pro kit, place the cursor on it and left-click with the mouse.

## Companion Monitor

### Graphical presentation

Run the application by clicking on the **COMPANION MONITOR** icon located on your desktop or from the menu **START > ALLPROGRAMS > COMPANION SUITE > COMPANION SUITE PRO LL2 > COMPANION MONITOR**.

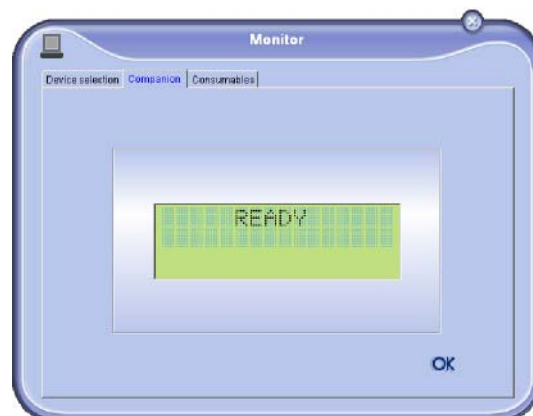

From this screen you can monitor the information or configure your multifunction machine from the tabs:

- **DEVICE SELECTION:** Displays the list of devices managed by the PC.
- **COMPANION:** Presents the multifunction machine screen (USB connection only).
- **CONSUMABLES:** Displays the consumables status.

### Device management

This tab shows the list of devices managed by the PC.

#### Selecting the current device

Only one device at a time may be connected to the PC. The current device may be selected by clicking on the radio button corresponding to the device.

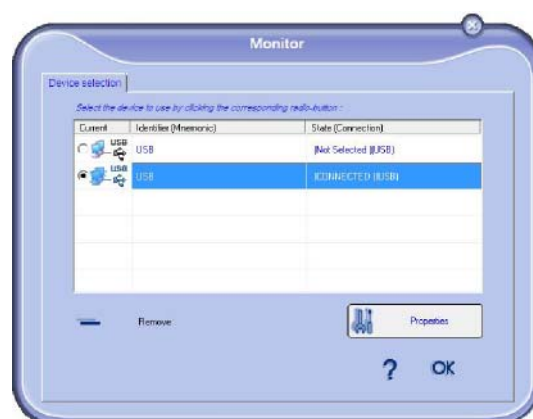

### Status of the connection

The status of the connection between the current device and the PC is indicated by a colour. The following table defines the possible states of the connection.

Colour	State
Yellow	Connection in progress.
Green	Connection established.
Red	The PC cannot connect to the device. Check the USB connection.

### Device parameters

- 1 Select a device by clicking on its line in the list and click on **PROPERTIES** to configure the scanning parameters to be applied for this device when you use the **SCAN TO** function.



- 2 Select the desired scan **MODE** in the drop-down menu.



- 3 Select the desired scan **RESOLUTION** in the drop-down menu.

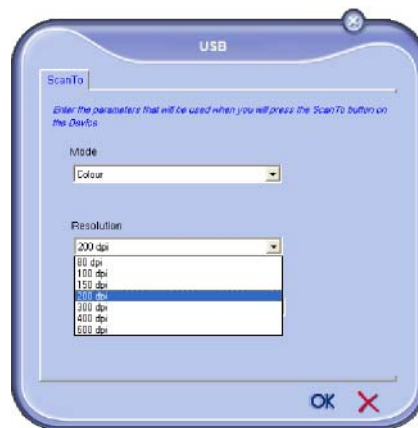

- 4 Click **OK** to confirm the new parameters.

### Removing a device

- 1 Select the device from the list and click the minus sign or **REMOVE** button.
- 2 To confirm the removal of the device, click **YES**. To cancel the removal, click **NO**.



The device is no longer displayed in the list.

### Display the consumable status

The following information will be available from the **CONSUMABLES** tab:

- current consumables status,
- number of printed pages,
- number of scanned pages.

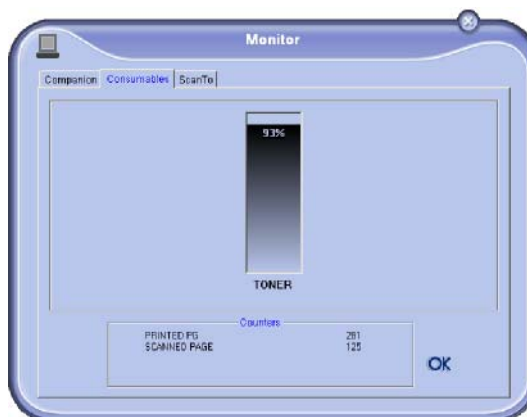

## Companion Suite Pro functionalities

### Document analysis

The document analysis can be carried out in two ways:

- either by the **SCAN TO** function (application accessible from the Companion Director window or from the **SCAN** button on the machine),
- or directly from a standard compatible application.

### Analysis with Scan To

Run the application by clicking on the **COMPANION DIRECTOR** icon located on your desktop or from the menu **START > ALL PROGRAMS > COMPANION SUITE > COMPANION SUITE PRO LL2 > COMPANION DIRECTOR**.



- 1 Click on the **SCAN TO** graphical image or press the **SCAN** button on your machine and select **SCAN-TO-PC**.
- 2 You can follow the ongoing digitisation on a screen.



- 3 At the end of the digitisation, the scanned picture appears in the PaperPort window.

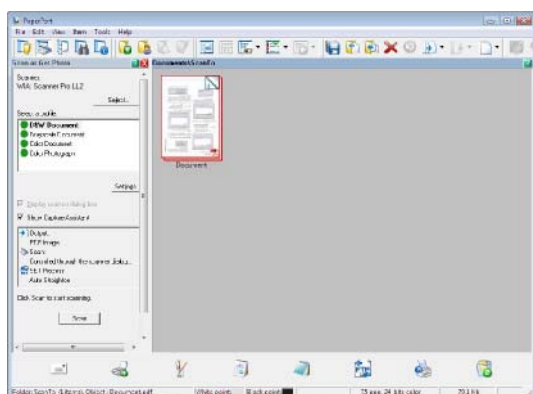

*If the PaperPort software is not installed on your hard drive, the scanned picture will appear on your desktop in TIFF format.*

To scan a document from PaperPort:

- 1 Click on **FILE > SCAN**.
- 2 Select the desired scanner.

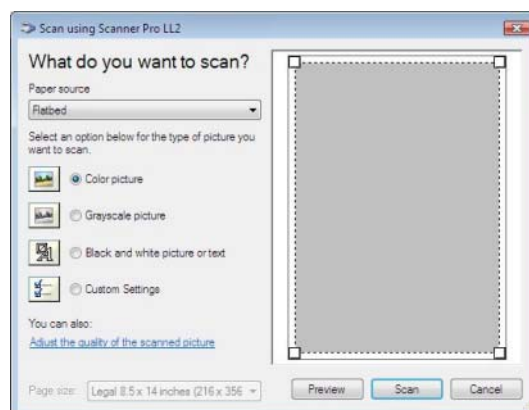

- 3 Customise the advanced properties of the digitisation by clicking on the **ADJUST THE QUALITY OF THE SCANNED PICTURE** link.
- 4 Adjust the desired parameters and click on the **OK** button.

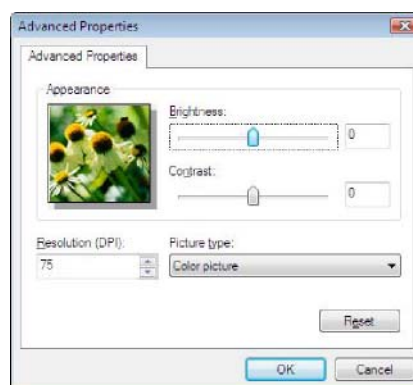

- 5 Click on the **SCAN** button, you can follow the ongoing digitisation on a screen.

## Printing

You have the possibility to print your documents via the USB connection or the WLAN connection.

During the installation of the Companion Suite Pro software, the **LASER PRO LL2** printer driver will be installed automatically onto your PC.

### Printing on the multifunction machine

Printing a document on the multifunction machine from your PC is like printing a document in Windows.

- 1 Use the **PRINT** command from the **FILE** menu of the currently open application on the screen.
- 2 Select the **LASER PRO LL2** printer.

**Printing in duplex mode with the multifunction machine**

The machine offers the possibility to print a document in manual duplex mode from your PC.

**In manual duplex, the print quality and paper transport are not guaranteed.**

**- If some trouble occurred to the paper during the print of the first side, such as wrinkle, dog ear or staple, do not use the paper for manual duplex.**

**- When you load paper, please true up the end of paper on a flat surface.**

**For best results, we recommend that you use 80 g/m<sup>2</sup> A4 paper or 20 lbs/m<sup>2</sup> Letter paper.**



To print a document in manual duplex mode:



*The duplex printing mode is available only in a paper format managed by the paper tray. The manual tray cannot be used to print in duplex mode.*

- 1 Use the **PRINT** command from the **FILE** menu of the currently open application on the screen.
- 2 Select the **LASER PRO LL2** printer.
- 3 Check the **Duplex** box and choose among the two binding modes:

Binding mode	Printing
Long sides	
Short sides	

- 4 Click on the **OK** button to begin printing.
- 5 The machine prints the odd pages (from the higher odd page to page 1) and the LCD screen displays:

**\*\* PRINTING \*\***  
**\*\* PC \*\***

- 6 Once the odd pages are printed, the LCD screen displays the message **\*\*PUT THE PRINTED SHEETS IN THE PAPER TRAY WITH THE PRINTED SIDE VISIBLE...:**

**\*\* PUT THE PRIN**  
**... AND PRESS <OK>**



*The PC generates and prints a page explaining how to reload the sheets for a duplex job. Read this page carefully and place it back with the other sheets.*

*it is very important that you return the explanation sheet to the paper tray to continue printing correctly.*

- 7 Place the sheets in the paper tray as indicated on the explanation page and below. The following illustrations describe the necessary operations depending on the selected binding mode:

- Long sides

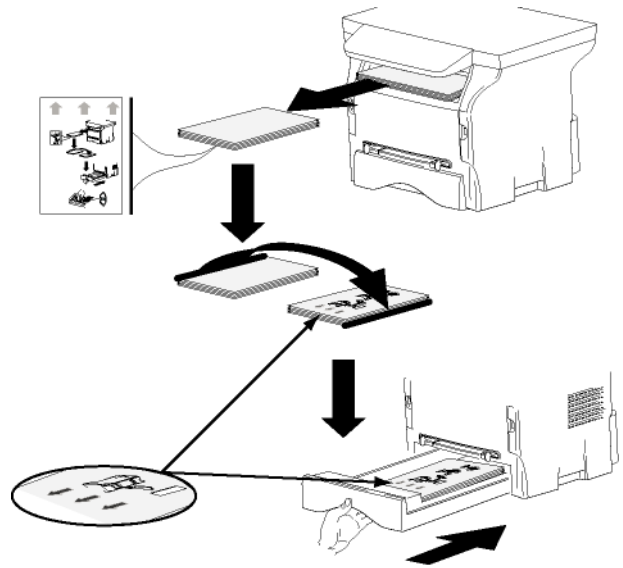

- Short sides

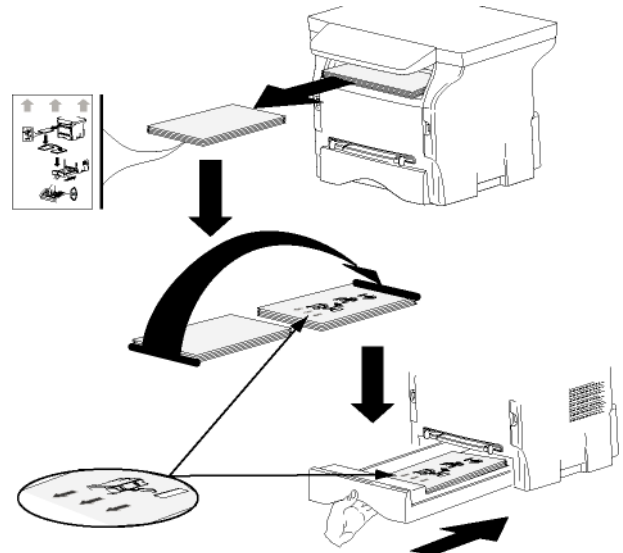

- 8 Press **OK** on the command panel to resume printing.
- 9 Even pages are printed on the other side of the sheets. Once all pages are printed, remove the explanation sheet.



*If a paper jam or a paper format error occurs, the job is cancelled. You must then resubmit the print job.*

## Software Uninstallation

This section describes the following procedures:

- full uninstallation of the Companion Suite Pro software,
- uninstallation of the drivers only.

### Uninstall the software from your PC

Turn your PC on. Open an account session with the administration rights.

Run the programs removal from the menu **START > ALL PROGRAMS > COMPANION SUITE > COMPANION SUITE PRO LL2 > UNINSTALL**.

- 1 A confirmation screen appears. Click on the **YES** button to continue the Companion Suite Pro program removal.

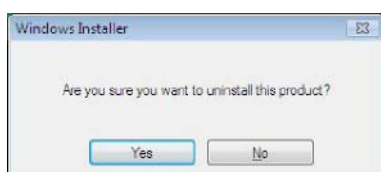

- 2 The uninstall program is launched. You can cancel the removal by clicking on **CANCEL**.

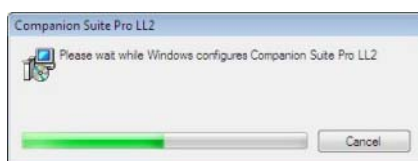

- 3 Click on the **OK** button.



- 4 You need to restart your system at the end of the procedure. Click on the **YES** button.



### Uninstall the drivers from your PC

Turn your PC on. Open an account session with the administration rights.

Depending on the installation mode used, select the required uninstallation mode:

- If you have installed the drivers with the Companion Suite Pro software, see paragraph Uninstall the drivers using the Companion Suite Pro software.
- If you have installed the drivers manually, see paragraph Uninstall the drivers manually.

### Uninstall the drivers using the Companion Suite Pro software

Run the programs removal from the menu **START > ALL PROGRAMS > COMPANION SUITE > COMPANION SUITE PRO LL2 > UNINSTALL**.



#### Note

You can also uninstall **COMPANION SUITE PRO LL2** drivers using the Windows function **ADD/REMOVE PROGRAMS** from the control panel.

- 1 A confirmation screen appears. Click on the **YES** button to continue the **COMPANION SUITE PRO LL2** drivers program removal.

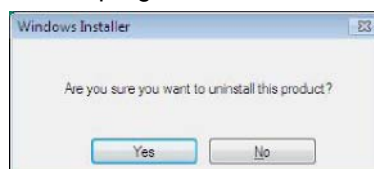

- 2 The uninstall program is launched. You can cancel the removal by clicking on **CANCEL**.

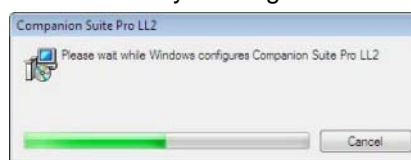

### Uninstall the drivers manually

The following drivers must be removed:

- print driver
- scan driver
- modem driver

To remove the print driver:

- 1 Open the **PRINTERS** window (**START > CONTROL PANEL > PRINTERS AND FAXES** or **START > CONTROL PANEL > HARDWARE AND SOUND > PRINTERS**, depending on the operating system).
- 2 Delete the **LASER PRO LL2** icon.
- 3 In the **PRINTERS** window, right-click with the mouse and select **RUN AS ADMINISTRATOR > SERVER PROPERTIES**.
- 4 Select the **DRIVERS** tab.
- 5 Select the **LASER PRO LL2** driver and click on the **REMOVE** button.

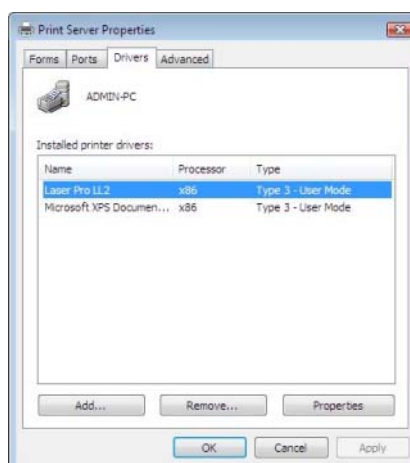

- 6 Select the option **REMOVE DRIVER AND DRIVER PACKAGE** and click on the **OK** button.



- 7 A confirmation screen appears. Click on the **YES** button to continue.
- 8 Click on the **DELETE** button to confirm the removal.

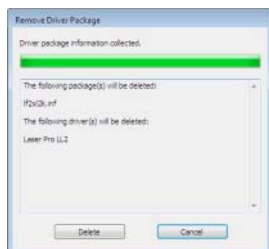

To remove scan and modem drivers:

- 1 Open the **DEVICE MANAGER** window (**START >CONTROL PANEL > SYSTEM > HARDWARE > DEVICE MANAGER** or **START >CONTROL PANEL > HARDWARE AND SOUND > DEVICE MANAGER**, depending on the operating system).

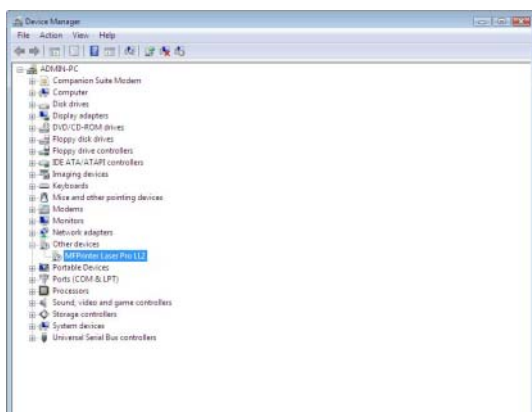

- 2 In the **OTHER DEVICES** sub-menu, select the **MF PRINTER LASER PRO LL2** item and click on the right button of the mouse.
- 3 Select **UNINSTALL** on the menu and left-click with the mouse.



- 4 Click on the **OK** button to confirm the removal.
- 5 In the **IMAGING DEVICES** sub-menu, select the **SCANNER PRO LL2** item and right-click with the mouse.
- 6 Select **UNINSTALL** on the menu and left-click with the mouse.
- 7 Click on the **OK** button to confirm the removal.



# Maintenance

## Service

### General information



#### CAUTION

For your safety, it is imperative to refer to the security directives presented in chapter **Security**, page 1.

To ensure that your machine is kept in the best conditions, it is recommended that you periodically clean the inner parts.

Please respect the following rules while using this machine:

- Do not leave the scanner cover open.
- Do not try to lubricate the device.
- Do not close the scanner cover violently or do not apply vibrations to the machine.
- Do not open the cartridge access cover while printing.
- Do not try to disassemble the machine.
- Do not use paper which has stayed in the tray for too long.

### Toner cartridge replacement

Your machine comes with a current consumable management system. It tells you if your toner cartridge is close to its end of cycle.

The following messages will appear on your machine screen when the toner cartridge reaches the critical threshold (less than 10% toner cartridge left) and when it is empty:

**TONER NEAR  
END**

**TONER EMPTY  
REPLACE <OK>**

You can however change the toner cartridge at any time, before it reaches its end of cycle.



#### Important

Always use the smart card provided when replacing the toner cartridge. The smart card contains the information necessary to reset the level of toner. Replacing the toner cartridge without using a smart card may result in the consumable management system being inaccurate.

To replace the toner cartridge, proceed as shown below.

- 1 Insert the smart card provided with the new toner cartridge as shown on the picture below.

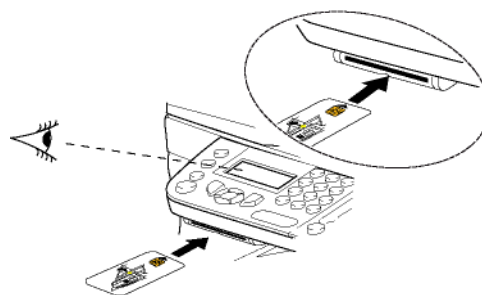

The following message appears:

**CHANGE TONER?  
YES=OK - NO=C**

- 2 Press **OK**.

The following message appears:

**OPEN FRONT COVER  
REPLACE TONER**

- 3 Stand in front of the device.
- 4 Push on the left and right sides of the cover and pull it towards you.
- 5 Raise and remove the toner cartridge from the machine.
- 6 Unpack the new cartridge and insert it into the slot as indicated in the diagram below.

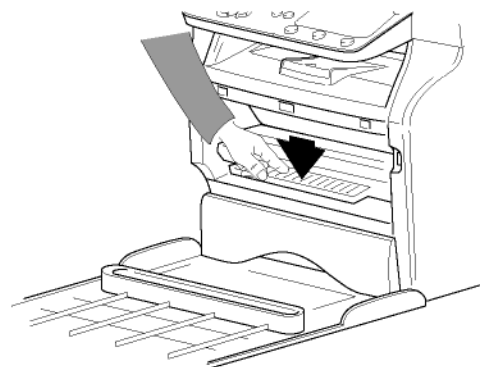
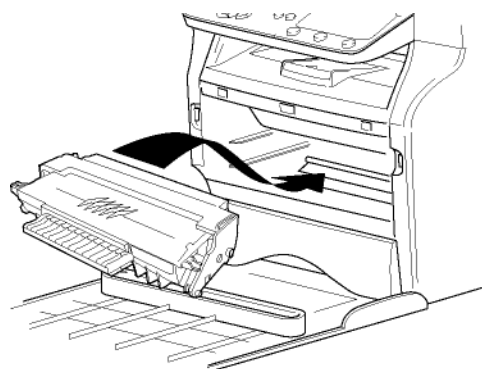

- 7 Close the cover.

The following message appears:

**HAVE YOU CHANGED  
THE TONER? <OK>**

- 8 Press **OK**.

A wait message appears.

**PLEASE  
WAIT**

The smart card is read.

**NEW TONER  
REMOVE CARD**

- 9 Remove the smart card from the reader, your machine is ready to print again.

### Issues with smart cards

If you use a smart card that has already been used, the machine will display:

**PLEASE  
WAIT**

then,

**REMOVE CARD  
ALREADY USED**

If you use a defective smart card, the machine will display:

**PLEASE  
WAIT**

then,

**UNKNOWN CARD  
REMOVE CARD**

If the **C** button is pressed while the smart card is being read, the machine displays:

**ACTION CANCELLED  
REMOVE CARD**

## Cleaning

### Scanner reading system cleaning

When one or more vertical lines appear on the copies, clean the glass of the scanner.

- 1 Open the scanner cover until it is standing in vertical position.
- 2 Wipe the glass with a soft lint-free cloth soaked with mild alcohol.
- 3 Close the scanner cover.
- 4 Make a copy to check that the symptoms have disappeared.

### Printer cleaning

Dust, dirtiness and paper debris on the external and internal surfaces of the printer can affect its operation. We advise that it is cleaned regularly.

### Printer external cleaning

Clean the external part of the printer with a soft cloth soaked in mild detergent.

## Printer issues

### Error messages

When the printer encounters any of the problems described below, the corresponding message is shown on the machine display.

Message	Action
<b>CHECK TONER</b>	Check the presence of a toner cartridge in the machine.
<b>TONER NEAR END</b>	Indicates that your consumable will need changing soon.
<b>REPLACE PAPER</b>	Add paper in tray.
<b>HEATING</b>	Message displayed when starting the machine.
<b>CLOSE COVER PRINTER</b>	The printer front cover is open, close it.
<b>TONER EMPTY REPLACE &lt;OK&gt;</b>	Replace the toner cartridge.
<b>PAPER JAM REMOVE TONER</b>	A sheet of paper is jammed in the machine. Take out the toner cartridge and remove the jammed paper sheet. Take out the paper tray and remove the jammed paper sheet. Then open and close the consumable cover.
<b>PAPER JAM EXTERNAL TRAY</b>	A sheet of paper is jammed in the machine. Open the paper jam cover. Remove the jammed paper sheet. Then open and close the consumable cover.
<b>PAPER EMPTY</b>	Add paper in the paper tray.



#### Note

After one of the error messages listed above is displayed, it may happen that the active print job is cancelled (see **PC printing issues**, page 47).

## Paper jam

When printing, a sheet of paper may get stuck in the printer or the paper tray and cause a paper jam.

In case of a paper jam in the machine, the following message appears:

### PAPER JAM EXTERNAL TRAY

- 1 Open the paper jam cover located at the back of the machine.
- 2 Remove the jammed sheet of paper and close the cover.

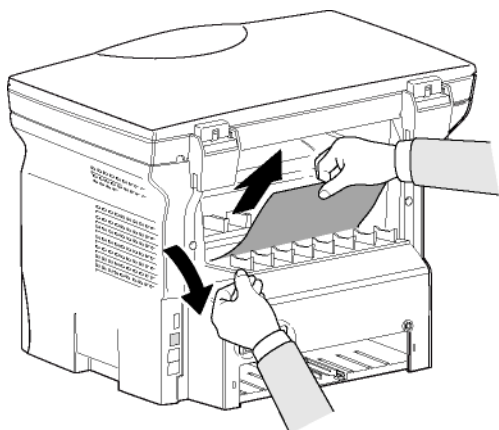

- 3 Open and close the front cover. The printer starts again automatically.



**CAUTION** The fusion unit can reach a very high temperature during the operation. To prevent any harm, do not touch this area. For details, refer to **Positions of Safety labels on the machine**, page 3.

In case of paper jam, the following message appears:

### PAPER JAM REMOVE TONER

- 1 Remove the toner cartridge and check if a sheet is jammed.
- 2 Remove the sheet of paper which causes the paper jam.
- 3 Put the toner cartridge in the machine, or remove the paper tray and remove the sheet of paper which causes the paper jam.
- 4 Check that the paper sheets in the paper tray are correctly placed.

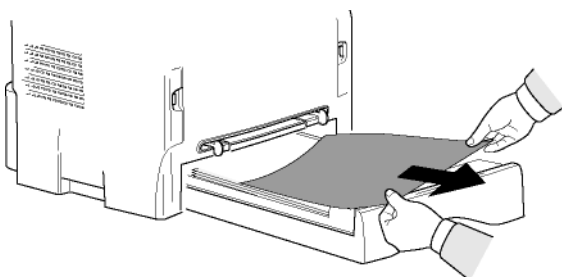

- 5 Replace the paper tray in the machine.

## PC printing issues

This section details how the machine handles a print request after having encountered an issue (paper jam, connection loss, etc.).

Refer to the sections below to know if the printing of your document will resume or will be cancelled, depending on:

- the connection to the PC,
- the problem encountered during printing.

### PC printing via USB connection

Issue encountered	Print request handling
Paper empty	Once the problem is resolved, printing resumes from the first non-printed page.
No paper feed	Once the problem is resolved, printing resumes from the first non-printed page.
Paper jam	Exception: If the document was to be printed in manual duplex mode, the printing of the document is cancelled.
Paper format problem	The printing of the active document is cancelled. Documents waiting to be printed, however, will print after the toner cartridge is replaced.
Toner empty	The machine switches to idle mode after a timeout (30 seconds by default). The printing of the active document is cancelled. Documents waiting to be printed, however, will be printed.
Pause requested from the spooler	Once the problem is resolved, the printing of the document restarts from the beginning, regardless of the number of pages already printed before the connection loss.
Loss of USB connection	

## PC printing via WLAN connection

Issue encountered	Print request handling
Paper empty	Once the problem is resolved, printing resumes from the first non-printed page.
No paper feed	Once the problem is resolved, printing resumes from the first non-printed page.
Paper jam	Exception: If the document was to be printed in manual duplex mode, the printing of the document is cancelled.
Paper format problem	Exception: If the document was to be printed in manual duplex mode, the printing of the document is cancelled.
Toner empty	The printing of the active document is cancelled. Documents waiting to be printed, however, will be printed. or Printing resumes from the first non-printed page.
Pause requested from the spooler	The machine switches to idle mode after a timeout (30 seconds by default). The printing of the active document is cancelled. Documents waiting to be printed, however, will be printed.
Loss of WLAN connection	Once the problem is resolved, the printing of the document restarts from the beginning, regardless of the number of pages already printed before the connection loss.

## Firmware update

Updating the machine firmware requires that the Companion Suite Pro software be installed on your PC, and that the PC is connected to the machine (see **PC Features**, page 34).

Then, access the update utility (**START > ALL PROGRAMS > COMPANION SUITE > COMPANION SUITE PRO LL2 > COMPANION - FIRMWARE UPDATE**), select the downloaded file and launch the update..

## Specifications

---

### Physical specifications

---

Dimensions:	344 x 447 x 386 mm
Weight:	11.6 kg

### Electrical specifications

---

Power supply (see rating plate):	Single phase 220-240 V - 50/60 Hz - 4.5 A
Electric consumption:	10 W typical in powersave 33 W typical in standby 450 W average during printing (900W peak)

### Environmental specifications

---

Operating temperature:	10 °C to 27 °C [50 °F to 80.6 °F] with an ambient humidity included between 15 to 80% (up to 32°C [89.6 °F] with an ambient humidity included between 15 to 54%)
------------------------	--

### Peripheral specifications

---

#### Printer

Type:	Laser (on normal paper)
Resolution:	600 dpi
Speed:	20 ppm maximum <sup>a</sup>
Preheating time:	21 sec.
First page out time:	13 sec.

- a. Printing speed may vary depending on used operating systems, computer specifications, software applications, connection modes (USB or WLAN), paper formats as well as file types and sizes.

#### Copier

Type:	Autonomous Black and White
Copy speed:	20 ppm maximum
Resolution:	600 dpi
Multiple copies:	99 pages maximum
Zoom range:	25 % to 400 %

#### Scanner

Type:	Colour scanner
Colour depth:	36 bits
Resolution:	600 dpi (optical) 2400 dpi (interpolated)
Software compatibility:	TWAIN, WIA
Maximum paper format:	Letter

#### Printing supports

Main paper tray capacity:	250 sheets maximum (60 g/m <sup>2</sup> ), 200 sheets maximum (80 g/m <sup>2</sup> )
Output tray capacity:	50 sheets
Main tray paper format:	A4, A5, Statement, Legal, Letter 60 to 105 g/m <sup>2</sup> paper
Paper format for manual printing:	A4, A5, Statement, Legal, Letter, B5, exec, A6 52 to 160 g/m <sup>2</sup> paper

#### PC connection

Slave USB 2.0 port (PC connection)  
Master USB 2.0 port (Wlan connection, reader, USB memory key reader)  
Operating System: Windows 2000 ≥ SP4, Windows XP x86 ≥ SP1, Windows Vista, Windows 2003 server (for printing only)

## Consumable specifications

---

### **Reference paper**

Scanner : Inapa tecno SPEED A4  
Printer : Ricoh T6200 A4

Specifications are subject to changes for improvement without notice.