

KIVA SYSTEM KIVA SB15m USER MANUAL

VERSION 1.3

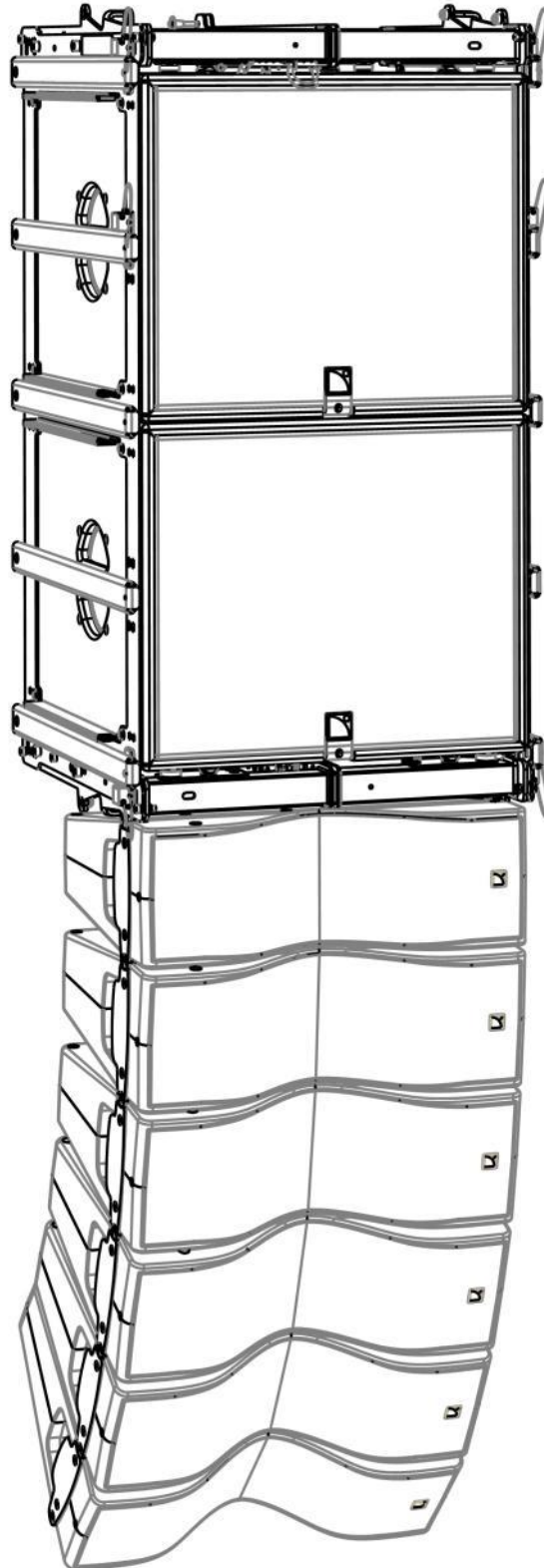

KIVA SYSTEM KIVA SB15m USER MANUAL

VERSION 1.3

SAFETY INSTRUCTIONS

1. **Read this manual**
2. **Follow all SAFETY INSTRUCTIONS as well as DANGER and OBLIGATION warnings**
3. **Never incorporate equipment or accessories not approved by L-ACOUSTICS®**
4. **Read all the related PRODUCT INFORMATION documents before exploiting the system**
The product information document is included in the shipping carton of the related system component.
5. **Read the RIGGING MANUAL before installing the system**
Use the rigging accessories described in the rigging manual and follow the associated procedures
6. **Beware of sound levels**
Do not stay within close proximity of loudspeakers in operation and consider wearing earplugs.
Loudspeaker systems are capable of producing very high sound pressure levels (SPL) which can instantaneously lead to permanent hearing damage to performers, production crew and audience members. Hearing damage can also occur with prolonged exposure to sound: 8 h at 90 dB(A), 30 min at 110 dB(A), less than 4 min at 130 dB(A).

SYMBOLS

The following symbols are used in this document:



DANGER

This symbol indicates a potential risk of harm to an individual or damage to the product.
It can also notify the user about instructions that must be strictly followed to ensure safe installation or operation of the product.



OBLIGATION

This symbol notifies the user about instructions that must be strictly followed to ensure proper installation or operation of the product.



INFORMATION

This symbol notifies the user about complementary information or optional instructions.



WELCOME TO L-ACOUSTICS®

Thank you for choosing the L-ACOUSTICS® KIVA WST® system.

This document contains essential information on using the system properly. Carefully read this document in order to become familiar with the system.

As part of a continuous evolution of techniques and standards, L-ACOUSTICS® reserves the right to change the specifications of its products and the content of its document without prior notice.

Please check the L-ACOUSTICS® web site on a regular basis to download the latest document and software updates: www.l-acoustics.com.

CONTENTS

KIVA SYSTEM	4
I SYSTEM COMPONENTS	5
1.1 Loudspeaker enclosures.....	5
1.2 Powering and driving system.....	5
1.3 Loudspeaker cables.....	5
1.4 Rigging elements.....	5
1.5 Software application.....	5
2 LOUDSPEAKER CONFIGURATIONS	7
2.1 Line source.....	7
2.2 Line source with low-frequency element.....	8
2.3 Line source element.....	10
2.4 Line source element with low-frequency element.....	11
3 LOUDSPEAKER CONNECTION	12
3.1 Connectors.....	12
3.2 Connection to LA4 /LA4X.....	13
3.3 Connection to LA8.....	16
APPENDIX A PRESET DESCRIPTION	20
[KIVA]	20
[KIVA_FI]	20
[KIVA_SB15]	20
[SB15_100] and [SB18_60]	20
[SB15_100_C] and [SB18_60_C]	21
APPENDIX B RECOMMENDATION FOR SPEAKER CABLES	21
APPENDIX C SPECIFICATIONS	22
KIVA	22
SB15m subwoofer	23

KIVA SYSTEM KIVA SB15m

USER MANUAL

VERSION 1.3

KIVA-SB15m SYSTEM

The KIVA-SB15m system is based on an ultra-compact WST® enclosure and a complementary subwoofer offering extended bandwidth and LF resources. Intended for rental productions and fixed installations, the KIVA-SB15m modular line source delivers remarkable acoustic properties in an unobtrusive and lightweight package and is suited to various long-throw applications, including FOH L/R systems, central clusters, distributed systems and complementary fills.

The main system components are as follows:

- KIVA, full range element, operating from 80 Hz to 20 kHz;
- SB15m, low-frequency element, operating down to 40 Hz;
- LA4, LA4X or LA8 amplified controllers.

Utilizing the unrivalled characteristics of a variable curvature WST® line source, KIVA offers a long throw capability in spite of its compact format. The sonic result is clarity, precision and a unique sensation of proximity for an incomparable listening experience.

KIVA's transducer arrangement delivers a 100°, smooth and controlled horizontal directivity pattern with a homogeneous tonal balance, a feature particularly valuable since most of a given audience is located off-axis. With variable inter-element angles from 0° to 15°, a KIVA line source allows matching any audience geometry, from narrow sectors to an extensive vertical coverage.

In standalone configuration, KIVA is particularly suited to distributed applications, as a main or complementary system. Its ultra-compact size and low weight complies with rigging and visual constraints found in historical buildings, theatres, broadcast productions and corporate events.

By adjusting the number of SB15m subwoofers, the LF resources are fully scalable and KIVA can be deployed as a FOH system with an extended operating bandwidth and an LF impact typical of today's music. The various system configurations offered to the sound designer and system engineer allow a high level of creative freedom. Before installation, these configurations can be acoustically and mechanically modeled with the SOUNDVISION 3D simulation software.

The amplified controllers offer an advanced and precise drive system for the enclosures. A factory preset library allows accommodating any application. All L-ACOUSTICS® amplified controllers feature the L-DRIVE, a thermal and over-excursion protection circuit.

Up to 253 amplified controllers can be connected together via the Ethernet-based L-NET protocol. The LA NETWORK MANAGER software allows online remote control and monitoring of all the connected units, via a user-friendly and intuitive graphic interface, and features the Array Morphing EQ. This exclusive tool allows the engineer to quickly adjust the tonal balance of the system to reach a reference curve or to ensure consistency of the sonic signature.

1 SYSTEM COMPONENTS

The system approach developed by L-ACOUSTICS® consists in offering a global solution that guarantees the highest and most predictable level of performance at any step of loudspeaker system deployment: modeling, installation, and operation. A complete L-ACOUSTICS® system includes enclosures, amplified controllers, cables, rigging system and software applications.

1.1 Loudspeaker enclosures

KIVA Main enclosure (80 Hz – 20 kHz), 2-way passive, variable curvature WST® line source element.

SB15m Subwoofer enclosure (down to 40 Hz).

SB18 Subwoofer enclosure (down to 32 Hz).



Loudspeaker system design

Sound design aspects are beyond the scope of this document. However, the various applications of the system will be based on the loudspeaker configurations presented in this document.

SB18 / SB18i / SB18m

In this document, the SB18 term and illustration refer equally to SB18, SB18i or SB18m.

1.2 Powering and driving system

LA4, LA4X Amplified controller with DSP, preset library and networking capabilities
or **LA8**



Operating instructions

Refer to the **LA4, LA4X and LA8 user manuals**.

1.3 Loudspeaker cables

DO cables (DO.7, DO10, DO25) 8-point PA-COM® loudspeaker cables.
Respective lengths of 0.7 m/2.3 ft, 10 m/32.8 ft, and 25 m/82 ft.

DOSUB-LA8 Breakout cable for four passive enclosures.
8-point PA-COM® to 4 × 2-point SpeakON®.

SP cables (SP.7, SP5, SP10, SP25) 4-point SpeakON® loudspeaker cables.
Respective lengths of 0.7 m/2.3 ft, 5 m/16.4 ft, 10 m/32.8 ft and 25 m/82 ft.

SP-Y1 Breakout cable for two passive enclosures.
4-point SpeakON® to 2 × 2-point SpeakON®.
Provided with CC4FP adapter.



Information about the connection of the enclosures to the LA amplifiers is given in this document.

Refer to the **LA4, LA4X and LA8 user manuals** for detailed instructions about the whole cabling scheme, including modulation cables and network.

1.4 Rigging elements



Rigging elements or procedures are not presented in this document.

Refer to the **KIVA system rigging manual**.

1.5 Software application

SOUNDVISION Proprietary acoustical and mechanical 3D modeling software.

LA NETWORK MANAGER Remote control and monitoring of amplified controllers.

KIVA SYSTEM KIVA SB15m USER MANUAL

VERSION 1.3



Using L-ACOUSTICS® software

Refer to the **SOUNDVISION** user manual and the **LA NETWORK MANAGER** tutorial.



KIVA



SB15m



LA4



LA4X



LA8



DO.7



DO10



DO25



DOSUB-LA8



SPY1



CC4FP



SP7



SP5



SP10



SP25



Soundvision



LA Network Manager

KIVA system components (excluding rigging elements and modulation cables)

2 LOUDSPEAKER CONFIGURATIONS

2.1 Line source

In this configuration – where a KIVA line source is used without complementary subwoofers – the system operates over the nominal bandwidth of the enclosure.

The [KIVA] preset allows for a reference frequency response in medium to long throw applications.

This configuration is driven by the LA4, LA4X or LA8 amplified controller.

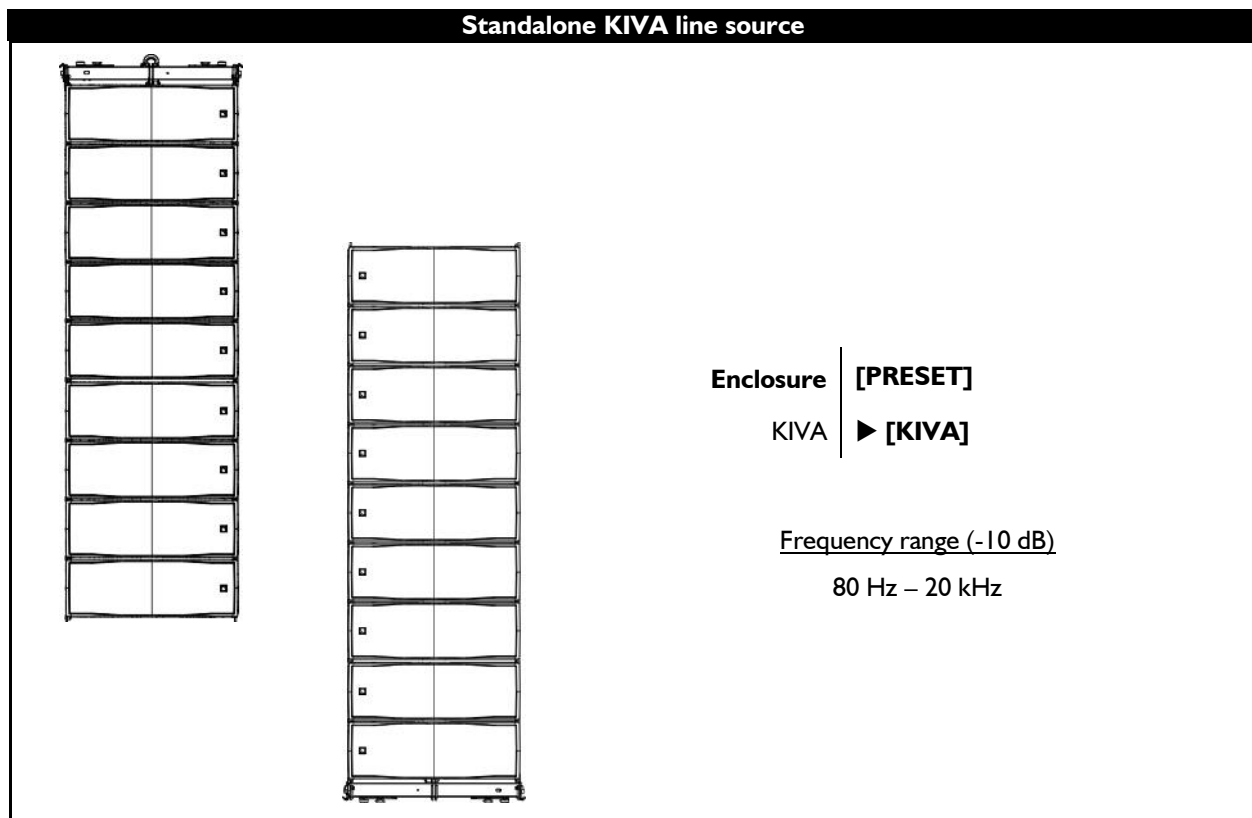

KIVA SYSTEM KIVA SB15m USER MANUAL

VERSION 1.3

2.2 Line source with low-frequency element

In this configuration – where a KIVA line source is used with SB15m subwoofers and optional SB18 subwoofers – the bandwidth of the KIVA system is extended in the low-end and the LF contour is reinforced.

The [KIVA] preset allows for a reference frequency response in medium to long throw applications.

The [SB15_100] preset provides a 100 Hz upper frequency limit for the SB15m.

The [KIVA_SB15] preset combines the [KIVA] and [SB15_100] presets to facilitate the use of this configuration.

The [SB18_60] preset provides a 60 Hz upper frequency limit for the SB18.

This configuration is driven by the LA4, LA4X or LA8 amplified controller. When using the [KIVA_SB15] hybrid preset, additional SB18 subwoofers must be driven by another amplified controller.

KIVA line source + coupled SB15m

<p style="text-align: center;"><u>Frequency range (-10 dB)</u></p> <p style="text-align: center;">40 Hz – 20 kHz</p> <p style="text-align: center;"><u>Recommended ratio</u></p> <p style="text-align: center;">3 KIVA: 1 SB15m for a reinforced contour or 6 KIVA: 1 SB15m for a flat contour</p> <p style="text-align: center;"><u>Limits for close coupling</u></p> <p style="text-align: center;">Maximum for mixed main/sub line: 12 KIVA + 4 SB15m Maximum distance between adjacent main/sub lines: 1.35 m</p>	<table style="width: 100%; border-collapse: collapse;"> <tr> <td style="border-right: 1px solid black; padding: 5px;">Enclosure</td> <td style="padding: 5px;">[PRESET]</td> </tr> <tr> <td style="border-right: 1px solid black; padding: 5px;">KIVA</td> <td style="padding: 5px;">▶ [KIVA]</td> </tr> <tr> <td style="border-right: 1px solid black; padding: 5px;">SB15m</td> <td style="padding: 5px;">▶ [SB15_100]</td> </tr> <tr> <td style="border-right: 1px solid black; padding: 5px; text-align: center;">or</td> <td></td> </tr> <tr> <td style="border-right: 1px solid black; padding: 5px;">KIVA + SB15m</td> <td style="padding: 5px;">▶ [KIVA_SB15]</td> </tr> </table>	Enclosure	[PRESET]	KIVA	▶ [KIVA]	SB15m	▶ [SB15_100]	or		KIVA + SB15m	▶ [KIVA_SB15]
Enclosure	[PRESET]										
KIVA	▶ [KIVA]										
SB15m	▶ [SB15_100]										
or											
KIVA + SB15m	▶ [KIVA_SB15]										



Delay settings

When combining a line source with subwoofers, delays may have to be added to the presets.

Refer to the **PRESET GUIDE** to obtain the pre-alignment delay values.

The [KIVA_SB15] hybrid preset does not allow the independent definition of parameters (gain, delay, etc.) for different output channels.

When different parameters need to be defined for different channels, it is necessary to build a custom preset with the [KIVA] and [SB15_100] presets. Refer to the **LA NETWORK MANAGER tutorial** for detailed instructions



Use [SBxx_xx_C] with a SB subwoofer array in cardioid configuration

The cardioid configuration consists in reversing 1 element in an array of 4 subwoofers.

Refer to the SBxx **user manual** for details about the *Cardioid configuration*.

KIVA line source + coupled SB15m + SB18

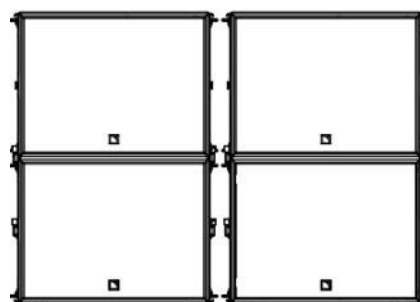
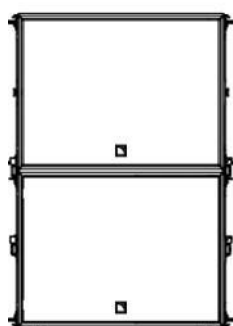

Enclosure	[PRESET]
KIVA	▶ [KIVA]
SB15m	▶ [SB15_100]
SB18	▶ [SB18_60]

or

KIVA +SB15m	▶ [KIVA_SB15]
SB18	▶ [SB18_60]

Frequency range (-10 dB)

32 Hz – 20 kHz

Recommended ratio

3 KIVA: 1 SB15m: 1 SB18



Delay settings

When combining a line source with subwoofers, delays may have to be added to the presets. Refer to the **PRESET GUIDE user manual** to obtain the pre-alignment delay values.

The [KIVA_SB15] hybrid preset does not allow the independent definition of parameters (gain, delay, etc.) for different output channels.

When different parameters need to be defined for different channels, it is necessary to build a custom preset with the [KIVA] and [SB15_100] presets.

Refer to the **LA NETWORK MANAGER tutorial** for detailed instructions



Use [SBxx_xx_C] with a SB subwoofer array in cardioid configuration

The cardioid configuration consists in reversing 1 element in an array of 4 subwoofers.

Refer to the SBxx **user manual** for details about the *Cardioid configuration*.

KIVA SYSTEM KIVA SB15m USER MANUAL

VERSION 1.3

2.3 Line source element

In this configuration – where one or two KIVA enclosures are used without complementary subwoofers – the system operates over the nominal bandwidth of the enclosure.

The [KIVA_FI] preset allows for a reference frequency response in short throw applications.

This configuration is driven by the LA4, LA4X or LA8 amplified controller.

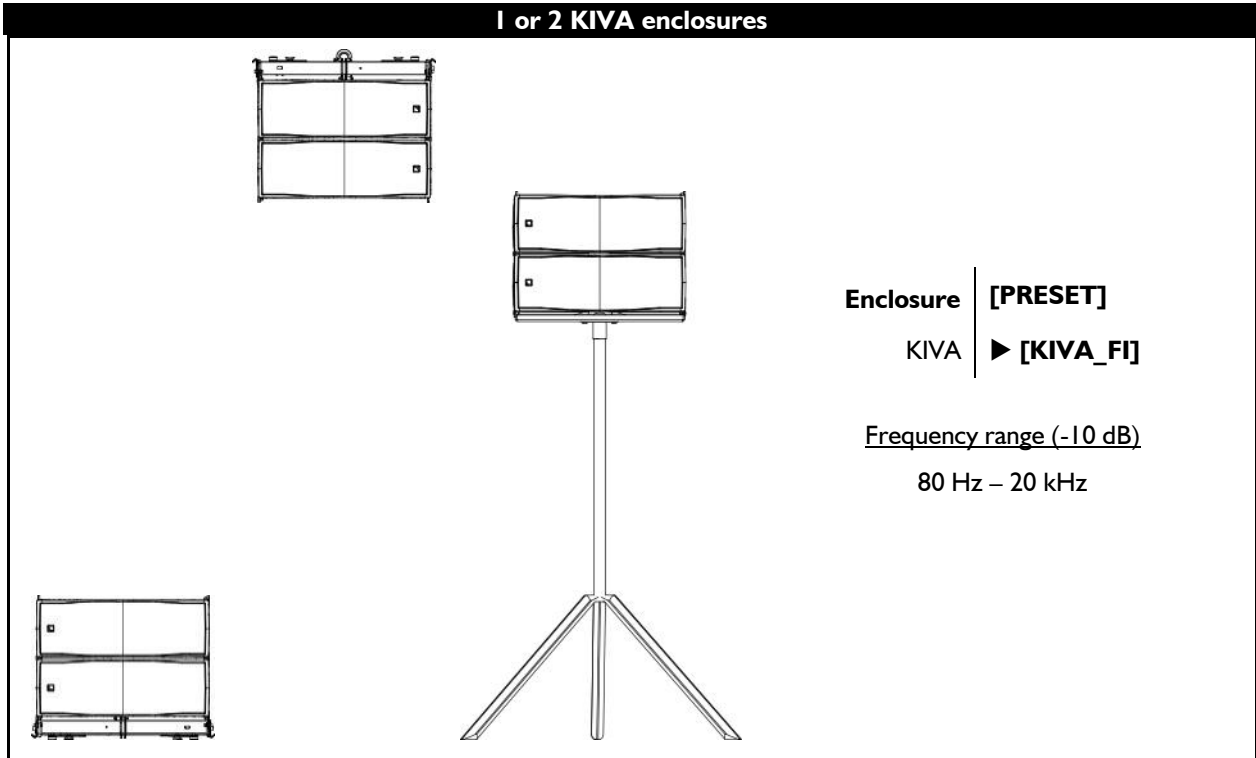

2.4 Line source element with low-frequency element

In this configuration – where one or two KIVA enclosures are used with a complementary subwoofer – the bandwidth of the KIVA system is extended in the low-end and the LF contour is reinforced.

The [KIVA_FI] preset allows for a reference frequency response in short throw applications.

The [SB15_100] preset provides a 100 Hz upper frequency limit for the SB15m.

This configuration is driven by the LA4, LA4X or LA8 amplified controller.

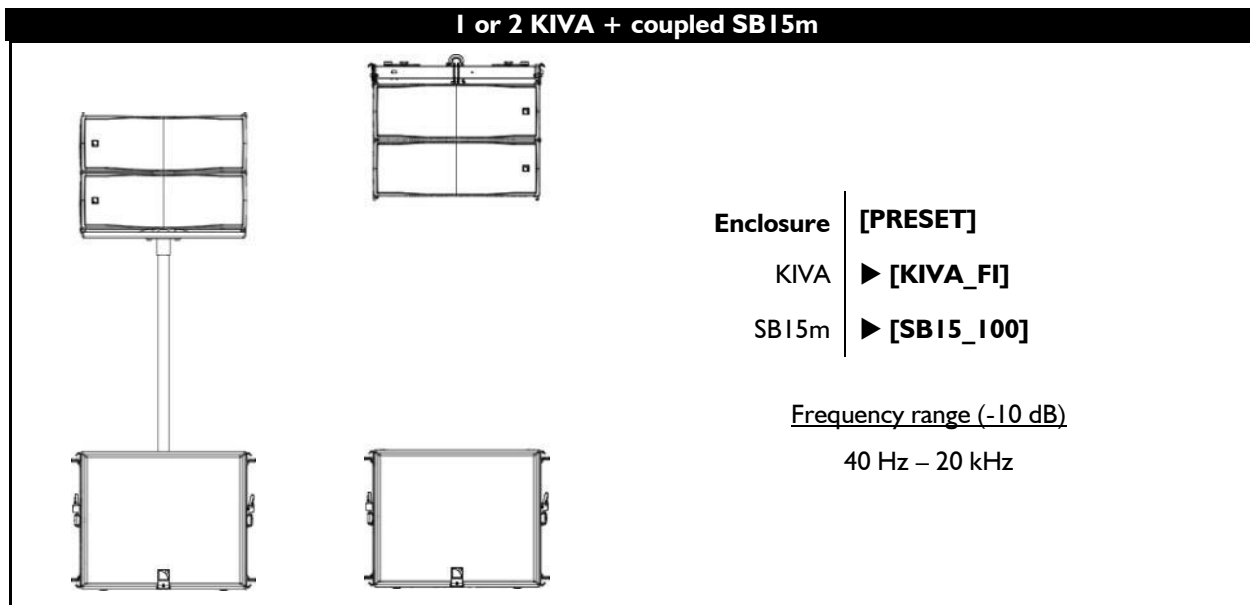

Delay settings

When combining a line source with subwoofers, delays may have to be added to the presets.

Refer to the **PRESET GUIDE** to obtain the pre-alignment delay values.

Refer to the **LA NETWORK MANAGER tutorial** for detailed instructions

Use [SBxx_xx_C] with a SB subwoofer array in cardioid configuration

The cardioid configuration consists in reversing 1 element in an array of 4 subwoofers.

Refer to the **SBxx user manual** for details about the *Cardioid configuration*.

KIVA SYSTEM KIVA SB15m USER MANUAL

VERSION 1.3

3 LOUDSPEAKER CONNECTION

3.1 Connectors

The KIVA enclosure and SB15m subwoofer are equipped with two 4-point SpeakON® connectors wired in parallel. The IN connector allows receiving the audio signal and the LINK connector allows routing it to another similar enclosure in parallel.

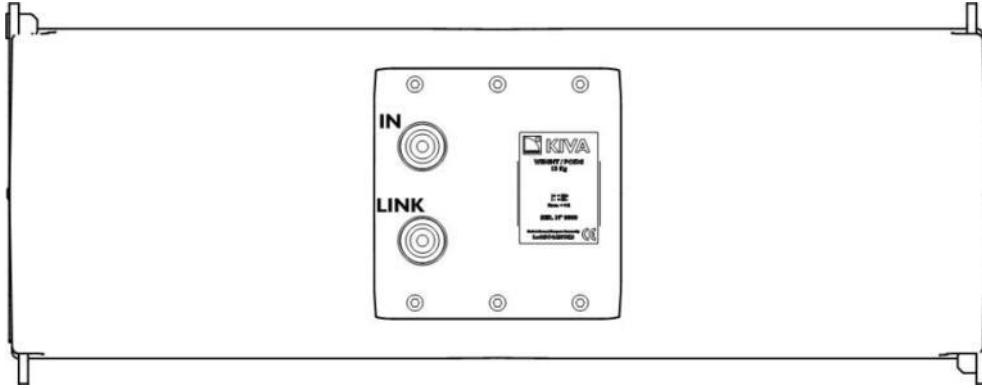

i Internal pinout for L-ACOUSTICS® KIVA enclosures.

SpeakON® points	1 +	1 -	2 +	2 -
Transducer connectors	IN+	IN-	Not used	Not used

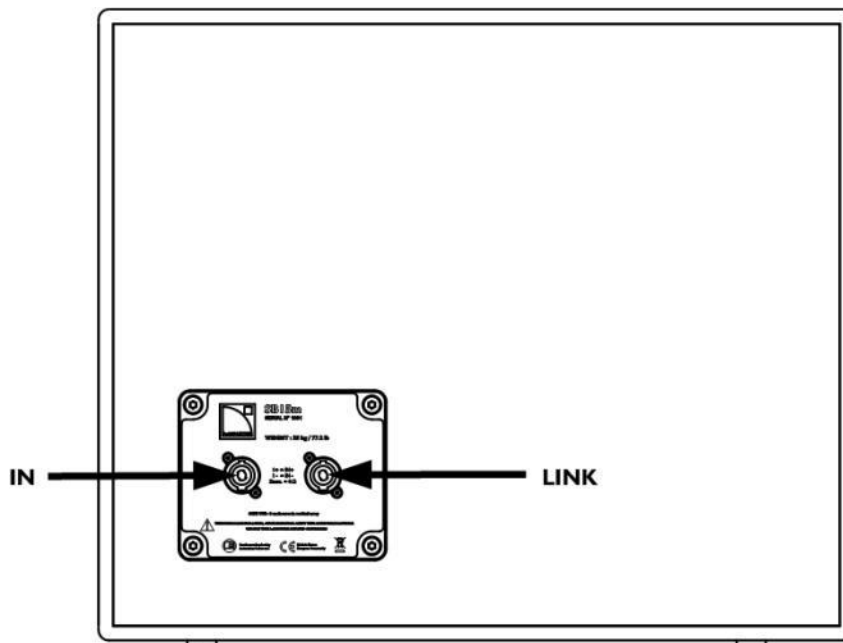

! The SB15m connection in parallel is only possible with the LA8 amplified controller.

i Internal pinout for L-ACOUSTICS® SB15m enclosures.

SpeakON® points	1 +	1 -	2 +	2 -
Transducer connectors	LF+	LF -	Not used	Not used

3.2 Connection to LA4 /LA4X



Maximum number of enclosures per LA4 /LA4X

Two KIVA or one SB15m can be connected to each output channel on the LA4 /LA4X. Therefore, a single LA4 / LA4X amplified controller can drive up to:

- 8 × KIVA or
- 4 × SB15m or
- 6 × KIVA and 1 × SB15m.



Cardioid configuration

Connect the reversed subwoofer(s) to OUT 1 to use the cardioid preset.

SB15m subwoofer on OUT1 in hybrid configuration

Always connect the SB15m subwoofer to OUT1 when you use the [KIVA_SB15] preset.



1 enclosure 2 enclosures (only for KIVA)

8 Ω

4 Ω

SB18 connection

SB15m and SB18 subwoofers follow the same cabling schemes.

Option A

- ▶ Use **SP cables** (SP.7, SP5, SP10 or SP25) to connect first enclosures to the four LA4 /LA4X output channels.
- ▶ If necessary, use **SP cables** to connect additional KIVA enclosures in parallel with the first ones.

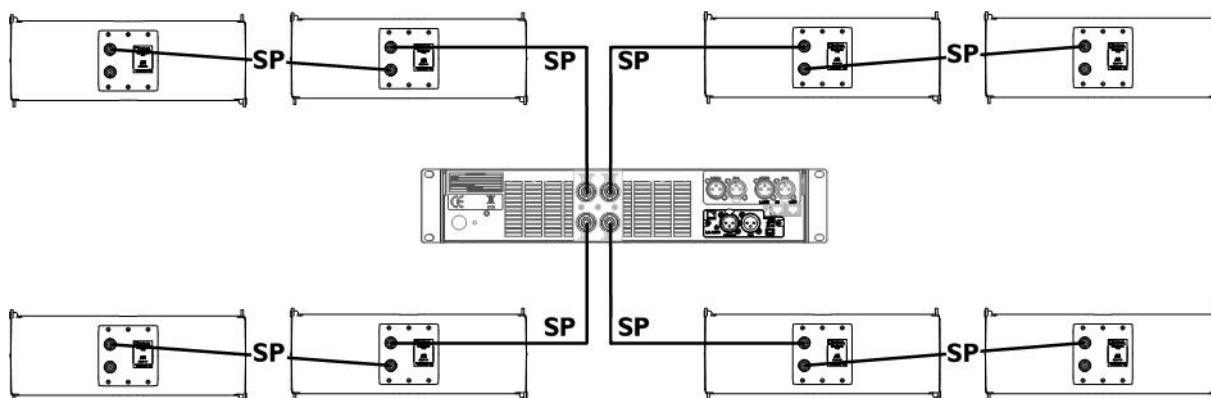

LA4 /LA4X option A maximum configuration with KIVA

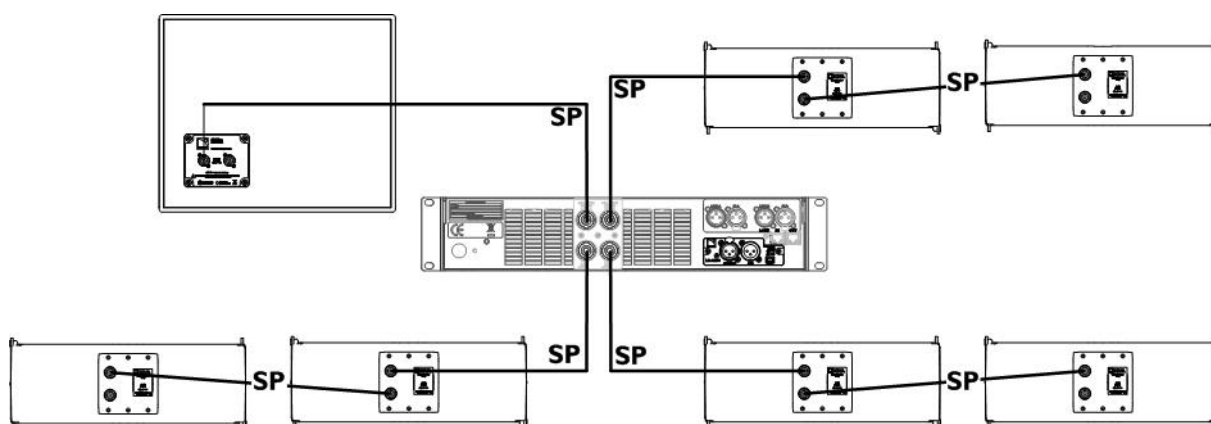

LA4 /LA4X option A maximum configuration with KIVA + SB15m

KIVA SYSTEM KIVA SB15m USER MANUAL

VERSION 1.3

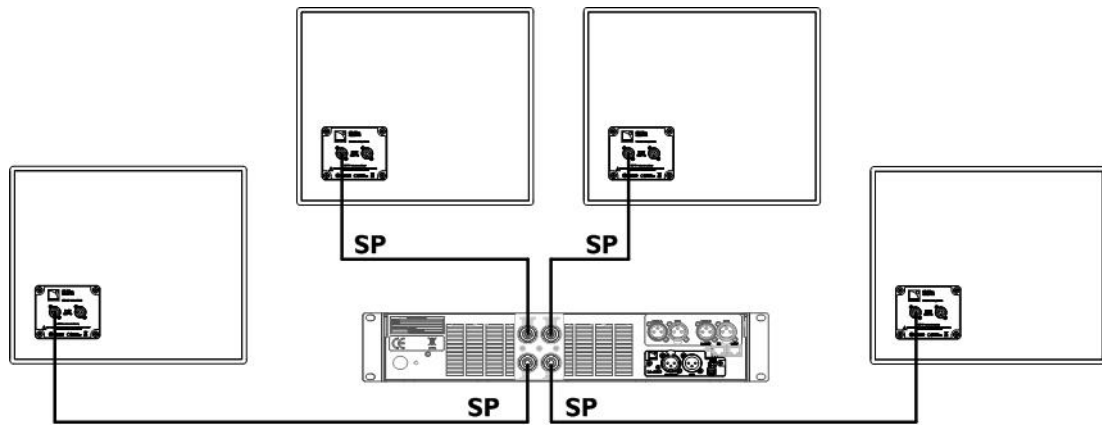

LA4 /LA4X option A maximum configuration with SB15m

Option B

- ▶ Connect an **SP cable** (SP.7, SP5, SP10 or SP25) to the OUT1/OUT2 and OUT3/OUT4 connectors of the LA4 / LA4X.
- ▶ Use a **CC4FP adapter** to connect an **SP-YI cable** and separate the two output channels.
- ▶ If necessary, use **SP cables** to connect additional KIVA enclosures in parallel with the first ones.

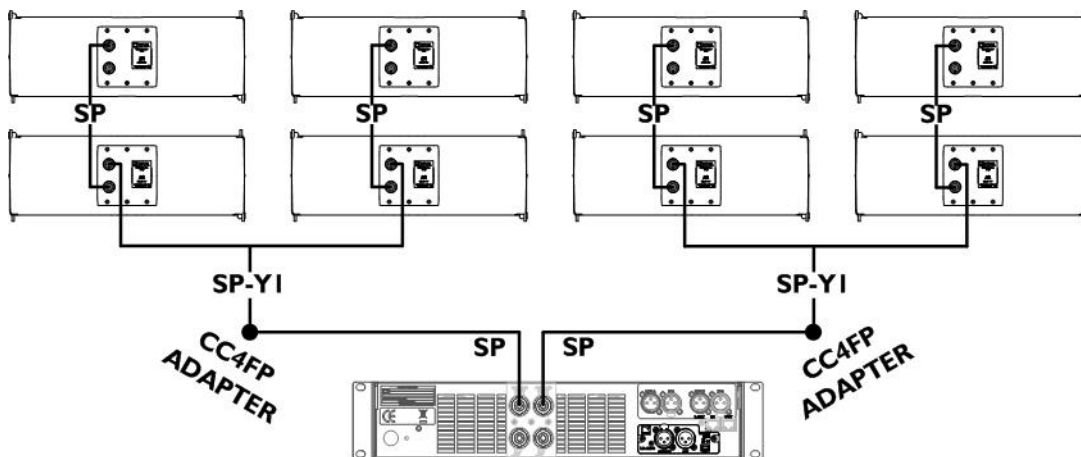

LA4 /LA4X option B maximum configuration with KIVA

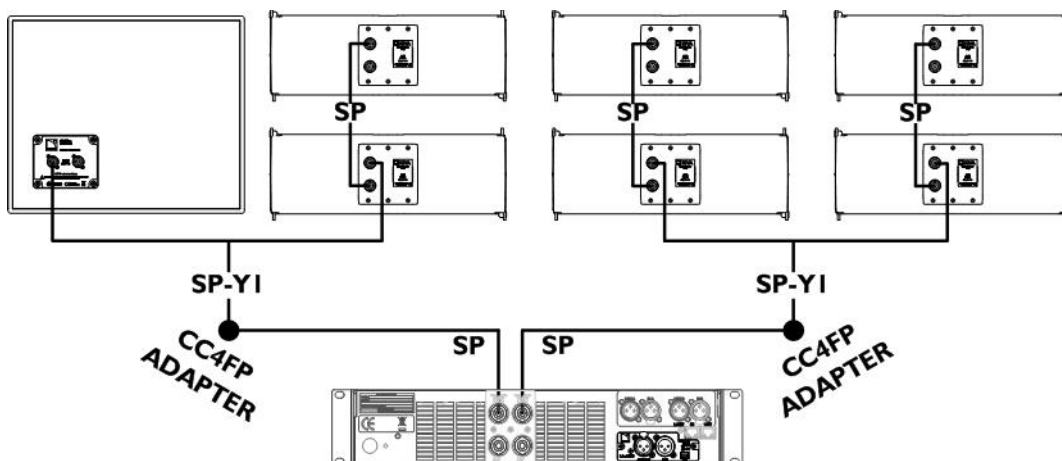

LA4 /LA4X option B maximum configuration with KIVA + SB15m

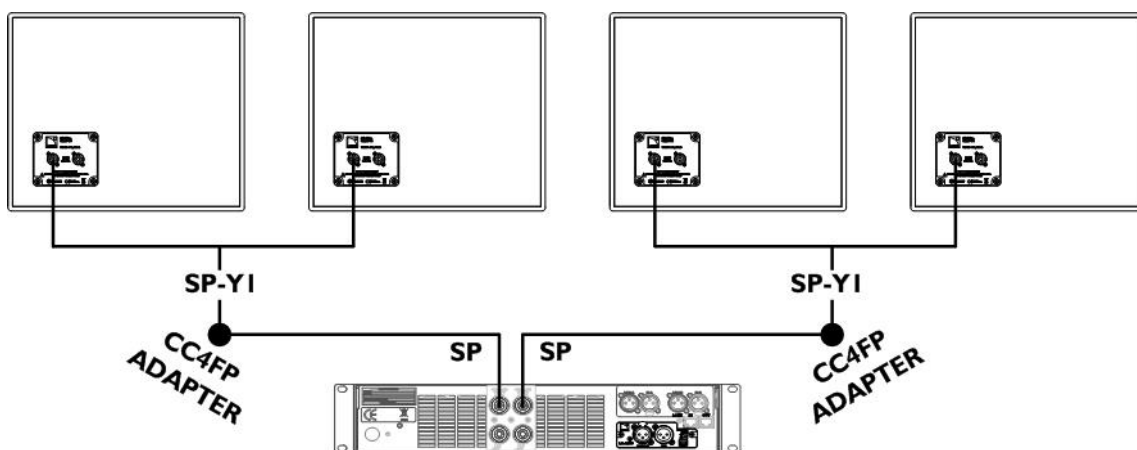

LA4 /LA4X option B maximum configuration with SB15m

KIVA SYSTEM KIVA SB15m USER MANUAL

VERSION 1.3

3.3 Connection to LA8



Maximum number of enclosures per LA8

Three KIVA or two SB15m can be connected in parallel to each output channel on the LA8. Therefore, a single LA8 amplified controller can drive up to:

- 12 × KIVA or
- 8 × SB15m or
- 9 × KIVA and 2 × SB15m.



Cardioid configuration

Connect the reversed subwoofer(s) to OUT 1 to use the cardioid preset.

SB15m subwoofer on OUT1 in hybrid configuration

Always connect the SB15m subwoofer to OUT1 when you use the [KIVA_SB15] preset.



1 enclosure	2 enclosures	3 enclosures (only for KIVA).
8 Ω	4 Ω	2.7 Ω



Impedance load

8 Ω for 1 enclosure, 4 Ω for 2 enclosures, 2.7 Ω for 3 enclosures (only for KIVA).

SB18 connection

SB15m and SB18 subwoofers follow the same cabling schemes.

Option A

- ▶ Connect a **DO cable** (DO.7, DO10 or DO25) to the LA8 PA-COM[®] connector
- ▶ Use the **DOSUB-LA8** to separate the four output channels.
- ▶ If necessary, use **SP cables** to connect additional similar enclosures in parallel with the first ones.



Corresponding DOSUB-LA8 SpeakON[®] points and LA8 output channels:

SPK1 = OUT 1	SPK3 = OUT 3
SPK2 = OUT 2	SPK4 = OUT 4

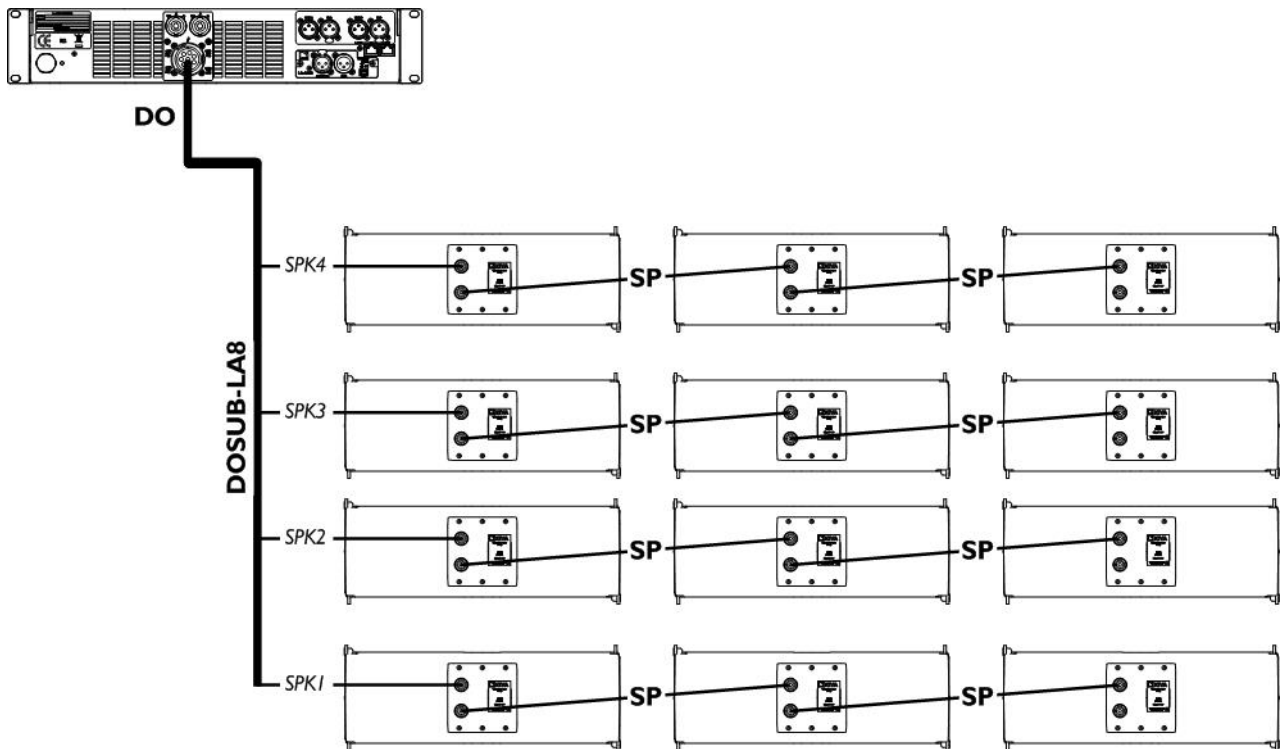

LA8 option A maximum configuration with KIVA

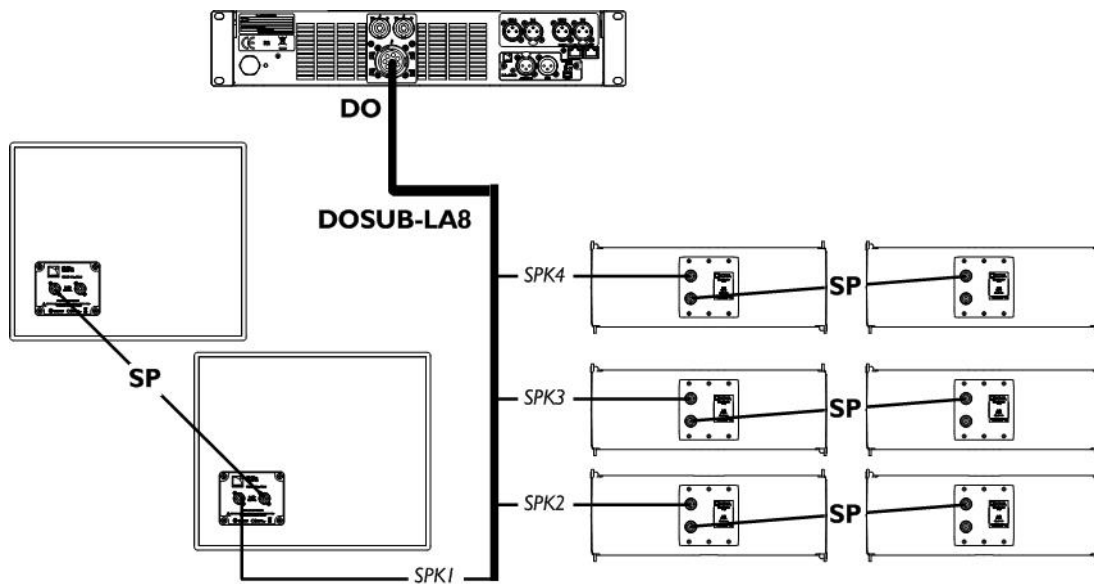

LA8 option A with KIVA + SBI5m

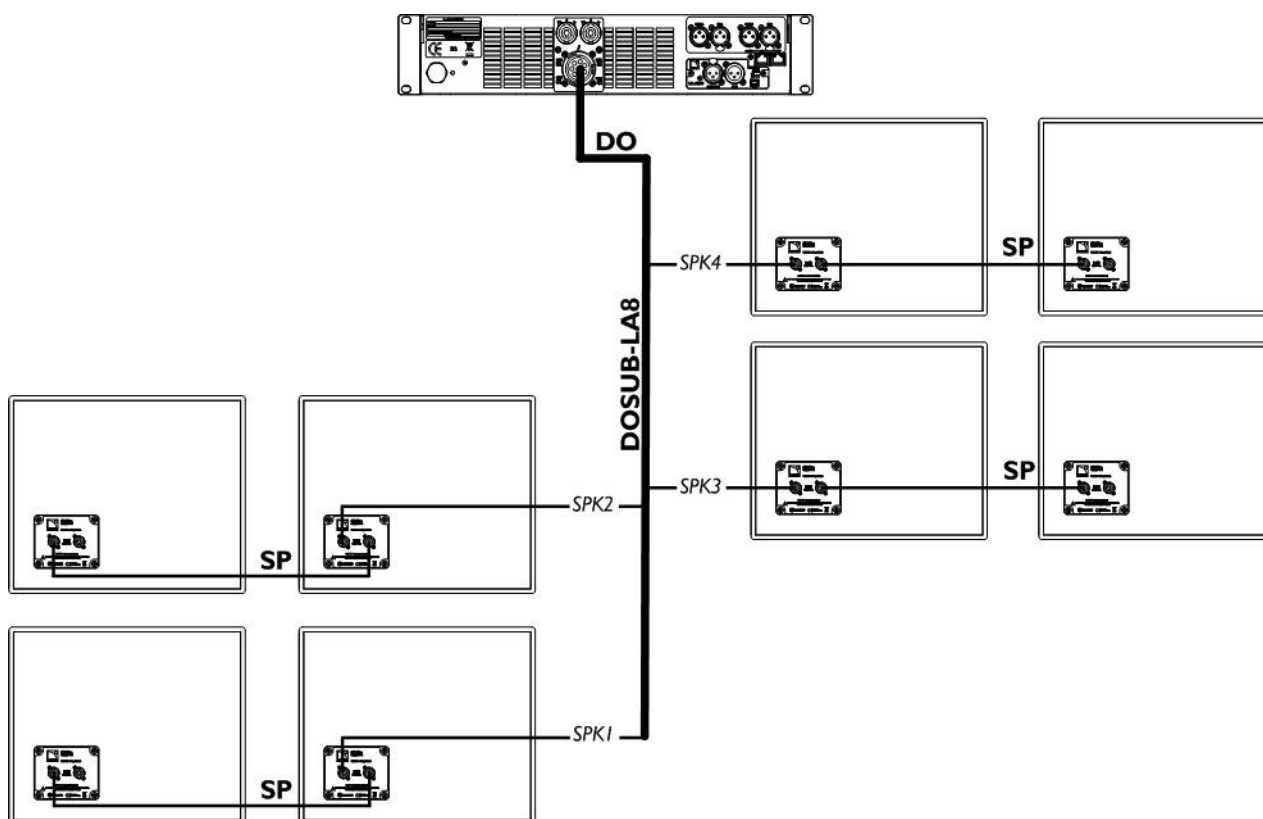

LA8 option A maximum configuration with SBI5m

KIVA SYSTEM KIVA SB15m USER MANUAL

VERSION 1.3

Option B

- ▶ Connect an **SP** cable (SP.7, SP5, SP10 or SP25) to the OUT1/OUT2 and OUT3/OUT4 LA8 SpeakON® connectors.
- ▶ Use a **CC4FP adapter** to connect an **SP-YI** cable and separate the two output channels.
- ▶ If necessary, use **SP cables** to connect additional similar enclosures in parallel with the first ones.

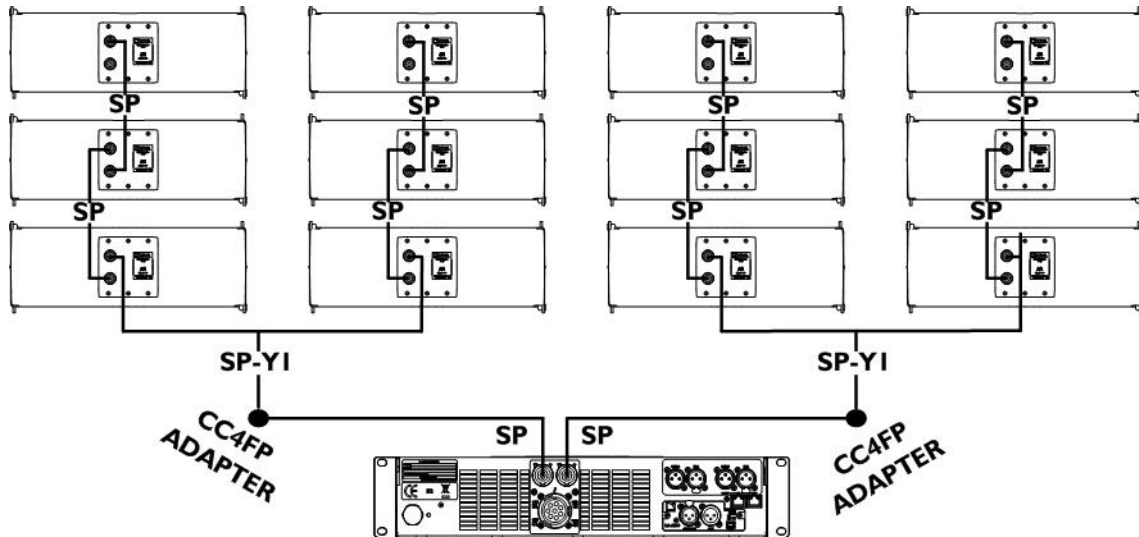

LA8 option B maximum configuration with KIVA

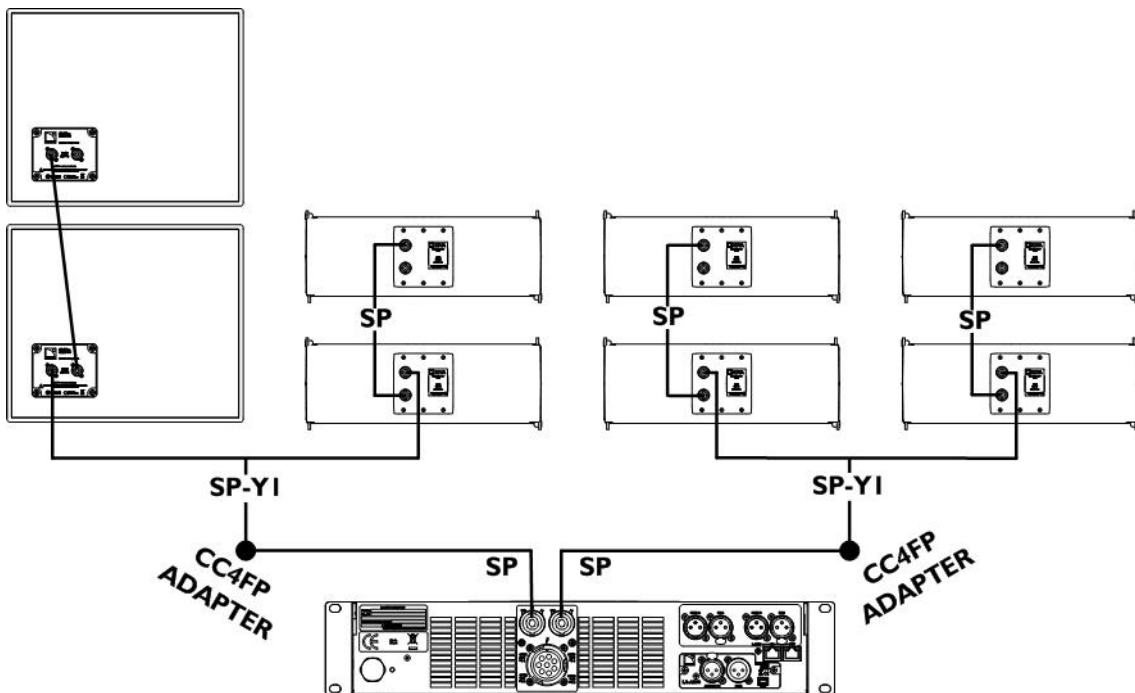

LA8 option B with KIVA + SB15m

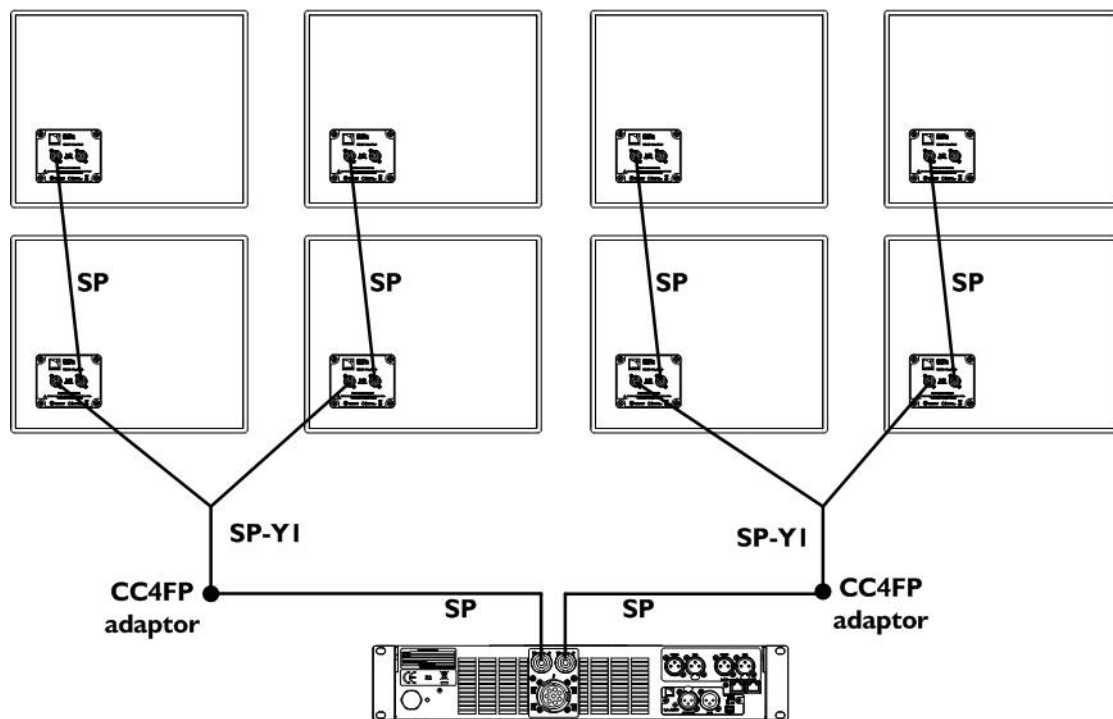

LA8 option A maximum configuration with SB15m

KIVA SYSTEM KIVA SB15m USER MANUAL

VERSION 1.3

APPENDIX A PRESET DESCRIPTION

[KIVA]

The [KIVA] preset allows for a reference frequency response in medium to long throw applications.

Loudspeaker elements	Amplifier outputs	Channels	Default parameters				
			Routing	Gain	Delay	Polarity	Mute
KIVA	OUT 1	PA	IN A	0 dB	0 ms	+	ON
KIVA	OUT 2	PA	IN A	0 dB	0 ms	+	ON
KIVA	OUT 3	PA	IN A	0 dB	0 ms	+	ON
KIVA	OUT 4	PA	IN A	0 dB	0 ms	+	ON

[KIVA_FI]

The [KIVA_FI] preset allows for a reference frequency response in short throw applications.

Loudspeaker elements	Amplifier outputs	Channels	Default parameters				
			Routing	Gain	Delay	Polarity	Mute
KIVA	OUT 1	PA	IN A	0 dB	0 ms	+	ON
KIVA	OUT 2	PA	IN A	0 dB	0 ms	+	ON
KIVA	OUT 3	PA	IN B	0 dB	0 ms	+	ON
KIVA	OUT 4	PA	IN B	0 dB	0 ms	+	ON

* A, B: channel A or B PA: passive output

[KIVA_SB15]

The [KIVA_SB15] preset combines the [KIVA] and [SB15_100] presets to facilitate the use of this configuration.

Loudspeaker elements	Amplifier outputs	Channels	Default parameters				
			Routing	Gain	Delay	Polarity	Mute
SB15m	OUT 1	LF	IN A	0 dB	0 ms	+	ON
KIVA	OUT 2	PA					ON
KIVA	OUT 3	PA					ON
KIVA	OUT 4	PA					ON

* A, B: channel A or B PA: passive output

[SB15_100] and [SB18_60]

The [SB15_100] preset provides a 100 Hz upper frequency limit for the SB15m.

The [SB18_60] preset provides a 60 Hz upper frequency limit for the SB18.

Loudspeaker elements	Amplifier outputs	Channels	Default parameters				
			Routing	Gain	Delay	Polarity	Mute
SB**	OUT 1	SB	IN A	0 dB	0 ms	+	ON
SB**	OUT 2	SB	IN A	0 dB	0 ms	+	ON
SB**	OUT 3	SB	IN B	0 dB	0 ms	+	ON
SB**	OUT 4	SB	IN B	0 dB	0 ms	+	ON

* A, B: channel A or B SB: subwoofer output

[SB15_100_C] and [SB18_60_C]

The [SB15_100_C] preset provides a 100 Hz upper frequency limit for the SB15m.

The [SB18_60_C] preset provides a 60 Hz upper frequency limit for the SB18.

They both feature optimized delay settings for subwoofers arrays in cardioid configuration.

Loudspeaker elements	Amplifier outputs	Channels	Default parameters				
			Routing	Gain	Delay	Polarity	Mute
Reversed SB**	OUT 1	SR	IN A	0 dB	0 ms	+	ON
SB**	OUT 2	SB					ON
SB**	OUT 3	SB					ON
SB**	OUT 4	SB					ON

* A, B: channel A or B SB: subwoofer output SR: reversed subwoofer output

APPENDIX B RECOMMENDATION FOR SPEAKER CABLES



Cable quality and resistance

Only use high-quality fully insulated speaker cables made of stranded copper wire.

Use cables of gauge offering low resistance per unit length and keep the cables as short as possible.

The following table provides the recommended maximum length depending on the cable cross-section and on the impedance load connected to the amplifier.

Cable cross-section			Recommended maximum length					
			8 Ω load		4 Ω load		2.7 Ω load	
mm ²	SWG	AWG	m	ft	m	ft	m	ft
2.5	15	13	30	100	15	50	10	33
4	13	11	50	160	25	80	17	53
6	11	9	74	240	37	120	25	80
10	9	7	120	390	60	195	40	130

KIVA SYSTEM KIVA SB15m USER MANUAL

VERSION 1.3

APPENDIX C SPECIFICATIONS

KIVA

Description	2-way passive enclosure, amplified by LA4X or LA8	
Usable bandwidth (-10 dB)	80 Hz - 20 kHz ([KIVA] preset)	
Maximum SPL¹	130 dB ([KIVA] preset)	
Coverage angle (-6 dB)	Horizontal: 100° (from 500 Hz)	
	Vertical: depends on the number of elements and array curvature	
Transducers	LF: 2 × 6.5", weather-resistant, bass-reflex	
	HF: 1 × 1.5", diaphragm compression driver, DOSC [®] waveguide	
Nominal impedance	8 Ω	
RMS power handling	120 W	
Connectors	IN: 1 × 4-point SpeakON [®]	LINK: 1 × 4-point SpeakON [®]
Rigging components	Captive 3-point rigging system Inter-enclosure angles: 0, 1, 2, 3, 4, 5, 7.5, 10, 12.5 or 15°	
Dimensions	<p>The diagram shows five views of the enclosure with the following dimensions:</p> <ul style="list-style-type: none"> TOP: 520 mm / 20.5 in FRONT: 175 mm / 6.9 in REAR: 175 mm / 6.9 in BOTTOM: 358 mm / 14.1 in SIDES: 103 mm / 4 in (width) and 202 mm / 8 in (height) 	
Physical data	Weight (net):	13 kg / 28.7 lb
	Cabinet:	Composite sandwich structure
	Back plate:	ZAMAC
	Finish:	Dark grey Brown (Pantone 426C) Pure white (RAL 9010 [®]) Custom RAL code on special order
	Front:	Plastic grill with anti-corrosion coating Airnet [®] acoustically neutral fabric
	Rigging components:	High strength steel with anti-corrosion coating

¹ Peak level at 1 m under free field conditions using 10 dB crest factor pink noise with specified preset.

SBI5m subwoofer

Description	Subwoofer enclosure, amplified by LA4X or LA8	
Low frequency limit (-10 dB)	40 Hz ([SB15_100] preset)	
Maximum SPL¹	135 dB ([SB15_100] preset)	
RMS power handling	600 W	
Transducer	1 × 15" weather-resistant, bass-reflex	
Nominal impedance	8 Ω	
Connectors	IN: 1 × 4-point SpeakON®	LINK: 1 × 4-point SpeakON®
Rigging components	Integrated pole-mount socket Coupling bars stored at handle position	

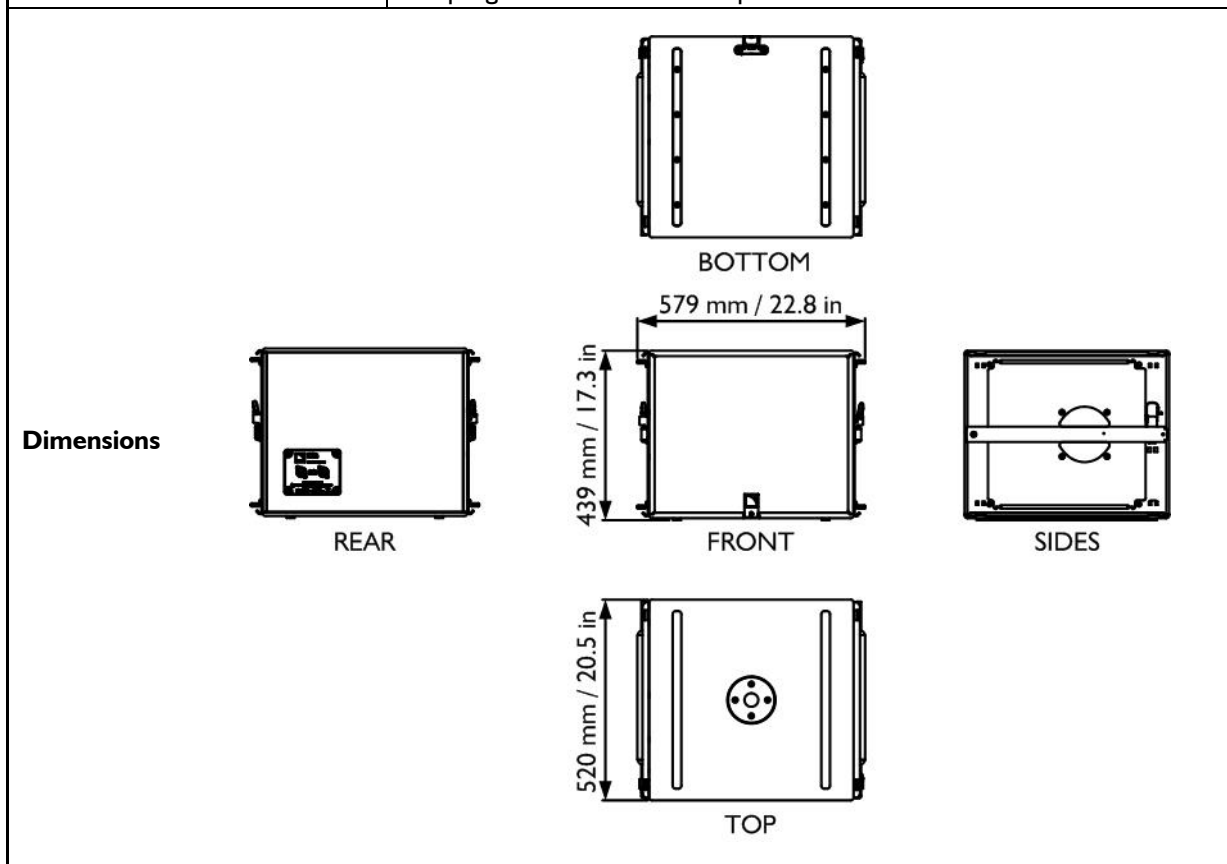

Physical data	Weight (net):	36 kg / 79.4 lb
	Cabinet:	Baltic birch plywood
	Finish:	Dark Grey brown (Pantone 426C) Pure white (RAL 9010®) Custom RAL code on special order
	Front:	Steel grill with anti-corrosion coating Airnet® acoustically neutral fabric
	Protection Rating:	IP45
	Rigging components:	High strength steel with anti-corrosion coating

¹ Peak level at 1 m under half space conditions using 10 dB crest factor pink noise with specified preset.

KIVA SYSTEM KIVA SB15m USER MANUAL

VERSION 1.3

SB18 subwoofer

Description	Subwoofer enclosure, amplified by LA4X or LA8	
Low frequency limit (-10 dB)	32 Hz ([SB18_100] preset)	
Maximum SPL¹	136 dB ([SB18_100] preset)	
RMS power handling	700 W	
Transducers	1 × 18" weather-resistant, direct radiation, dual bass-reflex	
Nominal impedance	8 Ω	
Connectors	IN: 1 × 4-point SpeakON®	LINK: 1 × 4-point SpeakON®
Rigging components	Integrated pole-mount socket Integrated rigging system Handles integrated into the cabinet	
Dimensions		
Physical data	Weight (net):	52 kg / 115 lb
	Cabinet:	Baltic birch plywood
	Finish:	Dark Grey brown (Pantone 426C) Pure white (RAL 9010®)
	Front:	Steel grill with anti-corrosion coating Airtnet® acoustically neutral fabric
	Protection rating	IP45
	Rigging components:	Steel with anti-corrosion coating

¹ Peak level at 1 m under half space conditions using 10 dB crest factor pink noise with specified preset.



Document reference: KIVA-SB15m_UM_EN_1.3

Distribution date: January 7, 2014

© 2013 L-ACOUSTICS®. All rights reserved.

**No part of this publication may be reproduced or transmitted in any form
or by any means without the express written consent of the publisher.**