

TOSHIBA

OWNER'S MANUAL

LCD Color TV



32WL58A
32WL58E
32WL58T
37WL58A
37WL58E
37WL58T

Owner's Record

You will find the model number and serial number on the back of the TV. Record these numbers in the spaces provided below. Refer to them whenever you call upon your TOSHIBA dealer regarding this product.

Model number:

Serial number:

Introduction

Getting started

Basic operation

Features

Equipment connections

Reference section

Welcome to Toshiba

- Thank you for purchasing this Toshiba LCD Color Television. This manual will help you use the exciting features of your new TV.
- Instructions in this manual are based on using the remote control.
- You can also use the controls on the TV if they have the same name as those on the remote control.
- Please read all the safety and operating instructions carefully, and keep the manual for future reference.

Contents

Introduction

Important Safety Instructions	3
Installation	3
Use	5
Service	6
Cleaning	7
Important information	7
Important information	7

Getting started

Installation	8
Connecting an antenna	8
Exploring your new TV	9
Installing the remote control batteries	9
TV top, TV front	9
TV back	10
Learning about the remote control	11
Location of controls	11
Turning the TV on, Selecting a language	12
Switching on the TV	12
Switching off the TV	12
Selecting a language	12
Learning about the menu system	13
Menu display chart	13
Programming channel memory	14
System selection, Auto tuning	14
Manual tuning	14
Program sorting	16
Watching TV programs	17
Volume, Sound mute, Changing program positions, Program return, On-screen information	17

Basic operation

Viewing the wide-screen picture format	18
Picture size selection	18
Picture position, Reset	19
Picture position adjustment	19
Reset (Picture position adjustment)	19
Picture quality adjustment	20
Picture quality adjustment	20
To activate the black stretch	21
To activate the MPEG NR (Noise Reduction)	21
To activate the DNR (Digital Noise Reduction)	21
To select the color temperature	22
To use the cinema mode	22
To use the picture still	22
To adjust the color management	23
To reset the base color adjustment	23
Sound adjustment	24
MTS (Multi-channel TV Sound) setting	24
Selecting the dual 1 or dual 2 mode	24
Stereo/Bilingual selection	25
Sound quality adjustment	25
To select the audio output	26
To select the HDMI audio mode	26

To use the WOW surround sound	27
To use the stable sound	27
To activate/deactivate the speaker	27
Woofers internal/external mode, Bass boost, Woofer system	28

Features

Input selection	29
Input selection	29
Timer, Gray screen	30
Timer	30
To activate gray screen	30
Side panel adjustment	31
Side panel adjustment	31
To use the auto format	31
Teletext – Setting up	32
Teletext mode	32
About Teletext	33
Teletext general information	33
Teletext SW adjustment	33
Teletext – FAST and LIST modes	34
Using FAST mode	34
Using LIST mode	34
Teletext – Control buttons	35
Teletext buttons on the remote control	35
BRIDGE MEDIA using	36
To use the BRIDGE MEDIA	36
To use the BRIDGE MEDIA (still picture)	37
To use the BRIDGE MEDIA (motion picture)	40
To use the BRIDGE MEDIA (information)	43
Double-Window using	44
To display the double-window	44
To select the headphone mode	45
To adjust the headphone volume (Mode 2)	45
To use a headphone	46

Equipment connections

Side connections	47
Connection example	47
Back connections	48
Connection example	48
Connecting a computer	49
To connect a computer	49
PC setting	50
To adjust a PC setting	50
Connecting an HDMI and a DVI device	52
To connect an HDMI and a DVI device	52

Reference section

Troubleshooting	53
Symptom and solution	53
Broadcast system, Specifications	54
Broadcast transmission systems of each country or region	54
LCD color television	54

Important Safety Instructions

- Be sure to observe the following instructions and precautions to ensure safe use of this TV.
- The exact power cord will vary according to the country or region.

Installation

Always connect the power plug to an electrical outlet equipped with A model: 220-240V, AC 50Hz, E model: 220-240V, AC 50/60Hz and T model: 110-240V, AC 50/60Hz.

Never use the TV outside the specified voltage range. It may cause a fire or an electric shock.

WARNING ABOUT THREE-WIRE GROUNDING-TYPE PLUG:

Never remove the earthing pin on the power plug. This system is equipped with a three pin earthing-type power plug. This plug will only fit an earthing-type power outlet. This is a safety feature. If you are unable to insert the plug into the outlet, contact an electrician to replace the wall outlet.

Never defeat the purpose of the earthing plug.

Check!

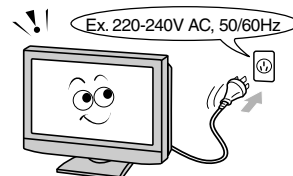

About the fuse

In a three pin earthing-type, the fuse fitted in this plug is approved by ASTA or BSI to BS1362. It should only be replaced by a correctly rated and approved type and the fuse cover must be refitted.

Never insert or remove the power plug with wet hands. This may cause electric shock.

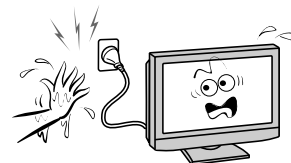

Never place the TV in an unstabilized location such as on a shaky table, incline or location subject to vibration. The TV may drop or fall down which may cause injury or damage.

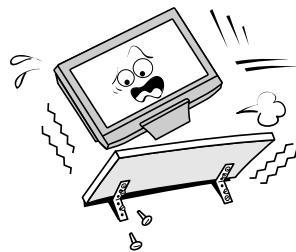

Never block or cover the slots and openings in the cabinet.

- Never place the TV so that it is facing upward, or on its side.
- Never place the TV in a closet, bookshelf where the ventilation is poor.
- Never drape a newspaper, tablecloth or curtain on the TV.
- When installing the TV against a wall, always keep the TV at least 10 cm away from the wall.
- Never place the TV on a soft unstable surface, such as a carpet, or a cushion.

The inside of this TV will overheat if the ventilation holes are covered, blocked or sealed, which may result in a fire.

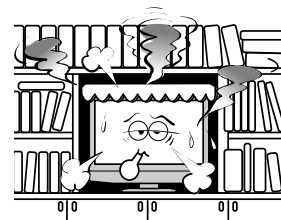

Never place the TV near a heater or in direct sunlight.

The surface of the cabinet or power cord may melt and result in fire or electric shock.

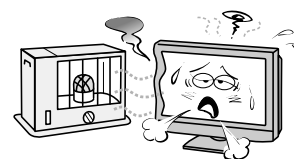

Important Safety Instructions (continued)

Installation (continued)

Never place the TV in an area exposed to high humidity levels, such as in a bathroom or close to a humidifier. This may cause a fire or an electric shock.

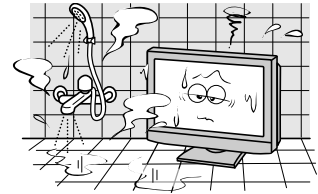

Never place the TV next to a stove where it will be exposed to oil, smoke, or steam, or in a location where there is a large quantity of dust. This may cause a fire or electric shock.



Install the TV in a horizontal, stable location. Connect between two clips on the back of the TV and a wall, pillar, etc., with a sturdy tie and clip of supplied accessories (see page 55).

- Use as short a tie as possible to ensure the TV is stable.
- If the TV is not installed securely, it may lean or fall over and cause an injury.

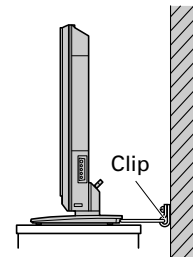

Side view

Sturdy tie
(as short as possible)

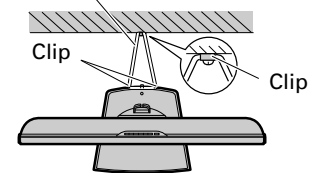

Top view

Precautions for moving the TV

- When moving the TV, be sure to remove the power plug from the wall outlet and disconnect the antenna cable and audio/video cables, any steady ties. Fire or electric shock may result if the power cord is damaged.
- When carrying the TV, at least two people are needed. Be sure to carry it upright.
- Never carry the TV with the screen facing up or down.



Precautions for installing on outdoor antenna

An outside antenna system should not be located in the vicinity of overhead power lines, or other electric light or power circuits. If the antenna falls down or drops, it may cause injury or electric shock.

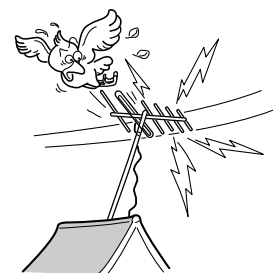

Use

Never place hot objects or open flame sources, such as lighted candles or nightlights, on or close to the TV.

High temperatures can melt plastic and lead to fires.

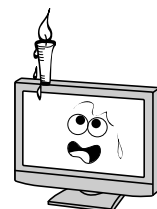

The apparatus shall not be exposed to dripping or splashing and that no objects filled with liquids, such as vases, shall be placed on the apparatus.

When liquids are spilled or small items are dropped inside the TV, this may cause a fire or an electric shock. If small objects drop inside the TV, turn off the TV and remove the power plug from the outlet immediately and contact a service technician.

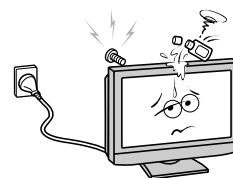

Never insert objects (metal or paper) or pour water inside the TV through ventilation holes and other openings.

These items may cause a fire or an electric shock.

If these objects are inserted inside the TV, turn off the TV and remove the power plug from the outlet immediately and contact a service technician. Be especially careful that children do not insert objects in the TV.



Never stand or climb on the TV.

Be especially careful in households with children to prevent them through climbing on top of the TV.

It may move, fall over, break, become damaged or cause an injury.



When the TV will not be used for a long period of time, such as during vacation or travel, remove the power plug from the wall outlet for safety.

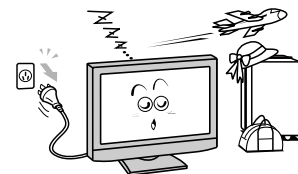

Never pull on the power cord when removing the plug from the wall outlet.

Always hold the plug firmly when removing it. If the power cord is yanked, the cord may become damaged and fire or electric shock may occur.

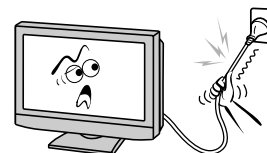

Important Safety Instructions (continued)

Use (continued)

Never cut, break, modify, twist, bunch up or bent the cord or apply excessive force or tension to it.

Never place heavy objects on the cord or allow it to overheat as this may cause damage, fire or electric shock. Contact a service technician if the power cord is damaged.

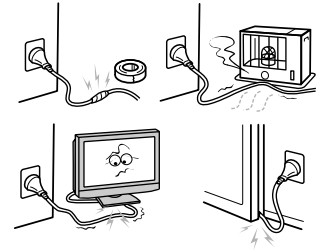

If there is thunder or lightning, never touch the antenna cable or other connected cables.

You may suffer an electric shock.

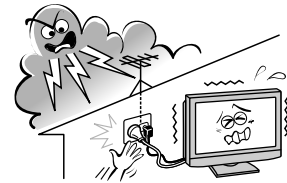

Service

Never repair, modify or disassemble the TV by yourself.

If it may cause a fire or an electric shock. Consult a service technician for inspection and repairs.

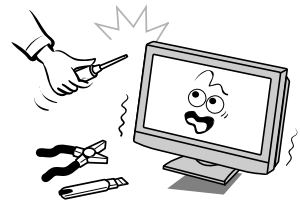

When a malfunction occurs, or if smoke or an unusual odor comes from the TV, turn off the TV and remove the power plug from the outlet immediately.

Make sure that the smoke or smell has stopped, then contact a service technician. If the TV is still used in this condition, it may cause a fire or an electric shock.

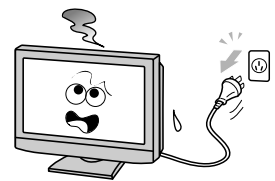

If the TV is dropped or the cabinet is broken, turn off the TV and remove the power plug from the outlet immediately.

If the TV is still power used in this condition, it may cause a fire or an electric shock. If the cabinet is broken, be careful when handling the TV to prevent an injury. Contact a service technician for inspection and repair.

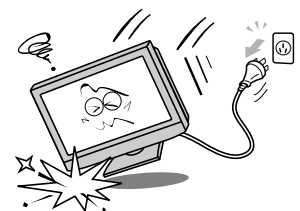

Important Safety Instructions (continued), Important information

Service (continued)

When the TV reaches the end of its useful life, ask a qualified service technician to properly dispose of the TV.

Note:

The lamp unit contains a small amount of mercury. Disposal of mercury may be regulated due to environmental considerations. Dispose of the used lamp unit by the approved method for your area. For disposal or recycling information, please contact your local authorities.



Cleaning

Remove the power plug before cleaning.

Never use solvents such as benzine or thinner to clean the TV.

- These solvents may distort the cabinet or damage its finish.
- If rubber or vinyl products remain in contact with the TV for a long time, a stain may result.

If the cabinet becomes dirty, clean it with a soft, dry cloth.

When cleaning the surface of the LCD display, wipe the panel surface gently with a soft, dry cloth.

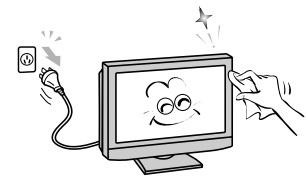

Periodically disconnect the power plug from the outlet and check it. If dust has collected on the power plug connectors, clean off the dust.

This dust may cause a fire due to reduced insulation on the plug.

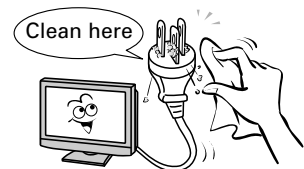

Important information

About LCD screen

- If you have the LCD screen facing to the sun, the LCD screen will be damaged. Be aware of locating the TV in the place such as window side or outside of the room.
- Never press the LCD screen strongly or scratch it, and never put anything on it. These actions will damage the LCD screen.

About cabinet

- Never spray volatile compounds such as insecticide on the cabinet. This may cause a discoloration or damage the cabinet.

Some pixels of the screen do not light up

- The LCD display panel is manufactured using an extremely high level of precision technology, however sometimes some pixels of the screen may be missing picture elements or have luminous spots. This is not a sign of a malfunction.

About Interference

- The LCD display may cause interference in image, sound, etc. of other electronic equipment that receives electromagnetic waves (e.g. AM radios and video equipment).

Important information (continued), Installation

Important information (continued)

About using under the low temperature places

- If you use the TV in the room of 0°C or less, the picture brightness may vary until the LCD monitor warms up. This is not a sign of a malfunction.

About afterimage

- If a still picture is displayed, an afterimage may remain on the screen, however it will disappear. This is not a sign of malfunction.

Exemptions

- Toshiba is not liable for any damage caused by fires, natural disaster (such as thunder, earthquake, etc.), acts by third parties, accidents, owner's misuse, or uses in other improper conditions.
- Toshiba is not liable for incidental damages (such as profit loss or interruption in business, modification or erasure of record data, etc.) caused by use or inability to use of product.
- Toshiba is not liable for any damage caused by neglect of the instructions described in the owner's manual.
- Toshiba is not liable for any damage caused by misuse or malfunction through simultaneous use of this product and the connected equipment.

Connecting an antenna

Optimum reception of color requires a good signal and will generally mean that an outdoor antenna must be used. The exact type and positioning of the antenna will depend upon your particular area. Your Toshiba dealer or service personnel can best advise you on which antenna to use in your area. Before connecting the antenna cable, turn off all main POWER switches. Before connecting the antenna cable, remove the back terminal cover (see page 10).

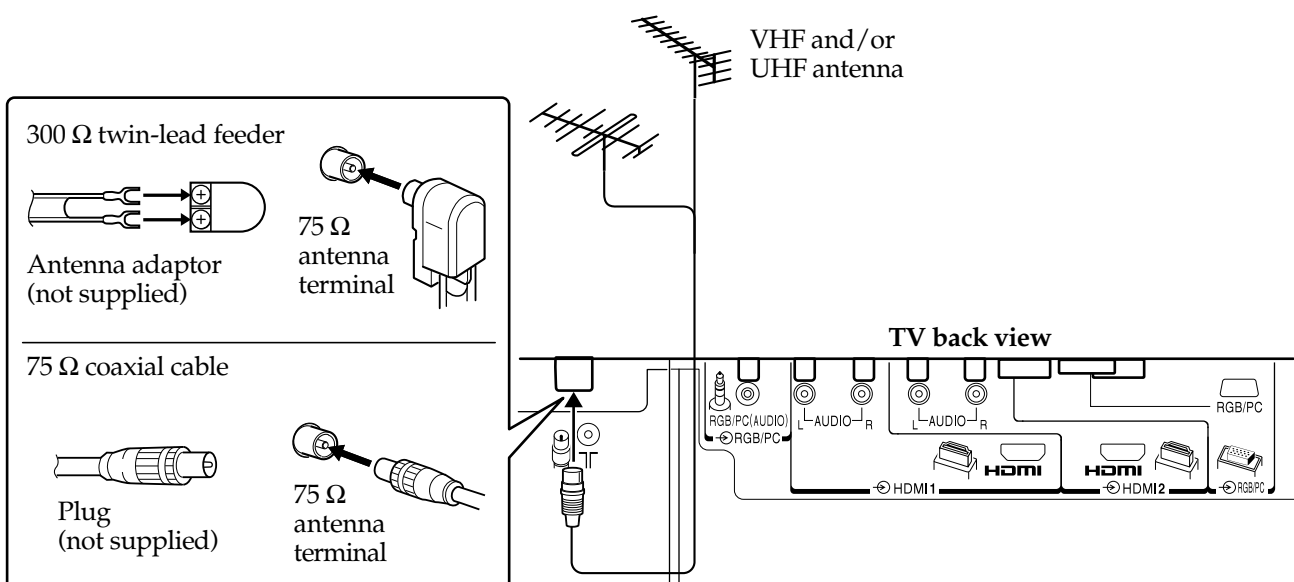

Exploring your new TV

- You can operate your TV using the buttons on the top of the panel or the remote control. The back and side of the panel provide the terminal connections to connect other equipment to your TV. See "Equipment connections" on pages 47-52.

Installing the remote control batteries

Remove the battery cover. Insert two R03 (AAA) batteries matching the -/+ polarities of the battery to the -/+ marks inside the battery compartment.

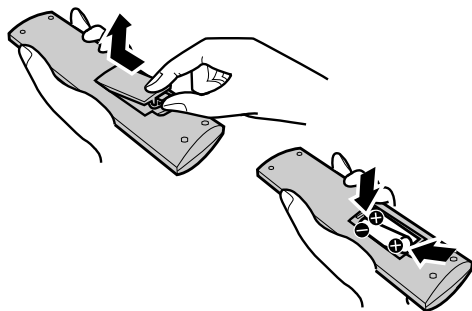

Caution:

- Dispose of batteries in a designated disposal area. Never throw batteries into a fire.
- Attention should be drawn to the environmental aspects of battery disposal.
- Never mix battery types or combine used batteries with new ones.

Effective range

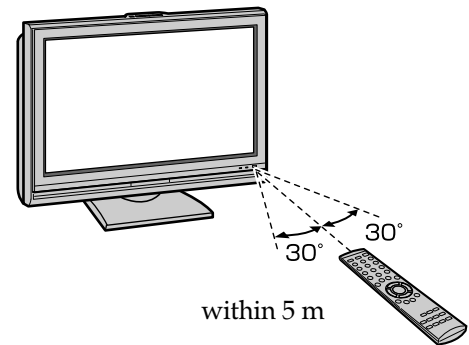

Notes:

- If the remote control does not operate correctly, or if the operating range becomes reduced, replace both batteries with new ones.
- If the batteries are dead or if you will not use the remote control for a long time, remove the batteries to prevent battery acid from leaking into the battery compartment.

TV top, TV front

For the use of each control, see the pages in brackets.

TV top view

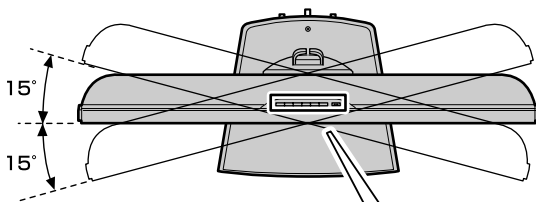

You can swivel the TV screen. Swivel angle: 15 degrees to left and right.

Top view

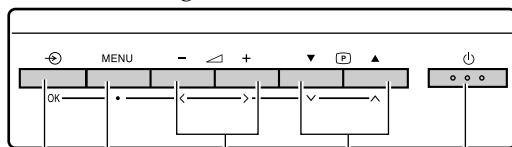

- Input source selection [29]
- MENU [13]
- Volume - + [17]
- Menu < > [13]
- Program position ▼ ▲ [17]
- Menu ∨ ^ [13]
- Power [12]

TV front view

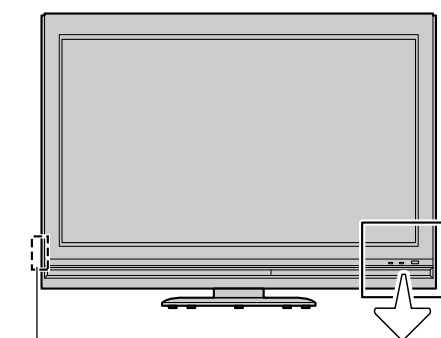

Power switch [12]

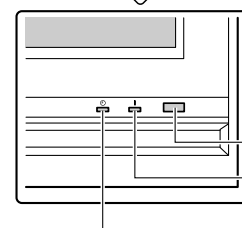

On-timer indicator (green) [30]

Remote sensor
Power indicator (red) [12]

Exploring your new TV (continued)

TV back

- Before connecting external equipment etc., remove the back terminal covers (squeeze tabs (➔ mark in the figure below) and pull covers).

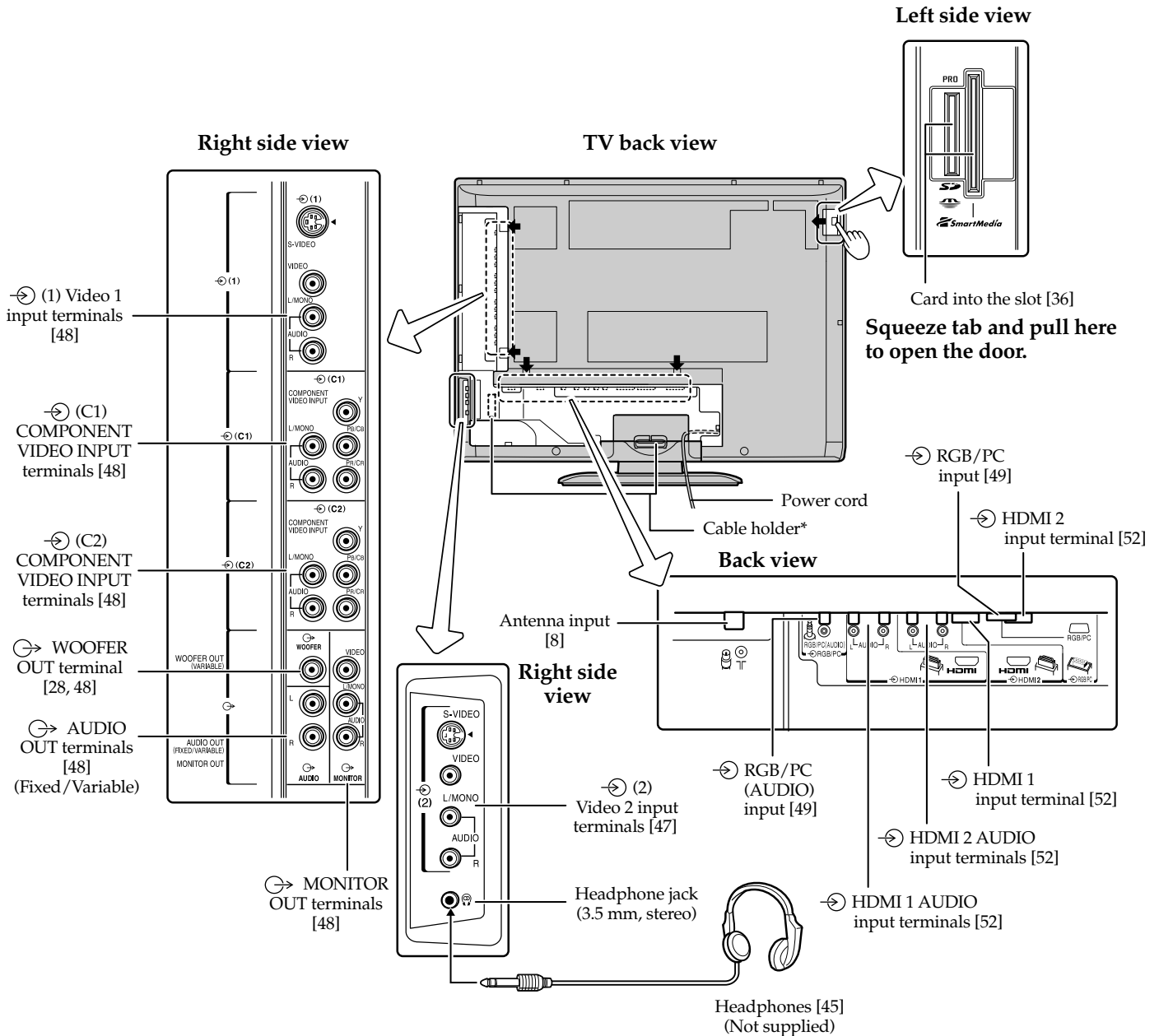

* You can use the cable holder to hold antenna cable, video and audio cables etc. **When moving the TV, never hold this holder.**

Learning about the remote control

Location of controls

For the use of each control, see the pages in brackets.

Teletext on/off [33 – 35]

CALL [15, 17]
Initial/index function for Teletext [35]

Power on/Standby [12]
(For Toshiba TV/VCR/DVD)

Number buttons (0-9) [17, 30]

- Input source selection [29]
(-1, -2, -C1, -C2, HDMI 1, HDMI 2, PC, BM)
- To access sub-pages when in teletext [33]

To return to the previous program [17]

Picture mode selection [20]

MENU [13]
DVD MENU

EXIT [13]

- Menu \wedge \vee [13]
- Program position \blacktriangle \blacktriangledown [17]
- Teletext \blacktriangle \blacktriangledown [34]
- **P** \blacktriangle \blacktriangledown [44]

• Menu \leftarrow \rightarrow [13]
• Volume - + [17, 44]

OK [13, 29]

Picture size selection [18]

- Teletext control buttons [34]
(Four colored buttons: Red, Green, Yellow, Blue)
- BRIDGE MEDIA [37-43]

Stereo/bilingual selection [25]

• Bass boost on/off [28]
• External woofer on/off [28]

Mode switch
TV : To control TV
VCR : To control VCR
DVD : To control DVD

Sound mute [17]

When in VCR or DVD mode:
(Only for Toshiba VCR/DVD players)

- \blacktriangle to EJECT
- $\blacktriangleleft\blacktriangleleft$ to REWIND
- \blacktriangleright to PLAY
- $\blacktriangleright\blacktriangleright$ to FAST FORWARD
- \blacksquare to PAUSE
- $\blacktriangleleft\blacktriangleleft$ to SKIP-REWIND
- \blacksquare to STOP
- $\blacktriangleright\blacktriangleright$ to SKIP-FORWARD

When in Teletext mode:

- E To reveal concealed text [35]
- E To hold a wanted page [35]
- E To enlarge teletext display size [35]
- E/E To select a page while viewing a normal picture [35]

When in TV mode:

- E/E To select the time display [35]
- \blacksquare Double-Window on/off [44]
- \blacktriangledown Picture STILL [22, 44]
- \blacksquare \blacktriangle \blacktriangledown \blacktriangleleft \blacktriangleright Double-Window picture/sound selection [44]

TOSHIBA
CT-90241

Turning the TV on, Selecting a language

- Connect the power cord to a wall outlet.

Switching on the TV

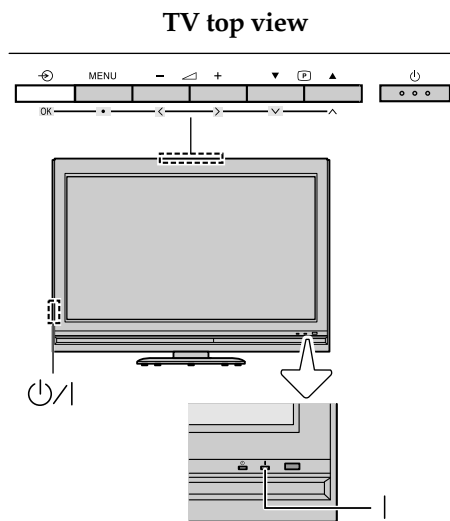

Note:

If you watch black and white programs when the color system mode is set to Auto, color noise may appear on the screen. In this case select the appropriate Color system (For the system of each country or region, refer to pages 15 and 54).

- 1 Press the / POWER switch on the TV left side until it clicks.



The Power ON indicator lights in red. Press the button on the remote control or on the TV top panel if no picture appears.

Switching off the TV

- 1 Press the button on the remote control or on the TV top panel to switch to the standby mode.
- 2 To switch the TV off, press the / POWER switch on the TV left side . Power indicator will be turned off.

Notes:

- This TV is not full disconnected from the main supply, as minute current is consumed even when the / POWER switch is turned off. When the TV will not be used for a long period of time, such as during vacation or travel, remove the power plug from the wall outlet.
- The TV will automatically turn itself off after approximately 15 minutes if it is tuned to a vacant channel or a station that completes its broadcast for the day. This function does not work in external input or Gray screen Off mode.
- If power is cut off while you are viewing the TV, the Last Mode Memory function turns on the TV automatically when power is applied again. If power is going to be off for a long time and you are going to be away from your TV, unplug the power cord to prevent the TV from tuning on in your absence.

Selecting a language

Choose from 9 different languages (English, Chinese (CS), Malay, Thai, Vietnamese, Russian, Arabic, Persian or French) for the on-screen display.

- 1 Press the **MENU** button, then press the < or > button to display the SET UP menu.
- 2 Press the ∇ or \blacktriangle button to select Language.
- 3 Press the < or > button to select the desired language.

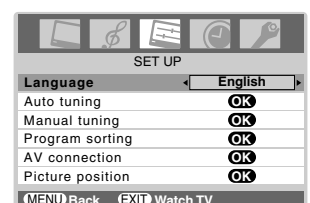

Learning about the menu system

- We suggest you familiarize yourself with the display charts before using the menu system:
 - Press the **MENU** button to display menu, then press the < or > button to select main menu headings.
 - Press the ∨ or ∧ button to select an item.
 - Press the < or > button to select or adjust setting.
 - Press the **OK** button to display the next menu.

Menu display chart

PICTURE menu

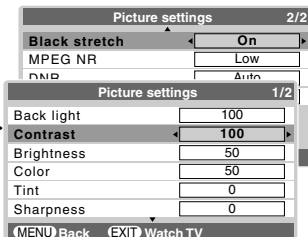
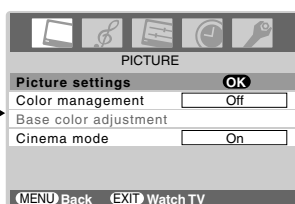
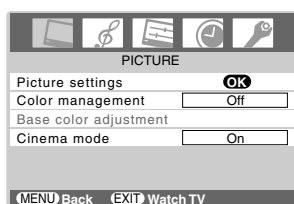

SOUND menu

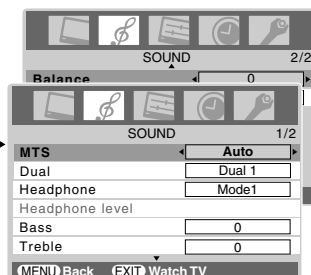
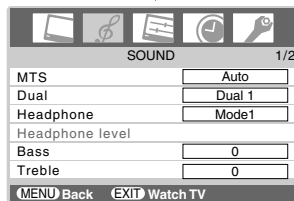

SET UP menu

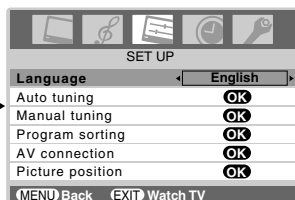
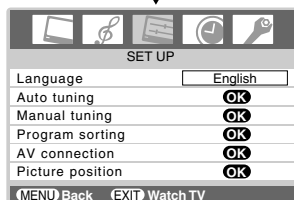

TIMER menu

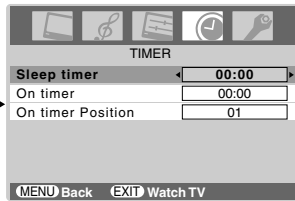
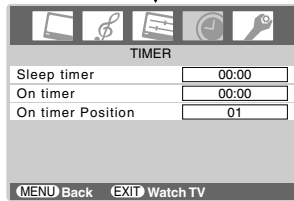

FUNCTION menu

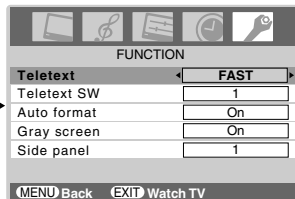
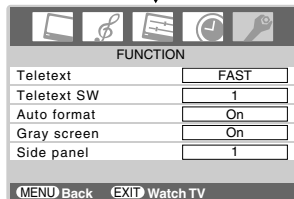

Notes:

- In the video input mode (⊕ 1, ⊕ 2, ⊕ C1, ⊕ C2, HDMI 1, HDMI 2), Auto tuning, Manual tuning and Program sorting are not available. Instead, Manual setting appears in the SET UP menu (see page 29).
- If you connect external equipment via component video source to external input, Color system selection in the Manual setting menu is not available.
- If you do not make a selection for a while, the menu display disappears automatically.
- If you want to close the menu display instantly, press the **EXIT** button except for the BRIDGE MEDIA function (see page 36).
- To return to the previous menu, press the **MENU** button except for the BRIDGE MEDIA function (see page 36).
- The ∧/∨ buttons function as the Program position **P▲** / **P▼** buttons when there is no menu display on the screen.
- The </> buttons function as the Volume **▲**+/ **▲**- buttons when there is no menu display on the screen.
- In the PC input mode, PC Setting appears in the SET UP menu (see page 29).
- In the 480i or 576i input signals mode, you can select the Cinema mode in the PICTURE menu (see page 22).
- When you use the color management function (see page 23), you can select the Base color adjustment in the PICTURE menu.
- When you use the double-window function (see page 45), you can select the Headphone level in the SOUND menu.

Programming channel memory

- First, use the Auto tuning function to preset all the active channels in your area automatically. Then, arrange the preset channels with the Manual tuning function so that you can tune into only desired channels.
- Use the Manual tuning operation if desired channels cannot be preset with the Auto tuning or if you would like to preset channels to specific position numbers one by one.

System selection, Auto tuning

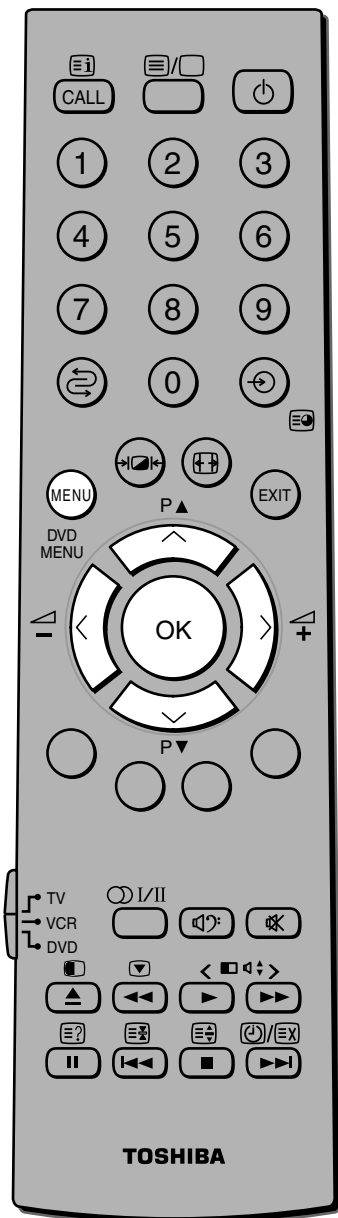

- 1 Press the **MENU** button, then press the < or > button to display the SET UP menu.
- 2 Press the ∨ or ∧ button to select Auto tuning.
- 3 Press the **OK** button to display the Auto tuning menu.
- 4 Press the **OK** button to start the automatic search.
The search will begin for all available stations.
The slide bar will move along the line as the search progresses.
If you make a mistake, simply repeat steps 1-4 to start again from the beginning.
- 5 When the automatic search is complete, the TV will automatically return to the first program position.
- 6 Press the **P▲** or **P▼** button to view the programmed position.

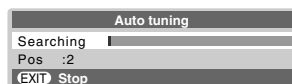
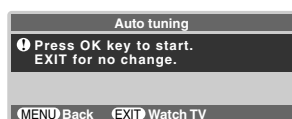
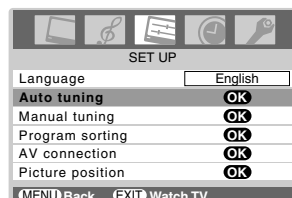

Manual tuning

- 1 Press the **MENU** button, then press the < or > button to display the SET UP menu. Press the ∨ or ∧ button to select Manual tuning.
- 2 Press the **OK** button to display the Manual tuning menu. Press the ∨ or ∧ button to select the program position you want to arrange.
- 3 Press the **OK** button to display the breakdown menu. Press the < or > button to select an item, then press the ∨ or ∧ button to select the item as shown below and on the next page.

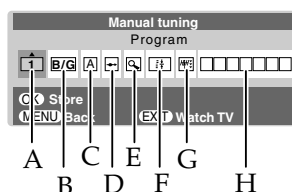
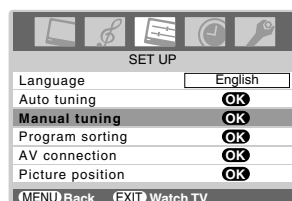

- A. Program position selection
B. Sound system (see page 54)

Manual tuning (continued)

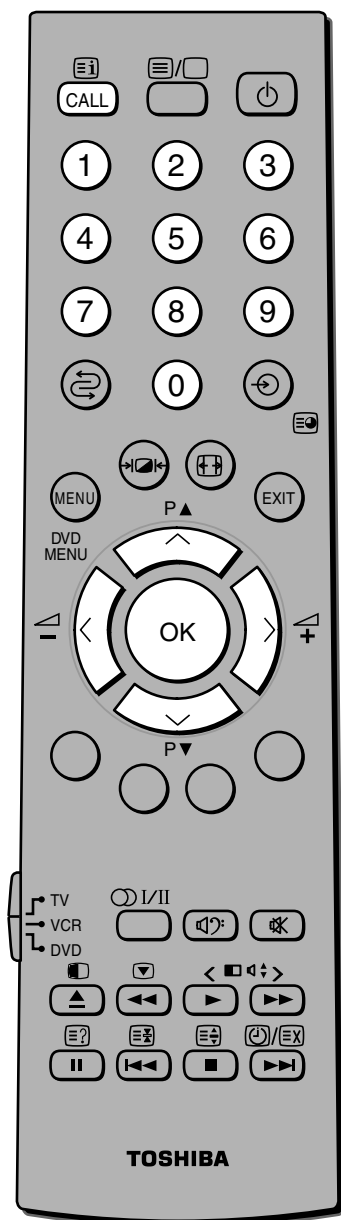

C. Color system (see page 54)

A : Automatic (factory setting), P : PAL, S : SECAM
N4 : NTSC 4.43 (MHz), N3 : NTSC 3.58 (MHz)

If the color of a certain channel is abnormal, the automatic color system selection (A) may have malfunctioned, or sound system selection is wrong. In such a case, select another color and/or sound system (see page 54).

D. Program position skip selection

Press the \wedge or \vee button to turn the program position skip option on " \curvearrowright " or off " \curvearrowleft ".

The program position will then be skipped when you select channels with the **P \blacktriangle** or **P \blacktriangledown** button.

The " \curvearrowright " mark will appear beside a program position number when you use the **Number** button on the remote control.

E. Channel search operation

Press the \wedge button to search up the band or the \vee button to search down the band.

Press the \vee or \wedge button repeatedly until your desired channel is displayed.

When a station/satellite is found, it will be displayed. NEVER PRESS ANY OTHER BUTTONS WHILE THE SET IS TUNING.

F. Auto Fine Tuning

Press the \vee or \wedge button to turn the Auto Fine Tuning option on " $\#$ " or off "0".

The Auto Fine Tuning function automatically corrects slight fluctuations when receiving signals.

Manual Fine Tuning

While the Auto Fine Tuning turn off "0", press the \vee or \wedge button so that the better picture and sound are obtained.

G. ANT ATT (Antenna attenuator)

Press the \wedge or \vee button to turn the ANT ATT option on " $\#$ " or off " $\#$ ", when visual interference occurs, set the ANT ATT to on.

H. Label

Station labels appear under the program position display each time you turn on the TV, select a channel, or press the **CALL** button.

To change or create station labels:

- 1) Press the \vee or \wedge button repeatedly to select a character for the first space, then press the \blacktriangleright button.

\curvearrowright A \leftrightarrow Z \leftrightarrow () \leftrightarrow * \leftrightarrow + \leftrightarrow , \leftrightarrow - \leftrightarrow . \leftrightarrow / \leftrightarrow 0 \leftrightarrow 9 \leftrightarrow \square \leftrightarrow \square

*(blank space)

- 2) Repeat step 1) to enter the rest of the characters. If you would like a blank space in the label name, you must choose a blank space from the list of characters.

Press the **OK** button to store your settings.

Programming channel memory (continued)

- This TV is capable of receiving a number of different channels depending upon where you live.
- Program sorting is an easy way of storing each channel on the program position of your choice.

Program sorting

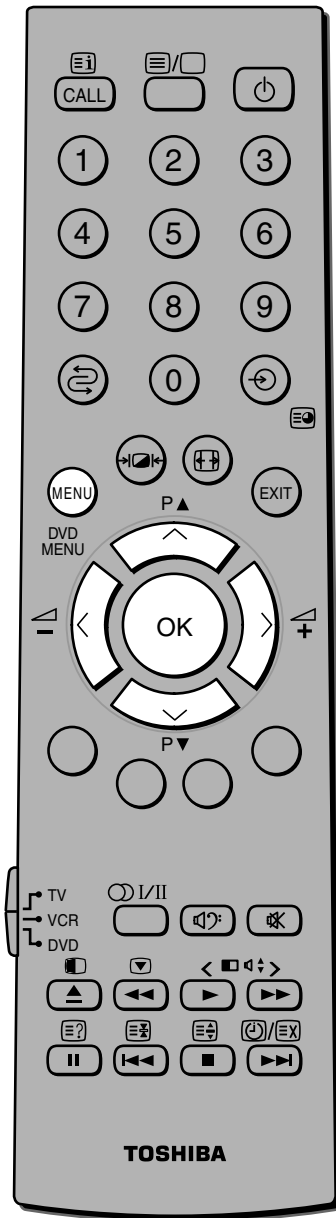

Ex.: To swap channel ABCD (Prog.1) for channel MNOP (Prog.4):

- 1 Press the **MENU** button, then press the < or > button to display the SET UP menu. Press the ^ or v button to select Program sorting.
- 2 Press the **OK** button to display the Program sorting menu.
- 3 Press the ^ or v button to select the channel ABCD, then press the > button.
- 4 Press the v button to select the new position "4", then press the < button.
- 5 Press the ^ button to select the channel MNOP, then press the > button.
- 6 Press the ^ button to select the new position "1", then press the < button.
- 7 Confirm new sorting list.

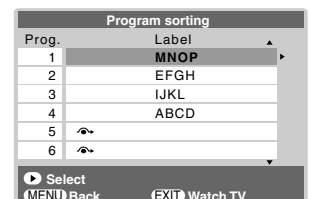
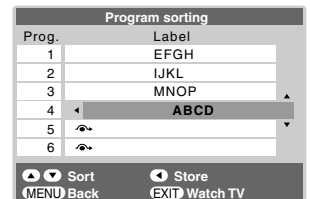
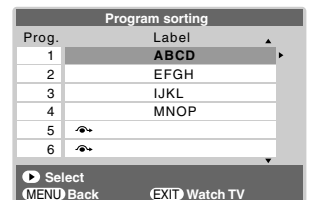
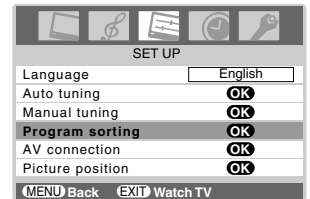

Watching TV programs

Volume, Sound mute, Changing program positions, Program return, On-screen information

TV top view

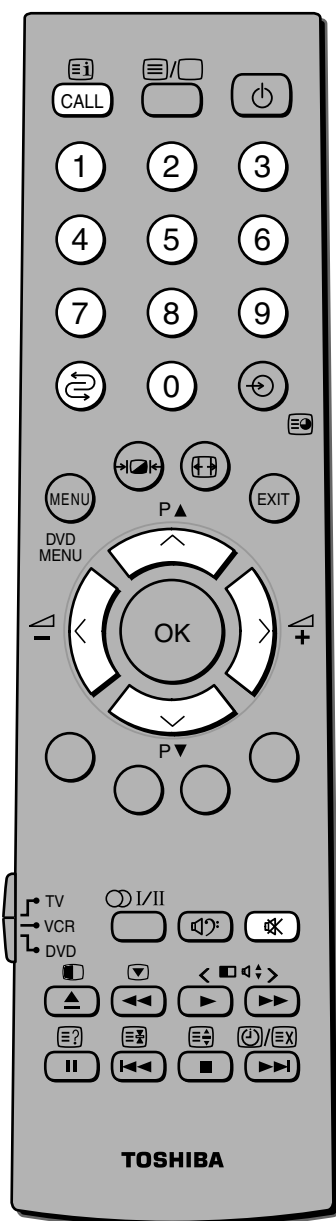
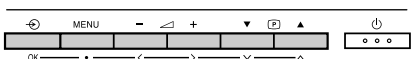

Note:

The program position selection change between different format channels takes several seconds.

To alter the volume:

- 1 Press the $\triangle +$ or $\triangle -$ button to raise or lower the volume.



To mute the sound:

- 1 Press the \times button. The word Sound mute appears on the screen.
- 2 Press the \times button again to restore the sound.

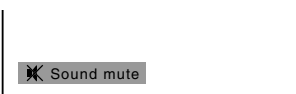

To change program position:

- 1 Enter the desired program position number using the **Number** buttons on the remote control.

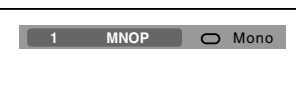

For program positions below 10, use 0 and the required number e.g., for program position 1.

- 2 You can also change the program position by using the **P▲** or **P▼** button.

The program position will be displayed on the screen with the Mono/Stereo/Dual audio status.

To switch between two program positions:

You can switch two program positions without entering actual position number each time.

- 1 Select the first program position you want to view.
- 2 Select the second program position with the **Number** buttons (0-9).
- 3 Press the \rightleftarrows button. The previous channel will be displayed.

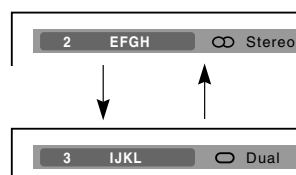

Each time you press the \rightleftarrows button, the TV will switch back and forth between the two program positions.

To display the on-screen information:

- 1 Press the **CALL** button to display the following on-screen information. The information will disappear in 6 seconds.
 - Program position or external input mode selected
 - Program skip on/off information
 - Label (if set)
 - Mono/Stereo/Dual audio status

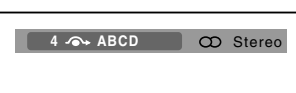

- 2 To erase the display instantly, press the **CALL** button again.

Viewing the wide-screen picture format

- This TV is capable of showing broadcasts in a number of formats. Depending on the type of broadcast being transmitted, you may select between Super live, Cinema, Subtitle, 14:9, Wide and 4:3.

Picture size selection



Notes:

- Using the special functions to change the size of the displayed image (e.g. changing the height/width ratio) for the purpose of public display or commercial gain may infringe on copyright laws.
- In the 720p/1080i input signals mode, the picture size selection is wide only.
- If the aspect ratio of the selected format is different from the one of the TV transmission or video program, it can cause a difference in vision. Change to the correct aspect ratio picture size.
- In the BRIDGE MEDIA (see page 29) and PC mode (see page 29), the picture size selection is wide or 4:3 only.

Press the  button repeatedly to view the options available.

Super live

This setting will enlarge the 4:3 image to fit the screen by stretching the image vertically and horizontally, holding the correct proportions at the center of the image.

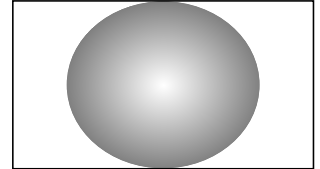

Cinema

When watching "letterbox format" films/video tapes, this setting will eliminate or reduce the black bars at the top and bottom of the screen by zooming in and selecting the image without distortion.

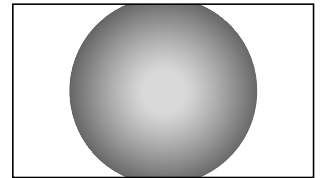

Subtitle

When subtitles are included on a letterbox format broadcast, this setting will raise the picture so that the most of text is displayed.

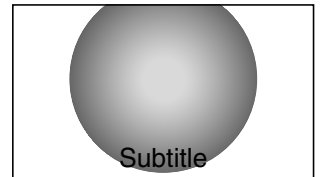

14:9

Use this setting when watching a 14:9 broadcast.

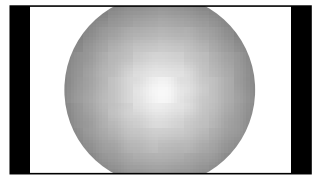

Wide

Use this setting when watching a wide-screen DVD, wide-screen video tape or a 16:9 broadcast (when available). Due to the range of wide-screen formats (16:9, 14:9, 20:9 etc.), you may see bars on the top and bottom of the screen.

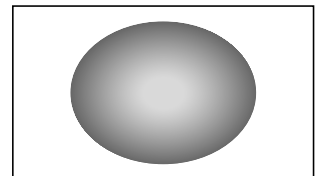

4:3

Use this setting to view a true 4:3 broadcast.

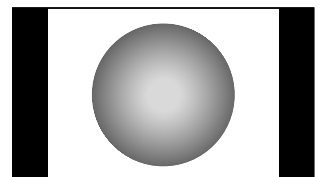

Picture position, Reset

Picture position adjustment

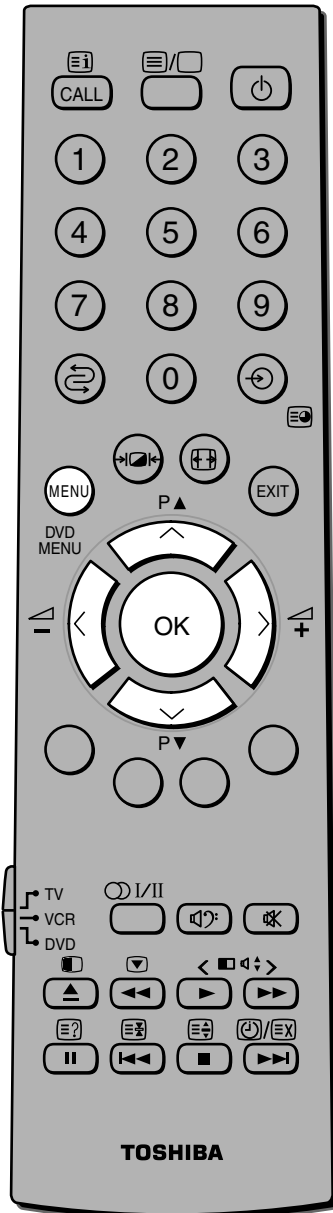

Notes:

- When the picture format is in Wide or 4:3 mode, only the Horizontal position can be adjusted.
- The picture position adjustment is not available for 720p/1080i input signals.

Adjustment to the position of the picture may be made to suit your viewing preferences.

To adjust the picture position:

- 1 Press the **MENU** button, then press the < or > button to display the SET UP menu.
- 2 Press the ∨ or ∧ button to select Picture position.
- 3 Press the **OK** button to display the Picture position menu.
The menu will vary depending upon the widescreen format you have previously chosen.
- 4 Press the ∨ or ∧ button to select an item you want to adjust.
- 5 Press the < or > button to adjust the settings as required.

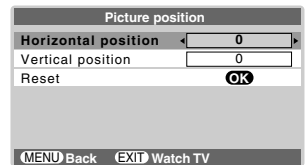
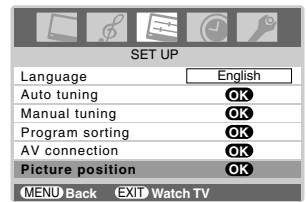

Reset (Picture position adjustment)

This function resets your picture position settings to the factory settings.

To reset the picture position:

- 1 Press the **MENU** button, then press the < or > button to display the SET UP menu.
- 2 Press the ∨ or ∧ button to select Picture position, then press the **OK** button.
- 3 Press the ∨ or ∧ button to select Reset, then press the **OK** button.

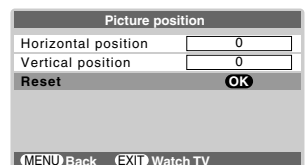
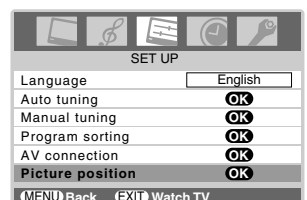

Picture quality adjustment

Picture quality adjustment

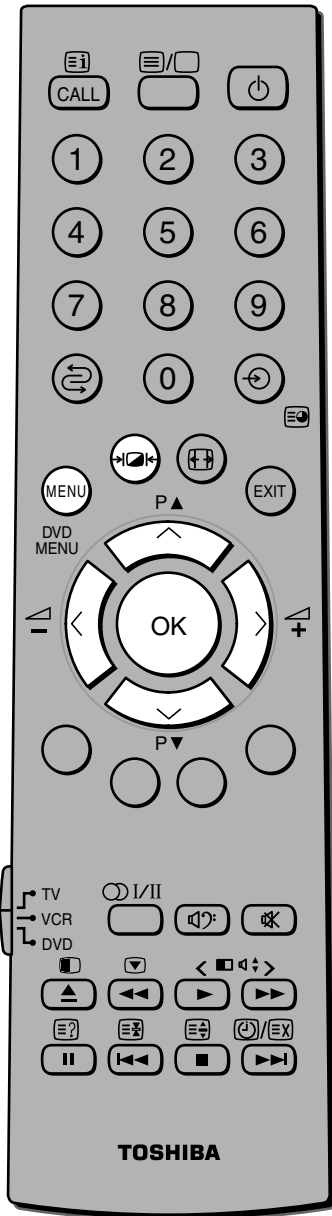

Notes:

- The Tint may only be adjusted on a tape which has been recorded and played back on an NTSC VCR.
- In the PC input mode (see page 29), Color, Tint and Sharpness modes are not available.





To select the picture mode:

You can select the picture quality instantly among three preset modes and one user-set mode.

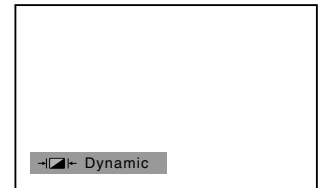
- Press the  button to select the desired picture quality.

Dynamic, Standard, Mild and Memory (user-set) can be selected cyclically.



Mode	Picture quality
 Dynamic	bright and dynamic picture
 Standard	standard picture
 Mild	soft picture
 Memory	the picture quality you set

Note:

In the PC input mode (see page 29), this mode is not available.

To adjust the basic picture quality:

- 1 Press the **MENU** button, then press the **<** or **>** button to display the PICTURE menu.
- 2 Press the **∨** or **∧** button to select the Picture settings menu, then press the **OK** button.
- 3 Press the **∨** or **∧** button to select Contrast, Brightness, Color, Tint or Sharpness, then press the **<** or **>** button to adjust the level.

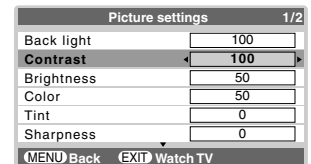

Selection	< Pressing >	
Back light	darker	lighter
Contrast	lower	higher
Brightness	darker	lighter
Color	paler	deeper
Tint	reddish	greenish
Sharpness	softer	sharper

To activate the black stretch

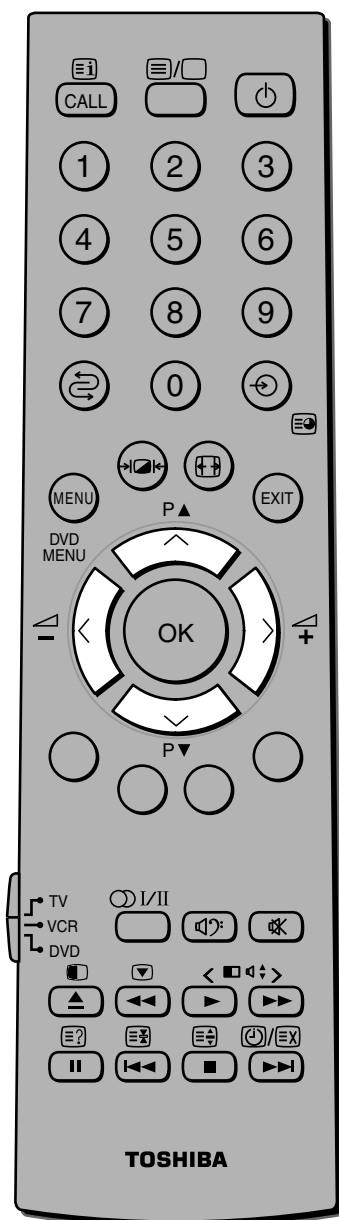

This function increases the strength of dark areas of the picture which improves definition.

- 1 From the Picture settings menu, press the \downarrow or \uparrow button to select Black stretch on the 2nd page.

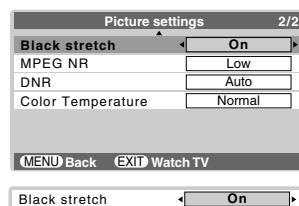

- 2 Press the \leftarrow or \rightarrow button to select On or Off.

Note:

In the PC input mode (see page 29), this mode is not available.

To activate the MPEG NR (Noise Reduction)

If the receiving signal of MPEG is a mosquito (grained) noise depending on the compression and conversion, the noise may be reduced when using this function.

- 1 From the Picture settings menu, press the \downarrow or \uparrow button to select MPEG NR on the 2nd page.

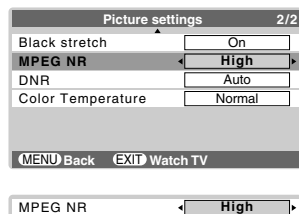

- 2 Press the \leftarrow or \rightarrow button to select Off, Low, Middle or High.

Note:

In the PC input mode (see page 29), this mode is not available.

To activate the DNR (Digital Noise Reduction)

If the receiving signal is weak and the picture is blurry, the picture may be improved when using this function.

- 1 From the Picture settings menu, press the \downarrow or \uparrow button to select DNR on the 2nd page.

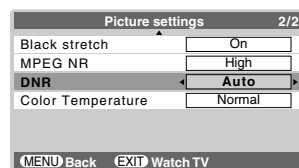

- 2 Press the \leftarrow or \rightarrow button to select Auto, Low, Middle, High or Off.

Note:

This function is available for 480i and 576i signals.

Picture quality adjustment (continued)

To select the color temperature

Cool : Lends a blue hue to the picture.
 Normal : Neutral
 Warm : Lends a red hue to the picture.

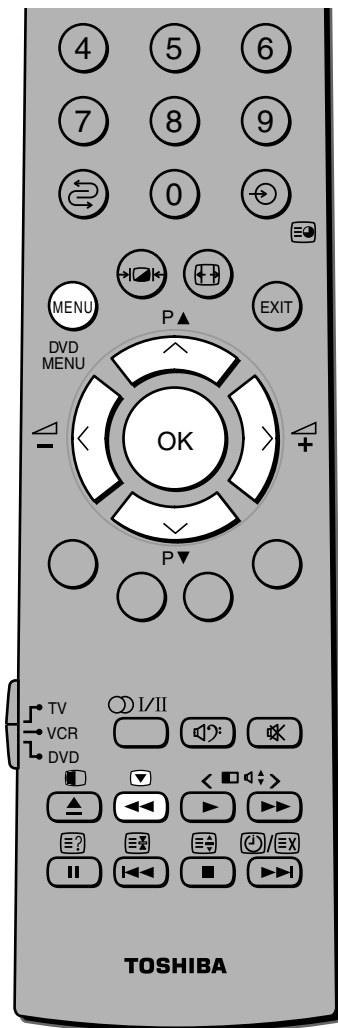

You can change the tone of the picture by selecting from three preset color temperatures: Cool, Normal or Warm.

- 1 Press the **MENU** button, then press the < or > button to display the PICTURE menu.
- 2 Press the ∇ or \blacktriangle button to select the Picture settings menu, then press the **OK** button.
- 3 Press the ∇ or \blacktriangle button to select Color Temperature on the 2nd page, then press the < or > button to select mode you prefer.

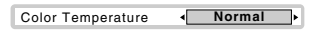
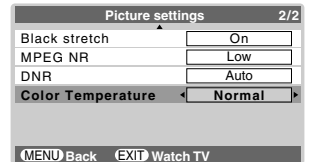

To use the cinema mode

A movie film's picture runs at 24 frames a second, whereas movie software such as DVD, etc., that you enjoy watching on television at home runs at 30 (NTSC) or 25 (PAL) frames a second. To convert this signal to reproduce a smooth motion and picture quality, select the On mode.

Effective signal and setup conditions

- When the Video input mode is selected.
- When the input signal format is 480i and 576i signals.

- 1 Press the **MENU** button, then press the < or > button to display the PICTURE menu.
- 2 Press the ∇ or \blacktriangle button to select Cinema mode, then press the < or > button to select On or Off.

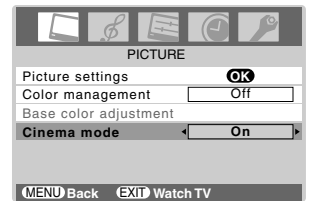

To use the picture still

Press the ∇ button to freeze the picture.

Even if an image is frozen on the TV screen, the pictures are running on the input source. Audio continues to be output as well. To return to a moving picture, press the ∇ button again.

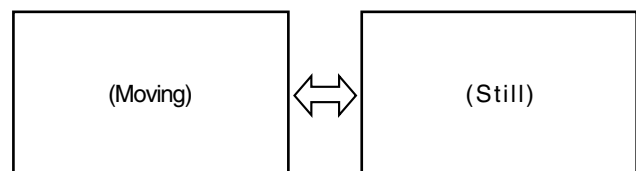

Notes:

- When a DVD movie with subtitle is playing back, the Cinema mode may not work correctly.
- If you use the picture still function except for the purpose of your private viewing and listening, it may infringe the copyright protected by the copyright laws.
- In the PC and BRIDGE MEDIA input modes (see page 29), the picture still function is not available.

To adjust the color management

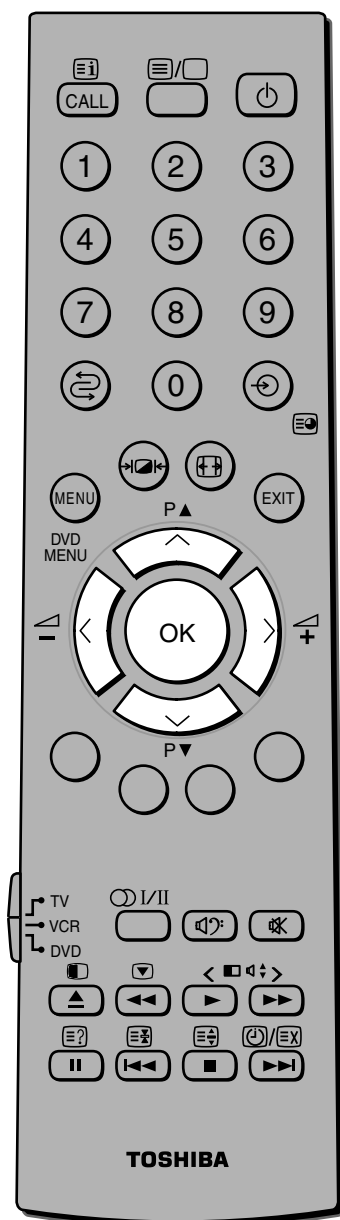

Notes:

- If you select color management Off mode, this mode is not available.
- In the PC input mode (see page 29), this mode is not available.

You can adjust the picture color quality by selecting from 6 base color adjustments : Red, Green, Blue, Yellow, Magenta, Cyan.

- 1 From the PICTURE menu, press the \downarrow or \uparrow button to select Color management.
- 2 Press the \leftarrow or \rightarrow button, then press the \leftarrow or \rightarrow button to select On.
- 3 Press the **OK** button, then press the \downarrow or \uparrow button to select Base color adjustment.
- 4 Press the **OK** button, then press the \downarrow or \uparrow button to select an item you want to adjust.
- 5 Press the \rightarrow button, then press the \leftarrow or \rightarrow button to select Hue or Saturation.
- 6 Press the \downarrow or \uparrow button to adjust the settings as required.

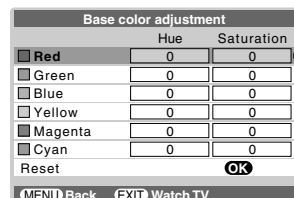
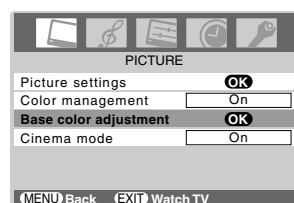
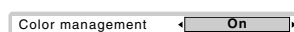
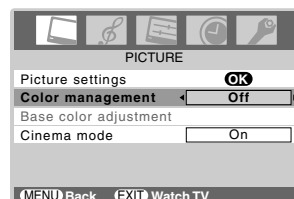

To reset the base color adjustment

The Reset function adjusts the base color adjustment to the factory settings.

- 1 From the Base color adjustment menu, press the \downarrow or \uparrow button to select Reset.
- 2 Press the **OK** button.

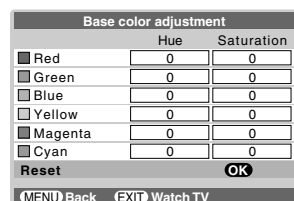

Sound adjustment

MTS (Multi-channel TV Sound) setting

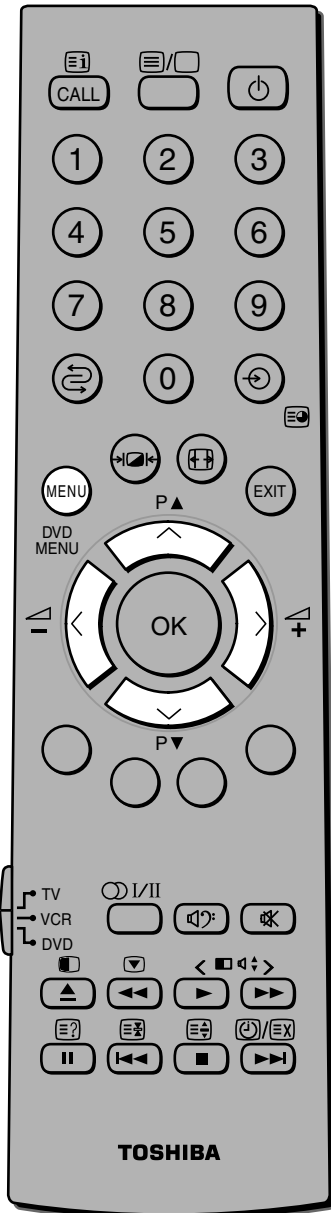

Setting the MTS mode:

Auto mode

The MTS auto mode automatically recognize stereo/bilingual programs depending on the broadcast signal.

- 1 Press the **MENU** button, then press the < or > button to display the SOUND menu.
- 2 Press the ∨ or ∧ button to select MTS, then press the < or > button to select Auto or Mono.

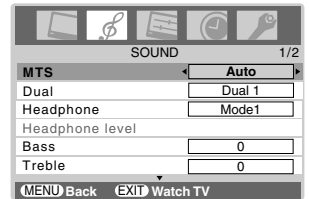

Mono mode

If you experience noise or poor reception of any stereo/bilingual program, set the MTS mode to Mono. Noise will be reduced and reception may improve.

Note:

If you experience noise with a particular program on whose channel reception is usually good, try setting MTS mode to Auto, then switch the /II button to Mono (monaural) (see page 25).

Selecting the dual 1 or dual 2 mode

You can hear only dual 1 or dual 2 sound selected, whenever bilingual programs are received.

- 1 Press the **MENU** button, then press the < or > button to display the SOUND menu.
- 2 Press the ∨ or ∧ button to select Dual, then press the < or > button to select Dual 1 or Dual 2.

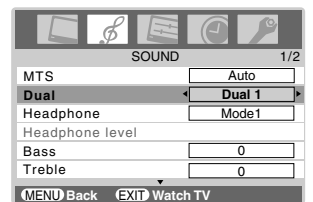

Notes:

- When the MTS setting is in Mono mode, the Dual menu is not selectable.
- The Dual menu setting status remains even if the TV is turned off.

Stereo/Bilingual selection

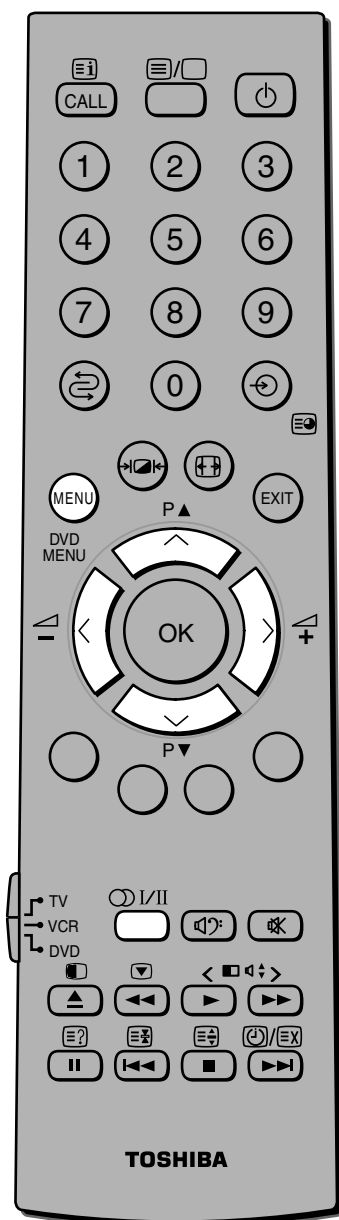

To select the stereo programs:

- 1 When a stereo program is received, Stereo appears.
- 2 Press the button to select the stereo/monaural mode. Stereo and Mono appear cyclically on the screen.

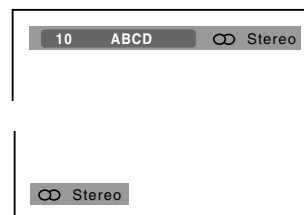

To select the bilingual programs:

- 1 When a bilingual program is received, Dual appears.
- 2 Press the button to select the sound to be heard. The sound differs according to the transmission system: NICAM or German stereo/bilingual broadcast. Dual 1, Dual 2 and Mono appear cyclically on the screen.

Display	Sound to be heard	
	NICAM	German stereo/bilingual broadcast
Dual 1	Sub I sound	Main sound
Dual 2	Sub II sound	Sub sound
Mono	Main sound	—

Note:

These settings are not stored in the TV memory.

Sound quality adjustment

To adjust the sound quality:

- 1 Press the **MENU** button, then press the **<** or **>** button to display the SOUND menu.
- 2 Press the **∨** or **∧** button to select Bass, Treble or Balance.
- 3 Press the **<** or **>** button to adjust the level.



Selection	< Pressing	>
Bass	weaker	stronger
Treble	weaker	stronger
Balance	decreases the right channel	decreases the left channel

Sound adjustment (continued)

To select the audio output

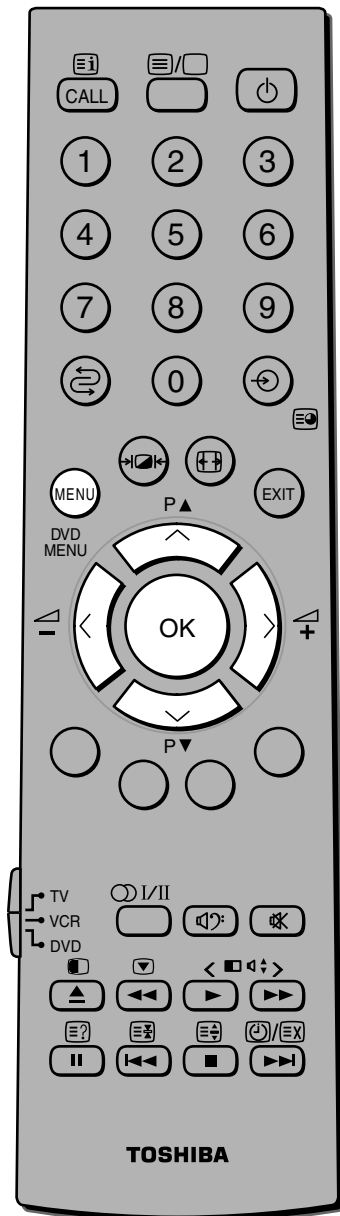

With the audio output function "Variable", you can use the TV's remote controller to adjust the sound volume of the external audio system connected (see page 48).

To select the sound volume from AUDIO OUT terminals:

- 1 Press the **MENU** button, then press the < or > button to display the SET UP menu.
- 2 Press the ∇ or \blacktriangle button to select AV connection, then press the **OK** button to display the AV connection menu.
- 3 Press the ∇ or \blacktriangle button to select Audio output, then press the < or > button to select Variable or Fixed.

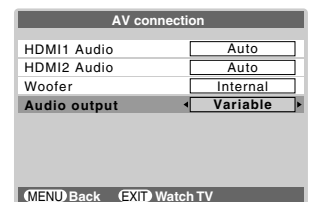
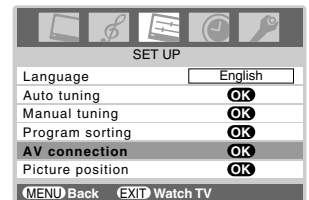

Note:

Make sure the volume control of your audio amplifier is set to a moderate listening level.

To select the HDMI audio mode

You can select sound of the HDMI and DVI device audio connected terminals (see page 52) from three modes : Auto, Digital and Analogue.

- 1 Press the **MENU** button, then press the < or > button to display the SET UP menu.
- 2 Press the ∇ or \blacktriangle button to select AV connection, then press the **OK** button to display the AV connection menu.
- 3 Press the ∇ or \blacktriangle button to select HDMI 1 Audio or HDMI 2 Audio, then press the < or > button to select Auto, Digital or Analogue.

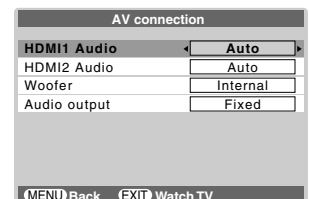
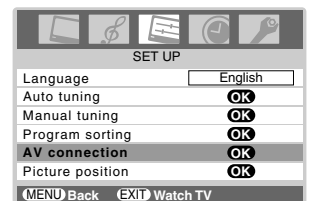

To use the WOW surround sound

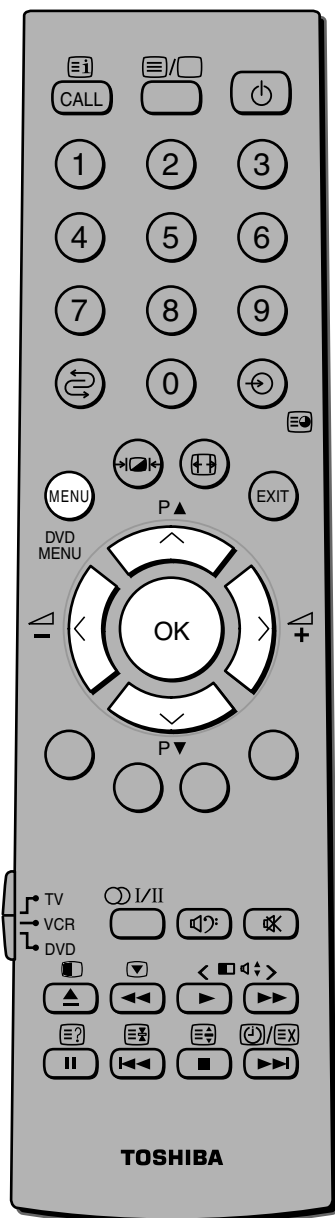

Notes:

- If the broadcast is monaural, the SRS 3D effect does not work.
- WOW, SRS and  symbol are trademarks of SRS Labs, Inc.
- WOW technology is incorporated under license from SRS Labs, Inc.

WOW is a special combination of SRS Labs audio technologies that creates a thrilling surround experience with deep, rich bass from stereo sound sources. Your TV's audio will sound fuller, richer and wider.

- 1 Press the **MENU** button, then press the **<** or **>** button to display the SOUND menu.
- 2 Press the **∨** or **∧** button to select WOW on the 2nd page, then press the **OK** button.
- 3 Press the **∨** or **∧** button to select an item you want to adjust, then press the **<** or **>** button to adjust the settings as required.

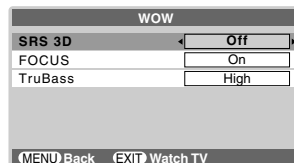
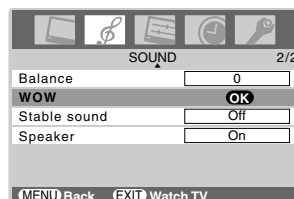

- SRS 3D: To turn On or Off the surround effect.
- FOCUS: To turn On or Off the surround effect.
- TruBass: To select your desired bass expansion level (Off, Low or High).

To use the stable sound

When the signal source is changed, the Stable sound function limits the high volume level to prevent extreme changes in volume. For example, this will prevent the sudden increase in volume that often happens when a TV program switches to a commercial.

- 1 From the SOUND menu, press the **∨** or **∧** button to select Stable sound on the 2nd page.
- 2 Press the **<** or **>** button to select On or Off.

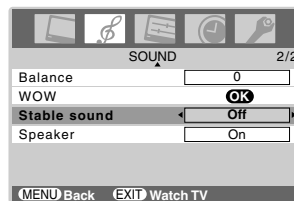

To activate/deactivate the speaker

Use this function to turn the TV speakers off when you connect an audio system (see page 48).

- 1 From the SOUND menu, press the **∨** or **∧** button to select Speaker on the 2nd page.
- 2 Press the **<** or **>** button to select On or Off.

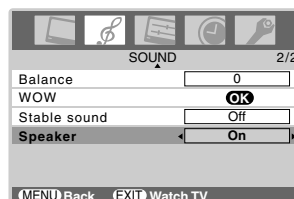

Sound adjustment (continued)

Woofer internal/external mode, Bass boost, Woofer system

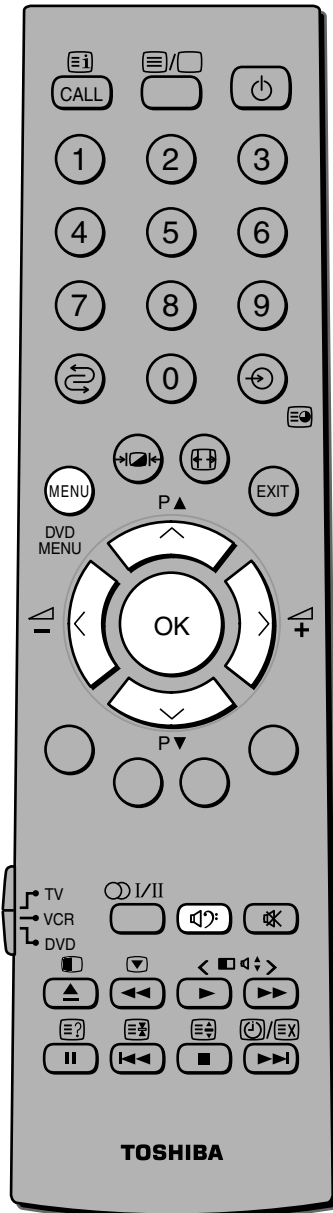
Note:

The Bass Boost effect is active only when the sound outputs from the speaker or an external woofer system.

To select the woofer internal/external mode:

- 1 Press the **MENU** button, then press the < or > button to display the SET UP menu.
- 2 Press the ∨ or ∧ button to select AV connection, then press the **OK** button to display the AV connection menu.
- 3 Press the ∨ or ∧ button to select Woofer, then press the < or > button to select Internal or External.
 - Internal is to use the bass boost.
 - External is to use an external woofer system.

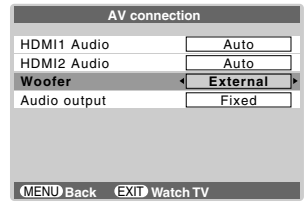

To use the bass boost:

- 1 Select the woofer internal mode as shown above.
- 2 Press the button to display Bass boost level.
- 3 While the Bass boost display is on the screen, press the < or > button to adjust the Bass boost level.
- 4 To turn off the Bass boost, press the button to display Bass boost Off.

To use an external woofer system:

- 1 Connect an external woofer to the "WOOFER OUT" output terminal located on the rear of the TV (see page 48).
- 2 Select woofer external mode from the AV connection menu.
- 3 Press the button to display External Woofer level, then press the < or > button to adjust the External Woofer level.
- 4 To turn off the External Woofer, press the button to display External Woofer Off.

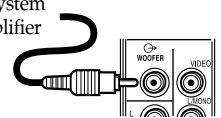
Woofer system with amplifier



Input selection

Input selection

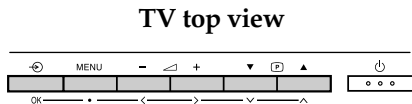

Note:

When the component video input, HDMI 1, HDMI 2, PC or BM input mode is selected, the MONITOR OUT output terminals (see page 48) output audio signal only.

To select input source:

- 1 Press and hold the button or press the **OK** button on the remote control until the video input mode list appears on the screen, then press the \downarrow or \uparrow button to select appropriate input source (or press the button on the TV top panel or the button on the remote control repeatedly to select required input source directly).
- 2 Press the **OK** button.
 1 (1), video 1 input),
 2 (2), video 2 input),
 C1 ((C1), COMPONENT VIDEO INPUT),
 C2 ((C2), COMPONENT VIDEO INPUT),
 HDMI 1 (HDMI 1 input),
 HDMI 2 (HDMI 2 input),
 PC (RGB/PC, PC input),
 BM (BRIDGE MEDIA Input)

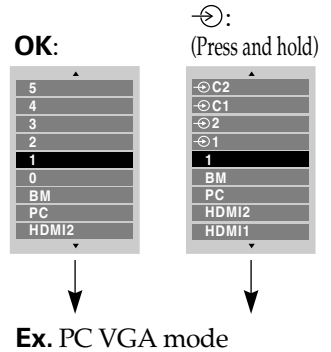

Ex. PC VGA mode

Manual setting:

- 1 Press the **MENU** button, then press the \leftarrow or \rightarrow button to display the SET UP menu.
- 2 Press the \downarrow or \uparrow button to select Manual setting, then press the **OK** button.
- 3 Press the \leftarrow or \rightarrow button to select an item, then press the \uparrow or \downarrow button to select the item as shown below.

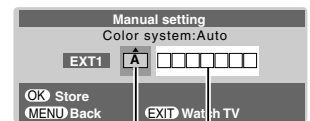
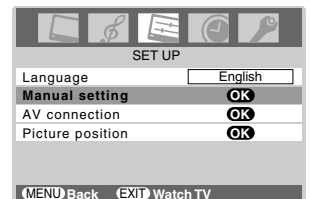

- A. Color System
 Confirm that color system is set to "A" (Auto). If not, select "A" with the \uparrow or \downarrow button.
- B. Video label
 The video label allows you to label each input source for your TV.

To change or create video labels:

- 1) Press the \uparrow or \downarrow button repeatedly to select a character for the first space, then press the \rightarrow button.

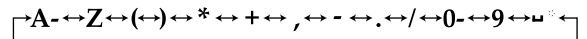

*(blank space)

- 2) Repeat step 1) to enter the rest of the characters.
 If you would like a blank space in the label name, you must choose a blank space from the list of characters.

Press the **OK** button to store your settings.

Timer, Gray screen

Timer

The Timer is especially useful if you want the TV to turn itself on or off after a selected period of time. Activation of the Timer is indicated by the green "On-timer indicator", on the front of the TV (see page 9).

TV top view

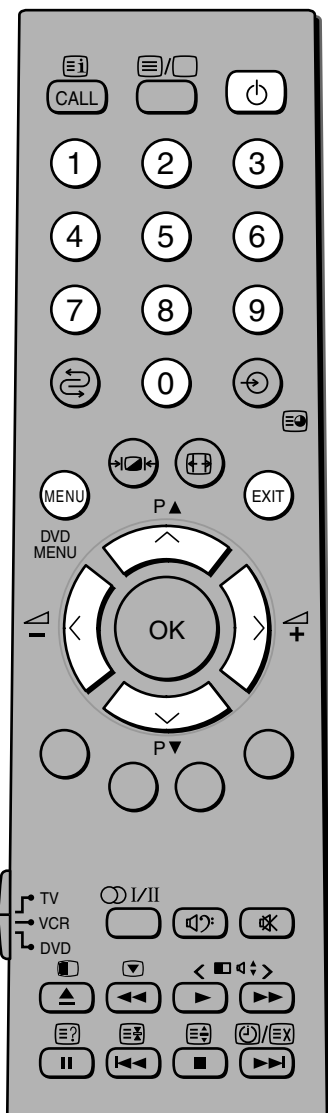
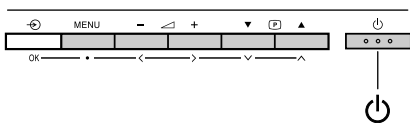

To select the timer menu:

- 1 Press the **MENU** button, then press the < or > button to display the **TIMER** menu.
- 2 Press the ∨ or ∧ button to select the required timer mode (Sleep timer (Turn off the TV) or On timer).
- 3 Press the **Number** buttons (0-9), < or > button to set the On or Off delay time, e.g. on in 30 minutes and On timer Position 3 selected.
- 4 Press the **EXIT** button to exit the menu. When setting the On timer, press the ∨ or ∧ button to select the On timer Position and enter the program position number you want to watch. Set the Standby mode by pressing the ⏻ button on the remote control or ⏻ Power button on the TV.

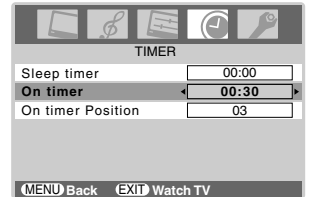

Note:

The time display will set by 10 minutes, up to 12 hours 50 minutes.

To activate gray screen

With the gray screen function On, the screen will automatically turn gray and the sound will be muted when no signal is being received.

- 1 Press the **MENU** button, then press the < or > button to display the **FUNCTION** menu.
- 2 Press the ∨ or ∧ button to select Gray screen.
- 3 Press the < or > button to select On or Off.

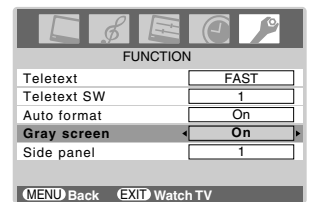

Note:

In the PC input mode (see page 29), the Gray screen is not available.

Side panel adjustment

Side panel adjustment

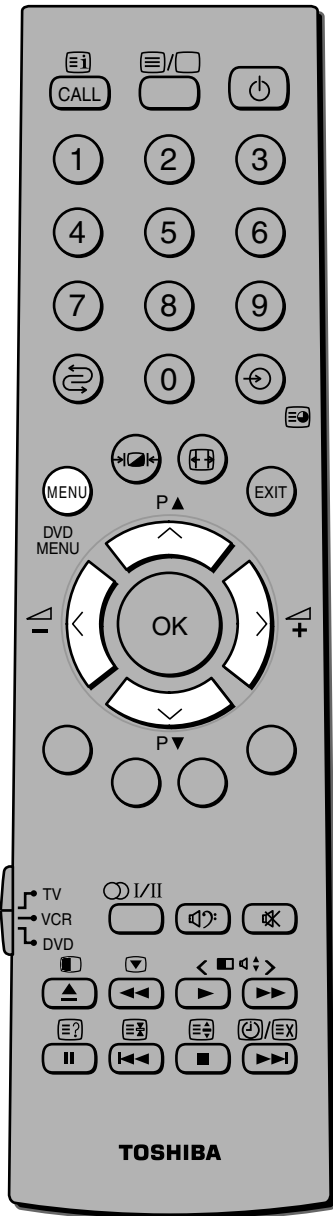

You can adjust the brightness of side panel in 14:9 or 4:3 mode.

To adjust the side panel setting:

- 1 Press the **MENU** button, then press the < or > button to display the FUNCTION menu.
- 2 Press the ∨ or ∧ button to select Side panel.
- 3 Press the < or > button to adjust the settings as required.

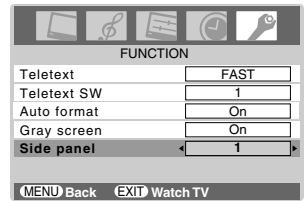

To use the auto format

When the TV receives a true HDMI signal picture and the auto format is On, it will automatically be displayed in HDMI signal format, irrespective of the TV's previous setting. This function is only available for PAL and PAL-DVD (HDMI signal format) input signals.

- 1 From the FUNCTION menu, press the ∨ or ∧ button to select Auto format.
- 2 Press the < or > button to select On or Off.

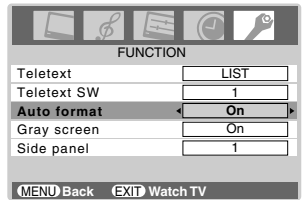

Teletext - Setting up

- This TV has a multi-page teletext memory, which takes a few moments to load and it offers two ways of viewing Teletext FAST and LIST which are explained on page 34.

Teletext mode

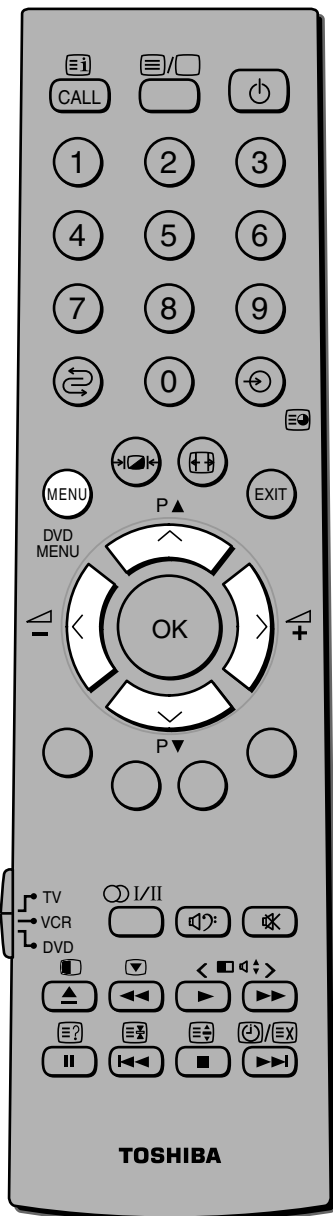

To select teletext mode:

Select a channel position with the desired teletext service.

- 1 Press the **MENU** button, then press the \downarrow or \uparrow button to select Teletext.

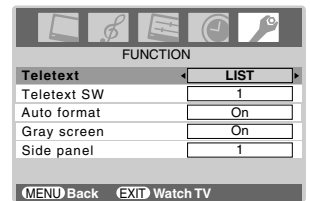

- 2 Press the \downarrow or \uparrow button to select Teletext.
- 3 Press the \leftarrow or \rightarrow button to select FAST or LIST mode.

Note:

When you are watching the teletext program, SET UP menu and FUNCTION menu are not selectable.

About Teletext

Teletext general information

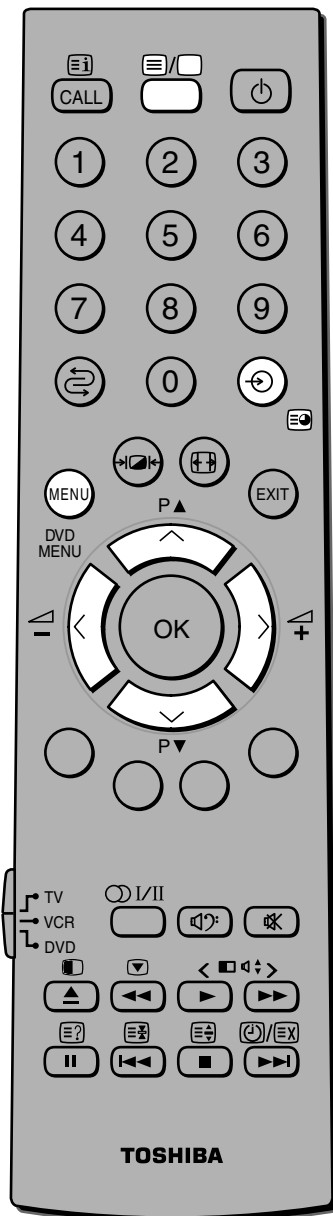

Note:

If you press the  button while the picture mode is activated, this mode will be cancelled.

button:

Pressing the  button once will bring up the teletext screen. Press again to superimpose the teletext over a normal broadcast picture. Press again to return to normal TV mode. You need to return to normal viewing if you wish to change channels.





When you first press the  button to access the text service, the first page you see will be the initial page.

In **FAST** mode, this displays the main subjects available and their relevant page numbers.

In **LIST** mode, you will see the page numbers currently stored on the **each color** button.



Sub-pages:

Once in this chosen page, if there are sub-pages they will automatically load into memory without changing the one you are reading. If there are many sub-pages, it will take a long time for them all to load and this will depend on the speed with which the broadcaster transmits them.





To access the sub-pages in memory, press the  () button, then use the  and  buttons to view them.

Teletext SW adjustment

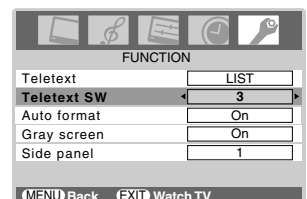
If reception is weak, the picture may appear blurred, and text may not appear clearly on the screen. In this case, use this function to make text appear clearer.

- 1 Press the **MENU** button, then press the  or  button to display the **FUNCTION** menu.



- 2 Press the  or  button to select **Teletext SW**, then press the  or  button to adjust 1, 2 or 3 modes.

Notes:

- This function may not be available in some cases.
- Only in the antenna input signal mode, this function is available.

Teletext - FAST and LIST modes

Using FAST mode

There are two Modes: FAST will display FASTEXT, if available. LIST will display your four favorite pages. In either mode, as an alternative to the colored buttons, you can access a page by entering a 3-digit number, using the **Number** buttons on the remote control, or to advance to the next page, press the **P▲** (^) button, to go back to the previous page press the **P▼** (v) button.

To change between FAST and LIST, see page 32.

Press the  button to access teletext.

If FASTEXT is available, you will see 4 colored titles at the base of the TV screen. To access any given subject, simply press the relevant colored button on the remote control.

If FASTEXT is not available, you can access any page simply by entering a 3-digit page number or pressing the corresponding colored button.

For further information on your particular text system(s), see the broadcast teletext index page or consult your local Toshiba dealer.

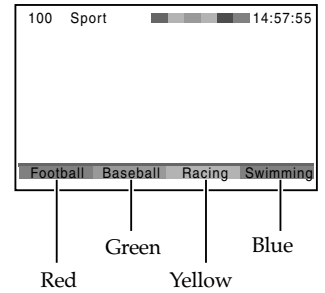

Using LIST mode

1 Press the  button to access teletext.

The four choices at the bottom of the screen are now number – 100, 200, 300 and 400, which have been programmed into the TV's memory.

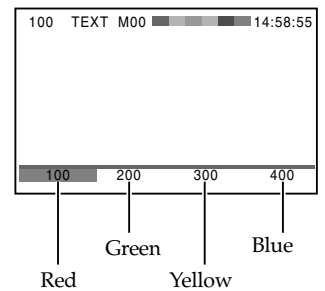

2 To view these pages, use the colored prompt buttons. e.g. press the Green button to view page 200.

3 If you want to change these stored pages, press the colored button for the color you want to change. e.g. Press the Green button and enter the 3-digit number.

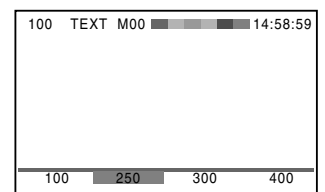

This number will change in the top left of the screen and in the colored highlight.

4 Press the **OK** button to store your choice. The bars at the bottom of the screen will flash white.

5 You may view other pages by simply entering the 3-digit page number – but NEVER press the **OK** button or you will lose the favorite already stored.

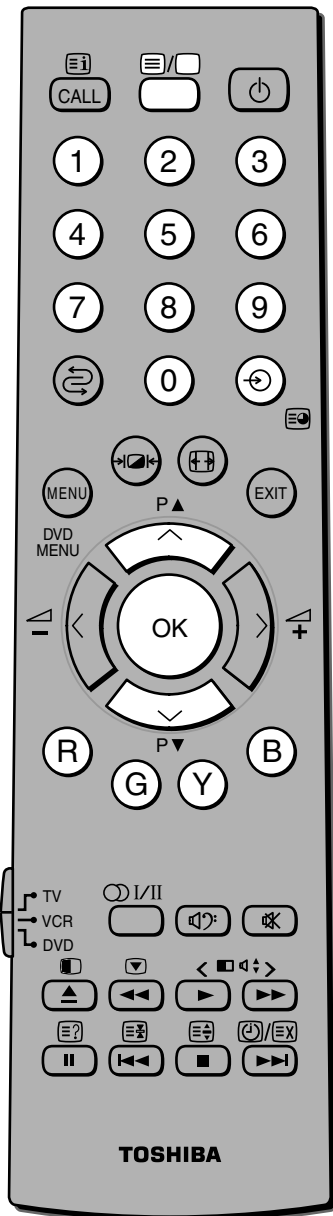

Teletext - Control buttons

- Below is an introduction to the teletext buttons on your remote control and their functions.

Teletext buttons on the remote control

Note:

It will not be possible to change program position while in Teletext mode, you will have to cancel the teletext first by pressing the  button to return to a normal TV picture.

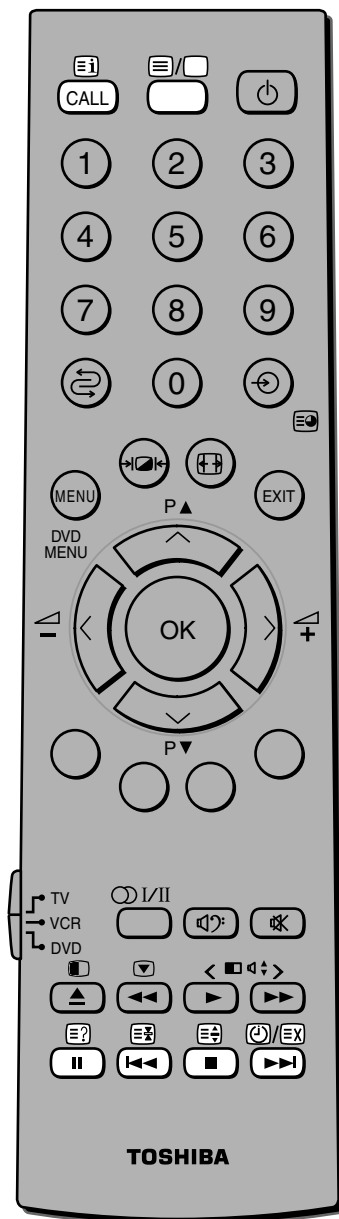

To display a page of teletext:

Press the  button to display teletext. Press again to superimpose the teletext over a normal broadcast picture. Press again to return to normal TV mode.

To display an index/initial page:

In FAST-mode

Press the  button to access the index page. The one displayed is dependant on the broadcaster.

In LIST-mode

Press the  button to return to the 100 page or initial page.

To reveal concealed text:

Some pages cover topics such as quizzes and jokes. To discover the solutions, press the  button.



To hold a wanted page:

This function is included as it is part of the broadcast teletext system but you will not need it as this TV allows you to control the display of sub-pages.

To enlarge the teletext display size:

Press the  button once to enlarge the top half of the page, press again to enlarge the bottom half of the page. Press again to revert to the normal size.

To select a page while viewing a normal picture:

When in teletext mode, if a page selection is made and then the  button is pressed, a normal picture will be displayed. The TV will indicate when the page is present by displaying the title bar of the text page at the top of the screen. Press the  button to view the page.

To select the time display:

If you press the  button while watching a normal TV broadcast, you will see a time display from the broadcaster. It will remain on the screen for about 5 seconds.

9:56 and 25 seconds p.m.

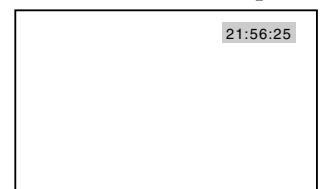

Note:

If you press the  button while this mode is activated, this mode will be cancelled.

BRIDGE MEDIA using

- The "BRIDGE MEDIA" function can be used to play back still or motion picture/sound memorized on "SD" Memory Cards, "Memory Stick" cards or "SmartMedia" cards by a digital still camera.
- The picture may not be reproduced properly depending on memory conditions.
If the picture cannot be displayed on the screen, you will see an "X" mark on the screen.
The edge of the picture may be hidden depending on the aspect ratio of the selected.
- If a full screen picture is displayed for more than 30 minutes, the screen saver will be activated (factory set).
(The motion picture appears on the screen.) (see page 43)

To use the BRIDGE MEDIA

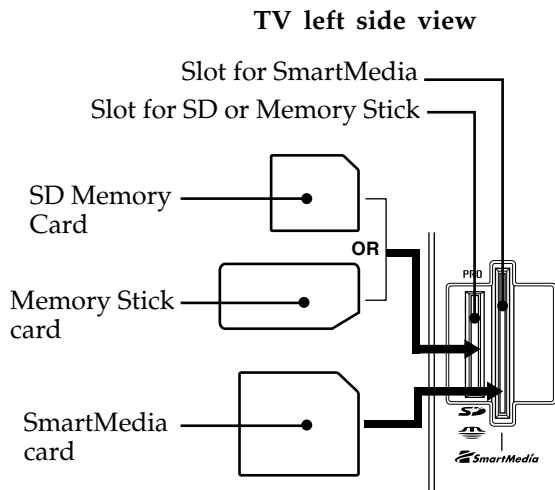

To remove the memory card

- Push the SD Memory Card or Memory Stick card.
- Pull out the SmartMedia card.

Notes:

- While the picture from the memory card is on the screen, never turn off the TV.
- While the picture from the memory card is on the screen, never take out the memory card.

Memory card format

Item		Format
SD Memory Card		8/16/32/64/128/256/512 MB
Memory Stick	Memory Stick	16/32/64/128 MB
	Memory Stick (magic gate/high speed data transmission)	16/32/64/128 MB
	Memory Stick (magic gate)	32/64/128 MB
	Memory Stick PRO	256/512 MB and 1GB
	Memory Stick (with memory select)	128 MB × 2
SmartMedia		8/16/32/64/128 MB

- About Memory Stick: Magic Gate and high speed data transmission are not available on this TV.

Still picture format

Item	Format
Memory Format	JPEG
File Format	Exif ver 2.2
Compatibility	DCF ver 1.0
Extension	JPG
Number of Picture Elements	H: 160 ≤ x ≤ 4096 V: 120 ≤ x ≤ 4096
Number of files	65535
Applicable maximum capacity	1GB

Motion picture format

Item		Format
Memory Format		Motion JPEG/MPEG-1
File Format		AVI/MOV (QuickTime)/MPEG-1
Extension		avi/mov/mpg
Number of Picture Elements and Frames Rate	Motion JPEG	VGA 640 × 480 (0 < x ≤ 10 fps) QVGA 320 × 240 (0 < x ≤ 15 fps) QQVGA 160 × 120 (0 < x ≤ 20 fps)
	MPEG-1	CIF 352 × 288 (0 < x ≤ 8 fps)
Audio Format		PCM/MPEG-1 Audio
Audio Sampling Frequency		5 - 48 kHz

- is a trademark of Toshiba Corporation.
- is a trademark of SD Card Association.
- is a trademark of Sony Corporation.

- Pictures on the memory card newly inserted will appear on the screen.
- If you use this function for a purpose other than your private viewing or listening, it may infringe copyright laws.
- You can also select BRIDGE MEDIA by pressing the  button (see page 29).
- In the BRIDGE MEDIA mode, the Auto tuning, Manual tuning and Program sorting disappear automatically in the SET UP menu.

To use the BRIDGE MEDIA (still picture)

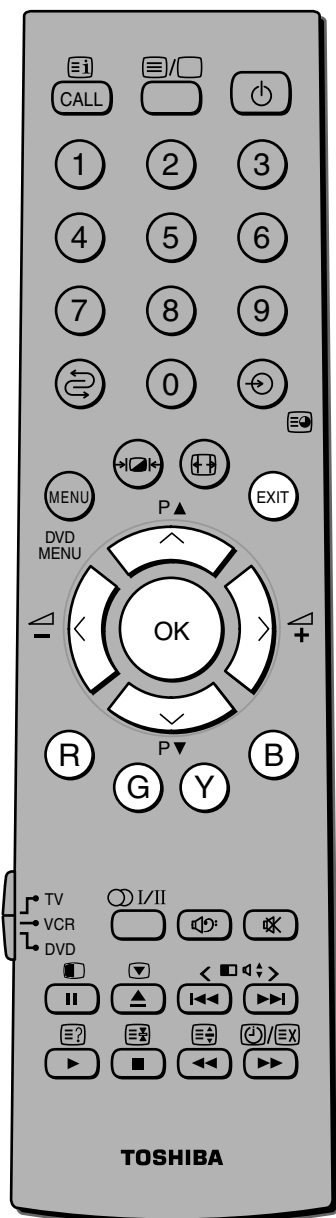

Notes:

- To exit the BRIDGE MEDIA, press the  button.
- To return to the previous menu, press the **EXIT** button.

To select the full screen picture:

Insert the SD Memory Card or Memory Stick card into the slot.
Insert the SmartMedia card into the slot.

- 1 The index menu appears on the screen, then press the \downarrow , \uparrow , \leftarrow or \rightarrow button to select the screen pictures.
If the memory card contains still pictures, the  mark appears on the screen.

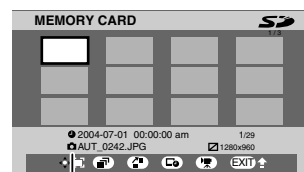

- To change to the MEMORY CARD menu, press the **EXIT** button.
- To change to the motion picture, press the **B** button. If there is no motion picture, you cannot change the mode.

- 2 Press the **OK** button.
Press the \downarrow or \uparrow button to select another full screen picture you want to see on the screen.

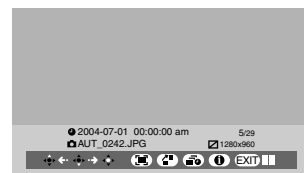

To use the slide show:

- 1 From the full screen picture, press the **R** button.
- 2 Press the **Y** button to display the Slideshow set up.
Press the \downarrow , \uparrow , \leftarrow or \rightarrow button to select 5 sec., 10 sec., 15 sec., 20 sec., 30 sec., or 60 sec.
- 3 Press the **OK** button, the Slide show will start.

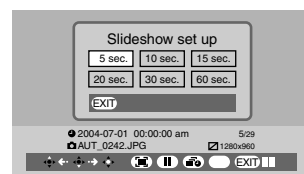

To stop the slide show

Press the **R** or **G** button.

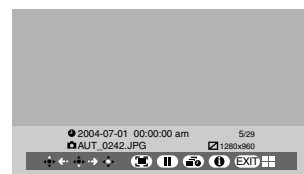

Notes:

- If you select "Slide" mode in the index menu, the Slideshow set up times may differ from the times you set in step 2.
- The MEMORY CARD menu variation.

Ex. SD and SmartMedia

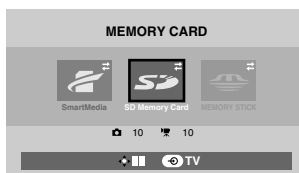

Ex. SmartMedia and Memory Stick

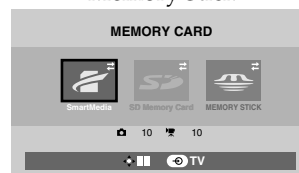

BRIDGE MEDIA using (continued)

To use the BRIDGE MEDIA (still picture) (continued)

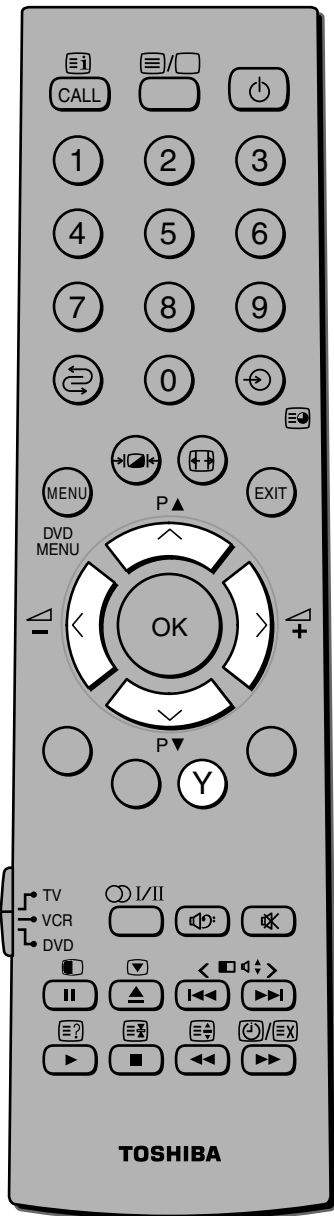

To use the zoom mode:

From the full screen picture, press the **Y** button to display the picture with a frame. Each time you press the **Y** button, the picture zooms as follows:

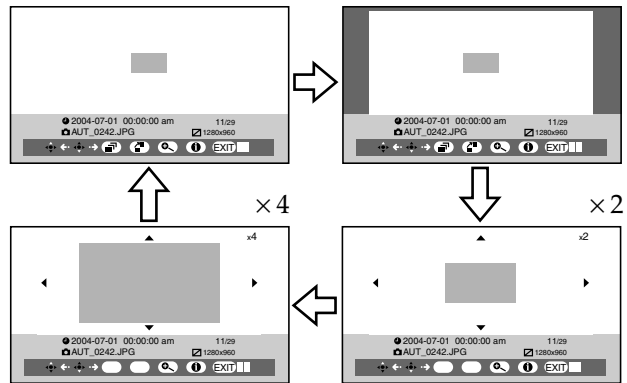

To select the picture position:

When in the $\times 2$ zoom mode or $\times 4$ zoom mode, you can select the picture position. Press the \downarrow , \uparrow , \leftarrow or \rightarrow button to select the picture position.

Ex. $\times 2$ zoom mode

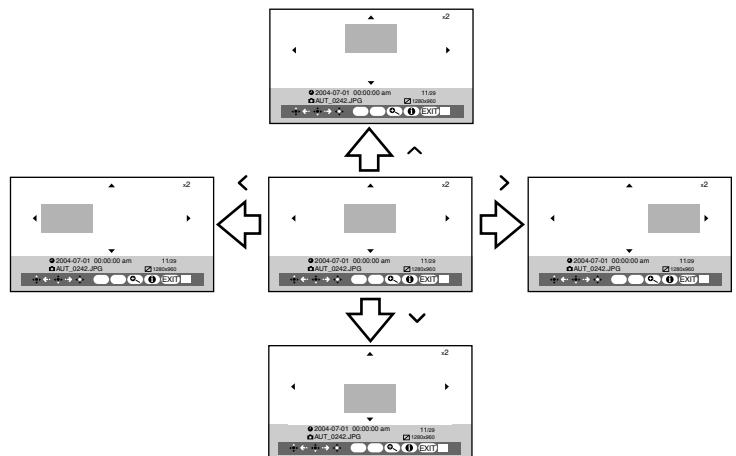

To use the BRIDGE MEDIA (still picture) (continued)

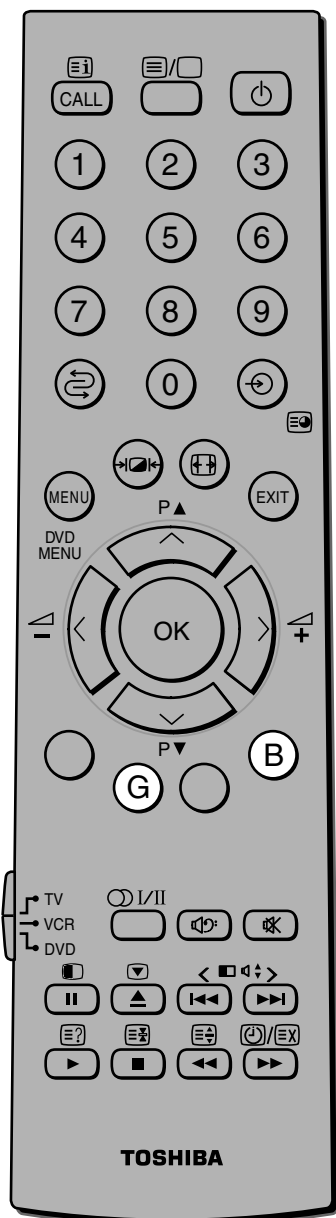

To select the information format:

Each time you press the **B** button, the on-screen information will change as follows:

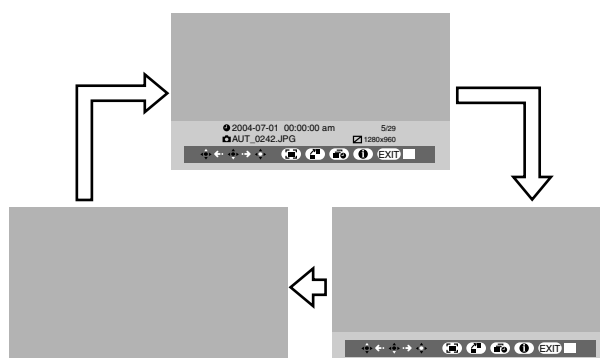

To select the rotation picture format:

Each time you press the **G** button, the picture rotates clockwise by 90°:

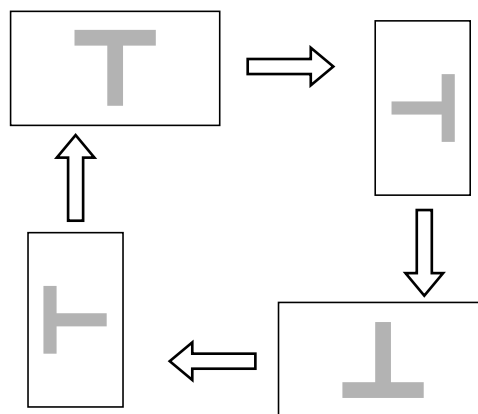

Note:

This function also operates in the index menu.

BRIDGE MEDIA using (continued)

To use the BRIDGE MEDIA (motion picture)

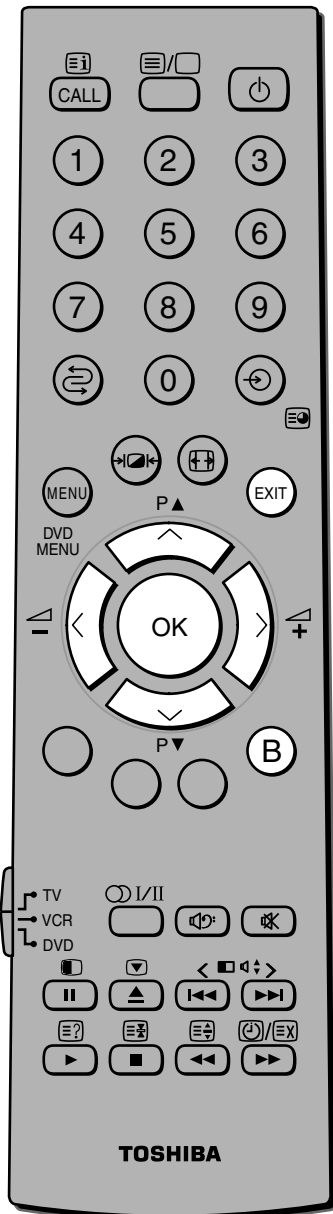

Features

To select the full screen motion picture and audio:

Insert the SD Memory Card or Memory Stick card into the slot. Insert the SmartMedia card into the slot.

- 1 The index menu appears on the screen, then press the \downarrow , \uparrow , \leftarrow or \rightarrow button to select the screen pictures. If the memory card contains motion picture and audio, the  mark appears on the screen.

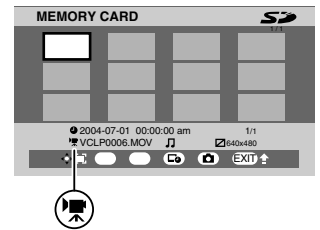

- To change to the MEMORY CARD menu, press the **EXIT** button.
- To change to the still picture, press the **B** button. If there is no still picture, you cannot change the mode.

- 2 Press the **OK** button, the full screen motion picture with frame and audio starts. Press the \downarrow or \uparrow button to select another full screen motion picture you want to see on the screen.

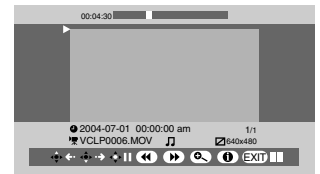

Notes:

- Adjust the sound volume with the \triangle + or \triangle - button.
- The motion picture play back mark () is displayed for several seconds.

To return to the index menu

Press the **EXIT** button.

To freeze the picture and audio:

Each time you press the **OK** button to freeze, the on-screen picture and audio will change as follows:

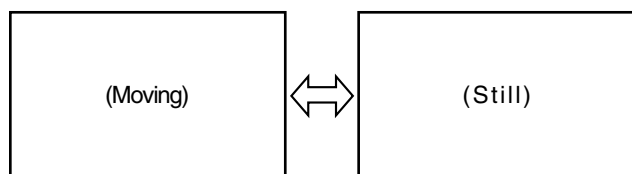

To use the BRIDGE MEDIA (motion picture) (continued)

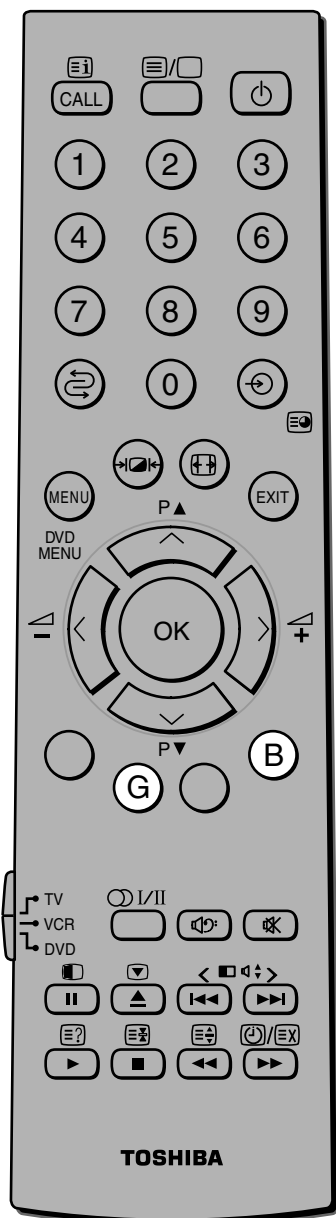

To use the fast forward:

Each time you press the **G** button, the on-screen picture will change as follows:

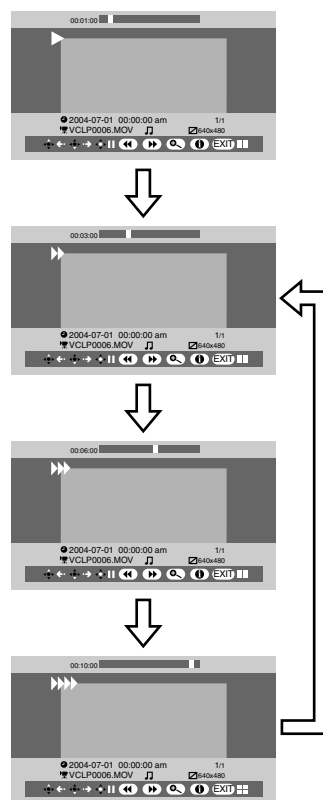

To select the information format:

Each time you press the **B** button, the on-screen information will change as follows:

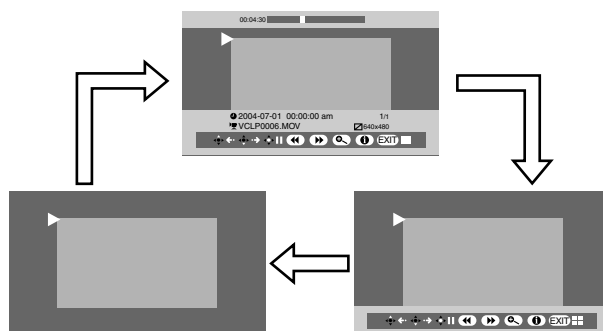

BRIDGE MEDIA using (continued)

To use the BRIDGE MEDIA (motion picture) (continued)

Features

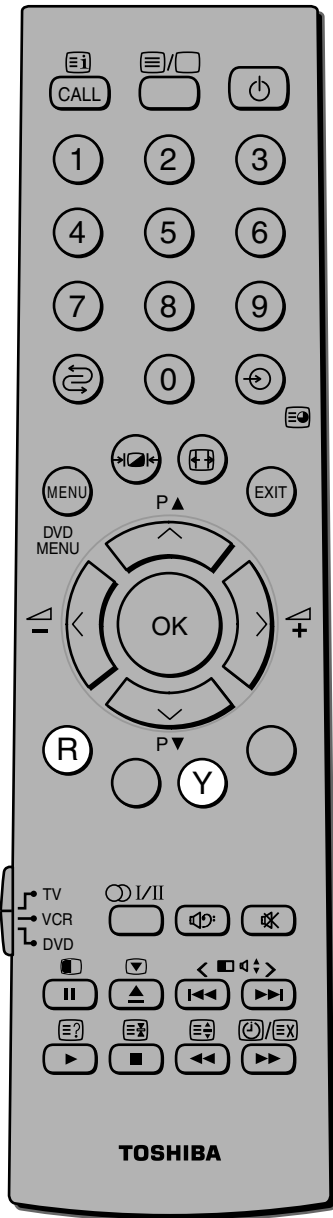

To use the rewind:

Each time you press the **R** button, the on-screen picture will change as follows:

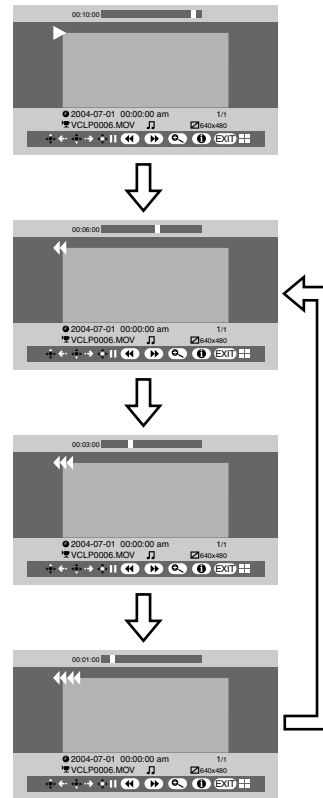

To turn off the frame:

Each time you press the **Y** button, the on-screen frame will change as follows:

Ex. Normal

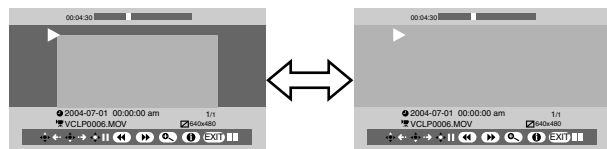

Ex. No information

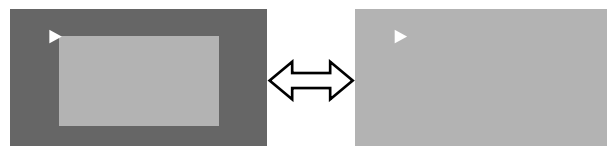

To use the BRIDGE MEDIA (information)

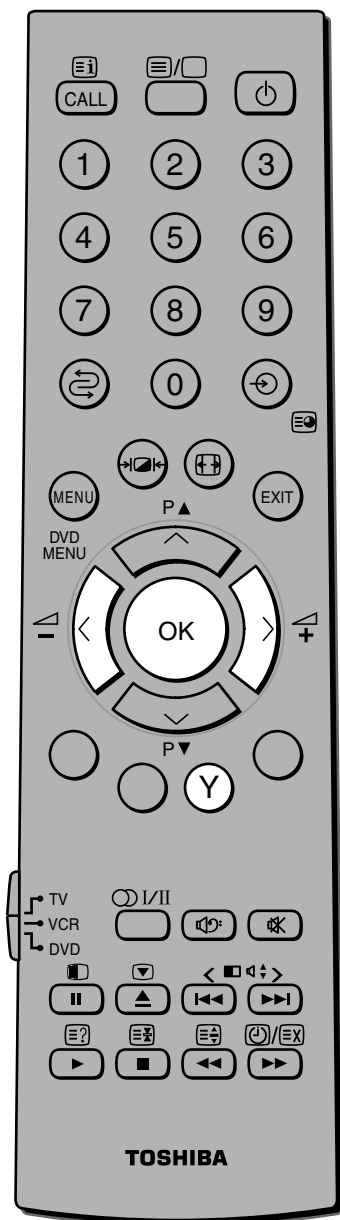

To select the screen saver:

The screen saver function activates by default. A moving picture will appear on the screen.

- 1 From the index menu (still or motion picture), then press the **Y** button to display the ScreenSaver.

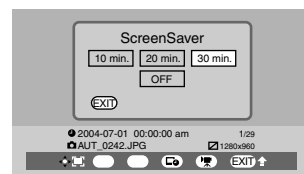

- 2 Press the **<** or **>** button to select 10 min., 20 min., 30 min., or OFF. (30 min: factory set)
- 3 Press the **OK** button to return. The screen will return to the index menu.

Note:

In the slide show or motion picture, the screen saver does not operate.

Alerts:

- **NO IMAGE**
No data to play back
- **NO SD Memory Card**
No insert card
- **NO SmartMedia**
No insert card
- **NO MEMORY STICK**
No insert card
- **NO FILE**
No recorded
- **MEMORY STICK TYPE ERROR**
No accept Memory Stick
- **FILE ERROR**
File broken or irregular file
- **FILE ERROR**
Not accept BM format
- **FILE TYPE ERROR**
No accept file format
- **SD Memory Card ERROR**
BM broken or inverse
- **SmartMedia ERROR**
BM broken or inverse
- **MEMORY STICK ERROR**
BM broken or inverse

To use the memory card:

Note that the operation is not guaranteed for all these memory cards shown in the table.

Toshiba recommend that you back up the data on the memory card before use. (The data of the memory card may be lost by misuse or malfunction of the TV. Toshiba assume no liability for losses incurred by data lost through the use of this TV.)

Double-Window using

- The Double-Window function allows you to split the screen into a Main and Sub window and watch two programs at the same time. You can display the TV program or the video input on the Main and Sub window.
- When you watch one channel simultaneously in the Double-Window mode, differences in image quality between the Main picture and Sub-picture occurs.

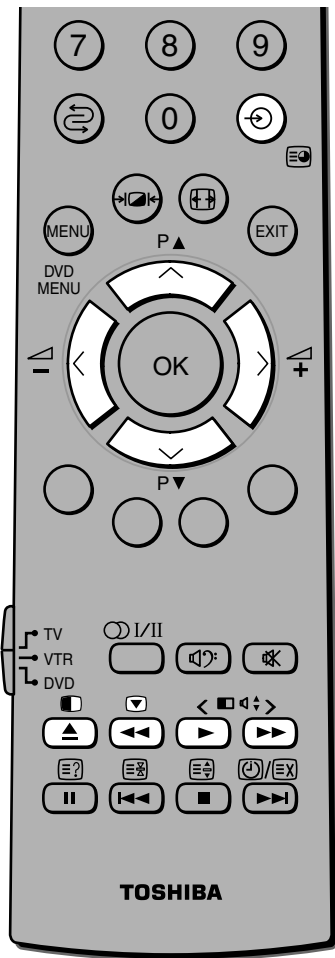

To display the double-window

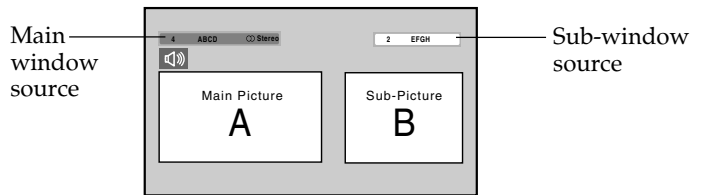

1 Select the TV program you want to watch.

2 Press the  button to display the double-window.



3 Press the    < or > button to select a program position or video input source, or switch and adjust speaker sound for each window (A, B).

Press    <

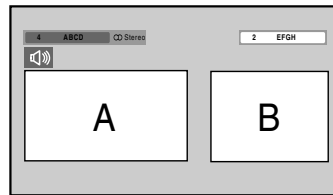

P ▲ ▼, - ⊖: available for A
Speaker sound: A
▲ - +: available for A
▼: A

Press    >

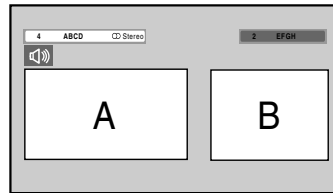

P ▲ ▼, - ⊖: available for B
Speaker sound: A
▲ - +: available for A
▼: B

Press    >

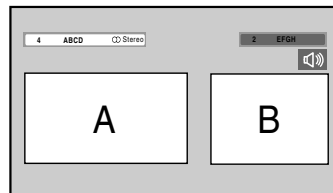

P ▲ ▼, - ⊖: available for B
Speaker sound: B
▲ - +: available for B
▼: B

Press    <

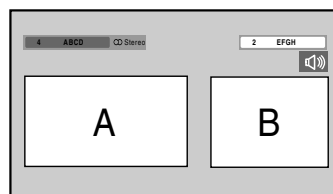

P ▲ ▼, - ⊖: available for A
Speaker sound: B
▲ - +: available for B
▼: A

Notes:

- Only 480i and 576i signals are available for the sub-window sources. If the other signal is received, the message "ⓘ Signal not supported" will be displayed on the screen.
- When you select the TV program of the Sub-window, the sound is monaural only.
- In the PC or BM input mode (see page 29), this mode is not available.
- The still mode will be cancelled if it receives a different input signal when changing program position, or video mode is selected, etc.

To select the headphone mode

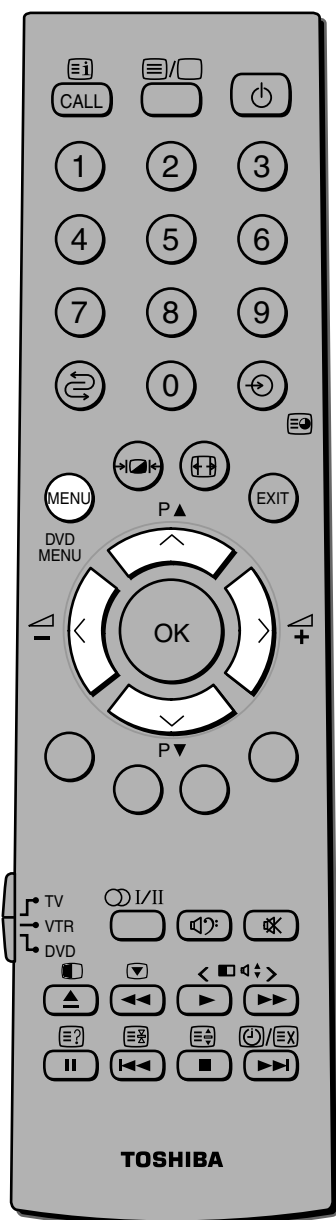

You can select either Mode 1 or Mode 2.
 Mode 1: Linked with the selected window
 Mode 2: Linked with another window

- 1 Press the **MENU** button, then press the < or > button to display the **SOUND** menu.
- 2 Press the ∨ or ∧ button to select **Headphone**, then press the < or > button to select **Mode 1** or **Mode 2**.

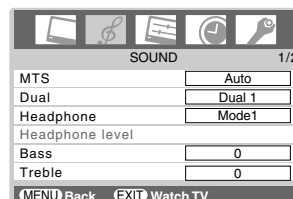

To adjust the headphone volume (Mode 2)

- 1 From the **SOUND** menu, press the ∨ or ∧ button to select **Headphone**. Press the < or > button to select **Mode 2**.
- 2 Press the ∨ or ∧ button to select **Headphone level**.
- 3 Press the < or > button to adjust the **Headphone volume**.

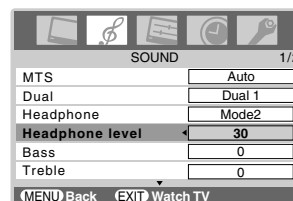

Double-Window using (continued)

To use a headphone

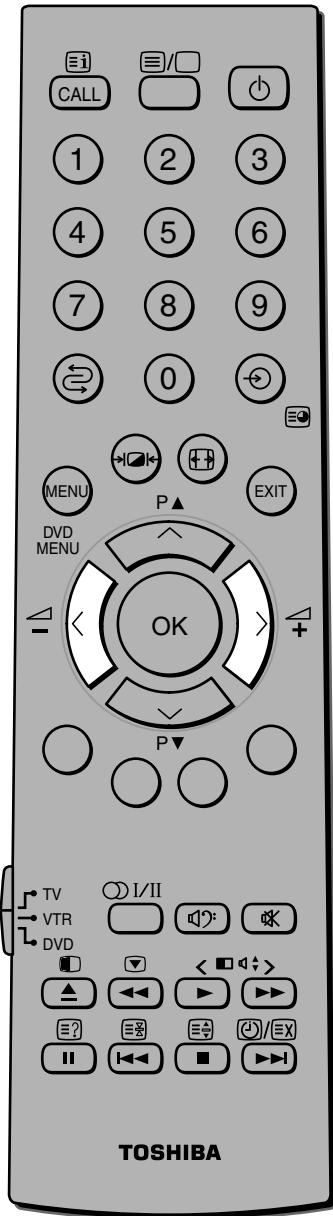

Connect a headphone to the headphone jack on the right side of the TV.

TV right side view

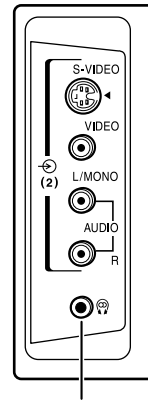

Headphone jack

When in a single window:

Headphone mode	Headphone	Speakers
Mode 1	Sound comes out (◀ - + is available.)	No sound
Mode 2	Sound comes out (Headphone level menu is available.)	Sound comes out (◀ - + is available.)

Headphone sound is the same as speaker sound.

When in Double-Window:

Headphone mode	Headphone	Speakers
Mode 1	A (or B) (◀ - + is available.)	No sound
Mode 2	B (or A) (Headphone level menu is available.)	A (B) (◀ - + is available.)

A: Main window B: Sub-window

Side connections

- You can connect a wide variety of auxiliary equipment via the terminals located on the right side of the panel → (2).

Connection example

Please always refer to the owner's manual of the equipment to be connected for full details.

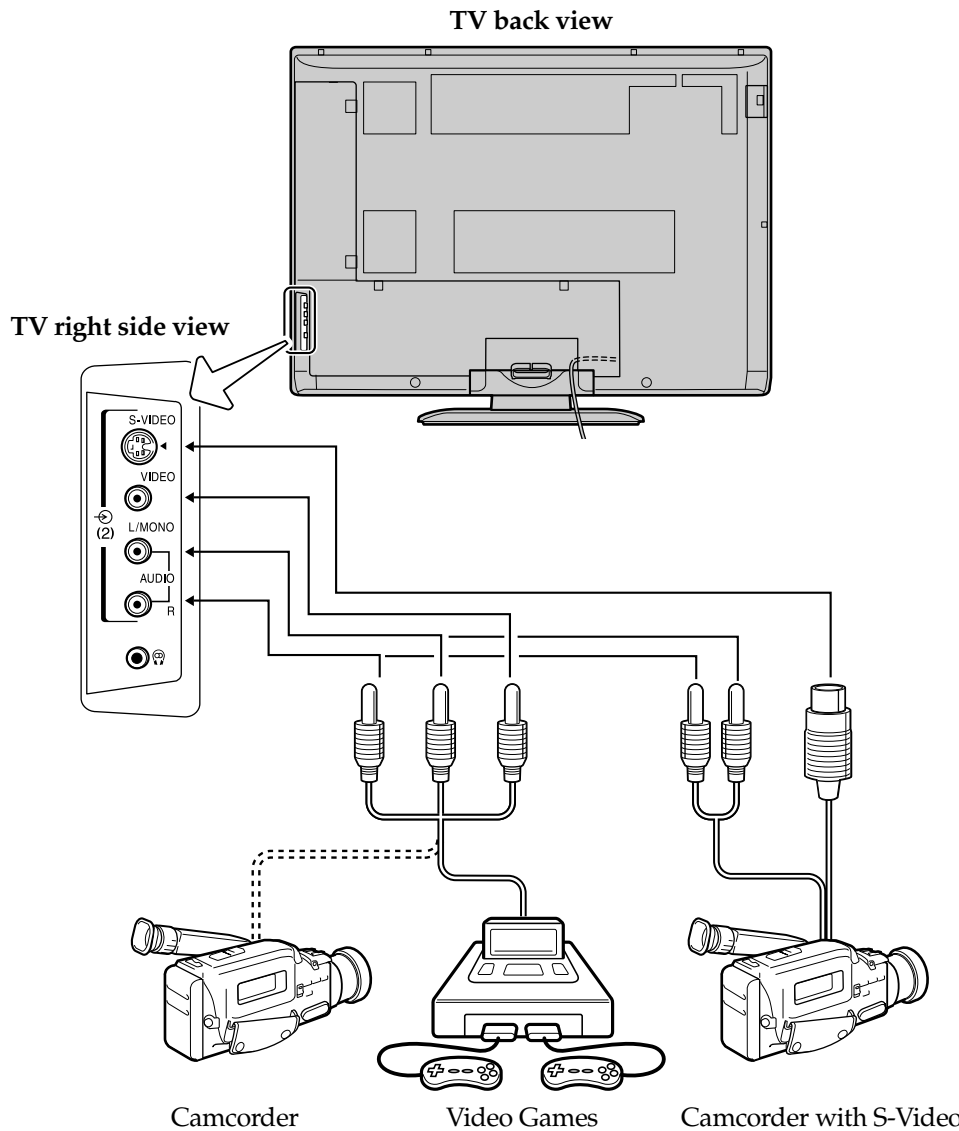

- To select the side inputs, press and hold the → button until the video input mode list appears on the screen, then press the ^ or v button to select → 2 (see page 29), then press **OK**.
- Before connecting any external equipment, turn off all main power switches.
- Connect either the S-VIDEO input terminal or VIDEO input terminal, whichever terminal is used. Never connect to both of these terminals.
- If you connect mono sound equipment to → (2), connect the audio output of the equipment to the L/MONO jack on the TV.
- You can enjoy Video Games with this TV. However shooting games, which shoots at a target on the TV screen with a light gun, may not work because of the LCD Color TV properties.

Back connections

Connection example

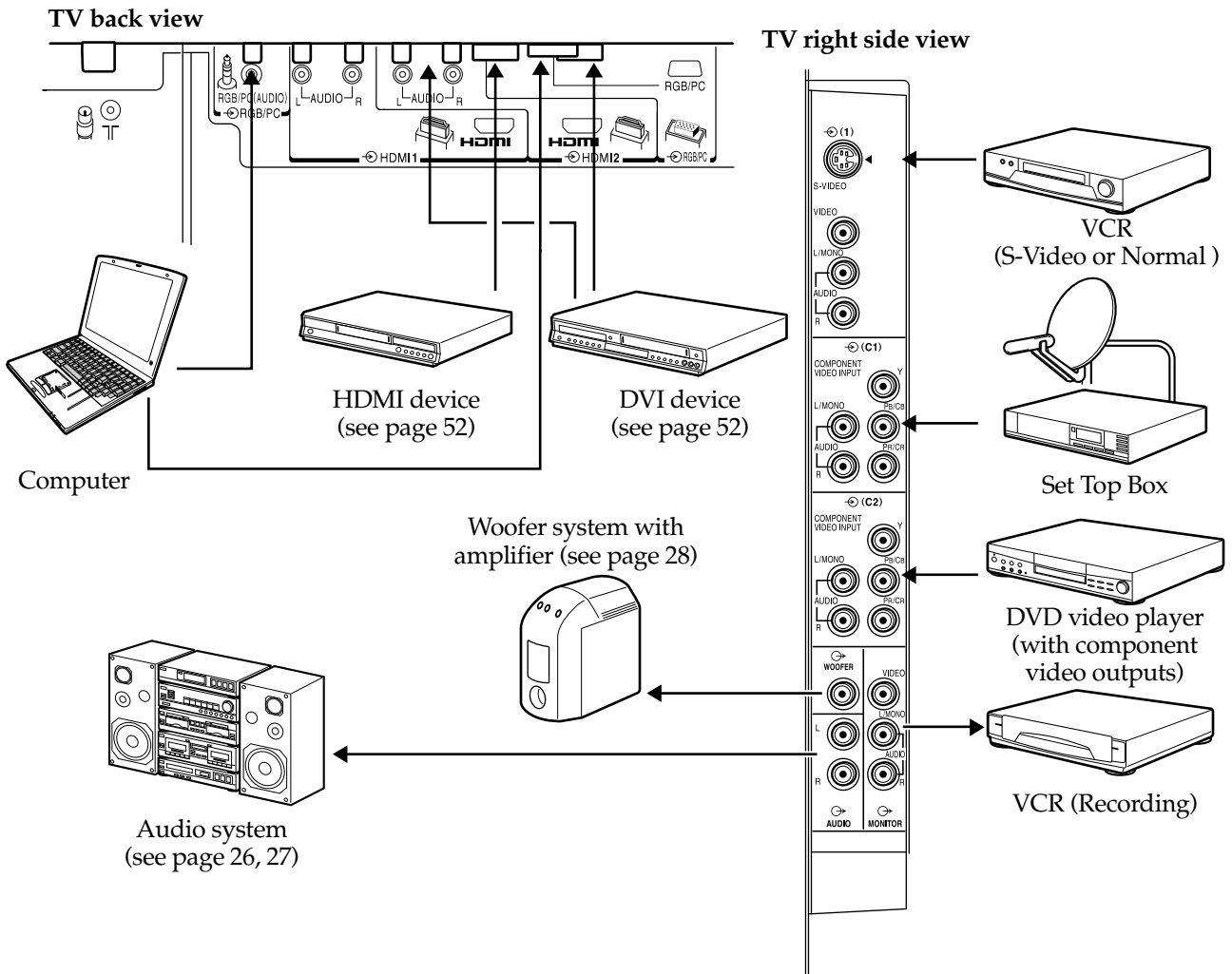

- Before connecting any external equipment, turn off all main power switches.
- Before connecting any external equipment, remove the back terminal cover (see page 10).
- The unauthorized recording of television programs, DVDs, video tapes and other materials may infringe upon the provisions of copyright laws.
- Connect either the S-VIDEO input terminal or VIDEO input terminal, whichever terminal is used. Never connect both of these terminals.
- There is a fixed/variable external audio output which enables the connection of a suitable audio system. The WOOFER OUT terminal allows an external active Woofer system to be connected.
- The COMPONENT VIDEO INPUT consists of three component video signals (Y, P_B/C_B, P_R/C_R) and provides the best picture performance. These terminals can only be used with the component video compatible equipment, e.g. DVD video player, etc.
- Additional equipment and cables shown are not supplied with this TV.

Connecting a computer

- Before connecting PC and audio cables, remove the back terminal covers (see page 10).
- An analog RGB (15 pin) computer cable can be connected.

To connect a computer

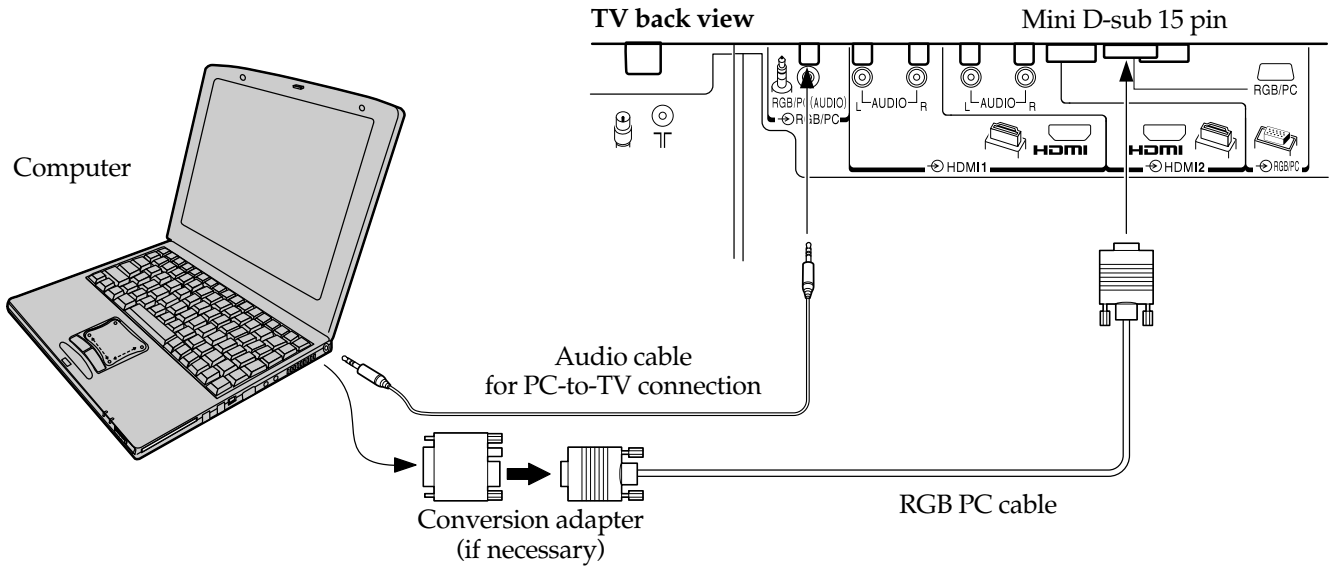

Connect a PC cable from the computer to the RGB/PC terminal on the back of the TV.

The following signals can be displayed:

- VGA: VESA 640 x 480 @ 60 Hz
- SVGA: VESA 800 x 600 @ 60 Hz
- XGA: VESA 1024 x 768 @ 60 Hz

However, these signal formats are converted to match the number of pixels of the LCD panel.

Therefore, the TV may not display small text properly.

Notes:

- Some PC models cannot be connected to this TV.
- There is no need to use an adapter for computers with DOS/V compatible mini D-sub 15 pin terminal.
- A bar may appear in the upper, lower, right or left side of the screen, or parts of the picture may be obscured depending on some signals. This is not the malfunction.
- If the edges of the picture are stretched, readjust the picture position adjustments in the PC Setting menu.
- Depending on the specification of the PC you are playing the DVD-Video on, and the DVD's title, some scenes may be skipped, or you may not be able to pause during multi-angle scenes.

Signal names for mini D-sub 15 pin connector

Pin assignment for RGB/PC terminal	Pin No.	Signal name	Pin No.	Signal name
		1	R	9
2		G	10	Ground
3		B	11	NC
4		NC (not connected)	12	NC
5		NC	13	H-sync
6		Ground	14	V-sync
7		Ground	15	NC
8		Ground		

PC setting

- In the PC input mode, you cannot select the Color, Tint, Sharpness, Black stretch, MPEG NR and DNR in the Picture setting menu and Cinema mode (see page 13).
- In the PC input mode, the Manual setting (see page 29) is not displayed.

To adjust a PC setting

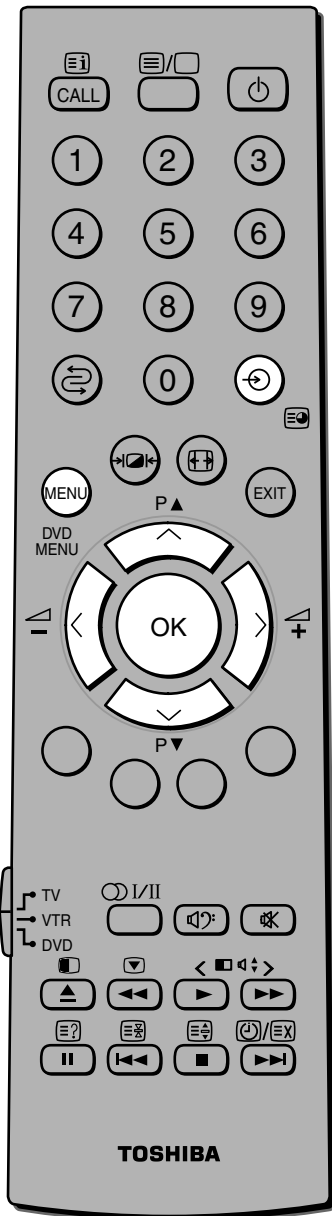

First press and hold the button until the video input mode list appears on the screen, then press the or and **OK** buttons in order to select the PC input mode (see page 29).

To adjust the Picture size/position:

- 1 Press the **MENU** button, then press the or button to display the SET UP menu.
- 2 Press the or button to select PC Setting.
- 3 Press the **OK** button to display the PC Setting menu.
- 4 Press the or button to select an option you want to adjust. (Picture size/position menu: Horizontal position, Horizontal width, Vertical position and Vertical height)
- 5 Press the or button to adjust the settings as required.

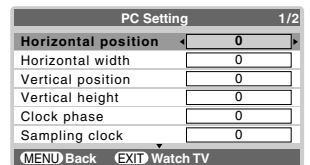
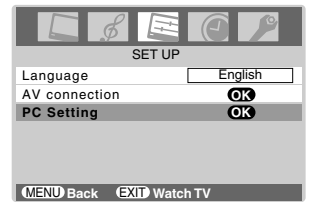

PC setting (continued)

- If the clock phase, which synchronize the PC signal and LCD display, is not optimized, the picture will blur. This function enables you to adjust clock phase and display a clear picture.
- If the sampling clock does not match with the dot clock frequency of the PC, blurred picture detail will occur, or screen width will change, or drift patterns in vertical lines may be apparent. This function enables you to adjust it and optimize the picture.
- The Reset function adjusts the PC Setting to the factory settings.

To adjust a PC setting (continued)

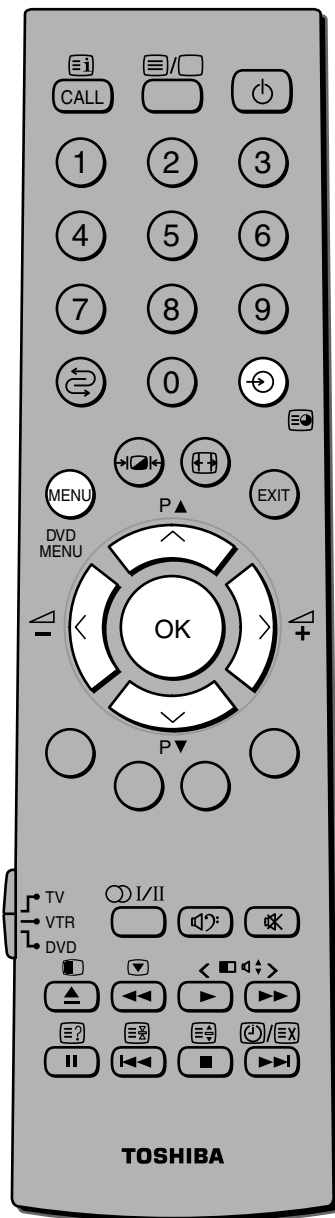

Note:

The optimum points of the clock phase and sampling clock adjustments may be incomprehensible according to the input signals.

First press and hold the \odot button until the video input mode list appears on the screen, then press the \downarrow or \uparrow and **OK** buttons in order to select the PC input mode (see page 29).

To adjust the clock phase of the picture:

- 1 Press the **MENU** button, then press the \leftarrow or \rightarrow button to display the SET UP menu. Press the \downarrow or \uparrow button to select PC Setting.
- 2 Press the **OK** button, then press the \downarrow or \uparrow button to select Clock phase.
- 3 Press the \leftarrow or \rightarrow button to obtain a clear picture.

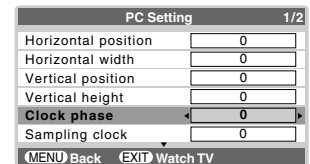

To adjust the sampling clock:

- 1 From the PC Setting menu, press the \downarrow or \uparrow button to select Sampling clock.
- 2 Press the \leftarrow or \rightarrow button to optimize the picture.

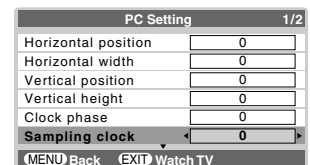

To reset the PC setting:

- 1 From the PC Setting menu, press the \downarrow or \uparrow button to select Reset on the 2nd page.
- 2 Press the **OK** button.

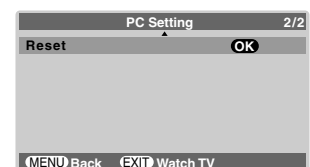

Connecting an HDMI and a DVI device

- This TV is not intended for connection to and should not be used with a PC.
- When turning on your electronic components, turn on the TV first, and then the HDMI or DVI device.
- When turning off your electronic components, turn off the HDMI and DVI device first, and then the TV.
- Before connecting an HDMI and a DVI device, remove the back terminal covers (see page 10).
- This model may not be compatible with features and/or specifications that may be added in the future.

To connect an HDMI and a DVI device

The HDMI input on your TV receives digital audio and uncompressed digital video from an HDMI device and uncompressed digital video from a DVI device.

This input is designed to accept HDCP program material in digital from EIA/CEA-861/861B compliant consumer electronic devices (such as a set top box and DVD player with HDMI and DVI output).

The HDMI input is designed for best performance with 1080i (50 Hz/60 Hz) high-definition video signals, but will also accept and display 480i, 480p, 576i, 576p and 720p (50 Hz) signals.

- HDMI: High-Definition Multimedia Interface
- DVI: Digital Video Interface
- HDCP: High-bandwidth Digital Content Protection
- EIA/CEA-861/861B compliance covers the transmission of uncompressed digital video with high-bandwidth digital content protection, which is being standardized for reception of high-definition video signals. Because this is an evolving technology, it is possible that some devices may not operate properly with the TV.

To connect an HDMI device:

One HDMI cable (type A connector)

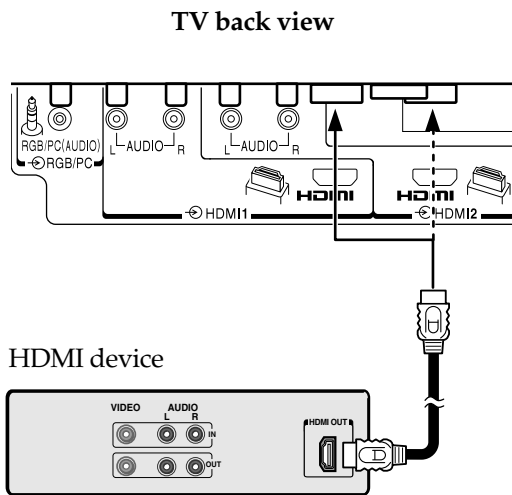

For proper operation, it is recommended that you use a short HDMI cable. HDMI cable transfers both video and audio. Separate analog audio cables are not required. Some CDVs (video CDs) may not output digital audio signals. In that case, you may hear sound by connecting analog audio cables.

To connect a DVI device:

One HDMI (type A connector)-to-DVI adapter cable and audio cables

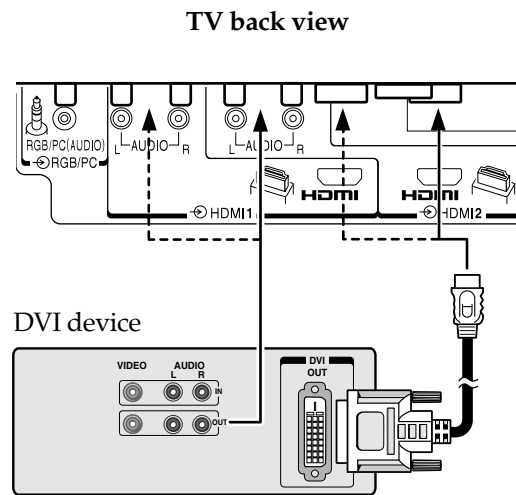

HDMI (type A connector)-to-DVI adapter cable

For proper operation, the length of an HDMI-to-DVI adapter cable should not exceed 3m. The recommended length is 2m.

Standard analog audio cables

An HDMI-to-DVI adapter cable transfers only video. Separate analog audio cables are required.

- HDMI, the HDMI logo, and High-Definition Multimedia Interface are trademarks or registered trademarks of HDMI Licensing, LLC.

Troubleshooting

- Before calling a service technician, please check the following table for a possible cause of the symptom and some solutions.

Symptom and solution

Symptom	Solution
TV will not turn on	<ul style="list-style-type: none"> • Make sure the power cord is plugged in, then press \mathcal{O}/I. • The remote control batteries may be dead. Replace the batteries.
No picture, no sound	<ul style="list-style-type: none"> • Check the antenna connections.
No sound, picture OK	<ul style="list-style-type: none"> • The sound may be muted. Press $\triangleleft +$, $\triangleleft -$ or MUTE. • The station may have broadcast difficulties. Try another channel. • Check that the Speaker function in SOUND menu is properly set.
Poor sound, picture OK	<ul style="list-style-type: none"> • The station may have broadcast difficulties. Try another channel.
Poor picture, sound OK	<ul style="list-style-type: none"> • Check the antenna connections. • The station may have broadcast difficulties. Try another channel. • Adjust the PICTURE menu.
Poor reception of broadcast channels	<ul style="list-style-type: none"> • Check the antenna connections. • The station may have broadcast difficulties. Try another channel. • Make sure the Color system is properly set.
Teletext problems	<ul style="list-style-type: none"> • Check the antenna connections. <p>Good performance of text depends on a good strong broadcast signal.</p>
Multiple images	<ul style="list-style-type: none"> • The station may have broadcast difficulties. Try another channel. • Antenna reception may be poor. Use a high directional outdoor antenna. • Check if the direction of the antenna has changed.
Poor color or no color	<ul style="list-style-type: none"> • The station may have broadcast difficulties. Try another channel. • Adjust the Tint and/or Color in the PICTURE menu.
The remote control does not operate	<ul style="list-style-type: none"> • Remove all obstructions between the remote control and the remote control sensor in the TV. • The remote control batteries may be dead. Replace them with new ones. • Check that the TV/VCR/DVD switch on the remote control is properly set.
Some pixels of the screen do not light up	<ul style="list-style-type: none"> • The LCD display panel is manufactured using an extremely high level of precision technology, however, sometimes some pixels of the screen may be missing picture elements or have luminous spots. This is not a sign of a malfunction.
The brightness of the screen comes down, or flickers of the screen are caused, or some parts of the screen do not light up.	<ul style="list-style-type: none"> • When you just buy and start to use this TV, a flickering may be caused in the screen. In this case, switch off the TV, then switch on it again to cure the condition. • The cold cathode fluorescent lamp used for the back light on this TV has longevity. When the brightness of the screen comes down, or the flickers of the screen are caused, or some parts of the screen do not light up, it may reach the end of its life. Contact a service technician.
The picture brightness varies when you switch the TV on.	<ul style="list-style-type: none"> • If you switch the TV on at 0°C and under, wait until the display warms up.

Broadcast system, Specifications

Broadcast transmission systems of each country or region

Area	Country or Region	System	
		Color	Sound
Asia M. E.	Bahrain, Kuwait, Israel, Oman, Qatar, United Arab Emirates, Yemen, etc. Indonesia, Malaysia, Singapore, Thailand, etc.	PAL	B/G
	China	PAL	D/K
	China Hong Kong	PAL	I
	Iraq, Islamic Republic of Iran, Lebanon, Saudi Arabia, etc.	SECAM	B/G
	Russian Federation, etc.	SECAM	D/K
	Myanmar, etc.	NTSC	M
Oceania	Australia, New Zealand, etc.	PAL	B/G
Africa	Republic of South Africa, etc.	PAL	I
South America	Argentina, Paraguay, Uruguay, etc.	PAL	N
	Brazil	PAL	M
	Chile, Colombia, etc.	NTSC	M

Note:

PAL, SECAM and NTSC 3.58 (MHz) are different color signal broadcast transmission systems applicable to different countries or region. NTSC 4.43 (MHz) is used in special VCRs to playback NTSC recorded video tapes through PAL television equipment.

LCD color television

Model	32WL58A, 32WL58E, 32WL58T, 37WL58A, 37WL58E, 37WL58T				
Power source	32/37WL58A : 220V - 240V AC, 50Hz 32/37WL58E : 220V - 240V AC, 50/60Hz 32/37WL58T : 110V - 240V AC, 50/60Hz				
Power consumption	32WL58A, 32WL58E, 32WL58T : 175W, 0.5W (standby) 37WL58A, 37WL58E, 37WL58T : 200W, 0.5W (standby)				
Dimensions	32WL58A, 32WL58E, 32WL58T : 794 mm (W) × 603 mm (H) × 300 mm (D) 37WL58A, 37WL58E, 37WL58T : 915 mm (W) × 670 mm (H) × 300 mm (D)				
Mass (Weight)	32WL58A, 32WL58E, 32WL58T : 21.5 kg 37WL58A, 37WL58E, 37WL58T : XXX kg				
Television system (Antenna input)	Channel coverage:				
	PAL	B/G (CCIR)	VHF	2 - 12	
			UHF	21 - 69	
			CATV	X - Z+2, S1 - S41	
	PAL	I (UK)	VHF	-	
			UHF	21 - 69	
			CATV	-	
	PAL	D/K (CHINA)	VHF	1 - 12	
			UHF	13 - 57	
			CATV	Z1 - Z38	
	SECAM	B/G (CCIR)	VHF	2 - 12	
			UHF	21 - 69	
			CATV	X - Z+2, S1 - S41	
	SECAM	D/K (OIRT)	VHF	1 - 12	
			UHF	21 - 69	
			CATV	X1 - X19	

LCD color television (continued)

Television system (Antenna input)	NTSC M (US)	VHF 2 - 13 UHF 14 - 69 CATV A6 - A1, A - W, AA - ZZ, AAA, BBB
	NTSC M (JAPAN)	VHF 1 - 12 UHF 13 - 62 CATV M1 - M10, S1 - S41
	Special RF signal:	
	NTSC 4.43 color system	5.5/6.0/6.5 MHz sound system
	PAL 60 Hz color system	5.5/6.0/6.5 MHz sound system
COMPONENT VIDEO INPUT terminals (the signal format)	480i, 480p, 576i, 576p, 720p (50/60 Hz), 1080i (50/60 Hz) (These signal formats are converted to match the number of pixels of the LCD panel.)	
Color system	PAL, SECAM, NTSC 3.58/4.43	
Aspect ratio	16 : 9	
Visible size (diagonal)	32WL58A/E/T: 80.0 cm 37WL58A/E/T: 94.0 cm	
Number of pixels	1366 (H) dots × 768 (V) dots	
Audio power	10 W + 10 W (10% THD)	
Speakers	Main : 60 × 120 mm 2 pcs. Tweeter : 33mm (round) 2 pcs.	
Input/Output terminals	⊖ (1)	Input 4 pin S-video Phono jacks A/V
	⊖ (2)	Input 4 pin S-video Phono jacks A/V
	⊖ (C1)	Input Component video Y, P _B /C _B , P _R /C _R Phono jacks A/V
	⊖ (C2)	Input Component video Y, P _B /C _B , P _R /C _R Phono jacks A/V
	⊕ MONITOR OUT	Output Phono jacks A/V
	⊕ AUDIO OUT	Output Phono jacks Audio L+R (Fixed/Variable)
	⊕ WOOFER OUT	Output Phono jack Bass Line out (Variable)
	⊖ RGB/PC	Input Mini D-sub 15 pin Analog RGB
	⊖ RGB/PC (AUDIO)	Input 3.5 mm stereo mini jack
	⊖ HDMI 1	Input (type A) 19 pin A/V Digital
	⊖ HDMI 1 AUDIO	Input Phono jacks Analog L+R
	⊖ HDMI 2	Input (type A) 19 pin A/V Digital
	⊖ HDMI 2 AUDIO	Input Phono jacks Analog L+R
	Headphone jack	3.5 mm (Diameter) stereo
Operating condition	Temperature	0°C - 35°C
	Humidity	20% - 80% (No moisture condensation)
Supplied accessories	Owner's manual (1), Remote control (1), Batteries (2), Clip (1)	



This is used to fix the TV to a wall, pillar, etc. (see page 4).

- Design and specifications are subject to change without notice.
- Never service or remodel the TV by yourself. It may expose you to a fire hazard or dangerous voltages.

TOSHIBA CORPORATION