

User's Guide

[English • Français • Deutsch • Español • Italiano • Norsk]

ScreenPlay™
by InFocus®

ENGLISH

Declaration of Conformity

Manufacturer: InFocus Corporation, 27700B SW Parkway Ave. Wilsonville, Oregon 97070 USA

European Office: Strawinskylaan 585, 1077 XX Amsterdam, The Netherlands

We declare under our sole responsibility that this projector conform to the following directives and norms:

EMC Directive 89/336/EEC, Amended by 93/68/EEC

EMC: EN 55022

EN 55024

EN 61000-3-2

EN 61000-3-3

Low Voltage Directive 73/23/EEC, Amended by 93/68/EEC

Safety: EN 60950: 2000

February, 2004

Trademarks

Apple, Macintosh, and PowerBook are trademarks or registered trademarks of Apple Computer, Inc. IBM is a trademark or registered trademark of International Business Machines, Inc. Microsoft, PowerPoint, and Windows are trademarks or registered trademarks of Microsoft Corporation. Digital Light Processing is a trademark or registered trademark of Texas Instruments. Faroudja, DCDi, and TrueLife are trademarks or registered trademarks of Faroudja. InFocus and ScreenPlay are trademarks or registered trademarks of InFocus Corporation.

Ver. 12-01

FCC Warning

Note: This equipment has been tested and found to comply with the limits for a Class B digital device, pursuant to part 15 of the FCC Rules. These limits are designed to provide reasonable protection against harmful interference in a residential installation. This equipment generates, uses and can radiate radio frequency energy and, if not installed and used in accordance with the instructions, may cause harmful interference to radio communications. However, there is no guarantee that interference will not occur in a particular installation. If this equipment does cause harmful interference to radio or television reception, which can be determined by turning the equipment off and on, the user is encouraged to try to correct the interference by one or more of the following measures:

--Reorient or relocate the receiving antenna.

--Increase the separation between the equipment and receiver.

--Connect the equipment into an outlet on a circuit different from that to which the receiver is connected.

--Consult the dealer or an experienced radio/TV technician for help.

Changes or modifications not expressly approved by InFocus Corporation can void the user's authority to operate the equipment.

Canada

This Class B digital apparatus complies with Canadian ICES-003.

Cet appareil numérique de la classe B est conforme à la norme NMB-003 du Canada.

Agency Approvals

UL, CUL, NOM, IRAM, GOST, C-tick

Other specific Country Approvals may apply. Please see product certification label.

InFocus reserves the right to alter product offerings and specifications at any time without notice.

Table of Contents

Introduction	4
Positioning the projector	6
Video connections	7
Connecting a video device	8
Displaying a video image	9
Connecting a computer	11
Shutting down the projector	12
Troubleshooting your setup	12
Using the keypad buttons	20
Using the remote control	21
Optimizing video images	22
Customizing the projector	22
Using the menus	23
Picture menu	24
Settings menu	29
Maintenance	31
Cleaning the lens	31
Replacing the projection lamp	32
Appendix	34
Red LED behavior and projector errors	34
Projected image size	34
Source compatibility	35
Projector dimensions for ceiling mount installations	36
RS-232 terminal specifications	37

For complete details on connecting and operating the projector, refer to this User's Guide. Electronic versions of this User's Guide in multiple languages are available on our website at www.infocushome.com/service.

The website also has technical specifications (an interactive image size calculator, laptop activation commands, connector pin outs, a glossary, the product data sheet), a web store to buy accessories, and a page for online registration.

Important Operating Considerations

- Place the projector in a horizontal position no greater than 15 degrees off axis. See “Positioning the projector” on page 6.
- Locate the projector in a well-ventilated area without any obstructions to intake or exhaust vents. Do not place the projector on a tablecloth or other soft covering that may block the vents.
- Locate the projector at least 4' (1.2 m) away from any heating or cooling vents.
- Use only InFocus-approved ceiling mounts.
- Use only the power cord provided. A surge-protected power strip is recommended.
- Refer to this manual for proper startup and shutdown procedures.
- In the unlikely event of the lamp rupturing, discard any edible items placed in the surrounding area and thoroughly clean the area along all sides of the projector. Wash hands after cleaning the area and handling the ruptured lamp. This product has a lamp which contains a very small amount of mercury. Dispose of it as required by local, state or federal ordinances and regulations. For more information see www.eiae.org.

Follow these instructions to help ensure image quality and lamp life over the life of the projector. Failure to follow these instructions may affect the warranty. For complete details of the warranty, see the warranty section at the end of this User's Guide.

Do not place objects in the areas along the side and in the front of the projector

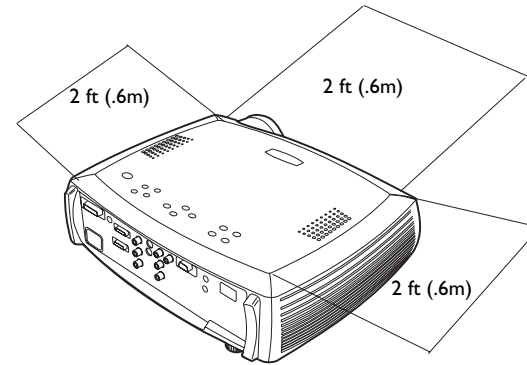

Do not place objects or people in the 2 foot (.6m) area along the front of the projector. For ceiling mount applications, this area should be 5 feet (1.5m).

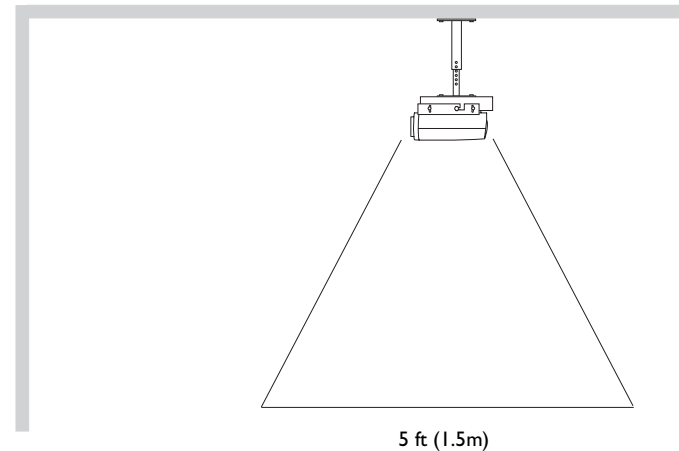

Introduction

Congratulations and thank you for your excellent choice of a superior digital image projection device. Your new ScreenPlay™ 7205 projector from InFocus® is specifically designed for home cinema applications. The ScreenPlay 7205 sets the standard for high-definition digital perfection, featuring true High Definition 1280x720 resolution using the latest DLP™ technology and new DCDi video processing from Faroudja™. Calibrated to D65 color mastering standards, the ScreenPlay 7205 reproduces colors and details the way the director intended. Whether you are watching movies or High Definition broadcasts or playing the latest video game, you will enjoy breathtaking image quality.

The focus ring is threaded, similar to a camera lens, for adding external optical filters to customize your viewing experience. The thread is made to accommodate some standard 72mm SLR-type filters.

Product specifications

To read the latest specifications on your digital image projector, be sure to visit our website, as specifications are subject to change. Web address information is located on the inside back cover of this User's Guide.

Accessories

The standard accessories that came with your projector can be found on the included packing list. Optional accessories are listed in the Accessories catalog that came with the projector and can also found on our website. See the inside back cover for the Web address.

Online Registration

Register your projector on our website to receive product updates, announcements, and registration incentives. See the inside back cover for the Web address.

Projector components and features

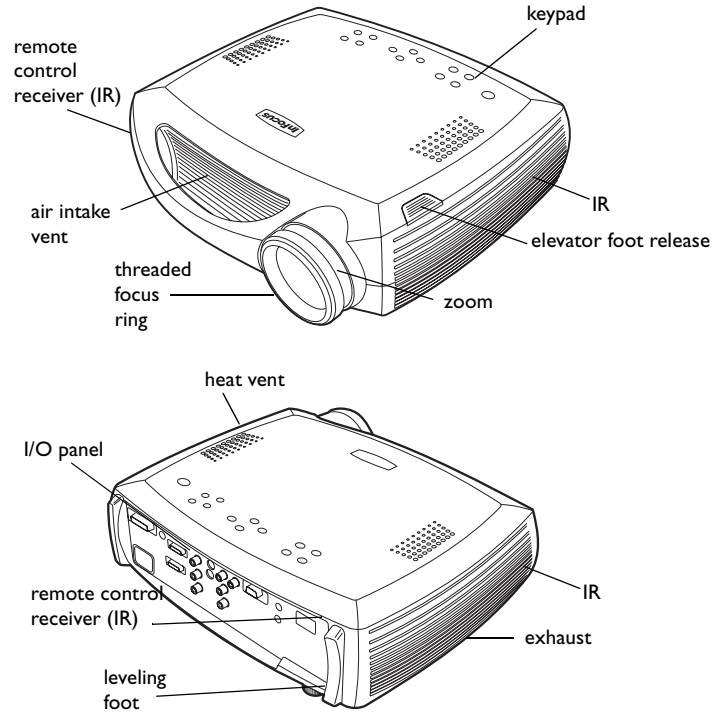

Connector Panel

The projector provides eight discreet video connectors:

- two red-green-blue RCA (SD/ED/HD component)
- two S-video
- one composite RCA
- one M1-DA (HD, RGBHV, HD component, DVI, and computer)
- one VESA (HD, RGBHV, HD component, and computer)
- one D5 (SD/ED/HD component, RGB SCART)

It also has a mini-jack input for a Niles or Xantech-compatible IR repeater and an RS-232 connector for serial control. The Command Line Interface (CLI) specifications and commands are listed in the Appendix starting on page 37.

Two 3.5mm mini-jack triggers provide 12 volt current. Trigger 1 provides a constant output while the projector is on. For example, if you connect your projection screen to Trigger 1, when you turn on the projector the screen will move down; when you turn the projector off, the screen will return to the storage position. Trigger 2 provides a 4:3 aspect trigger. When you select 4:3 in the Aspect Ratio menu or from the **Resize** button on the remote, a 12v signal will be sent after a five second delay. Use this trigger for screens with 4:3 aspect curtains. When you switch back to 16:9 format, the curtains open to reveal the entire screen.

For details on each connector type and their inputs, see page 35.

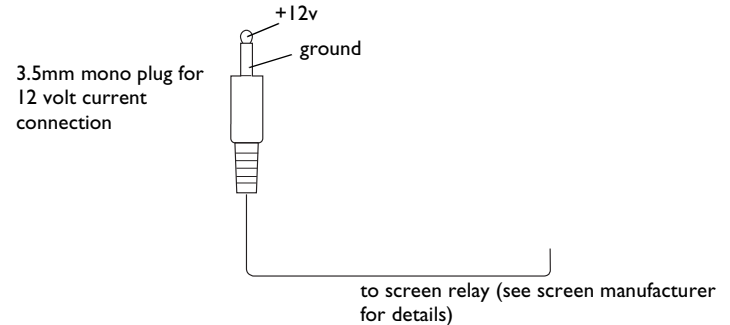
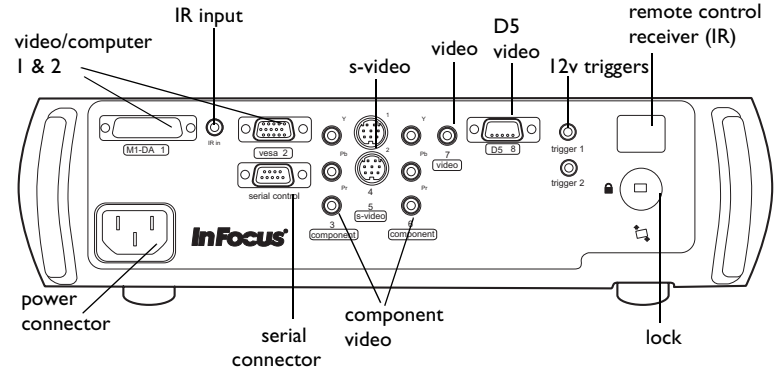

Positioning the projector

There are a number of factors to consider when determining where to set up the projector, including the size and shape of your screen, the location of your power outlets, and the distance between the projector and the rest of your equipment. Here are some general guidelines.

- 1 Position the projector on a flat surface at a right angle to the screen.

The projector must be within 10 feet (3 m) of your power source. To ensure adequate cable access, place the projector at least 6 inches (0.15m) from a wall or other objects. Place the projector at least 5.6 feet (1.7 m) from the projection screen.

If you install the projector on the ceiling, refer to the installation guide that comes with the Ceiling Mount Kit for more information. To turn the image upside down, see page 29. InFocus recommends use of an authorized InFocus ceiling mount. The Ceiling Mount Kit is sold separately.

- 2 Position the projector the desired distance from the screen.

The distance from the lens of the projector to the screen, the zoom setting, and the video format determine the size of the projected image. For more information about projected image sizes, see page 34.

The image exits the projector at a given angle. This image offset is 116%. This means that if you have an image 10' high, the bottom of the image will be 1.6' above the center of the lens.

Go to www.infocushome.com/support for a complete image size calculator.

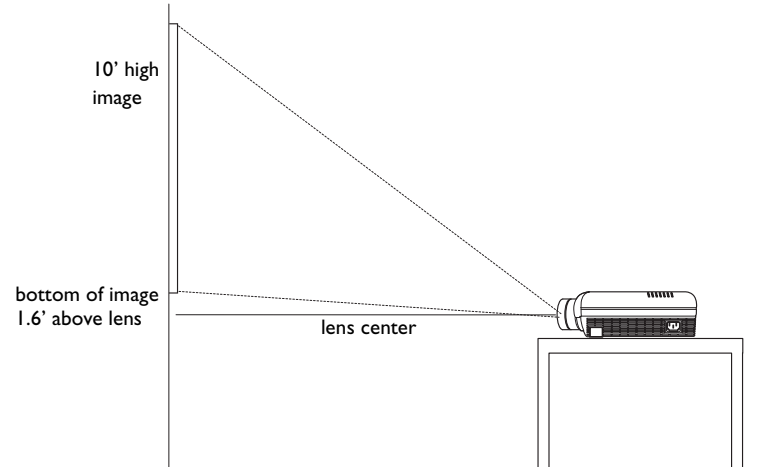
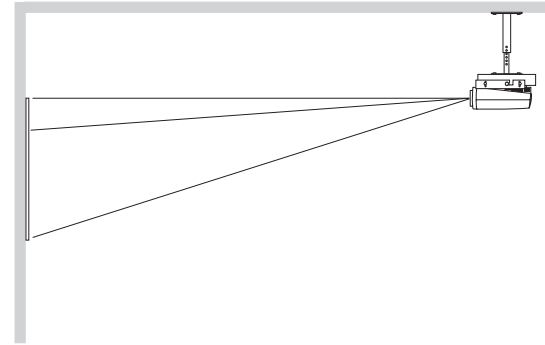

Video connections

You can connect VCRs, DVD players, camcorders, digital cameras, video games, HDTV receivers, and TV tuners to the projector. (You cannot directly connect the coaxial cable that enters your house from a cable or satellite company; the signal must pass through a tuner first. Examples of tuners are digital cable boxes, VCRs, digital video recorders, and satellite TV boxes. Basically, any device that can change channels is considered a tuner.) Audio must be provided by your own speakers, as the projector has no separate audio controls. If there is more than one output, select the highest quality one. DVI, Component video and RGB (M1, HD15) have the best quality, followed by S-video, and then composite video.

Table 1: Video connections

Input signal	Connector	Connector label on projector
Standard Broadcast TV (not HDTV), via cable, digital cable, satellite TV, DirectTV	Component video S-video Composite video	Component 3, 6 S-video 4, 5 Video 7
HDTV	Component video VESA DVI	Component 3, 6 VESA 2 M1-DA 1
DVD	Component video S-video Composite video	Component 3, 6 S-video 4, 5 Video 7
VCR	Composite video S-video Component video	Video 7 S-video 4, 5 Component 3, 6
Video Camera	Composite video S-video	Video 7 S-video 4, 5

Table 1: Video connections

Video Game	VESA Composite video S-video Component video	VESA 2 Video 7 S-video 4, 5 Component 3, 6
------------	---	---

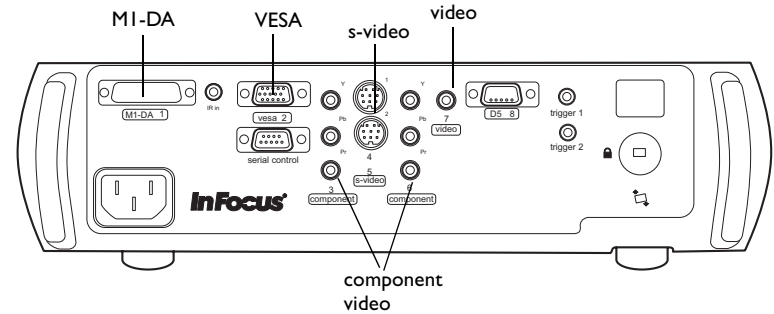

For a complete list of compatible sources, see page 35 of the Appendix.

Connecting a video device

If your video device has more than one output, select the highest quality one. DVI video has the best quality, followed by Component video, S-video, and then composite video.

If the video device uses component cable connectors, plug the cable's green connectors into the green component-out connector on the video device and into the green component connector (labeled "Y") on the projector. Plug the component cable's blue connectors into the blue component-out connector on the video device and into the blue component connector (labeled "Pb") on the projector. Plug the component cable's red connectors into the red component-out connector on the video device and into the red component connector (labeled "Pr") on the projector.

If the video device uses a round, four-prong S-video connector, plug an S-video cable into the S-video connector on the video device and into the **S-video** connector on the projector.

If the video device uses a yellow composite video connector, plug a composite video cable's yellow connector into the video-out connector on the video device. Plug the other yellow connector into the yellow **Video** connector on the projector.

If the video device uses a DVI connector, plug an M1-D cable into the video-out connector on the video device. Plug the other connector into the **MI-DA** connector on the projector.

If the video device uses a VESA connector, plug a VESA cable into the video-out connector on the video device. Plug the other connector into the **VESA** connector on the projector.

Connecting the power cable

Connect the power cable to the connector on the back of the projector and to your electrical outlet. The Power LED on the keypad turns solid green.

NOTE: Always use the power cable that shipped with the projector.

connect component cable

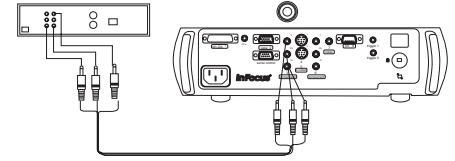

connect S-video cable

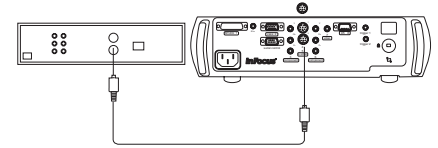

connect composite video cable

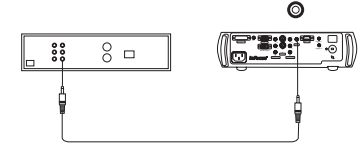

connect M1-D cable

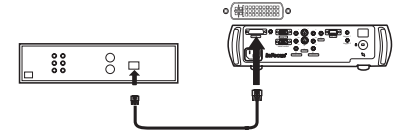

connect VESA cable

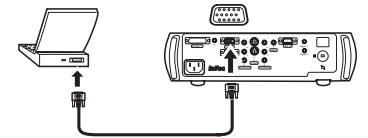

connect power cable

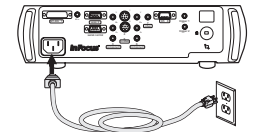

Displaying a video image

Remove the lens cap.

remove lens cap

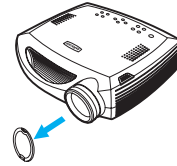

Press the **Power** button on the top of the projector.

press Power

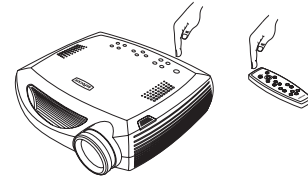

The projector chimes if the chime feature is enabled (page 30). The LED flashes green and the fans start to run. When the lamp comes on, the startup screen displays and the LED is steady green. It can take a minute for the image to achieve full brightness.

? No startup screen? Get help on page 12.

Plug in and turn on the video device.

turn on video device

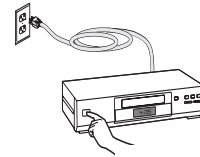

An image from the video device should appear on the projection screen. If it doesn't, press the **Source** button on the keypad.

Adjust the height of the projector by pressing the release button to extend the elevator foot. Rotate the leveling foot, if necessary.

adjust height

elevator foot



rotate leveling foot

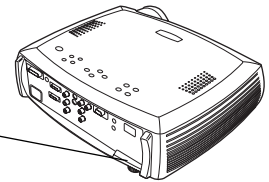

Position the projector the desired distance from the screen at a 90 degree angle to the screen. See page 34 for a table listing screen projected image sizes and distances to the screen.

adjust distance

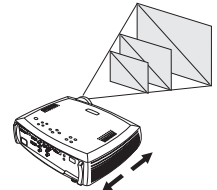

Adjust the zoom or focus rings by rotating them until the desired image size and sharpness are produced.

adjust zoom and focus

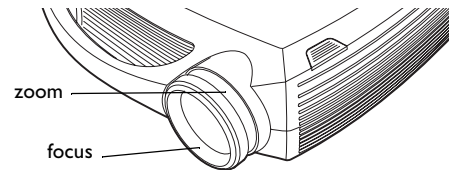

If the image is not square, adjust the keystone using the buttons on the keypad. Press the upper **Keystone** button to reduce the width of the upper portion of the image, and press the lower **Keystone** button to reduce the width of the lower portion.

adjust keystone

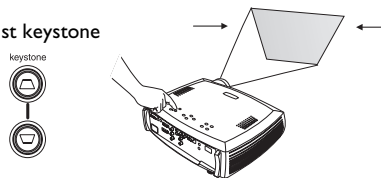

You can also adjust the horizontal and vertical keystone via the Picture menu. See page 24

The **Contrast**, **Brightness**, **Color**, and **Tint** are factory calibrated to D65 colors, but you can adjust these settings in the Picture menu if necessary.

See page 23 for help with the menus.

adjust Picture menu

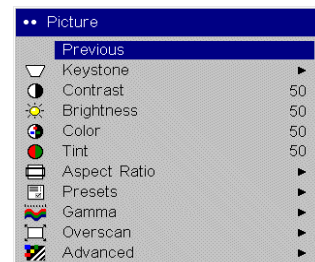

The focus ring is threaded, similar to a 35mm camera lens. To put a filter on your lens, simply screw it clockwise onto the threaded focus ring.

add a lens filter

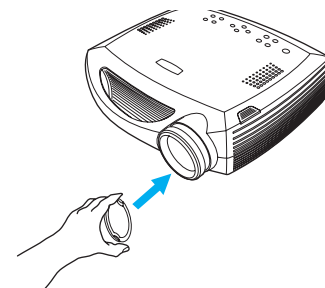

Connecting a computer

Connect either a VESA cable or M1 cable into the appropriate connector on the projector. Connect the other end to the video port on your computer. If you are using a desktop computer, you first need to disconnect the monitor cable from the computer's video port.

connect computer cable

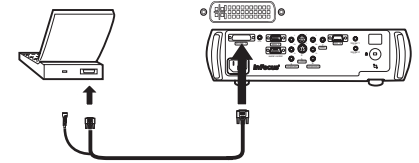
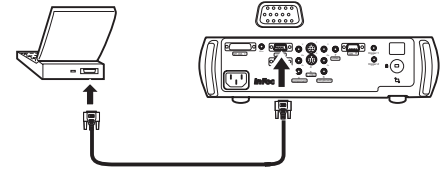

Connect the power cable to the connector on the back of the projector and to your electrical outlet.

The Power LED on the projector's keypad turns solid green.

NOTE: Always use the power cable that shipped with the projector.

Turn on the projector, then your computer.

connect power cable

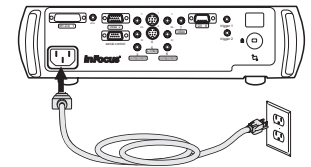

You can control the projector from an LCD control panel or computer by connecting an RS-232 cable to the projector's **Serial** connector. Specific RS-232 commands can be found in the Appendix starting on page 38 and in the Service and Support section of our website at www.infocushome.com/support.

connect RS-232 cable

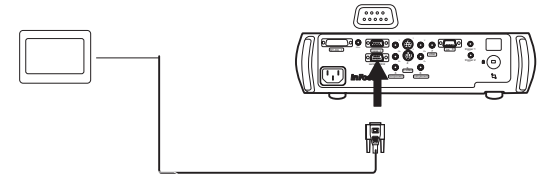

Shutting down the projector

Power Save

The projector has a Power Save feature in the System menu that automatically turns the lamp off after no signals are detected for 20 minutes. After 10 additional minutes with no signal, the projector powers down. If an active signal is received before the projector powers down, the image is displayed. You must press the **Power** button to display an image after 30 minutes have passed.

Turning off the projector

To turn off the projector, press the **Power** button. The lamp turns off and the LED blinks green for about one minute while the fans continue to run to cool the lamp. When the lamp has cooled, the LED lights green and the fans stop. Unplug the power cable to completely power off the projector.

Troubleshooting your setup

If your image appears correctly on the screen, skip to the next section (page 20). If it does not, troubleshoot the setup.

The LED on top of the projector's keypad indicates the state of the projector and can help you troubleshoot.

Table 2: LED behavior and meaning

LED color/behavior	Meaning
solid green	The projector is plugged in, or the projector has been turned on and the software has initialized. The projector has been turned off and the fans have stopped.
blinking green	The Power button has been pressed and the software is initializing, or the projector is powering down and the fans are running to cool the lamp.
blinking red The projector will not start up if the LED is blinking red. You must correct the problem, disconnect and reconnect the power cable, then power on the projector. See page 34 for more information on blinking red LEDs.	A fan (blinks 4 times) or lamp (blinks 3 times) failure has occurred. Turn off the projector and wait one minute, then turn the projector on again. Also check for a blocked vent or a stopped fan (blinks 5 times).
solid red	An unidentifiable error: please contact Technical Support.

The following table shows some potential problems. In some cases, more than one possible solution is provided. Try the solutions in the order they are presented. When the problem is solved, you can skip the additional solutions.

Problem	Solution	Result								
<p data-bbox="48 240 256 265">No startup screen</p> 	<p data-bbox="661 206 1121 262">Plug power cable in and remove lens cap</p> 	<p data-bbox="1185 240 1355 265">Correct image</p> 								
<p data-bbox="48 602 392 627">Image not centered on screen</p> 	<p data-bbox="661 602 1147 627">Move projector, adjust zoom, adjust height</p>  <p data-bbox="661 849 1107 904">Adjust horizontal or vertical position in Picture>Keystone menu</p>  <table border="1" data-bbox="748 955 1060 1059"> <tr> <td>••• Keystone</td> <td></td> </tr> <tr> <td>Previous</td> <td></td> </tr> <tr> <td>▾ Vertical</td> <td>50</td> </tr> <tr> <td>▾ Horizontal</td> <td>50</td> </tr> </table>	••• Keystone		Previous		▾ Vertical	50	▾ Horizontal	50	<p data-bbox="1185 602 1355 627">Correct image</p> 
••• Keystone										
Previous										
▾ Vertical	50									
▾ Horizontal	50									

Image not square



Adjust keystone on keypad or Keystone menu

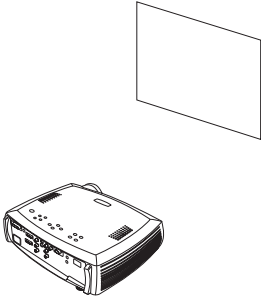
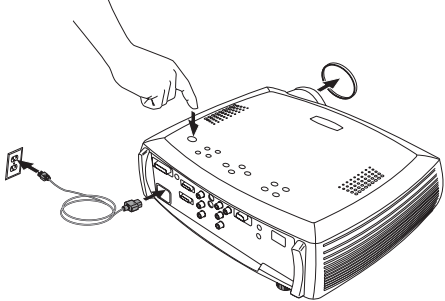
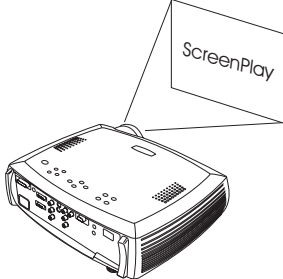
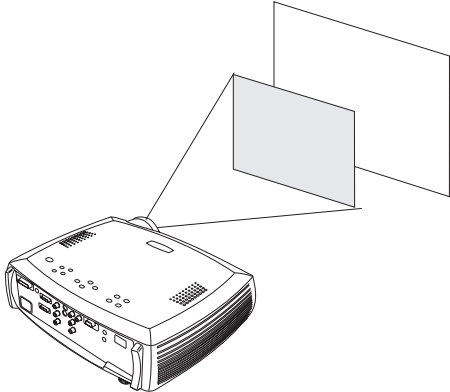
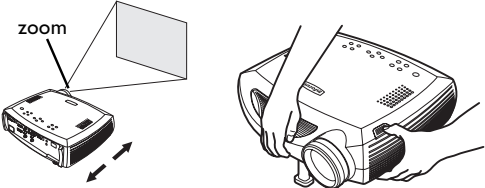
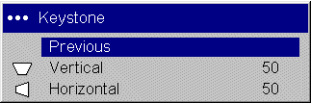
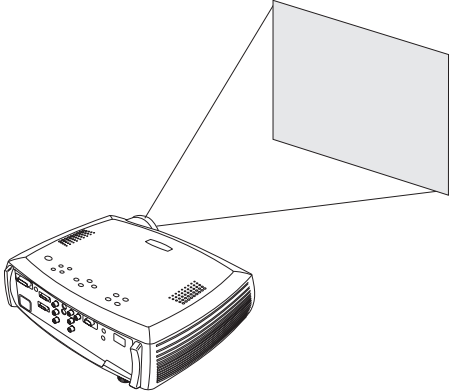
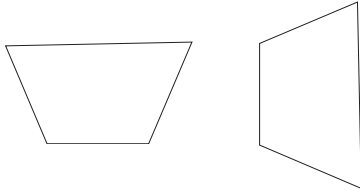
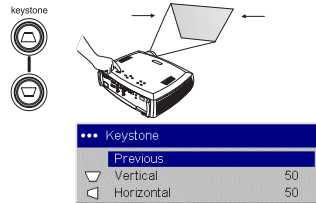

Square image



Image does not fit 16:9 screen



Change aspect ratio to 16:9 in Picture>Aspect ratio menu

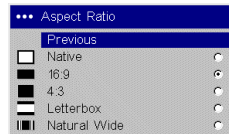

Correct image



Edges of image distorted



Turn Overscan on in the Picture>Overscan menu

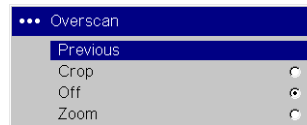

Correct image



1. Projected colors don't match source
2. Colors are washed out or too deep
3. Image from component source appears greenish

~~COLOR~~

1. Adjust color, tint, color temperature, brightness, or contrast in the menus.
2. Pick another gamma setting
3. Pick another color space

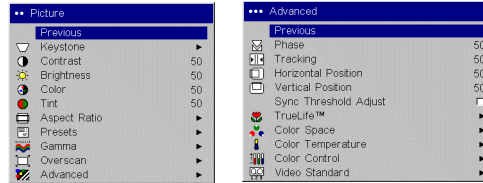

Correct image

COLOR

Image upside down



Turn off Ceiling in Settings>System menu

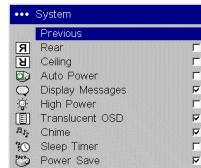

Correct image



Image reversed left to right



Turn off Rear in Settings>System menu



Correct image



Video image “torn” and fragmented



**Change Video Standard in
Picture>Advanced menu**

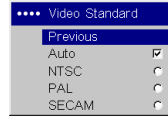

Correct image



Lamp won't turn on, LED blinking red (page 12)

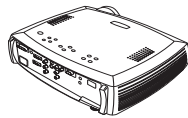
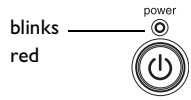

**Make sure vents aren't blocked; allow
projector to cool for one minute**

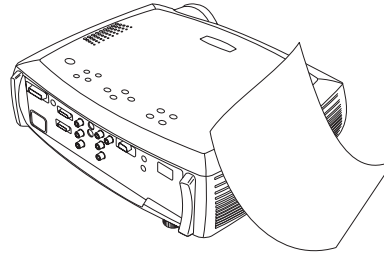

**Unplug projector; wait one minute; plug in
projector and turn it on: lamp lights**

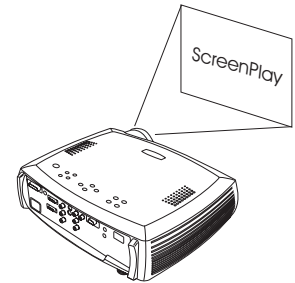

Computer-specific troubleshooting

Only startup screen appears

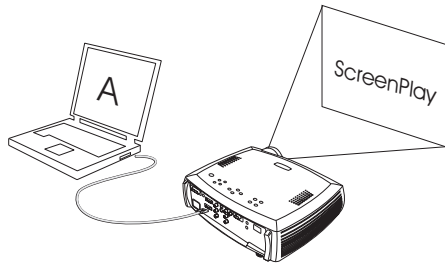

Press the Source button 
Activate laptop's external port

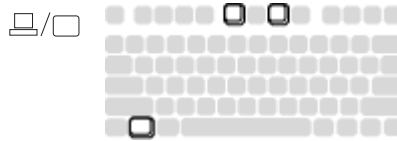

or restart
laptop

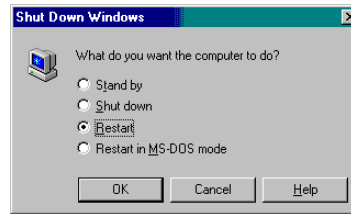

Computer image projected

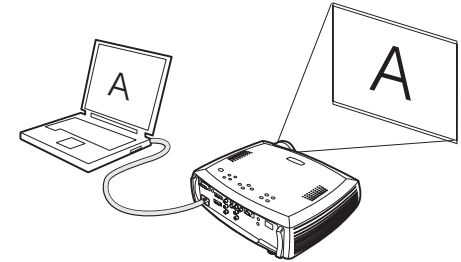

No computer image, just the words "Signal out of range"

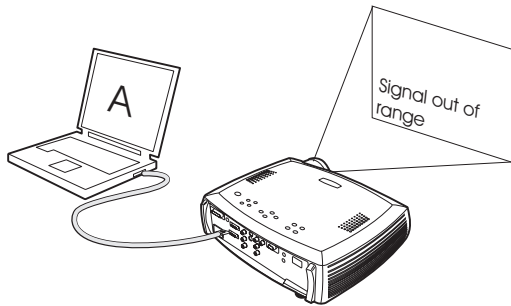

Adjust computer refresh rate in Control
Panel>Display>Settings>Advanced>
Adapter (location varies by operating
system)

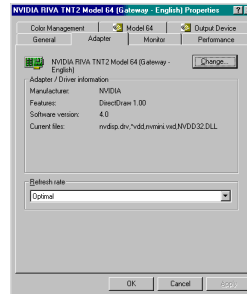

Computer image projected

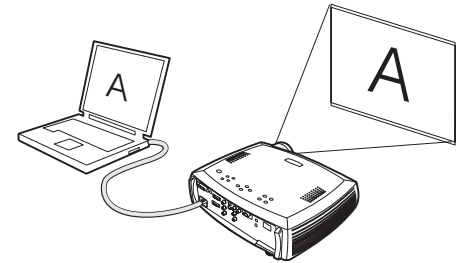
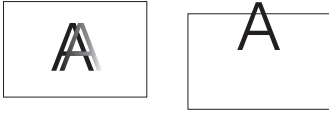

Image fuzzy or cropped



**Set your computer's display resolution to the native resolution of the projector
(Start>Settings>Control Panel>Display>Settings tab, select 1280x720)**

**For a laptop,
disable laptop
monitor
or turn-on dual-
display mode**

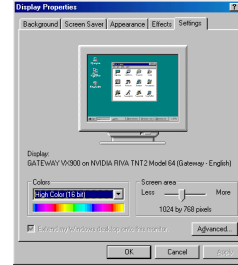
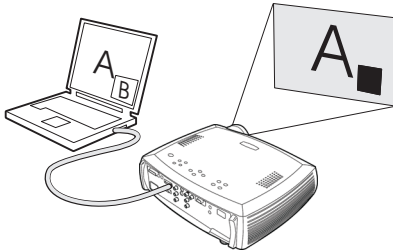

Image clear and not cropped



The video embedded in my PowerPoint presentation does not play on the screen



Turn off the internal LCD display on your laptop

Embedded video plays correctly

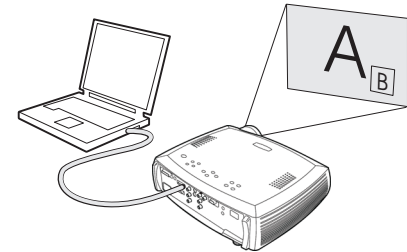

Still having problems?

If you need assistance, visit our website or call us. See the inside of the back cover for support contact information.

This product is backed by a limited warranty. An extended warranty plan may be purchased from your dealer. When sending the projector in for repair, we recommend shipping the unit in its original packing material, or having a professional packaging company pack the unit. An optional ATA shipping case is available for purchase that provides adequate protection for shipping. Please insure your shipment for its full value.

Using the keypad buttons

Most buttons are described in detail in other sections, but here is an overview of their functions:

Power—turns the projector on (page 9) and off (page 9).

Menu—opens the on-screen menus (page 23).

Select—confirms choices made in the menus (page 23).

Up/down arrows—navigates to and adjusts settings in the menus (page 23).

Auto image—resets the projector to the source.

Presets—cycles through the 3 available user preset settings (page 26).

Keystone—adjusts squareness of the image (page 10).

Brightness—adjusts intensity of the image (page 24).

Resize—changes the aspect ratio (page 24).

Source—changes the active source (page 29).

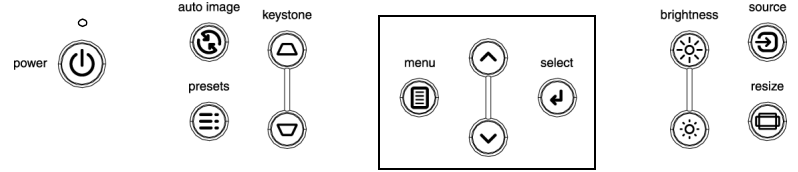

menu navigation buttons

Using the remote control

The remote uses two (2) provided AAA batteries. They are easily installed by sliding the cover off the remote's back, aligning the + and - ends of the batteries, sliding them into place, and then replacing the cover.

To operate, point the remote at the projection screen or at the projector (not at the video device or computer). The range of optimum operation is up to 30 feet (9.14m).

Press the remote's **Menu** button to open the projector's menu system. Use the arrow buttons to navigate, and the **Select** button to select features and adjust values in the menus. See page 23 for more info on the menus.

The remote also has:

- **Power** button to turn the projector on and off (see page 12 for shut-down info)
- backlight button to light the remote's buttons in the dark
- **Brightness** and **Contrast** buttons to adjust the image
- **Blank** button to display a blank screen instead of the current image (to change the color of the blank screen, see page 30)
- **Source** buttons to switch among sources (to assign a particular source to a source button, see page 29) and a source toggle
- **Resize** button to change the Aspect Ratio (see page 24)
- **Auto Image** button to resynchronize the projector to the source
- **Preset** button to restore stored settings (see page 26)
- **Overscan** button to remove noise in a video image (page 26)

Troubleshooting the remote

- Make sure the batteries are installed in the proper orientation and are not dead.
- Make sure you're pointing the remote at the projector or the screen, not at the video device or the computer, and are within the remote range of 30 feet (9.14m).

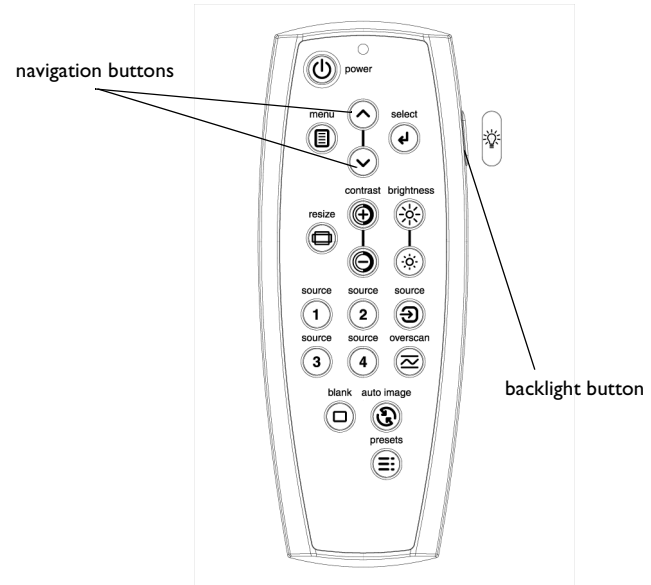

Optimizing video images

After the video device is connected properly and the image is on the screen, you can optimize the image using the onscreen menus. For general information on using the menus, see page 23.

- Change the Aspect ratio. Aspect ratio is the ratio of the image width to image height. TV screens are usually 1.33:1, also known as 4:3. HDTV and most DVDs are 1.78:1, or 16:9. Choose the option that best fits your input source in the menus, or press the **Resize** button on the remote to cycle through the options. See page 24.
- Adjust the Keystone, Contrast, Brightness, Color, or Tint in the Picture menu. See page 24.
- Select a different Color Temperature or use the Color Control to adjust the gain and offset of the red, green, and blue color. See page 28.
- Select a specific Color Space or Gamma. See page 26 and page 28.
- Select a different Video Standard. Auto tries to determine the standard of the incoming video. Select a different standard if necessary. See page 28.
- Turn Overscan on to remove noise around the video image. See page 26.
- Fine tune component inputs using the TrueLife™ adjustments. See page 27.
- Tune colors to your specifications using Blue Only and ADC Calibration. See page 31.
- Choose High Power to maximize the light output. See page 29.
- Make sure your DVD player is set for a 16:9 television. See your DVD player's user's guide for instructions.

Customizing the projector

You can customize the projector for your specific setup and needs. See page 29 to page 31 for details on these features.

- For rear projection, turn Rear mode on in the **Settings>System** menu.
- For ceiling mounted projection, turn Ceiling mode on in the **Settings>System** menu.
- Turn the projector's display messages and power-on chime on and off.
- Turn on power saving features.
- Specify blank screen colors and startup logos. Make the menus translucent.
- Specify the menu language.

Using the menus

To open the menus, press the menu button on the keypad or remote. (The menus automatically close after 60 seconds if no buttons are pressed.) The Main menu appears. Use the arrow buttons to move up and down to highlight the desired submenu, then press the **Select** button.

To change a menu setting, highlight it, press **Select**, then use the up and down arrow buttons to adjust the value, select an option using radio buttons, or turn the feature on or off using check boxes. Press **Select** to confirm your changes. Use the arrows to navigate to another setting. When your adjustments are complete, navigate to **Previous**, then press **Select** to go to the previous menu; press the **Menu** button at any time to close the menus.

Dots appear before the menu name. The number of dots indicate the menu's level, ranging from one (the Main menu) to five (the most nested menus).

The menus are grouped by usage:

- The Picture menu provides image adjustments.
- The Settings menu provides set-up type adjustments that are not changed often.
- The About menu provides a read-only display of information about the projector and source.

Certain menu items may be hidden until a particular source is connected. For example, Tint is only available for NTSC video sources and will be hidden when other sources are active. Other menu items may be grayed out when they are not available. For example, Brightness is grayed out until an image is active.

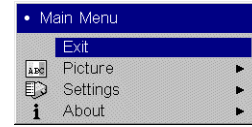

Main menu

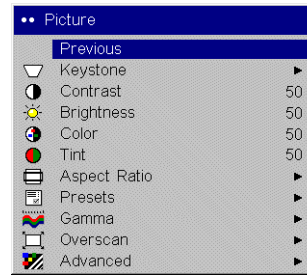
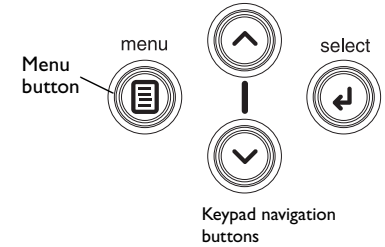

Picture menu

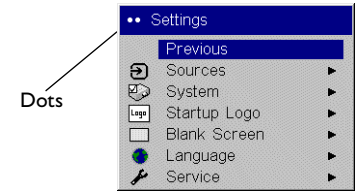

Settings menu



About menu

Picture menu

To adjust the following five settings, highlight the setting, press **Select**, use the up and down arrows to adjust the values, then press select to confirm the changes. All menu defaults are listed in a table starting on page 38.

Keystone: adjusts the image vertically and horizontally to make a squarer image. The two keystones ranges are interdependent. The combined number of steps for both is 50. If one keystone is set to 65, it is 15 steps above the center position of 50. This leaves 35 steps that the other keystone can vary from the center of 50. This means it cannot go below 15 or above 85.

Contrast: controls the degree of difference between the lightest and darkest parts of the picture and changes the amount of black and white in the image.

Brightness: changes the intensity of the image. You can also adjust brightness from the keypad.

Color: (video sources only) adjusts a video image from black and white to fully saturated color.

Tint: (NTSC video sources only) adjusts the red-green color balance in the image.

Aspect Ratio: Aspect ratio is the ratio of the image width to image height. TV screens are usually 1.33:1, also known as 4:3. HDTV and most DVDs are 1.78:1, or 16:9. You can choose Native, 4:3, 16:9, Letterbox, or Natural Wide. The default is 16:9. The goal is to show the most detail on the screen while preserving the ratio of width to height. The native resolution of the projector is 1280x720. Use Native, 4:3 or Natural Wide for 4:3 input sources; use Native, 16:9 or Letterbox for 16:9 input. Pressing the **Resize** button on the remote cycles through these options.

Native: this mode bypasses the internal scaler, displaying the image with no resizing. Since the native resolution is 1280x720 and 4x3 video images are approximately 640x480, 4x3 images will always be smaller than the display and will be centered in the display. Computer images 1024x768 or smaller will also be centered in the display. If a 16x9 video source or a 1280x1024 or larger computer source is viewed, it will display up to 1280 pixels and 720 lines from the center of the input.

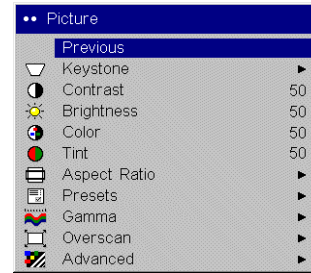

Picture menu

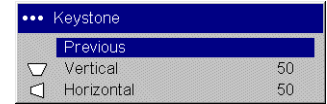

Keystone

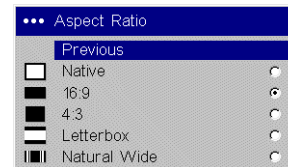

Aspect ratio

16:9: the default is **16:9**, which preserves the 16:9 aspect ratio and is designed to be used with content that is Enhanced for Widescreen TVs.

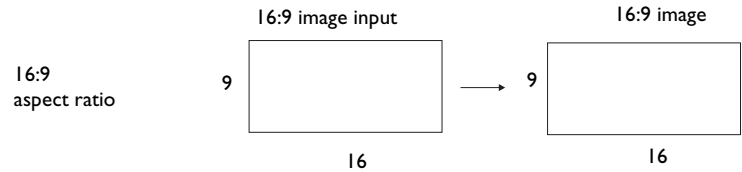

4:3: resizes the image from its original version to fit a standard 4:3 aspect ratio screen. If you have a 4:3 source on a 16:9 screen, the image is placed in a 16:9 space, so black bars appear at the sides of the image.

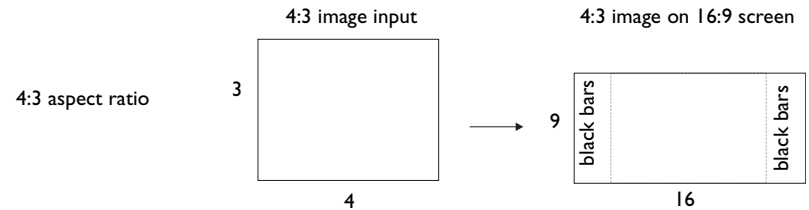

Letterbox: preserves the 16:9 aspect ratio. If you have a 16:9 source and screen, the image fills the screen. If your source is letterboxed, the image is expanded to fill the screen.

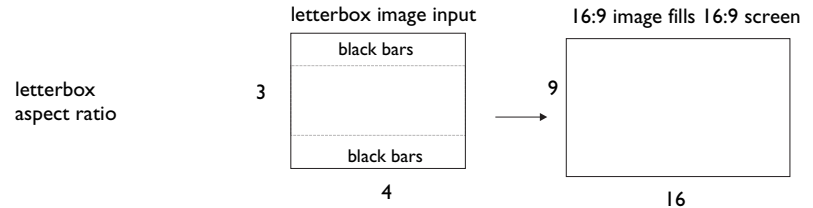

Natural Wide: this mode stretches a 4:3 image to fill the entire 16:9 screen. The center two-thirds of the image is unchanged; the edges of the image are stretched. The mode is only available when TrueLife is active (see page 27).

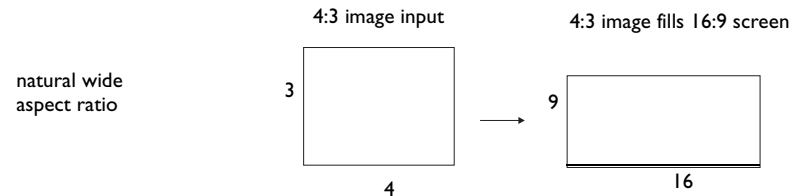

Presets: This allows you to customize settings and save the settings to be restored later. To restore the factory default settings, choose Factory Reset in the **Settings>Service** menu.

To set a preset for the current source, adjust the image, select **Save Settings** in the Presets menu, then choose Save User 1, 2, or 3. You can recall these settings in the future by selecting the appropriate user presets.

Gamma: Gamma tables contain preset intensity configurations optimized for the input source. You can select a gamma table that has been specifically tuned for either film, CRT (Cathode Ray Tube), video, Bright Room, or PC input. (Film input is material originally captured on a film camera, like a movie; video input is material originally captured on a video camera, like a TV show or sporting event.) White Peaking increases the brightness of whites that are near 100%.

NOTE: Your viewing preferences may vary. Cycle through the gamma options and pick the one you like the best.

Overscan: (video sources only) removes noise around the video image.

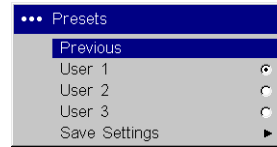

Presets

Save User Presets

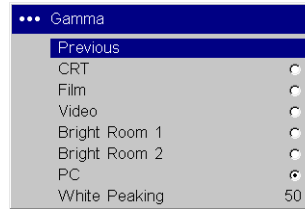
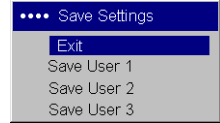

Gamma

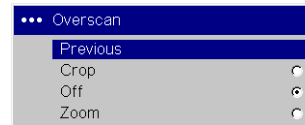

Overscan

Advanced settings

The following 4 options are for computer or HDTV sources only.

Phase: adjusts the phase of the video signal's digital conversion.

Tracking: adjusts the frequency of the video signal's digital conversion.

Horizontal/Vertical Position: adjusts the position of the source.

Sync Threshold Adjust: If a hardware device, such as a DVD player, is not syncing properly with the projector, select this option to help it to sync when connected to the projector.

TrueLife: This option refers to Faroudja's TrueLife processing of the image. All standard definition interlaced video signals (composite, S-video and component) are routed through this processor. Extended and High Definition progressive component sources are not routed through this processor by default. You can turn TrueLife on to route these signals through the processor and then adjust the following 3 options:

Chroma Detail: This adjusts the color sharpness.

Luma Detail: This adjusts the overall sharpness (edge enhancement) of the Luma signal.

Chroma Delay: aligns the Luma and Chroma signals.

CCS: (Cross Color Suppression) processes the signal to remove any color information from the luma portion of the signal. It is On for all composite signals, Off for all component signals, and can be turned on or off for all S-video signals.

Film Mode: controls deinterlacing. If 2:2/3:2 Enable is selected, the deinterlacer attempts to perform a 3:2 pull-down, assuming the source was originally created on 24fps film. If the original source is 30fps film, you should select NTSC 2:2 pull-down.

Noise Reduction: adjusts signal noise reduction. Choose Off to have no noise reduction, choose Auto to have the software determine the amount of noise reduction, or choose Manual and adjust the Level. Skintone Bypass prevents the noise reduction from being performed on skin tones, thus preventing them from appearing overly softened.

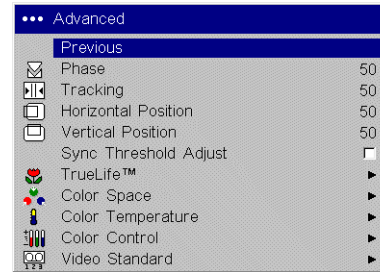

Advanced

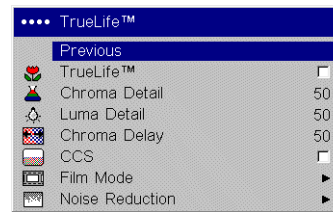

TrueLife

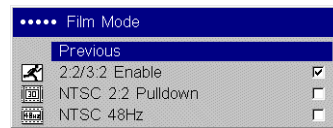

Film Mode

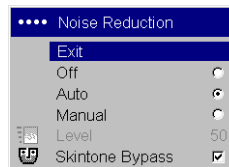

Noise Reduction

Color Space: This option applies to computer and HDTV sources (it won't appear in the menu for video sources). It allows you to select a color space that has been specifically tuned for the video input. When Auto is selected, the projector automatically determines the standard. To choose a different setting, turn off Auto, then choose RGB for computer sources, choose REC709 for component 1080i or 720p sources, or choose REC601 for component 480p or 576p sources.

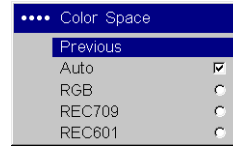

Color Space

Color Temperature: changes the intensity of the colors. Select a listed value.

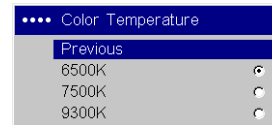

Color Temperature

Color Control: allows you to individually adjust the gain (relative warmth of the color) and the offset (the amount of black in the color) of the red, green, and blue colors.



Color Control

Video Standard: When it is set to Auto, the projector attempts to pick the video standard automatically based on the input signal it receives. (The video standard options may vary depending on your region of the world.) If the projector is unable to detect the correct standard, the colors may not look right or the image may appear "torn." If this happens, manually select a video standard by selecting NTSC, PAL, or SECAM from the Video Standard menu.



Video Standard

Settings menu

Sources: allows you to assign a particular input to a specific source key on the remote and enables or disables Autosource. When Autosource is not checked, the projector defaults to the last-used source. If no source is found, a blank screen displays. When Autosource is checked, the projector checks the last-used source first at power up. If no signal is present, the projector checks the sources in order until a source is found or until power down.

You can use the Source Enable feature to eliminate certain sources from this search, which will speed the search. By default, the check boxes for all sources are checked. Uncheck a source's box to eliminate it from the search.

System

All options in this menu toggle between on and off.

Rear: reverses the image so you can project from behind a translucent screen.

Ceiling: turns the image upside down for ceiling-mounted projection.

NOTE: It is recommended that all final image adjustments in Ceiling mode are made once the unit has fully warmed up (approximately 20 minutes).

Auto Power: When Auto Power is checked, the projector automatically goes into the startup state after the projector receives power. This allows control of ceiling mounted projectors with a wall power switch.

Display Messages: displays status messages (such as "Searching") in the lower-left corner of the screen.

High Power: Turn this on to increase the light output of the lamp. This also shortens lamp life and increases fan noise.

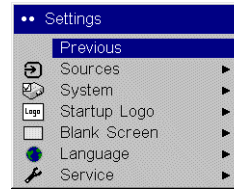

Settings menu

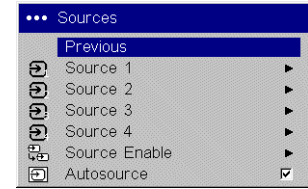

Sources

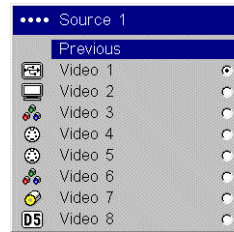

Source 1

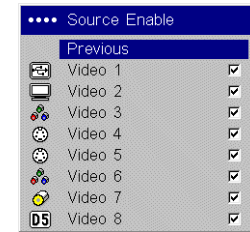

Source Enable

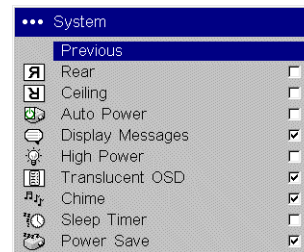

System menu

Translucent OSD: makes the menus translucent. This prevents the image from being completely covered by the menus while you are making image adjustments.

Chime: turn this on to hear a sound when the **Power** button is pressed.

Sleep Timer: allows you to force the projector to automatically shutdown after 4 hours.

Power Save: when On, the lamp is automatically turned off after no signals are detected for 20 minutes. After 10 additional minutes with no signal, the projector powers down. If an active signal is received before the projector powers down, the image will be displayed.

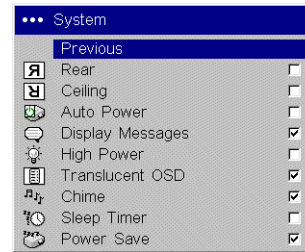

System menu

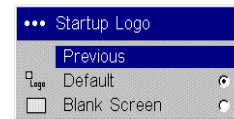

Startup logo

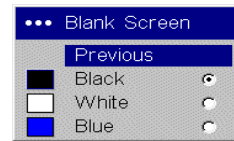

Blank Screen

Startup Logo: allows you to display a blank Black, White, or Blue screen instead of the default screen at startup and when no source is detected.

Blank Screen: determines what color displays when you press the **Blank** button on the remote or when no source is active.



Language

Language: allows you to select a language for the onscreen display of menus and messages.

Service: to use these features, highlight them and press **Select**.

Factory Reset: restores all settings (except Lamp Hours) to their default after displaying a confirmation dialog box.

Test Pattern: displays a test pattern when the **Blank** button on the remote is pressed. To select the patterns, use the up/down arrows on the remote or keypad. Press the remote's Blank button to exit test pattern mode.

Blue Only: turns off the Red and Green portions of the input, allowing you to properly adjust the color balance with a SMPTE color bar pattern.

ADC Calibration: allows adjustment of the calibrated ADC values so that color accuracy can be optimized. Adjust the slidebars for each value and note the change in the appropriate color. Use a component input when adjusting the Component controls.

Service Code: only used by authorized service personnel.

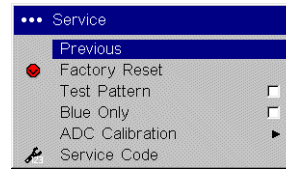

Service menu

Maintenance

Cleaning the lens

- 1 Apply a non-abrasive camera lens cleaner to a soft, dry cloth.

Avoid using an excessive amount of cleaner, and don't apply the cleaner directly to the lens. Abrasive cleaners, solvents or other harsh chemicals might scratch the lens.

- 2 Lightly wipe the cleaning cloth over the lens in a circular motion. If you don't intend to use the projector immediately, replace the lens cap.

clean the lens
with a soft dry cloth
and non-abrasive
cleaner

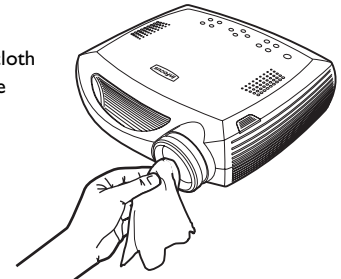

Replacing the projection lamp

The lamp hour timer in the About menu counts the number of hours the lamp has been in use. Twenty hours before the lamp life expires, the message “Change lamp” appears on the screen at startup. If the maximum lamp time is exceeded, the lamp will not light. In this case, after replacing the lamp you must reset the lamp hours by simultaneously pressing both **Brightness** buttons on the keypad and holding them for 10 seconds. You can order new lamp modules from your dealer.

- 1 Turn off the projector and unplug the power cable.
- 2 Wait 60 minutes to allow the projector to cool thoroughly.

- 3 Turn the projector upside down and remove the lamp door by removing the two screws and sliding the lamp door tabs out of the three tab bays.

CAUTION: Never operate the projector with the lamp door removed. This disrupts the air flow and causes the projector to overheat.

- 4 Loosen the captive screw on the lamp module.



•• About	
Previous	
Lamp Hours Used	123
Active Source	Video 4
Signal Format	NTSC
Version	1.0

Lamp hours used

turn off and unplug
the projector

wait 60 minutes

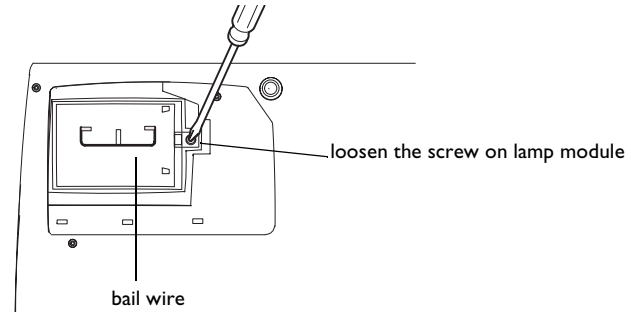
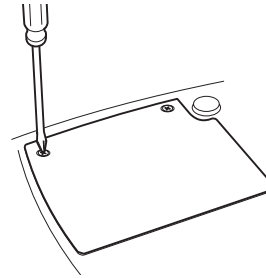
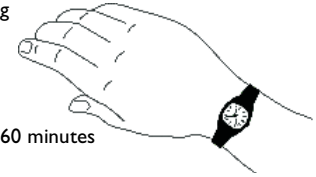

WARNINGS:

- To avoid burns, allow the projector to cool for at least 60 minutes before you replace the lamp.
 - Do not drop the lamp module. The glass may shatter and cause injury.
 - Do not touch the glass lamp screen. Fingerprints can obscure projection sharpness.
 - Be extremely careful when removing the lamp module. In the unlikely event of the lamp rupturing, discard any edible items placed in the surrounding area and thoroughly clean the area along all sides of the projector. Wash hands after cleaning the area and handling the ruptured lamp. This product has a lamp which contains a very small amount of mercury. Dispose of it as required by local, state or federal ordinances and regulations. For more information see www.eiae.org.
- 5 Carefully remove the lamp module by grasping and lifting the metal bail wire. Dispose of the lamp in an environmentally proper manner.
 - 6 Install the new lamp module, making sure that it is properly seated.
 - 7 Tighten the single screw.
 - 8 Replace the lamp door by sliding the tabs into the tab bays and tightening the two screws.
 - 9 Plug in the power cable, then press the **Power** button to turn the projector back on.
 - 10 Reset the lamp hour timer.

Resetting the lamp timer

To reset the lamp age, simultaneously holding down the two **Brightness** buttons on the projector's keypad for 10 seconds.

Using the security lock

The projector has a security lock for use with a PC Guardian Cable Lock System. Refer to the information that came with the lock for instructions on how to use it.

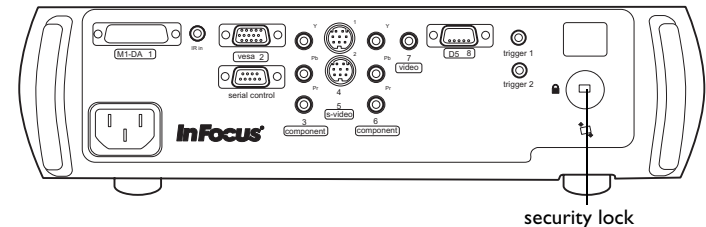

Appendix

Red LED behavior and projector errors

If the projector is not functioning properly and the red LED is blinking, consult **Table 2** to determine a possible cause. There are two second pauses between the blinking cycles. Visit www.infocushome.com/support for more details on the red LED error codes.

Table 3: Red LEDs

Red LED Behavior	Explanation
One (1) blink	The lamp won't strike after five (5) attempts. Check the lamp and lamp door installations for loose connections.
Three (3) blinks	The projector has shut down the lamp. Turn off the projector, wait one minute, then turn it back on. Or, replace the lamp. Contact Technical Support for repair if replacing the lamp does not solve the problem.
Four (4) blinks	The fan has failed. Replace the lamp (the lamp module contains a fan). Contact Technical Support for repair if replacing the fan does not solve the problem.
Five (5) blinks	The projector is overheating. Check for a blocked air vent. Contact Technical Support for repair if clearing the air vents does not solve the problem.

Projected image size

Table 4:
Range of projection distances for a given screen size

16:9 Screen dimensions (inches/m)	Screen diagonal (inches/m)	Projection Distance	
		Maximum zoom (feet/m)	Minimum zoom (feet/m)
27x48 .7x1.2	55.1/1.4	6.7/2.03	8.3/2.54
34x60 .9x1.5	68.8/1.75	8.3/2.5	10.4/3.2
41x72 1.0/1.8	82.6/2.1	10.0/3.0	12.5/3.8
45x80 1.1x2.0	91.8/2.3	11.1/3.4	13.9/4.2
49x87 1.2/2.2	99.8/2.5	12.1/3.7	15.1/4.6
52X92 1.3X2.3	105.6/2.7	12.8/3.9	16.0/4.9
54X96 1.4X2.4	110.1/2.8	13.3/4.1	16.7/5.1
59X104 1.5X2.6	119.3/3.0	14.4/4.4	18.1/5.5
65X116 1.7X2.9	133.1/3.4	16.1/4.9	20.1/6.1

NOTE: Visit our website at www.infocushome.com/support for an interactive image size calculator.

Source compatibility

**Table 5:
Source Compatibility**

Video	Component and RGB HDTV (720p, 1035i, 1080p, 1080p-24Hz) DVI/HDCP for digital video and encrypted digital video Component EDTV (480p, 576p progressive scan), SECAM: M, Component, Composite and S-Video standard video (480i, 576i, 576i RGB SCART with adapter, NTSC, NTSC M 4.43, PAL: B, H, I, M, N)
Computer	Digital and analog PC, Macintosh, 1280x1024 resolution
Communication	USB and RS-232

**Table 6:
Projector Inputs and Outputs**

2-Component (Gold RCA)	HDTV, EDTV, and Standard TV component
1-Component (D5)	HDTV, EDTV, Standard TV, RGB SCART with adapter
2-S-Video	Standard Video
1-Composite (RCA)	Standard Video
1-MI-DA VESA	HDTV RGB, HDTV component, DVI, computer, and USB
1-HD15 VESA	HDTV RGB, HDTV component, computer
1-9-pin Dsub male	RS-232
1-3.5 mm mini jack	IR Repeater (Niles/Xantech compatible)
2-3.5 mm mini jack	1-12v screen drop, 1-12v 4:3 aspect "curtains"

Projector dimensions for ceiling mount installations

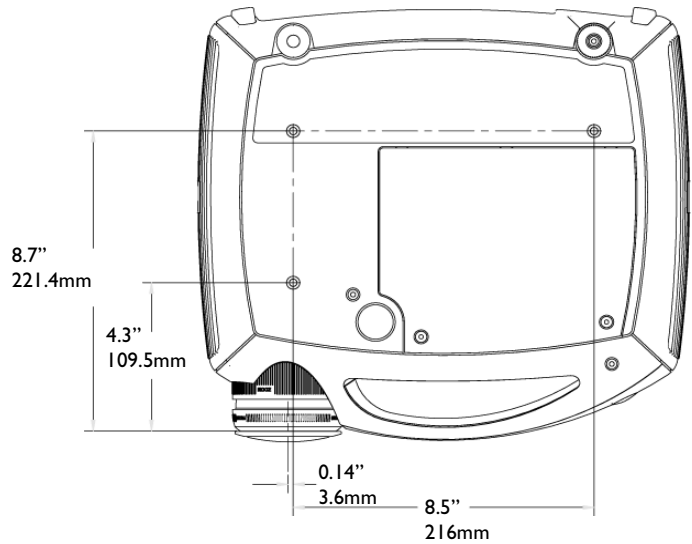
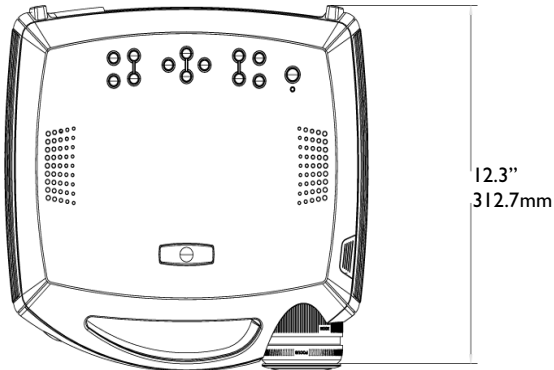
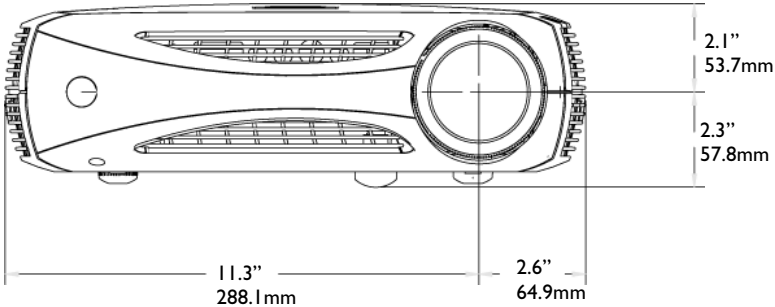

dimensions of optional cable cover: 12.4 x 3.9 x 3.2" (315 x 100 x 82mm)
total length with optional cable cover: 16.2" 411.5mm)

RS-232 terminal specifications

Communication configuration

To control the projector from an LCD control panel, connect an RS-232 cable to the serial control connector on the projector and set your computer's serial port settings to match this communication configuration:

Setting	Value
Bits per second	19,200
Data bits	8
Parity	None
Stop bits	1
Flow control	None
Emulation	VT100

Command format

All commands consist of 3 alpha characters followed by a request, all enclosed in parentheses. The request can be a read request (indicated by a "?") or a write request (indicated by 1 to 4 ASCII digits).

A read request format: (AAA?) where

- (starts the command
- AAA denotes the command
- ? denotes the read request
-) ends the command

A read command returns the range and the current setting, for example:

Function	Command	Response
Brightness	(BRT?)	(0-22, 10)
Lamp hours	(LMP?)	(0-9999, 421)

A write request example: (AAA####) where

- (starts the command
- AAA denotes the command
- #### denotes the value to be written (leading zeros not necessary)
-) ends the command

Some commands have ranges, while others are absolute. If a number greater than the maximum range is received, it is automatically set to the maximum number for that function. If a command is received that is not understood, a "?" is returned. With absolute settings, "0" is off, 1-9999 is on. The one exception is the Power command, where 0 is off and 1 is on.

Function	Command	Response
Brightness	(BRT10)	Sets the brightness to 10
Power	(PWR0)	Turns power off
Power	(PWR1)	Turns power on
Power	(PWR9999)	?

Supported commands

Function	Command	Range	Default
Aspect Ratio	ARZ	0-4 0 = Native 1 = 16:9 2 = 4:3 3 = Letterbox 4 = Natural Wide	1
Auto Chime Enable	ACE	0-1	1
Auto Power	APO	0-1	0
Auto Source	ASC	0-1	0
Blank	BLK	0-1	0
Blank Screen	BSC	0-2 0 = black 1 = blue 2 = white	0
Blue Color Offset	BCO	1-63	32
Blue Gain	BCG	1-63	32
Brightness	BRT	2-254	128
Ceiling	CEL	0-1	0
Chroma Detail	CDE	0-20	0
Color	CLR	2-254	128
Color Space	CSM	0-7 0 = RGB 3 = REC601 2 = REC709 7 = Auto	7

Color Temp	TMP	0-2 0 = 9300 1 = 8200 2 = 6500	2
Contrast	CON	4-252	128
CCS	CCS	0-1	0
Display Messages	DMG	0-1	1
Factory Reset (Write only)	RST	0-1	n/a
Gamma Table	GTB	0-5 0 = CRT 1 = Film 2 = Video 3 = Bright Room 1 4 = Bright Room 2 5 = PC	3
Green Color Offset	GCO	1-63	32
Green Gain	GCG	1-63	32
High Power Enable	HPE	0-1	0
Horizontal Position	HPS	n/a	n/a
Keystone (Vertical)	DKC	53-203	128
Keystone (Horizontal)	DKH	63-193	128
Lamp Hours (Read only)	LMP	0-32767	0
Lamp Reset	LMR	0-32767	0
Luma Detail	LDE	0-20	0
Menu	MNU	0-1	0
Menu Navigation	NAV	0-4 0 = up 1 = down 4 = select	n/a

Language	LAN	0-11 0 = English 1 = French 2 = German 3 = Spanish 4 = Chinese Traditional 5 = Japanese 6 = Korean 7 = Portuguese 8 = Russian 9 = Norwegian 10 = Chinese Simplified 11 = Italian	0	Red Color Offset	RCO	1-63	32
				Red Gain	RCG	1-63	32
				Skintone Bypass Enable	SBE	0-1	0
				Source	SRC	0-7 0 = Video 1, MI 1 = Video 2, VESA 2 = Video 3, Component 1 3 = Video 4, S-Video 1 4 = Video 5, S-Video 2 5 = Video 6, Component 2 6 = Video 7, Composite 7 = Video 8, D5	2
NTSC 2:2 Pulldown Enable	NPE	0-1	0	Startup Logo	DSU	0-1	1
Noise Reduction Enable	NRE	0-2 0 = Off 1 = Auto 2 = Manual	0	Tint	TNT	2-254	128
Noise Reduction Level	NRL	0-10	5	Tracking	MTS	n/a	n/a
Overscan	OVS	127=Crop 128=Off 129=Zoom	128	Translucent OSD	TOE	0-1	1
Phase	MSS	0-31	n/a	TrueLife Enable	TLE	0-1	0
Power	PWR	0-1	0	Vertical Position	VPS	n/a	n/a
Power Save	PSV	0-1	1	Video Standard	VSU	0-3 0 = Auto 1 = NTSC 2 = PAL 3 = SECAM	0
Presets	PST	0-2 0 = User 1 1 = User 2 2 = User 3	0				
Rear Project	REA	0-1	0				

Numerics

12v triggers 5, 35
16x9 5, 14, 22, 24, 25
4x3 25
4x3 aspect trigger 5

A

ADC Calibration 31
adjusting image 10, 24
Advanced menu 27
Aspect Ratio 24
Auto Power 29
Autosource 29

B

Blank Screen 30
blinking green 12
blinking red 12
Blue Only 31

C

cable box 7
CCS 27
Ceiling 29
Chime 30
Chroma Delay 27
Chroma Detail 27
cleaning the lens 31
CLI commands 38
Color 24
Color Control 28
Color Space 28
Color Temperature 28
colors are incorrect 15
command line interface commands 38
component cable connector 8
composite video connector 8
computer, connecting 11
connecting

computer 11
power cable 8
video device 8
connector panel 5
contacting InFocus 19
Contrast 24
customer service contact information 19

D

D65 colors 10
dimensions of projector 36
Display Messages 29
DVI connector 8

E

error codes 34

F

Factory Reset 31
Faroudja video preprocessing 27
Film Mode 27
focus 10
focus ring
threaded 10
fuzzy image 18

G

Gamma 26

H

HDTV 7, 22, 24, 35
HDTV sources 27, 28
height, adjusting 9
High Power 29
Horizontal Position 27

I

image
display video 9
focussing 10
size 6
zooming 10

- image does not fit screen 14
- image edges distorted 14
- image not centered 13
- image not square 14
- image offset 6
- image reversed 15
- image size matrix 34
- image sizes 6
- image torn 16
- image upside down 15
- InFocus website 2
- inputs 35
- IR repeater 5
- K**
- keystone 10, 24
- L**
- lamp replacement 32
- lamp timer, resetting 33
- lamp won't turn on 16
- Language 30
- LED
 - blinking green 12
 - blinking red 16
 - solid green 12
- LED behavior 12, 34
- Lens cleaning 31
- Letterbox 25
- Luma Detail 27
- M**
- Main menu 23
- Maintenance 31
- menus 23
 - changing the language 30
 - making translucent 30

- N**
- Native 24
- Natural Wide 25
- no computer image 17
- no startup screen 13
- Noise Reduction 27
- O**
- offset 6
- only startup screen appears 17
- Overscan 26
- P**
- Phase 27
- Picture menu 24
- Power button 9
- power cable 8, 11
- Power Save 12, 30
- Presets 26
- projection distance 6, 34
- projector
 - adjusting height 9
 - cleaning the lens 31
 - compatible sources 35
 - connecting a video device 8
 - connector panel 5
 - controlling projection screen 5
 - customizing 22
 - dimensions 36
 - displaying a video image 9
 - image sizes 34
 - inputs and outputs 35
 - LED behavior 12
 - maintaining 31
 - menus 23
 - optimizing images 22
 - overview 4
 - positioning 6, 9

- remote control 21
- replacing the lamp 32
- resetting lamp timer 33
- saving settings 26
- security lock 33
- setting up 6
- shutting down 12
- troubleshooting 12

R

- Rear 29
- registering your projector 4
- remote control 21
- replacing the lamp 32
- resetting the lamp timer 33
- Resize button 24
- resolution 4
- RS-232
 - connecting 5, 11
- RS232
 - specifications 37

S

- security lock 33
- Serial connection 11
- serial connection 5, 37
- Service Code 31
- Service menu 31
- Settings menu 29
- shutting down the projector 12
- Sleep Timer 30
- solid green 12
- solid red 12
- source compatibility 35
- Source troubleshooting 13, 17
- Sources 29
- Startup Logo 30
- S-video connector 8
- Sync Threshold Adjust 27

- System menu 29

T

- Test Pattern 31
- threaded focus ring 10
- Tint 24
- Tracking 27
- Translucent OSD 30
- triggers 5
- Troubleshooting 12, 13, 17
- TrueLife settings 27
- TV tuner 7

V

- Vertical Position 27
- VESA connector 8
- video connections 7
- video images, optimizing 22
- video processing 27

W

- warranty 19
- website 2
- White Peaking 26

Z

- zoom 10

Limited Warranty

Subject to the Limitations, Exclusions and Disclaimers hereof, InFocus Corporation (“InFocus”) warrants that the Projector, Lamps and Accessories (hereinafter collectively or individually referred to as “Product” as appropriate) purchased from InFocus, an InFocus distributor, or an InFocus reseller will conform to InFocus’ specifications and be free from defects in material or workmanship for the respective Limited Warranty period provided below. InFocus does not warrant that the Product will meet the specific requirements of the end-user customer.

If the Product while subject to this Limited Warranty, is defective in material or workmanship during the warranty period, then InFocus, at its option, will REPAIR or REPLACE the Product.

All exchanged parts and Products replaced under this Limited Warranty will become property of InFocus. InFocus’ sole obligation is to supply (or pay for) all labor necessary to repair the Product found to be defective within the Limited Warranty period and to repair or replace defective parts with new parts or, at the option of InFocus, serviceable used parts that are equivalent or superior to new parts performance. Limited Warranty periods are as follows:

- **Projector Product Limited Warranty Period (Excluding Lamps):** **Two (2) years** from date of purchase.
- **Lamp Product Limited Warranty Periods:** From the date of Projector Product purchase, the original installed lamp shall have a **90-day or 500 hours** usage Limited Warranty Period, whichever comes first, and replacement Lamps purchased at the time of Projector Product purchase will have a **500 hours** usage Limited Warranty period.
- **Accessory Product Limited Warranty Period:** one (1) year from date of purchase.

WARRANTY LIMITATION AND EXCLUSION

THIS WARRANTY SETS FORTH INFOCUS’ MAXIMUM LIABILITY FOR ITS PRODUCT. THIS WARRANTY EXTENDS ONLY TO PRODUCTS PURCHASED FROM INFOCUS OR AN INFOCUS AUTHORIZED RESELLER. InFocus shall have no further obligation under the foregoing Limited War-

ranty if the Product has been damaged due to abuse, misuse, neglect, smoke exposure (cigarette or otherwise), accident, unusual physical or electrical stress, unauthorized modifications (including use of an unauthorized mount), tampering, alterations, or service other than by InFocus or its authorized agents, causes other than from ordinary use or failure to properly use the Product in the application for which said Product was intended.

This Limited Warranty excludes Product cleaning, repair, or replacement of plastics due to cosmetic damage and damage as a result of normal wear. Product repair outside of the terms of the Limited Warranty will be on a time and materials basis. Prolonged Product “demonstration” causes unusual Product wear and is not considered normal use under the terms of this Limited Warranty.

The Accessory Product Limited Warranty covers the accessory item only and excludes normal wear. The Lamp Product Limited Warranty excludes expected lamp degradation.

Remanufactured Products and Software Products are exempt from the foregoing Limited Warranty. Please refer to the appropriate Remanufactured Product Limited Warranty or Software Product Limited Warranty for applicable Warranty information.

DISCLAIMER OF UNSTATED WARRANTIES

THE WARRANTY PRINTED ABOVE IS THE ONLY WARRANTY APPLICABLE TO THIS PRODUCT. ALL OTHER WARRANTIES, EXPRESS OR IMPLIED, INCLUDING, BUT NOT LIMITED TO, THE IMPLIED WARRANTIES OF MERCHANTABILITY AND FITNESS FOR PARTICULAR PURPOSE ARE DISCLAIMED. THERE ARE NO WARRANTIES THAT EXTEND BEYOND THE DESCRIPTION ON THE FACE HEREOF AND THE FOREGOING WARRANTY SHALL NOT BE EXTENDED, ALTERED OR VARIED EXCEPT BY WRITTEN INSTRUMENT SIGNED BY INFOCUS. SOME JURISDICTIONS DO NOT ALLOW LIMITATIONS ON HOW LONG AN IMPLIED WARRANTY MAY LAST, SO SUCH LIMITATIONS MAY NOT APPLY TO YOU.

Limited Warranty Period

The Limited Warranty periods hereof commence on the date of purchase by the end-user customer. These Limited Warranty provisions shall apply only to the end-user purchaser (first person or entity that purchased a new Product for personal or business use and not for the purpose of distribution or resale). SOME JURISDICTIONS MAY GRANT YOU CONSUMER RIGHTS WITH MINIMUM WARRANTY DURATION THAT DIFFER FROM THE DURATIONS PROVIDED HEREIN, AND INFOCUS WILL HONOR ALL SUCH CONSUMER RIGHTS.

To Be Eligible For Limited Warranty Coverage

Any person exercising a claim under this Limited Warranty must establish to the satisfaction of InFocus both the date of purchase and that the Product was purchased new. The sales receipt or invoice, showing the date of purchase of the Product is the proof of the date of purchase.

To Obtain Warranty Service

During the Limited Warranty period, to exercise this Limited Warranty, the purchaser must first contact 1) InFocus, 2) a service facility authorized by InFocus or 3) the place of original purchase.

InFocus Customer Service – 1-800-799-9911 or techsupport@infocus.com

For Warranty service, the purchaser will be advised to return or deliver the defective Product freight and all fees prepaid, to an InFocus Service Center or to a service facility authorized by InFocus. When returning Product to InFocus, a Return Material Authorization Number (RMA); is required and must be clearly displayed on the outside of the shipping carton or a similar package affording an equal degree of protection. InFocus or the service facility authorized by InFocus will return the repaired/replaced Product freight prepaid to the purchaser.

Products returned for Warranty service must be accompanied by a written letter that: (i) explains the problem; (ii) provides proof of date of purchase; (II) provides the dealer's name; and (I) provides the model and serial number of the Product.

Upon request of InFocus Corporation or an authorized repair center for InFocus, proof of legal import must accompany the warranty repair Product, otherwise the Product must be returned to the place of original purchase, to the manufacturer (Purchaser must bear all tax, duty and freight), or the Purchaser must bear charges for the warranty repair.

No repair or replacement of Product or part thereof shall extend the Limited Warranty period as to the entire Product. Warranty on the repair part and workmanship shall only be effective for a period of ninety (90) days following the repair or replacement of that part or the remaining period of the Product Limited Warranty whichever is greater.

LIMITATION OF LIABILITY

IT IS UNDERSTOOD AND AGREED THAT INFOCUS' LIABILITY WHETHER IN CONTRACT, IN TORT, UNDER ANY WARRANTY, IN NEGLIGENCE OR OTHERWISE SHALL NOT EXCEED THE RETURN OF THE AMOUNT OF THE PURCHASE PRICE PAID BY PURCHASER AND UNDER NO CIRCUMSTANCES SHALL INFOCUS BE LIABLE FOR SPECIAL, INDIRECT, INCIDENTAL OR CONSEQUENTIAL DAMAGES OR LOST PROFITS, LOST REVENUES OR LOST SAVINGS. THE PRICE STATED FOR THE PRODUCTS IS A CONSIDERATION IN LIMITING INFOCUS' LIABILITY.

Limitation on Bringing Action - No action, regardless of form, arising out of the agreement to purchase the Product may be brought by purchaser more than one year after the cause of action has accrued.

Governing Law - Any action, regardless of form, arising out of the agreement to purchase the Product is governed by Oregon law.

Mandatory Arbitration – Any action, regardless of form, arising out of the agreement to purchase the Product is subject to mandatory arbitration.

SOME JURISDICTIONS DO NOT ALLOW THE EXCLUSION OR LIMITATION OF INCIDENTAL OR CONSEQUENTIAL DAMAGES SO THE ABOVE LIMITATION OR EXCLUSION MAY NOT APPLY TO YOU. THIS LIMITED WARRANTY GIVES YOU SPECIFIC LEGAL RIGHTS, AND YOU MAY ALSO HAVE OTHER RIGHTS, DEPENDING ON JURISDICTION.