

CPC 100

Multi-functional primary test system for substation commissioning and maintenance



CPC 100 – The revolutionary all-in-one test system

The patented test system replaces numerous individual testing devices and offers new, innovative testing methods. This makes testing with the CPC 100 a time-saving and cost-effective alternative for conventional testing methods. Despite its expansive capabilities, the CPC 100 is very simple to use.

Using the CPC 100, electrical tests on various assets can be performed:

- > Current transformers
- > Voltage transformers
- > Power transformers
- > Power lines
- > High-voltage (HV) cables
- > Grounding systems
- > Rotating machines
- > GIS systems
- > Switchgear and circuit breakers
- > IEC 61850 installations
- > Protection relays

The powerful testing device provides up to 800 A or 2 kV (2 kA or 12 kV with accessories) with up to 5 kVA over a frequency range of 15 Hz to 400 Hz or 400 A_{DC}.

Its compact design (29 kg / 64 lbs) makes it easy to transport and ideal for on-site testing.

Testing with variable frequency

The CPC 100's variable output frequency allows the use of test frequencies different from the mains frequency offering a very effective suppression of mains-related interference. Thus the CPC 100 is able to obtain very accurate results even in extremely noisy environments.

Another critical advantage to performing measurements at different frequencies is the opportunity this provides to gain more information about the asset under test.

The CPC 100 utilizes switched mode amplifiers and frequency shift techniques to generate its variable output frequency.

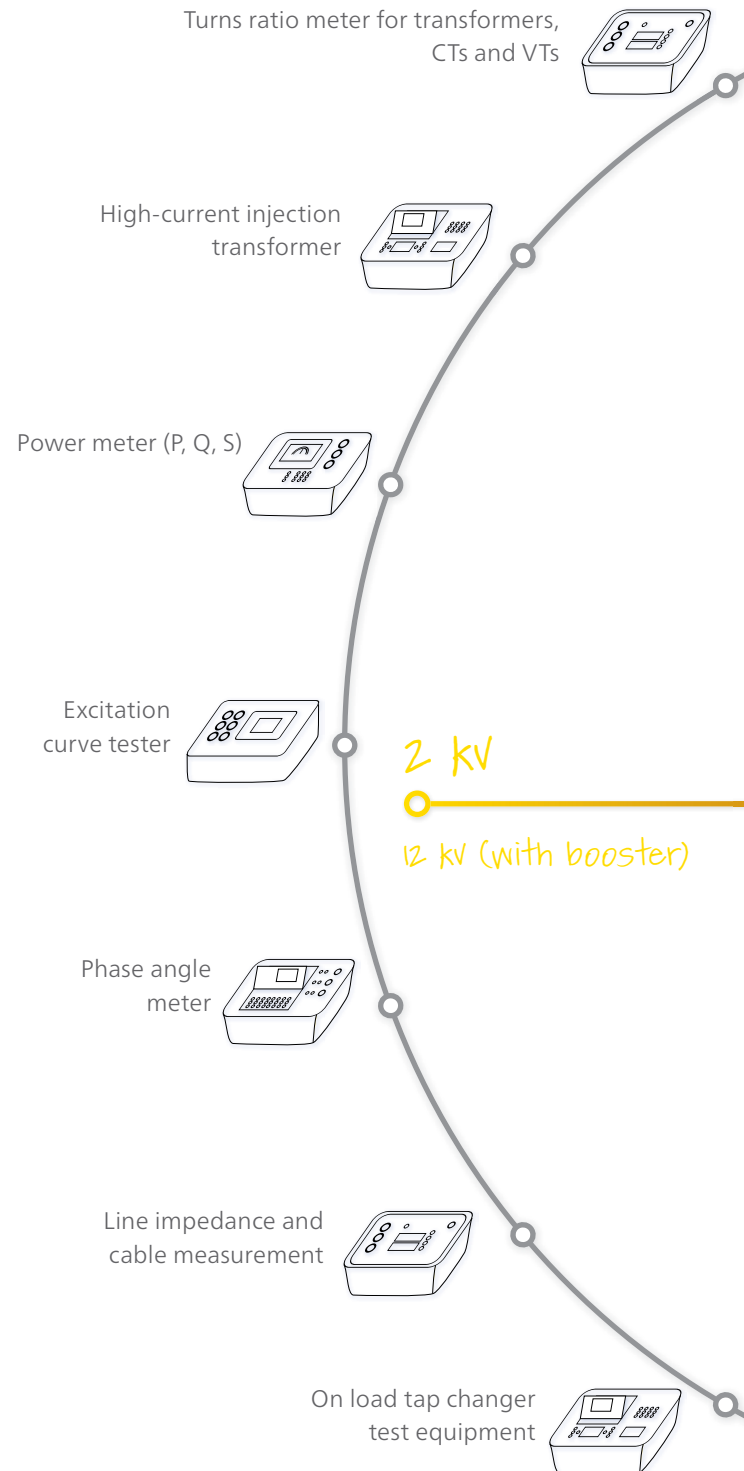



Ground resistance meter

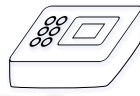

Micro ohmmeter
400 A_{DC}

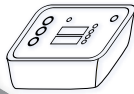

Tester for Rogowski coils and other unconventional CTs / VTs (IEC 61850)



Winding resistance meter

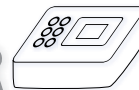

Protection relay tester
(one phase V, I, f)



Multimeter
(V, I, R, Z, ...)

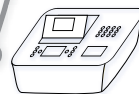

Step up transformer
2000 V



Complex impedance meter
(burdens, cables, lines and transformers)



Vector group verification system
for power transformers



Power / dissipation factor
measurement set



Polarity
checker

29 kg / 64 lbs
single phase wall outlet



400 A_{DC}

800 A_{AC}
2 kA (with booster)

15 Hz - 400 Hz

CPC 100 product family – Extended range of applications

The CPC 100 covers a lot of different applications in and around substations as well as at the manufacturer's production site. Extended by a high number of valuable accessories the application range of the CPC 100 is further expanded. Thus it is the ideal instrument for all major applications in the area of primary testing.

CPC 100 Applications

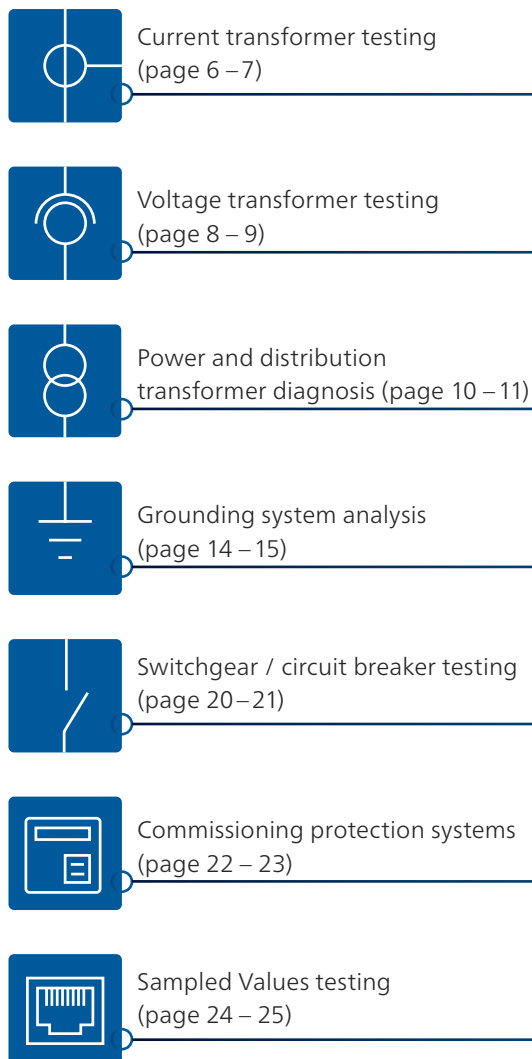

Primary test system

**Extended range
with accessories**



Coupling unit



Grounding box

HV cable and power line analysis
(page 12 – 13)

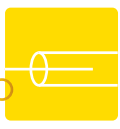

Handheld grounding tester

Grounding system analysis
(page 14 – 15)



Switch box

Power and distribution transformer
diagnosis (page 10 – 11)



Compensation reactor

Switchgear / circuit breaker testing
(page 20 – 21)



Tan Delta test set

Rotating machine diagnosis
(page 16 – 17)



Current booster

Voltage transformer testing
(page 6 – 7)



Current transformer testing
(page 8 – 9)



Sampled Values testing
(page 24 – 25)



Resonance circuit

Gas Insulated Switchgear testing
(page 18 – 19)



Current transformer testing

Testing current transformers helps to detect:

Installation related failures:

- > Transportation damages
- > Wiring errors
- > Manufacturing defects

In-service related failures:

- > Degradation of accuracy class
- > Shorted turns
- > Magnetized core
- > Burden failures in secondary circuit
- > Insulation material failures

With the CPC 100 many standard electrical tests for CTs can be performed with one single device saving testing time and labor costs. Additionally, unconventional CTs, like Rogowski coils and IEC 61850 integrated systems, can also be tested.

CT testing with the CPC 100

Supplied from a single phase wall outlet, the CPC 100 can generate up to 800 A_{AC} (2000 A with CP CB2 current booster) for injecting into the CT's primary side and testing its ratio, polarity and burden.

For excitation curve measurement, the CPC 100's output is connected to the secondary terminals of the core. Within an automatic test run, the CPC 100 measures the excitation curve and displays the knee point voltage and knee point current (according to the relevant IEC or IEEE / ANSI standard). The CPC 100 also automatically demagnetizes the CT core after the test.

Using the winding resistance measurement function also allows the user to calculate the accuracy limiting factor (ALF) for protection circuits and the instrument security factor (FS) for metering circuits.

The CT winding resistance and power / dissipation factor can also be measured.



Current transformer testing

- > CT ratio (with burden)
up to 800 A or 2000 A with CP CB2, 5 kVA output power
- > CT burden
up to 6 A_{AC} | secondary
- > CT excitation curve (knee point)
up to 2 kV_{AC}
- > Polarity check with CPOL
up to 800 A or up to 2000 A with CP CB2, 5 kVA output power
- > Accuracy limiting factor (ALF) test
- > CT ratio with voltage
up to 130 V_{AC} | bushing CTs
- > CT winding resistance
up to 6 A_{DC}
- > CT voltage withstand test
up to 2 kV_{AC}
- > CT ratio Rogowski and CT ratio low power
up to 800 A or up to 2000 A with CP CB2, 5 kVA output power
- > Power / dissipation factor (tan δ) test
up to 12 kV, 300 mA | with CP TD1
- > IEC 61850 Sampled Values testing

10 reasons to choose a CPC 100

Multi-functionality 1

With one easy-to-use system you can:

- > Test several assets
(for example CT, VT, CB, power transformer)
- > Test different parts of an asset
(for example core, windings, bushing, insulation)
- > Perform numerous tests
(for example ratio, polarity, burden, excitation current)

CP CB2 (current booster)

2 kA



With the CP CB2 primary injection of current up to 2 kA can be realized for CT testing.

CP TD1 (tan δ)

12 kV



For high-voltage CTs, insulation material tests are very important and can be easily done with the CP TD1 accessory.

CPOL (polarity checker)



The CPOL can check the correct polarity along the different connection points in the secondary wiring by analyzing the sawtooth signal injected into the CT's primary side using the CPC 100.

Voltage transformer testing

The majority of VT failures occur due to electrical stresses or manufacturing and installation errors. Typically electrical stresses are caused by:

- > Thunderstorms
- > Ferro-resonances effects
- > Over-voltages

Especially in high-voltage and extra high-voltage installations supervision of the VT insulation system is important to ensure that its dielectric characteristics have not degraded over time.

In case of (re-)commissioning of substations VT circuits should also be checked. Verifying the VT's nameplate data helps to identify damages of the VT or wrong connections.

VT testing with the CPC 100

With a voltage output of up to $2000 V_{AC}$ the CPC 100 can be used to test VT ratio, polarity and burden.

By injecting voltage into the primary side, ratio can be measured. Thereby the phase angles of high-voltage output and voltage measurement input are also measured. Thus the correct VT polarity can be verified.

Applying voltage to the secondary VT circuits and measuring the load current in amplitude and phase allows the actual burden to be measured, ensuring that it is within the VT's specification data.

Disturbance-free measurement

The VT's secondary signal may be difficult to measure if it is small in amplitude – especially if neighboring parts of the substation are in operation. In case of strong disturbances, the user can select a frequency different to that of the power system and utilizes the “frequency selective measurement” function. Thus only the VT's output signal with this particular frequency is measured while all other signals are filtered out.



0 ... 2 kV

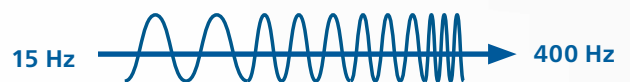

With the wide frequency range excellent noise interference suppression can be achieved when testing in the harsh HV environment.

Voltage transformer testing

- > VT ratio
up to 2 kV_{AC} | polarity and burden
- > VT burden
up to 130 V_{AC} | secondary
- > VT secondary voltage withstand test
up to 2 kV_{AC}
- > Polarity check with CPOL
up to 2 kV_{AC}
- > VT electronics
up to 2 kV_{AC}
- > IEC 61850 Sampled Values testing
- > Power / dissipation factor (tan δ) test
up to 12 kV, 300 mA | with CP TD1

10 reasons to choose a CPC 100

Variable frequency 2

- > Voltage and current injection with variable frequency
- > Suppression of mains-related interference and disturbances
- > Test results at different frequencies provide more detailed information about an asset (for example more information about the insulation condition)
- > Variable frequency testing is necessary for some standardized and advanced diagnostic tests

CP TD1 (tan δ)

12 kV



For high-voltage VTs, insulation material tests are very important and can be easily done with the CP TD1 accessory.

CPOL (polarity checker)



The CPOL can check the correct polarity along the different connection points in the secondary wiring by analyzing the sawtooth signal injected into the VT's primary side using the CPC 100.

Power transformer testing

Testing to assess the health of power transformers and to diagnose problems is of utmost importance to ensure the long-term and safe operation of these very expensive power assets.

With the CPC 100 power transformers and their ancillary components can be tested:

- > Windings
- > Tap changer
- > Bushings
- > Insulation
- > Core
- > Connection leads
- > Surge arrestors

Testing power transformers – Most common electrical tests with one device

The CPC 100 provides an easy and accurate (4-wire connection) winding resistance measurement. Automatic measurement for tapped windings (by using CP SB1 with the on load tap changer) speeds up the measurement. The CPC 100 automatically discharges the inductive energy, which makes the measurement safe.

After switching off a transformer or after applying DC signals to a transformer, the core remains magnetized. This can cause problems for further diagnostic measurements or can lead to higher inrush currents. By using the CP SB1 switch box the integrated algorithm in the CPC 100 completely demagnetizes the transformer core.

For measuring ratio and excitation current, the CPC 100 provides a 2 kV output, delivering 2500 VA. The test voltage is generated digitally and the current is automatically measured within the CPC 100. This makes the measurement highly accurate, easy to set up, fast and safe.

For power / dissipation factor (PF / DF) measurement of power transformers and bushings, the CPC 100 is combined with the CP TD1. Measuring this factor over a broad frequency range – in addition to mains frequency – helps to better assess the insulation condition, for example detect whether the cellulose or the oil is contaminated by moisture.



0 ... 2 kV

1 Ø

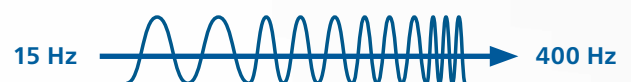

The wide frequency range of 15 Hz to 400 Hz is needed for advanced $\tan \delta$ tests, which give the user important information about the transformer aging.

Power transformer testing

- > DC winding resistance
up to 100 A_{DC}
- > Transformer demagnetization
with CP SB1
- > Dynamic load tap changer diagnostics
(on load tap changer test)
up to 100 A_{DC} | optionally with CP SB1
- > Transformer turns ratio (TTR) per tap
up to 2 kV_{AC} | including polarity and excitation current |
IEC 61387-1 support for transformer with unconventional vector groups
- > Automatically determination of the transformer's
vector group
with CP SB1
- > Leakage reactance / short circuit impedance
up to 6 A_{AC}
- > Transformer, bushing: power / dissipation factor (tan δ)
+ insulation capacitance
up to 12 kV, 300 mA | frequency from 15 Hz to 400 Hz | with CP TD1
- > Insulating fluids: power / dissipation factor (tan δ)
up to 12 kV, 300 mA | with CP TD1 and CP TC12
- > Excitation current per tap
up to 12 kV, 300 mA | with CP TD1
- > Frequency response of stray losses (FRSL)
- > Surge arrestors: leakage current and watt losses
up to 12 kV, 300 mA | with CP TD1

10 reasons to choose a CPC 100

Testing and reporting

3

- > Offline test preparation possibilities
(time-saving and less error-prone)
- > CPC 100 software automatically guiding
the user through the test
- > Automated report generation
- > Customizable test reports (for example
different languages, customer logo)

CP TD1 (tan δ)

12 kV



Insulation condition assessment of transformers, bushings and insulation fluids (with the CP TC12).

CP SB1 (switch box)

3 Ø, N



The CP SB1 switch box is the connection between transformer and CPC 100. Connecting all phases simultaneously avoids wiring errors and the need to repeatedly climb the transformer. Automatic OLTC control speeds up testing.

HV cable and power line testing

For a reliable power supply, selective operation of protection relays is crucial. Over- and underreach can be avoided by having correct relay settings, and line data. Therefore it is necessary to determine line parameters, such as positive sequence impedance, zero sequence impedance or k-factors.

Calculating impedances and the k-factor is highly error-prone. Measuring line and ground impedance eliminates these errors and contributes to system reliability by providing proper relay settings.

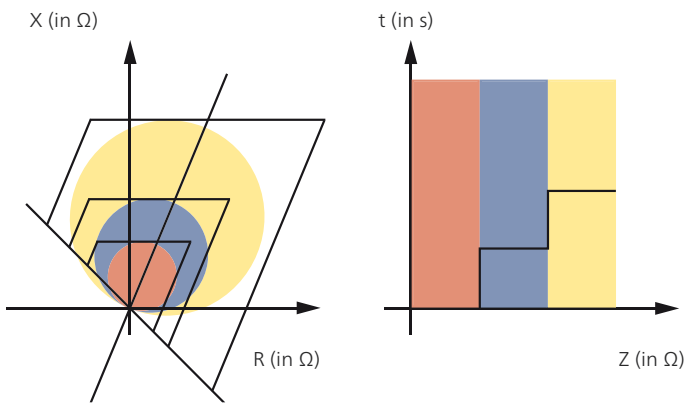

Line parameter measurement

With the CPC 100 and the CP CU1 the impedance of cables and power lines can be measured accurately, quickly (in approximately two hours) and safely.

Line impedance and k-factor

The CPC 100 and the CP CU1 are used to inject current into the different phase-phase and phase-ground loops of a power line / cable, grounded at the other end, while measuring voltage, current and phase angle. From the measurement data of the different loops, line parameters are calculated. Variable frequency injection allows measurements to be made despite coupling from live parts or neighboring lines.

Mutual coupling

With this unique testing equipment, the mutual coupling factor of parallel lines can also be determined, allowing the correct parameterization of the mutual coupling algorithm of modern line protection relays.



CP CU1



Using variable output frequency, measurements with the CPC 100 are not influenced by mains frequency coupling. Precise and reproducible measurement results, even in noisy environments, are possible.

Cable and transmission line diagnosis

- > Line impedance and k-factor
up to 100 A | with CP CU1
- > Mutual coupling
up to 100 A | with CP CU1
- > Positive or zero sequence impedance

10 reasons to choose a CPC 100

Weight and size

4

- > Light-weight (29 kg / 64 lbs)
- > Compact design
- > Save costs on:
 - > Transport
 - > Handling
 - > Storage



The CP CU1 allows the safe connection of the CPC 100 to a power line or HV cable. The impedance matching transformer within the CP CU1 ensures optimum power transfer from the CPC 100 to the power line.

The CP GB1 grounding box contains surge arrestors to ensure safe testing during unexpected events.

Substation grounding analysis

The grounding of a high-voltage electrical system helps to ensure the safety of personnel. Voltage rises in the neighboring area of electrical systems, caused by a system fault or lightning, can be extremely dangerous.

Conventional test solutions, which use power system frequencies, need enormous power and complicated methods to overcome the problems of interference. Varying the frequency and using narrowband digital filtering with the CPC 100 and CP CU1 reduces the required power and the equipment weight to a minimum.

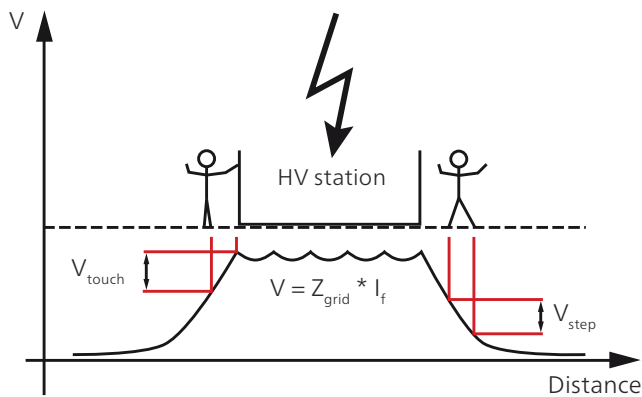

Ground grid impedance

Using the current-voltage method, the challenge for good ground impedance (Z_{grid}) measurements is to inject sufficient measurement current into the soil at a remote location and to measure the voltage rise caused by this injection – and not by any other current in the ground.

The CPC 100 and CP CU1 test system meets this challenge. It injects current at non-network frequencies into the soil at a remote station via the existing power lines. It then selectively measures the voltage rise at the used frequencies.

The measurements are performed according to international standards including DIN VDE 0101, CENELEC HD63751, IEEE Std 80-2000 and IEEE Std 81-1983.

Step and touch voltages

The step and touch voltages (V_{step} and V_{touch}) of the local station can be measured with the CPC 100 itself or more conveniently with the HGT1 – a frequency selective voltmeter which minimizes wiring.



CP CU1

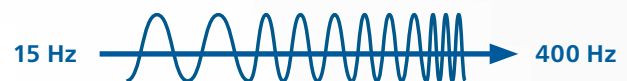

Using variable output frequency, measurements with the CPC 100 are not influenced by mains frequency coupling. Precise and reproducible measurement results, even in noisy environments, are possible.

Ground system analysis

- > Ground grid impedance for large systems
up to 100 A | with CP CU1
- > Step and touch voltage
up to 100 A | with CP CU1 and HGT1
- > Ground grid impedance for small systems
up to 6 A_{AC}
- > Soil resistivity
up to 6 A_{AC}
- > Integrity check of grounding connection
up to 400 A_{DC}
- > Reduction factor / current split factor
- > Measure multiple current paths with Rogowski coil

10 reasons to choose a CPC 100

Safety

5

- > Emergency switch-off button
- > Ground connection check
- > Overload detection
- > Multiple isolated outputs
- > Safety key lock
- > Discharge circuit to de-energize DC test objects
- > Strobe light
- > 3-position safety switch
- > Grounding box



The CP GB1 contains surge arrestors to ensure safe testing during unexpected events.

The HGT1 is a handheld measurement device to measure step and touch voltages within HV stations and surrounding areas. With the HGT1 extremely long measurement cables can be avoided.

The CP CU1 allows the safe connection of the CPC 100 to a power line or HV cable. The impedance matching transformer within the CP CU1 ensures optimum power transfer from the CPC 100 to the power line.

Rotating machines diagnosis

The most sensitive part in rotating machines is the insulation. The expected lifetime of a stator winding depends on the ability of the insulation to prevent winding faults.

High temperatures and high rates of temperature changes can generate micro-voids particularly at the interface between mica and resin, and between semiconductive layers and resin. Partial discharges in these voids will further increase the void size by erosion and complete breakdowns are inevitable.

Therefore, experts strongly recommend the checking of insulation for partial discharges during the whole lifecycle of motors and generators. In order to check the insulation a compensated high-voltage source is needed. The CPC 100, CP TD1 and CP CR500 test system can be utilized as a high-voltage source.

" $\Delta \tan \delta$ " test and tip-up test

As maintenance tools for entire windings, the " $\Delta \tan \delta$ " test and the tip-up test are used. Both tests are an indirect way of determining if partial discharges (PD) are occurring in a high-voltage stator winding.

An increase of the power factor / dissipation factor (tip-up) from the normal level indicates that the winding has significant PD activity, as this is indicative of this condition.

The CPC 100, CP TD1 and CP CR500 test system allow " $\Delta \tan \delta$ " and tip-up tests complying with the IEC 60894 and IEEE 286 specifications.

An acceptable power / dissipation factor offers assurance that the coil or the bar were properly fabricated with inherently low-loss materials.

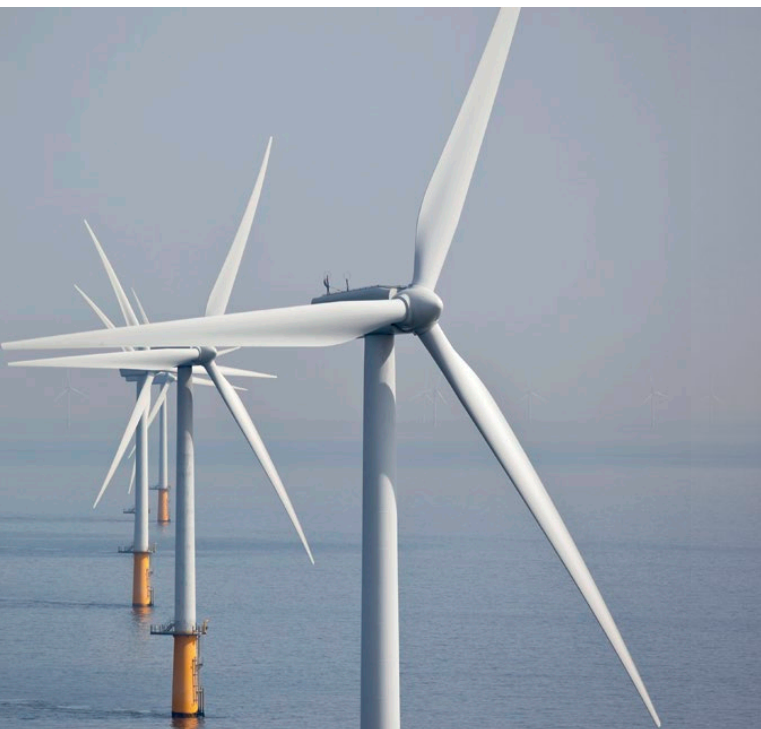

Rotating machines diagnosis

- > Power / dissipation factor ($\tan \delta$) tip-up test at 50 Hz / 60 Hz
up to 12 kV | max. 1 μF / 4 A | with CP TD1 and CP CR500
- > Power / dissipation factor test with variable frequency
up to 12 kV | frequency from 15 Hz to 400 Hz | with CP TD1
- > HV source for testing rotating machines
up to 12 kV | max. 2 μF | with CP TD1 and CP CR500

10 reasons to choose a CPC 100

Product quality

6

- > Durable case design for rough environments with test field accuracy
- > Long lifetime due to high quality components
- > Premium quality cables and clamps
- > Comprehensive documentation (for example, user manual with connection diagrams, software help function, videos, application notes)



Insulation condition assessment of motors and generators. The CPC 100 plus CP TD1 can provide up to 12 kV and can also be used as a HV source.

The CP CR500 compensator reactor enables the CP TD1 to be used with test objects with large capacitance such as large motors and generators.

Gas-insulated switchgear testing

Testing gas-insulated switchgear to date

Gas-insulated switchgears (GIS) are compact and are, therefore, used in applications where space is limited. For commissioning of GIS a high-voltage (HV) withstand test is required in accordance with standards (IEC 62271-203).

To date the test voltage needed for a withstand test has been produced by a resonance circuit. This test system consists of an HV test transformer, a coupling capacitor and a power control unit. The HV test transformer and the coupling capacitor have to be connected directly to the GIS.

Weak points of this testing principle:

- > The complete test system is difficult to transport, because it consists of very heavy and large components.
- > It is difficult to use it at test sites with limited space, such as wind turbines.
- > The HV test lead must be connected to, and disconnected from, the GIS system for testing. This normally includes a time-consuming venting and refilling process of the SF₆ gas.

Innovative GIS testing

With OMICRON's CPC 100 + CP RC you can perform GIS tests without the need of a big HV transformer. This is possible because the system directly makes use of a specially designed "Power VT" for testing.

This Power VT is an integral part of the GIS and generates the required test voltage. CPC 100 injects power at the low-voltage (LV) side of the VT, producing the necessary voltage on the HV side. As you can directly connect the measuring system to the integrated VT of the GIS system it eliminates the need for draining and refilling any SF₆ gas.

The CPC 100 + CP RC system comprises several small and light-weight components (< 21 kg / 46 lbs) which can be transported by one person. With its modular design you can perform GIS tests even at test sites with limited space.

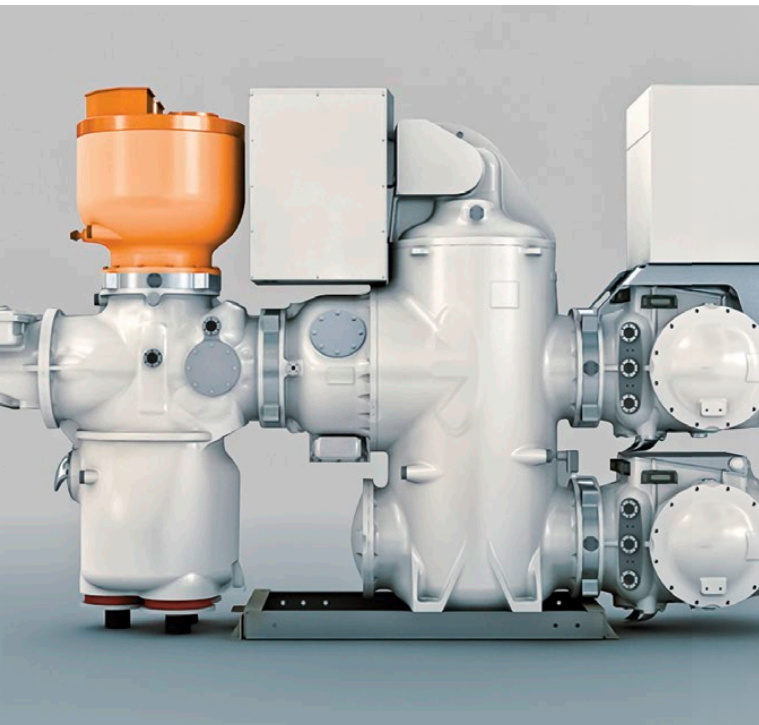

Auto-transformer CP AT1

The CP AT1 allows you to connect the mains supply of the CPC 100 to a three-phase 16 A power outlet, and delivers the required power for the test setup.

Control unit CPC 100

The CPC 100 supplies the required energy and acts as both measuring and controlling device.

GIS testing

- > Withstand test
up to 235 kV | max 1.6 nF | with CP RC2
- > High-voltage source for partial discharge measurements
up to 235 kV | max 1.6 nF | with CP RC2

10 reasons to choose a CPC 100

Expandability 7

- > Further applications can be covered by adding additional hardware accessories
- > By upgrading the software:
 - > Additional tests can be performed
 - > Additional assets can be tested

CPC 100 + CP RC2: testing GIS up to 145 kV rated voltage

CPC 100 + CP RC1: testing GIS up to 123 kV rated voltage



Isolation transformer CP TR

The CP TR provides a potential-free output signal and compensates the capacitive load.



Compensating reactor CP CR

With 4 mH (CP CR4) or 6 mH (CP CR6) the CP CR compensates the capacitance in a modular fashion.



Power VT

In addition to the measurement function of a VT the Power VT offers the possibility to generate high voltage for testing.

Switchgear and circuit breaker testing

Switchgear consists of busbars, circuit breakers (CB), disconnectors and earthing switches. There are various connections and contacts within the switchgear. Poorly maintained or damaged contacts can cause arcing, single phasing or even fire which can lead to the total loss of the asset.

Therefore, it is common practice to conduct contact resistance measurements to ensure that the connections have been made with the appropriate contact pressure.

Additionally, the insulation of CBs within the switchgear has to be tested. These assets are frequently exposed to HV stresses, switching currents and very high fault currents, which heat up the circuit breakers and impact on the insulation material.

Contact resistance measurement

The CPC 100 can measure contact resistance by injecting a current of up to 400 A_{DC} into the contacts and measuring the voltage drop (using the 4-wire method). The resistance value can be compared to the value given by the manufacturer as well as to previous records.

Insulation testing of circuit breakers

For power / dissipation factor ($\tan \delta$) measurements of circuit breakers, the CPC 100 is combined with the CP TD1. Measuring this factor over a wide frequency range – in addition to mains frequency – helps to better assess the insulation condition.

Timing of CBs with overcurrent elements

For testing of CBs or load breaker switches with integrated overcurrent elements, the CPC 100 can inject AC primary currents up to 800 A (or 2000 A together with the current booster CP CB2), and measure the time from the start of the injection to the interruption of the current.



$\mu\Omega$ measurement with the CPC 100's 400 A_{DC} capabilities enables accurate contact resistance measurements on circuit breakers.

Switchgear / circuit breaker testing

- > Contact resistance
up to 400 A_{DC}
- > Bushing: power / dissipation factor (tan δ)
+ insulation capacitance
12 kV, 300 mA | frequency from 15 Hz to 400 Hz | with CP TD1
- > Overcurrent relays with primary injection (MV)
up to 800 A or 2000 A with CP CB2, 5 kVA output power
- > Circuit breaker: Power / dissipation factor (tan δ)
up to 12 kV, 300 mA | frequency from 15 Hz to 400 Hz | with CP TD1
- > Insulating fluids: power / dissipation factor (tan δ)
up to 12 kV, 300 mA | with CP TD1 and CP TC12

10 reasons to choose a CPC 100

Support

8

- > International technical support
- > On-site support for issues concerning testing, start-up and maintenance
- > Repair centers around the world
- > Local support by worldwide sales partner network
- > Consulting on the development of individual testing concepts
- > Training classes around the globe

CP TD1 (tan δ)

12 kV



Insulation condition assessment of circuit breakers and insulation fluids (with CP TC12).

Commissioning and trouble shooting of protection systems

In order to work properly, protection and control systems have to be correctly integrated into the substation or power plant. Quantities from the primary system are transformed at the VTs and CTs – using their different cores – and so the voltage and current signals must be correctly connected to the protection relays, automation units and meters.

From these protection and control units, the trip signals are routed back to the primary apparatus, for example, the circuit breakers. A fault in any part of this system may result in a system failure – false tripping or a failure to trip.

To prevent such a failure, the system's functionality can be verified by injecting into the primary side of the CT or VT and checking the measured values at the relay or automation unit. Finally, injecting current at the magnitude of a fault should result in the tripping of the circuit breaker, which allows the verification of the complete chain.

Commissioning protection systems

The CPC 100 allows the verification of the ratio and polarity of CTs and VTs – preventing wrong connections, especially in the case of tapped CTs. Injecting current or voltage into individual CTs / VTs and checking the reading at the relay ensures that phases are not mixed up and that the CT and VT ratio setting in the relay is correct.

The CPC 100 can also measure the burden on the CTs and VTs and, by determining the CT's excitation curve, it ensures that the protection circuits are connected to the appropriate CT cores.

The CPC 100 can help to verify that the secondary wiring is correct. By injecting a sawtooth signal into the CT or VT, the operator verifies with a handheld device that the signal has the correct polarity at the connection points of the secondary systems.

With the CPC 100 primary faults can be simulated to check if overcurrent, differential or distance relays operate correctly. The total trip time including the CB operating time can also be measured in this test.



0 ... 800 A

0 ... 2 kV

The CPC 100 can inject up to 800 A (2000 A with the CP CB2) or up to 2 kV as well as a sawtooth polarity check signal into CTs or VTs in the HV yard, hence performing testing on the whole system.

Protection installation testing

- > CT ratio (with burden)
 - up to 800 A or 2000 A with the CP CB2, 5 kVA output power
- > CT burden
 - up to 6 A_{AC} | secondary
- > CT excitation curve (knee point)
 - up to 2 kV_{AC}
- > VT ratio
 - up to 2 kV_{AC} | polarity and burden
- > VT burden
 - up to 130 V_{AC} | secondary
- > Overcurrent relays with primary injection (MV)
 - up to 800 A or 2000 A with the CP CB2, 5 kVA output power
- > Polarity check with CPOL
 - up to 800 A or 2 kV_{AC}, 5 kVA output power
- > Testing of the entire protection chain
 - by primary fault current injection and live CB tripping

10 reasons to choose a CPC 100

Conformity to standards

9

- > CPC 100 fulfills highest safety requirements
- > CPC 100 is CE tested
- > CPC 100 tests according to IEEE and IEC standards
- > Measurements with the CPC 100 deliver reliable and repeatable results due to high signal and measurement accuracy

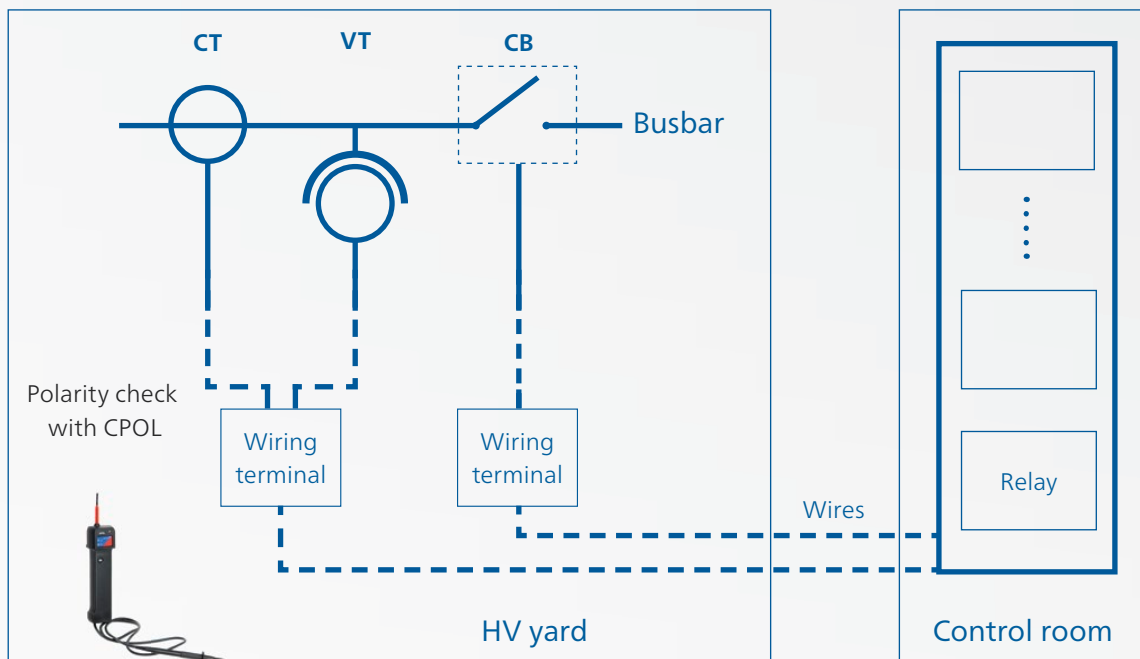

IEC 61850-9-2 Sampled Values testing

The standard for “Communication Networks and Systems for Power Utility Automation”, IEC 61850, utilizes network technologies for all types of information exchange.

Within IEC 61850, protocols for the transmission of instantaneous voltage and current values are specified. The sensors used in the transmission process can be conventional CTs and VTs as well as unconventional current and voltage sensors.

Sampled Values

A merging unit (MU) collects the measured current and voltage values from the current and voltage sensors. Then it merges the digitized values, which are called “Sampled Values” (SV), into a data stream published to the substation network.

Using this method, measured values (for example, the bus voltage for a busbar protection scheme) can easily be distributed to multiple bay devices.

Sampled Values testing with the CPC 100

The CPC 100 test system performs closed-loop testing whereby a test signal is injected on the primary side of the current / voltage sensors. The MU converts the sensor output into a SV stream which is published to the substation network. The CPC 100 then reads the data back from the network in order to perform a variety of different tests.

Automatic MU and channel detection is achieved by injecting a test signal with a specific wave form. An optimized and time-effective algorithm searches for the unique test pattern within all the available MUs on the network to identify the correct channel for testing.

The CPC 100’s SV test card operates according to the “Implementation Guideline for Digital Interface to Instrumental Transformers using IEC 61850-9-2” published by the UCA International User Group.



Sampled Values testing

- > SV CT ratio test and polarity check
up to 800 A or up to 2000 A, 5 kVA output power | with the CP CB2
- > SV VT ratio test and polarity check
up to 2 kV_{AC}
- > Automatic MU detection
- > Automatic voltage / current channel detection
- > Frequency selective voltage / current meter
- > Noise level measurement
- > Amplitude response of the signal processing chain
up to 800 A or up to 2 kV_{AC} | frequency from 15 Hz to 400 Hz

10 reasons to choose a CPC 100

Prepared for the future

10

- > Unconventional assets can be tested
(for example Rogowski coils, low power CTs)
- > Testing according to IEC 61850-9-2
(for example Sample Values testing, Merging Unit testing)
- > Future applications areas will be covered
by new developed accessories and software

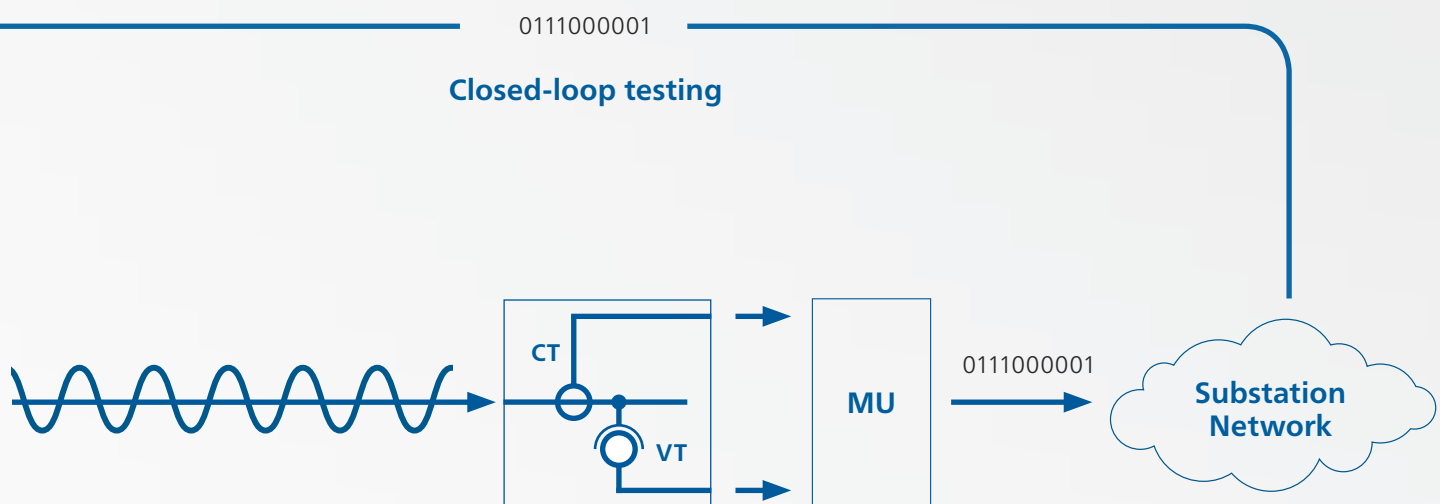

The CPC 100 injects a sinusoidal test signal to perform tests such as the ratio test. Additionally, the CPC 100 generates specific periodic wave shapes to identify the correct MU and corresponding test channel.

CTs, VTs and unconventional sensors

Operation of CPC 100: front panel

Different ways to operate

OMICRON's CPC 100 offers different operating modes, to meet the personal preferences of the user:

- > From the front panel: Selecting test cards directly
- > From the front panel: Using pre-defined test templates
- > Fully automated: Using Primary Test Manager™ (see next double page)

Operating from the front panel

1. Selecting test cards directly

Operating the CPC 100 manually provides the quickest results with minimal training and preparation – perfect for users who only operate the device occasionally. The user just selects the test card to be used, connects the CPC 100 to the asset and performs the test by pressing the green button.

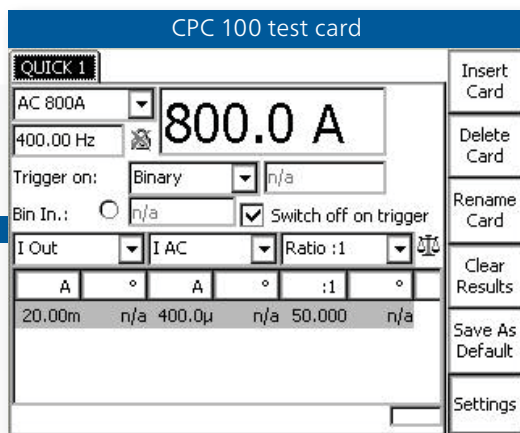

2. Using pre-defined test templates

Additionally, pre-defined test templates help the user to perform frequently used tests conveniently and efficiently. A number of test cards (for example, power / dissipation factor, winding resistance, ratio measurement, etc.) are combined into one test template. An example is the template containing all the recommended measurements for testing a current transformer.

The test template can be seen as a test plan. It tells the user which measurements to make and provides the basis for the overall test report.

Test templates can be prepared in advance in the office on the PC – without the CPC 100 connected – and can then be executed on site, step by step. Users can also create their own test templates and define, which test cards they want to include.

The settings and results of all manual tests can be stored on a flash memory and transferred to a PC using a USB memory stick or ethernet connection.

Customized reporting: Microsoft Excel™

After transferring the test results to a PC, report templates in numerical and graphical form are available.

The measurement data – including settings and results as well as administrative information such as date and time, filename, etc. – can also be imported to these templates for customized reporting, graphical result evaluation and further analyses.

Microsoft Excel™ reports provide the basis for client-specific reporting and allow test reports to be adapted to utility or manufacturer specific formats. Further content, such as company logos, can also be added.

Test reports can then be printed in a variety of languages.

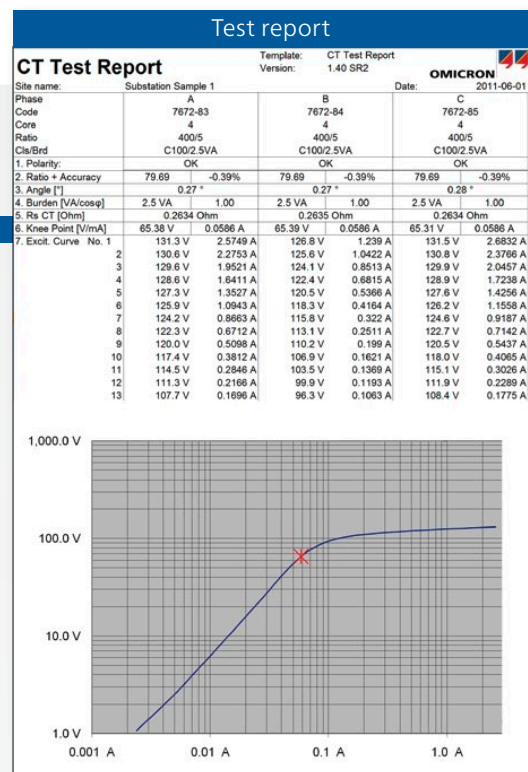
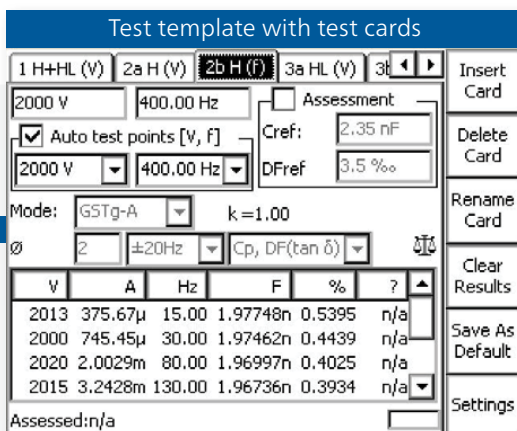

Operation of CPC 100: Primary Test Manager™

Primary Test Manager™ (PTM)

OMICRON's PTM software supports the user's workflow during diagnostic testing. The user can define and manage test objects, create test plans, perform measurements, and generate reports.

PTM manages the entire workflow during testing, guiding the user through the process step-by-step. Its main functions include:

1. Data management
2. Dynamic test plan generation
3. Guidance through test procedures
4. Comprehensive reporting

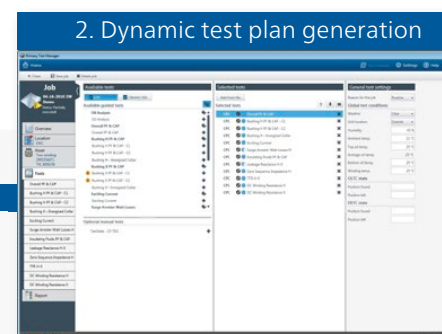
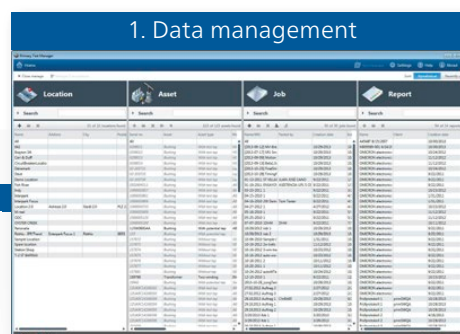
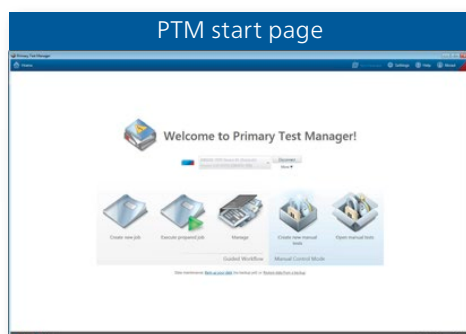

1. Data management

PTM facilitates the administration of the data of the asset to be tested. Its general data including the location, manufacturer, production date and serial number can be entered in addition to the electrical data which forms the basis for the dynamic generation of test procedures.

2. Dynamic test plan generation

Using the electrical data of the apparatus, PTM generates a plan of diagnostic measurements to be performed in accordance with industry standards, saving time and reducing the risk of errors.

3. Guidance through the testing procedure

During the measurement, the PTM allows the direct control of the test instrument from a PC or laptop. Clear wiring diagrams help to avoid errors when making the connections. At a glance, the user gets an overview of the progress of the test and the tasks remaining by following the execution of the steps in the test table. Additionally, test results can be compared and automatically assessed according to international standards and guidelines.

4. Comprehensive reporting

After the tests are completed, reports of any of the measurements made can be generated at any time. The content of the report is flexible – as components can be easily selected and de-selected by mouse-clicks. In addition a company logo, pictures and other tests results can be added.

3. Guidance through testing

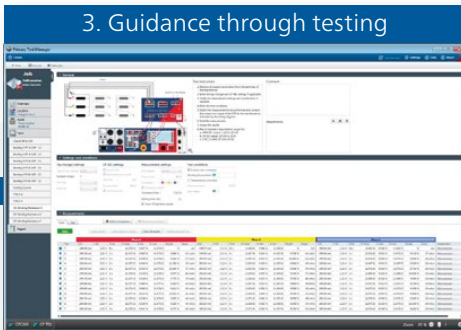

4. Comprehensive reporting

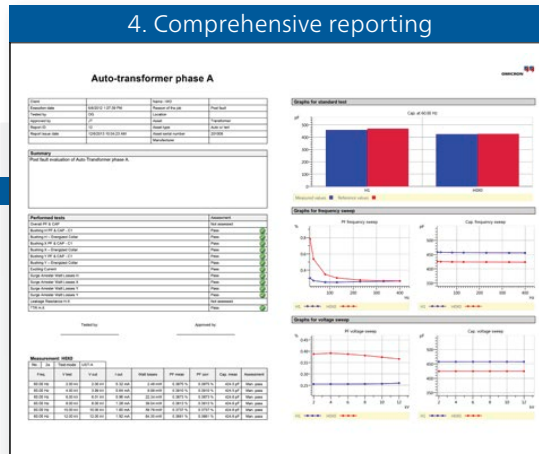

Front panel and connection possibilities



1. Grounding terminal
2. High AC voltage output 2 kV AC
3. External booster output
4. High DC current output 400 A DC
5. High AC current output 800 A AC
6. Mains power supply
7. Overcurrent protection
8. Power switch



9. 6 A or 130 V output
10. Current output 6 A DC
11. Current measuring input 10 A AC or DC
12. Voltage measuring input 300 V AC
13. Low level voltage measuring input 3 V AC
14. Voltage measuring input 10 V DC
15. Binary input for potential-free contacts or voltages up to 300 V DC
16. Safety key lock
17. Signal lights
18. Emergency stop button
19. Quick button



- 19. Keys for the quick selection of applications
- 20. Keys for the quick selection of the desired view
- 21. LCD monitor
- 22. Soft-touch keys which change their function according to the selected application
- 23. Keys for selecting stacked test cards
- 24. Numerical keyboard
- 25. Advanced jog-dial hand wheel with "click" (Enter) function
- 26. Up / down keys for navigation and entering values
- 27. Test start / stop button
- 28. User manual

- 29. Serial interface for devices such as CP TD1
- 30. Plug to connect external safety functions
- 31. Socket for the connection of the CPC 100 to a network or direct connection to a PC's network connector
- 32. USB memory stick connection

CPC 100 – Operating principle

Internal elements of the CPC 100

These key components make the CPC 100 outstanding:

- > Control unit
- > Power electronics unit
- > Multiple range transformer
- > Measurement unit
- > Interface

Each of the above is engineered to operate effectively in harsh electrical and environmental conditions associated with the testing of HV apparatus.

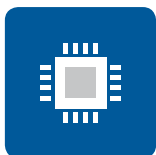
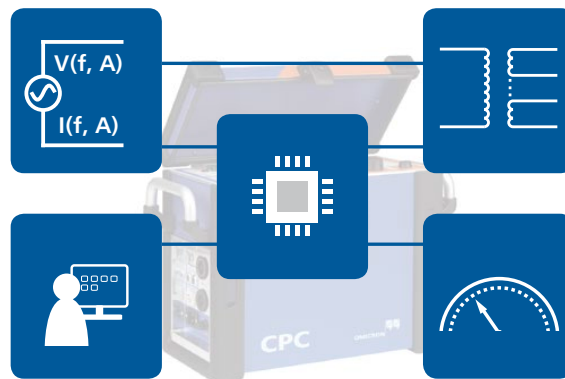

Control unit

The “brain” of the CPC 100 consists of two signal processing units and an embedded computer providing:

- > Application knowledge for all of the incorporated testing procedures
 - > Up-to-date, practical and efficient measurement functions
- > Digital test voltage or current generation
 - > Enables independence from the mains signal quality
 - > Enables independence from the mains frequency
 - > Assures a high level of reproducibility of measurements
- > Safety functions such as ground connection checks, self diagnostics, overload, overcurrent and overtemperature management
 - > Reduces the risks to the user and the test objects
 - > Prevents damage to the CPC 100 and its accessories
- > Data storage using onboard flash memory and external USB memory
 - > Saves time through its automatic storage and reporting functions

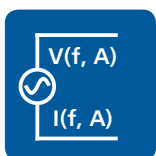

Power electronic unit

Adjustable and controlled voltage (or current) source with variable frequency

- > Supplied from a single phase wall outlet (110 V / 230 V, 50 Hz / 60 Hz)
 - > The CPC 100 can be used everywhere in the substation or power plant
- > DC intermediate circuit allows reactive power to be generated inside the unit
 - > As only active power is taken from the supply socket, less current has to be taken from the wall socket
 - > Longer injection times are possible
- > Generation of voltage or current with variable frequency
 - > Avoids mains frequency related noise
 - > Performs accurate measurements in noisy environments
 - > Tests apparatus with different frequency rating (for example, for factory tests in the supplier’s home country)
- > Generates different periodic wave shapes (sine wave, sawtooth, etc.)
 - > Performs special measurements (polarity verification, IEC 61850 merging unit and channel detection)

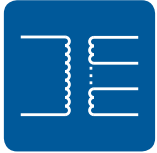

Multi-range transformer

- > Special multi-range 5 kVA transformer facilitates different test signal ranges
- > Multiple isolated and protected outputs for safe operation
 - > Avoids unwanted ground loops and makes measurements accurate and safe
- > Automatic measurement of test signals, which are difficult or dangerous to measure (for example, 2 kV high-voltage or 800 A high-current output) using internal measurement and regulation loops
 - > Delivers a constant output under variable test impedance conditions



Measurement unit

- > RMS and phase-angle measurements:
 - > Measures voltage, current, ratio, frequency, phase
 - > Verifies polarity (for example, on CTs and VTs)
 - > Calculates power (P, Q, S) and impedance (R, L, C, Z, X)
- > Frequency selective measurements (measuring signals at the same frequency as the CPC 100 source signals)
 - > Suppresses all disturbances, including mains frequency related noise
 - > Measures small signals in electromagnetically disturbed environments
- > Inputs are galvanically separated from each other
 - > Avoids the wrong measurement results due to unintended ground loops
- > All inputs are equipped with overvoltage and surges protection devices
 - > Avoids damage to the CPC 100
- > Connection of external sensors (CTs, VTs and current clamps) is supported by the CPC 100 software
- > Advanced measurement capabilities (for example, integral of a signal for measuring Rogowski coil CTs)



Interface

- > Easy and intuitive graphical user interface
 - > Efficient, time-saving testing
- > Different selectable language settings and test standards (for example, IEEE, IEC, etc.)
 - > Users from different countries can effectively use the device
 - > Reports can be generated in different languages
- > Wiring connections to be made are indicated by LEDs
 - > Quick wiring set-up
 - > Avoids wiring errors
- > Different operation modes: From the front panel with test cards or controlled by a PC
 - > Each user can operate the CPC 100 according to personal preferences

Technical data CPC 100

CPC 100

Generator / Outputs

Current outputs

Range	Amplitude	t_{\max}^1	V_{\max}^2	Power_{\max}^2	f
800 A AC ³	0 ... 800 A	25 s	6.0 V	4800 VA	15 Hz ... 400 Hz
	0 ... 400 A	8 min.	6.4 V	2560 VA	15 Hz ... 400 Hz
	0 ... 200 A	> 2 h	6.5 V	1300 VA	15 Hz ... 400 Hz
6 A AC ¹⁰	0 ... 6 A	> 2 h	55 V	330 VA	15 Hz ... 400 Hz
3 A AC ¹⁰	0 ... 3 A	> 2 h	110 V	330 VA	15 Hz ... 400 Hz
400 A DC	0 ... 400 A	2 min.	6.5 V	2600 VA	DC
	0 ... 300 A	3 min.	6.5 V	1950 VA	DC
	0 ... 200 A	> 2 h	6.5 V	1300 VA	DC
6 A DC ^{4,10}	0 ... 6 A	> 2 h	60 V	360 VA	DC

2000 A AC³ with an optional current booster (CP CB2)

Voltage outputs

Range	Amplitude ⁵	t_{\max}	I_{\max}	Power_{\max}^5	f
2 kV AC ³	0 ... 2 kV	1 min.	1.25 A	2500 VA	15 Hz ... 400 Hz
	0 ... 2 kV	> 2 h	0.5 A	1000 VA	15 Hz ... 400 Hz
1 kV AC ³	0 ... 1 kV	1 min.	2.5 A	2500 VA	15 Hz ... 400 Hz
	0 ... 1 kV	> 2 h	1.0 A	1000 VA	15 Hz ... 400 Hz
500 V AC ³	0 ... 500 V	1 min.	5.0 A	2500 VA	15 Hz ... 400 Hz
	0 ... 500 V	> 2 h	2.0 A	1000 VA	15 Hz ... 400 Hz
130 V AC ¹⁰	0 ... 130 V	> 2 h	3.0 A	390 VA	15 Hz ... 400 Hz

Internal measurement of outputs (Accuracy⁶)

Output	Range	Amplitude Reading Error	Amplitude Full scale Error	Phase Full scale Error
800 A AC	–	< 0.10 %	< 0.10 %	< 0.10°
400 A DC	–	< 0.20 %	< 0.05 %	–
2 kV AC	2000 V	< 0.05 %	< 0.05 %	< 0.10°
	1000 V	< 0.05 %	< 0.05 %	< 0.15°
500 V	500 V	< 0.05 %	< 0.05 %	< 0.20°
5 A	5 A	< 0.20 %	< 0.05 %	< 0.10°
500 mA	500 mA	< 0.05 %	< 0.05 %	< 0.10°

Inputs

Measuring inputs (Accuracy⁶)

Input	Imped.	Range	Amplitude Reading Error	Amplitude Full scale Error	Phase Full scale Error
I AC / DC ^{4,7}	< 0.1 Ω	10 A AC	< 0.05 %	< 0.05 %	< 0.10°
		1 A AC	< 0.05 %	< 0.05 %	< 0.15°
		10 A DC	< 0.03 %	< 0.08 %	–
V1 AC ⁸	500 k Ω	300 V	< 0.05 %	< 0.05 %	< 0.10°
		30 V	< 0.05 %	< 0.05 %	< 0.10°
		3 V	< 0.10 %	< 0.05 %	< 0.10°
V2 AC ^{8,11}	10 M Ω	300 mV	< 0.15 %	< 0.05 %	< 0.10°
		30 mV	< 0.10 %	< 0.25 %	< 0.15°
		3 mV	< 0.10 %	< 0.25 %	< 0.15°
V DC ^{4,7}		10 V	< 0.03 %	< 0.08 %	–
		1 V	< 0.03 %	< 0.08 %	–
		100 mV	< 0.05 %	< 0.10 %	–
		10 mV	< 0.05 %	< 0.15 %	–

Additional features of the measuring inputs

Automatic range switching (except Amplifier test card)
Galvanically separated potential groups: I AC/DC ; V1 & V2 ; V DC
AC frequency range: 15 Hz to 400 Hz (except Amplifier test card)
Protection of I AC/DC input: 10 A very fast acting (FF) fuse⁴

Binary input for dry contacts or voltages up to 300 V DC⁷

Trigger criteria: Toggling with potential-free contacts or voltages of up to 300 V
Input impedance: > 100 k Ω
Response time: 1 ms

Output to input synchronization

	Test cards Quick, Sequencer, Ramping	Amplifier test card
Frequency range	48 Hz ... 62 Hz	48 Hz ... 62 Hz
Synchronization inputs	V1 AC (automatic range switch)	V1 AC, V2 AC, I AC (fixed to maximum range)
Input magnitude	10 % of input range full scale	
Output magnitude	5 % of output range full scale	
Settling time	100 ms after 5 % of output range full scale is reached	1000 ms after 5 % of output range full scale is reached
Signal changes	All quantities must be ramped within 20 signal periods	No changes of frequency and phase. Magnitude changes without limitation. Output follows within 250 ms
Phase tolerance	0.5 ° within the limits as specified above	



Resistance measurement

4-wire measurement with 400 A DC output and 10 V DC input

Current	Resistance	Voltage	Accuracy (full scale)
400 A	10 $\mu\Omega$	4 mV	Error < 0.70 %
400 A	100 $\mu\Omega$	40 mV	Error < 0.55 %
400 A	1 m Ω	400 mV	Error < 0.50 %
400 A	10 m Ω	4 V	Error < 0.50 %

4-wire measurement with 6 A DC output and 10 V VDC input

Current	Resistance	Voltage	Accuracy (full scale)
6 A	100 m Ω	0.6 V	Error < 0.35 %
6 A	1 Ω	6 V	Error < 0.35 %
1 A	10 Ω	10 V	Error < 0.25 %

2-wire measurement with 10 V VDC input

Current	Resistance	Voltage	Accuracy (full scale)
> 5 mA	100 Ω		Error < 0.60 %
> 5 mA	1 k Ω		Error < 0.51 %
> 5 mA	10 k Ω		Error < 0.50 %

Power supply and mechanical data

Single-phase, nominal ⁹	100 V _{AC} ... 240 V _{AC} , 16 A
Single-phase, permissible	85 V _{AC} ... 264 V _{AC} (L-N or L-L)
Frequency, nominal	50 Hz / 60 Hz
Power consumption	< 3500 VA (< 7000 VA for a time < 10 s)
Connection	IEC 320 / C20
Weight	29 kg / 64 lbs (case without protection cover)
Dimensions (W x H x D)	468 x 394 x 233 mm (18.4 x 15.5 x 9.2 in), cover, without handles.
EMC	EN 61326-1 Class A, IEC 61326-1 Class A, FCC Subpart B of Part 15 Class A, CE conform (2004 / 108 / EC)
Safety	EN 61010-1, IEC 61010-1, UL 61010-1, CE conform (2006 / 95 / EC)
Shock	IEC / EN 60068-2-27, 15 g / 11 ms, half-sinusoid, each axis
Vibration	IEC / EN 60068-2-6, frequency range from 10 Hz to 150 Hz, continuous acceleration 2 g (20 m/s ² / 65 ft/s ²), 10 cycles per axis

Environmental conditions for CPC 100 and CPC 100 accessories

Operating temperature	-10 °C ... +55 °C / +14 °F ... +131 °F
Storage temperature	-20 °C ... +70 °C / -4 °F ... +158 °F
Humidity range	5 % ... 95 % relative humidity, no condensation

All input / output values are guaranteed for one year within an ambient temperature of 23 °C ± 5 °C / 73 °F ± 10 °F, a warm-up time longer than 25 min. and in a frequency range of 45 Hz to 60 Hz or DC. Accuracy values indicate that the error is smaller than ± (value read x reading error + full scale of the range x full scale error).

1. With a mains voltage of 230 V using a 2 x 6 m high-current cable at an ambient temperature of 23 °C ± 5 °C / 73 °F ± 10 °F.
2. The power and maximum voltage may be reduced above 60 Hz or below 50 Hz.
3. Output can be synchronized with V1 AC in Quick, Sequencer, Ramping and Amplifier test cards.
4. The inputs and outputs are protected with lightning arrestors between the connector and against the protective earth. In the event of application of energy exceeding a few hundred Joule the lightning arrestors apply a permanent short-circuit to the input / output.
5. The power and amplitude may be reduced above 200 Hz or below 50 Hz.
6. 98 % of all units have an accuracy better than specified as "typical".
7. This input is galvanically separated from all other inputs.
8. V1 and V2 are galvanically coupled but separated from all other inputs.
9. There are power restrictions for mains voltages below 190 V_{AC}.
10. Fuse-protected.
11. When using the CTRogowski test card, the 3 V V2 AC input uses an additional software based integration method. In the range of 50 Hz < f < 60 Hz, this results in a phase shift of 90 ° as well as an additional phase error of ± 0.1 ° and an additional amplitude error of ± 0.01 %. For frequencies in the range of 15 Hz < f < 400 Hz, the phase error is not specified, and the amplitude error can be up to ± 0.50 % higher.

Technical data CPC 100 accessories

CP TD1 – Tan-delta unit



High-voltage output

U/f	I	S	t _{max}	f
0 ... 12 kV AC	300 mA	3 600 VA	> 2 min.	15 Hz ... 400 Hz
0 ... 12 kV AC	100 mA	1 200 VA	> 60 min.	15 Hz ... 400 Hz

Internal measurement of voltage output / current inputs

Range	Resolution	Accuracy	Conditions
0 ... 12 000 V _{AC}	1 V	Error < 0.3 % of reading + 1 V	
0 ... 5 A _{AC}	5 digits	Error < 0.3 % of reading + 100 nA	I _x < 8 mA
	5 digits	Error < 0.5 % of reading	I _x > 8 mA

Capacitance Cp (equivalent parallel circuit)

Range	Resolution	Accuracy	Conditions
1 pF ... 3 μF	6 digits	Error < 0.05 % of reading + 0.1 pF	I _x < 8 mA, V _{test} = 300 V ... 10 kV
1 pF ... 3 μF	6 digits	Error < 0.2 % of reading	I _x > 8 mA, V _{test} = 300 V ... 10 kV

Power factor PF / dissipation factor DF

Range	Resolution	Accuracy	Conditions
0 ... 10 % (capacitive)	5 digits	Error < 0.1 % of reading + 0.005 %	f = 45 Hz ... 70 Hz, I < 8 mA, V _{test} = 300 V ... 10 kV
0 ... 100 % (PF) 0 ... 10 000 % (DF)	5 digits	Error < 0.5 % of reading + 0.02 %	V _{test} = 300 V ... 10 kV

Impedance

Range	Resolution	Accuracy	Conditions
1 kΩ ... 1,200 MΩ	6 digits	Error < 0.5 % of reading	V _{test} = 300 V ... 10 kV

Phase angle

Range	Resolution	Accuracy	Conditions
-90° ... +90°	4 digits	Error < 0.01 °	V _{test} = 300 V ... 10 kV

Quality factor

Range	Resolution	Accuracy
0 ... 1 000	5 digits	Error < 0.5 % of reading + 0.2 %
> 1 000	5 digits	Error < 5 % of reading

Inductance

Range	Resolution	Accuracy
1 H ... 1 000 kH	6 digits	Error < 0.3 % of reading

Watts / power (P, Q, S)

Range	Resolution	Accuracy
0 ... 3.6 kVA	5 digits	Error < 0.5 % reading + 1 mVA
0 ... 3.6 kW/kVA _r	6 digits	Error < 0.5 % reading + 1 mW / mVA _r

Mechanical data

Dimensions (W x H x D)	450 x 330 x 220 mm / 17.7 x 13 x 8.7 in
Weight	25 kg / 55.2 lbs

CP CU1 – Coupling unit



Output ranges

Range	Current	Compliance voltage at > 45 Hz
10 A	0 ... 10 A _{rms}	500 V _{rms}
20 A	0 ... 20 A _{rms}	250 V _{rms}
50 A	0 ... 50 A _{rms}	100 V _{rms}
100 A	0 ... 100 A _{rms}	50 V _{rms}

Measuring transformers

Transformer	Ratio	Accuracy at 50 Hz / 60 Hz
VT	600 V : 30 V	Class 0.1
CT	100 A : 2.5 A	Class 0.1

Inputs

	Characteristic	Rating
V SENSE	Overvoltage category Voltage range	CAT III (IEC 61010-1) 0 ... 600 V _{rms}
BOOSTER	Overvoltage category Voltage range Current range Frequency range Fuse	CAT I 0 ... 200 V _{rms} 0 ... 30 A _{rms} 15 Hz ... 400 Hz 30 A fast acting, automatic circuit breaker

Output power

Characteristic	Rating
Maximum power	5 000 VA (45 Hz ... 70 Hz), cos φ < 1.0 for 8 s at 230 V _{AC} 5 000 VA (45 Hz ... 70 Hz), cos φ < 0.4 for 8 s at 115 V _{AC}
Continuous power	0 ... 1 600 VA

Accuracy

Range	Accuracy of absolute value	Accuracy of phase angle	V SENSE voltage	I OUT current	Current range
0.05 ... 0.2 Ω	1.0 ... 0.5 %	1.5 ... 0.8°	5 ... 20 V	100 A	100 A
0.2 ... 2 Ω	0.5 ... 0.3 %	0.8 ... 0.5°	20 ... 50 V	100 ... 25 A	100 A
2 ... 5 Ω	0.3 %	0.5°	100 V	50 ... 20 A	50 A
5 ... 25 Ω	0.3 %	0.5°	100 ... 250 V	20 ... 10 A	20 A
25 ... 300 Ω	0.3 ... 1.0 %	0.5 ... 1.5°	250 ... 500 V	10 ... 1,5 A	10 A

Mechanical data

Dimensions (W x H x D)	450 x 220 x 220 mm / 17.7 x 8.7 x 8.7 in
Weight	28.5 kg / 62.78 lbs

CP CB2 – Current booster



Output current	up to 2 000 A
Output power at 2 000 A	5 kVA
Accuracy of current at 50 Hz / 60 Hz	Error < ± 0.13 % (rd) ± 0.13 % (fs)
Phase tolerance at full scale	Error < ± 0.25 %
Dimensions (W x H x D)	186 x 166 x 220 mm / 7.3 x 6.5 x 8.7 in
Weight	16.0 kg / 35.3 lbs

CP DB1 – Discharge box



6 A path	Switch closed	6 A continuous
	Switch open	The discharge process is faster by a factor of 4 compared to the CPC 100 6 A _{peak} Overtemperature protection: 85 °C / 185 °F Overvoltage protection: 150 V / 5 kA between connectors
100 A path	Switch closed	100 A continuous
	Switch open	The discharge process is faster by a factor of 10 compared to the CPC 100 100 A _{peak} 2500 J _{max} Overvoltage protection: 200 V / 30 kA between connectors
Mechanical data		
Dimensions (W × H × D)	357 × 235 × 147 mm / 14.0 × 9.2 × 5.8 in	
Weight	4 kg / 8.8 lbs	

CP SB1 – Switch box



AC input / V1 AC output	Max. 300 V _{rms}
DC input	Max. 6 A _{DC}
Transformer high and low voltage connections	Max. 300 V _{rms} between all connectors and ground
Supply	Via serial interface from CPC 100 (+15 V)
Dimensions (W × H × D)	357 × 235 × 111 mm / 14.1 × 9.2 × 4.4 in
Weight	3.5 kg / 7.7 lbs

CP TC12 – 12 kV oil test cell



Cell type	Three-electrode design with guard
Test gap	11 mm / 0.43 in
Capacitance of empty cell (air)	Approx. 65 pF ± 10 %
Sample volume	1.2 liters ... 2 liters / 41 ... 68 fl.oz.
Max. RMS test voltage	12 kV
Inner dimensions (diameter × height)	172 mm x 180.8 mm / 6.8 x 7.1 in
Outer dimensions (W × H × D)	220 × 235.5 × 220 mm / 8.7 × 9.3 × 8.7 in
Weight	Approx. 9.2 kg / 20 lbs

CPOL – Polarity checker



Measuring range	Typical: 5 mV ... 300 V Guaranteed: 50 mV ... 300 V
Nominal frequency	Typical: 52.6 Hz, Possible: 40 Hz ... 60 Hz
Minimum slope ratio	25 % ... 90 % or via pulse width
Power consumption	Key pressed: 25 mA Key not pressed: 0 mA
Input impedance	400 kΩ
Batteries	4 × 1,5 V Micro LR03 AAA AM4 MN2400
Dimensions (W × H × D)	200 × 45 × 35 mm / 78.7 × 17.7 × 13.8 in
Weight	0.25 kg / 0.11 lb including batteries and bag

CP CR500 – Compensation reactor



Inductors	2 × 40 H	2 × 80 H	1 × 40 H and 1 × 80 H
Current compensation			
50 Hz	2 × 1 A	2 × 0.5 A	1 × 1 A + 1 × 0.5 A
60 Hz	2 × 0.8 A	2 × 0.4 A	1 × 0.8 A + 1 × 0.4 A
Capacitance compensation			
50 Hz	2 × 250 nF	2 × 125 nF	1 × 250 nF + 1 × 125 nF
60 Hz	2 × 180 nF	2 × 90 nF	1 × 180 nF + 1 × 90 nF
On/off times at 25 °C			
0.5 A	on/off times: 6 min/6 min	on/off times: 6 min/6 min	on/off times: 6 min/6 min
1 A	on/off times: 2 min/6 min	-	on/off times: 2 min/6 min
Maximum test voltage	12 kV _{rms} (≥ 50 Hz)		
Dimensions (W × H × D)	455 × 275 × 220 mm / 17.9 × 10.8 × 8.7 in		
Weight	36 kg / 79.4 lbs		

HGT1 – Handheld grounding tester



Voltage input	Max. 25 V _{rms}
Power supply	1 × 3.7 V lithium polymer (Li-Po) battery
Dimensions (W × H × D)	90 × 180 × 45 mm / 3.5 × 7.1 × 1.8 in
Weight (including battery)	0.48 kg / 1 lb

CP GB1 – Grounding box



Nominal ac spark-over voltage	< 1000 V _{rms}
Impulse spark-over voltage	< 2000 V _{peak}
Short circuit proof with:	
16 mm cylindrical or 20 mm ball studs	26.5 kA (< 100 ms) / 67 kA _{peak}
25 mm ball studs	30 kA (< 100 ms) / 75 kA _{peak}
Torsional moment for changing arrestors	> 15 Nm
Dimensions (Ø × H)	200 × 190 mm / 7.9 × 7.5 in
Weight	6.8 kg / 13.2 lbs (including grounding cable)

CP RC – Compensating reactor



	CP TR7 / CP TR8	CP CR4 / CP CR6	CP AT1
Voltage output	180 V ¹ / 220 V	220 V	254 V - 278 V
Current output	60 A	150 A	16 A
Apparent power on secondary side	13.2 kVA _r	33 kVA _r	4.4 kVA _r
Frequency	80 Hz ... 120 Hz	80 Hz ... 120 Hz	50 Hz / 60 Hz
Insulation class	F	F	F
Weight	19 kg / 42 lbs	20.5 kg / 45 lbs	15.5 kg / 34 lbs
Dimensions (W × H × D)	262 × 277.5 × 222 mm / 10.31 × 10.9 × 8.74 in		

¹ CP TR7

Ordering information

CPC 100 Standard Package (order no. VE000611)

Hardware

1 × CPC 100

Software

1 × CP Quick card

1 × CP CT test cards

1 × CP VT test cards

1 × CP transformer test cards

1 × CP resistance test cards

1 × CPC editor software

Cables and accessories

1 × CPC 100 user manual

1 × Set of 2 standard high-current cables (6 m / 19.68 ft) or optional 1 × set of 2 high-current cables (9 m / 29.53 ft)

1 × Set of 2 standard high-voltage cables (2000 V, 6 m / 19.68 ft) or optional 1 × set of 2 high-voltage cables (2000 V, 10 m / 32.81 ft)

1 × Set of 6 standard measurement cables (6 m / 19.68 ft) or optional 1 × set of 6 measurement cables (10 m / 32.81 ft)

1 × Grounding cable (green / yellow) (6 m / 19.68 ft, 6 mm²)

1 × Ethernet PC connection cable (3 m / 9.84 ft)

1 × Transport case with wheels for CPC 100

1 × Carry bag for CPC 100 accessories

1 × Set of 4 connection clamps for high voltage

1 × Low voltage adapter

1 × Power cord CPC

1 × CP SA1 Surge Arrestor box

1 × USB memory stick

1 × Set of 4 crocodile clamps

1 × CPC Toolset DVD
(including 30-days trial licence for PTM Advanced)



CPC 100 Standard Package (order no. VE000611)

CPC 100 Enhanced Package (order no. VE000621)

CPC 100 Standard Package plus:

Software

1 × CP sequencer test card

1 × CP ramping test card

1 × CP GR – ground resistance test option includes testing software and hardware accessory (VEHZ0660)

1 × CPOL software and hardware accessory (VEHZ0650)

CP TD1 Upgrade Option (order no. VE000641)

Hardware

1 × CP TD1

Cables and accessories

1 × CP TD1 accessories set

1 × Set of 4 crocodile clamps

1 × Set of 12 solid terminal adapters

1 × Grounding cable (green / yellow) (6 m / 19.68 ft, 6 mm²)

1 × Transport case with wheels for CP TD1 accessories set

2 × Hot collar band

1 × Transport case with wheels for CP TD1

1 × CP TD1 reference manual

1 × CP Trolley

1 × CPC Toolset DVD (including 30-days trial licence for PTM Advanced)

CP CU1 and CP GB1 Upgrade Option (order no. VEHZ0671)

Hardware

1 × CP CU1

1 × CP GB1

Cables and accessories

1 × 3-lead shorting cable (0.3 m / 11.81 in, 10 mm²)

1 × CP CU1 reference manual

1 × Set of 3 CP GB1 surge arrestors

1 × Short circuiting bar (4 mm / 0.16 in, 19 mm / 0.75 in)

1 × Booster connection cable (6 m / 19.68 ft, 3 × 1.5 mm²)

1 × Coax measurement cable (6 m / 19.68 ft)

1 × Set of 2 cables with Kelvin clamps (6 m / 19.68 ft, 6 mm²)

1 × Grounding cable (green / yellow) (6 m / 19.68 ft, 6 mm²)

1 × Transport case CP CU1

1 × CPC Toolset DVD (including 30-days trial licence for PTM Advanced)

CP sequencer test card has to be ordered separately (order no. VESM0635)

CP SB1 Upgrade Option (order no. VEHZ0692)

Hardware

1 × CP SB1

Cables and accessories

1 × RS232 cable

1 × Grounding cable (green / yellow) (6 m / 19.68 ft, 6 mm²)

1 × Set of 10 coaxial cables (15 m / 49.21 ft, 2,5 mm²) on cable drum (3 × red, 3 × blue, 2 × green, 2 × yellow)

4 × Set of 2 Kelvin clamps

1 × Transport case with wheels for CP SB1

1 × Set of 12 flexible terminal adapters

1 × CPC Toolset DVD (including 30-days trial licence for PTM Advanced)

Additional accessories: CP SB1 user manual, connection cables, backpack for accessories

For transformer demagnetization the CP Demag test card has to be ordered separately (order no. VESM0639)

Ordering information

CP Transformer Test System (order no. VE000645)

Hardware

- 1 × CPC 100
- 1 × CP TD1

Software

- 1 × CP Quick card
- 1 × CP transformer test cards
- 1 × CP sequencer test card
- 1 × CPC editor software

Cables and accessories

- 1 × Set of 2 high-current cables (9 m / 29.53 ft)
- 1 × Set of 2 high-voltage cables (2000 V, 10 m / 32.81 ft)
- 1 × Set of 6 measurement cables (10 m / 32.81 ft)
- 1 × Set of 4 connection clamps for high voltage
- 1 × Set of 4 crocodile clamps
- 1 × Ethernet PC connection cable (3 m / 9.84 ft)
- 1 × Low voltage adapter
- 1 × CP TD1 accessories set
- 1 × Set of 12 solid terminal adapters
- 1 × Transport case with wheels for CP TD1
- 1 × CP TD1 reference manual
- 1 × CPC 100 user manual
- 2 × Grounding cable (green / yellow) (6 m / 19.68 ft, 6 mm²)
- 1 × Transport case with wheels for CPC 100
- 1 × Carry bag for CPC 100 accessories
- 1 × TH3631 temperature/humidity measurement unit
- 1 × CPC Toolset DVD (including 30-days trial licence for PTM Advanced)
- 1 × Transport case with wheels for CP TD1 accessories set
- 1 × CP SA1 surge arrester box
- 1 × Power cord CPC
- 1 × USB memory stick
- 2 × Hot collar band
- 1 × CP trolley



CP Transformer Test System (order no. VE000645)

CPC 100 Line Impedance Test System (order no. VE000602)

Hardware

- 1 × CPC 100
- 1 × CP CU1
- 1 × CP GB1

Software

- 1 × CP Quick card
- 1 × CP sequencer test card
- 1 × CPC editor software

Cables and accessories

- 1 × Ethernet PC connection cable (3 m / 9.84 ft)
- 1 × Transport case with wheels for CPC 100
- 2 × Grounding cable (green / yellow) (6 m / 19.68 ft, 6 mm²)
- 1 × CPC 100 user manual
- 1 × USB memory stick
- 1 × 3-lead shorting cable (0.3 m / 11.81 in, 10 mm²)
- 1 × CP CU1 reference manual
- 1 × Set of 3 CP GB1 surge arrestors
- 1 × Short circuiting bar (4 mm / 0.16 in, 19 mm / 0.75 in)
- 1 × Booster connection cable (6 m / 19.68 ft, 3 × 1.5 mm²)
- 1 × Transport case for CP CU1
- 1 × Set of 2 cables with Kelvin clamps (6 m / 19.68 ft, 6 mm²)
- 1 × Coax measurement cable (6 m / 19.68 ft)
- 1 × CPC Toolset DVD (including 30-days trial licence for PTM Advanced)



CPC 100 Line Impedance Test System (order no. VE000602)

The cables for the high current (800 AAC / 400 ADC) and for the high-voltage (2000 V) outputs are not included in the package. You can order them separately.

Step & Touch Voltage Set for CP CU1 (order no. VEHZ0625)

Hardware

- 1 × Handheld grounding tester HGT1 including accessories

Cables and accessories

- 2 × Foot electrode water cans
(empty: 6 kg / 13.2 lbs each; filled: > 25 kg / 55.1 lbs each)
- 1 × Ground electrode
- 1 × CPC Toolset DVD (including 30-days trial licence for PTM Advanced)

Ground Impedance Set for CP CU1 (order no. VEHZ0622)

Hardware











- 1 × Rogowski coil with a length of 1.90 m / 75 in – 20 / 200 A ranges
- 1 × Handheld eTrexH GPS navigation device for evaluation of distance

Cables and accessories

- 6 × Cable reels (100 m / 328.08 ft, 0.75 mm², black)
- 3 × Ground electrode

Ordering information

Hardware

Order no.	Product	Description	CPC 100 Standard Package	CPC 100 Enhanced Package	Transformer Test System	Line Impedance Test System	CPC 100 TD/PF Test System ¹	CP TD1 Upgrade Option	CP CU1 Upgrade Option	CP SB1 Upgrade Option
	CPC 100	<ul style="list-style-type: none"> > Multi-functional primary test system CPC 100 > Quick test card (manual control of the test set) > Software and accessories according to CPC package overview > CPC Toolset DVD (including 30-days trial license for PTM Advanced) 	■	■	■	■	■	-	-	-
	VE000641 CP TD1 Upgrade Option	<ul style="list-style-type: none"> > CP TD1 capacitance and tan δ test unit > CP TD1 connectors and cables for HV injection (20 m / 65.62 ft) > Foldable trolley with cable drum mountings > CP TD1 reference manual 	-	-	■	-	■	■	-	-
	VEHZ0642 CP CAL1	<ul style="list-style-type: none"> > Calibration box to verify / calibrate any CP TD1 in the field 	-	-	-	-	-	-	-	-
	VEHZ0601 CP TC12	<ul style="list-style-type: none"> > 12 kV oil test cell for measuring permittivity and tan delta (power factor) of insulation liquids 	-	-	-	-	-	-	-	-
	VEHZ0692 CP SB1 switch box	<ul style="list-style-type: none"> > CP SB1 for automated turns ratio and dynamic and static resistance measurement of 3-phase transformers > Manual, transport case, cables set and connection clamps 	-	-	-	-	-	-	-	■
	VEHZ0695 CP DB1 discharge box	<ul style="list-style-type: none"> > CP DB1 discharge box to speed up the discharge process of a power transformer 	-	-	-	-	-	-	-	-
	VEHZ0602 CP CR500 (2 x 40 H)	<ul style="list-style-type: none"> > Compensating reactor > Transport case and cable set 	-	-	-	-	-	-	-	-
	VEHZ0604 CP CR500 (2 x 80 H)		-	-	-	-	-	-	-	-
	VEHZ0605 CP CR500 (1 x 40 H, 1 x 80 H)		-	-	-	-	-	-	-	-
	VEHZ0630 CP CB2 current booster	<ul style="list-style-type: none"> > Current booster to increase output current range to 2000 A 	-	-	-	-	-	-	-	-

Order no.	Product	Description	CPC 100 Standard Package	CPC 100 Enhanced Package	Transformer Test System	Line Impedance Test System	CPC 100 TD/PF Test System ¹	CP TD1 Upgrade Option	CP CU1 Upgrade Option	CP SB1 Upgrade Option
 VEHZ0671	CP CU1 + CP GB1 including accessories	<ul style="list-style-type: none"> > CP CU1 coupling unit to make k-factor, cable and ground impedance measurements > CP GB1 grounding box for additional isolation and protection > Kelvin clamps, CP CU1 reference manual, transport case and standard cables for connection and measurement 	-	-	-	■	-	-	■	-
 VEHZ0672	CP GB1 with accessories	<ul style="list-style-type: none"> > CP GB1 grounding box > Surge arrestors, grounding studs, grounding socket clamp and grounding cable (2 m / 6.56 ft, 95 mm²) 	-	-	-	-	-	-	-	-
 VEHZ0629	HGT1	<ul style="list-style-type: none"> > HGT1 handheld grounding tester > Standard cables for connection and measurement > User manual 	-	-	-	-	-	-	-	-
 VEHZ0760	CP RC1 resonance circuit	<ul style="list-style-type: none"> > Set to create high-voltage on capacitive loads by means of a power VT: > 1 × CP TR8 isolation transformer > 1 × CP CR4 compensation reactor > 1 × CP CR6 compensation reactor > HV resonance test system test card > Manual, transport case, cable set and terminal adapters 	-	-	-	-	-	-	-	-
 VEHZ0770	CP RC2 resonance circuit	<ul style="list-style-type: none"> > Set to create high-voltage on capacitive loads by means of a power VT: > 1 × CP AT1 auto-transformer > 1 × CP TR7 isolating transformer > 3 × CP CR6 compensation reactor > HV resonance test system test card > Manual, transport case, cable set and terminal adapters 	-	-	-	-	-	-	-	-
 VEHZ0650	CPOL polarity tester hardware	<ul style="list-style-type: none"> > Polarity tester hardware > Bag and batteries (4 × AAA) 	-	■	-	-	-	-	-	-

■ included – not included ¹ Order no. VE000640

Ordering information

Software, cables and accessories

Order no.	Product	Description	CPC 100 Standard Package	CPC 100 Enhanced Package	Transformer Test System	Line Impedance Test System	CPC 100 TD/PF Test System ¹	CP TD1 Upgrade Option	CP CU1 Upgrade Option	CP SB1 Upgrade Option
VESM0600	CP Quick card	Quick test card	■	■	■	■	■	-	-	-
VESM0610	CP CT test cards	Test cards: ratio (V), ratio (I), excitation curve, burden, winding resistance, voltage withstand test (2 kV), Rogowski coils, low power CTs	■	■	-	-	-	-	-	-
VESM0615	CP VT test cards	Test cards: ratio, burden, voltage withstand test (2 kV), electronic voltage transformers	■	■	-	-	-	-	-	-
VESM0620	CP transformer test cards	Test cards: winding resistance, tap changer check, ratio, voltage withstand test (2 kV), vector group check	■	■	■	-	-	-	-	-
VESM0639	CP Demag test card	Test card for demagnetization of a power transformer by using the CP SB1	-	-	-	-	-	-	-	-
VESM0625	CP resistance test cards	Test cards: contact resistance ($\mu\Omega$ – $m\Omega$), winding resistance ($\mu\Omega$ – $k\Omega$)	■	■	-	-	-	-	-	-
VESM0630	CP ramping test card	Programmable ramping generator and determination of thresholds	-	■	-	-	-	-	-	-
VESM0635	CP sequencer test card	Sequencer test card for testing with different states	-	■	■	■	-	-	-	-
VESM0640	CP GR	Ground resistance test option: includes testing software and hardware accessory (VEHZ0660)	-	■	-	-	-	-	-	-
VESM0645	CPOL	Polarity checking for CT / VT wiring including software and hardware accessory set (VEHZ0650)	-	■	-	-	-	-	-	-
VESM0660	CP amplifier test card	Test module to use the CPC 100 like an amplifier	-	-	-	-	-	-	-	-
VESM0670	CPC editor software	CPC editor software	■	■	■	■	■	-	-	-
VESM0637	CP SV-Ratio test card	CP SV-Ratio test card to test IEC 61850-9-2 Sampled Values CTs and VTs	-	-	-	-	-	-	-	-
VESM0636	CP 12kV High Voltage test card	Test card with the CP TD1 as high-voltage source either independently or together with the CP CR500	-	-	-	-	-	-	-	-
VESM0638	HV resonance test system test card	Testcard for generation of high voltage by means of resonance circuit	-	-	-	-	-	-	-	-
VESM0671	PTM Advanced software	PTM Advanced software	-	-	-	-	-	-	-	-
Cables and accessories										
VEHK0610	High-current cable set for CP CB2	2 × 1.5 m / 4.92 ft, 95 mm ² (black), 2 × 1.5 m / 4.92 ft, 95 mm ² (red), 1 × 0.6 m / 1.97 ft, 95 mm ²	-	-	-	-	-	-	-	-
VEHK0611	Connection cable to CPC 100 for CP CB2 / CU1	20 m / 65.62 ft, 3 × 2.5 mm ²	-	-	-	-	-	-	-	-
VEHK0612	Standard high-current cable set	2 × 6 m / 19.68 ft, 70 mm ² (800 A)	■	■	-	-	-	-	-	-
VEHK0613	Standard high-voltage cable set	2 × 6 m / 19.68 ft, 0.5 mm ² (2000 V)	■	■	-	-	-	-	-	-
VEHK0614	Standard measurement cable set	6 × 6 m / 19.68 ft, 2.5 mm ²	■	■	-	-	-	-	-	-
VEHK0615	Grounding cable (green/yellow)	1 × 6 m / 19.68 ft, 6 mm ² with connection clamp	■	■	■	■	■	■	■	■
VEHK0617	Optional high-current cable set	2 × 9 m / 29.53 ft, 70 mm ² (800 A)	-	-	■	-	-	-	-	-
VEHK0618	Optional high-voltage cable set	2 × 10 m / 32.81 ft, 0.5 mm ² (2000 V)	-	-	■	-	-	-	-	-

Order no.	Product	Description	CPC 100 Standard Package	CPC 100 Enhanced Package	Transformer Test System	Line Impedance Test System	CPC 100 TD/PF Test System ¹	CP TD1 Upgrade Option	CP CU1 Upgrade Option	CP SB1 Upgrade Option
VEHK0619	Optional measurement cable set	6 × 10 m / 32.81 ft, 2.5 mm ²	–	–	■	–	–	–	–	–
VEHK0680	Optional lightweight winding resistance measurement cables	2 × 20 m / 65.6 ft, 25 mm ² for output 400 A DC	–	–	–	–	–	–	–	–
VEHK0616	Power cord CPC (EU, Middle East)	3 × 1.5 mm ² , 2.5 m / 8.20 ft, VII	■ ²	■ ²	■ ²	–	■ ²	–	–	–
VEHK0620	Power cord CPC (ZA, IN, NA)	3 × 1.5 mm ² , 2.5 m / 8.20 ft, ZA/3	■ ²	■ ²	■ ²	–	■ ²	–	–	–
VEHK0621	Power cord CPC (open end)	3 × 1.5 mm ² , 2.5 m / 8.20 ft, open ends	■ ²	■ ²	■ ²	–	■ ²	–	–	–
VEHK0622	Ethernet PC connection cable	3 m / 9.84 ft, twisted pair cat 5, RJ45 connector	■	■	■	■	■	–	–	–
VEHK0623	Low voltage adapter	4 mm / 15.74 in banana to low voltage plug	■	■	■	–	–	–	–	–
VEHK0624	Power cord CPC (GB, HK)	3 × 1.5 mm ² , 2 m / 6.56 ft, BS connector (for GB, HK)	■ ²	■ ²	■ ²	–	■ ²	–	–	–
VEHK0627	MV-cable set for CP CU1	3 × cables (2 m / 6.56 ft, 95 mm ²) with clamps on both ends to connect the CP GB1 to MV-cable installations	–	–	–	–	–	–	–	–
VEHK0652	Coax measurement cable	6 m / 19.68 ft	–	–	–	■	–	–	■	–
VEHK0676	Cable set with Kelvin clamps	2 current cables (red and black) (6 m / 19.68 ft, 6 mm ²) and banana sockets for measurement cables	–	–	–	■	–	–	■	–
VEHK0677	3-lead shorting cable	0.3 m / 11.81 in, 10 mm ² with 6 mm / 0.24 in plugs	–	–	–	■	–	–	■	–
VEHK0678	Booster connection cable	6 m / 19.68 ft, 3 × 1.5 mm ²	–	–	–	■	–	–	■	–
VEHK0690	Connection cables for CP SB1	Set of 10 coaxial cables (15 m / 49.21 ft, 2.5 mm ²) on cable drum (3 × red, 3 × blue, 2 × green, 2 × yellow)	–	–	–	–	–	–	–	■
VEHP0061	Transport case for CPC 100	Transport case with wheels for CPC 100	■	■	■	■	■	–	–	–
VEHP0062	Transport case for CP TD1	Transport case with wheels for CP TD1	–	–	■	–	■	■	–	–
VEHP0063	Transport case for CP CU1 or CP CR500	Transport case with wheels for CP CU1 & CP GB1 or CP CR500	–	–	–	■	–	–	■	–
VEHP0066	Transport case for CPC 100 accessories	Transport case with wheels for CPC 100 accessories	–	–	–	–	–	–	–	–
VEHP0067	Transport case for CP TD1 accessories	Transport case with wheels for CP TD1 accessories	–	–	■	–	■	■	–	–
VEHP0069	Carry bag for CPC 100 accessories	Carry bag for CPC 100 accessories	■	■	■	–	–	–	–	–
VEHP0071	Transport case for CP CB2	Transport case with wheels for CP CB2	–	–	–	–	–	–	–	–
VEHP0090	Transport case for CP SB1	Transport case with wheels for CP SB1	–	–	–	–	–	–	–	■
VEHS0006	Solid terminal adapters	Solid terminal adapters (12 pcs)	–	–	■	–	■	■	–	–
VEHS0009	Flexible terminal adapters	Flexible terminal adapters (12 pcs)	–	–	–	–	–	–	–	■
VEHS0610	Low voltage plug	Low voltage plug, spare plug for voltage input (0 ... 3 V)	–	–	–	–	–	–	–	–
VEHZ0021	100TX to 100FX-SC converter	100TX to 100FX-SC converter (optical – electrical)	–	–	–	–	–	–	–	–
VEHZ0600	CP TD1 accessories set	CP TD1 accessories set	–	–	■	–	■	■	–	–
VEHZ0610	Connection clamps for high-voltage	For connection with banana plugs, 4mm / 0.16 in (2 standard clamps and 2 Kelvin clamps)	■	■	■	–	–	–	–	–
VEHZ0611	Warning lamp set	Warning strobe set for CPC 100	–	–	–	–	–	–	–	–
VEHZ0613	CP TD1 C-Load	Reference C-Load for verification of power loss measurements with CP TD1	–	–	–	–	–	–	–	–

■ included – not included

¹ Order no. VE000640
² Power cord is arbitrary

Ordering information

Cables and accessories

Order no.	Product	Description	CPC 100 Standard Package	CPC 100 Enhanced Package	Transformer Test System	Line Impedance Test System	CPC 100 TD/PF Test System ¹	CP TD1 Upgrade Option	CP CU1 Upgrade Option	CP SB1 Upgrade Option
VEHZ0620	Crocodile clamps	Crocodile clamps for connection of the banana plugs, 4 mm / 0.16 in (2 x red and 2 x black)	■	■	■	-	-	■	-	-
VEHZ0622	Ground Impedance Set for CP CU1	Ground Impedance Set for CP CU1	-	-	-	-	-	-	-	-
VEHZ0623	Rogowski coil	Length 1.90 m / 6.23 ft, 20 / 200 A	-	-	-	-	-	-	-	-
VEHZ0624	Handheld eTrexH GPS navigation device	Handheld eTrexH GPS navigation device for evaluation of distance	-	-	-	-	-	-	-	-
VEHZ0625	Step & touch voltage set for CP CU1	Pair of foot electrodes, handheld grounding tester HGT1, cables and ground electrode	-	-	-	-	-	-	-	-
VEHZ0627	Set of two foot electrodes	Set of two foot electrodes	-	-	-	-	-	-	-	-
VEHZ0635	Pulley for current booster	Pulley for current booster block and tackle including 25 m / 82.02 in rope and carabiners for easily lifting the booster CP CB2	-	-	-	-	-	-	-	-
VEHZ0640	CP trolley	Comfortable trolley for single person operation in the field with tan δ / power factor test system	-	-	■	-	■	■	-	-
VEHZ0644	TH3631	Unit for measurement of humidity and temperature of the air and on the surface of test objects	-	-	■	-	-	-	-	-
VEHZ0646	New e IFC-5 interface card	New e IFC-5 interface card for CPC 100	-	-	-	-	-	-	-	-
VEHZ0688	3-position remote safety switch	Remote safety switch (3-position) for CPC 100	-	-	-	-	-	-	-	-
VEHZ0660	Ground resistance accessory set	4 x electrodes, 1 x cable reel red (50 m / 164.04 ft), 1 x cable reel black (100 m / 328.08 ft)	-	■	-	-	-	-	-	-
VEHZ0665	CP SA1 surge arrester box	Surge arrester box for 100 A winding resistance measurement	■	■	■	-	-	-	-	-
VEHZ0666	USB memory stick	USB memory stick	■	■	■	■	■	-	-	-
VEHZ0675	400 A clamp-on ammeter / multimeter	400 A clamp-on ammeter / multimeter	-	-	-	-	-	-	-	-
VEHZ0676	Set of 3 CP GB1 surge arrestors	Replacement kit with 3 CP GB1 surge arrestors	-	-	-	■	-	-	■	-
VEHZ0677	Short circuiting bar	4 mm / 0.16 in, 19 mm / 0.75 in	-	-	-	■	-	-	■	-
VEHZ0678	Hot collar band	Hot collar band	-	-	■	-	■	■	-	-
VEHZ0681	16 mm / 0.63 in cyl. studs and clamp U1 for CP GB1	Studs and grounding socket clamp for CP GB1 for connection on 16 mm / 0.63 in cylindrical grounding studs	-	-	-	-	-	-	-	-
VEHZ0682	20 mm / 0.79 in ball studs and clamp U1 for CP GB1	Studs and grounding socket clamp for CP GB1 for connection on 20 mm / 0.79 in ball studs	-	-	-	-	-	-	-	-
VEHZ0683	25 mm / 0.98 in ball studs and clamp U2 for CP GB1	Studs and grounding socket clamp for CP GB1 for connection on 25 mm / 0.98 in ball studs	-	-	-	-	-	-	-	-
VEHZ0691	Kelvin clamps	4 x set of 2 Kelvin clamps	-	-	-	-	-	-	-	■
VESD0600	CPC 100 reference manual	CPC 100 reference manual	-	-	-	-	-	-	-	-
VESD0601	CPC 100 user manual	CPC 100 user manual	■	■	■	■	■	-	-	-
VESD0671	CP CU1 reference manual	CP CU1 reference manual	-	-	-	■	-	-	■	-
VESD0606	CP TD1 reference manual	CP TD1 reference manual	-	-	■	-	■	■	-	-
X0000089	CPC Toolset DVD	CPC Toolset DVD (including 30-days trial licence for PTM Advanced)	■	■	■	■	■	■	■	■

■ included - not included ¹ Order no. VE000640

Training at OMICRON Academy

Excellence through education

OMICRON offers several training courses to become familiar with the CPC 100 and its accessories. Working in small groups customers practise using the CPC 100 primary test system and perform practical measurements on different test objects.

The training program provides customers with valuable expertise while serving real-life needs at the same time.

Expert trainers and dedicated training equipment with different test objects and models simulating every part of the substation in the classroom are the key to OMICRON's customer-oriented professional development.



General training contents

- > Operating philosophy of the CPC 100
- > Applying the general test cards
- > Working with the test cards
- > Preparing tests and documenting the measurement results efficiently with the PC software
- > Practical exercises on different assets
- > Introduction to CPC 100 accessories

Scheduled training

The training courses regularly take place at the OMICRON Training Centers all around the world.

Customized training

In case of specific customer requirements OMICRON also offers customized on-site training courses. These training courses can take place at the customer's premises or at the substation.

Webinars

This form of training reduces down time and expense for customers. Customers can sign in for OMICRON's webinars and participate in an easy and comfortable way from their desk.



Detailed information about all training courses and dates offered can be found on the OMICRON website:

www.omicron.at/en/training/

OMICRON is an international company serving the electrical power industry with innovative testing and diagnostic solutions. The application of OMICRON products allows users to assess the condition of the primary and secondary equipment on their systems with complete confidence. Services offered in the area of consulting, commissioning, testing, diagnosis and training make the product range complete.

Customers in more than 140 countries rely on the company's ability to supply leading-edge technology of excellent quality. Service centers on all continents provide a broad base of knowledge and extraordinary customer support. All of this together with our strong network of sales partners is what has made our company a market leader in the electrical power industry.

The following publications provide further information on the solutions described in this brochure:



Diagnostic Testing Solutions for Power Transformers Brochure



CP CU1 Brochure



Primary Test Manager™ (PTM) Brochure

For more information, additional literature, and detailed contact information of our worldwide offices please visit our website.