

emotion of sauna.



Installation and user's manual

ECON H1



GB



IP x4



Druck Nr. 29342787en / - 22.06



Contents

1. General information
 - 1.1 Technical Data
 - 1.2 Package contents
 - 1.3 General safety precautions
 2. Assembly of the control unit
 - 2.1 Wall mounting
 - 2.2 Electrical connection
 - 2.2.1 Connecting the sauna oven
 - 2.2.2 Connecting the vaporizer
 - 2.2.3 Connecting the sauna lamp
 - 2.3 Connecting the sensor lines
 3. Operation
 - 3.1.1 Dry (Finnish) sauna
 - 3.2 Steam operation
 - 3.2.1 Supplemental heating function
 - 3.2.2 Low water shutoff
 4. Troubleshooting
 - 4.1.1 Error indicator in display
 - 4.2 Overheat safety shutoff
 - 4.3 Monitoring the temperature sensor
 5. Heating time extension
 6. Guarantee
Manufacturer's warranty
-

1. General information

1.1 Technical data

Rated voltage:	400 V 3 N 50 Hz AC
Breaking capacity:	max 9 kW resistive load (AC 1 operation) Climatic operation: 6 kW + 3 kW for vaporizer unit, upgrade to 36 kW possible through connection to circuit breakers
Heating time shut-off:	6 h or optionally 12 h after removal of resistance
Display:	two-digit, 7 segmented display
Protection type:	IPx4 in accordance with DIN (German Standards Institution) 40050, Splashproofing
Control range, sauna operation:	70 to 110° C
Control range, steam operation:	30 to 65° C during steam operation control: time proportional vaporizer control
Sensor system:	KTY-Sensor with overheat shutoff protection at 139° C
Water level control:	low water level in the vaporizer causes automatic shutoff after two minutes of low water level
Control characteristics:	digital two-step control of -20° C - max. cab temperature
Ventilation capacity:	max. 200 W max. 1A
Light:	max 200 W max. 1A
Supplemental heating function:	20 min after shutoff of steam program
Error display:	blinking LED for connector interruption to oven sensor connector interruption or failure of the safety temperature shutoff
Environmental temperature:	0° C to + 40° C
Storage temperatures:	20° C to +70° C

1.2 Package contents (subject to change)

Included with the control unit are

1. an oven-sensor board with overheat shutoff protection, KTY-sensors with sensor housing, two 3x25 mm fastening screws and a 1,7 m long sensor cable.
2. a plastic bag with three 4 x 20 mm fastening screws and three spacer tubes
3. a replacement overheat protection module

1.3 General safety precautions

- **Attention:** It is forbidden to install the control box in a closed switch cabinet or behind a wooden panelling!
- The electrical installation may be done only by a qualified electrical technician.
- You must comply with the regulations of your electrical supplier and applicable VDE regulations (DIN VDE 0100).
- **WARNING:** Never attempt repairs or installations yourself, as this could result in serious injury. Only a qualified technician may remove the housing cover.
- Please note the dimensions in the assembly instructions, especially when installing the temperature sensor. The temperature above the oven is critical for the temperature setting. The temperature can be held within operating parameters and a minimal temperature gradient inside the sauna cabin can be achieved only if unit is assembled correctly.
- The device may only be used as intended as a control unit for sauna ovens up to 9 kW. (Up to 36 kW when combined with a breaking capacitor).
- Completely disconnect the control unit from the electrical circuit, i.e. flip all circuit breakers or the main circuit breaker during installation or repair.
- Please note the safety and installation information from the sauna oven manufacturer.

2. Assembly of the control unit

2.1 Wall mounting

Mount the control unit outside the sauna cabin only. The most practical mounting point would be the wall area onto which the sauna oven is mounted on the inside, except on the outside of the cabin. If electrical conduits are present, mount the control unit accordingly. To mount the control unit, please follow these instructions:



Illust. 1

1. Remove the cover of the control unit. Loosen the fastening screws below the control panel. If your unit uses control knobs, remove them. Enlarge the holes for the electrical cables (Illust. 4) with a sharp knife. Drill the threaded holes for the included 4 x 20 mm wood screws according to Illust.s 3 & 3.1.
2. Insert one of the wood screws into the upper middle hole. This screw will be the mounting point for the control unit. Make sure the screw is projecting out about 3 mm. (Illust. 3.2)
3. Hang the control unit onto the 3 mm projecting screw. Lead the electrical cable through the holes you enlarged in step 1 and screw the lower part of the housing onto the cabin wall using the lower threaded holes. (Illust. 4)

Please note:

If the sauna cabin is not equipped with electrical conduits, the electrical cables must be lead along the outside of the cabin, preferably in one of the recesses between the wood boards. Therefore, you have to mount the control unit farther away from the cabin wall, so you can lead the cables into the unit. In this case, use the included spacer tubes as shown in Illust. 3.3

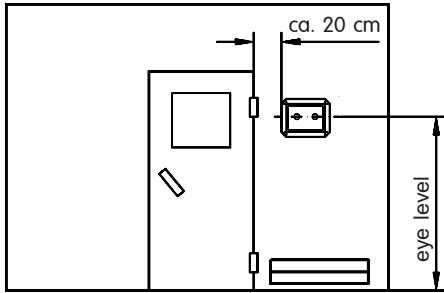

Illust. 2

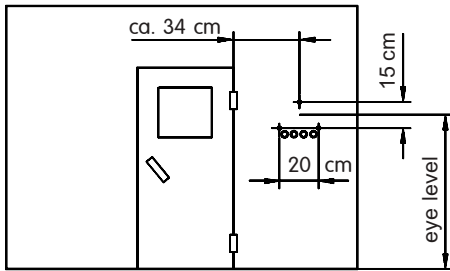

Illust. 3.1

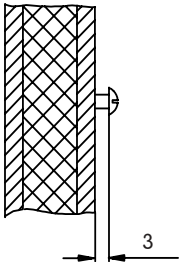

Illust. 3.2

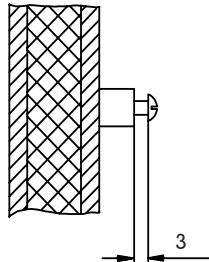

Illust. 3.3

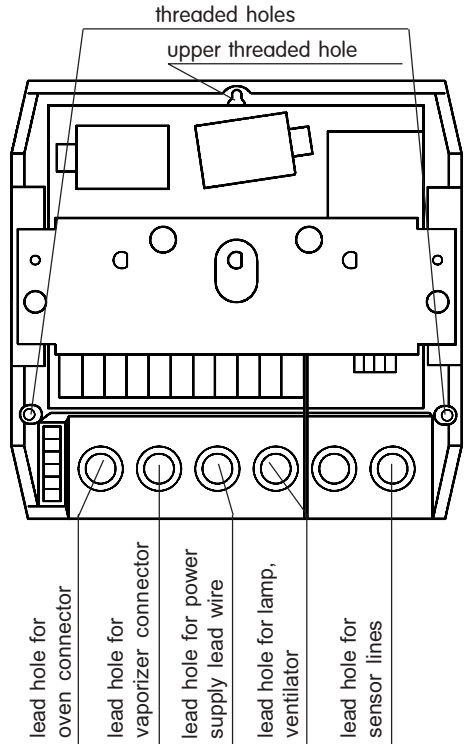

Illust. 4

2.2 Electrical connection

The electrical connection may only be done by a qualified electrical technician under authority of the regulations of the local power supply company and those of the VDE.

In general, there can only be one permanent connection to the power supply network, to include a device which allows the unit to be disconnected from the power source with a contact distance of at least 3 mm from all terminals.

All electrical installations and connector cables inside the cabin must be able to withstand temperatures up to 140°C. Please use the table below to determine the required cable diameters for this task.

Attach the power supply lead wire as shown in Illust. 5 to the power supply terminals of the control unit. Connection instructions are printed directly in the control unit.

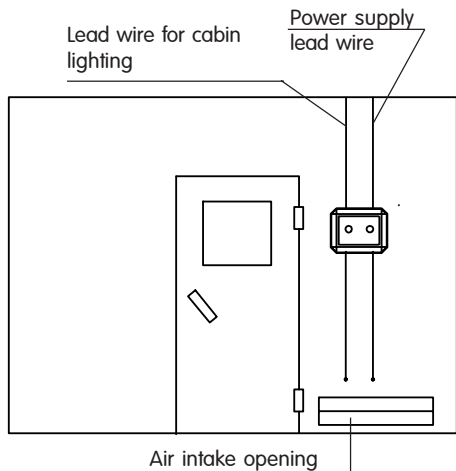

Illust. 5

Warning: Always connect the sauna oven's neutral conductor. During steam operation one of the phases shuts down, therefore the heat doesn't spread evenly. In consequence the neutral conductor becomes energized.

2.2.1 Connecting the sauna oven

Assemble the sauna oven and the vaporizer according to the instructions provided by the manufacturer in front of the air intake opening. Lead the silicon lines and electrical conduits to their respective terminals on the control unit and connect them according to the circuit diagram printed there.

Please note: If no electrical conduits are present, drill a hole with a diameter of 10 mm next to the air intake opening and lead the oven control cables through this hole to their corresponding terminals (U V W) in the control unit. To protect the silicon lines from external influences, install them in a shielded fashion. For this task, use a fitting cable or simple PVC conduit and lead the silicon cable through it to the control unit.

2.2.2 Connecting the vaporizer

To connect the vaporizer, use silicon connecting lines 4 x 1,5 mm² as well.

connector capacity in KW	appropriate for cabin sizes in m ³	minimum diameter in mm ² (copper wire) connection to 380 V 3N AC		
		power supply lead wire to the control unit	oven connector cable control unit for oven	safety fuse capacity in A
4,5	4 - 6	5 x 2,5 mm ²	5 x 1,5 mm ²	3 x 16
6,0	6 - 10	5 x 2,5 mm ²	5 x 1,5 mm ²	3 x 16
7,5	8 - 12	5 x 2,5 mm ²	5 x 1,5 mm ²	3 x 16
9,0	10 - 14	5 x 2,5 mm ²	5 x 1,5 mm ²	3 x 16

Warning: When connecting the vaporizer make sure it is correctly attached to the water bath (WB) and low water shutoff (WM). If you switch these connections, you disable the water deficiency function and bypass the thermostat. As a result, the vaporizer will overheat.

This is a fire hazard!!

Illust. 6 shows the circuit diagram. The control unit can detect water deficit if there is a zero-potential feed at the WM-input.

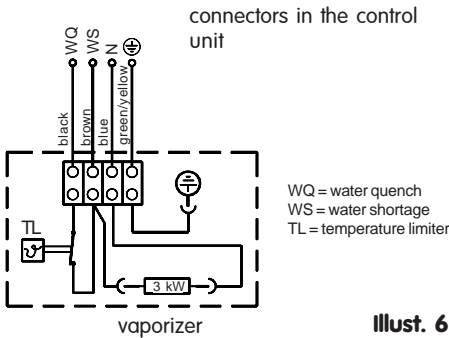

Illust. 6

Please note that the following measurements are based on values provided by the unit quality assurance by the European Standard EN 60335-53-2. In principle, you must mount the oven sensor where temperatures are the highest. Illust. 7 gives you an overview of the mounting point of the sensor.

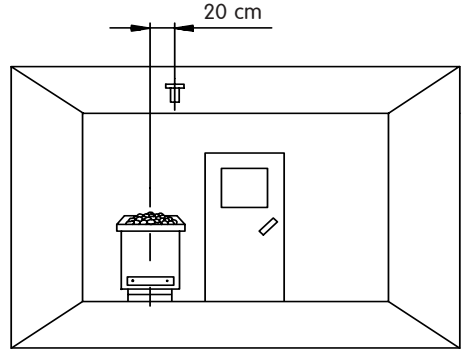

Illust. 7

2.2.3 Connecting the sauna lamp

The sauna lamp must be splashproof (by Standard IP54) and suitable for temperatures up to 140°C. The sauna lamp can be mounted anywhere except in the area of the rising hot air above the oven.

2.3 Connecting the sensor lines

You should not install sensor and power supply lines together, or lead them through the same conduit. This can lead to interferences in the electronics, such as "fluttering" in the switch protectors. If it is absolutely necessary to install them together, or the wire is longer than 3m, you should use a shielded sensor line such as the LIYLY-O (4 x 05, mm²). Connect the shielding to mass in the control unit.

Mounting the oven sensor

1. Mount the oven sensor in cabins up to 2 x 2m according to Illust. 7 and 8, in larger cabins according to Illust.s 7 and 9.

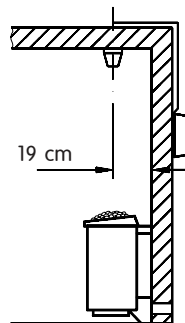

Illust. 8

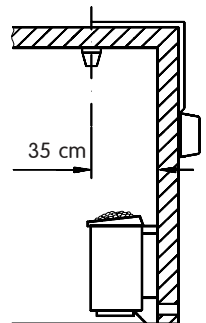

Illust. 9

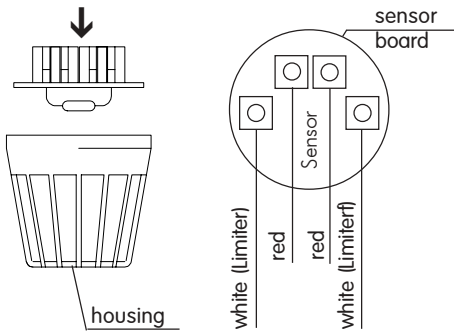

Illust. 10

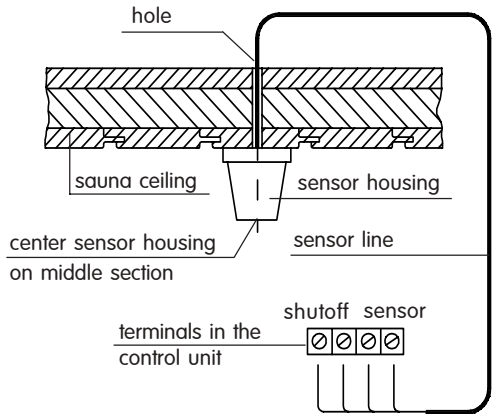

Illust. 11

2. Drill a hole to lead the cable through, preferably through the middle of one of the wooden boards.
3. Lead the sensor cable through the drilled hole and attach it to the sensor line according to Illust. 11.
4. Attach the lines for the shutoff (white) and the temperature sensor (red) according to Illust. 10 to the sensor board. Then insert the sensor board into the housing.

5. After you are finished installing and have made sure the control unit is functioning properly, check the line for overheat shutoff protection for short circuits. To do this, release one of the white lines in the sensor housing. The control unit's safety relay should now fall, i.e. the heating circuit should now be interrupted.

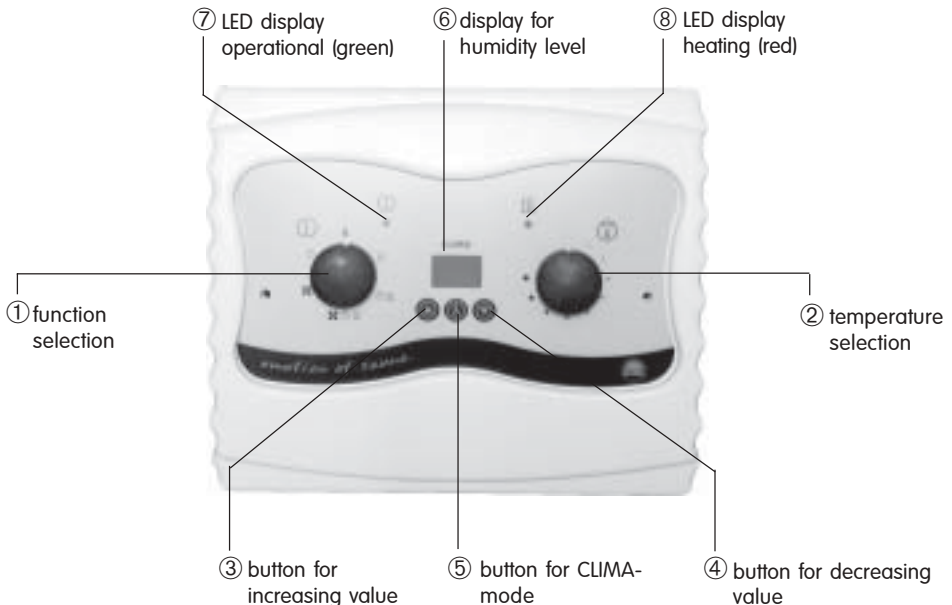

Illust. 12

3. Operation

The control unit is intended for two operational modes:



- Dry (Finnish) sauna
- Steam sauna



In the dry (Finnish) sauna mode the sauna air is not steamed additionally. The sauna air temperature can be set up to 110°C. During steam operation the maximum temperature is limited to 65°C for safety reasons.

The configuration of the operation elements are shown in Illust. 12.

① Switch knob to select the following functions

Heating  = sauna oven on

Light/heating   = sauna oven + cabin lighting on

Fan/light/heating    = sauna oven + cabin lighting + fan on

Fan  = fan (if installed) on

Licht  = light is on

0 = all installed components are off

② Turning dial for temperature selection

③ Button for increasing steam level

④ Button for decreasing steam level

⑤ Button for CLIMA - mode

⑥ LED-display for steam level

⑦ Standby display

⑧ Operation display for sauna oven

3.1 Startup of dry (Finnish) sauna operation

Switch the sauna oven with the left hand dial to ① operation, i.e. one of the switch positions with the  symbol.

The green LED above the button will light up. Depending on the current temperature in the sauna cabin, the sauna oven's red operational display ⑥ will light up, signaling the oven is heating.

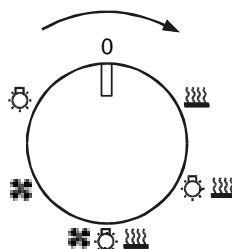

Use the right hand dial ② to set the desired cabin temperature. For a higher temperature turn the knob clockwise, for a lower temperature counter-clockwise.

The temperature can be set from 70°C up to 110°C (during sauna operation). Please take into consideration that these values can vary by a few degrees, depending on cabin configuration. For safety reasons the temperature is measured in the hottest area of the cabin above the oven. This temperature serves as a value for the temperature around the sauna benches. Depending on oven capacity and placement of the fresh air vents, undesirable influences can alter these measurements, not allowing the maximum temperature to be reached. The control range is laid out so that normal temperatures from 90 to 95°C in the bench area can be preselected.

3.2 Steam operation

A suitable vaporizer unit up to 3 kW and 230 V AC is required for steam operation. The control unit "clocks" the vaporizer based on the user-set steam level. Use the three buttons below the digital display ⑥ to set the vaporizer performance level.

Operation using the vaporizer function is activated via the middle CLIMA key ⑤. The value set for the last operating cycle appears in the display (in case of first-time operation, this is 0). With the two programming keys placed to the left and right of the CLIMA key, (up and down), Illust.13, you can program in amounts between 0 and 99%.



Press CLIMA key once

Illust. 13

The vaporizer is always activated when an amount between 1 and 99% is shown in the display. When the display shows 0, please note that the vaporizer is not activated, but as with steam operation in general, the maximum temperature in the cabin is limited to 65°C. Please note also that the vaporizer starts up only after the temperature falls to this level.

The value shown in the display reflects the time-proportional vaporizer adjustment. Therefore, the display cannot be adjusted for or show the relative humidity, but rather the frequency of vaporizer activation. The table (Illust.14) is meant to clarify this.

Amount shown in display	Vaporizer	
	On	Off
99	99 %	1 %
75	75 %	25 %
50	50 %	50 %
25	25 %	75 %
0	0	100 %

Illust. 14

Please note: During the activation of the vaporizer, the oven heats with only two phases; that is, one of the switch phases is switched to the vaporizer.

In the case of the symmetrically wired oven (equal heating power for each phase), one-third of the heating power of the sauna oven is consequently switched off. This serves both to protect the user from excessive temperatures as well as to limit the switch capacity to 3 kW per phase.

The humidity level aimed for depends strongly on the configuration of the sauna cabin, the type of sauna oven used and the power of the vaporizer. Therefore, it is important that you find your personal climate zone. Always choose the temperature first (from 30 to 60°C) and then the steam level.

Tip: For the preheating time, select a higher steam level (=duration of operation), so that the volume of water contained in the vaporizer (up to 8 liters depending on the model) will be heated more rapidly. When the oven and vaporizer are optimally adjusted to the sauna cabin, the values for humidity given in Illust.15 can be reached at 100% duration of operation.

Temperature	Relative humidity
60°C	50 %
50°C	60 %
40°C	70 %
30°C	80 %

Illust. 15

These amounts are reachable, although they are higher than the amounts actually needed.

Therefore, reduce the amounts after the preheat cycle; to do so, set a lower value using the program key ④. Please note that the cabin temperature is highest under the cabin ceiling, although the relative humidity is proportionally lower at this point. The relative humidity rises in proportion to the falling temperatures from the cabin ceiling to the cabin floor.

The following diagram (Illust. 16) shows you the temperature values proportional to the relative humidity for the most common types of sauna bathing and comfort zones.

Temperature in °C

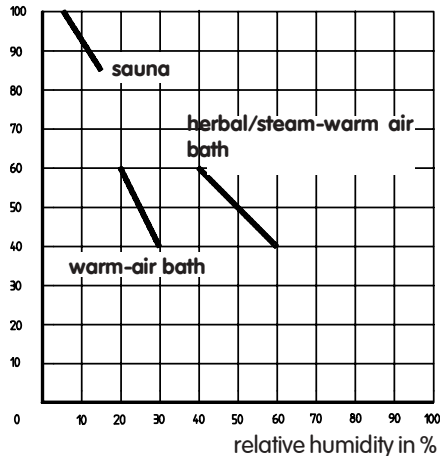

Illust. 16

3.2.1 Turning off steam operation-supplemental heating function

The steam operation program is stopped by pressing the CLIMA key. At the end of operation, a drying program is begun. The sauna is automatically heated to about 90°C for 20 minutes. The operating sequence of the supplemental drying program is exhibited by the blinking 7-segmented display.

The supplemental heating temperature has been preset by the manufacturer to 90°C and is not adjustable. If the supplemental heating program must be interrupted or if it is necessary to turn the system off completely, set the function dial to 0.

3.2.2 Low water shutoff

Vaporizer tanks are equipped with an overheat safety shutoff as a state-of-the-art standard. When this safety is activated, for example, when the water level in the vaporizer tank is too low (water deficit) and is not filled within two minutes, the control unit turns off for safety reasons and two dashes(--) appear on the display.

Please note: Some vaporizers are equipped with a buzzer, providing an acoustical signal as an additional warning when the thermostat in the vaporizer registers a water deficit.

4. Troubleshooting

Unit cannot be put in operation mode

Check to see whether socket (230V AC) is in contact with all three prongs. Check the fine adjustment on the board.

Blinking green LED

1. Check overheat shutoff in the sensor housing
2. Check lines leading to the overheat shutoff

Blinking red LED

1. Check temperature sensor
2. Check lines to temperature sensor

Unit can be turned on, oven heats, but needed temperature cannot be reached.

1. Check temperature sensor
2. Check lines to temperature sensor
3. Check assembly of sensor housing.
4. Check supply air and exhaust air

Poti Dial for temperature control must stop at right and left and must not be able to be turned 360°.

4.1 Checking the overheat safety shutoff

The control unit is equipped with a safety shutoff in the form of a temperature governor. This temperature governor is located in the sensor housing over the sauna oven and is connected to the control unit with the white sensor lines. If the sauna oven is not turned off due to a flaw in the electronics, the overheat shutoff registers temperatures starting at 140°C and breaks the circuit to the safety shutoff of the control unit and consequently to the sauna oven.

After such a shutdown, the overheat safety shut off must be replaced and the sauna unit or the control unit monitored by an expert.

Note to the electrical technician: You can easily check the function of the overheat safety shutoff by shorting the two contacts for the shut off line on the control unit or checking to see whether 0 V is indicated on the proper plug. At a high-ohm temperature check, this is defective and you will measure the control voltage.

4.3 Checking the temperature sensor

The control unit determines the temperature with a KTY temperature sensor. These have a positive temperature coefficient; that is, the resistance of these components rises as a function of the temperature.

An important value is the resistance at normal room temperature. At 20°C, this is about 1,9 kΩ.

To determine the temperature on the temperature sensor, you can measure the low voltage on the sensor plug with a voltmeter (measuring range 20 V DC) and calculate the temperature value using the diagrams (Illust. 17).

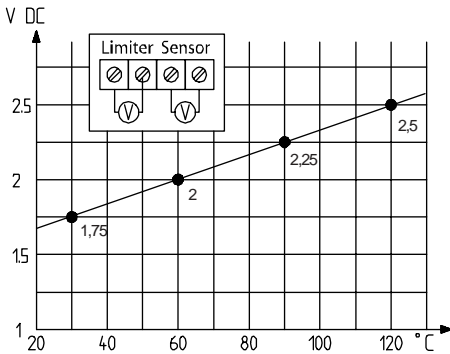

Illust. 17

5. Heating time extension

The control unit is adjusted for a maximum heating time of 6 hours at delivery. This heating time limit can be extended to 12 hours.

To do so, it is necessary to remove a resistor underneath the dial on the control board.

To get the correct position of the resistor, please look at Illust. 18. To accomplish this, it is absolutely necessary to switch off the fuses or the main switch.

Caution: As a matter of principle, this work may only be undertaken by a professional!

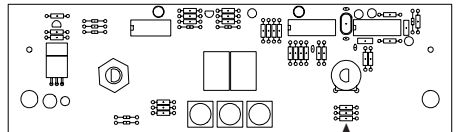

Remove this resistor for a heating time of 12 h

Illust. 18

Connecting diagram

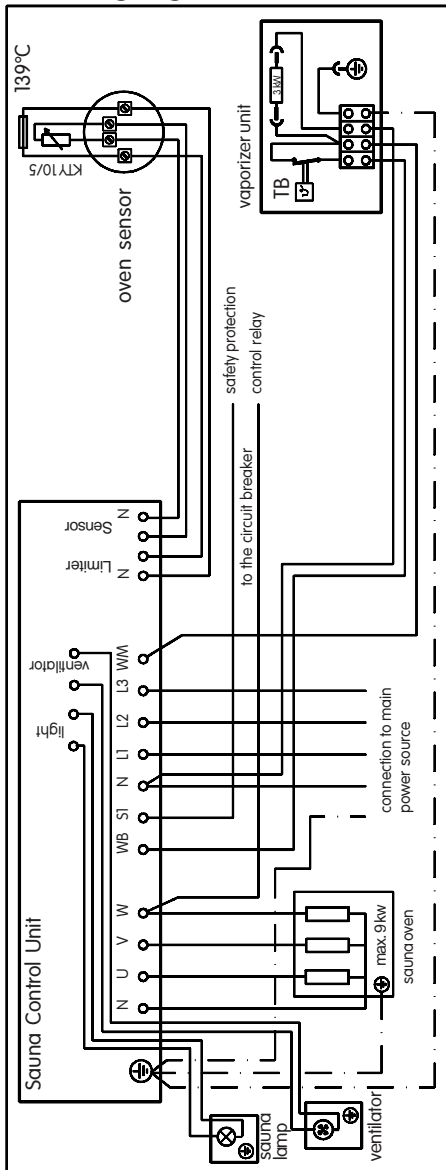

Service Address:
 EOS-Werke Günther GmbH
 Adolf-Weiß-Str. 43
 35759 Driedorf-Germany
 tel +49 (0)2775 82-240
 fax +49 (0)2775 82-455
 servicecenter@eos-werke.de
 www.eos-werke.de

Caution

Upon activation of the vaporizer, the exit port "W" is switched from the sauna heating unit via the plug "Wb" to the vaporizer.

In this case, the sauna heating unit will heat at only 2/3 of capacity.

Attention!

Dear customer,
 according to the valid regulations, the electrical connection of the sauna heater and the control box has to be carried out through the specialist of an authorized electric shop.

We would like to mention to the fact that in case of a warranty claim, you are kindly requested to present a copy of the invoice of the executive electric shop.

Guarantee

The guarantee is taken over according to the legal regulations at present.

Manufacturer's warranty

- The period of warranty starts from the date of purchase and lasts up to 2 years for commercial use and 3 years for private use.
- Always include the completed warranty certificate when returning equipment.
- The warranty expires for appliances which have been modified without manufacturer's explicit agreement.
- Damages caused by incorrect operation or handling through non-authorized persons are not covered under the terms of warranty.
- In the event of a claim, please indicate the serial number as well as the article code number and type name with expressive description of the fault.
- This warranty covers damaged parts but no defects due to wear and tear.

In case of complaint please return the equipment in its original packaging or other suitable packaging (caution: danger of transport damage) to our service department.

Always include the completed warranty certificate when returning equipment.

Possible shipping costs arising from the transport to and from point of repair cannot be borne by us.

Outside of Germany please contact your specialist dealer in case of warranty claims. Direct warranty processing with our service department is in this case not possible.

Equipment start-up date:

Stamp and signature of the authorized electrician: