

# PROFX4<sup>V2</sup>

4-CHANNEL PROFESSIONAL EFFECTS MIXER

## OWNER'S MANUAL

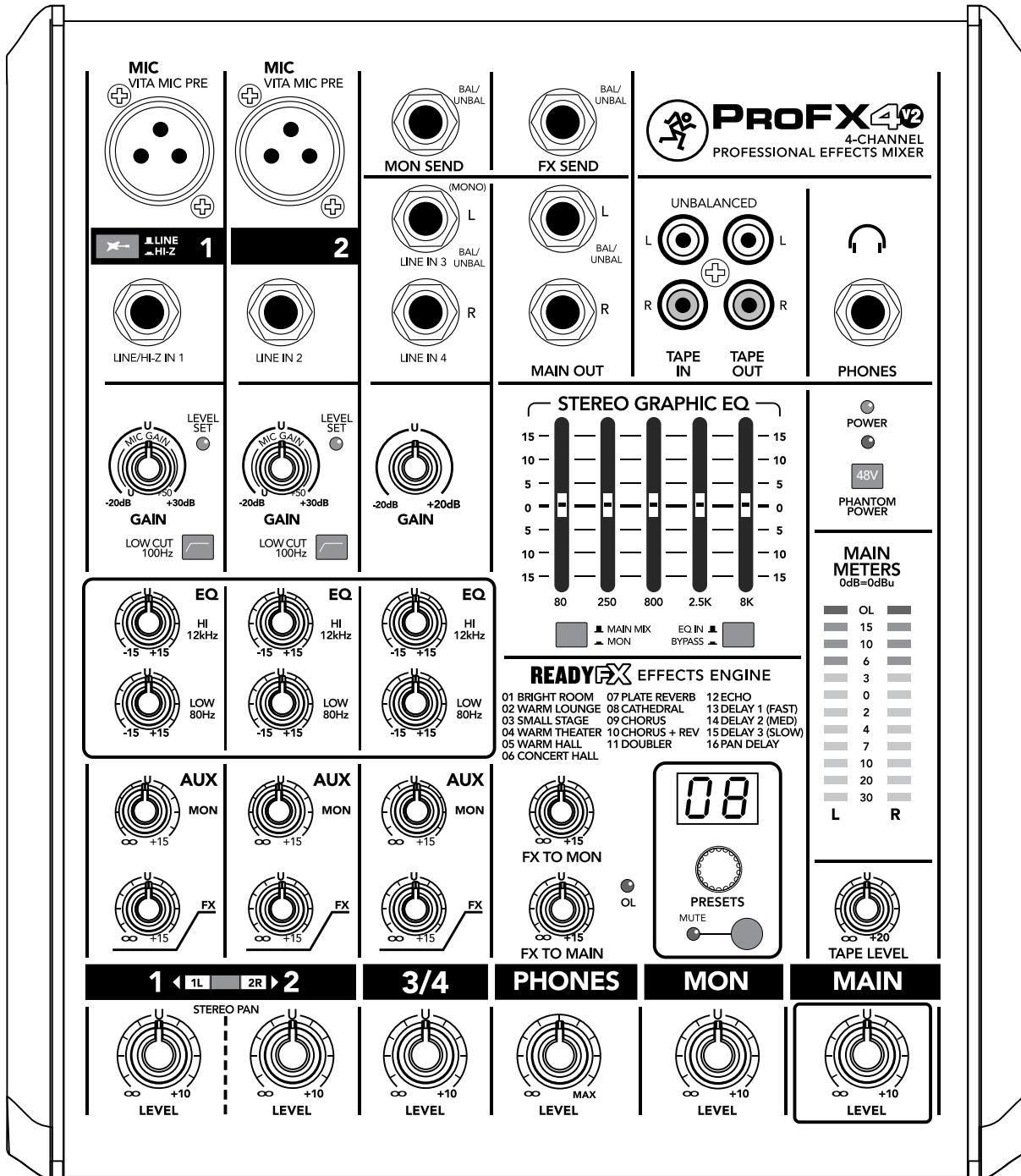

# Important Safety Instructions

1. Read these instructions.
2. Keep these instructions.
3. Heed all warnings.
4. Follow all instructions.
5. Do not use this apparatus near water.
6. Clean only with a dry cloth.
7. Do not block any ventilation openings. Install in accordance with the manufacturer's instructions.
8. Do not install near any heat sources such as radiators, heat registers, stoves, or other apparatus (including amplifiers) that produce heat.
9. Do not defeat the safety purpose of the polarized or grounding-type plug. A polarized plug has two blades with one wider than the other. A grounding-type plug has two blades and a third grounding prong. The wide blade or the third prong are provided for your safety. If the provided plug does not fit into your outlet, consult an electrician for replacement of the obsolete outlet.
10. Protect the power cord from being walked on or pinched particularly at plugs, convenience receptacles, and the point where they exit from the apparatus.
11. Only use attachments/accessories specified by the manufacturer.
12. Use only with a cart, stand, tripod, bracket, or table specified by the manufacturer, or sold with the apparatus. When a cart is used, use caution when moving the cart/apparatus combination to avoid injury from tip-over.
13. Unplug this apparatus during lightning storms or when unused for long periods of time.
14. Refer all servicing to qualified service personnel. Servicing is required when the apparatus has been damaged in any way, such as power-supply cord or plug is damaged, liquid has been spilled or objects have fallen into the apparatus, the apparatus has been exposed to rain or moisture, does not operate normally, or has been dropped.
15. This apparatus shall not be exposed to dripping or splashing, and no object filled with liquids, such as vases or beer glasses, shall be placed on the apparatus.
16. Do not overload wall outlets and extension cords as this can result in a risk of fire or electric shock.
17. The MAINS plug or an appliance coupler is used as the disconnect device, so the disconnect device shall remain readily operable.



**18. NOTE:** This equipment has been tested and found to comply with the limits for a Class B digital device, pursuant to part 15 of the FCC Rules. These limits are designed to provide reasonable protection against harmful interference in a residential installation. This equipment generates, uses, and can radiate radio frequency energy and, if not installed and used in accordance with the instructions, may cause harmful interference to radio communications. However, there is no guarantee that interference will not occur in a particular installation.

If this equipment does cause harmful interference to radio or television reception, which can be determined by turning the equipment off and on, the user is encouraged to try to correct the interference by one or more of the following measures:

- Reorient or relocate the receiving antenna.
- Increase the separation between the equipment and the receiver.
- Connect the equipment into an outlet on a circuit different from that to which the receiver is connected.
- Consult the dealer or an experienced radio/TV technician for help.

**CAUTION:** Changes or modifications to this device not expressly approved by LOUD Technologies Inc. could void the user's authority to operate the equipment under FCC rules.

**19.** This apparatus does not exceed the Class A/Class B (whichever is applicable) limits for radio noise emissions from digital apparatus as set out in the radio interference regulations of the Canadian Department of Communications.

**ATTENTION** — *Le présent appareil numérique n'émet pas de bruits radioélectriques dépassant les limites applicables aux appareils numériques de class A/de class B (selon le cas) prescrites dans le règlement sur le brouillage radioélectrique édicté par les ministere des communications du Canada.*

**20.** Exposure to extremely high noise levels may cause permanent hearing loss. Individuals vary considerably in susceptibility to noise-induced hearing loss, but nearly everyone will lose some hearing if exposed to sufficiently intense noise for a period of time. The U.S. Government's Occupational Safety and Health Administration (OSHA) has specified the permissible noise level exposures shown in the following chart.

According to OSHA, any exposure in excess of these permissible limits could result in some hearing loss. To ensure against potentially dangerous exposure to high sound pressure levels, it is recommended that all persons exposed to equipment capable of producing high sound pressure levels use hearing protectors while the equipment is in operation. Ear plugs or protectors in the ear canals or over the ears must be worn when operating the equipment in order to prevent permanent hearing loss if exposure is in excess of the limits set forth here:

Duration, per day in hours	Sound Level dBA, Slow Response	Typical Example
8	90	Duo in small club
6	92	
4	95	Subway Train
3	97	
2	100	Very loud classical music
1.5	102	
1	105	Matt screaming at Troy about deadlines
0.5	110	
0.25 or less	115	Loudest parts at a rock concert

**CAUTION**

RISK OF ELECTRIC SHOCK! DO NOT OPEN!

CAUTION: TO REDUCE THE RISK OF ELECTRIC SHOCK DO NOT REMOVE COVER (OR BACK). NO USER-SERVICEABLE PARTS INSIDE. REFER SERVICING TO QUALIFIED PERSONNEL.

The lightning flash with arrowhead symbol within an equilateral triangle is intended to alert the user to the presence of uninsulated "dangerous voltage" within the product's enclosure, that may be of significant magnitude to constitute a risk of electric shock to persons.

The exclamation point within an equilateral triangle is intended to alert the user of the presence of important operating and maintaining (servicing) instructions in the literature accompanying the appliance.

**WARNING** — To reduce the risk of fire or electric shock, do not expose this apparatus to rain or moisture.

Laitte on liitettävä suojakoskettimilla varustettuun pistorasiaan.

Apparatet må tilkoples jordet stikkontakt.

Apparaten skall anslutas till jordat uttag.

**Correct disposal of this product:** This symbol indicates that this product should not be disposed of with your household waste, according to the WEEE directive (2012/19/EU) and your national law. This product should be handed over to an authorized collection site for recycling waste electrical and electronic equipment (EEE). Improper handling of this type of waste could have a possible negative impact on the environment and human health due to potentially hazardous substances that are generally associated with EEE. At the same time, your cooperation in the correct disposal of this product will contribute to the effective usage of natural resources. For more information about where you can drop off your waste equipment for recycling, please contact your local city office, waste authority, or your household waste disposal service.

# Contents

Important Safety Instructions ..... 2

Contents..... 3

Features ..... 3

Introduction ..... 4

How To Use This Manual ..... 4

Things To Remember..... 4

Getting Started..... 4

Hookup Diagrams..... 5

ProFX4v2 Rear Panel Features ..... 7

    1. Power Connection ..... 7

    2. Power Switch ..... 7

ProFX4v2 Front Panel Features..... 8

    Connections and Channel Strip..... 8

        3. Mic Inputs ..... 8

        Phantom Power ..... 8

        4. Line / Hi-Z Switch ..... 8

        5. Line Inputs / Hi-Z Input (Channel 1 Only). 9

        6. Stereo Line Inputs..... 9

        "U" like Unity Gain ..... 9

        7. Gain..... 9

        8. Level Set LED..... 10

        9. Low Cut Switch..... 10

        2-Band Equalization ..... 10

        10. Hi EQ ..... 10

        11. Low EQ ..... 10

        12. Aux Mon..... 11

        13. Aux FX..... 11

        14. Stereo Pan Switch (Ch. 1-2) ..... 11

        15. Level..... 11

    Additional Inputs and Outputs..... 12

        16. Mon Send..... 12

        17. FX Send ..... 12

        18. Main Out L/R..... 12

        19. Tape Inputs / Outputs..... 12

        20. Phones..... 12

    Stereo Graphic EQ and Main Meters ..... 13

        21. Power LED ..... 13

        22. 48V Phantom Power Switch..... 13

        23. Stereo Graphic EQ..... 13

        24. Main Mix / Mon Switch..... 13

        25. EQ In / Bypass Switch ..... 13

        26. Main Meters..... 13

    Internal FX ..... 14

        27. Preset Selector ..... 14

        28. Preset Display ..... 14

        29. Int FX Mute Switch and LED..... 14

        30. Internal FX ..... 14

        31. OL LED ..... 14

    Phones, Mon, Tape and Main Mix..... 15

        32. Phones..... 15

        33. Aux Mon Master ..... 15

        34. Tape Level ..... 15

        35. Main Mix ..... 15

Appendix A: Service Information ..... 16

Appendix B: Technical Information ..... 17

    ProFX4v2 Dimensions ..... 19

    ProFX4v2 Block Diagram..... 20

    ProFX4v2 Track Sheet ..... 21

Appendix C: Table of Effects Presets..... 22

Limited Warranty..... 23

## Features

### Unmatched Sound Quality

- Two extremely low-noise Vita™ mic preamps designed to add life to any input
- All-new ReadyFX™ effects engine with 16 great-sounding effects like reverbs, delays and choruses

### No-Compromise Live Mixing Toolkit

- 5-band graphic EQ for tuning mains or monitors
- Aux output perfect for driving a monitor mix
- 2-band EQ (80 Hz and 12 kHz) on all channels
- Directly connect guitar, bass and other instruments via Hi-Z input
- 100Hz low-cut filter and 48V phantom power on all mic channels
- Stereo RCA tape I/O with input level control
- Headphone output with separate level control

### Rugged, Roadworthy Design

- Legendary “Built-Like-A-Tank” design
- Solid steel chassis protects your investment
- Tough ABS side protection



Like us



Follow us



Watch our dang videos

Part No. SW1115 Rev. A 04/15

©2015 LOUD Technologies Inc. All Rights Reserved.

# Introduction

The ProFX4v2 4-channel effects mixer provides a comprehensive live sound solution for singer / songwriters and other low channel count applications.

Delivering unmatched sound quality, the ProFX4v2 features all-new Vita™ preamps, which are virtually noiseless and designed specifically for the highly-dynamic world of live sound.

ProFX4v2 also includes the immensely powerful new ReadyFX™ effects engine, harnessing floating-point DSP to deliver 16 rich effects that elevate any performance.

A no-compromise live sound toolkit includes a room-shaping GEQ and flexible I/O for professional applications.

With a rugged steel chassis and unmatched sonic performance, ProFX4v2 is truly the life of your live mix.

## How to Use This Manual:

After this introduction, a getting started guide will help you get things set up fast. The hookup diagrams show some typical setups, while the remaining sections provide details of the ProFX4v2 mixer.



This icon marks information that is critically important or unique to the ProFX4v2. For your own good, read and remember them.



This icon leads you to in-depth explanations of features and practical tips. They usually have some valuable nuggets of information.



This icon draws attention to certain features and functions relating to the usage of the ProFX4v2.

## Things to Remember:

- Never listen to loud music for prolonged periods. Please see the Safety Instructions on page 2 for information on hearing protection.
- Save the shipping box and packing materials! You may need them someday. Besides, the cats will love playing in them and jumping out at you unexpectedly. Remember to pretend like you are surprised!
- Save your sales receipt in a safe place.

# Getting Started

The following steps will help you set up the ProFX4v2 mixer quickly.

1. Turn down all knobs except the channel EQ.
2. Set all channel EQ knobs and the graphic EQ sliders at their center detent.
3. Set all buttons to the “out” position.
4. Plug signal sources into the mixer, such as:
  - Microphones plugged into the mic inputs. Engage phantom power if your mics need it. Check the mic's user manual to be sure.
  - Line-level sources such as keyboards, drum machines, or CD players plugged into the line-level inputs.
5. Connect cords from the main outs to your powered speakers or amplifier.
6. Push the 2-pin female side of the power adaptor securely into the connector on the rear of the ProFX4v2. Plug the other end into an AC outlet properly configured with the correct voltage as indicated on the AC adaptor. Turn on the mixer.
7. If you have powered speakers, turn them on. Otherwise, hook up your passive speakers to your amp with speaker cables, and turn it on. Adjust your powered speaker or amplifier level controls to the manufacturer's recommended settings.
8. Be sure that the volume of the input is the same as it would be during normal use, or you may have to readjust the gain in the middle of a set. You can listen with headphones if you carefully turn up the channel level knob and headphones level a little.
9. Adjust the gain knobs as desired.
10. To get sound out of the speakers and into a waiting world, turn up that channel's level knob to the “U” (unity gain) position, and slowly bring up the main mix knob to a comfortable listening level.
11. Repeat steps 8 to 10 for the other channels.

# Hookup Diagrams

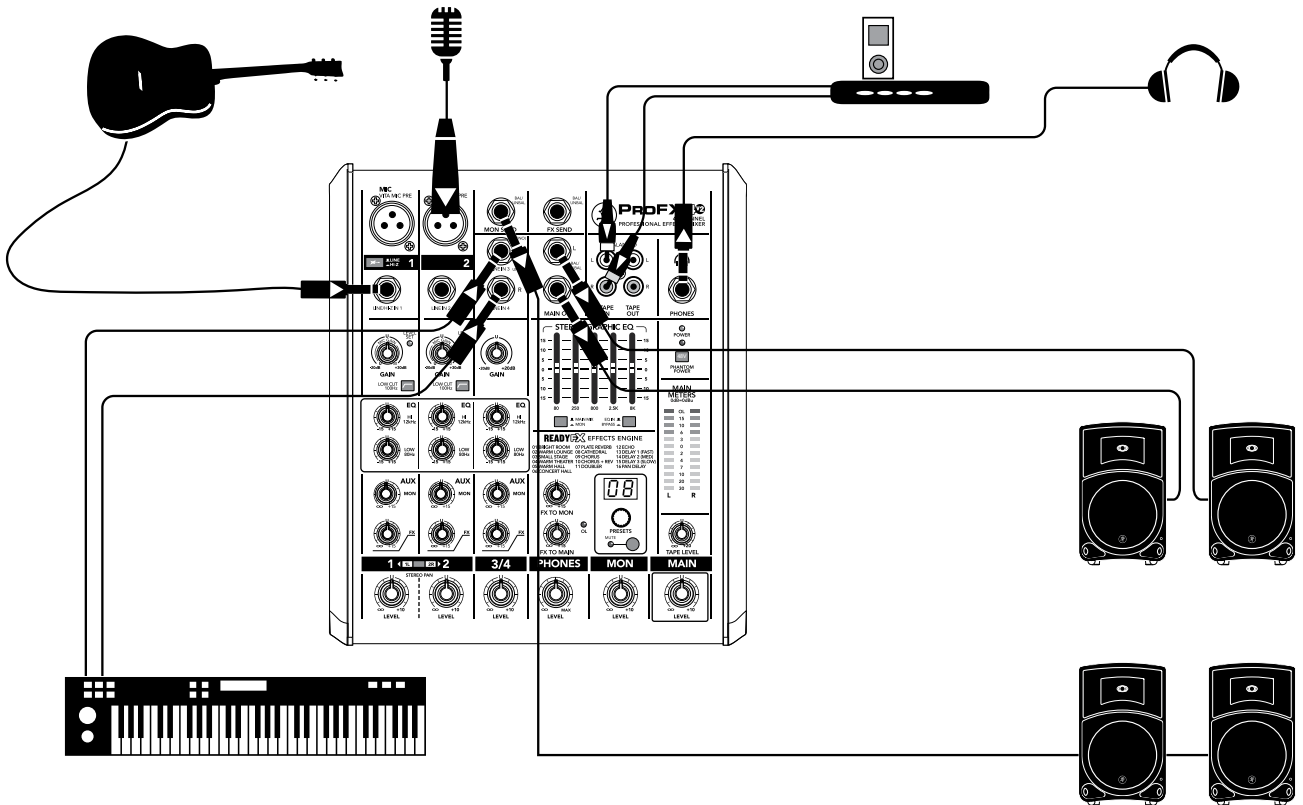

*This diagram shows an acoustic guitar plugged into the channel 1 line input with the line/hi-z switch engaged. A microphone is connected to the channel 2 XLR input for vocals and a keyboard is attached to the channel 3-4 line-level inputs. An iPod docking station is attached to the stereo tape inputs.*

*Thump15 powered speakers are connected to the left and right main output. Two of these speakers are also set up as stage monitors and connect to the mixer's monitor output. The aux mon controls of each channel allow you to create a stage monitor mix as desired, while headphones are used for monitoring.*

## Typical Live Sound System

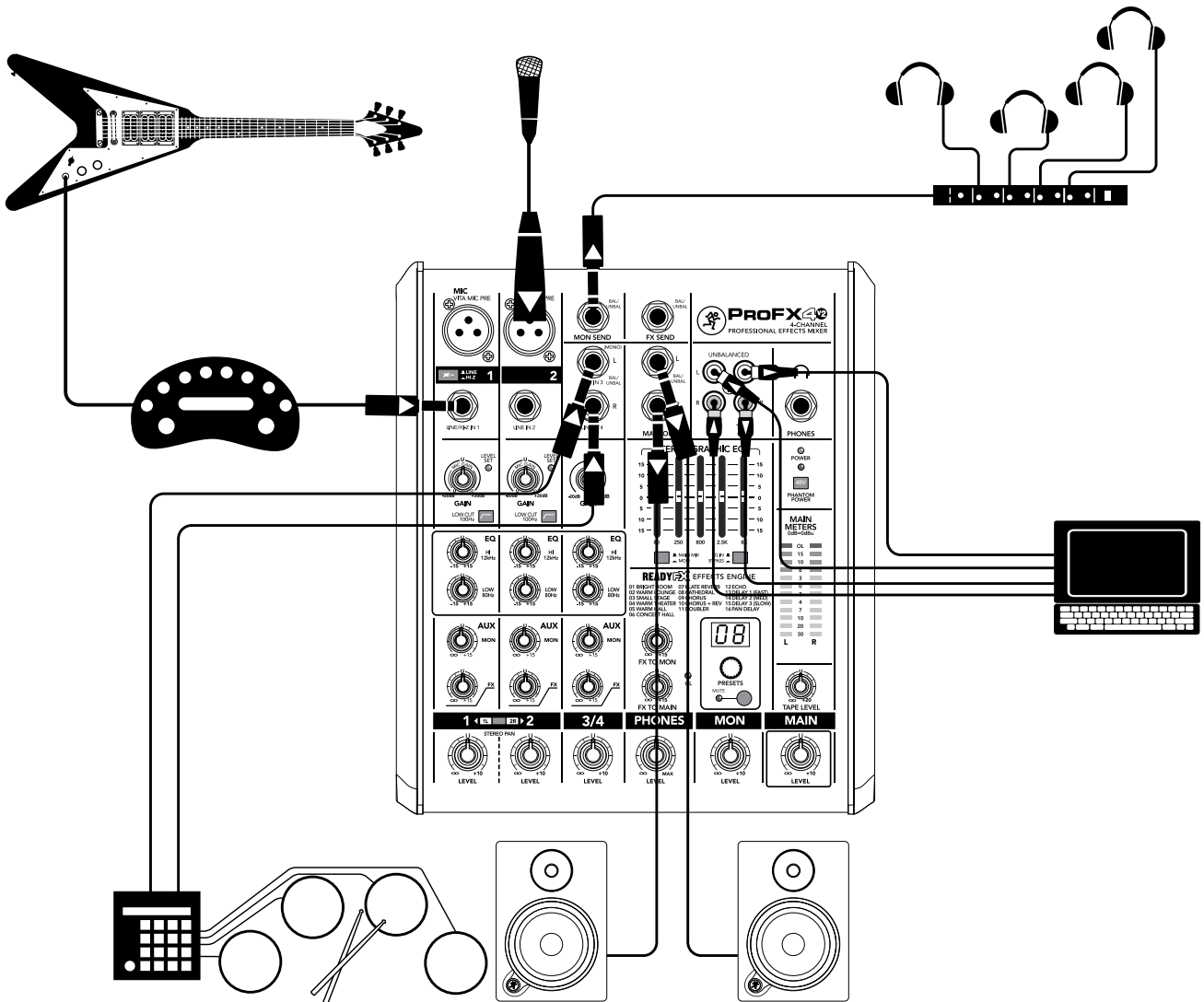

This diagram shows a Flying V plugged into a modeling device which is then connected to the channel 1 line input with the line/hi-z switch disengaged. [The modeling device is at line-level, not instrument]. A microphone is connected to the channel 2 XLR input for vocals and a drum machine is attached to the channel 3-4 line-level inputs.

MR8mk3 powered reference monitors are connected to the left and right main output. Headphones connected to the mon send via a headphone amp are available for the talent to utilize when tracking.

A laptop connects to the stereo tape inputs and outputs to record the 2-channel main mix to the DAW, as well as play back two channels from the DAW.

## Typical Recording System

# ProFX4v2 Rear Panel Features

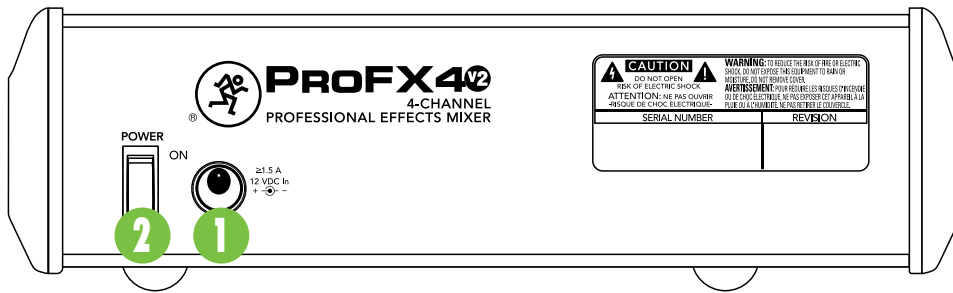

## 1. Power Connection

Push the 2-pin female side of the power adaptor securely into the connector on the rear of the mixer. Plug the other end into an AC outlet properly configured with the correct voltage as indicated on the AC adaptor.



Only use the AC adapter that came with your mixer, or a factory-authorized power supply.

## 2. Power Switch

Press the top of this rocker switch inwards to turn on the mixer. The front panel power LED will glow with happiness...or at least it will if you have the mixer's AC adaptor plugged into a suitable live AC mains supply.

Press the bottom of this switch to put the mixer into standby mode. It will not function, but the external power supply is still live. To remove power, either turn off the mains supply, or unplug the AC adaptor from the mixer and the mains supply.



As a general guide, you should turn on the mixer first, before any external power amplifiers or powered speakers, and turn it off last. This will reduce the possibility of any turn-on, or turn-off thumps in your speakers.

# ProFX4v2 Front Panel Features

## Connections and Channel Strip

The vertical channel strips look very similar and have only a few differences between them. Each channel works independently and just controls the signals plugged into the inputs directly above them.

### 3. Mic Inputs

ProFX4v2 mixers use 3-pin female XLR connectors on all microphone inputs, with pin 1 wired to the grounded (earthed) shield, pin 2 wired to the high (hot or positive polarity) side of the audio signal and pin 3 wired to the low (cold or negative polarity) side of the signal.

These female XLR connectors accept balanced mics or line level inputs from almost any type of source. The Vita mic preamps feature higher fidelity and headroom rivaling any standalone mic preamp on the market today.

We use phantom-powered, balanced inputs just like the big mega-consoles, for exactly the same reason: This kind of circuit is excellent at rejecting hum and noise.

Professional ribbon, dynamic, and condenser mics all sound excellent through these inputs. The mic/line inputs will handle any kind of level you can toss at them, without overloading.

Microphone-level signals are passed through the mixer's splendid microphone preamplifiers to become line-level signals. They are wired as follows, according to standards specified by the AES (Audio Engineering Society).

#### XLR Balanced Wiring:

- Pin 1 = Shield (ground)
- Pin 2 = Positive (+ or hot)
- Pin 3 = Negative (- or cold)

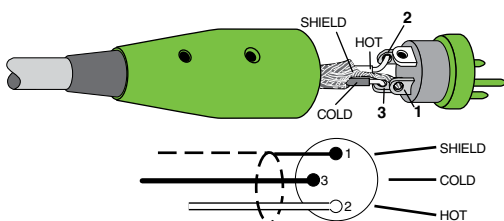

### Phantom Power

Most modern professional condenser mics require 48V phantom power which lets the mixer send low-current DC voltage to the mic's electronics through the same wires that carry audio. (Semi-pro condenser mics often have batteries to accomplish the same thing.) "Phantom" owes its name to an ability to be "unseen" by dynamic mics (Shure SM57/SM58, for instance), which don't need external power and aren't affected by it anyway.

**NOTE** The ProFX4v2 mixer's phantom power is globally controlled by the phantom power switch (meaning that phantom power for both mic inputs is turned on and off together.)

**VERY IMPORTANT** Never plug single-ended (unbalanced) microphones or ribbon microphones into the mic input jacks if phantom power is on. Do not plug instrument outputs into the mic input jacks with phantom power on unless you know for certain it is safe to do so.

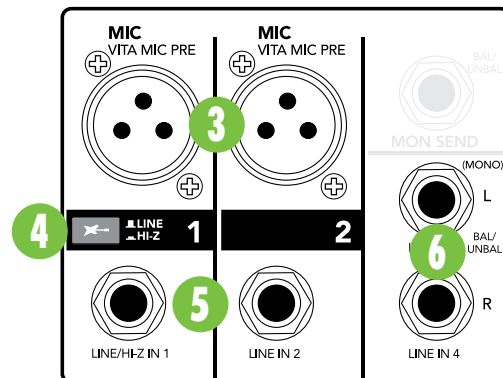

### 4. Line / Hi-Z Switch

To connect a guitar directly to the mixer without using a DI Box, press this switch in first; then connect the output from the guitar to channel 1's 1/4" TRS input. The input impedance is optimized for direct connection and high-frequency fidelity is assured.

In the out position, channel 1's 1/4" TRS input becomes a line input just like the other mono line inputs.

To use guitars or other instruments on other channels, you will need to use an external DI box first. Without the DI box – or if this switch is not pressed in – guitars may sound dull and muddy.



## 5. Line Inputs / Hi-Z Input (Channel 1 Only)

In addition to accepting balanced mic or line-level signals using an XLR connector, ProFX4v2 mixers may also accept 1/4" line-level signals driven by balanced or unbalanced sources. These 1/4" jacks share circuitry (but not phantom power) with the mic preamps.

To connect balanced lines to these inputs, use a 1/4" Tip-Ring-Sleeve (TRS) plug. "TRS" stands for Tip-Ring-Sleeve, the three connection points available on a stereo 1/4" or balanced phone jack or plug.

TRS jacks and plugs are used for balanced signals and stereo headphones and are wired as follows according to standards specified by the AES (Audio Engineering Society):

### 1/4" TRS Balanced Mono Wiring:

- Sleeve = Shield (ground)
- Tip = Positive (+ or hot)
- Ring = Negative (- or cold)

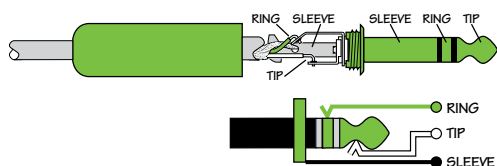

To connect an unbalanced line to this input, use a 1/4" mono (TS) phone plug or instrument cable. They are wired as follows, according to standards specified by the AES (Audio Engineering Society):

### 1/4" TS Unbalanced Mono Wiring:

- Sleeve = Shield (ground)
- Tip = Positive (+ or hot)

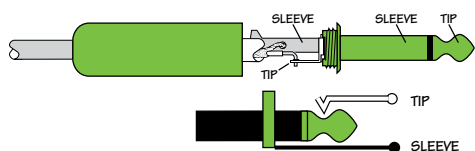

The channel 1 line-level input may also accept instrument-level signals if the hi-z switch is engaged. This allows you to connect guitars directly into channel 1 without the need for a DI box.

## 6. Stereo Line Inputs

The stereo line inputs are designed for 1/4" TRS balanced or 1/4" TS unbalanced signals. They may accept any line-level instrument, effects device, CD player, etc.

If you are connecting a mono source, use the left (mono) input, and the mono signals will appear on both sides of the main mix.

### "U" like Unity gain

ProFX4v2 mixers have a "U" symbol on almost every level control. It stands for "unity gain," meaning no change in signal level. The labels on the controls are measured in decibels (dB), so you'll know what you're doing level-wise if you choose to change a control's settings.

## 7. Gain

If you haven't already, please read the "Getting Started" section on page 4. Setting the gain correctly will ensure that the preamplifier's gain is not too high, where distortion could occur, and not too low, where the quieter, exquisitely-delicate passages might be lost in background noise.

The gain knobs adjust the input sensitivity of the mic and line inputs. This allows signals from the outside world to be adjusted to run through each channel at optimal internal operating levels.



For mono channels (mic input with a mono line input), the gain knob adjusts the input sensitivity of the mic and line inputs.

If the signal originates through the mic XLR jack, there will be 0 dB of gain with the knob fully down, ramping to 50 dB of gain fully up.

Through the 1/4" mono line inputs, there is 20 dB of attenuation fully down and 30 dB of gain fully up, with unity gain "U" at 12:00.

This 20 dB of attenuation can be very handy when you are inserting a hot signal, or when you want to add EQ gain, or both. Without this "virtual pad," there is more chance of channel clipping.

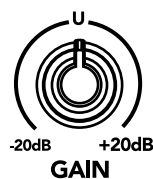

For stereo channels (no mic input) the gain control just affects the line-level inputs, with 20 dB of gain, and 20 dB of attenuation.

### 8. Level Set LED

These LEDs are used with the gain control to set the channel preamplifier gain just right for each source.

If one or more channels are distorting, check the level set LEDs. If they are on continuously, turn down the gain.

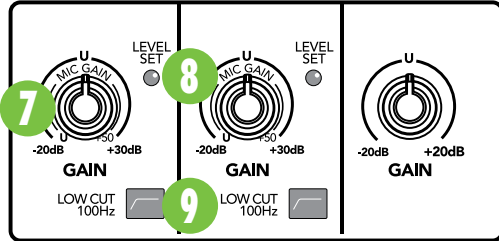

### 9. Low Cut Switch

Both mono channels have a low-cut switch (often referred to as a high-pass filter) that cuts bass frequencies below 100 Hz at a rate of 18 dB per octave.

We recommend that you use low-cut on every microphone application except kick drum, bass guitar, or bassy synth patches. These aside, there isn't much down there that you want to hear, and filtering it out makes the low stuff you do want much more crisp and tasty. Not only that, but low-cut can help reduce the possibility of feedback in live situations, and it helps to conserve amplifier power.



Another way to consider the low-cut's function is that it actually adds flexibility during live performances. With the addition of low-cut, you can safely use low equalization on vocals. Many times, bass shelving EQ can really benefit voices. Trouble is, adding low EQ also boosts stage rumble, mic handling clunks and breath pops from way-down low. Applying low-cut removes all those problems, so you can add low EQ without blowing the woofers.

### 2-Band Equalization

The ProFX4v2 has 2-band equalization at carefully selected points — low shelving at 80 Hz, and hi shelving at 12 kHz. “Shelving” means that the circuitry boosts or cuts all frequencies past the specified frequency. For example, rotating the low EQ knob 15 dB to the right boosts bass starting at 80 Hz and continuing down to the lowest note you never heard.



With too much EQ, you can really upset things. We've designed a lot of boost and cut into each equalizer circuit because we know that everyone will occasionally need that. But if you max the EQ on every channel, you'll get mix mush. Equalize subtly and use the left sides of the knobs (cut), as well as the right (boost). If you find yourself repeatedly using a lot of boost or cut, consider altering the sound source, such as placing a mic differently, trying a different kind of mic, a different vocalist, changing the strings, or gargling.

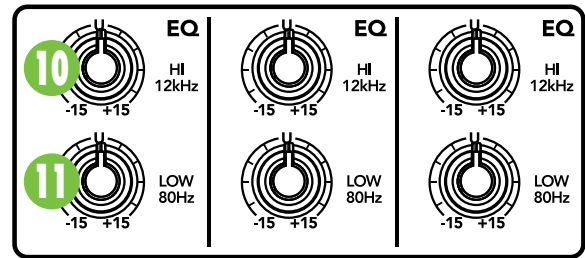

### 10. Hi EQ

The hi EQ provides up to 15 dB of boost or cut above 12 kHz, and it is also flat (no boost or cut) at the detent. Use it to add sizzle to cymbals, an overall sense of transparency, or an edge to keyboards, vocals, guitar and bacon frying. Turn it down a little to reduce sibilance or to mask tape hiss.

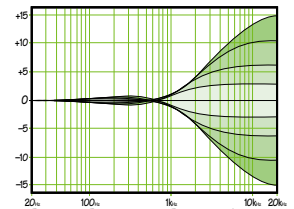

### 11. Low EQ

The low EQ provides up to 15 dB of boost or cut below 80 Hz. The circuit is flat at the center detent position. This frequency represents the punch in bass drums, bass guitar, fat synth patches, and some really serious male singers who eat raw beef for breakfast.

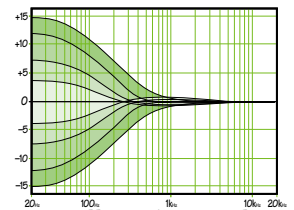

## 12. Aux Mon

These knobs tap a portion of each channel's signal to set up a nice monitor mix feeding stage monitors, independent of the main mix. Adjust these controls on each channel until the band is happy with the stage monitor mix.

The controls are off when fully turned down, deliver unity gain at the center detent, and can provide up to 15 dB of gain turned fully up.

The pan switch and channel level do not affect the monitor output, but the other channel controls will. The aux mon is pre-fader, so adjusting the channel's level control will not affect the aux mon output level.

The overall output level may be adjusted with the aux master mon knob and monitor's EQ tweaked with the graphic EQ if the main mix/mon switch is engaged. Internal FX may also be added to the monitor mix with the FX to mon knob.

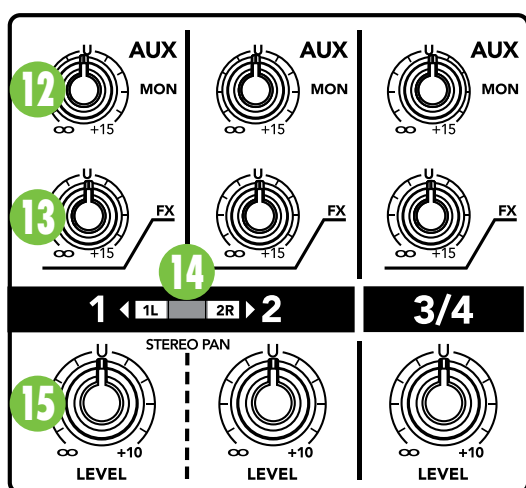

## 13. Aux FX

These knobs tap a portion of each channel's signal to set up a nice FX mix feeding the internal FX processor, and to feed external processors via the FX send.

The controls are off when fully turned down, deliver unity gain at the center detent, and can provide up to 15 dB of gain turned fully up.

The channel level and other channel controls affect the FX output, but the pan switch does not. The aux FX is post-fader.

The FX signal reaching the internal FX processor and the FX send output jack is the sum (mix) of all the channels whose aux FX control is set to more than minimum.

FX are added to the main mix by increasing the level of the FX to main knob. Internal FX may also be added to the monitor mix by increasing the level of the FX to mon knob.

## 14. Stereo Pan Switch (Ch. 1–2)

With this switch out, each mono channel feeds both the left and right sides of the main mix equally. For example:

- Playing a mono source: If you talk into a microphone connected to input 1, your sweet tones will be heard in both the left and right loudspeakers.
- Overdubbing a mono source: if you are monitoring directly through the headphones, you can hear the overdub signal in both ears while you are playing.

With this switch pressed in, channel 1 will play only in the left side of the main mix, and channel 2 will play in the right side. For example:

- Recording a stereo source: If you have a stereo microphone connected to the mic inputs, or if you are playing a stereo source into the line inputs, each side of the source can be recorded discretely onto a recorder connected to the main or tape outputs.

The pan switch does not affect channels 3 or 4, or the tape inputs.

## 15. Level

This is the last control in a channel's signal path, and it adjusts the level of each channel onto the main mix. The "U" mark indicates unity gain, meaning no increase or decrease of signal level. All the way up provides an additional 10 dB, should you need to boost a section of a song. If you find that the overall level is too quiet or too loud with the level near unity, check that the gain control is set correctly.

# Additional Inputs and Outputs

## 16. Mon Send

Stage monitors allow the talented musicians in the band to hear themselves clearly on stage. This can be a good thing! The monitor mix may be carefully adjusted in level using the aux mon controls. These tap a portion of each channel's signal to provide a 1/4" TRS output here to feed external stage monitors. These could either be passive stage monitors powered by an external amplifier, or powered stage monitors with their own built-in amplifier.

The monitor signal is the sum (mix) of all the channels whose aux mon control is set to more than minimum. If they want “more me and less Brian,” you may turn up their channel's aux mon control, and turn down Brian's.

The overall output level may be adjusted with the aux master mon knob and mon 1 may have its EQ tweaked with the graphic EQ if the main mix/mon switch is engaged. Alternatively, you could add an external graphic EQ between this output and your powered monitors. This will allow you to adjust the EQ, and minimize the chance of feedback from nearby microphones.

The monitor output is not affected by the main mix fader or the channel faders. This allows you to set up the monitor mix and level just right, and not have it change when a channel fader or the main mix fader is adjusted. This is known as “pre-fader.”

## 17. FX Send

This 1/4" TRS line-level output may be used to feed an external effects processor (FX), such as a nice sound effect, or delay unit. The output from this jack is an exact copy of what goes into the internal FX processor, being the careful mix of all channels whose aux FX control is turned to more than minimum.

(The processed output of the internal FX does not come out of this output, but is added internally to the main mix or monitor mix.)

The output is “post-fader,” so any changes to the channel faders will also affect the level going to the external processor.

The processed output from the effects processor is usually returned to a spare channel or the tape input, and you may carefully mix the original unprocessed channel (dry) and the processed channel (wet). Altering the original channel fader increases both the wet and dry signals and keeps them at the same delicate ratio. For example, the reverb remains at the same level relative to the original.

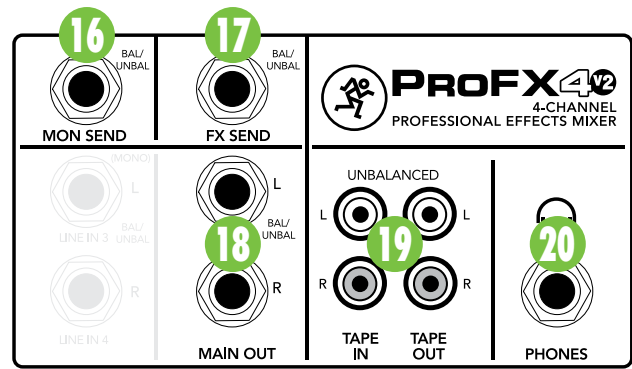

## 18. Main Out L/R

The 1/4" TRS output connectors provide balanced or unbalanced line-level signals. Connect these to the next device in the signal chain like an external processor (compressor/limiter), or directly to the inputs of the main amplifier or powered speakers.

## 19. Tape Inputs / Outputs

The stereo unbalanced RCA inputs allow you to play a CD player, MP3 player, or other line-level source. The tape in jacks accept an unbalanced signal using standard hi-fi hookup cables.

The stereo unbalanced RCA outputs allow you to record the main stereo mix onto a hard disk recorder or automatic CD burner, for example. This lets you make a recording for posterity/archive/legal purposes whenever the band gets back together again.

The tape output is the stereo main mix, and it is not affected by the main mix knob. The output could also be used as an extra set of main outputs for feeding another zone.

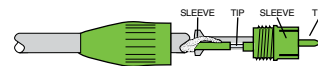

## 20. Phones

This 1/4" TRS connector supplies the output to stereo headphones. It is the same signal that is routed to the main and tape outputs. The phones volume is controlled with the phones knob.

The phones output follows standard conventions:

- Tip = Left channel
- Ring = Right channel
- Sleeve = Common ground



**WARNING:** The headphone amp is loud and can cause permanent hearing damage. Even intermediate levels may be painfully loud with some headphones. BE CAREFUL! Always turn the phones level control all the way down before connecting headphones or doing anything new that may affect the headphone volume. Then turn it up slowly as you listen carefully.

# Stereo Graphic EQ and Main Meters

## 21. Power LED

This LED will illuminate green when the mixer is turned on, as a reminder of how on it really is. If it is not on, then it is off, and the mixer becomes a rather nice weight for keeping your morning newspaper from blowing away in the wind.

If it does not turn on, make sure the AC adaptor is correctly inserted at both ends, the local AC mains supply is active, and the power switch is on.

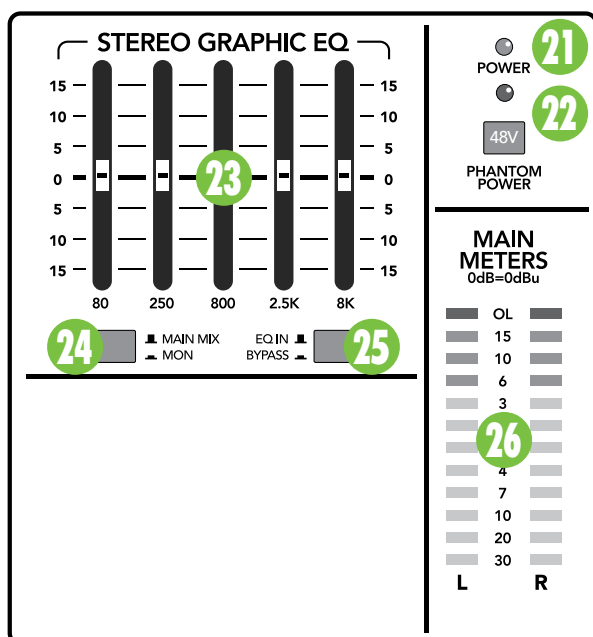

## 22. 48V Phantom Power Switch

Most modern professional condenser mics require 48V phantom power, which lets the mixer send low-current DC voltage to the mic's electronics through the same wires that carry audio. (Semi-pro condenser mics often have batteries to accomplish the same thing.) "Phantom" owes its name to an ability to be "unseen" by dynamic mics (Shure SM57/SM58, for instance), which don't need external power and aren't affected by it anyway.

Press this switch in if your microphone requires phantom power. (Always check the position of this switch before connecting microphones.) The accompanying LED will illuminate red to indicate that phantom power is active. This is a global switch that affects all mic channels' XLR jacks at once.



Never plug single-ended (unbalanced) microphones, or ribbon mics into the mic input jacks if phantom power is on. Do not plug instrument outputs into the mic XLR input jacks with phantom power on, unless you know for certain it is safe to do so. Be sure the main mix fader is turned down when connecting microphones to the mic inputs when phantom power is turned on, to prevent pops from getting through to the speakers.

## 23. Stereo Graphic EQ

This 5-band graphic equalizer adjusts the main mix output. It affects the line-level outputs, but not the headphones or tape outputs. This EQ may be used for a monitor mix instead of the main mix if the main mix/mon 1 switch is engaged. It may also be quickly bypassed using the EQ in/bypass switch.

Each slider allows you to adjust the level of its frequency band, with up to 15 dB of boost or cut, and no change in level at the center (0 dB) position. The frequency bands are: 80 Hz, 250 Hz, 800 Hz, 2.5 kHz and 8 kHz.

The EQ section comes before the main mix level and meters. As with the channel EQ, just take it easy. There is a large amount of adjustment, and if you are not careful, you can upset the delicate balance of nature. Although it may not seem cool to actually turn down controls, with EQ it is often the best option. Turn down the offending frequency range rather than boosting the desired range. You may use it to reduce the level of some frequency bands where feedback occurs.

## 24. Main Mix / Mon Switch

This switch allows you to choose if the stereo graphic EQ is used for the stereo left and right main mix or if it is used for monitors. For example, there may be times when the graphic EQ may be used wisely in the monitor mix to reduce feedback in the monitors from nearby microphones.

## 25. EQ In / Bypass Switch

This switch allows you to quickly engage or disengage the stereo graphic EQ. This may be used for quick checks of your EQ settings, or to shorten the signal path if you do not need to use the EQ.

## 26. Main Meters

These peak meters are made up of two columns of twelve LEDs, with three colors to indicate different ranges of signal level, traffic light style. They range from -30 at the bottom, to 0 in the middle, to +20 (OL) at the top.

When 0 dBu (0.775 V) is at the main left and right TRS outputs, it shows as 0 dB on the meters.

You can get a good mix with peaks flashing anywhere between -20 and +10 dB on the meters. Most amplifiers clip at about +10 dBu, and some recorders aren't so forgiving either. For best real-world results, try to keep your peaks between "0" and "+6." Remember, audio meters are just tools to help assure you that your levels are "in the ballpark." You don't have to stare at them (unless you want to).

## Internal FX

### 27. Preset Selector

Rotate this endless control to select one of the 16 preset effects. When the rotation stops, that preset will be loaded and become operational. The current preset number is shown in the display. The different presets are shown in the table below and on the mixer's silkscreen below the stereo graphic EQ. Further details of each preset are explained in Appendix C on page 22. Only one preset may be selected at a time.

1	Bright Room	9	Chorus
2	Warm Lounge	10	Chorus + Reverb
3	Small Stage	11	Doubler
4	Warm Theater	12	Echo
5	Warm Hall	13	Delay 1 (Fast)
6	Concert Hall	14	Delay 2 (Medium)
7	Plate Reverb	15	Delay 3 (Slow)
8	Cathedral	16	Pan Delay

### 28. Preset Display

This display shows the number of the currently selected effects preset, as shown in the list of presets above. Rotate the preset selector knob right or left to change a preset.

A new preset will be loaded approximately 1/4 of a second after you stop turning the knob, and it will be stored into the FX memory after about one second. When the mixer is turned on, the FX section will load up the last-used preset.

### 29. Int FX Mute Switch and LED

When engaged, the internal effects processor is muted, and its output will not appear on the main mix or monitor mix. The adjacent mute LED will illuminate as a reminder that the effects are muted. When power is first applied, this LED will illuminate and the FX will be muted for about 10 seconds while the little FX gerbils inside settle down.

If this switch is not engaged, then the internal effects are set free and may be added as required to the main mix and/or monitor mix.

### 30. Internal FX

These knobs route the effects output to the mon and mains independently. Use the mon control to provide effects to monitors. Slowly add effects to the monitors by turning the mon knob clockwise. Use the aux master to monitor the amount sent. The FX output to the mains will be heard directly from the PA.

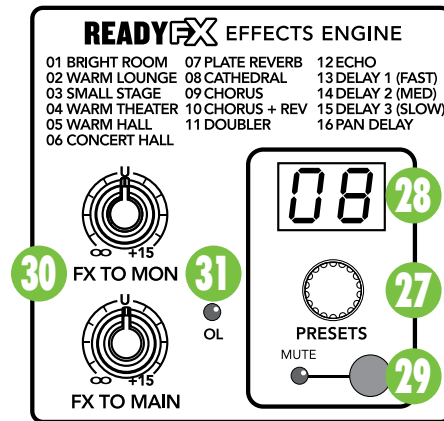

### 31. OL LED

This LED illuminates red if the effects processor is overloaded with too strong of a signal. Turn down the FX send master level and check the channel sends if this lights regularly.

The signals going into the processor are affected by the channel gain and channel levels, as well as the channel FX sends.

## Phones, Mon, Tape and Main Mix

### 32. Phones

As one might expect, this knob controls the level of the headphones. Make sure that this knob is fully off [counter-clockwise] when adding a new source.



**WARNING:** The headphone amp is loud and can cause permanent hearing damage. Even intermediate levels may be painfully

loud with some headphones. **BE CAREFUL!**

Always turn the phones level control all the way down before connecting headphones or doing anything new that may affect the headphone volume. Then turn it up slowly as you listen carefully.

### 33. Aux Mon Master

This knob provides overall control over the aux mon levels just before they are delivered to the aux mon send output.

Auxiliary is usually the control you turn up when the lead singer glares at you, points at his stage monitor, and sticks his thumb up in the air. (It would follow that if the singer stuck his thumb down, you'd turn the knob down, but that never happens.)

### 34. Tape Level

This knob controls the input level of signals entering the tape inputs.

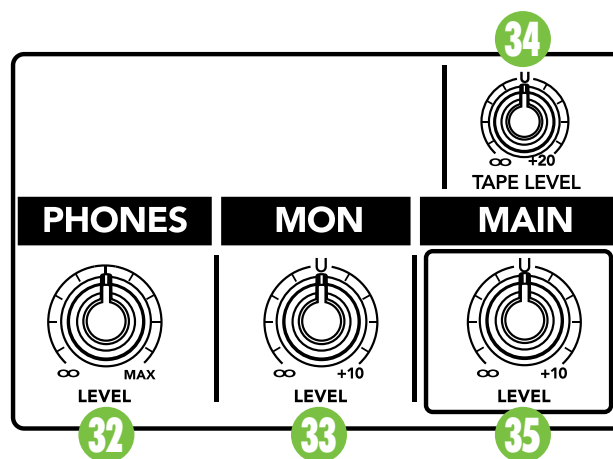

### 35. Main Mix

This knob allows you to adjust the levels of the main mix signals sent to the main outputs.

This gives you the ultimate feeling of power and control over the sound levels sent to your audience. Adjust this control carefully, with your good eye on the meters to check against overloading, and your good ear to the levels to make sure your audience (if any) is happy.

The main mix signals are off with the knob fully counter-clockwise, the “U” marking is unity gain, and fully clockwise provides 10 dB of additional gain. This additional gain will typically never be needed, but once again, it’s nice to know that it’s there. The knob is stereo, as it affects both the left and right of the main mix equally. This is the ideal control to slowly bring down at the end of a song (or quickly in the middle of a song if the need ever arises).

This control does not affect the mon send, FX send or tape outputs.

# Appendix A: Service Information

If you think your mixer has a problem, please check out the following troubleshooting tips and do your best to confirm the problem. Visit the Support section of our website ([www.720trees.com](http://www.720trees.com)) where you will find lots of useful information such as FAQs, documentation and any updated PC drivers etc. You may find the answer to the problem without having to send your mixer away.

## Troubleshooting

### Bad Channel

- Is the channel gain set correctly?
- Is the channel level up enough?
- Try the same source signal in another channel, set up exactly like the suspect channel.
- Is phantom power required for your microphone?

### Bad Output

- Is the main level turned up?
- Unplug anything from the other line-level outputs, such as monitor out, just in case one of the external pieces has a problem.
- Make sure that you are not overdriving the amplifiers. Check the loudspeaker average load impedance is not less than the minimum the amplifier can handle. Check the speaker wiring.

### Noise

- Turn the channel gains down, one by one. If the sound disappears, it's either that channel or whatever is plugged into it, so unplug whatever that is. If the noise disappears, it's from your whatever.

### Power

- The power LED should come on if the mixer is connected to a suitable live AC mains outlet, and the power switch is on. Check to make sure that the AC adaptor is securely plugged in.

## Repair

For warranty service, refer to the warranty information on page 23.

Non-warranty service is available at a factory-authorized service center. To locate your nearest service center, visit [www.720trees.com](http://www.720trees.com), click "Support" and select "Locate a Service Center." Service for ProFX4v2 mixers living outside the United States can be obtained through local dealers or distributors.

If you do not have access to our website, you can call our Tech Support department at 1-800-898-3211, Monday-Friday during normal business hours, Pacific Time, to explain the problem. Tech Support will tell you where the nearest factory-authorized service center is located in your area.



# Appendix B: Technical Information

## Specifications

### Noise Characteristics

Equivalent Input Noise (EIN) (150 Ω Source Impedance, 20 Hz to 20 kHz)	
Mic in to FX send, max gain	-128 dBu
Residual Output Noise ≤30 kHz	
All outputs, master levels off, all channel levels off	-95 dBu
All outputs, master levels unity, one channel level unity	-85 dBu

### Frequency Response

Mic input to any output (gain at unity, +0 dB / -1 dB)	
	20 Hz to 40 kHz

### Distortion (THD+N)

(22 Hz to 80 kHz bandwidth)	
Mic in to Main Out (+4 dBu output)	<0.01%

### Attenuation and Crosstalk

Adjacent Inputs @ 1 kHz	-80 dB
Inputs to Outputs @ 1 kHz	-80 dB
Fader Off @ 1 kHz	-80 dB

### Common Mode Rejection Ratio (CMRR)

Mic in to Main out, max gain, 1 kHz	70 dB
-------------------------------------	-------

### Maximum Levels

All inputs	+22 dBu
1/4" Main Mix	+22 dBu
All other outputs	+22 dBu

### Impedances

Mic in	3.8 kΩ
All other inputs	≥20 kΩ
Tape out	1 kΩ
Phones out	25 Ω
All other outputs	120 Ω Unbalanced, 240 Ω Balanced

### Equalization

Low	±15 dB @ 80 Hz
High	±15 dB @ 12 kHz
Low Cut Filter	18 dB/octave @ 100 Hz

### Maximum Voltage Gain (EQ Flat)

Mic Input Channel to	
Insert Output	50 dB
Tape Output	60 dB
1/4" Main Output	70 dB
Monitor Send	76 dB
FX Send	75 dB
Mono Line Input Channel to	
Tape Output	40 dB
Monitor Send	56 dB
FX Send	55 dB
Stereo Line Input Channel to	
Tape Output	30 dB
Monitor Send	46 dB
FX Send	45 dB
Tape Input to	
Main Output	30 dB
USB Input to	
Main Output	30 dB

### Digital Effects

I/O	Mono Input, Stereo Output
Number of Presets	16

### Meters

Main L/R Mix	
Two columns of 12 segments each:	
OL (+20 dBu), +15, +10, +6, +3, 0 (0 dBu),	
-2, -4, -7, -10, -20, -30	

### Graphic EQ

Frequency Centers	80, 250, 800, 2.5k, 8k
Gain	±15 dB
Assignable to Main or Monitor, bypassable	

## Specifications continued...

### Phantom Power

---

48 VDC to all Mic channels simultaneously

### Power Requirements

---

Class I Hard-Wired Wall Wart 12VDC @ 1.5A

### Physical Dimensions and Weight

---

Height	2.9 in / 73 mm
Width	8.7 in / 220 mm
Depth	10.1 in / 256 mm
Weight	3.2 lb / 1.4 kg

### Options

---

Bag P/N 2036809-29

LOUD Technologies Inc. is always striving to improve our products by incorporating new and improved materials, components, and manufacturing methods. Therefore, we reserve the right to change these specifications at any time without notice.

The "Running Man" is a registered trademark of LOUD Technologies Inc. All other brand names mentioned are trademarks or registered trademarks of their respective holders, and are hereby acknowledged.

Please check our website for any updates to this manual:  
[www.720trees.com](http://www.720trees.com).

©2015 LOUD Technologies Inc. All Rights Reserved.

# ProFX4v2 Dimensions

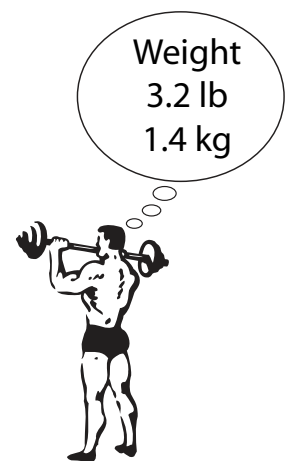
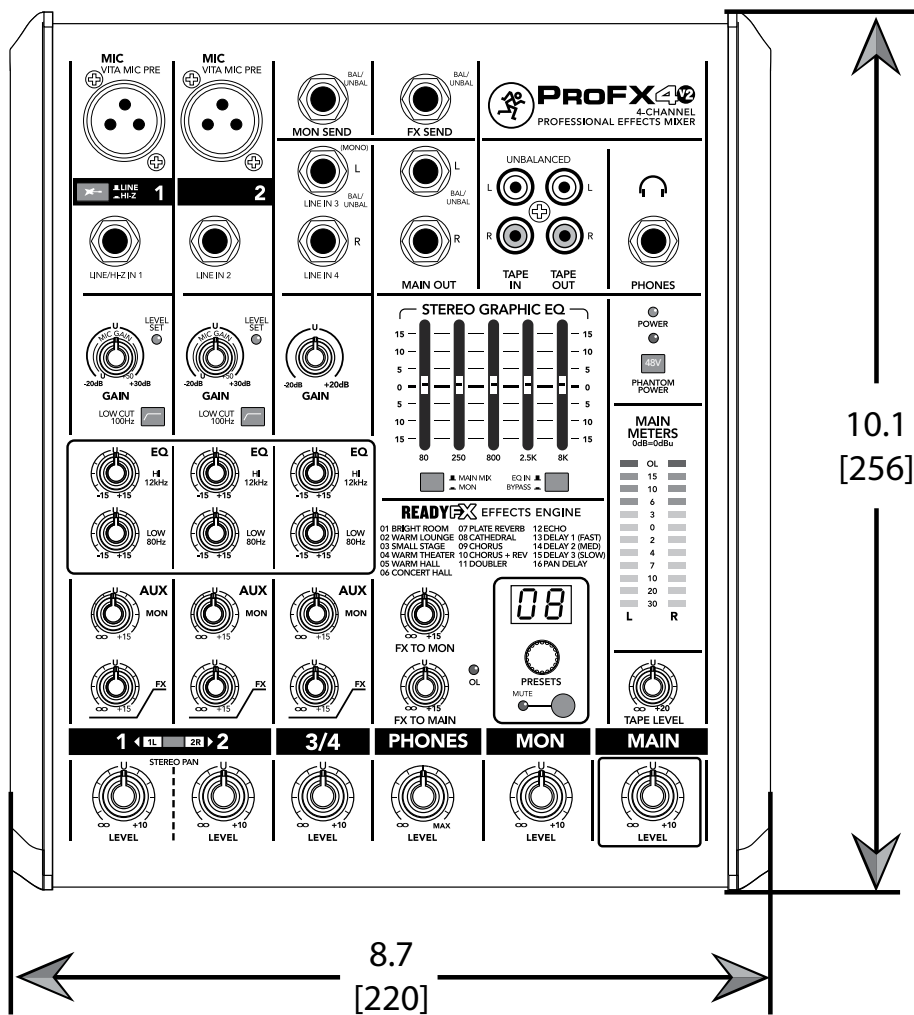
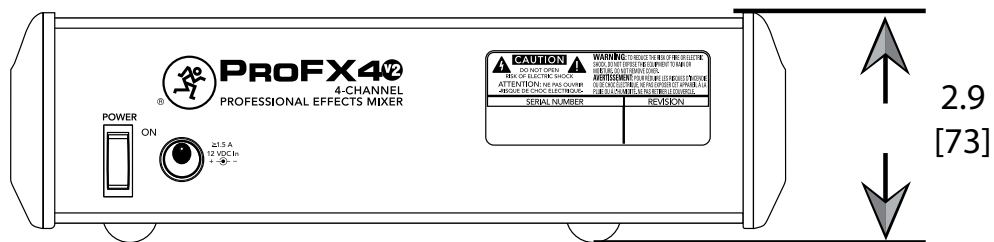

# ProFX4v2 Block Diagram

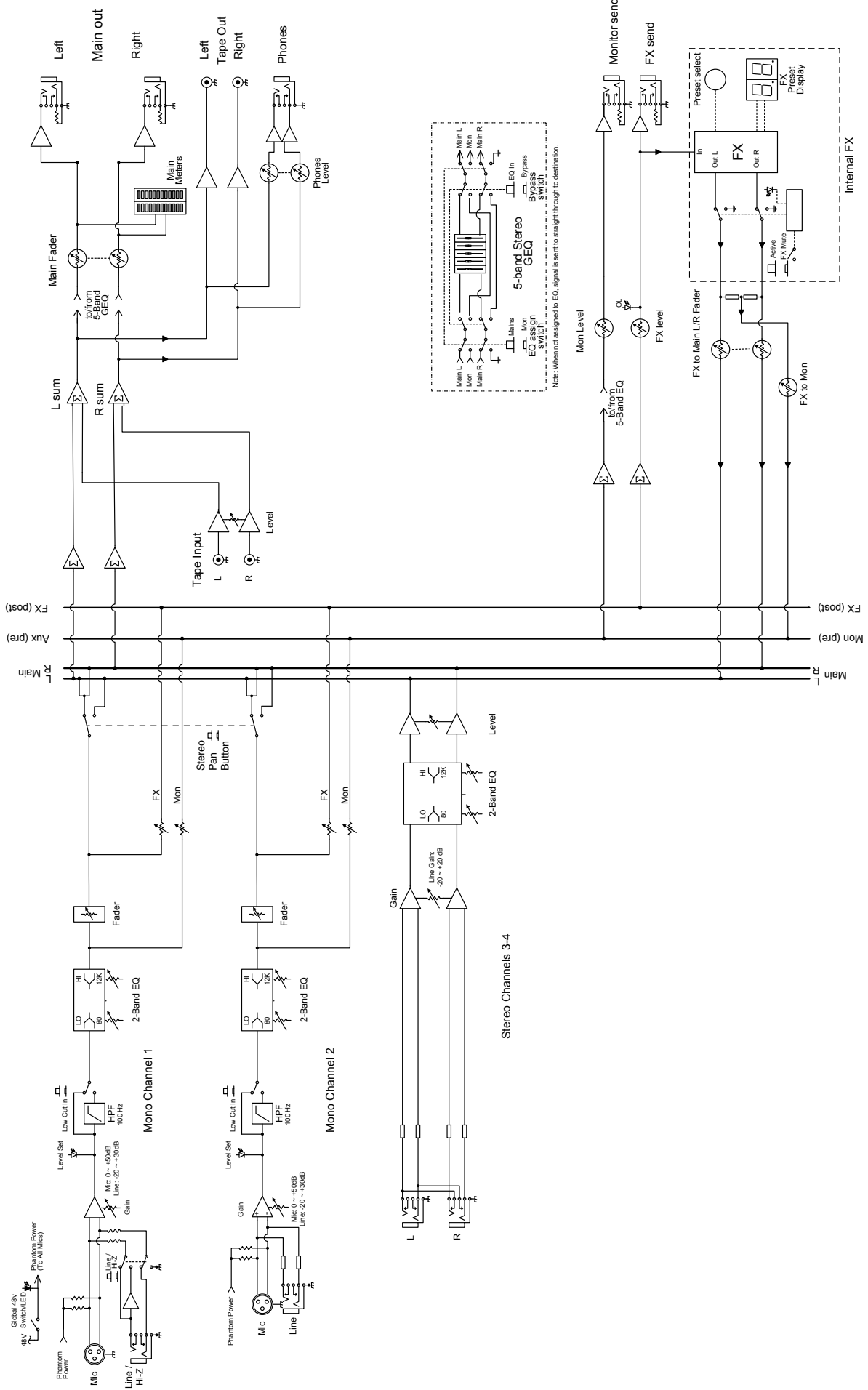

**MIC**  
VITA MIC PRE

**MIC**  
VITA MIC PRE

BAL/  
UNBAL

**MON SEND**

BAL/  
UNBAL

**FX SEND**

**PROFX4v2**  
4-CHANNEL  
PROFESSIONAL EFFECTS MIXER

LINE/Hi-Z IN 1

LINE IN 2

(MONO)  
L

BAL/  
UNBAL

LINE IN 3

R

LINE IN 4

UNBALANCED

L

R

**TAPE IN**

**PHONES**

U

MIC GAIN

LEVEL SET

-20dB +50 +30dB

**GAIN**

LOW CUT 100Hz

U

MIC GAIN

LEVEL SET

-20dB +50 +30dB

**GAIN**

LOW CUT 100Hz

U

GAIN

-20dB +20dB

**STEREO GRAPHIC EQ**

80 250 800 2.5K 8K

EQ IN BYPASS

POWER

48V

PHANTOM POWER

**EQ**

U

HI 12kHz

-15 +15

U

LOW 80Hz

-15 +15

**EQ**

U

HI 12kHz

-15 +15

U

LOW 80Hz

-15 +15

**EQ**

U

HI 12kHz

-15 +15

U

LOW 80Hz

-15 +15

U

AUX

MON

∞ +15

U

AUX

MON

∞ +15

U

AUX

MON

∞ +15

U

FX TO MON

∞ +15

U

FX TO MAIN

∞ +15

PRESETS

MUTE

**1** ← 1L → 2R → **2**

**3/4**

**PHONES**

**MON**

**MAIN**

STEREO PAN

U

LEVEL

∞ +10

U

LEVEL

∞ +10

U

LEVEL

∞ +10

U

LEVEL

∞ MAX

U

LEVEL

∞ +10

U

LEVEL

∞ +10

**READYFX EFFECTS ENGINE**

01 BRIGHT ROOM	07 PLATE REVERB	12 ECHO
02 WARM LOUNGE	08 CATHEDRAL	13 DELAY 1 (FAST)
03 SMALL STAGE	09 CHORUS	14 DELAY 2 (MED)
04 WARM THEATER	10 CHORUS + REV	15 DELAY 3 (SLOW)
05 WARM HALL	11 DOUBLER	16 PAN DELAY
06 CONCERT HALL		

**MAIN METERS**  
0dB=0dBu

OL	█
15	█
10	█
6	█
3	█
0	█
2	█
4	█
7	█
10	█
20	█
30	█

L R

TAPE LEVEL

U

∞ +20

# Appendix C: Table of Effects Presets

No.	Title	Description	Example of its use
01	Bright Room	This room has a bright tone with lots of scattered reflections to simulate harder, more reflective surfaces.	Useful on vocals that require a brighter reverb to cut through the mix, or for giving acoustic instruments a livelier vibe.
02	Warm Lounge	This preset features a medium sized room sound, with just enough enhancement of the lower mids to produce a warm tone.	Useful for vocals on songs that require a larger, more "wet" sound, or for giving dimension to bright horns without adding harshness.
03	Small Stage	This preset simulates the sound of a small concert stage, with a medium reverb time and reverberant space.	Useful for vocals or guitars in fast paced, high-energy songs that call for a "live" sounding reverberation.
04	Warm Theater	This reverb has a warm bodied tone and medium long reverb time to simulate the live acoustics of a theater space.	Perfect for vocals, drums, acoustic and electric guitars, keyboards and more.
05	Warm Hall	This reverb simulates the sound of a spacious, yet cozy, heavily draped and carpeted concert hall with an especially warm tone.	Perfect for adding natural concert hall ambience to close-mic'ed orchestral instruments.
06	Concert Hall	This hall reverb is characterized by its large, spacious sound, long pre-delay, and vibrant tone.	Adds life to acoustic instruments and vocals from solos to full-on symphonies and choirs.
07	Plate Reverb	This preset emulates vintage mechanical reverberation that was generated with a metal plate. Its sound is characterized by lots of early reflections and no pre-delay.	Perfect for thickening percussive instruments, such as a snare drum, or tight vocal arrangements.
08	Cathedral	This reverb emulates the extremely long tails, dense diffusion and long pre-delays and reflections that would be found in a very large, stone walled house of worship.	Gives amazing depth to choirs, wind instruments, organs and soft acoustic guitars.
09	Chorus	This preset provides a soft, ethereal sweeping effect that is useful for thickening and for making a particular sound pop out of the mix.	Perfect for enhancement of electric and acoustic guitar and bass, or to add a dramatic effect to vocals, particularly group harmonies and choirs.
10	Chorus + Reverb	This preset perfectly combines the chorus effect above with a large, roomy reverb.	This effect thickens the sound with chorus while adding warmth and spaciousness thanks to the smooth reverb.
11	Doubler	This effect simulates the sound of a vocal or instrument being recorded twice (double-tracked) on a multi-track recorder.	Provides a vibe that is similar to chorus without the subtle swirl.
12	Echo	A single-repeat echo, not as fast as the Doubler. This effect provides a single, relatively rapid delay of the original signal, with the added warmth that vintage tape-based echo units provided.	Also known as Slap Back Echo, use it to make a vocal or guitar stand out in the mix without extra volume.
13 14 15	DLY 1 (Fast) DLY 2 (Med) DLY 3 (Slow)	These three presets provide delay with delay times of fast, medium and slow.	These work best with full, up-beat music like rock where the delay needs to cut through the mix.
16	Pan Delay	This fast delay bounces signal back 'n' forth from Left to Right and back again. Overall decay time is shorter than DLY 1-3.	This works best in a stereo mix.

# ProFX4v2 Series Limited Warranty

## Please keep your sales receipt in a safe place.

This Limited Product Warranty ("Product Warranty") is provided by LOUD Technologies Inc. ("LOUD") and is applicable to products purchased in the United States or Canada through a LOUD-authorized reseller or dealer. The Product Warranty will not extend to anyone other than the original purchaser of the product (hereinafter, "Customer," "you" or "your").

For products purchased outside the U.S. or Canada, please visit [www.720trees.com/warranty](http://www.720trees.com/warranty) to find contact information for your local distributor, and information on any warranty coverage provided by the distributor in your local market.

LOUD warrants to Customer that the product will be free from defects in materials and workmanship under normal use during the Warranty Period. If the product fails to conform to the warranty then LOUD or its authorized service representative will at its option, either repair or replace any such nonconforming product, provided that Customer gives notice of the noncompliance within the Warranty Period to the Company at: [www.720trees.com/support](http://www.720trees.com/support) or by calling LOUD technical support at 1.800.898.3211 (toll-free in the U.S. and Canada) during normal business hours Pacific Time, excluding weekends or LOUD holidays. Please retain the original dated sales receipt as evidence of the date of purchase. You will need it to obtain any warranty service.

For full terms and conditions, as well as the specific duration of the Warranty for this product, please visit [www.720trees.com/warranty](http://www.720trees.com/warranty).

The Product Warranty, together with your invoice or receipt, and the terms and conditions located at [www.720trees.com/warranty](http://www.720trees.com/warranty) constitutes the entire agreement, and supersedes any and all prior agreements between LOUD and Customer related to the subject matter hereof. No amendment, modification or waiver of any of the provisions of this Product Warranty will be valid unless set forth in a written instrument signed by the party to be bound thereby.

## Need help with your mixer?

- **Visit [www.720trees.com](http://www.720trees.com) and click Support to find: FAQs, manuals, addendums, and other useful information.**
- **Email us at: [techmail@loudtechinc.com](mailto:techmail@loudtechinc.com).**
- **Telephone 1-800-898-3211 to speak with one of our splendid technical support chaps (Monday through Friday, normal business hours, Pacific Time).**



---

**16220 Wood-Red Road NE**  
**Woodinville, WA 98072 • USA**  
**Phone: 425.487.4333**  
**Toll-free: 800.898.3211**  
**Fax: 425.487.4337**  
**[www.720trees.com](http://www.720trees.com)**

---