

# Load Trail LLC

## WARNING

This User's Manual contains safety information and instructions for your trailer.

You must read this manual before loading or towing your trailer.

You must follow all safety precautions and instructions.

## DEALER

Please place a  
dealership business  
card in this box.

**LOAD TRAIL**



Like us on Facebook





## **AN INDUSTRY BEST FROM A MANUFACTURER YOU CAN COUNT ON...**

Load Trail is proud to be home to the best trailer warranty on the market. Our 232 Protection plan is standard on all Load Trail Trailers and includes coverage above and beyond most other trailer warranties. The details are:

**\*2 years comprehensive coverage** - This comprehensive coverage will protect you from manufacturing defects on every single component on the trailer.

**\*3 years structural warranty on the entire trailer** -If used according to guidelines we guarantee our trailer to be structurally free from manufacturing defects for three years.

**\*2 years road side assistance** - This protection will give you the peace of mind to hit the road any time with a 24/7 roadside assistance hotline that will cover your trailer and your tow vehicle anywhere in the United States & Canada for personal or business use.

Roadside Assistance Covers:

- \* Towing / Road Service for both tow vehicle and trailer
- \* Vehicle Fluid Delivery (includes fuel, hydraulic fluid, etc...)
- \* Flat Tire Changes
- \* Jump Starts (dead battery service)
- \* Lock-out-service
- \* On and Off-Road Coverage
- \* Both Commercial & Consumer use

24 Hour Roadside Assistance Hotline

1-877-211-8138

We are confident in our product and have the warranty to prove it.

See page 6 for full warranty details.

Table of Contents

An Industry Best from a Manufacturer You Can Count On

<b>1</b>	<b>INTRODUCTION AND WARRANTY .....</b>	<b>5</b>
1.1	Introduction.....	5
1.2	Warranty.....	6
<b>2</b>	<b>GENERAL SAFETY INFORMATION .....</b>	<b>10</b>
2.1	Safety Alert Symbols and Signal Words.....	10
2.2	Major Hazards .....	10
	Improper Sizing of the Trailer to the Tow Vehicle .....	11
	Driving Too Fast .....	11
	Failure to Adjust Driving Behavior When Towing a Trailer.....	11
	Trailer Not Properly Coupled to the Hitch .....	12
	Proper Use of Safety Chains .....	13
	Proper Connection of Breakaway Brake.....	13
	Matching Trailer and Hitch.....	14
	Worn Tires, Loose Wheels and Lug Nuts .....	14
	Improper Loading.....	16
	Unsafe Load Distribution .....	16
	Shifting Cargo.....	17
	Inappropriate Cargo.....	18
	Inoperable Brakes or Lights.....	18
	Trailer Modifications.....	19
	Hazards For Dump Trailers .....	19
	Hazards For Tilt Deck Trailers .....	20
	Hazards from Accessories.....	21
	Safety Warning Labels on Your Trailer .....	22
	Safe Trailer Towing Guidelines.....	32
	Reporting Safety Defects.....	33
<b>3</b>	<b>TIRE SAFETY INFORMATION.....</b>	<b>34</b>
3.1	Trailer Tire Information .....	34
3.2	Steps for Determining Correct Load Limit – Trailer .....	35
	Trailers 10,000 Pounds GVWR or Less.....	36
	Trailers Over 10,000 Pounds GVWR.....	36
3.3	Steps for Determining Correct Load Limit – Tow Vehicle .....	37
3.4	Glossary Of Tire Terminology.....	37
3.5	Tire Safety - Everything Rides On It .....	41
	Safety First–Basic Tire Maintenance .....	42
	Finding Your Vehicle's Recommended Tire Pressure and Load Limits .....	42
	Understanding Tire Pressure and Load Limits.....	42
	Checking Tire Pressure .....	43
	Steps for Maintaining Proper Tire Pressure.....	43
	Tire Size .....	44
	Tire Tread .....	44
	Tire Balance and Wheel Alignment.....	44
	Tire Repair.....	44
	Tire Fundamentals.....	45
	3.5.1.1 Information on Passenger Vehicle Tires .....	45
	3.5.1.2 UTQGS Information .....	47

Table of Contents

3.5.1.3	Additional Information on Light Truck Tires .....	47
	Tire Safety Tips .....	48
<b>4</b>	<b>COUPLING TO THE TOW VEHICLE .....</b>	<b>50</b>
4.1	Use an Adequate Tow Vehicle and Hitch.....	50
	Trailer Information .....	50
	Tow Vehicle.....	51
4.2	Coupling and Uncoupling the Trailer .....	52
	Various Coupler Designs.....	53
4.3	Bumper Pull Trailers .....	54
	Trailer with Ball Hitch Coupler .....	54
4.3.1.1	Before Coupling The Trailer To The Tow Vehicle .....	55
4.3.1.2	Prepare The Coupler And Hitch.....	56
4.3.1.3	Couple The Trailer To The Tow Vehicle .....	56
	Trailer with Ring and Pintle Coupler.....	57
4.3.1.4	Before Coupling The Trailer To The Tow Vehicle.....	57
4.3.1.5	Prepare The Ring and Pintle .....	58
4.3.1.6	Couple The Trailer To The Tow Vehicle .....	59
	Connect Safety Chains – Bumper Pull Trailer .....	59
	Connect The Electrical Cable – Bumper Pull Trailers.....	60
	Attach Breakaway Brake Lanyard – Bumper Pull Trailers.....	61
4.3.1.7	Test Electric Brakes.....	61
4.3.1.8	Test Electric Breakaway Brakes .....	62
4.3.1.9	Test Surge Brakes (If equipped).....	63
4.3.1.10	Test Surge Brake Breakaway System .....	65
	Uncoupling A Bumper Pull Trailer .....	65
4.4	Gooseneck Trailer With Ball Receiver .....	66
	Before Coupling The Trailer To The Tow Vehicle .....	67
	Prepare The Ball And Receiver .....	68
	Couple The Trailer To The Tow Vehicle.....	69
	Connect The Safety Chains .....	69
	Connect The Electrical Cable .....	70
	Attach Breakaway Brake Lanyard .....	71
4.4.1.1	Test Electric Brakes.....	72
4.4.1.2	Test Electric Breakaway Brakes .....	72
	Uncoupling Gooseneck Trailer With Ball Coupler .....	73
4.5	Tongue Weight.....	75
	Checking Tongue Weight .....	76
4.6	Adjust Bumper Pull Trailer Hitch Height .....	77
4.7	Adjust Gooseneck Coupler Height .....	78
<b>5</b>	<b>LOADING AND UNLOADING A DUMP TRAILER .....</b>	<b>80</b>
5.1	Hazards For Dump Trailers.....	80
5.2	Ramp Weights .....	82
5.3	Loading Fixed Loads.....	82
	Rear Loading Equipment.....	83
	6' HD Hydraulic Ramp Gate .....	86
5.3.1.1	Towing Operation .....	87
5.3.1.2	Ramp Operation .....	87
5.3.1.3	Spreader Gate Operation .....	88

Table of Contents

Side Loading Palletized Material.....	89
<b>5.4 Loading and Unloading Bulk Materials .....</b>	<b>90</b>
Prepare Trailer For Loading.....	90
Loading Bulk Material .....	91
Unload Bulk Material Using The Spreader Gate .....	92
Unload Bulk Material Using The Swing Gates .....	97
<b>5.5 Hydraulic Components .....</b>	<b>103</b>
<b>5.6 Body Prop.....</b>	<b>103</b>
<b>5.7 Securing The Cargo .....</b>	<b>105</b>
<b>6 LOADING AND UNLOADING A FLATBED TRAILER .....</b>	<b>106</b>
6.1 Ramp and Gate Weights .....	107
6.2 Ramp Options .....	108
Fold Down Ramps .....	108
Mesh Ramp .....	110
Removable Ramps .....	112
6.3 Distributing The Cargo.....	112
Preparing the Trailer for Loading .....	112
Loading a Rigid-Deck Trailer .....	113
Loading the SB Series Tilt Deck Trailer .....	115
Loading the TD Series Tilt Deck Trailer .....	117
Center Pop-Up Deck.....	119
Hydraulic Dovetail Operation (If equipped) .....	120
Hydraulic Tilt Deck Operation .....	124
<b>7 PRE-TOW CHECK LIST .....</b>	<b>127</b>
7.1 Pre-Tow Checklist .....	127
7.2 Make Regular Stops.....	127
<b>8 BREAKING-IN A NEW TRAILER .....</b>	<b>128</b>
8.1 Retighten Lug Nuts at First 10, 25 & 50 Miles .....	128
8.2 Adjust Brake Shoes at First 200 Miles.....	128
8.3 Synchronizing the Brake Systems.....	128
<b>9 ACCESSORIES.....</b>	<b>129</b>
9.1 Accessory Battery .....	129
KTI Single Acting Power Unit.....	131
KTI Double Acting Power Unit .....	132
KTI Triple Acting Power Unit (Power Up/Power Down/Gravity Down) .....	133
KTI Dual Double Acting Power Unit (4 Button Remote).....	134
Battery Cables .....	135
KTI Trouble Shooting Quick Reference Guide.....	135
Wireless Remote Instruction.....	136
ONBOARD BATTERY CHARGER & TESTER.....	137
<b>10 INSPECTION, SERVICE &amp; MAINTENANCE .....</b>	<b>138</b>
10.1 Inspection, Service & Maintenance Summary Charts .....	138
10.2 Inspection and Service Instructions.....	140
Axle Bolts, Frame, Suspension, & Structure.....	140

*Table of Contents*

Trailer Structure .....	141
10.2.1.1 Fasteners and Frame Members .....	141
10.2.1.2 Welds .....	141
Trailer Brakes - Electric .....	142
10.2.1.3 Brake Shoes and Drums .....	142
10.2.1.4 Manually Adjusting Brake Shoes .....	142
10.2.1.5 Brakes, Electric .....	142
10.2.1.6 Tow Vehicle Operated Electric Brakes .....	143
10.2.1.7 Magnets for all Electric Brakes .....	143
Trailer Brakes – Surge (If equipped) .....	143
10.2.1.8 Surge Brake Master Cylinder .....	143
10.2.1.9 Hydraulic Surge Brake .....	144
10.2.1.10 Master Cylinder Bleeding .....	144
Trailer Connection to Tow Vehicle .....	145
10.2.1.11 Bumper Pull Coupler and Ball .....	145
10.2.1.12 Ring and Pintle .....	146
10.2.1.13 Gooseneck Ball Receiver .....	146
Landing Leg or Jack .....	147
Lights and Signals .....	147
Wheel Rims .....	147
Tires .....	147
Dexter Axle Identification .....	150
Dexter Maintenance Schedule .....	151
Wheel Bearings .....	152
Lubrication .....	152
10.2.1.14 Dump Trailers .....	153
10.2.1.15 Tilt Deck Trailers .....	156
Hydraulic Reservoir .....	156
Lug Nuts .....	157
Wheel Torque Requirements .....	158
Hydraulic Dove Tail Adjustment .....	160
Trailer Storage Preparation .....	161
After Prolonged Trailer Storage Inspection Procedure .....	162
10.3 Electrical Connector Wiring Diagrams .....	163

# 1 INTRODUCTION AND WARRANTY

## 1.1 INTRODUCTION

Congratulations on the purchase of your new trailer! We believe you will be happy and completely satisfied with your purchase. Our #1 goal is to provide a valued customer a quality trailer at a reasonable price.

For your safety, we ask you to study this manual carefully before operating your trailer. If there are any questions about information in this manual, please consult your dealer.

When calling about your trailer, please have the VIN number available for the dealer. The VIN number can be found on the neck of a bumper pull or under the riser on a gooseneck.

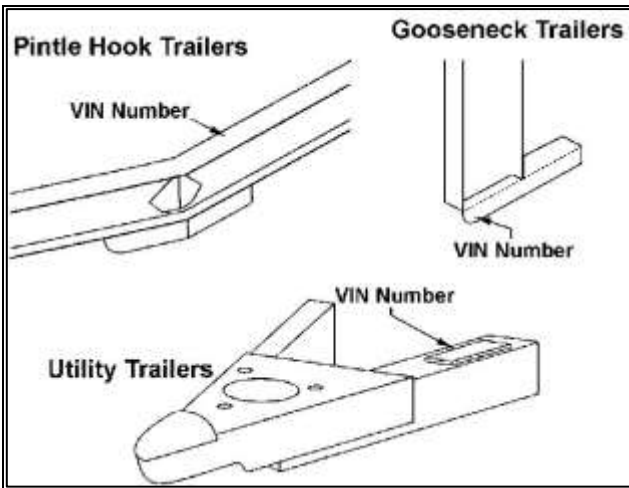

*VIN Number Locations*

For future reference, please write your VIN number in the space below:

---

This manual covers the basic trailer. Read this manual before using your trailer and follow all of the safety instructions. Therefore, you must read, understand and follow the instructions given by the trailer manufacturer, tow vehicle and trailer hitch manufacturers, as well as the instructions in this manual. Keep all manuals provided with your trailer in a safe place at all times.

Our trailers are built with components produced by various manufacturers. Some of these items have separate instruction manuals. Where this manual indicates that you should read another manual, and you do not have that manual, contact your dealer for assistance.

Inserts providing information on axles and tire warranty are provided with this manual. Please keep these inserts for future reference.

## 1.2 WARRANTY

### WARRANTY TERMS

Subject to the exclusions and limitations below, LOAD TRAIL LLC (hereinafter "Load Trail") warrant each new trailer Load Trail manufactures ("Product") to be free from defects in material and workmanship, operated under normal use and service in the continental United States and Canada . The trailer warranted hereunder must be operated by the purchaser in accordance with practice approved by Load Trail, with loads not exceeding the manufacture's rated capacities and subject to all terms and conditions of this Limited Warranty. The warranty start date is one year from date of shipment to the dealer or end user purchase date, whichever comes first. During the Limited Warranty period, any defect in material and workmanship on any product not excluded below shall be repaired or replaced at Load Trail's option by a Load Trail authorized representative or approved repair facility only. Load Trail will pay for replacement parts and such approved shop labor in accordance with Load Trail's labor reimbursement policy outlined below. Load Trail reserves the right to supply remanufactured replacement parts as it deems appropriate. Load Trail reserves the right, in lieu of the repair and replacement obligations set forth in this Limited Warranty, to refund the purchase price for the Product. Such right shall be exercised in Load Trail's sole discretion. If Load Trail elects to refund the purchase price, you agree to deliver to Load Trail the Product prior to receipt of such refund. This Limited Warranty is your exclusive remedy, and applies to new Product only purchased in the United States and Canada which is accompanied by this written Limited Warranty and for which a completed warranty registration card has been received by Load Trail within 30 days after purchase of the Product.

### WARRANTY COVERAGE

#### Three Year Structural - Limited Warranty

The Load Trail Limited Warranty warrants the structure to be free of defects in material and workmanship, under normal use and service for a period of three (3) years after the warranty start date. This (3) year Limited Warranty is on the structure only and is limited to the main frame, ramp, cross members, railings and sub-frame ONLY.

#### Two Year Comprehensive - Limited Warranty

The Load Trail Limited Warranty warrants every component to be free of defects in material and workmanship, under normal use and service for a period of two (2) years after the warranty start date.

#### Non Load Trail Components

Items not of Load Trail manufacture including but not limited to the chassis, crane, welder, hydraulic and tool drawer packages, and electronic components (which are the responsibility of the components manufacturer). Load Trail will act responsibly to facilitate the repair or replacement of such parts by such component's manufacturer. Costs incurred by Load Trail for repair or replacement parts or items not of Load Trail's manufacture will be invoiced to you.

To be considered warranty, the failed part must be returned, at the discretion of Load Trail, to Load Trail or the manufacturer of the part within thirty (30) calendar days. The part will be evaluated and if warranty is approved by the manufacturer, a credit or replacement part may be issued to the customer. If the failed part is not



---

## Introduction And Warranty

---

returned to Load Trail or the manufacturer of the part within thirty (30) calendar days, the customer will be charged the full price of all replacement parts plus applicable shipping costs.

### Parts Warranty

Parts replaced in the warranty period will be subject to the balance of this two (2) year Limited Warranty, but replacement will not in any way extend this Limited Warranty. Replacement parts after the warranty period shall be subject to Load Trail's then standard parts warranty.

Standard part purchases made through the Load Trail Parts Department are not covered under the Limited Warranty associated with a trailer purchase. A part purchased through the Load Trail Parts Department shall only be covered by the warranty offered by the manufacture of said parts.

### Load Trail's Labor Reimbursement Policy

Load Trail will, in its sole discretion consider labor reimbursement during the defined warranty period provided that the repair is pre-approved. Labor amounts will be determined from the flat rate shop manual or authorized contract rate. It is your responsibility to contact the Warranty Department to verify your labor rate. All warranty work must be pre-authorized by Load Trails Warranty Department. Failure to do so will result in no warranty payment or replacement of parts.

### Shipping Costs

Load Trail will pay for shipping of warranty parts by ground carrier. Expedited freight delivery is available at the expense of the owner. Shipping for the return of parts for warranty consideration will be at the owner's expense but will be reimbursed if the parts in question are deemed defective by Load Trail or by the manufacturer of the part and legible copy of the invoice is provided.

### Retail Purchaser Responsibility

This Limited Warranty requires that you provide both required and recommended maintenance and repair and obtain periodic inspections of the Product (including bodies and accessories) as indicated in the Operator's Manual furnished with each Product or otherwise specified by Load Trail in writing. The cost of required recommended maintenance and repair and obtain periodic inspections is solely your responsibility. You are required to keep documented evidence that these services were performed. The Load Trail's Limited warranty may be subject to cancellation if the above requirements are not performed.

### Exclusions

This Limited warranty shall not apply to:

1. Any defect in the Product which was caused (in Load Trail's sole judgment) by other than normal use and service of the body or accessory or by any of the following:
  - Accidents including but not limited to collision
  - Improper operation, abnormal usage, misuse or negligence
  - Overloading
  - Failure to provide routine maintenance and repair service and failure to provide any other reasonable and proper maintenance and repair
  - Improper repair or installation
  - Unsuitable storage

## Introduction And Warranty

---

- Repairs, alterations or modification including the installation of accessories, not made or installed by Load Trail or authorized representative or approved repair facility.
  - Accidents, chemicals, acts of God, and any other acts which are not the fault of Load Trail
  - Vandalism
2. Any Product (including anybody or accessory) whose identification numbers or marks have been altered or removed.
  3. Any component of the Product (including body or accessory) which any of the required or recommended periodic inspection or services have been performed using parts not manufactured or supplied by Load Trail meeting Load Trail specification or installed as specified by Load Trail.
  4. Products (including bodies or accessories) for which you have failed to deliver the warranty registration card to Load Trail with in thirty (30) days from the date of delivery of the Product.
  5. Any defect which was caused (in Load Trail's sole judgment) by operation of the body or accessory not abiding by standard operating procedures outlined in the Operators Manual.
  6. Transportation costs, if any, of transporting the Product or any component to an approved repair facility.
  7. Diagnostic and overtime premiums.
  8. Depreciation caused by normal wear, lack of reasonable maintenance, failure to follow operating instructions, misuse, or lack of proper protection during storage.
  9. Any installation of a Product on chassis other than original factory installation.
  10. Damage to paint resulting from deterioration due to wear or exposure, misuse, chipping, scratching, deterioration or damage from road elements, such as magnesium chloride (liquid salt), sand, improper wash solvents, and / or weather conditions. Paint carries a 2 year pro-rated warranty.
  11. Damage caused by loose nuts, bolts or screws including improperly torqued wheel lug nuts.
  12. Any trailer utilized as a rental unit or as part of a rental combination with rental equipment.
  13. Warped lumber, faded lumber and cracking of flooring 180 days from date of manufacture.
  14. Parts and accessories which are not defective but may wear out and have to be replaced during the warranty period, including, but not limited to normal wear items, light bulbs, paint, brake lining, brake drums, tires, decking and the like.

## Introduction And Warranty

---

### Limitation of Warranties

Except for the warranties expressly and specifically made herein, Load Trail makes no other warranties, and any possible liability of Load Trail hereinafter is in lieu of all other warranties, expressed, implied, or statutory including but not limited to any warranties of merchantability or fitness for particular purpose. Load Trail reserves the right to modify, alter, and improve any product previously sold without incurring any obligation to replace any product previously sold without such modification. No person is authorized to give any other warranty or assume any additional obligation on Load Trail's behalf.

This repair, replacement, or refund as provided under the Limited Warranty is your exclusive remedy, and is provided in lieu of all other warranties, expressed or implied, in no event shall Load Trail be liable, whether in contract or tort (including negligence) for damages in excess of the purchase price of the product, accessory or software, or any indirect incidental, special or consequential damages of any kind, or loss of revenue or profits, loss of business, loss of information or data, software or applications or other financial loss arising out of or in connection with the ability or inability to use the products, to the full extent these damages may be disclaimed by law.

### Disputes Under This Limited Warranty

Any and all disputes and claims of any kind and nature whatsoever arising under this Limited Warranty shall be handled as provided in any agreement of purchase and sale for the Product.

If such agreement does not include an express provision relating to the handling of disputes and claims, then the following terms shall apply to this Limited Warranty: This Limited Warranty shall be deemed to have been made in the State of Texas (without regard to the conflict of law principals of the *State*), including all matters of construction, validity and performance regardless of the location of the Product. You expressly waive any and all right to jury trial regarding any dispute hereunder. You hereby irrevocably submit to the exclusive jurisdiction and venue of courts sitting in Lamar County, Texas, You hereby irrevocably waive, and hereby agree not to assert by way or motion, defense, or otherwise, any claim that you are not subject personally to the jurisdiction of such courts, that the Product or any other property of yours is exempt or immune from attachment or execution, that any action brought under this Limited Warranty is brought in an inconvenient forum, that the venue of the action is improper or that this Limited Warranty cannot be enforced by any such courts.

## 2 GENERAL SAFETY INFORMATION

### 2.1 SAFETY ALERT SYMBOLS AND SIGNAL WORDS

An Owner's Manual that provides general trailer information cannot cover all of the specific details necessary for the proper combination of every trailer, tow vehicle and hitch. Therefore, you must read, understand and follow the instructions given by the tow vehicle and trailer hitch manufacturers, as well as the instructions in this manual.

Our trailers are built with components produced by various manufacturers. Some of these items have separate instruction manuals. Where this manual indicates that you should read another manual, and you do not have that manual, contact your dealer for assistance.

The safety information in this manual is denoted by the safety alert symbol:  The level of risk is indicated by the following signal words.

#### DANGER

**DANGER** – Immediate hazards which **WILL** result in severe personal injury or death if the warning is ignored.

#### WARNING

**WARNING** – Hazards or unsafe practices which **COULD** result in severe personal injury or death if the warning is ignored.

#### CAUTION

**CAUTION** – Hazards or unsafe practices which could result in minor or moderate injury if the warning is ignored.

#### NOTICE

**NOTICE** – Practices that could result in damage to the trailer or other property.

### 2.2 MAJOR HAZARDS

Loss of control of the trailer or trailer/tow vehicle combination can result in death or serious injury. The most common causes for loss of control of the trailer are:

- Improper sizing the trailer for the tow vehicle, or vice versa.
- Excessive Speed: Driving too fast for the conditions.
- Failure to adjust driving behavior when towing a trailer.
- Overloading and/or improper weight distribution.

## General Safety Information

---

- Improper or mis-coupling of the trailer to the hitch.
- Improper braking and steering under sway conditions.
- Not maintaining proper tire pressure.
- Not keeping lug nuts tight.

### **IMPROPER SIZING OF THE TRAILER TO THE TOW VEHICLE**

Trailers that weigh too much for the towing vehicle can cause stability problems, which can lead to death or serious injury. Furthermore, the additional strain put on the engine and drive-train may lead to serious tow vehicle maintenance problems. For these reasons the maximum towing capacity of your towing vehicle should not be exceeded. The towing capacity of your tow vehicle, in terms of maximum Gross Trailer Weight (GTW) and maximum Gross Combined Weight Rating (GCWR) can be found in the tow vehicle Owner's Manual.

### **⚠ DANGER**

**Use of an under-rated hitch, ball or tow vehicle can result in loss of control leading to death or serious injury.**

**Make certain your hitch and tow vehicle are rated for your trailer.**

### **DRIVING TOO FAST**

With ideal road conditions, the maximum recommended speed for safely towing a trailer is 60 mph. If you drive too fast, the trailer is more likely to sway, thus increasing the possibility for loss of control. Also your tires may overheat, thus increasing the possibility of a blowout.

### **⚠ WARNING**

**Driving too fast for conditions can result in loss of control and cause death or serious injury.**

**Adjust speed down when towing trailer.**

### **FAILURE TO ADJUST DRIVING BEHAVIOR WHEN TOWING A TRAILER**

When towing a trailer, you will have decreased acceleration, increased stopping distance, and increased turning radius (which means you must make wider turns to keep from hitting curbs, vehicles, and anything else that is on the inside corner). Furthermore the trailer will change the handling characteristics of your towing vehicle, making it more sensitive to steering inputs and more likely to be pushed around in windy conditions or when being passed by large vehicles. In addition, you will need a longer distance to pass, due to slower acceleration and increased length. With this in mind:

- Be alert for slippery conditions. You are more likely to be affected by slippery road surfaces when driving a tow vehicle with a trailer, than driving a tow vehicle without a trailer.

## General Safety Information

---

- Anticipate the trailer “swaying.” Swaying can be caused by excessive steering, wind gusts, roadway edges, or by the trailer reaction to the pressure wave created by passing trucks and busses.
- When encountering trailer sway take your foot off the accelerator, and steer as little as possible in order to stay on the road. Use small “trim-like” steering adjustments. Do not attempt to steer out of the sway; you’ll only make it worse. Also do not apply the tow vehicle brakes to correct trailer swaying. On the other hand, application of the trailer brakes alone will tend to straighten out the combination, especially when going downhill.
- Check rearview mirrors frequently to observe the trailer and traffic.
- Use lower gear when driving down steep or long grades. Use the engine and transmission as a brake. Do not ride the brakes, as they can overheat and become ineffective.
- Be aware of your trailer height, especially when approaching bridges, roofed areas and around trees.

### **TRAILER NOT PROPERLY COUPLED TO THE HITCH**

It is critical that the trailer be securely coupled to the hitch, and that the safety chains and emergency breakaway brake lanyard are correctly attached. Uncoupling may result in death or serious injury to you and to others.

#### **WARNING**

**Proper selection and condition of the coupler and hitch are essential to safely towing your trailer. A loss of coupling may result in death or serious injury.**

- **Be sure the hitch load rating is equal to or greater than the load rating of the coupler.**
- **Be sure the hitch size matches the coupler size.**
- **Observe the hitch for wear, corrosion and cracks before coupling. Replace worn, corroded or cracked hitch components before coupling the trailer to the tow vehicle.**
- **Be sure the hitch components are tight before coupling the trailer to the tow vehicle.**

**⚠ WARNING**

**An improperly coupled trailer can result in death or serious injury.**

**Do not move the trailer until:**

- **The coupler is secured and locked to hitch;**
- **The safety chains are secured to the tow vehicle; and**
- **The trailer jack(s) are fully retracted.**

**Do not tow the trailer on the road until:**

- **Tires and wheels are checked;**
- **The trailer brakes are checked;**
- **The breakaway switch is connected to the tow vehicle;**
- **The load is secured to the trailer; and**
- **The trailer lights are connected and checked.**

**PROPER USE OF SAFETY CHAINS**

If your trailer comes loose from the hitch for any reason, we have provided safety chains so that control of the trailer can still be maintained.

**⚠ WARNING**

**Improper rigging of the safety chains can result in loss of control of the trailer and tow vehicle, leading to death or serious injury, if the trailer uncouples from the tow vehicle.**

- **Fasten chains to frame of tow vehicle. Do not fasten chains to any part of the hitch unless the hitch has holes or loops specifically for that purpose.**
- **Cross chains underneath hitch and coupler with enough slack to permit turning and to hold tongue up, if the trailer comes loose.**

**PROPER CONNECTION OF BREAKAWAY BRAKE**

If equipped with brakes, your trailer will be equipped with a breakaway brake system that can apply the brakes on your trailer if your trailer comes loose from the hitch for any reason. You will have a separate set of instructions for the breakaway brake if your trailer is so equipped. The breakaway brake system, including battery, must be in good condition and properly rigged to be effective.

**⚠ WARNING**

**An ineffective or inoperative breakaway brake system can result in a runaway trailer, leading to death or serious injury if the coupler or hitch fails.**

**The breakaway lanyard must be connected to the tow vehicle, and NOT to any part of the hitch.**

**Before towing the trailer, test the function of the breakaway brake system. If the breakaway brake system is not working, do not tow the trailer. Have it serviced or repaired.**

**MATCHING TRAILER AND HITCH**

**⚠ DANGER**

**Use of a hitch with a load rating less than the load rating of the trailer can result in loss of control and may lead to death or serious injury.**

**Use of a tow vehicle with a towing capacity less than the load rating of the trailer can result in loss of control, and may lead to death or serious injury.**

**Be sure your hitch and tow vehicle are rated for the Gross Vehicle Weight Rating (GVWR) of your trailer.**

**WORN TIRES, LOOSE WHEELS AND LUG NUTS**

Just as with your tow vehicle, the trailer tires and wheels are important safety items. Therefore, it is essential to inspect the trailer tires before each tow.

If a tire has a bald spot, bulge, cut, cracks, or is showing any cords, replace the tire before towing. If a tire has uneven tread wear, take the trailer to a dealer service center for diagnosis. Uneven tread wear can be caused by tire imbalance, axle misalignment or incorrect inflation.

Tires with too little tread will not provide adequate frictional forces on wet roadways and can result in loss of control, leading to death or serious injury.

Improper tire pressure causes increased tire wear and may reduce trailer stability, which can result in a tire blowout or possible loss of control. Therefore, before each tow you must also check the tire pressure. Remember, the proper tire pressure is listed on the Certification / VIN label, normally mounted on the front left side of the trailer, and should be checked when tires are cold. Allow 3 hours cool-down after driving as much as 1 mile at 40 mph before checking tire pressure.



**⚠ WARNING**

**Improper tire pressure may cause unstable trailer. Blowout and loss of control may occur. Death or serious injury can result.**

**Make sure of proper tire pressure before towing trailer. Inflate tires to pressure stated on the Certification / VIN label.**

The tightness of the lug nuts is very important in keeping the wheels properly seated to the hub. Before each tow, check to make sure they are tight.

**⚠ WARNING**

**Metal creep between the wheel rim and lug nuts (bolts) may cause rim to loosen.**

**Death or injury can occur if wheel comes off.**

**Tighten lug nuts (bolts) before each tow.**

The proper tightness (torque) for lug nuts and tightening sequence is listed in the Inspection, Service and Maintenance section of this manual. Use a torque wrench to tighten the lug nuts and use the crisscross star pattern sequence. Improper tightening of the lug nuts voids the axle warranty.

Lug nuts are also prone to loosen after first being assembled. When driving a new trailer (or after wheels have been remounted), check to make sure they are tight after the **first** 10, 25 and 50 miles of driving and before each tow thereafter.

Failure to perform this check can result in a wheel separating from the trailer and a crash, leading to death or serious injury.

**⚠ WARNING**

**Lug nuts are prone to loosen after being first assembled. Death or serious injury can result.**

**Check lug nuts for tightness on a new trailer, and after re-mounting a wheel at 10, 25 and 50 miles.**

**⚠ WARNING**

**Inadequate lug nut torque can cause a wheel to separate from the trailer, leading to death or serious injury.**

**Be sure lug nuts are tight before each tow.**

**IMPROPER LOADING**

The total weight of the load you put on the trailer, plus the empty weight of the trailer itself, must not exceed the trailer's Gross Vehicle Weight Rating (GVWR). If you do not know the empty weight of the trailer plus the cargo weight, you must weigh the loaded trailer at a commercial scale. In addition, you must distribute the load in the trailer such that the load on any axle does not exceed the Gross Axle Weight Rating (GAWR). If your trailer is equipped with a Tire & Loading Information Placard, mounted next to the Certification / VIN label, the cargo capacity weight stated on that placard is only a close estimate. The GVWR and GAWR are listed on the Certification / VIN label mounted on the front left side of the trailer.

**⚠ WARNING**

**An overloaded trailer can result in failure or in loss of control of the trailer, leading to death or serious injury.**

**Never load a trailer so that the weight on any tire exceeds its rating.**

**Never exceed the trailer Gross Vehicle Weight Rating (GVWR).**

**Never exceed an axle Gross Axle Weight Rating (GAWR).**

**UNSAFE LOAD DISTRIBUTION**

Improper front / rear load distribution can lead to an unstable trailer or poor tow vehicle handling. Poor trailer stability results from tongue weights that are too low, and poor tow vehicle stability results from tongue weights that are too high. Refer to the appropriate "Loading the Trailer" section for more information.

In the following table, the second column shows the rule of thumb percentage of total weight of the trailer plus its cargo (Gross Trailer Weight, or "GTW") that should appear on the tongue of the trailer. For example, a trailer with a gooseneck hitch, with a loaded weight of 12,000 pounds, should have 20-25% of 12,000 pounds (2400-3000 lbs.) on the gooseneck.

A dump trailer will have the proper weight distribution if the load is **evenly distributed** in the dump body. For non-flowable (discrete) loads locate the load such as to provide the proper tongue weight. After loading, be sure to check that none of the axles are overloaded.

## General Safety Information

### Tongue Weight as a Percentage of Loaded Trailer Weight

Type of Hitch	Percentage
Ball Hitch (or Bumper Hitch)	10-15% for large trailers 6-10% for smaller utility trailers
Gooseneck	20-25%

Uneven left / right load distribution can cause tire, wheel, axle or structural failure. Be sure your trailer is evenly loaded left / right. Towing stability also depends on keeping the center of gravity as low as possible.

### **WARNING**

**Improper tongue weight (load distribution) can result in loss of control of the trailer, leading to death or serious injury.**

**Make certain that tongue weight is within the allowable range.**

**Be sure to:**

- **Distribute the load front-to-rear to provide proper tongue weight (see chart). For dump trailers, a flowable load should be evenly distributed throughout the body.**
- **Distribute the load evenly, right and left.**
- **Keep the center of gravity low.**

### **SHIFTING CARGO**

Since the trailer “ride” can be bumpy and rough, you must secure your cargo so that it does not shift while the trailer is being towed.

### **WARNING**

**A shifting load can result in failure, or to loss of control of the trailer, and can lead to death or serious injury.**

**You must tie down all loads with proper sized fasteners, ropes, straps, etc. to prevent the load from shifting while traveling.**

If the door latch is equipped with a catch that has a hole for a linchpin, use a linchpin to prevent the door latch from opening.

**⚠ WARNING**

**If the door opens, your cargo may be ejected onto the road, resulting in death or serious injury to other drivers.**

**Always secure the door latch after closing. Place a linchpin in the catch.**

**INAPPROPRIATE CARGO**

Your trailer may be designed for specific cargo. If your trailer is designed for specific cargo, only carry that cargo in the trailer. A trailer must not be used to carry certain items, such as people, containers of hazardous substances or containers of flammable substances.

**⚠ WARNING**

**Never transport people inside or on your trailer. Besides putting their lives at risk, the transport of people in a trailer is illegal.**

**⚠ WARNING**

**Do not transport flammable, explosive, poisonous or other dangerous materials in your trailer.**

- **The exception is fuel in the tank of a vehicle or equipment being hauled.**

**INOPERABLE BRAKES OR LIGHTS**

Be sure that the electric brakes and all of the lights on your trailer are functioning properly before towing your trailer. Electric brakes and lights on a trailer are controlled via a connection to the tow vehicle, generally a multi-pin electrical connector. Check the trailer tail lights by turning on your tow vehicle headlights. Check the trailer brake lights by having someone step on the tow vehicle brake pedal while you look at trailer lights. Do the same thing to check the turn signal lights.

If your trailer has electric brakes, your tow vehicle will have an electric brake controller that sends power to the trailer brakes. Before towing the trailer on the road, you must operate the brake controller while trying to pull the trailer in order to confirm that the electric brakes operate. While towing the trailer at less than 5 mph, manually operate the electric brake controller in the tow vehicle cab. You should feel the operation of the trailer brakes.

If your trailer has hydraulic “surge” brakes, pull the emergency breakaway brake lanyard to check the operation of the surge mechanism.

**⚠ WARNING**

**Improper electrical connection between the tow vehicle and the trailer will result in inoperable lights and electric brakes, and can lead to collision.**

**Before each tow:**

- **Check that all lights and turn signals work.**
- **Check that the electric brakes work by operating the brake controller inside the tow vehicle.**

Standard mirrors usually do not provide adequate visibility for viewing traffic to the sides and rear a towed trailer. You must provide mirrors that allow you to safely observe approaching traffic.

**TRAILER MODIFICATIONS**

Alteration of the trailer structure or modification of your trailer can make the trailer unsafe and will void all warranty options.

**HAZARDS FOR DUMP TRAILERS**

A dump trailer is specifically designed for hauling cargo that is to be dumped. A dump trailer is not designed for transporting livestock. The major hazards associated with dump trailers are:

- Overloading.
- Improper weight distribution; both side to side and front to back.
- Getting under a raised dump body.
- Not using, or improperly using the body prop.
- Modifying or altering hydraulic components.
- Modifying or altering dump controls.
- Not dumping from a solid and level foundation.
- Not fully opening rear doors when dumping.
- Jerking the trailer, or hydraulics, to loosen the load.
- Trailer contacting or coming near overhead power lines when body is raised.

**⚠ DANGER**

**NEVER alter or substitute any hydraulic system component. Death or serious injury may result.**

**An altered or component substituted hydraulic system may malfunction, resulting in the dump body falling without warning.**

**NEVER alter or substitute any hydraulic system component.**

**⚠ WARNING**

**A soft and/or uneven surface may cause the tow vehicle and trailer to tip over when the dump body is raised.**

**Raise the dump body ONLY if the tow vehicle and trailer are both on a firm and level surface.**

**⚠ WARNING**

**An overloaded trailer or improperly distributed load can result in death or serious injury.**

**An overloaded trailer can cause the hydraulic system to malfunction, resulting in the dump body falling.**

**A load that is improperly distributed in the trailer can result in the trailer tipping over when the dump body is raised.**

**⚠ WARNING**

**Risk of electrocution.**

- **Dump body coming near or contacting power lines can cause electrocution. Electrocution can occur without contact.**
- **Be sure there are no overhead power lines over or near the trailer before raising dump body.**

**HAZARDS FOR TILT DECK TRAILERS**

. The major hazards associated with tilt deck trailers are:

- Overloading.
- Improper weight distribution; both side to side and front to back.
- Getting under a raised tilt deck.
- Not using, or improperly using the safety prop.
- Modifying or altering hydraulic components.
- Modifying or altering the tilt deck controls.

**⚠ DANGER**

**NEVER alter or substitute any hydraulic system component. Death or serious injury may result.**

**An altered or component substituted hydraulic system may malfunction, resulting in the tilt deck falling without warning.**

**NEVER alter or substitute any hydraulic system component.**

**⚠ WARNING**

**An overloaded trailer or improperly distributed load can result in death or serious injury.**

**An overloaded trailer can cause the hydraulic system to malfunction, resulting in the dump body falling.**

**HAZARDS FROM ACCESSORIES**

The “Accessories” chapter of this manual contains some information about certain optional accessories that may be on your trailer. Read and follow all of these instructions before operating the accessories.

## General Safety Information

### SAFETY WARNING LABELS ON YOUR TRAILER



**! DANGER**



**AVOID SERIOUS INJURY OR DEATH!**

1. Stand clear of dump body when operating.
2. Do not allow others to stand near operating area or in an area where an upset load might fall.
3. Before dumping, make sure doors are open fully and securely latched to the sides of the dump bed.
4. Do not leave raised dump bed unattended.
5. Do not raise a loaded bed if trailer is on uneven ground.
6. Never get under dump bed unless safety prop is in position.
7. When not in use, store control switch inside toolbox.

060012B

*Dump Trailers – Both Sides Of Dump Body*



**! CAUTION**



**Watch hands  
and fingers while  
raising or lowering  
deck.**

080019B

*Tilt Deck Trailers – Both Sides*





*Tilt Deck Trailers – Near Latch*



*Trailers Equipped with Ramps*



*Trailers with Tilt Deck*

General Safety Information



*Trailers equipped with Hydraulic Valve*



*Manual Tilt Trailers – Near Latch Pin*



*Trailers equipped with Heavy Duty Gate/Ramps*

## General Safety Information

**⚠ WARNING ⚠**

Connecting the cylinder to a hydraulic system with more pressure(psi) and flow(gpm) than is recommended, can cause the cylinder to fail during the dumping of load. This could lead to damage, serious injury, or death. "Be sure" you have the correct pressure and flow. If you do not know the recommended pressure and flow, consult the trailer manufacturer.

Adjusting the hydraulic pressure to more than the recommended setting may cause the cylinder to fail during the dumping of the load. This could cause damage to the trailer, serious injury or death. Never adjust the pressure on your own. If the hydraulic pressure is in question consult the trailer manufacturer. Have only a qualified person set the hydraulic pressure.

Freeing a stuck load during dumping, with the body raised, by jerking or shocking the trailer, may cause damage to the trailer, serious injury, or death. Never drive forward or backward and stop quickly with the load up or otherwise shock the load. If a load is stuck in the body, lower the body, then free the load.

Being under a raised body can result in serious injury or death should the body unexpectedly descend. "Never" position yourself or allow others to position themselves under a "loaded" body. "Always" prop the "unloaded" body up using the body prop or body props supplied. "Remember" body props are to be used only on an "unloaded" body.

Attempting to dump a load on unlevel ground may cause the trailer to over turn, and can result in damage, serious injury or death. Always dump the load on ground that is level front to rear as well as level side to side.

080021

*Right Side, On Toolbox*

**⚠ CAUTION**



**Watch hands and fingers when opening and closing Pop-up.**

080011B

*Trailers Equipped With Pop-Up Rear Deck*



*Dump Trailers*



*Utility Trailers Equipped With Side Rails And Fenders*

# General Safety Information

<p><b>▲ WARNING</b></p> <p>Uncoupling will cause trailer to come loose. ALWAYS use proper technique to uncouple. NEVER use the BRAKE (HAND BRAKE) or BRAKE (PARKING BRAKE) while uncoupling. ALWAYS use proper technique to uncouple. ALWAYS use proper technique to uncouple. ALWAYS use proper technique to uncouple.</p> <ol style="list-style-type: none"> <li>1. LOCK brakes with pin or feedback.</li> </ol>	 <p>Sleeve hook Pin or feedback</p> <p>LR Coupler to attach</p>	<p><b>▲ WARNING</b></p> <p>ALWAYS use safety chains. Chains hold trailer if supportive link fails. Chains hold trailer if supportive link fails. Chains hold trailer if supportive link fails. Chains hold trailer if supportive link fails.</p> <ol style="list-style-type: none"> <li>1. CHOOSE chains underneath coupler.</li> <li>2. ALLOW slack for trailer to turn.</li> <li>3. ATTACH chain hooks securely to tow vehicle frame.</li> </ol>	 <p>ATTACH TO TOW VEHICLE FRAME</p> <p>ENOUGH SLACK FOR TURNING</p>	<p><b>▲ WARNING</b></p> <p>Trailer can roll if it is loaded down. Safety chains support when other hitch points break down. Safety chains support when other hitch points break down. Safety chains support when other hitch points break down.</p> <ol style="list-style-type: none"> <li>1. ATTACH to frame CHAIN with proper technique.</li> <li>2. CHOOSE trailer fluid level.</li> <li>3. CHOOSE correct fluid level if present fluid is NOT FULL.</li> </ol>	 <p>Back To Tow Vehicle Chain To Tow Vehicle Hitch Chain</p>
<p><b>▲ WARNING</b></p> <p>Always use proper technique when backing up for other vehicles. "Don't pull" or "Don't pull" trailer and tow vehicle. Disconnect towbar and tow vehicle. Disconnect towbar and tow vehicle. Disconnect towbar and tow vehicle.</p> <ol style="list-style-type: none"> <li>1. DISCONNECT towbar and tow vehicle.</li> <li>2. DISCONNECT towbar and tow vehicle.</li> <li>3. DO NOT TOW if lights are not working.</li> </ol>	 <p>DISCONNECTED CONNECTED</p>	<p><b>▲ WARNING</b></p> <p>The vehicle log rule has each link of control. Section below, you must CHECK. Section below, you must CHECK. Section below, you must CHECK.</p> <ol style="list-style-type: none"> <li>1. The pressure and load.</li> <li>2. Tire and pressure for damage.</li> <li>3. Log rule for new and unmounted wheels.</li> </ol> <p>For new and unmounted wheels, 10, 20 and 30 miles of driving.</p>	 <p>Log Rule TIGHT</p> <p>Time and pressure OK?</p>	<p><b>▲ WARNING</b></p> <p>Proper loading can cause trailer safety. Proper loading can cause trailer safety. Proper loading can cause trailer safety. Proper loading can cause trailer safety.</p> <ol style="list-style-type: none"> <li>1. Make certain weight of load plus trailer weight does not exceed trailer's rated capacity.</li> <li>2. Load evenly across tow bar.</li> <li>3. SECURE load to trailer.</li> </ol>	 <p>Secure load to trailer Back to Tow Vehicle Hitch Chain</p>

**Trailer W/ Surge Brakes**



<p><b>▲ WARNING</b></p> <p>Uncoupling will cause trailer to come loose. ALWAYS use proper technique to uncouple. NEVER use the BRAKE (HAND BRAKE) or BRAKE (PARKING BRAKE) while uncoupling. ALWAYS use proper technique to uncouple. ALWAYS use proper technique to uncouple.</p> <ol style="list-style-type: none"> <li>1. LOCK brakes with pin or feedback.</li> </ol>	 <p>Sleeve hook Pin or feedback</p> <p>LR Coupler to attach</p>	<p><b>▲ WARNING</b></p> <p>ALWAYS use safety chains. Chains hold trailer if supportive link fails. Chains hold trailer if supportive link fails. Chains hold trailer if supportive link fails.</p> <ol style="list-style-type: none"> <li>1. CHOOSE chains underneath coupler.</li> <li>2. ALLOW slack for trailer to turn.</li> <li>3. ATTACH chain hooks securely to tow vehicle frame.</li> </ol>	 <p>ATTACH TO TOW VEHICLE FRAME</p> <p>ENOUGH SLACK FOR TURNING</p>	<p><b>▲ WARNING</b></p> <p>Trailer can roll if it is loaded down. Safety chains support when other hitch points break down. Safety chains support when other hitch points break down. Safety chains support when other hitch points break down.</p> <ol style="list-style-type: none"> <li>1. ATTACH to frame CHAIN with proper technique.</li> <li>2. CHOOSE trailer fluid level.</li> <li>3. CHOOSE correct fluid level if present fluid is NOT FULL.</li> </ol>	 <p>Back To Tow Vehicle Chain To Tow Vehicle Hitch Chain</p>
<p><b>▲ WARNING</b></p> <p>Always use proper technique when backing up for other vehicles. "Don't pull" or "Don't pull" trailer and tow vehicle. Disconnect towbar and tow vehicle. Disconnect towbar and tow vehicle. Disconnect towbar and tow vehicle.</p> <ol style="list-style-type: none"> <li>1. DISCONNECT towbar and tow vehicle.</li> <li>2. DISCONNECT towbar and tow vehicle.</li> <li>3. DO NOT TOW if lights are not working.</li> </ol>	 <p>DISCONNECTED CONNECTED</p>	<p><b>▲ WARNING</b></p> <p>The vehicle log rule has each link of control. Section below, you must CHECK. Section below, you must CHECK. Section below, you must CHECK.</p> <ol style="list-style-type: none"> <li>1. The pressure and load.</li> <li>2. Tire and pressure for damage.</li> <li>3. Log rule for new and unmounted wheels.</li> </ol> <p>For new and unmounted wheels, 10, 20 and 30 miles of driving.</p>	 <p>Log Rule TIGHT</p> <p>Time and pressure OK?</p>	<p><b>▲ WARNING</b></p> <p>Proper loading can cause trailer safety. Proper loading can cause trailer safety. Proper loading can cause trailer safety. Proper loading can cause trailer safety.</p> <ol style="list-style-type: none"> <li>1. Make certain weight of load plus trailer weight does not exceed trailer's rated capacity.</li> <li>2. Load evenly across tow bar.</li> <li>3. SECURE load to trailer.</li> </ol>	 <p>Secure load to trailer Back to Tow Vehicle Hitch Chain</p>

**Trailer W/ Electric Brakes**







Bumper Pull Trailers – Left Side Of Tongue

# General Safety Information

<p><b>WARNING</b></p> <p>Improper loading can cause trailer sway and sudden loss of control. You must:</p> <ul style="list-style-type: none"> <li>• Make certain weight of load plus trailer weight does not exceed trailer's capacity (GVWR-Gross Vehicle Weight Rating)</li> <li>• Load heavier items in front of wheels.</li> <li>• Load evenly side to side.</li> <li>• SECURE load to trailer.</li> </ul>		<p><b>WARNING</b></p> <p>Uncoupling will cause trailer to come loose from tow vehicle.</p> <ol style="list-style-type: none"> <li>1. CHECK that pin's <b>LOAD RATING</b> is same or greater than <b>ring LOAD RATING</b>.</li> <li>2. <b>LOCK</b> the clamp in place using a pin or lock.</li> </ol>	
<p><b>WARNING</b></p> <p>ALWAYS use safety chains. Chains hold trailer if connection fails. You must:</p> <ol style="list-style-type: none"> <li>1. <b>CROSS</b> chains underneath coupler.</li> <li>2. <b>ALLOW</b> slack for trailer to turn.</li> <li>3. <b>ATTACH</b> chain hooks securely to tow vehicle frame.</li> </ol>		<p><b>WARNING</b></p> <p>Tire, wheel or lugnut failure can cause loss of control. Before towing, you must <b>CHECK</b>:</p> <ol style="list-style-type: none"> <li>1. Tire pressure and tread.</li> <li>2. Tires and wheels for damage.</li> <li>3. Lug nuts for tightness.</li> </ol> <p>For new and remounted wheels, re-tighten lug nuts at the first 10, 25 and 50 miles of driving.</p>	
<p><b>WARNING</b></p> <p>Lights can prevent trailer from being hit by other vehicles. You must:</p> <ol style="list-style-type: none"> <li>1. <b>CONNECT</b> trailer and tow vehicle electrical connectors.</li> <li>2. <b>CHECK</b> all lights: tail lights, turn signal, and brake lights.</li> <li>3. <b>DO NOT TOW</b> if lights are not working.</li> </ol>		<p><b>WARNING</b></p> <p><b>ELECTRIC BRAKE MODELS</b></p> <p>Trailer can roll if it comes loose. Electric safety brake applies when cable pulls pin out of switch box:</p> <ol style="list-style-type: none"> <li>1. <b>PULL</b> hard to get pin out of switch box.</li> <li>2. <b>CHECK</b> brake by <b>PULLING TRAILER</b></li> <li>3. <b>ATTACH</b> pin <b>CABLE</b> to tow vehicle so pin will be pulled out if trailer separates.</li> <li>4. Promptly <b>REPLACE</b> pin in switch box.</li> </ol>	

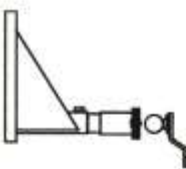
Bumper Pull Trailers – Left Side of Tongue

# General Safety Information

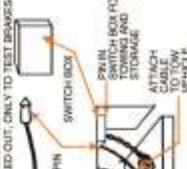
	<p><b>WARNING</b></p> <p>Improper loading can cause trailer sway and sudden loss of control. You must:</p> <ul style="list-style-type: none"> <li>• Make certain weight of load plus trailer weight does not exceed trailer's capacity (GVWR-gross vehicle weight rating)</li> <li>• Load heavier items in front of wheels.</li> <li>• Load evenly side to side.</li> <li>• SECURE load to trailer.</li> </ul>
	<p><b>WARNING</b></p> <p>Uncoupling will cause trailer to come loose from tow vehicle. You must:</p> <ol style="list-style-type: none"> <li>1. CHECK that ball LOAD RATING is same as or greater than coupler LOAD RATING.</li> <li>2. CHECK that ball SIZE is same as coupler.</li> <li>3. CLOSE COUPLER CLAMP on ball.</li> <li>4. LIFT coupler upwards to feel that it is not separable from ball.</li> <li>5. LOCK coupler clamp with pin or padlock.</li> </ol>
	<p><b>WARNING</b></p> <p>ALWAYS use safety chains. Chains hold trailer if connection fails. You must:</p> <ol style="list-style-type: none"> <li>1. ALLOW slack for trailer to turn.</li> <li>2. ATTACH chain hooks securely to tow vehicle frame.</li> </ol>
	<p><b>WARNING</b></p> <p>Tire, wheel or lugnut failure can cause loss of control. Before towing, you must CHECK:</p> <ol style="list-style-type: none"> <li>1. Tire pressure and tread.</li> <li>2. Tires and wheels for damage.</li> <li>3. Lug nuts for tightness.</li> </ol> <p>For new and remounted wheels, re-tighten lug nuts at the first 10, 25 and 50 miles of driving.</p>
	<p><b>WARNING</b></p> <p>Lights can prevent trailer from being hit by other vehicles. You must:</p> <ol style="list-style-type: none"> <li>1. CONNECT trailer and tow vehicle electrical connections.</li> <li>2. CHECK all lights: tail lights, turn signal, and brake lights.</li> <li>3. DO NOT TOW if lights are not working.</li> </ol>
	<p><b>WARNING</b></p> <p><b>ELECTRIC BRAKE MODELS</b></p> <p>Trailer can roll if it comes loose. Electric safety brake applies when:</p> <ol style="list-style-type: none"> <li>1. PULL lever to pull pin out of switch box.</li> <li>2. CHECK brake by PULLING TRAILER with tow vehicle.</li> <li>3. ATTACH pin CABLE to tow vehicle so pin will be pulled out if trailer separates.</li> <li>4. Promptly REPLACE pin in switch box.</li> </ol>

Gooseneck Trailers – Left Side Of Gooseneck Frame

**⚠ WARNING**



**Hydraulic Valve Must Be Down Before Towing Trailer.**

- Pull Up to Operate Jack
- Push Down to Operate Dove Tail or Dump Bed

Dump trailers w/Hydraulic Jacks & Hydraulic Dove Tails w/Hydraulic Jacks – Inside Front Tool Box

**Hydraulic Dove Tail Operating Instructions**

1. Press UP until pump builds up pressure.
2. Push Lever DOWN with foot.
3. Press DOWN while keeping pressure on lever with foot until latch fully disengages.
4. When finished loading or unloading press UP and raise deck fully, press DOWN until latch engages.

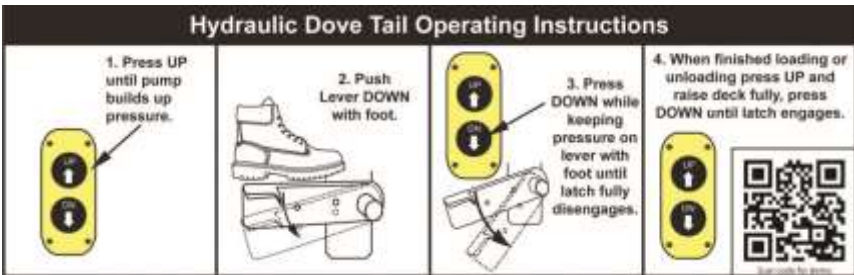

Trailers w/Hydraulic Dove Tails – Left Side of Dove Tail near Lever

**⚠ WARNING**

**FIRE HAZARD**

**Do not place metal objects on top of Battery and Solenoid Terminals**

All trailers equipped with battery and/or hydraulic pump



---

## General Safety Information

---

### **WARNING**

**To protect you and others against death or serious injury, all of the labels shown must be on the trailer and must be legible.**

**If any of these labels are missing or cannot be read, contact your dealer for replacement labels.**

**You will need to provide us with the number shown at the bottom of the label(s) in order for us to send the correct one(s).**

#### Trailer Towing Guide

Driving a vehicle with a trailer in tow is vastly different from driving the same vehicle without a trailer in tow. Acceleration, maneuverability and braking are all diminished with a trailer in tow. It takes longer to get up to speed; you need more room to turn and pass, and more distance to stop when towing a trailer. You will need to spend time adjusting to the different feel and maneuverability of the tow vehicle with a loaded trailer. Because of the significant differences in all aspects of maneuverability when towing a trailer, the hazards and risks of injury are also much greater than when driving without a trailer. You are responsible for keeping your vehicle and trailer in control, and for all the damage that is caused if you lose control of your vehicle and trailer.

Find an open area with little or no traffic for your first practice. Of course, before you start towing the trailer, you must follow all of the instructions for inspection, testing, loading and coupling. Also, before you start towing, adjust the mirrors so you can see the trailer as well as the area to the rear of it.

Drive slowly at first, 5 mph or so, and turn the wheel to get the feel of how the tow vehicle and trailer combination responds. Next, make some right and left hand turns. Watch in your side mirrors to see how the trailer follows the tow vehicle. Turning with a trailer attached requires more room.

Stop the rig a few times from speeds no greater than 10 mph. If your trailer is equipped with brakes, try using different combinations of trailer/electric brake and tow vehicle brake. Note the effect that the trailer brakes have when they are the only brakes used. When properly adjusted, the trailer brakes will come on just before the tow vehicle brakes.

It will take practice to learn how to back up a tow vehicle with a trailer attached. Take it slow. Before backing up, get out of the tow vehicle and look behind the trailer to make sure that there are no obstacles. Some drivers place their hands at the bottom of the steering wheel, and while the tow vehicle is in reverse, "think" of the hands as being on the top of the wheel. When the hands move to the right (counter-clockwise, as you would do to turn the tow vehicle to the left when moving forward), the rear of the trailer moves to the right. Conversely, rotating the steering wheel clockwise with your hands at the bottom of the wheel will move the rear of the trailer to the left, while backing up. If you are towing a bumper hitch rig, be

## General Safety Information

---

careful not to allow the trailer to turn too much, because it will hit the rear of the tow vehicle. To straighten the rig, either pull forward, or turn the steering wheel in the opposite direction.

### SAFE TRAILER TOWING GUIDELINES

- Recheck the load tie downs to make sure the load will not shift during towing.
- Before towing, check coupling, safety chain, brakes, tires, wheels and lights.
- Check the lug nuts or bolts for tightness.
- Check coupler tightness after towing 50 miles.
- Adjust the brake controller to engage the trailer brakes before the tow vehicle brakes. Follow the brake controller manufacturer's literature.
- Use your mirrors to verify that you have room to change lanes or pull into traffic.
- Use your turn signals well in advance.
- Allow plenty of stopping space for your trailer and tow vehicle.
- Do not drive so fast that the trailer begins to sway due to speed. Generally never drive faster than 60 m.p.h.
- Allow plenty of room for passing. A rule of thumb is that the passing distance with a trailer is 4 times the passing distance without a trailer.
- Use lower gears for climbing and descending grades.
- Do not ride the brakes while descending grades; they may get so hot that they stop working. Then you will potentially have a runaway tow vehicle and trailer.
- Slow down for bumps in the road.
- Do not brake while in a curve unless absolutely necessary. Instead, slow down before you enter the curve.
- Do not apply the tow vehicle brakes to correct extreme trailer swaying. Instead, lightly apply the trailer brakes with the hand controller.
- Make regular stops, about once each hour. Confirm that
  - The coupler is secure to the hitch and is locked,
  - Electrical connectors are made,
  - There is appropriate slack in the safety chains,
  - There is appropriate slack in the breakaway switch pull pin cable,
  - The tires are not visibly low on pressure, and
  - The cargo is secure and in good condition.

## General Safety Information

---

### **REPORTING SAFETY DEFECTS**

If you believe that your vehicle has a defect that could cause a crash or could cause injury or death, you should immediately inform the National Highway Traffic Safety Administration (NHTSA) in addition to notifying ABC Manufacturing Inc.

If NHTSA receives similar complaints, it may open an investigation, and if it finds that a safety defect exists in a group of vehicles, it may order a recall and remedy campaign. However, NHTSA cannot become involved in individual problems between you, your dealer, or ABC Manufacturing Inc.

To contact NHTSA, you may call the Vehicle Safety Hotline toll-free at 1-888-327-4236 (TTY: 1-800-424-9153); or go to <http://www.safercar.gov>; or write to: Administrator, NHTSA, 400 Seventh Street, SW, Washington, DC 20590. You can also obtain other information about motor vehicle safety from <http://www.safercar.gov>.

## 3 TIRE SAFETY INFORMATION

This portion of the User's Manual contains tire safety information as required by 49 CFR 575.6.

Section 3.1 contains "Trailer Tire Information".

Section 3.2 contains "Steps for Determining Correct Load Limit - Trailer".

Section 3.3 contains "Steps for Determining Correct Load Limit – Tow Vehicle".

Section 3.4 contains a Glossary of Tire Terminology, including "cold inflation pressure", "maximum inflation pressure", "recommended inflation pressure", and other non-technical terms.

Section 3.5 contains information from the NHTSA brochure entitled "Tire Safety – Everything Rides On It".

This brochure, as well as preceding subsections, describes the following items;

- Tire labeling, including a description and explanation of each marking on the tires, and information about the DOT Tire Identification Number (TIN).
- Recommended tire inflation pressure, including a description and explanation of:
  - Cold inflation pressure.
  - Vehicle Placard and location on the vehicle.
  - Adverse safety consequences of under inflation (including tire failure).
  - Measuring and adjusting air pressure for proper inflation.
- Tire Care, including maintenance and safety practices.
- Vehicle load limits, including a description and explanation of the following items:
  - Locating and understanding the load limit information, total load capacity, and cargo capacity.
  - Calculating total and cargo capacities with varying seating configurations including quantitative examples showing / illustrating how the vehicles cargo and luggage capacity decreases as combined number and size of occupants' increases. This item is also discussed in Section 3.
  - Determining compatibility of tire and vehicle load capabilities.
  - Adverse safety consequences of overloading on handling and stopping on tires.

### 3.1 TRAILER TIRE INFORMATION

Trailer tires may be worn out even though they still have plenty of tread left. This is because trailer tires have to carry a lot of weight all the time, even when not in use. It is actually better for the tire to be rolling down the road than to be idle. During use, the tire releases lubricants that are beneficial to tire life. Using the trailer tires often also helps prevent flat spots from developing.

The main cause of tire failure is improper inflation. Check the cold tire inflation pressures at least once a week for proper inflation levels. "Cold" means that the

---

## Tire Safety Information

---

tires are at the same temperature as the surrounding air, such as when the vehicle has been parked overnight. Wheel and tire manufacturers recommend adjusting the air pressure to the trailer manufacturer's recommended cold inflation pressure, in pounds per square inch (PSI) stated on the vehicle's Federal Certification Label or Tire Placard when the trailer is loaded to its gross vehicle weight rating (GVWR). If the tires are inflated to less than the recommended inflation level or the GVWR of the trailer is exceeded, the load carrying capacity of the tire could be dramatically affected. If the tires are inflated more than the recommended inflation level, handling characteristics of the tow vehicle/trailer combination could be affected. Refer to the owner's manual or talk to your dealer or vehicle manufacturer if you have any questions regarding proper inflation practices.

Tires can lose air over a period of time. In fact, tires can lose 1 to 3 PSI per month. This is because molecules of air, under pressure, weave their way from the inside of the tire, through the rubber, to the outside. A drop in tire pressure could cause the tire to become overloaded, leading to excessive heat buildup. If a trailer tire is under-inflated, even for a short period of time, the tire could suffer internal damage.

High speed towing in hot conditions degrades trailer tires significantly. As heat builds up during driving, the tire's internal structure starts to breakdown, compromising the strength of the tire. It is recommended to drive at moderate speeds.

Statistics indicate the average life of a trailer tire is about five years under normal use and maintenance conditions. After three years, replacing the trailer tires with new ones should be considered, even if the tires have adequate tread depth. Some experts claim that after five years, trailer tires are considered worn out and should be replaced, even if they have had minimal or no use. This is such a general statement that it may not apply in all cases. It is best to have your tires inspected by a tire supplier to determine if your tires need to be replaced.

If you are storing your trailer for an extended period, make sure the tires are fully inflated to the maximum rated pressure and that you store them in a cool, dry place, such as a garage. Use tire covers to protect the trailer tires from the harsh effects of the sun.

### **3.2 STEPS FOR DETERMINING CORRECT LOAD LIMIT – TRAILER**

Determining the load limits of a trailer includes more than understanding the load limits of the tires alone. On all trailers there is a Federal Certification / VIN label that is located on the forward half of the left (road) side of the unit. This certification/VIN label will indicate the trailer's Gross Vehicle Weight Rating (GVWR). This is the most weight the fully loaded trailer can weigh. It will also provide the Gross Axle Weight Rating (GAWR). This is the most a particular axle can weigh. If there are multiple axles, the GAWR of each axle will be provided.

If your trailer has a GVWR of 10,000 pounds or less, there is a vehicle placard located in the same location as the certification label described above. This placard provides tire and loading information. In addition, this placard will show a statement

## Tire Safety Information

regarding maximum cargo capacity. Cargo can be added to the trailer, up to the maximum weight specified on the placard. The combined weight of the cargo is provided as a single number. In any case, remember: the total weight of a fully loaded trailer cannot exceed the stated GVWR.

When loading your cargo, be sure it is distributed evenly to prevent overloading front to back and side to side. Heavy items should be placed low and as close to the axle positions as reasonable. Too many items on one side may overload a tire. The best way to know the actual weight of the vehicle is to weigh it at a public scale. Talk to your dealer to discuss the weighing methods needed to capture the various weights related to the trailer. This would include the weight empty or unloaded, weights per axle, wheel, hitch or king-pin, and total weight.

Excessive loads and/or under inflation cause tire overloading and, as a result, abnormal tire flexing occurs. This situation can generate an excessive amount of heat within the tire. Excessive heat may lead to tire failure. It is the air pressure that enables a tire to support the load, so proper inflation is critical. The proper air pressure may be found on the Certification / VIN label and/or on the Tire Placard. This value should never exceed the maximum cold inflation pressure stamped on the tire.

### TRAILERS 10,000 POUNDS GVWR OR LESS

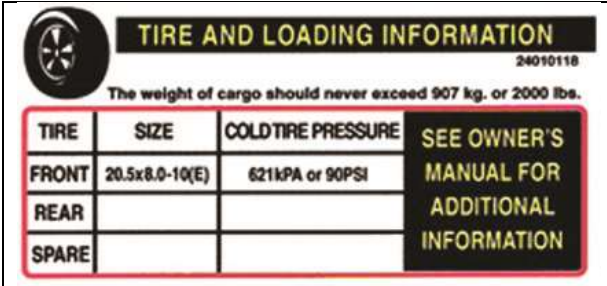

The placard features a tire icon on the left, a title bar with 'TIRE AND LOADING INFORMATION' and '24010118', and a warning statement: 'The weight of cargo should never exceed 907 kg. or 2000 lbs.'. Below this is a table with columns for 'TIRE', 'SIZE', and 'COLD TIRE PRESSURE'. The 'FRONT' row is filled with '20.5x8.0-10(E)' and '621kPA or 90PSI'. The 'REAR' and 'SPARE' rows are empty. To the right of the table is a box with the text 'SEE OWNER'S MANUAL FOR ADDITIONAL INFORMATION'.

TIRE	SIZE	COLD TIRE PRESSURE	SEE OWNER'S MANUAL FOR ADDITIONAL INFORMATION
FRONT	20.5x8.0-10(E)	621kPA or 90PSI	
REAR			
SPARE			

*Tire Information Placard*

- Locate the statement, "The weight of cargo should never exceed XXX kg or XXX lbs.," on your vehicle's placard.
- This figure equals the available amount of cargo and luggage load capacity.
- Determine the combined weight of luggage and cargo being loaded on the vehicle. That weight may not safely exceed the available cargo and luggage load capacity.
- The trailer's placard refers to the Tire Information Placard attached adjacent to or near the trailer's VIN (Certification) label at the left front of the trailer.

### TRAILERS OVER 10,000 POUNDS GVWR

**(Note: These trailers are not required to have a tire information placard on the trailer and may not have one installed)**

---

## Tire Safety Information

---

- Determine the empty weight of your trailer by weighing the trailer using a public scale or other means.
- Locate the GVWR (Gross Vehicle Weight Rating) of the trailer on your trailer's VIN (Certification) label.
- Subtract the empty weight of your trailer from the GVWR stated on the VIN label. That weight is the maximum available cargo capacity of the trailer and may not be safely exceeded.

### 3.3 STEPS FOR DETERMINING CORRECT LOAD LIMIT – TOW VEHICLE

- Locate the statement, "The combined weight of occupants and cargo should never exceed XXX lbs.," on your vehicle's placard.
- Determine the combined weight of the driver and passengers who will be riding in your vehicle.
- Subtract the combined weight of the driver and passengers from XXX kilograms or XXX pounds.
- The resulting figure equals the available amount of cargo and luggage capacity. For example, if the "XXX" amount equals 1400 lbs. and there will be five 150 lb. passengers in your vehicle, the amount of available cargo and luggage capacity is 650 lbs. ( $1400 - 750 (5 \times 150) = 650$  lbs.).
- Determine the combined weight of luggage and cargo being loaded on the vehicle. That weight may not safely exceed the available cargo and luggage capacity calculated in previous step.
- If your vehicle will be towing a trailer, load from your trailer will be transferred to your vehicle. Consult the tow vehicle's manual to determine how this weight transfer reduces the available cargo and luggage capacity of your vehicle.

### 3.4 GLOSSARY OF TIRE TERMINOLOGY

**Accessory weight** The combined weight (in excess of those standard items which may be replaced) of automatic transmission, power steering, power brakes, power windows, power seats, radio and heater, to the extent that these items are available as factory-installed equipment (whether installed or not).

**Bead** The part of the tire that is made of steel wires, wrapped or reinforced by ply cords and that is shaped to fit the rim.

**Bead separation** This is the breakdown of the bond between components in the bead.

**Bias ply tire** A pneumatic tire in which the ply cords that extend to the beads are laid at alternate angles substantially less than 90 degrees to the centerline of the tread.

**Carcass** The tire structure, except tread and sidewall rubber which, when inflated, bears the load.

## Tire Safety Information

---

**Chunking** The breaking away of pieces of the tread or sidewall.

**Cold inflation pressure** The pressure in the tire before you drive.

**Cord** The strands forming the plies in the tire.

**Cord separation** The parting of cords from adjacent rubber compounds.

**Cracking** Any parting within the tread, sidewall, or inner liner of the tire extending to cord material.

**CT** A pneumatic tire with an inverted flange tire and rim system in which the rim is designed with rim flanges pointed radially inward and the tire is designed to fit on the underside of the rim in a manner that encloses the rim flanges inside the air cavity of the tire.

**Curb weight** The weight of a motor vehicle with standard equipment including the maximum capacity of fuel, oil, and coolant, and, if so equipped, air conditioning and additional weight optional engine.

**Extra load tire** A tire designed to operate at higher loads and at higher inflation pressures than the corresponding standard tire.

**Groove** The space between two adjacent tread ribs.

**Gross Axle Weight Rating** The maximum weight that any axle can support, as published on the Certification / VIN label on the front left side of the trailer. Actual weight determined by weighing each axle on a public scale, with the trailer attached to the towing vehicle.

**Gross Vehicle Weight Rating** The maximum weight of the fully loaded trailer, as published on the Certification / VIN label. Actual weight determined by weighing trailer on a public scale, without being attached to the towing vehicle.

**Hitch Weight** The downward force exerted on the hitch ball by the trailer coupler.

**Innerliner** The layer(s) forming the inside surface of a tubeless tire that contains the inflating medium within the tire.

**Innerliner separation** The parting of the innerliner from cord material in the carcass.

**Intended outboard sidewall** The sidewall that contains a white-wall, bears white lettering or bears manufacturer, brand, and/or model name molding that is higher or deeper than the same molding on the other sidewall of the tire or the outward facing sidewall of an asymmetrical tire that has a particular side that must always face outward when mounted on a vehicle.



## Tire Safety Information

---

**Light truck (LT) tire** A tire designated by its manufacturer as primarily intended for use on lightweight trucks or multipurpose passenger vehicles. May be used on trailers.

**Load rating** The maximum load that a tire is rated to carry for a given inflation pressure.

**Maximum load rating** The load rating for a tire at the maximum permissible inflation pressure for that tire.

**Maximum permissible inflation pressure** The maximum cold inflation pressure to which a tire may be inflated.

**Maximum loaded vehicle weight** The sum of curb weight, accessory weight, vehicle capacity weight, and production options weight.

**Measuring rim** The rim on which a tire is fitted for physical dimension requirements.

**Non-pneumatic rim** A mechanical device which, when a non-pneumatic tire assembly incorporates a wheel, supports the tire, and attaches, either integrally or separately, to the wheel center member and upon which the tire is attached.

**Non-pneumatic spare tire assembly** A non-pneumatic tire assembly intended for temporary use in place of one of the pneumatic tires and rims that are fitted to a passenger car in compliance with the requirements of this standard.

**Non-pneumatic tire** A mechanical device which transmits, either directly or through a wheel or wheel center member, the vertical load and tractive forces from the roadway to the vehicle, generates the tractive forces that provide the directional control of the vehicle and does not rely on the containment of any gas or fluid for providing those functions.

**Non-pneumatic tire assembly** A non-pneumatic tire, alone or in combination with a wheel or wheel center member, which can be mounted on a vehicle.

**Normal occupant weight** This means 68 kilograms (150 lbs.) times the number of occupants specified in the second column of Table I of 49 CFR 571.110.

**Occupant distribution** The distribution of occupants in a vehicle as specified in the third column of Table I of 49 CFR 571.110.

**Open splice** Any parting at any junction of tread, sidewall, or innerliner that extends to cord material.

**Outer diameter** The overall diameter of an inflated new tire.

## Tire Safety Information

---

**Overall width** The linear distance between the exteriors of the sidewalls of an inflated tire, including elevations due to labeling, decorations, or protective bands or ribs.

**Pin Weight** The downward force applied to the 5<sup>th</sup> wheel or gooseneck ball, by the trailer kingpin or gooseneck coupler.

**Ply** A layer of rubber-coated parallel cords.

**Ply separation** A parting of rubber compound between adjacent plies.

**Pneumatic tire** A mechanical device made of rubber, chemicals, fabric and steel or other materials, that, when mounted on an automotive wheel, provides the traction and contains the gas or fluid that sustains the load.

**Production options weight** The combined weight of those installed regular production options weighing over 2.3 kilograms (5 lbs.) in excess of those standard items which they replace, not previously considered in curb weight or accessory weight, including heavy duty brakes, ride levelers, roof rack, heavy duty battery, and special trim.

**Radial ply tire** A pneumatic tire in which the ply cords that extend to the beads are laid at substantially 90 degrees to the centerline of the tread.

**Recommended inflation pressure** This is the inflation pressure provided by the vehicle manufacturer on the Tire Information label and on the Certification / VIN tag.

**Reinforced tire** A tire designed to operate at higher loads and at higher inflation pressures than the corresponding standard tire.

**Rim** A metal support for a tire or a tire and tube assembly upon which the tire beads are seated.

**Rim diameter** This means the nominal diameter of the bead seat.

**Rim size designation** This means the rim diameter and width.

**Rim type designation** This means the industry of manufacturer's designation for a rim by style or code.

**Rim width** This means the nominal distance between rim flanges.

**Section width** The linear distance between the exteriors of the sidewalls of an inflated tire, excluding elevations due to labeling, decoration, or protective bands.

**Sidewall** That portion of a tire between the tread and bead.

## Tire Safety Information

---

**Sidewall separation** The parting of the rubber compound from the cord material in the sidewall.

**Special Trailer (ST) tire** The "ST" is an indication the tire is for trailer use only.

**Test rim** The rim on which a tire is fitted for testing, and may be any rim listed as appropriate for use with that tire.

**Tread** That portion of a tire that comes into contact with the road.

**Tread rib** A tread section running circumferentially around a tire.

**Tread separation** Pulling away of the tread from the tire carcass.

**Treadwear indicators (TWI)** The projections within the principal grooves designed to give a visual indication of the degrees of wear of the tread.

**Vehicle capacity weight** The rated cargo and luggage load plus 68 kilograms (150 lbs.) times the vehicle's designated seating capacity.

**Vehicle maximum load on the tire** The load on an individual tire that is determined by distributing to each axle its share of the maximum loaded vehicle weight and dividing by two.

**Vehicle normal load on the tire** The load on an individual tire that is determined by distributing to each axle its share of the curb weight, accessory weight, and normal occupant weight (distributed in accordance with Table I of CRF 49 571.110) and dividing by 2.

**Weather side** The surface area of the rim not covered by the inflated tire.

**Wheel center member** In the case of a non-pneumatic tire assembly incorporating a wheel, a mechanical device which attaches, either integrally or separably, to the non-pneumatic rim and provides the connection between the non-pneumatic rim and the vehicle; or, in the case of a non-pneumatic tire assembly not incorporating a wheel, a mechanical device which attaches, either integrally or separably, to the non-pneumatic tire and provides the connection between tire and the vehicle.

**Wheel-holding fixture** The fixture used to hold the wheel and tire assembly securely during testing.

### 3.5 TIRE SAFETY - EVERYTHING RIDES ON IT

The National Traffic Safety Administration (NHTSA) has published a brochure (DOT HS 809 361) that discusses all aspects of Tire Safety, as required by CFR 575.6. This brochure is reproduced in part below. It can be obtained and downloaded from NHTSA, free of charge, from the following web site:

[http://www.nhtsa.dot.gov/cars/rules/TireSafety/ridesonit/tires\\_index.html](http://www.nhtsa.dot.gov/cars/rules/TireSafety/ridesonit/tires_index.html)

---

## Tire Safety Information

---

Studies of tire safety show that maintaining proper tire pressure, observing tire and vehicle load limits (not carrying more weight in your vehicle than your tires or vehicle can safely handle), avoiding road hazards, and inspecting tires for cuts, slashes, and other irregularities are the most important things you can do to avoid tire failure, such as tread separation or blowout and flat tires. These actions, along with other care and maintenance activities, can also:

- Improve vehicle handling
- Help protect you and others from avoidable breakdowns and accidents
- Improve fuel economy
- Increase the life of your tires.

This booklet presents a comprehensive overview of tire safety, including information on the following topics:

- Basic tire maintenance
- Uniform Tire Quality Grading System
- Fundamental characteristics of tires
- Tire safety tips.

Use this information to make tire safety a regular part of your vehicle maintenance routine. Recognize that the time you spend is minimal compared with the inconvenience and safety consequences of a flat tire or other tire failure.

### **SAFETY FIRST—BASIC TIRE MAINTENANCE**

Properly maintained tires improve the steering, stopping, traction, and load-carrying capability of your vehicle. Underinflated tires and overloaded vehicles are a major cause of tire failure. Therefore, as mentioned above, to avoid flat tires and other types of tire failure, you should maintain proper tire pressure, observe tire and vehicle load limits, avoid road hazards, and regularly inspect your tires.

### **FINDING YOUR VEHICLE'S RECOMMENDED TIRE PRESSURE AND LOAD LIMITS**

Tire information placards and vehicle certification labels contain information on tires and load limits. These labels indicate the vehicle manufacturer's information including:

- Recommended tire size
- Recommended tire inflation pressure
- Vehicle capacity weight (VCW—the maximum occupant and cargo weight a vehicle is designed to carry)
- Front and rear gross axle weight ratings (GAWR—the maximum weight the axle systems are designed to carry).

Both placards and certification labels are permanently attached to the trailer near the left front.

### **UNDERSTANDING TIRE PRESSURE AND LOAD LIMITS**

Tire inflation pressure is the level of air in the tire that provides it with load-carrying capacity and affects the overall performance of the vehicle. The tire inflation

---

## Tire Safety Information

---

pressure is a number that indicates the amount of air pressure—measured in pounds per square inch (psi)—a tire requires to be properly inflated. (You will also find this number on the vehicle information placard expressed in kilopascals (kPa), which is the metric measure used internationally.)

Manufacturers of passenger vehicles and light trucks determine this number based on the vehicle's design load limit, that is, the greatest amount of weight a vehicle can safely carry and the vehicle's tire size. The proper tire pressure for your vehicle is referred to as the "recommended cold inflation pressure." (As you will read below, it is difficult to obtain the recommended tire pressure if your tires are not cold.)

Because tires are designed to be used on more than one type of vehicle, tire manufacturers list the "maximum permissible inflation pressure" on the tire sidewall. This number is the greatest amount of air pressure that should ever be put in the tire under normal driving conditions.

### **CHECKING TIRE PRESSURE**

It is important to check your vehicle's tire pressure at least once a month for the following reasons:

- Most tires may naturally lose air over time.
- Tires can lose air suddenly if you drive over a pothole or other object or if you strike the curb when parking.
- With radial tires, it is usually not possible to determine underinflation by visual inspection.

For convenience, purchase a tire pressure gauge to keep in your vehicle. Gauges can be purchased at tire dealerships, auto supply stores, and other retail outlets. The recommended tire inflation pressure that vehicle manufacturers provide reflects the proper psi when a tire is cold. The term cold does not relate to the outside temperature. Rather, a cold tire is one that has not been driven on for at least three hours. When you drive, your tires get warmer, causing the air pressure within them to increase. Therefore, to get an accurate tire pressure reading, you must measure tire pressure when the tires are cold or compensate for the extra pressure in warm tires.

### **STEPS FOR MAINTAINING PROPER TIRE PRESSURE**

- Step 1: Locate the recommended tire pressure on the vehicle's tire information placard, certification label, or in the owner's manual.
- Step 2: Record the tire pressure of all tires.
- Step 3: If the tire pressure is too high in any of the tires, slowly release air by gently pressing on the tire valve stem with the edge of your tire gauge until you get to the correct pressure.
- 
- Step 4: If the tire pressure is too low, note the difference between the measured tire pressure and the correct tire pressure. These "missing" pounds of pressure are what you will need to add.
- Step 5: At a service station, add the missing pounds of air pressure to each tire that is underinflated.

---

## Tire Safety Information

---

- Step 6: Check all the tires to make sure they have the same air pressure (except in cases in which the front and rear tires are supposed to have different amounts of pressure).

If you have been driving your vehicle and think that a tire is underinflated, fill it to the recommended cold inflation pressure indicated on your vehicle's tire information placard or certification label. While your tire may still be slightly underinflated due to the extra pounds of pressure in the warm tire, it is safer to drive with air pressure that is slightly lower than the vehicle manufacturer's recommended cold inflation pressure than to drive with a significantly underinflated tire. Since this is a temporary fix, don't forget to recheck and adjust the tire's pressure when you can obtain a cold reading.

### **TIRE SIZE**

To maintain tire safety, purchase new tires that are the same size as the vehicle's original tires or another size recommended by the manufacturer. Look at the tire information placard, the owner's manual, or the sidewall of the tire you are replacing to find this information. If you have any doubt about the correct size to choose, consult with the tire dealer.

### **TIRE TREAD**

The tire tread provides the gripping action and traction that prevent your vehicle from slipping or sliding, especially when the road is wet or icy. In general, tires are not safe and should be replaced when the tread is worn down to  $\frac{2}{32}$  of an inch. Tires have built-in treadwear indicators that let you know when it is time to replace your tires. These indicators are raised sections spaced intermittently in the bottom of the tread grooves. When they appear "even" with the outside of the tread, it is time to replace your tires. Another method for checking tread depth is to place a penny in the tread with Lincoln's head upside down and facing you. If you can see the top of Lincoln's head, you are ready for new tires.

### **TIRE BALANCE AND WHEEL ALIGNMENT**

To avoid vibration or shaking of the vehicle when a tire rotates, the tire must be properly balanced. This balance is achieved by positioning weights on the wheel to counterbalance heavy spots on the wheel-and-tire assembly. A wheel alignment adjusts the angles of the wheels so that they are positioned correctly relative to the vehicle's frame. This adjustment maximizes the life of your tires. These adjustments require special equipment and should be performed by a qualified technician.

### **TIRE REPAIR**

The proper repair of a punctured tire requires a plug for the hole and a patch for the area inside the tire that surrounds the puncture hole. Punctures through the tread can be repaired if they are not too large, but punctures to the sidewall should not be repaired. Tires must be removed from the rim to be properly inspected before being plugged and patched.

---

# Tire Safety Information

---

## TIRE FUNDAMENTALS

Federal law requires tire manufacturers to place standardized information on the sidewall of all tires. This information identifies and describes the fundamental characteristics of the tire and also provides a tire identification number for safety standard certification and in case of a recall.

### 3.5.1.1 Information on Passenger Vehicle Tires

Please refer to the diagram below.

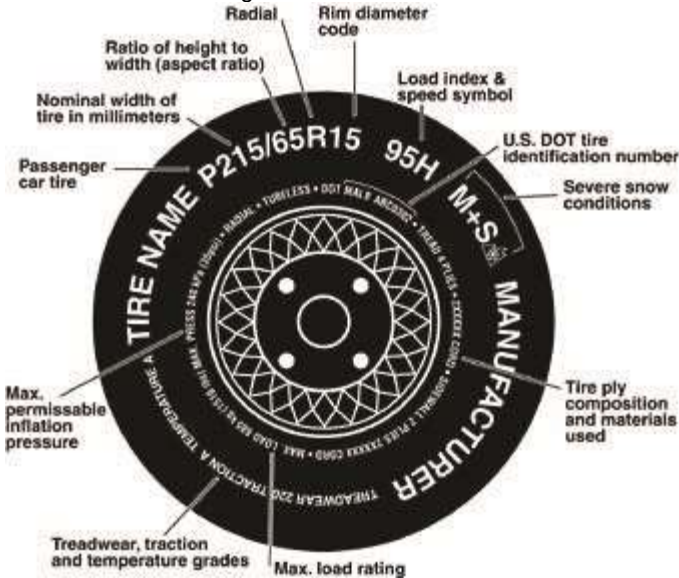

#### P

The "P" indicates the tire is for passenger vehicles.

#### Next number

This three-digit number gives the width in millimeters of the tire from sidewall edge to sidewall edge. In general, the larger the number, the wider the tire.

#### Next number

This two-digit number, known as the aspect ratio, gives the tire's ratio of height to width. Numbers of 70 or lower indicate a short sidewall for improved steering response and better overall handling on dry pavement.

#### R

The "R" stands for radial. Radial ply construction of tires has been the industry standard for the past 20 years.

## Tire Safety Information

---

### Next number

This two-digit number is the wheel or rim diameter in inches. If you change your wheel size, you will have to purchase new tires to match the new wheel diameter.

### Next number

This two- or three-digit number is the tire's load index. It is a measurement of how much weight each tire can support. You may find this information in your owner's manual. If not, contact a local tire dealer. Note: You may not find this information on all tires because it is not required by law.

### M+S

The "M+S" or "M/S" indicates that the tire has some mud and snow capability. Most radial tires have these markings; hence, they have some mud and snow capability.

### Speed Rating

The speed rating denotes the speed at which a tire is designed to be driven for extended periods of time. The ratings range from 99 miles per hour (mph) to 186 mph. These ratings are listed below. Note: You may not find this information on all tires because it is not required by law.

Letter Rating	Speed Rating
Q	99 mph
R	106 mph
S	112 mph
T	118 mph
U	124 mph
H	130 mph
V	149 mph
W	168* mph
Y	186* mph

\* For tires with a maximum speed capability over 149 mph, tire manufacturers sometimes use the letters ZR. For those with a maximum speed capability over 186 mph, tire manufacturers always use the letters ZR.

### U.S. DOT Tire Identification Number

This begins with the letters "DOT" and indicates that the tire meets all federal standards. The next two numbers or letters are the plant code where it was manufactured, and the last four numbers represent the week and year the tire was built. For example, the numbers 3197 means the 31st week of 1997. The other numbers are marketing codes used at the manufacturer's discretion. This information is used to contact consumers if a tire defect requires a recall.

### Tire Ply Composition and Materials Used

The number of plies indicates the number of layers of rubber-coated fabric in the tire. In general, the greater the number of plies, the more weight a tire can support. Tire manufacturers also must indicate the materials in the tire, which include steel, nylon, polyester, and others.



## Tire Safety Information

---

### Maximum Load Rating

This number indicates the maximum load in kilograms and pounds that can be carried by the tire.

### Maximum Permissible Inflation Pressure

This number is the greatest amount of air pressure that should ever be put in the tire under normal driving conditions.

### 3.5.1.2 UTQGS Information

#### Treadwear Number

This number indicates the tire's wear rate. The higher the treadwear number is, the longer it should take for the tread to wear down. For example, a tire graded 400 should last twice as long as a tire graded 200.

#### Traction Letter

This letter indicates a tire's ability to stop on wet pavement. A higher graded tire should allow you to stop your car on wet roads in a shorter distance than a tire with a lower grade. Traction is graded from highest to lowest as "AA", "A", "B", and "C".

#### Temperature Letter

This letter indicates a tire's resistance to heat. The temperature grade is for a tire that is inflated properly and not overloaded. Excessive speed, underinflation or excessive loading, either separately or in combination, can cause heat build-up and possible tire failure. From highest to lowest, a tire's resistance to heat is graded as "A", "B", or "C".

### 3.5.1.3 Additional Information on Light Truck Tires

Please refer to the following diagram.

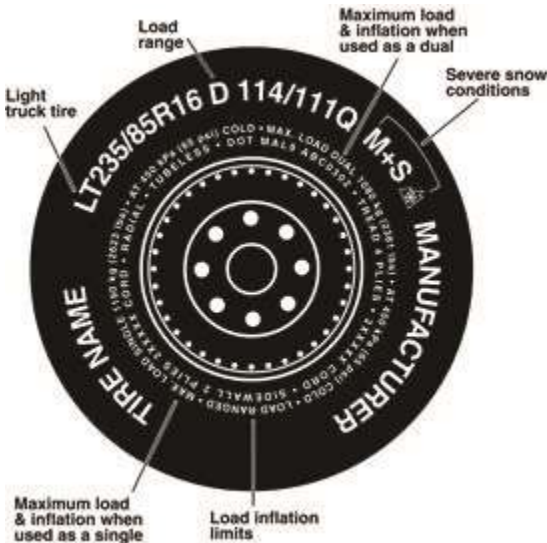

---

## Tire Safety Information

---

Tires for light trucks have other markings besides those found on the sidewalls of passenger tires.

**LT** The "LT" indicates the tire is for light trucks or trailers.

**ST** An "ST" is an indication the tire is for trailer use only.

### **Max. Load Dual kg (lbs) at kPa (psi) Cold**

This information indicates the maximum load and tire pressure when the tire is used as a dual, that is, when four tires are put on each rear axle (a total of six or more tires on the vehicle).

### **Max. Load Single kg (lbs) at kPa (psi) Cold**

This information indicates the maximum load and tire pressure when the tire is used as a single.

### **Load Range**

This information identifies the tire's load-carrying capabilities and its inflation limits.

## **TIRE SAFETY TIPS**

### **Preventing Tire Damage**

- Slow down if you have to go over a pothole or other object in the road.
- Do not run over curbs or other foreign objects in the roadway, and try not to strike the curb when parking.

### **Tire Safety Checklist**

- Check tire pressure regularly (at least once a month), including the spare.
- Inspect tires for uneven wear patterns on the tread, cracks, foreign objects, or other signs of wear or trauma.
- Remove bits of glass and foreign objects wedged in the tread.
- Make sure your tire valves have valve caps.
- Check tire pressure before going on a long trip.
- Do not overload your vehicle. Check the Tire Information Placard or Owner's Manual for the maximum recommended load for the vehicle.

### **Tire / Wheel Components – Limited Warranty:**

Load Trail LLC, warrants, subject to the terms, conditions, and limitations state herein, tires, and wheels to be free from defects in materials and workmanship.

1. This Limited Warranty applies only to the original purchaser for two years from the warranty start date.
2. The warranty period for the coating of the wheel is ninety (90) days from the warranty start date.
3. 100 % replacement for any material or manufacturing defects.

## Tire Safety Information

---

4. The Limited Warranty does not cover incidental or consequential damages, including, but not limited to, lost time, inconvenience, loss of vehicle use, cost of towing or transportation, related property damage or consequential damages of any type of nature.
5. The tire is worn past last 3/32 of tread depth at any point on tread contact surface

The warranty does not apply to the following:

- Tires or wheels subjected to overloading, under-inflation, improper mounting, fitment to incorrect rim, purposeful abuse or chemical contamination.
  - Tires or wheels which have been patched, plugged or repaired or into which liquid balancers or sealants have been introduced.
6. This Limited Warranty makes no expressed claims of expected tire wear. Variables that affect tire wear are driving conditions, load and tire inflation pressure.

Note: All specifications subject to change without notice.

## 4 COUPLING TO THE TOW VEHICLE

Follow all of the safety precautions and instructions in this manual to ensure safety of persons, cargo, and satisfactory life of the trailer.

### 4.1 USE AN ADEQUATE TOW VEHICLE AND HITCH

If the vehicle and hitch are not properly selected and matched to the Gross Vehicle Weight Rating (GVWR) of your trailer, you can cause an accident that could lead to death or serious injury. If you already have a tow vehicle, know your vehicle tow rating and make certain the trailer's rated capacity is less than or equal to the tow vehicle's rated towing capacity.

#### DANGER

**Use of a hitch with a load rating less than the load rating of the trailer can result in loss of control and may lead to death or serious injury.**

**Use of a tow vehicle with a towing capacity less than the load rating of the trailer can result in loss of control, and may lead to death or serious injury.**

**Be sure your hitch and tow vehicle are rated for the Gross Vehicle Weight Rating of your trailer.**

#### TRAILER INFORMATION

The Certification / Vehicle Identification Number (VIN) tag is located on the front left corner of your trailer.

The trailer Certification / VIN tag contains the following critical safety information for the use of your trailer:

**MANUFACTURER:** Load Trail LLC

**DATE OF MANUFACTURE:** Month and year the trailer was manufactured.

**GVWR:** The Gross Vehicle Weight Rating is the maximum allowable gross weight of the trailer and its contents. The gross weight of the trailer includes the weight of the trailer and all of the items within it (such as cargo and other supplies).

**GAWR:** The Gross Axle Weight Rating is the maximum gross weight that an axle can support. It is the lowest of axle, wheel, or tire rating. Sometimes the tire or wheel rating is lower than the axle manufacturers rating, and will then determine GAWR.

---

## Coupling To The Tow Vehicle

---

The sum total of the GAWR for all trailer axles may be less than the GVWR for the trailer, because some of the trailer load is carried by the tow vehicle, rather than by the trailer axle(s). The total weight of the cargo and trailer must not exceed the GVWR, and the load on an axle must not exceed its GAWR.

**TIRE SIZE:** The tire size and load range for your trailer.

**RIM SIZE:** The rim size and load range for your trailer.

**PSI:** The tire air pressure (Kilopascals / Pounds per Square Inch) measured with tires cold.

**VIN:** The Vehicle Identification Number.

**VEHICLE TYPE:** Model or style of trailer.

**CERTIFICATION STATEMENT:** “This trailer meets all the Federal Motor Vehicle Safety Standards in effect on the date of manufacture shown above”.

### TOW VEHICLE

When equipping a new vehicle or an older vehicle to tow your trailer, ask the vehicle dealer for advice on how to outfit the towing vehicle. Discuss the following information and equipment with the vehicle dealer.

**Overall Carrying and Towing Capacity of Vehicle:** Vehicle manufacturers will provide you with the maximum towing capacities of their various models, as well as the GCWR. No amount of reinforcement will give a 100 horsepower, 2,500 pound truck the towing capacity that a 300 horsepower, 5,000 pound truck has.

**Towing Hitch:** The towing hitch attached to your tow vehicle must have a capacity equal to or greater than the load rating of the trailer you intend to tow. The hitch capacity must also be matched to the tow vehicle capacity.

**Suspension System:** A tow vehicle equipped with a factory installed “Towing Package” likely comes equipped with heavy duty springs, heavy duty tires and other suspension components which are able to serve the size and weight of the trailer that the vehicle is rated to tow. However, the addition of additional equipment may further improve the tow vehicle performance. These may include adjustable air shocks, helper springs, etc.

**Brake Controller:** The brake controller is part of the tow vehicle and is essential in the operation of the electric brakes on the trailer. If your trailer has electric brakes, it requires a brake controller be installed at the driver’s position. The brake controller is not the same as the safety breakaway brake system that is installed on the trailer.

**Side View Mirrors:** The size of the trailer that is being towed and your state law regulations determine the size of the mirrors. However, some states prohibit extended mirrors on a tow vehicle, except while a trailer is actually being towed. In

---

## Coupling To The Tow Vehicle

---

this situation, detachable extended mirrors are necessary. Check with your dealer or the appropriate state agency for mirror requirements.

**Heavy Duty Flasher:** A Heavy Duty Flasher is an electrical component that may be required when your trailer turn signal lights are attached to the tow vehicle flasher circuit.

**Electrical Connector:** An Electrical Connector connects the light and brake systems on the trailer to the light and brake controls on the towing vehicle.

**Heavy Duty Engine Oil Cooling System:** The tow vehicle engine works harder when a trailer is being towed. Depending on the size of the trailer, you may need to install a separate engine oil cooler. Inadequate cooling may result in sudden engine failure. Ask the tow vehicle dealer if it is necessary to install a heavy duty cooling system.

**Automatic Transmission Oil Cooler:** The automatic transmission of a towing vehicle handles more power when a trailer is being towed. Inadequate cooling will shorten transmission life, and may result in sudden transmission failure. Ask the tow vehicle dealer if it is necessary to install a separate oil cooler for the automatic transmission.

**Fire Extinguisher:** It is sensible to have a fire extinguisher in the tow vehicle.

**Emergency Flares and Emergency Triangle Reflectors:** It is wise to carry these warning devices even if you are not towing a trailer. It is particularly important to have these when towing a trailer because the hazard flashers of your towing vehicle will not operate for as long a period of time when the battery is running both the trailer lights and tow vehicle lights.

## 4.2 COUPLING AND UNCOUPLING THE TRAILER

A secure coupling (or fastening) of the trailer to the tow vehicle is essential. A loss of coupling may result in death or serious injury. Therefore, you must understand and follow all of the instructions for coupling.

The following parts are involved in making a secure coupling between the trailer and tow vehicle:

**Coupling:** That part of the trailer connecting mechanism by which the connection is actually made to the trailer hitch. This does not include any structural member, extension of the trailer frame, or brake controller.

**Hitch:** That part of the connecting mechanism including the ball support platform and ball and those components that extend and are attached to the towing vehicle, including bumpers intended to serve as hitches.

---

## Coupling To The Tow Vehicle

---

**Safety chains:** Chains permanently attached to the trailer such that if the coupler connection comes loose, the safety chains can keep the trailer attached to the tow vehicle. With properly rigged safety chains, it is possible to keep the tongue of the trailer from digging into the road pavement, even if the coupler-to-hitch connection comes apart.

**Trailer lighting (and braking) connector:** A device that connects electrical power from the tow vehicle to the trailer. Electricity is used to turn on brake lights, running lights, and turn signals as required. In addition, if your trailer has a separate braking system, the electrical connector will also supply power to the trailer brakes from the tow vehicle.

**Breakaway switch:** If the trailer becomes uncoupled from the tow vehicle, the breakaway switch lanyard, attached independently to the tow vehicle hitch, will pull a pin in the emergency electrical breakaway switch on the trailer. The breakaway switch is activated by a separate battery supply in the trailer such as to energize the trailer brakes independently of the towing vehicle. It is important to check the state of charge of the emergency breakaway battery before each trip. Simply pull the pin out of the switch by hand and then try to pull the trailer. If you feel a significant drag force the brakes are activated. Be sure to re-insert the pin in the breakaway switch. Also be sure to allow enough slack in the breakaway brake lanyard such that the switch will only activate (pin pulls out) if the coupler connection comes loose.

**Jack:** A device on the trailer that is used to raise and lower the trailer tongue.

### **WARNING**

**An improperly coupled trailer can result in death or serious injury.**

**Do not move the trailer until:**

- **The coupler is secured and locked to hitch;**
- **The safety chains are secured to the tow vehicle; and**
- **The trailer jack(s) are fully retracted.**

**Do not tow the trailer on the road until:**

- **Tires and wheels are checked;**
- **The trailer brakes are checked;**
- **The breakaway lanyard is connected to the tow vehicle;**
- **The load is secured to the trailer; and**
- **The trailer lights are connected and checked.**

### **VARIOUS COUPLER DESIGNS**

Trailers are produced with a variety of coupler devices. One of the sections below will pertain to your trailer.

---

## Coupling To The Tow Vehicle

---

- Bumper pull ball coupler or ring
- Gooseneck ball coupler
- Gooseneck fifth wheel or king pin coupler

If the coupler on your trailer does not resemble one of the couplers shown in the figures, see the separate coupler instructions. If you do not have separate coupler instructions, contact your dealer for assistance.

### 4.3 BUMPER PULL TRAILERS

#### TRAILER WITH BALL HITCH COUPLER

A ball hitch coupler connects to a ball that is located on or under the rear bumper of tow vehicle. This system of coupling a trailer to a tow vehicle is sometimes referred to as "bumper pull."

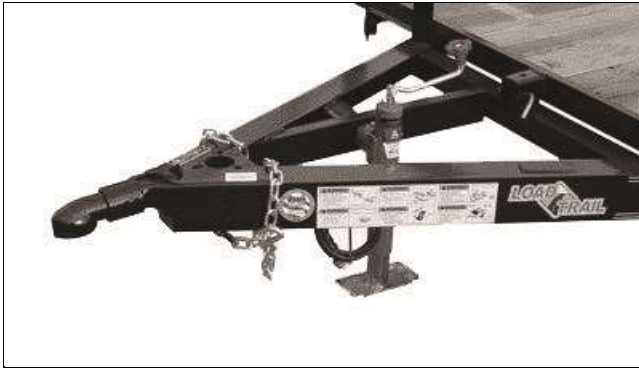

*Trailer With Ball Hitch Coupler*

We have utilized a ball hitch coupler that is suitable for the size and weight of the trailer. The load rating of the coupler and the necessary ball size are listed on the trailer tongue. You must provide a hitch and ball for your tow vehicle, where the load rating of the hitch and ball is equal to or greater than that of your trailer. Also, the ball size must be the same as the coupler size. If the hitch ball is too small, too large, is underrated, is loose or is worn, the trailer can come loose from the tow vehicle, and may cause death or serious injury.

Your trailer may be equipped with a Hydraulic Surge Brake Actuator. Surge braking is accomplished with an actuator and hydraulic brake assemblies. The "surge" or "push" of the trailer toward the tow vehicle during deceleration automatically synchronizes these trailer brakes with the tow vehicle brakes. As the trailer pushes against the vehicle, the actuator telescopes together and applies force to its master cylinder, supplying hydraulic pressure to the trailer's brakes. For more information, refer to the Surge Brake Actuator manual provided with your trailer. Direct questions regarding surge brake troubleshooting to the hydraulic brake manufacturer.



---

## Coupling To The Tow Vehicle

---

**THE TOW VEHICLE, HITCH AND BALL MUST HAVE A RATED TOWING CAPACITY EQUAL TO OR GREATER THAN THE TRAILER Gross Vehicle Weight Rating (GVWR).**

**IT IS ESSENTIAL THAT THE HITCH BALL BE OF THE SAME SIZE AS THE COUPLER.**

The ball size and load rating (capacity) are marked on the ball; hitch capacity is marked on the hitch.

### **4.3.1.1 Before Coupling The Trailer To The Tow Vehicle**

Be sure the size and rating of hitch ball match the size and rating of the coupler. Hitch balls and couplers are marked with their size and rating.

#### **WARNING**

**Coupler-to-hitch mismatch can result in uncoupling, leading to death or serious injury.**

**Be sure the LOAD RATING of the hitch ball is equal or greater than the load rating of the coupler.**

**Be sure the SIZE of the hitch ball matches the size of the coupler.**

- Wipe the hitch ball clean and inspect it visually and by feel for flat spots, cracks and pits.

#### **WARNING**

**A worn, cracked or corroded hitch ball can fail while towing, and may result in death or serious injury.**

**Before coupling trailer, inspect the hitch ball for wear, corrosion and cracks.**

**Replace worn or damaged hitch ball.**

- Rock the ball to make sure it is tight to the hitch, and visually check that the hitch ball nut is solid against the lock washer and hitch frame.
- Wipe the inside and outside of the coupler clean and inspect it visually for cracks and deformations; feel the inside of the coupler for worn spots and pits.
- Be sure the coupler is tight to the tongue of the trailer. All coupler fasteners must be visibly solid against the trailer frame.

## Coupling To The Tow Vehicle

### **WARNING**

**A loose hitch ball nut can result in uncoupling, leading to death or serious injury.**

**Make sure the hitch ball is tight to the hitch before coupling the trailer.**

- Raise the bottom surface of the coupler to be above the top of the hitch ball.

#### **4.3.1.2 Prepare The Coupler And Hitch**

- Lubricate the hitch ball and the inside of the coupler with a thin layer of automotive bearing grease.
- Remove the safety latch pin and open the coupler locking mechanism.
  - In the open position, the coupler is able to drop fully onto the hitch ball.
  - See the coupler instructions for details of placing the coupler in the “open” position.
- Slowly back up the tow vehicle so that the hitch ball is near or aligned under the coupler.

#### **4.3.1.3 Couple The Trailer To The Tow Vehicle**

- Lower the trailer tongue until the coupler fully engages the hitch ball. If the coupler does not line up with the hitch ball, adjust the position of the tow vehicle.
- Engage the coupler locking mechanism. In the engaged position, the locking mechanism securely holds the coupler to the hitch ball.
- Insert the safety lock pin through the hole in the locking mechanism.
- Be sure the coupler is all the way on the hitch ball and the locking mechanism is engaged. A properly engaged locking mechanism will allow the coupler to raise the rear of the tow vehicle. Using the trailer jack, test to see that you can raise the rear of the tow vehicle by 1 inch, after the coupler is locked to the hitch.

### **NOTICE**

**The tongue jack can be damaged by overloading. Do not use the tongue jack to raise the tow vehicle more than 1 inch.**

If the coupler cannot be secured to the hitch ball, do not tow the trailer. Contact your dealer for assistance.

- Lower the trailer so that its entire tongue weight is held by the hitch, and continue retracting the jack to its fully retracted position.
- Fully retract jack drop leg and insert pin.
- **Go to Section 4.3.3 “Connect Safety Chains – Bumper Pull Trailer” to continue connecting trailer to tow vehicle.**

---

## Coupling To The Tow Vehicle

---

### TRAILER WITH RING AND PINTLE COUPLER

A ring connects to the pintle that is located on or under the rear bumper of tow vehicle. This system of coupling a trailer to a tow vehicle is sometimes referred to as "bumper pull."

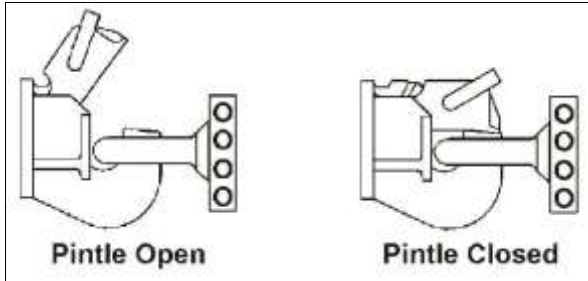

*Trailer With Ring and Pintle Coupler*

We have utilized a ring that is suitable for the size and weight of the trailer. The load rating of the ring and the necessary pintle size are listed on the trailer tongue. You must provide a pintle for your tow vehicle, where the load rating of the hitch and pintle is equal to or greater than that of your trailer. Also, the pintle size must be the same as the ring size. If the pintle is too small, too large, is underrated, is loose or is worn, the trailer can come loose from the tow vehicle, and may cause death or serious injury.

Your trailer may be equipped with a Hydraulic Surge Brake Actuator. Surge braking is accomplished with an actuator and adding hydraulic brake assemblies. The "surge" or "push" of the trailer toward the tow vehicle during deceleration automatically synchronizes these trailer brakes with the tow vehicle brakes. As the trailer pushes against the vehicle, the actuator telescopes together and applies force to its master cylinder, supplying hydraulic pressure to the trailer's brakes. For more information, questions and warranty issues, refer to the Surge Brake Actuator manual provided with your trailer.

**THE TOW VEHICLE, HITCH AND PINTLE MUST HAVE A RATED TOWING CAPACITY EQUAL TO OR GREATER THAN THE TRAILER Gross Vehicle Weight Rating (GVWR).**

**IT IS ESSENTIAL THAT THE PINTLE BE OF THE SAME SIZE AS THE COUPLER.**

The pintle size and load rating (capacity) are marked on the pintle; ring capacity is marked on the ring.

#### **4.3.1.4 Before Coupling The Trailer To The Tow Vehicle**

Be sure the size and rating of pintle match the size and rating of the ring. Hitch ring and pintles are marked with their size and rating.

## Coupling To The Tow Vehicle

### **WARNING**

**Coupler-to-hitch mismatch can result in uncoupling, leading to death or serious injury.**

**Be sure the LOAD RATING of the pintle is equal or greater than the load rating of the ring.**

**Be sure the SIZE of the pintle matches the size of the ring.**

- Wipe the pintle clean and inspect it visually and by feel for flat spots, cracks and pits.

### **WARNING**

**A worn, cracked or corroded pintle can fail while towing, and may result in death or serious injury.**

**Before coupling trailer, inspect the pintle for wear, corrosion and cracks.**

**Replace worn or damaged pintle.**

- Rock the pintle to make sure it is tight to the hitch, and visually check that the pintle fasteners are solid against the hitch frame.
- Wipe the inside and outside of the ring clean and inspect it visually for cracks and deformations; feel the inside of the ring for worn spots and pits.
- Be sure the ring is tight to the tongue of the trailer. All ring fasteners must be visibly solid against the trailer frame.

### **WARNING**

**A loose pintle can result in uncoupling, leading to death or serious injury.**

**Make sure the pintle is tight to the hitch before coupling the trailer.**

- Raise the bottom surface of the ring to be above the top of the open pintle.

#### **4.3.1.5 Prepare The Ring and Pintle**

- Lubricate the inside of the pintle with a thin layer of automotive bearing grease.
- Remove the safety latch pin and open the pintle locking mechanism.
  - In the open position, the ring is able to drop fully onto the pintle.

---

## Coupling To The Tow Vehicle

---

- See the coupler instructions for details of placing the pintle in the “open” position.
- Slowly back up the tow vehicle so that the pintle is near or aligned under the ring.

### 4.3.1.6 Couple The Trailer To The Tow Vehicle

- Lower the trailer tongue until the ring fully engages the pintle. If the ring does not line up with the pintle, adjust the position of the tow vehicle.
- Engage the pintle locking mechanism. In the engaged position, the locking mechanism securely holds the ring to the pintle.
- Insert the safety lock pin through the hole in the locking mechanism.
- Be sure the ring is all the way on the pintle and the locking mechanism is engaged. A properly engaged locking mechanism will allow the pintle to raise the rear of the tow vehicle. Using the trailer jack, test to see that you can raise the rear of the tow vehicle by 1 inch, after the coupler is locked to the hitch.

<b>NOTICE</b>
---------------

<b>The tongue jack can be damaged by overloading. Do not use the tongue jack to raise the tow vehicle more than 1 inch.</b>
---

If the ring cannot be secured to the pintle, do not tow the trailer. Contact your dealer for assistance.

- Lower the trailer so that its entire tongue weight is held by the hitch, and continue retracting the jack to its fully retracted position.
- Fully retract jack drop leg and insert pin.
- **Go to Section 4.3.3 “Connect Safety Chains – Bumper Pull Trailer” to continue connecting trailer to tow vehicle.**

### CONNECT SAFETY CHAINS – BUMPER PULL TRAILER

- Visually inspect the safety chains and hooks for wear or damage. Replace worn or damaged safety chains and hooks before towing.
- Rig the safety chains so that they:
  - Crisscross underneath the coupler so if the trailer uncouples, the safety chains can hold the tongue up above the road. Loop around a frame member of the tow vehicle or to holes provided in the hitch system (but, do **not** attach them to an interchangeable part of the hitch assembly).
  - Attach hooks up from underneath the hole (do not just drop into hole); and
  - Provide enough slack to permit tight turns, but not be close to the road surface to drag.

## Coupling To The Tow Vehicle

---

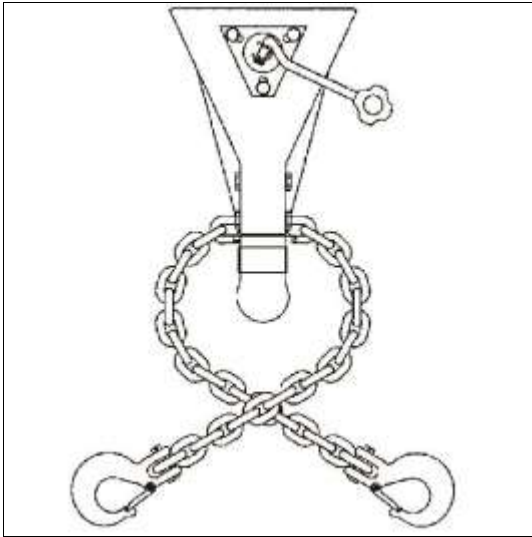

*Proper Safety Chain Arrangement*

### **⚠ WARNING**

**Incorrect rigging of the safety chains can result in loss of control of the trailer and tow vehicle, leading to death or serious injury, if the trailer uncouples from the tow vehicle.**

**Chains must:**

- **Fasten to frame of tow vehicle, not to hitch or ball.**
- **Cross underneath hitch and coupler with minimum slack to permit turning and to hold tongue up, if the trailer comes loose.**

### **CONNECT THE ELECTRICAL CABLE – BUMPER PULL TRAILERS**

Connect the trailer lights to the tow vehicle's electrical system using trailer electrical cable.

- Check **all** lights for proper operation. Repair or replace non-working lights before towing trailer.
- Check electric brakes for proper operation using brake controller mounted in the cab.

## Coupling To The Tow Vehicle

### **⚠ WARNING**

**Improper electrical connection between the tow vehicle and the trailer will result in inoperable lights and electric brakes, and can lead to collision.**

**Before each tow:**

- **Check that all lights and turn signals work.**
- **Check that the electric brakes work by operating the brake controller inside the tow vehicle.**

### **ATTACH BREAKAWAY BRAKE LANYARD – BUMPER PULL TRAILERS**

If the coupler or hitch fails, a properly connected and working breakaway brake system will apply the brakes on the trailer. The safety chains will keep the tow vehicle attached and as the brakes are applied at the trailer's axles, the trailer/tow vehicle combination will come to a controlled stop.

- Connect the lanyard to the tow vehicle so that the hydraulic actuator will engage or the electric brake pullpin will be pulled out before all of the slack in the safety chains is taken up. Do **not** connect the lanyard to a safety chain, hitch ball or hitch ball assembly. This would keep the breakaway brake system from operating when it is needed.

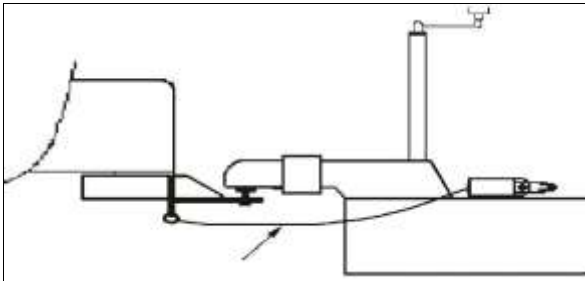

*Electric Breakaway Brake Lanyard*

#### **4.3.1.7 Test Electric Brakes**

If your trailer has electric brakes, your tow vehicle will have an electric brake controller that sends power to the trailer brakes. Before towing the trailer on the road, you must operate the brake controller while trying to pull the trailer in order to confirm that the electric brakes operate. While towing the trailer at less than 5 mph, manually operate the electric brake controller in the tow vehicle. You should feel the operation of the trailer brakes. If the trailer brakes are not functioning, the brake system **MUST** be evaluated to determine the cause of the problem and corrective action **MUST** be taken before the trailer is used. Take the unit to your dealer or a qualified brake specialist.

---

## Coupling To The Tow Vehicle

---

Use this procedure each time you tow your trailer to check your surge brake system operation.

### 4.3.1.8 Test Electric Breakaway Brakes

The breakaway brake system includes a battery, a switch with a pullpin and lanyard, and a breakaway brake controller. Read and follow the instructions here as well as the instructions that have been prepared by the breakaway brake manufacturer. If you do not have these instructions, contact your dealer for assistance.

The breakaway brake system battery will trickle charge from the tow vehicle. Dump trailers and trailers with 12 volt hydraulic pumps will use the hydraulic pump battery for the breakaway brakes and will not be equipped with the battery charger shown in figure below. If the electrical system on your tow vehicle does not provide power to the battery, you must periodically charge the battery with a commercial battery charger to keep the battery charged. Dump trailers and trailers with 12 volt hydraulic pumps have an on-board battery maintainer/charger. See the Accessories section.

The “Charging” lamp (1) will be illuminated when the battery is receiving a charge from the tow vehicle. Press the “Test” button (2) to test the battery level of charge. Do not tow trailer if the battery requires recharging. A discharged breakaway brake battery will not activate the brakes if the trailer uncouples from the tow vehicle. The battery must be fully charged before towing trailer



*Breakaway Brake Battery Charger*

- To test the breakaway brake battery, remove the pullpin from the switch and attempt to pull the trailer forward. You should feel the trailer resisting being towed, but the wheels will not necessarily be locked. If the brakes do not function, do not tow the trailer until brakes, or battery, are repaired.
- Immediately replace the pullpin. The breakaway brake system battery discharges rapidly when the pullpin is removed.



---

## Coupling To The Tow Vehicle

---

### **WARNING**

**An ineffective breakaway brake system can result in a runaway trailer, leading to death or serious injury, if the coupler or ball hitch fails.**

**Connect the breakaway cable to the tow vehicle; and NOT to the hitch, ball or support.**

**Before towing the trailer, test the function of the breakaway brake system. If the breakaway brake system is not working, do not tow the trailer. Have it serviced or repaired.**

Do **not** tow the trailer with the breakaway brake system ON because the brakes will overheat which can result in permanent brake failure.

### **WARNING**

**Failure to replace the pullpin can result in ineffective brakes, leading to loss of control, serious injury or death.**

If you do not use your trailer for three or more months, or during winter months:

- Store the battery indoors; and
- Charge the battery every three months.

Replace the breakaway brake battery according to the intervals specified by battery manufacturer.

#### **4.3.1.9 Test Surge Brakes (If equipped)**

Hydraulic surge actuator systems provide automatic and smooth trailer braking without special application by the tow vehicle driver. While this is extremely convenient it can sometimes be difficult to determine if the surge setup is functioning properly. The following steps provide a quick field-test to confirm that the trailer brake system is operational.

---

## Coupling To The Tow Vehicle

---

### **WARNING**

**The field-test procedure indicates only if the trailer brake system is functional, but DOES NOT provide information on how efficiently it will operate.**

**Regular inspection, maintenance, and adjustment of all brake system components (including the surge actuator, tubing, hoses, brake clusters, drums, and associated hardware/support structure) are still required to ensure maximum brake performance and smooth, even brake operation.**

Move the trailer to flat, level ground, pulling **FORWARD** several feet before parking. This forward motion will ensure trailers equipped with free-backing brakes are in their normal operating mode. Disconnect the trailer from the tow vehicle and jack up the trailer's tongue until it is horizontal.

Hook the trailer's safety chains (NOT the actuator's breakaway cable) together to form a loop, which is centered below the actuator's coupler. Place wheel chock blocks two feet behind the trailer to prevent a runaway trailer.

Place a sturdy board, such as a 2 inch by 4 inch piece of lumber, into the chain loop below the coupler. The board should be 4 feet or longer so it will extend several feet above the actuator. Keep the end of the board a few inches off the ground, and position it to press against the front end of the actuator's coupler. Press the board towards the rear of the trailer.

Keep pressing the top of the board to stroke the actuator and its internal master cylinder. If the trailer brake system is operational, the brakes will apply and keep the trailer from rolling away from you. Properly adjusted uni-servo or duo-servo type brakes will prevent you from moving the trailer back more than a few inches. Free-backing type brakes will initially provide rolling resistance, but continued force on the board will switch them into free-backing mode, and you'll be able to move the trailer backwards.

If you have uni-servo or duo-servo brakes, and stroking the actuator (as described above) causes the trailer to roll away from you freely or with only minimal resistance, the brakes are NOT applying properly. If you have free-backing brakes and stroking the actuator (as described above) causes the trailer to roll away without initial resistance, then the brakes are NOT applying properly. The brake system **MUST** be evaluated to determine the cause of the problem and corrective action **MUST** be taken before the trailer is used. Use this procedure each time you tow your trailer to check your surge brake system operation.

---

## Coupling To The Tow Vehicle

---

### 4.3.1.10 Test Surge Brake Breakaway System

Before towing, check that the breakaway lever and lanyard are properly positioned. If the breakaway lever and lanyard are not located correctly due to either the lanyard being pulled during use or by accident, it **MUST** be reset prior to the trailer being moved.

See the Surge Brake Actuator manual for the correct resetting and testing procedure.

### **WARNING**

**The breakaway system is designed to operate if the trailer separates from the tow vehicle.**

**DO NOT use the breakaway system as a parking brake.**

### UNCOUPLING A BUMPER PULL TRAILER

Follow these steps to uncouple your ball hitch trailer from the tow vehicle:

- Park the trailer on a firm level surface and block trailer tires.
- Disconnect the electrical connector.
- Disconnect the breakaway brake switch lanyard.
- Disconnect the safety chains from the tow vehicle.
- Unlock the coupler and open it.
- Before extending jack, make certain the ground surface below the jack pad will support the tongue load.
- Rotate the jack handle to extend the jack and transfer the weight of the trailer tongue to the jack.
- Raise the trailer coupler above the tow vehicle hitch.

### 4.4 GOOSENECK TRAILER WITH BALL RECEIVER

A gooseneck ball receiver on the trailer connects to a gooseneck ball that you must have installed in the bed of the tow vehicle. The following figure shows a trailer with a gooseneck ball receiver. If your trailer is equipped with a fifth wheel or king pin, see the instruction provided by the manufacturer.



*Gooseneck Trailer With Ball Receiver*

We have installed a receiver that is suitable for the size and weight of the trailer. The load rating of the coupler and the necessary ball size are listed on the gooseneck.

You must provide a gooseneck ball and support structure that is marked with a rating that meets or exceeds the GVWR of your trailer **and** matches the size of the gooseneck ball receiver. If the gooseneck ball is too small, is underrated, is loose or is worn, the trailer can come loose from the tow vehicle, and may lead to death or serious injury.

**THE TOW VEHICLE, SUPPORT STRUCTURE AND GOOSENECK BALL MUST HAVE A RATED TOWING CAPACITY EQUAL TO OR GREATER THAN THE TRAILER Gross Vehicle Weight Rating (GVWR). IT IS ESSENTIAL THAT THE GOOSENECK BALL BE OF THE SAME SIZE AS THE GOOSENECK BALL RECEIVER.**

## Coupling To The Tow Vehicle

### **⚠ WARNING**

**Coupler-to-hitch mismatch can result in uncoupling, leading to death or serious injury.**

**Be sure the LOAD RATING of the hitch ball is equal or greater than the load rating of the coupler.**

**Be sure the SIZE of the hitch ball matches the size of the coupler.**

A gooseneck trailer will have one or two drop leg jacks for raising and lowering the gooseneck ball receiver. Because several drop leg jack mechanisms are available, the general instructions below may vary slightly from the jack manufacturer's instructions. If the trailer jack on your trailer does not resemble the jack shown in the figure below, follow the instructions provided by the jack manufacturer. If you do not have these instructions, contact your dealer for assistance. Note: Inspect and lubricate jacks periodically for optimal performance. See the "Inspection, Service & Maintenance" section for service details.



*Drop Leg Jack*

### **BEFORE COUPLING THE TRAILER TO THE TOW VEHICLE**

- Be sure the size and rating of the gooseneck ball match the size and rating of the receiver.
- Wipe the gooseneck ball clean and inspect it visually and by feel for flat spots, cracks and pits.

---

## Coupling To The Tow Vehicle

---

### **WARNING**

**A worn, cracked or corroded gooseneck ball can fail while towing, and may result in death or serious injury.**

**Before coupling the trailer, inspect the gooseneck ball for wear, corrosion and cracks; and replace worn or damaged gooseneck ball.**

- Rock the ball to make sure it is tight to the ball support, and visually check that the gooseneck ball nut is solid against the lock washer and ball support frame.

### **WARNING**

**A loose gooseneck ball can result in uncoupling, leading to death or serious injury.**

**Make sure the gooseneck ball nut is tight before coupling the trailer.**

- Wipe the inside and outside of the receiver clean and inspect it visually for cracks; and feel the inside of the receiver for worn spots and pits. If any of these conditions exist, have the receiver replaced before coupling the trailer.
- Lubricate the inside of the receiver with automotive bearing grease.
- Be sure the receiver is tight to the trailer. All receiver fasteners must be visibly solid against the trailer frame.
- Release the jack handle or crank from its holder.
- Rotate the handle/crank clockwise to raise the bottom surface of the gooseneck to be above the top of the gooseneck ball.

### **PREPARE THE BALL AND RECEIVER**

- Release the lock plate on the gooseneck ball receiver. With the spring-loaded lock plate locking pin in the OPEN position, rotate the lock plate to a position that allows the gooseneck ball to enter the receiver.
- Slowly back up the tow vehicle so that the ball is aligned under the receiver.

### **WARNING**

**If the trailer drops during coupling, death or serious injury may result.**

**There must be no one under the trailer or coupler before or during the coupling operation.**

---

## Coupling To The Tow Vehicle

---

### COUPLE THE TRAILER TO THE TOW VEHICLE

- Rotate the jack handle counter-clockwise. This will retract the jack causing the receiver to drop down so it can fully engage the ball and transfer the weight of the trailer tongue to the towing vehicle hitch. If the receiver does not line up with the ball, raise the receiver again and adjust the position of the tow vehicle. Then lower the receiver over the ball. When the drop leg base is no longer resting on the ground, the towing vehicle hitch is holding all of the weight of the trailer tongue.
- Close the lock plate on the receiver.
- Move the spring-loaded lock plate locking pin to the CLOSED position. Be sure the locking pin is holding the lock plate.
- Be sure the receiver is all the way on the ball and the lock plate is engaged. A properly engaged locking mechanism will allow the coupler to raise the rear of the tow vehicle. Using the trailer jack, test to see that you can raise the rear of the tow vehicle by 1 inch.

### NOTICE

**The jack can be damaged by overloading. Do not use the jack to raise the tow vehicle more than 1 inch.**

If the receiver cannot be secured to the ball, do not tow the trailer. Contact your dealer for assistance.

After testing to see that the receiver is properly secured and locked to the ball, retract the jack to its fully retracted position.

- Return the drop leg(s) to their upper positions. The drop leg(s) are held in the lowered position with a plunger pin. Rotating the plunger pin while pulling it outward will cause it to come out of engagement with the drop leg and the leg will rapidly rise.

### CAUTION

**The drop legs are heavily spring loaded in the lowered position. They will rapidly return to the upper position when released and can inflict serious bruises, scrapes or pinching.**

**Keep your feet, shins and hands well clear of the drop legs and drop leg bases when releasing the drop legs.**

### CONNECT THE SAFETY CHAINS

- Visually inspect the safety chains and hooks for wear or damage. Replace worn or damaged safety chains and hooks before towing.

## Coupling To The Tow Vehicle

---

- Rig the safety chains so that they attach to the “safety chain receivers” in the bed of the truck. If you are not certain of the hitch provisions for receiving safety chains, contact the hitch manufacturer or installer. Do NOT attach the safety chains to the gooseneck ball or its support; and
- Rig the safety chains so they have sufficient slack to permit turning, but not too much slack – the safety chains must keep the gooseneck on the tow vehicle bed if the trailer uncouples.

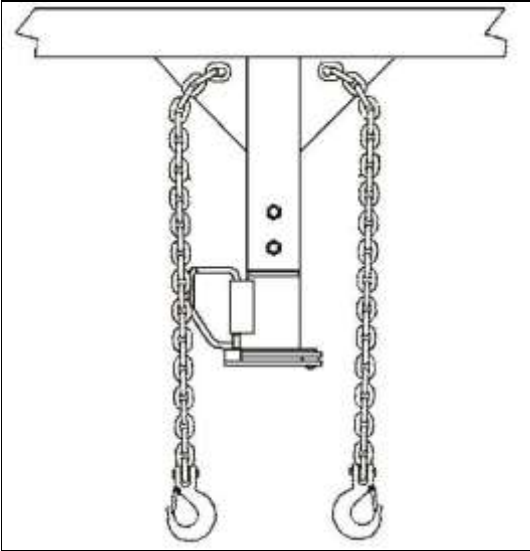

*Safety Chain Arrangement*

### **⚠ WARNING**

**Improper rigging of the safety chains can result in loss of control of the trailer and tow vehicle, leading to death or serious injury, if the trailer uncouples from the tow vehicle.**

- **Fasten chains to safety chain receivers on the hitch, not to ball.**
- **Have sufficient slack to permit turning and to keep gooseneck on bed of the tow vehicle, if the trailer comes loose.**

### **CONNECT THE ELECTRICAL CABLE**

Connect the trailer lights to the tow vehicle's electrical system using the electrical connector.

- Check all lights for proper operation:
- Check electric brakes for proper operation



## Coupling To The Tow Vehicle

### **⚠ WARNING**

**Improper electrical connection between the tow vehicle and the trailer will result in inoperable lights and electric brakes, and can lead to collision.**

**Before each tow:**

- **Check that all lights and turn signals work.**
- **Check that the electric brakes work by operating the brake controller inside the tow vehicle.**

### **ATTACH BREAKAWAY BRAKE LANYARD**

If the coupler or hitch fails, a properly connected and working breakaway brake system will apply the brakes on the trailer. The safety chains will keep the tow vehicle attached and as the brakes are applied at the trailer's axles, the trailer/tow vehicle combination will come to a controlled stop.

- Connect the lanyard to the tow vehicle so that the electric brake pullpin will be pulled out before all of the slack in the safety chains is taken up. Do **not** connect the lanyard to a safety chain, hitch ball or hitch ball assembly. This would keep the breakaway brake system from operating when it is needed.

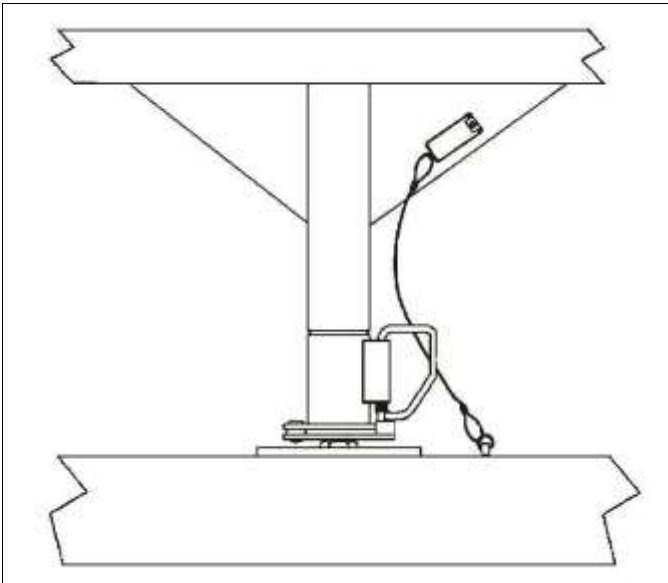

*Electric Breakaway Brake Lanyard*

---

## Coupling To The Tow Vehicle

---

### 4.4.1.1 Test Electric Brakes

If your trailer has electric brakes, your tow vehicle will have an electric brake controller that sends power to the trailer brakes. Before towing the trailer on the road, you must operate the brake controller while trying to pull the trailer in order to confirm that the electric brakes operate. While towing the trailer at less than 5 mph, manually operate the electric brake controller in the tow vehicle. You should feel the operation of the trailer brakes. If the trailer brakes are not functioning, the brake system **MUST** be evaluated to determine the cause of the problem and corrective action **MUST** be taken before the trailer is used. Please consult your dealer.

Use this procedure each time you tow your trailer to check your surge brake system operation.

### 4.4.1.2 Test Electric Breakaway Brakes

The breakaway brake system includes a battery, a switch with a pullpin and lanyard, and a breakaway brake controller. Read and follow the instructions here as well as the instructions that have been prepared by the breakaway brake manufacturer. If you do not have these instructions, contact your dealer for assistance.

The breakaway brake system battery will trickle charge from the tow vehicle. Dump trailers and trailers with 12 volt hydraulic pumps will use the hydraulic pump battery for the breakaway brakes and will not be equipped with the battery charger shown in figure below. If the electrical system on your tow vehicle does not provide power to the battery, you must periodically charge the battery with a commercial battery charger to keep the battery charged. Dump trailers and trailers with 12 volt hydraulic pumps have an on-board battery maintainer/charger. See the Accessories section.

The “Charging” lamp (1) will be illuminated when the battery is receiving a charge from the tow vehicle. Press the “Test” button (2) to test the battery level of charge. Do not tow trailer if the battery requires recharging. A discharged breakaway brake battery will not activate the brakes if the trailer uncouples from the tow vehicle. The battery must be fully charged before towing trailer.



*Breakaway Brake Battery Charger*

---

## Coupling To The Tow Vehicle

---

- To test the breakaway brake battery, remove the pullpin from the switch and attempt to pull the trailer forward. You should feel the trailer resisting being towed, but the wheels will not necessarily be locked. If the brakes do not function, do not tow the trailer until brakes, or battery, are repaired.
- Immediately replace the pullpin. The breakaway brake system battery discharges rapidly when the pullpin is removed.

### **WARNING**

**An ineffective breakaway brake system can result in a runaway trailer, leading to death or serious injury, if the coupler or ball hitch fails.**

**Connect the breakaway cable to the tow vehicle; and NOT to the hitch, ball or support.**

**Before towing the trailer, test the function of the breakaway brake system. If the breakaway brake system is not working, do not tow the trailer. Have it serviced or repaired.**

Do **not** tow the trailer with the breakaway brake system ON because the brakes will overheat which can result in permanent brake failure.

### **WARNING**

**Failure to replace the pullpin can result in ineffective brakes, leading to loss of control, serious injury or death.**

If you do not use your trailer for three or more months, or during winter months:

- Store the battery indoors; and
- Charge the battery every three months.

Replace the breakaway brake battery according to the intervals specified by battery manufacturer.

### **UNCOUPLING GOOSENECK TRAILER WITH BALL COUPLER**

Follow these steps to uncouple your gooseneck hitch trailer from the tow vehicle:

- Park the trailer on a firm level surface.
- Block trailer tires to prevent the trailer from rolling, before jacking the trailer up
- Lower the tow vehicle tailgate.
- Disconnect the electrical connector.
-

---

## Coupling To The Tow Vehicle

---

- Disconnect the breakaway brake switch lanyard.
- Disconnect the safety chains from the tow vehicle.
- Move the spring-loaded receiver lock plate locking pin to the OPEN position.
- Rotate the lock plate to a position that permits the gooseneck ball to exit the receiver.
- Before releasing dropleg jack, make certain ground surface below jack base will support the trailer tongue load.
- Rotate the drop leg plunger pin handle so that the plunger pin is released from the drop leg.
- Push down on the drop leg base with your foot to place a drop leg to the desired lowered position.
- Rotate the plunger pin handle so that the plunger pin is attempting to engage the drop leg.
- Slowly raise your foot, permitting the drop leg to rise. The plunger pin will engage a hole in the drop leg.

### **⚠ CAUTION**

**The drop legs are heavily spring loaded in the lowered position. They will rapidly return to the upper position when released and can inflict serious bruises, scrapes or pinching.**

**Keep your feet, shins and hands well clear of the drop legs and drop leg bases when releasing the drop legs.**

**Always wear shoes or boots while performing this operation**

- Be sure the plunger pin is fully engaged. Push it in by hand if necessary. The bent part of the plunger pin handle must be touching the plunger pin housing.
- If your trailer has two drop leg jacks, lower them both to the same level, following the above instructions.

### **NOTICE**

**If the drop legs are not set at the same level, one of the drop leg jacks can be overloaded and can be damaged.**

- Release the handle (or crank) from its holder and engage it with the jack shaft.
- Rotate the handle (or crank) clockwise to slowly extend the jack and transfer the weight of the trailer tongue to the jack.
- On two speed jacks, move the handle to engage high speed mode.
- When the drop leg base contacts the ground, shift the gearbox into low speed mode.

### NOTICE

**Do not use high speed to lift the trailer, the drop leg jack mechanism can be damaged.**

**High speed is used only to rapidly move the drop leg base into contact with the ground.**

- Continue to extend the jack(s), making sure that the ground is providing stable and level support for the trailer.
- After the jack(s) are extended and the gooseneck ball receiver is well clear of the gooseneck ball, to permit driving the tow vehicle away, disengage the handle from its shaft and return to its holder.

## 4.5 TONGUE WEIGHT

It is critical to have a portion of the trailer load carried by the tow vehicle. That is, the trailer tongue must exert a downward force on the hitch. This is necessary for two reasons. First, the proper amount of tongue weight is necessary for the tow vehicle to be able to maintain control of the tow vehicle/trailer system. If, for example, the tongue exerts an upward pull on the hitch, instead of pushing down on it (because the trailer is overloaded behind its axle(s)), the rear wheel of the tow vehicle can lose traction or grip and cause loss of control. Also, even if there is some weight on the tongue, but not enough weight on the tongue, the trailer can become unstable at high speeds. Remember, the faster you go the more likely the trailer is to sway.

If, on the other hand, there is too much tongue weight, the tow vehicle is prone to jack-knife. Furthermore, the front wheels of the tow vehicle can be too lightly loaded and cause loss of steering control and traction, if the front wheels are driving.

In addition to tow vehicle control, tongue weight is necessary to insure that the trailer axle(s) do not exceed their Gross Axle Weight Rating (GAWR).

In the following table, the second column notes the rule of thumb percentage of total weight of the trailer plus its cargo (Gross Vehicle Weight, or "GVW") that should appear on the tongue of the trailer. For example, a trailer with a gooseneck hitch, with a loaded weight of 12,000 pounds, should have 20-25% of 12,000 pounds on the tongue. That is, the example trailer would have 2,400 to 3,000 pounds on its tongue.

## Coupling To The Tow Vehicle

Tongue Weight as a Percentage of Loaded Trailer Weight	
Type of Hitch	Percentage
Ball Hitch (or Bumper Hitch)	10-15% for large trailers 6-10% for smaller utility trailers
Gooseneck	20-25%

### **WARNING**

**Improper tongue weight (load distribution) can result in loss of control of the trailer, leading to death or serious injury.**

**Make certain that tongue weight is within the allowable range.**

**Be sure to:**

- **Distribute the load front-to-rear to provide proper tongue weight (see chart);**
- **Distribute the load evenly, right and left, to avoid tire overload; and**
- **Keep the center of gravity low.**

### **CHECKING TONGUE WEIGHT**

To check the tongue weight, the tow vehicle and trailer must be on level ground, as they will be when the trailer is being towed.

Take the trailer to a truck stop or grain elevator where there is a “certified” scale. Place the tow vehicle only onto the scale and get the weight. This weight must be less than your tow vehicle’s GVWR. Pull the trailer onto the scale and uncouple it from the tow vehicle, leaving just the trailer on the scale. Get a ticket which lists the total trailer weight. Re-connect the trailer to your tow vehicle and drive the tow vehicle wheels off the scale, just leaving the trailer axles on the scale. Get a “ticket”, which lists the trailer’s axle weight. Simply subtract the axle weight from the total weight to determine the hitch weight.

While you are at the scale, you should weigh the entire combination vehicle. This result should be less than the Gross Combined Weight Rating (GCWR) for your towing vehicle. Some scales allow you to get individual axle weights also. If this is possible, get the tow vehicles front and rear axle weights to make sure they are in the same proportion as the tow vehicle alone, and that the rear axle is not overloaded. This is the best way to check that a weight distribution (or loadleveling) hitch is adjusted properly, i.e., you have the proper number of chain links attached to the snap-up brackets.

## Coupling To The Tow Vehicle

### 4.6 ADJUST BUMPER PULL TRAILER HITCH HEIGHT

The height of the hitch on the trailer must be adjusted so that the trailer, when loaded to rated capacity, is level while connected to the tow vehicle. A level trailer allows equal weight distribution on the axles.

Your dealer or a trailer service center can perform this adjustment or you can use the following steps to adjust the hitch height yourself.

#### **WARNING**

**Improper hitch height adjustment can result in overloaded tires, blowout and loss of control, leading to death or serious injury.**

**Adjust the hitch height so that the loaded trailer is level.**

- Connect trailer to tow vehicle and load the trailer to rated capacity (see Loading and Unloading the Trailer).
- Park the tow vehicle and trailer on a firm level surface.
- Stand away from the trailer and visually verify if the trailer is level front-to-rear. If the front of the trailer is higher than the rear, the hitch must be raised. If the front of the trailer is lower than the rear, the hitch must be lowered.
- Uncouple trailer from tow vehicle (See Uncoupling a Bumper Pull Trailer).
- Remove the lock nuts and bolts (1) on hitch. **Discard** lock nuts. Inspect bolts for damage and replace if necessary. Contact your dealer for the correct size and grade of bolts.

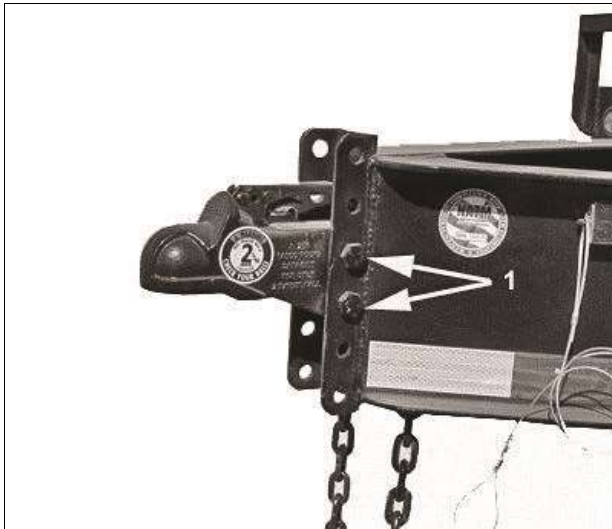

*Adjust Hitch Height*

## Coupling To The Tow Vehicle

### **WARNING**

**Used lock nuts are prone to loosen, resulting in the hitch separating from the trailer, which can lead to death or serious injury.**

**NEVER re-use a lock nut.**

**Use new lock nuts each time the hitch height is adjusted.**

**Contact your dealer for the proper grade and size of lock nut.**

- Raise or lower the hitch as necessary.
- Install bolts (1) and **NEW** lock nuts.
- Tighten lock nuts to 100 lb/ft of torque.
- Couple the trailer to the tow vehicle and verify that the trailer is level front to rear. Adjust if necessary.
- Unload trailer (see Loading and Unloading The Trailer) and disconnect from tow vehicle (see Uncoupling a Bumper Pull Trailer).

### **4.7 ADJUST GOOSENECK COUPLER HEIGHT**

The height of the ball receiver on the trailer must be adjusted so that the trailer, when loaded to rated capacity, is level while connected to the tow vehicle. A level trailer allows equal weight distribution on the axles. There must also be adequate clearance between the bottom of the trailer and the sides of the tow vehicle bed.

Connect trailer to tow vehicle (see Coupling To The Tow Vehicle) and load the trailer to rated capacity (see Loading and Unloading The Trailer). Park the tow vehicle and trailer on a firm level surface.

Stand back from the trailer and visually verify if the trailer is level front-to-rear. If the front of the trailer is higher than the rear, the hitch must be retracted. If the front of the trailer is lower than the rear, the hitch must be extended.

Uncouple trailer from tow vehicle (See Coupling To The Tow Vehicle).

Loosen the jam nut and setscrew (1). Remove safety lock pin (2) and load bearing pin (3). Extend or retract the receiver as needed. The maximum the receiver can be extended is 8 inches from the fully retracted position.

Insert load bearing pin (3) through holes in inner and outer tubes and install safety lock pin (2). Tighten setscrew (1) to 88 lb/ft of torque. Tighten jam nut to 85 lb/ft of torque. **Never** use the setscrew or any other device as a replacement for the load bearing pin (3).



## Coupling To The Tow Vehicle

### **⚠ WARNING**

**Improper gooseneck height adjustment can result in overloaded tires, blowout and loss of control, leading to death or serious injury.**

**Adjust the gooseneck receiver so that the loaded trailer runs level.**

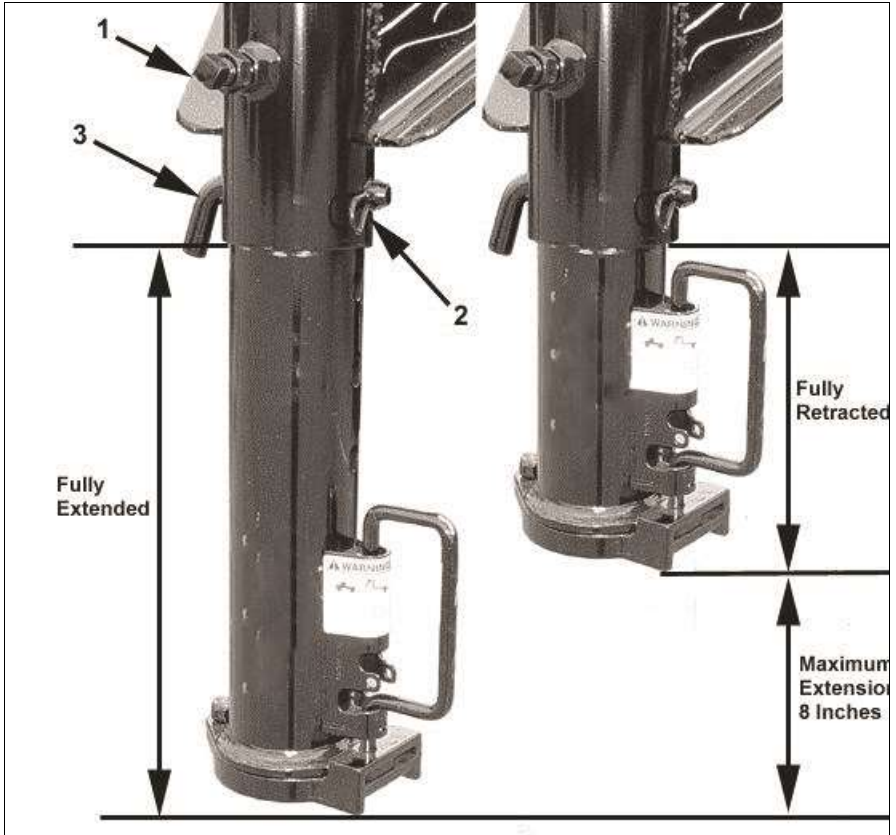

*Gooseneck Height Adjustment*

Note: Inspect coupler periodically for debris inside receiver. See the “Inspection, Service & Maintenance” section for service details.

## 5 LOADING AND UNLOADING A DUMP TRAILER

Improper trailer loading causes many accidents and deaths. To safely load a trailer, you must consider:

- Overall load weight;
- Load weight distribution;
- Proper tongue weight; and
- Securing the load properly.

To determine that you have loaded the trailer within its rating, you must consider the *distribution* of weight, as well as the total weight of the trailer and its contents. The trailer axles carry most of the total weight of the trailer and its contents (Gross Vehicle Weight, or “GVW”). The remainder of the total weight is carried by the tow vehicle hitch. It is essential for safe towing that the trailer tongue and tow vehicle hitch carry the proper amount of the loaded trailer weight, otherwise the trailer can develop an undesirable sway at towing speeds, or the rear of the towing vehicle can be overloaded. Read the “Tongue Weight” information in Section 4.

The load distribution must be such that no component part of the trailer is loaded beyond its rating. This means that you must consider the rating of the tires, wheels and axles. For tandem and triple axle trailers, you must make sure that the front-to-rear load distribution does not result in overloading any axle.

Towing stability also depends on keeping the center of gravity as low as possible. Load heavy items on the floor and over the axles. When loading additional items, be sure to maintain even side-to-side weight distribution and proper tongue weight. The total weight of the trailer and its contents must never exceed the total weight rating of the trailer (Gross Vehicle Weight Rating, or “GVWR”).

### 5.1 HAZARDS FOR DUMP TRAILERS

A dump trailer is specifically designed for hauling cargo that is to be dumped, and equipment or palletized loads, not for transporting livestock. The major hazards associated with dump trailers are:

- Overloading.
- Improper weight distribution; both side to side and front to back.
- Getting under a raised dump body.
- Not using, or improperly using the body prop.
- Modifying or altering hydraulic components.
- Modifying or altering dump controls.
- Not dumping from a solid and level foundation.
- Not fully opening rear doors when dumping.
- Jerking the trailer, or hydraulics, to loosen the load.
- Trailer coming near or contacting overhead power lines when body is raised.

---

## Loading And Unloading A Dump Trailer

---

### **WARNING**

**An overloaded trailer can result in loss of control of the trailer, leading to death or serious injury.**

**Do not exceed the trailer Gross Vehicle Weight Rating (GVWR) or an axle Gross Axle Weight Rating (GAWR).**

**Do not load a trailer so that the weight on any tire exceeds its rating.**

### **WARNING**

**A soft and/or uneven surface may cause the tow vehicle and trailer to tip over when the dump body is raised.**

**Raise the dump body ONLY if the tow vehicle and trailer are both on a firm and level surface.**

### **WARNING**

**An overloaded trailer or improperly distributed load can result in death or serious injury.**

**An overloaded trailer can cause the hydraulic system to malfunction, resulting in the dump body falling.**

**A load that is improperly distributed in the trailer can result in the trailer tipping over when the dump body is raised.**

### **DANGER**

**NEVER alter or substitute any hydraulic system component. Death or serious injury may result.**

**An altered or component substituted hydraulic system may malfunction, resulting in the dump body falling without warning.**

**NEVER alter or substitute any hydraulic system component.**

**⚠ WARNING**

**Risk of electrocution.**

**Dump body coming near or contacting power lines can cause electrocution. Electrocution can occur without contact.**

**Be sure there are no overhead power lines over or near the trailer before raising dump body.**

## 5.2 RAMP WEIGHTS

**⚠ CAUTION**

**Ramp and gate weights shown do not reflect or suggest the load capacity of the ramps or gates.**

**Weights shown are subject to change due to changes in construction materials or changes in design.**

**Use a safe lifting procedure to avoid injury when lifting ramps.**

See table in Section 6.1 for ramp weights.

## 5.3 LOADING FIXED LOADS

Fixed loads include palletized materials, skid-steer loaders, mowers, etc.

Fixed loads that are to be carried or dumped should be loaded evenly throughout the trailer. Too much load in the front portion will strain and possibly overload the hydraulic hoist. Too much load in the rear can lead to trailer swaying at highway speeds.

- Couple the trailer to the tow vehicle.
- Park the tow vehicle and trailer on a firm and level surface, both front-to-back and side-to-side. Attempting to load on a soft or uneven surface may cause the trailer to overturn, which can result in death or serious injury.

## Loading And Unloading A Dump Trailer

### **⚠ WARNING**

**Load can suddenly move or topple, which can result in death or serious injury.**

**Do not load or unload trailer unless coupled to tow vehicle and is on a firm and level surface.**

- Inspect the tie down rings for any damage or cracks.
- Clear the area around the trailer.

### **REAR LOADING EQUIPMENT**

- Place blocking under the rear of the trailer so the weight of the cargo does not raise the front of the trailer during loading.
- Open both rear swing doors and secure open with door hold back latch (1).



*Door Hold Back Latch*

### **⚠ CAUTION**

**The weight of each dump trailer loading ramp is 89 lbs.**

**Use a safe lifting procedure to avoid injury when handling ramps.**

- For trailers with under deck ramps, remove safety lock pins (2), open covers and pull ramps from storage position

## Loading And Unloading A Dump Trailer

---



*Ramp Safety Lock Pins*

- For trailers with ramps stored over the fenders, lift up on ramps to remove from storage position.

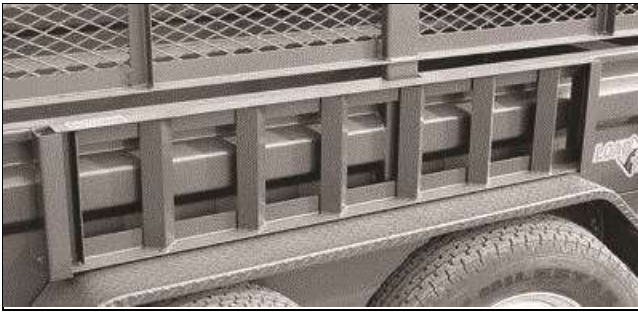

*Over Fender Ramp Storage*

- Place angle bracket (3) on ramps over trailer bracket (4) as shown in figure below.

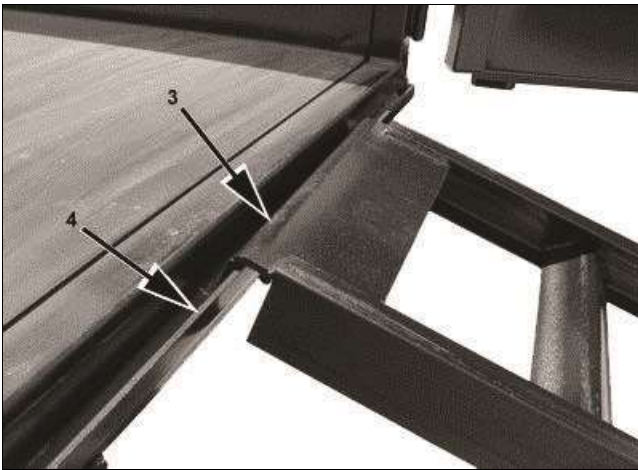

*Install Ramps*

---

## Loading And Unloading A Dump Trailer

---

- Place the ramps at the proper width and load the equipment. The operator must be experienced and skilled to perform the loading and unloading.

### **⚠ CAUTION**

**Ramps are NOT RATED for load bearing capacity. They will NOT support the load bearing capacity of the trailer.**

**Do not overload the ramps.**



*Dump Ramps Installed*

- Secure the cargo to the trailer using appropriate straps, chains and tensioning devices. Refer to [www.fmcsa.dot.gov](http://www.fmcsa.dot.gov) for regulations regarding cargo securement rules.
- Remove ramps and place in storage position. If equipped, close ramp covers and install safety lock pins (2) on ramp covers.
- Close and secure rear doors.
- Remove blocking under rear of trailer.

## Loading And Unloading A Dump Trailer

### 6' HD HYDRAULIC RAMP GATE

#### Detailed Overview & Operating Instructions

Prior to operation of gate, selector valve in front tool box must be placed in gate position.

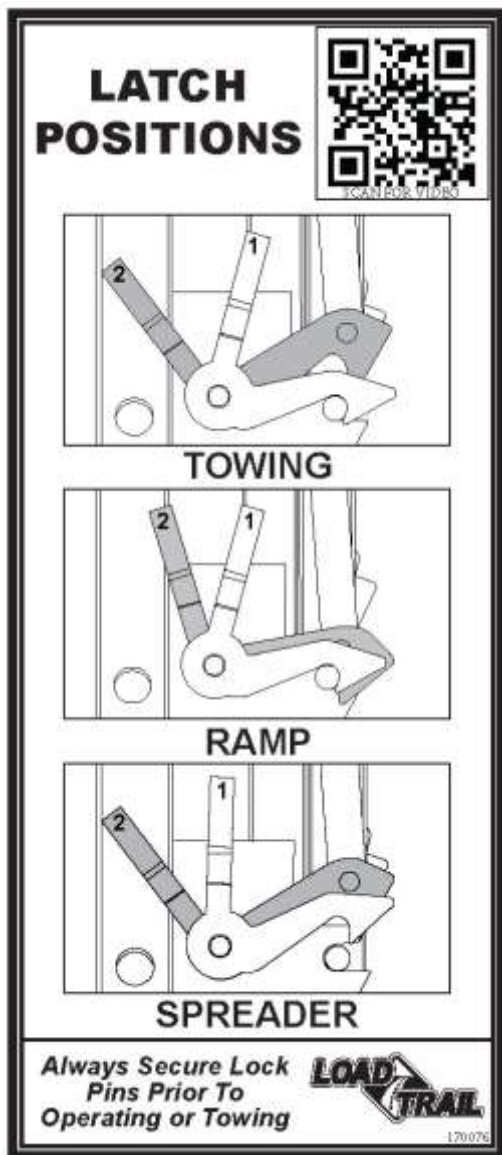



# Loading And Unloading A Dump Trailer

## Detailed Overview & Operating Instructions



\*WARNING – Failure to follow instructions may cause serious injury or death\*

### 5.3.1.1 Towing Operation

- 1) Secure top and bottom pins before towing trailer. Always secure lock pins prior to operating or towing.



### 5.3.1.2 Ramp Operation

- 1) Set rear support stands on the ground and secure with pins.



- 2) Engage both latches and secure with spring pins. Always secure lock pins prior to operating.

## Loading And Unloading A Dump Trailer

---



- 3) Let ramp down for loading.  
**\*WARNING – STAND CLEAR DURING OPERATION\***  
NEVER stand behind the rear of fenders. Keep 8 ft. clearance to rear and direct sides of gate.



### 5.3.1.3 Spreader Gate Operation

- 1) Disengage both latches and secure with spring pins. Always secure lock pins prior to operating.



- 2) Raise gate for spreading.



When gate operation is complete, selector valve switch must be placed back in dump bed position.

## Loading And Unloading A Dump Trailer

---

### **SIDE LOADING PALLETIZED MATERIAL**

Trailers Equipped With Fold Down Sides Only.

### **⚠ WARNING**

**Risk of death or serious injury.**

**Trailer is not designed to load or unload equipment from the side.**

**Do not attempt to load or unload equipment from the side of the trailer.**

- Pull spring loaded pins (1) and turn to lock on the front and rear of the trailer.



*Rear Side Lock Pin*

- Carefully lay down the side panel.



*Left Side Panel Fully Lowered*

---

## Loading And Unloading A Dump Trailer

---

- Materials such as pallets can now be loaded from the side.
- Secure the cargo to the trailer using appropriate straps, chains and tensioning devices. Refer to [www.fmcsa.dot.gov](http://www.fmcsa.dot.gov) for regulations regarding cargo securement rules.

### **WARNING**

**Towing the trailer with side panel lowered creates a driving hazard, which may result in death or serious injury.**

**Both side panels must be raised and locked before towing trailer.**

- Raise and lock side panels before towing trailer.

## 5.4 LOADING AND UNLOADING BULK MATERIALS

**Payload Capacity:** Check if the trailer has “payload” decals on the sides. If not, then determine the payload, or cargo capacity, by subtracting the empty weight of the trailer from the GVWR given on the Certification / VIN tag. Determine the density of the material to be loaded and dumped so that you will know, approximately, the amount of material may be safely loaded, carried, and dumped.

### **WARNING**

**Trailer, hitch or dump body can fail.**

**You or others can die or be seriously injured.**

**Load in the trailer must not exceed capacity and must be distributed evenly.**

### **PREPARE TRAILER FOR LOADING**

Couple the trailer to the towing vehicle before loading. This is essential because the tongue can rise during loading. To measure the tongue weight you will have to uncouple the trailer after it is loaded.

Be sure the trailer is located on firm level ground. Attempting to load on uneven ground may cause the trailer to overturn, which can result in serious injury or death.

Do not transport people, containers of hazardous substances, or flammable liquids. The exception is fuel in the tank of vehicles or equipment being hauled.

---

## Loading And Unloading A Dump Trailer

---

### **WARNING**

**Do not transport flammable, explosive, poisonous or other dangerous materials in your trailer. The exception is fuel in the tank of vehicles or equipment being hauled.**

### **WARNING**

**RAISED DUMP BODY CAN DROP OR TIP OVER SUDDENLY. YOU AND OTHERS CAN DIE OR BE SERIOUSLY INJURED.**

**YOU MUST:**

- **Have trailer on level, firm ground before dumping.**
  - **Keep others away while dumping.**
  - **Stay at controls until dump body is down.**
- NEVER LEAVE THE SCENE WHEN DUMP BODY IS LIFTED.**

- **Lock hoist controls after use.**
- **Have dump body down before moving trailer.**
- **Use body prop and have dump body empty before getting under raised dump body.**
- **If the hoist does not lift the load, manually reduce the load - obtain service from a qualified hydraulics technician.**

**NEVER ASSIST THE HOIST. (i.e., with a jack, crane, heavy equipment, etc.)**

- **If the load does not leave the dump body, lower the dump body and manually free the load.**
- **Never attempt to free a load from a raised dump body.**

### **LOADING BULK MATERIAL**

- Couple the trailer to the tow vehicle.
- Park the trailer and tow vehicle on a firm and level surface, both side-to-side and front-to-rear.
- Check the dump body for damage. Repair before loading trailer.
- Close and latch trailer gates.
- Tell the loader operator the GVWR of your trailer. The loader operator will have an approximate weight of the material to be loaded.
- Use common sense when loading. If you are uncertain of the weight of the material, load a small amount and weigh your trailer. It is much easier to add to a light load than to remove material from an overloaded trailer.

## Loading And Unloading A Dump Trailer

- Level (evenly distribute) the load within the trailer from front to back and from side to side.
- If material may blow out while driving, tarp the trailer.
- If the trailer is overloaded, **DO NOT attempt to raise the dump body**. The excess material must be removed by equipment designed for this purpose, or by hand.

### UNLOAD BULK MATERIAL USING THE SPREADER GATE

If trailer is equipped with Hydraulic Jacks, please follow instructions below regarding operation of selector valve.



- Read and understand the hoist operating procedure before operating the dump body.
- Clear the area around the dump trailer.
- Park the tow vehicle and trailer on a firm and level surface both side-to-side and front-to-rear. Attempting to unload on a soft or uneven surface may cause the trailer to overturn, which can result in death or serious injury.
- For spreading material, the surface in which the tow vehicle and trailer will travel **MUST** be firm and level.

### **⚠ WARNING**

**A soft and/or uneven surface may cause the tow vehicle and trailer to overturn when the dump body is raised or while spreading material.**

**Raise the dump body ONLY if the tow vehicle and trailer are both on a firm and level surface.**

## Loading And Unloading A Dump Trailer

### **⚠ WARNING**

**An overloaded trailer or improperly distributed load can result in death or serious injury.**

**An overloaded trailer can cause the hydraulic system to malfunction, resulting in the dump body falling.**

**A load that is improperly distributed in the trailer can result in the trailer overturning when the dump body is raised.**

- Set the metering chains (1) at the desired number of links to control the opening distance of the spreader gate. Be sure to set both chains at equal length. Push forward on lever (2) to unlock spreader gate.



*Set Metering Chains and Unlock Spreader Gate*

### **⚠ WARNING**

**Loaded materials can exert pressure against the spreader gate.**

**This may cause the spreader gate to swing out with force when unlocked, causing serious injury.**

**Stand on the side of the trailer to unlock spreader gate.**

- Open the battery box and support lid with prop rod. Locate the dump body controller. While using the dump body controller, position yourself in a safe location clear of the dump body. Check for overhead power lines and other obstructions before raising dump body.

## Loading And Unloading A Dump Trailer

### **DANGER**

**A lowering or falling dump body can result in death or serious injury.**

**NEVER enter the area under the dump body unless the empty dump body is supported by the body prop.**

### **DANGER**

**The body prop is designed to support an empty dump body only.**

**NEVER support a loaded dump body by the body prop.**

**Unload the dump body before using body prop.**

### **WARNING**

**Risk of electrocution.**

**Dump body coming near or contacting power lines may result in electrocution. Electrocution can occur without contact.**

**Be sure there are no overhead power lines over or near the trailer before raising dump body.**

- Press and hold button (3) to raise the dump body. Release the button when the body has reached approximately the halfway point of its dumping angle, or if the load begins to shift rearward. Never leave the dump body control when operating the dump body.



## Loading And Unloading A Dump Trailer



*Dump Controller*

### **⚠ WARNING**

**Fully raising the loaded dump body may result in the tow vehicle rear wheels losing traction.**

**Do not fully raise a loaded dump body or place the entire load at the rear of trailer.**

- Return the dump body control to the battery box. Watch for and avoid obstructions such as tree limbs, overhead lines, potholes, etc. and SLOWLY drive the tow vehicle and trailer ahead to spread the material.
- **DO NOT** drive forward and stop quickly to “shock” the load out of the body. **DO NOT** “jerk” the control button up and down to dislodge the load. **The proper procedure for a stuck load is to fully lower the dump and dislodge the material by hand.**
- You may need to raise the dump body higher after a portion of the load has been spread to place the remaining material at the rear of the dump body.
- Stop tow vehicle after all material has exited the dump body.
- Press and hold button (4) to lower the dump body. (See previous figure.) Release the button when the dump body is fully lowered. Place dump body controller in the storage or travel location. Close and lock battery box.

## Loading And Unloading A Dump Trailer

### NOTICE

**Risk of trailer damage.**

Trailers equipped with a "power down" hydraulic system can be damaged if the "DN" button is held after the dump body is fully lowered.

Release the "DN" button when the dump body is fully lowered.

### ⚠ WARNING

**Risk of battery exploding.**

Do not place Pump Remote, metal objects near or on top of battery or solenoid terminals, may cause pump failure or battery explosion.

Battery box prop rod may contact battery terminals, which may result in the battery exploding.

Place battery box lid prop rod in retaining clip.

**Tongue Mounted Battery Boxes Only:** When closing the battery box lid, place the prop rod (1) in the retaining clip (2) on the side of the battery box. Failure to do so may result in the prop rod contacting the battery terminals, which can result in the battery exploding.



*Battery Box Prop Rod*

---

## Loading And Unloading A Dump Trailer

---



- Close and latch rear gate before moving trailer.

### UNLOAD BULK MATERIAL USING THE SWING GATES

- Read and understand the hoist operating procedure before dumping the load.
- Be sure the trailer is on level ground, both side-to-side and front-to-rear. Attempting to unload on uneven ground may cause the trailer to overturn, which can result in death or serious injury.

### **⚠ WARNING**

**A soft and/or uneven surface may cause the tow vehicle and trailer to overturn when the dump body is raised or while spreading material.**

**Raise the dump body ONLY if the tow vehicle and trailer are both on a firm and level surface.**

### **⚠ WARNING**

**An overloaded trailer or improperly distributed load can result in death or serious injury.**

**An overloaded trailer can cause the hydraulic system to malfunction, resulting in the dump body falling.**

**A load that is improperly distributed in the trailer can result in the trailer overturning when the dump body is raised.**

### **⚠ WARNING**

**Loaded materials can exert pressure against the swing gates. This may cause the gates to swing out with force when unlatched, causing serious injury.**

**Stand away from the trailer to unlock swing gates.**

- Clear the area around the dump trailer.

---

## Loading And Unloading A Dump Trailer

---

- Remove safety lock pin and push downward on latch (1) to unlock top hinged gate or raise latch (2) to release swing gates.



*Unlock Gate*

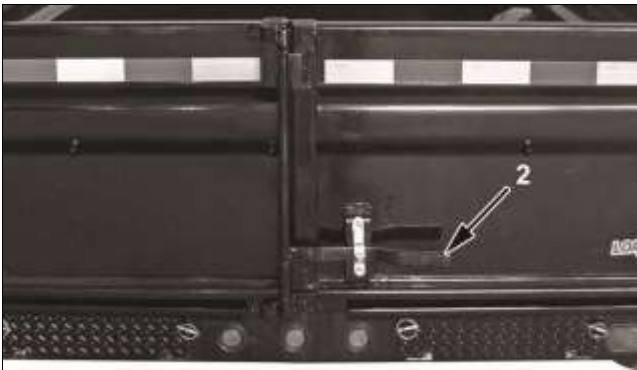

*Latch On Double Swing Gates*

- Lock double swing gates against the side of trailer hold back latch (3).

## Loading And Unloading A Dump Trailer

---



*Door Hold Back Latch*

- Open the battery box. On a tongue mounted battery box, support lid with prop rod. Locate the dump body controller. While using the dump body controller, position yourself in a safe location clear of the dump body. Check for overhead power lines and other obstructions before raising dump body.

### **⚠ DANGER**

**A lowering or falling dump body can result in death or serious injury.**

**NEVER enter the area under the dump body unless the empty dump body is supported by the body prop.**

•

### **⚠ WARNING**

**Risk of electrocution.**

**Dump body coming near or contacting power lines may result in electrocution. Electrocution can occur without contact.**

**Be sure there are no overhead power lines over or near the trailer before raising dump body.**

## Loading And Unloading A Dump Trailer

### **⚠ DANGER**

**The body prop is designed to support an empty dump body only.**

**NEVER support a loaded dump body by the body prop.**

**Unload the dump body before using body prop.**

- Standing well clear of the dump body in a safe location, push and hold the up button (4) on the control until the dump body reaches approximately the **halfway point** of its dumping angle. Never leave the control when operating the dump body.



*Dump Controller*

- Discontinue pushing the up button and walk to the rear of the trailer so you can estimate if there is enough space for the remainder of the load to be safely dumped. If not, then you need to fully lower the dump body by pushing and holding the down button (5) and then pull the trailer forward and then repeat the previous step. See above figure.
- Standing well clear of the dump body, raise the dump body to the **three quarter point** of the maximum dump angle. Discontinue pushing the up button and walk to the rear of trailer to check to see if there is enough space for continued dumping.
- Repeat the process until the load has been completely dumped.
- If the load has not completely dumped DO NOT drive forward and stop quickly to “shock” the load out of the body. Also DO NOT “jerk” the control button up and down to dislodge the load. The proper procedure for a stuck load is to lower the dump and dislodge the material by hand.
- Press and hold the down button (5) to lower the dump body. See above figure.
- Release the button when the dump body is fully lowered. Place dump body control in the battery box. Close and lock battery box.

---

## Loading And Unloading A Dump Trailer

---

- If the rear header at the top of the trailer was removed for unloading, it **must** be installed before closing doors and towing trailer.
- Close and latch rear doors.

### NOTICE

#### Risk of trailer damage.

Trailers equipped with a "power down" hydraulic system can be damaged if the "DN" button is held after the dump body is fully lowered.

Release the "DN" button when the dump body is fully lowered.

**Tongue Mounted Battery Boxes Only:** When closing the battery box lid, place the prop rod (1) in the retaining clip (2) on the side of the battery box. Failure to do so may result in the prop rod contacting the battery terminals, which can result in the battery exploding.

### ⚠ WARNING

#### Risk of battery exploding.

Do not place Pump Remote, metal objects near or on top of battery or solenoid terminals, may cause pump failure or battery explosion.

Battery box prop rod may contact battery terminals, which may result in the battery exploding.

Place battery box lid prop rod in retaining clip.

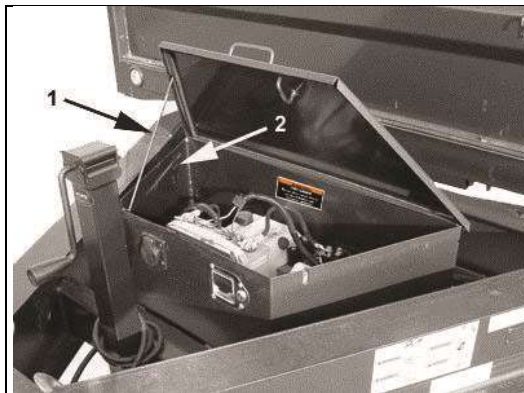

*Battery Box Prop Rod*

## Loading And Unloading A Dump Trailer

---



- Close and latch rear doors before moving the trailer.

### **⚠ WARNING**

**Unsecured gate(s) can cause a driving hazard.**

**Do not operate trailer without properly securing rear latch.**

- Pull up on lever (1) to lock top hinged gate or close gate latch (2). Install safety lock pin on both styles of gates.



*Lock Top Hinged Gate*



*Close Latch On Double Swing Gates*



### 5.5 HYDRAULIC COMPONENTS

Do not alter or substitute and hydraulic components on the dump trailer. The hydraulic system is designed with each component being compatible with the safe and reliable operation of the hydraulic system. Under no circumstances should you alter the hydraulic pressure or flow rate in the hydraulic system.

#### **⚠ DANGER**

**Risk of death or serious injury by crushing.**

**An altered or component substituted hydraulic system may malfunction, resulting in the dump body falling without warning.**

**NEVER alter or substitute any hydraulic system component.**

Always have the hydraulic system repaired or maintained by a qualified technician.

### 5.6 BODY PROP

The body prop supplied as part of the trailer is to be used only when the dump body is empty. The purpose of the body prop is a back-up to the hydraulic system and will hold the empty dump body in a raised position while performing maintenance on the hoist, trailer body, or the trailer itself. Body prop may be located at front of prop dump body (as shown) or at side of dump body.

Note: For service or technical questions on the hydraulic pump, refer to the hydraulic manual specifications. Contact the pump manufacturer for additional questions or pump warranty issues.

**DO NOT** use the body prop to support a loaded dump body.

**DO NOT** enter the area under a raised dump body without first supporting the empty dump body up with the body prop.

#### **⚠ DANGER**

**Risk of death by crushing.**

**Empty dump body before using body prop.**

## Loading And Unloading A Dump Trailer

---

### **⚠ WARNING**

**Risk of death by crushing.**

**Make sure dump body is empty.**

**DO NOT manipulate the body prop if a person is near the control.**

### **⚠ WARNING**

**Risk of death by crushing.**

**Dump body can drop unexpectedly.**

**Never go under a raised dump body.**

**Use body prop for maintenance.**

Park the trailer on a firm and level surface. Raise the dump body and place the body prop (1) in the upright position. Lower the dump body onto the body prop. The body prop (1) must engage the receiver (2).

### **NOTICE**

**Risk of trailer damage.**

**Trailers equipped with a "power down" hydraulic system can be damaged if the "DN" button is held after the dump body is lowered onto the body prop.**

**Release the "DN" button when the dump body is lowered onto the body prop.**

## Loading And Unloading A Dump Trailer

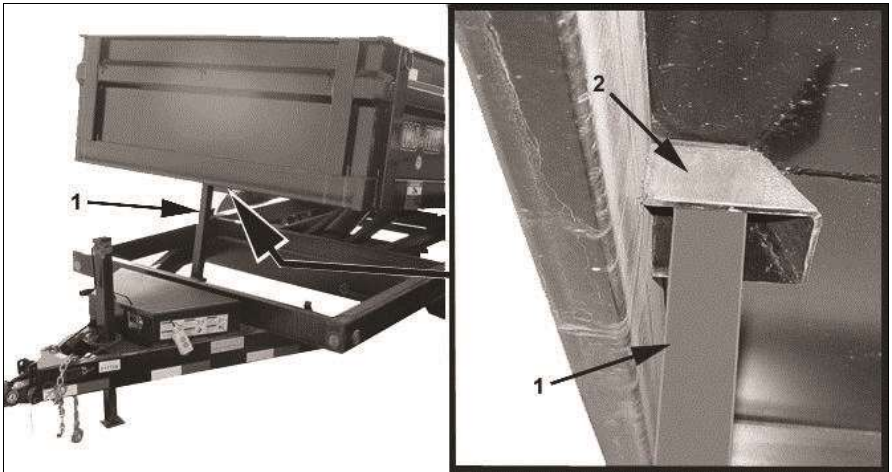

*Dump Trailer Body Prop Engaged*

### 5.7 SECURING THE CARGO

Since the trailer cargo is subjected to longitudinal (front / back) and lateral (side / side) forces you must secure all cargo that is not flowable, so that it does not shift while the trailer is being towed.

#### **⚠ WARNING**

**Shifting cargo can result loss of control of the trailer, and can lead to death or serious injury.**

**Tie down all loads with proper sized fasteners, ropes, straps, etc.**

Refer to [www.fmcsa.dot.gov](http://www.fmcsa.dot.gov) for regulations regarding cargo securement rules.

## 6 LOADING AND UNLOADING A FLATBED TRAILER

Improper trailer loading causes many accidents and deaths. To safely load a trailer, you must consider:

- Overall load weight;
- Load weight distribution;
- Proper tongue weight; and
- Securing the load properly.

To determine that you have loaded the trailer within its rating, you must consider the *distribution* of weight, as well as the total weight of the trailer and its contents. The trailer axles carry most of the total weight of the trailer and its contents (Gross Vehicle Weight, or “GVW”). The remainder of the total weight is carried by the tow vehicle hitch. It is essential for safe towing that the trailer tongue and tow vehicle hitch carry the proper amount of the loaded trailer weight, otherwise the trailer can develop an undesirable sway at towing speeds, or the rear of the towing vehicle can be overloaded. Read the “Tongue Weight” section below.

The load distribution must be such that no component part of the trailer is loaded beyond its rating. This means that you must consider the rating of the tires, wheels and axles. For tandem and triple axle trailers, you must make sure that the front-to-rear load distribution does not result in overloading any axle.

Towing stability also depends on keeping the center of gravity as low as possible. Load heavy items on the floor and over the axles. When loading additional items, be sure to maintain even side-to-side weight distribution and proper tongue weight. The total weight of the trailer and its contents must never exceed the total weight rating of the trailer (Gross Vehicle Weight Rating, or “GVWR”).

### **WARNING**

**An overloaded trailer can result in loss of control of the trailer, leading to death or serious injury.**

**Do not exceed the trailer Gross Vehicle Weight Rating (GVWR) or an axle Gross Axle Weight Rating (GAWR).**

**Do not load a trailer so that the weight on any tire exceeds its rating.**

## 6.1 RAMP AND GATE WEIGHTS

### CAUTION

The weights of the available ramps are listed below.

Ramp and gate weights shown do not reflect or suggest the load capacity of the ramps or gates.

Weights shown are subject to change due to changes in construction materials or changes in design.

Use a safe lifting procedure to avoid injury when lifting ramps.

Assist Team Lift on Heavy Duty Ramps.

Ramp and Gate Weights		
Description	Size	Weight
Side-Mount Ramp	52" x 9" to 65" x 10"	30-40 lbs.
Side-Mount / Side-Mount Dump Ramp	58" x 12"	48 lbs.
Slide-in Ramp	5', 6', 7' & 8'	46-114 lbs.
ATV Ramp Assembly	5' -18" x 60"	68 lbs.
Flip-up Ramp Assembly	5' x 12" to 6' x 22"	133-150 lbs.
Front Fold Gate	48" x 36"	66 lbs.
	60" x 36"	76 lbs.
	77" x 36"	90 lbs.
	83" x 36"	95 lbs.
Rear Gate Assembly, Regular Fold Includes Gates with Ramp	48" x 13" to 60"	35-78 lbs.
	60" x 13" to 60"	41-89 lbs.
	77" x 13" to 60"	50-257 lbs.
	80" x 13" to 60"	53-294 lbs.
	83" x 13" to 60"	55-296 lbs.
	96" x 48" to 72"	143-349 lbs.
Rear Gate Assembly, Split Fold (2 pcs) Includes Gates with Ramp	60" x 48" to 60"	97-110 lbs.
	77" x 48" to 60"	142-265 lbs.
	80" x 48" to 60"	156-305 lbs.
	83" x 48" to 60"	160-315 lbs.
	96" x 48" to 72"	265-370 lbs.
Flip-Over Ramps	19" x 65"	150 lbs.
Multi Purpose Ramp	36" x 38"	112 lbs.
Multi Purpose Heavy Duty Ramp	42" x 62"	342 lbs.
G21 – 3 Piece Heavy Duty Gate	83" x 72"	367 lbs.

## 6.2 RAMP OPTIONS

Your flatbed trailer can be equipped with one of several different ramp options:

- Fold down ramps.
- Mesh ramps
- Removable ramps.

### **WARNING**

**Unsecured ramps can create a driving hazard.**

**Secure ramps in their storage or travel position before towing trailer.**

### **CAUTION**

**Ramps are NOT RATED for load bearing capacity. They will NOT support the load bearing capacity of the trailer.**

**Do not overload the ramps.**

### **FOLD DOWN RAMPS**

Your trailer may be equipped with one, two or three fold down ramps.

### **CAUTION**

**Use a safe lifting procedure to avoid injury when handling ramps.  
See section 6.1 for ramp weights.**

Ramps shown on next page are in the travel/storage position. Your trailer may have ramps that fold over against the trailer deck for travel. If ramps **do not** fold over against the trailer deck, the straps and safety lock pins on all ramps shown on next page **must** be installed for travel.

To lower ramps, remove safety lock pins (1), support straps (2) and lower ramps. Straps and safety lock pins **must** be installed before towing trailer.

## Loading And Unloading A Flatbed Trailer



*Fold Down Ramps*

---

## Loading And Unloading A Flatbed Trailer

---

### MESH RAMP

Your trailer may be equipped with one, two or three mesh ramps on the rear and/or side of trailer. Ramps may be secured with safety lock pins or support straps with safety lock pins.

### ⚠ CAUTION

**Use a safe lifting procedure to avoid injury when handling ramps.  
See section 6.1 for ramp weights.**

**Ramps with Safety Lock Pins:** To lower ramp, remove safety lock pins (1) and lower ramp. Ramp **must** be raised and safety lock pins **must** be installed before towing trailer.



*Rear Mesh Ramp – Safety Lock Pins*



---

## Loading And Unloading A Flatbed Trailer

---

**Ramps with Support Straps:** To lower ramp, remove safety lock pins (2), support straps (3) and lower ramp. Straps and safety lock pins **must** be installed **or** the ramp(s) **must** be folded over flat against the trailer deck before towing trailer.



*Rear Mesh Ramp – Support Straps*

---

## Loading And Unloading A Flatbed Trailer

---

### REMOVABLE RAMPS

Your trailer may be equipped with removable ramps, which may be stored under the rear, and accessed from the curbside side of the trailer.



*Side Storage Position Ramps*

### 6.3 DISTRIBUTING THE CARGO

Couple the trailer to the tow vehicle before loading. This is essential for the bumper pull trailer because the tongue of a bumper pull trailer can rise during loading, before the cargo is properly distributed. To measure the tongue weight, you will have to uncouple the trailer after it is loaded.

Do not transport people, containers of hazardous substances, cans or containers of flammable substances, such as gasoline, kerosene, paint, etc. The exception is fuel in the tank of vehicles or equipment being hauled.

<b>⚠ WARNING</b>
------------------

<p><b>Do not transport flammable, explosive, poisonous or other dangerous materials on your trailer. The exception is fuel in the tank of vehicles or equipment being hauled.</b></p>
---

### PREPARING THE TRAILER FOR LOADING

Before loading cargo onto the trailer:

- Inspect the deck of the trailer for corrosion or damage; and
- Inspect the hold down openings and/or "D"-rings. Hold down openings must be sturdy with no visible cracks or kinks. D-rings must be tight to the deck and must not be bent.

If the deck or any required hold-down is damaged, do not load the cargo. Bring the trailer to your dealer or a competent repair service before using it to carry cargo.

## Loading And Unloading A Flatbed Trailer

### **⚠ WARNING**

**Damaged or loose hold downs and/or “D”-rings can break, allowing cargo to become loose on the trailer. Loose cargo can shift the center of gravity, and result in loss of control of the trailer.**

**Inspect hold downs and/or “D”-rings, and test them for looseness before loading cargo.**

**Do not use a damaged or loose hold down or “D”-ring to secure cargo.**

### **LOADING A RIGID-DECK TRAILER**

Before loading trailer, couple the trailer to the tow vehicle and make sure the deck is level. Do not load or unload the trailer when the deck is not level.

Your trailer may be equipped with rear jacks (1) to prevent the front of the trailer from rising while loading and unloading.

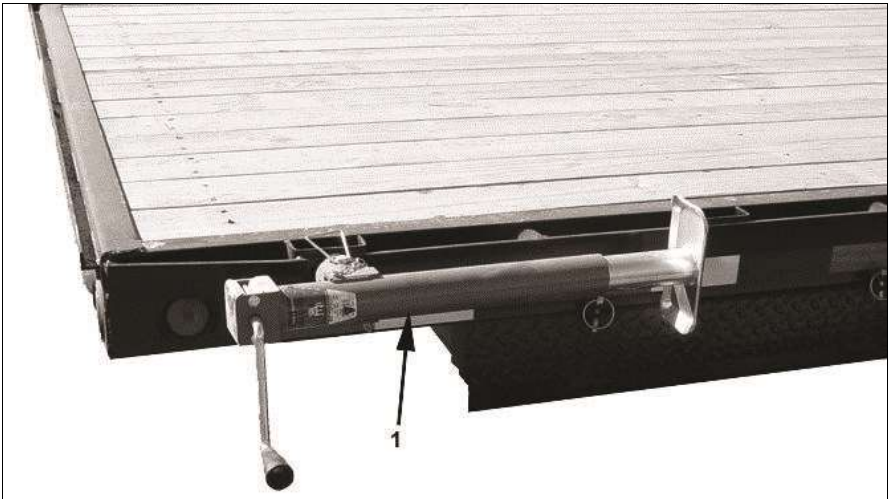

*Rear Jack*

Remove pin and pivot both jacks to the vertical position. Install pin to secure jacks.

### **⚠ CAUTION**

**Use a safe lifting procedure to avoid injury when handling ramps. See section 6.1 for ramp weights.**

---

## Loading And Unloading A Flatbed Trailer

---

To install ramps, remove safety lock pins, open covers and pull ramps out. Place angle bracket on ramps, in channel on rear of trailer. Adjust ramp width as needed to load and unload.

If ramps are removable, make sure the top of the ramps are secure to the trailer, and the bottom is resting on firm ground.



*Rear Jack and Ramps*

If your trailer is not equipped with rear jacks, place blocking under the rear of the trailer to prevent the front of the trailer from rising while loading and unloading.

### **⚠ WARNING**

**Load can suddenly move or topple, which can result in death or serious injury.**

**Do not load or unload your open trailer unless it is prevented from tipping and is on firm and level ground.**

Load the cargo onto the trailer with approximately 60% of the cargo on the front half of the trailer.

Secure the cargo to the trailer using appropriate straps, chains and tensioning devices. Refer to [www.fmcsa.dot.gov](http://www.fmcsa.dot.gov) for regulations regarding cargo securement rules.

Since the trailer “ride” can be bumpy and rough, you must secure your cargo so that it does not shift while the trailer is being towed.

---

## Loading And Unloading A Flatbed Trailer

---

### **WARNING**

**Shifting cargo can result in loss of control of the trailer, and can lead to death or serious injury.**

**Tie down all loads with proper sized fasteners, ropes, straps, etc.**

Return the ramp(s) to their stowed position(s), and secure them so that they will not move during transit. Place rear jacks in the horizontal travel position or remove blocking from rear of the trailer.

### **LOADING THE SB SERIES TILT DECK TRAILER**

The SB series tilt deck trailer is fitted with a lock pin (1) that keeps the trailer deck in the driving position. After the trailer is loaded and the cargo is secured with hold downs, be sure the lock pin has locked the trailer into “driving position.”

Couple the trailer to the tow vehicle before attempting to unlock the deck and load the trailer.

Remove safety lock pin and deck lock pin (1) and tilt deck to the loading position.

### **WARNING**

**A damaged deck lock pin may cause loss of cargo or loss of control of the trailer. Death or serious injury may result.**

**Before loading the trailer, inspect the deck lock pin.**

**If the deck lock pin becomes bent, do not straighten it. Replace the deck lock pin before towing trailer.**

## Loading And Unloading A Flatbed Trailer

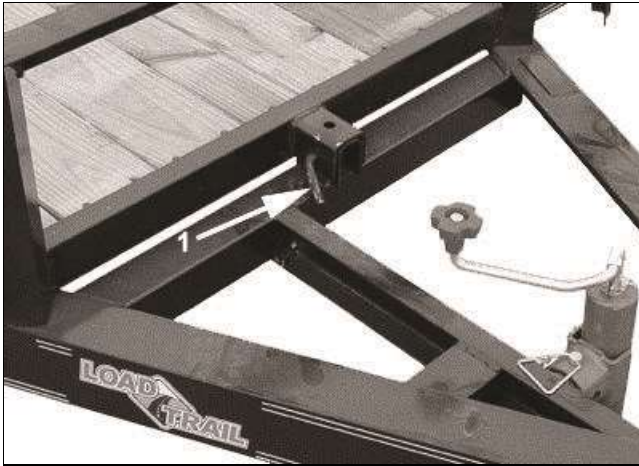

*Deck Lock Pin*



*Deck Tilted*

Load the cargo onto the trailer with approximately 60% of the cargo on the front half of the deck. As the cargo is moved forward on the deck, the deck will pivot down into the driving position.

Install deck lock pin (1) and safety lock pin to secure the deck in the travel position.

### **⚠ WARNING**

**An unlocked tilt deck can result in loss of cargo or loss of control of the trailer, which can result in death or serious injury.**

**Before towing the trailer:**

- **Lock the tilting deck in the driving position.**
- **Double-check that the catch engages the hole in the tilt deck.**

---

## Loading And Unloading A Flatbed Trailer

---

Secure the cargo to the trailer using appropriate straps, chains and tensioning devices. Refer to [www.fmcsa.dot.gov](http://www.fmcsa.dot.gov) for regulations regarding cargo securement rules.

### LOADING THE TD SERIES TILT DECK TRAILER

The TD series tilt deck trailer is equipped with a latch on the left side of the trailer that keeps the trailer deck in the travel position. A control valve is mounted either on the front, or on street side of the trailer to allow the trailer to tilt. After the trailer is loaded and the cargo is secured with hold downs, be sure the latch is engaged and the control valve is in the “closed” position.

Couple the trailer to the tow vehicle before attempting to unlock the deck and load the trailer.

### WARNING

**A tilt deck can pinch and crush.**

**Keep away from the deck while tilting to avoid injury.**

Pull pin and push latch down to open (1) as shown below.



*Deck Latch*

## Loading And Unloading A Flatbed Trailer

---

Move control valve (2) to the “Open” position to allow the trailer to tilt to the load/unload position.



*Deck Control Valve*

Load the cargo onto the trailer with approximately 60% of the cargo on the front half of the deck. As the cargo is moved forward on the deck, the deck will pivot down into the driving position.

Pull latch up and secure safety pin (1) to lock the deck in the travel position.



*Deck Latches*

Move the control valve to the “Closed” position and engage lock on valve handle. Control valve **MUST** be in the “Closed” position for towing trailer.



## Loading And Unloading A Flatbed Trailer



Deck Control Valve

### **⚠ WARNING**

**An unlocked tilt deck can result in loss of cargo or loss of control of the trailer, which can result in death or serious injury.**

**Before towing the trailer:**

- **Lock the tilting deck in the driving position.**
- **Move the control valve to the "closed" position.**

Secure the cargo to the trailer using appropriate straps, chains and tensioning devices. Refer to [www.fmcsa.dot.gov](http://www.fmcsa.dot.gov) for regulations regarding cargo securement rules.

### **CENTER POP-UP DECK**

Your trailer may be equipped with a center pop-up deck. This pop-up allows you to utilize the entire deck and ramps on the trailer for loading items.

### **⚠ CAUTION**

**Pinching hazard.**

**Keep hands and fingers away from pinch areas between pop-up and trailer frame.**

- To lower the pop-up, release lock pin (1). Push in on rear panel handle (2) while pushing down on top of pop-up (3).

## Loading And Unloading A Flatbed Trailer



*Lower Pop-Up*



*Raise Pop-Up*

- To raise the pop-up, release lock pin (1). Pull rear panel handle (2) and engage pin (1).

### HYDRAULIC DOVETAIL OPERATION (IF EQUIPPED)

#### **⚠ DANGER**

**NEVER alter or substitute any hydraulic system component. Death or serious injury may result.**

**An altered or component substituted hydraulic system may malfunction, resulting in the deck falling without warning.**

**NEVER alter or substitute any hydraulic system component.**

## Loading And Unloading A Flatbed Trailer

If trailer is equipped with Hydraulic Jacks, please follow instructions below regarding operation of selector valve.

# WARNING



### Hydraulic Valve Must Be Down Before Towing Trailer.

- Pull Up to Operate Jack
- Push Down to Operate Dove Tail or Dump Bed

## MAXIMUM CAPACITIES

Dovetail Hauling Capacity: 4,000 lbs  
from Center of Dovetail Forward.

Dovetail Lift Capacity: 10,000 lbs  
from Center of Dovetail Forward.

### Hydraulic Dove Tail Operating Instructions

<p>1. Press UP until pump builds up pressure.</p> 	<p>2. Push Lever DOWN with foot.</p> 	<p>3. Press DOWN while keeping pressure on lever with foot until latch fully disengages.</p> 	<p>4. When finished loading or unloading press UP and raise deck fully, press DOWN until latch engages.</p>  
---	--	--	---

## Loading And Unloading A Flatbed Trailer

### **⚠ WARNING**

**Risk of death by crushing.**

**Dovetail can drop unexpectedly.**

**Never go under a raised dovetail without safety locks engaged.**

The hydraulic pump, battery and control are located on the curb side of the trailer in a lockable box. If trailer is equipped with Hydraulic Jacks, hydraulic pump will be in front tool box.

- To lower the dovetail, open the box and locate the control. Press "UP" (1) to move the dovetail off of the mechanical stops.



*Dovetail Control*



*Dovetail Mechanical Stop Handle*

- Push down at contact point (2) and continue to hold while lowering.

---

## Loading And Unloading A Flatbed Trailer

---

- Press “DN” (3) to lower the dovetail ramp.

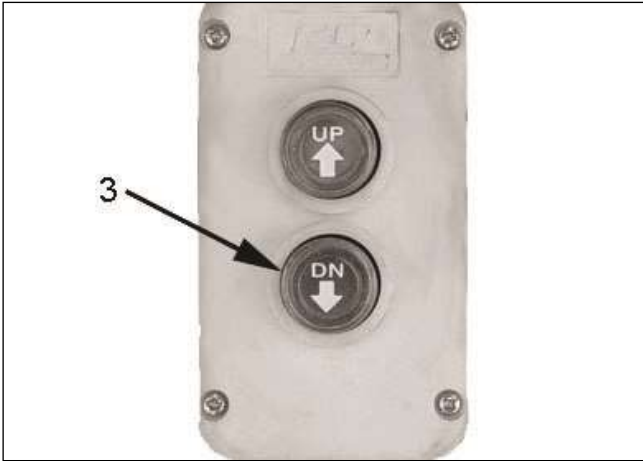

*Dovetail Control*

### **WARNING**

**A moving dove tail on trailer can pinch and crush.  
Keep away from the trailer while operating to avoid injury.**



*Dovetail Lowered*

## Loading And Unloading A Flatbed Trailer

### **⚠ WARNING**

**Load can suddenly move or topple, which can result in death or serious injury.**

**Do not load or unload your trailer unless it is prevented from tipping and is on firm and level ground.**

**Do not tow trailer unless safety latches are fully engaged.**

- To raise dovetail:
- Press “UP” on control to raise dovetail.
- Move the mechanical stop lever (4) clockwise until safety latches are fully engaged.
- fully engaged.



*Dovetail Mechanical Stop Handle*

- Place control in box, close and lock cover.

### **HYDRAULIC TILT DECK OPERATION**

### **⚠ DANGER**

**NEVER alter or substitute any hydraulic system component. Death or serious injury may result.**

**An altered or component substituted hydraulic system may malfunction, resulting in the tilt deck falling without warning.**

**NEVER alter or substitute any hydraulic system component.**

## Loading And Unloading A Flatbed Trailer

### **⚠ WARNING**

**Risk of death by crushing.**

**Tilt deck can drop unexpectedly.**

**Never go under a raised tilt deck.**

**Use safety prop for maintenance.**

The hydraulic pump, battery and control are located on the curb side of the trailer in a lockable box.

- To tilt the trailer deck, open the box and locate the control. Press down on the latch (1) and press “UP” (2) on the control to raise the tilt deck. See following figures. Latch can be released after trailer deck clears the locks.

### **⚠ WARNING**

**A moving tilt deck on trailer can pinch and crush.**

**Keep away from the trailer while operating to avoid injury.**

- Press “DN” (3) and fully lower the tilt deck.

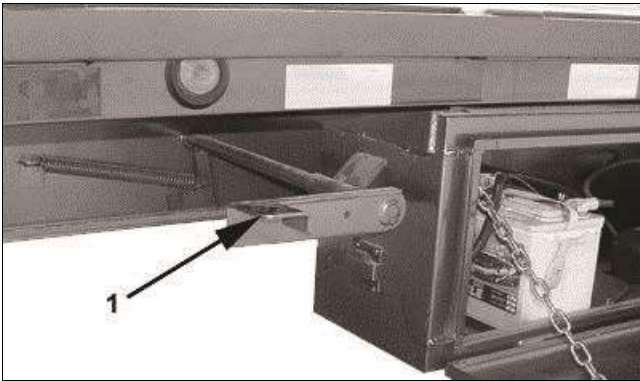

*Hydraulic Tilt Bed Latch*

## Loading And Unloading A Flatbed Trailer



*Tilt Bed Control*



*Hydraulic Tilt Bed*

### **⚠ WARNING**

**Load can suddenly move or topple, which can result in death or serious injury.**

**Do not load or unload your trailer unless it is prevented from tipping and is on firm and level ground.**

- When loading the trailer, place equipment to be loaded at the rear of the deck. Secure equipment to trailer deck and then lower the tilt deck.
- Press “DN” (3) to lower the tilt deck.

Position equipment on trailer and secure load to trailer.



## 7 PRE-TOW CHECK LIST

### 7.1 PRE-TOW CHECKLIST

Before towing, double-check all of these items:

- Tires, wheels and lug nuts. See the “Major Hazards” section of this manual.
- Tire Pressure. Inflate tires on trailer and tow vehicle to the pressure stated on the Certification / VIN label.
- Coupler secured and locked. See “Coupling to the Tow Vehicle” section of this manual.
- Safety chains properly rigged to tow vehicle, not to hitch or ball. See “Coupling To The Tow Vehicle” section of this manual.
- Test Tail, Stop, and Turn Lights
- Test trailer brakes.
- Safety breakaway lanyard fastened to tow vehicle, not to safety chains. See “Coupling To The Tow Vehicle” section of this manual.
- Cargo properly loaded, balanced and tied down. See the appropriate “Loading the Trailer” section of this manual.
- Tongue weight and weight distribution set-up.
- Ramps secured for travel.
- Fire extinguisher
- Flares and reflectors

### 7.2 MAKE REGULAR STOPS

After each 50 miles, or one hour of towing, stop and check the following items:

- Coupler secured.
- Safety chains are fastened and not dragging.
- Cargo secured.
- Doors latched and secured.

## 8 BREAKING-IN A NEW TRAILER

### 8.1 RETIGHTEN LUG NUTS AT FIRST 10, 25 & 50 MILES

Wheel lugs can shift and settle quickly after being first assembled, and must be checked after the **first** 10, 25 and 50 miles of driving. Failure to perform this check may result in a wheel coming loose from the trailer, causing a crash leading to death or serious injury. Improper tightening of the lug nuts voids the axle warranty. Refer to the Inspection, Service and Maintenance section of this manual.

#### **WARNING**

**Lug nuts are prone to loosen after being first assembled. Death or serious injury can result.**

**Check lug nuts for tightness on a new trailer, and after re-mounting a wheel at 10, 25 and 50 miles.**

### 8.2 ADJUST BRAKE SHOES AT FIRST 200 MILES

Brake shoes and drums experience a rapid initial wear. The brakes must be adjusted after the first 200 miles of use, and each 3,000 miles thereafter. Some axles are fitted with a mechanism that will automatically adjust the brake shoes. Read your axle and brake manual to see if your brakes adjust automatically. If you do not have the axle and brake manual, contact your dealer for assistance.

If your trailer is not fitted with automatically adjusting brakes, the brakes will need to be manually adjusted. See section 10.2.1.4, "Manually Adjusting Brake Shoes," for instructions.

### 8.3 SYNCHRONIZING THE BRAKE SYSTEMS

Trailer brakes are designed to work in synchronization with the brakes on the tow vehicle. When the tow vehicle and trailer braking systems are synchronized, both braking systems contribute to slowing, and the tongue of the trailer will neither dive nor rise sharply.

#### **WARNING**

**If trailer and tow vehicle brakes do not work properly together, death or serious injury can occur.**

**Road test the brakes in a safe area at no more than 30 m.p.h. before each tow.**

To insure safe brake performance and synchronization, read and follow the axle/brake and the brake controller manufacturers' instructions. If you do not have these instructions, contact your dealer for assistance.

## 9 ACCESSORIES

This chapter provides some basic information for the safe operation of accessories. You must read and follow these instructions before using the accessory. If you are uncertain whether you have all of the instructions, contact your dealer before operating the accessory.

### 9.1 ACCESSORY BATTERY

Your trailer may be outfitted with an accessory battery that operates a dump body, tilt deck or other accessories. An accessory battery may be kept charged either by the tow vehicle or by using the on-board battery maintainer/charger. If the trailer is used daily, it is recommended that the battery charger be plugged in after each days use. The accessory battery may be located in a tongue mounted battery box or a side mounted box.

Connect a standard 3-prong extension cord to the outlet on the battery box. The charger will shut off automatically when the battery is fully charged. Do not alter the plug or use a 3-prong to 2-prong adapter plug.

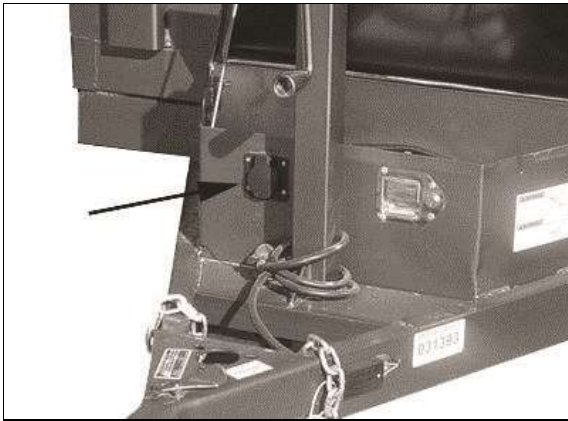

*Connect To Battery Charger – Tongue Mounted Box*

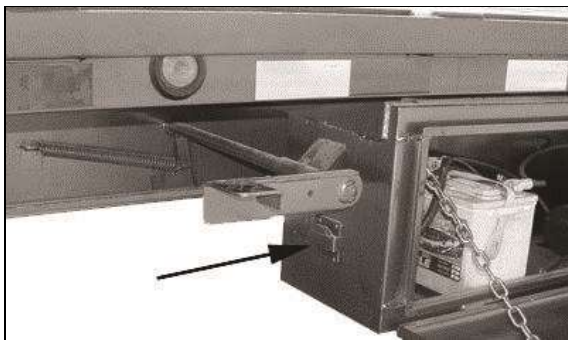

*Connect To Battery Charger – Side Mounted Box*

## Accessories

If you do not plan to be using the trailer for an extended period, such as seasonal storage, plug in the battery charger to keep the battery fully charged.

The accessory battery must be kept in a charged condition during storage. The battery could freeze and break if it becomes discharged.

If the battery is not fully charged, the hydraulic pump will lose pressure causing hydraulic fluid to flow back into the hydraulic reservoir, overfilling the reservoir and ejecting fluid into the battery box.

**Tongue Mounted Battery Boxes Only:** When closing the battery box lid, place the prop rod (1) in the retaining clip (2) on the side of the battery box. Failure to do so may result in the prop rod contacting the battery terminals, which can result in the battery exploding.

### **⚠ WARNING**

**Risk of battery exploding.**

**Do not place Pump Remote, metal objects near or on top of battery or solenoid terminals, may cause pump failure or battery explosion.**

**Battery box prop rod may contact battery terminals, which may result in the battery exploding.**

**Place battery box lid prop rod in retaining clip.**



*Battery Box Prop Rod*



KT1 SINGLE ACTING POWER UNIT

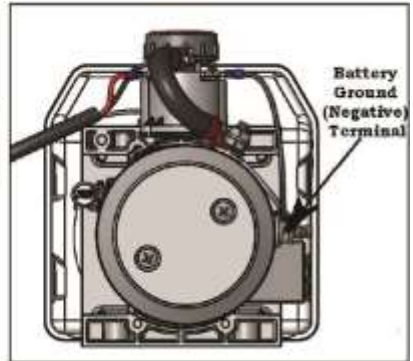
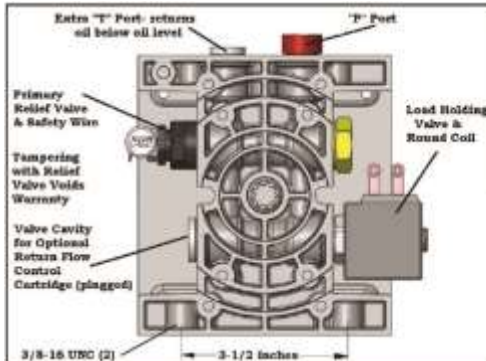
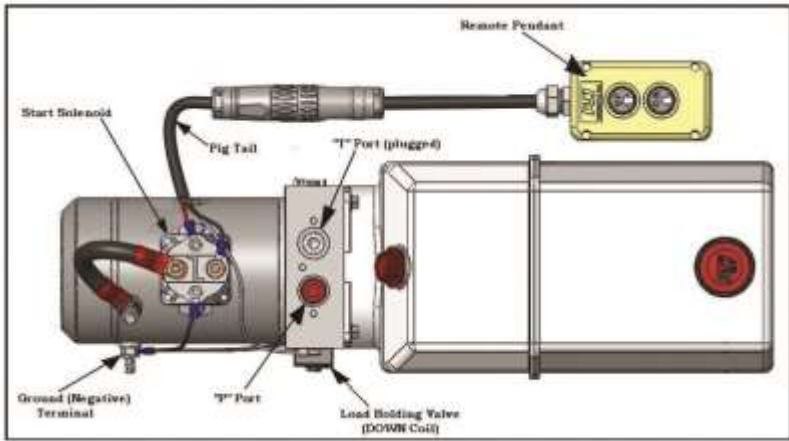

### KTI DOUBLE ACTING POWER UNIT

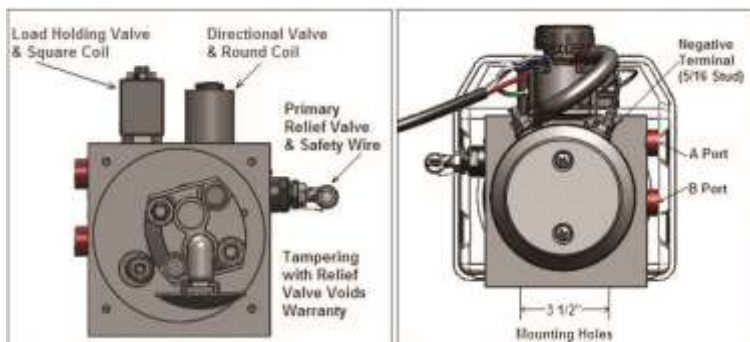
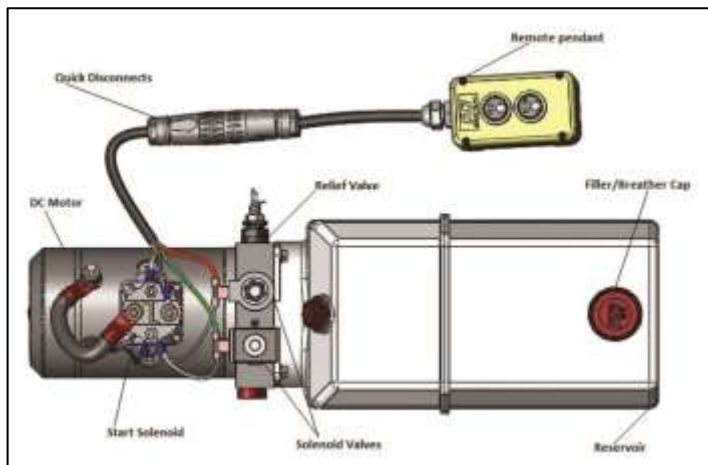

### KTI Fluid Recommendations

KTI recommends using a premium hydraulic oil to ensure optimum performance and system life. Select oil that has anti-wear properties, rust and oxidation inhibitors, foam inhibitors and good stability. Examples of premium grade hydraulic oils: Chevron Rando HDZ, Mobil DTE 10, DTE 20 series, AMSOIL, and Shell Tellus.

Automotive Transmission Oils are acceptable under normal conditions.

Aviation Oils such as Valvoline ROYCO series or Mobil Aero HF or HFA may be used in **prolonged, extreme cold** environments.

Ambient Temperature Range

-20°F to +32°F  
(-29°C to +0°C)

+14°F to +120°F  
(-10°C to +49°C)

ISO Viscosity Grade

15

22, 32, ATF

**KTI TRIPLE ACTING POWER UNIT (POWER UP/POWER DOWN/GRAVITY DOWN)**

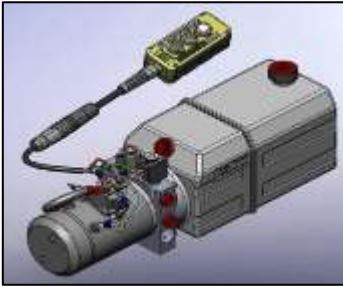

diagram A-1

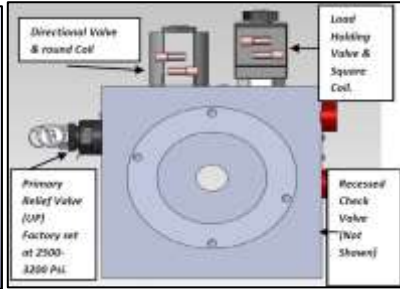

diagram A-2

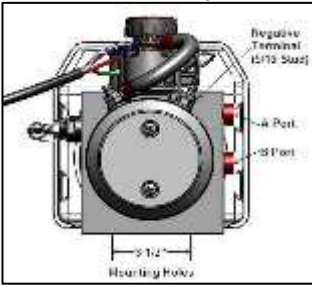

diagram A-3

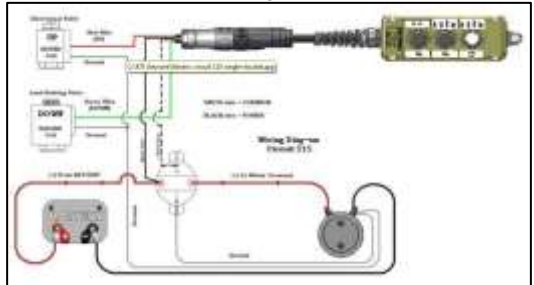

diagram A-4

**Installation**

1. Install 9/16-18 SAE ORB, SAE #6, hydraulic fittings into ports “A” and “B”. Torque your hydraulic fittings to 18 ft-lb.
2. Remove the Three-button pendant from the power unit at the quick disconnect.
3. Mount the Power Unit using two, 3/8-16 UNC mounting bolts (diagram A-3)
4. Remove the Filler/Breather Cap and fill the reservoir with hydraulic oil to the Full line on Reservoir Label. [**Approx. one (1) inch from the top**] (See fluid recommendations).
5. Replace the filler/breather cap.
6. Connect Hydraulic Lines to ports “A” (TOP) & “B” (BOTTOM).
  - a) Check the torque specifications for the hose fittings.
  - b) Connect the Base of the Cylinder to port “A” (TOP).
  - c) Connect the Rod End of the Cylinder to port “B” (BOTTOM).
7. Connect the battery **Ground** cable to the **Ground** terminal of the DC Motor (diagram A-3)
8. Connect the **Positive** cable from the battery to the start solenoid (diagram A-4). (See **Battery Gauge / Cable length** table on pg.2 to help you select the proper gauge and length of cables for your unit.)
9. Holding the bottom nut with a wrench, torque the battery connections to 3 lb-ft.
10. Reconnect the three-button remote pendant at the quick disconnect.
11. Operate the power unit while also keeping an eye on the fluid level in the reservoir.
  - a. Insure that the fluid level doesn't go lower than ½ full during the initial start up.
  - b. When the cylinder is fully extended, the reservoir should be about ½ full. (The Reason for Not Filling the Reservoir all the way is that during retraction of the cylinder fluid from the Butt End of the Cylinder Will return to tank, Causing the Reservoir to Overflow)
12. Run the cylinder Up and Down until all the air is removed from the hydraulic oil.
13. Fill the reservoir to the Full line on Reservoir Label. [**Approx. one (1) inch from the top**]

**KTI DUAL DOUBLE ACTING POWER UNIT (4 BUTTON REMOTE)**

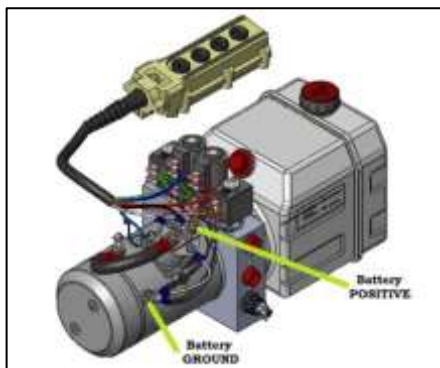

diagram A-2

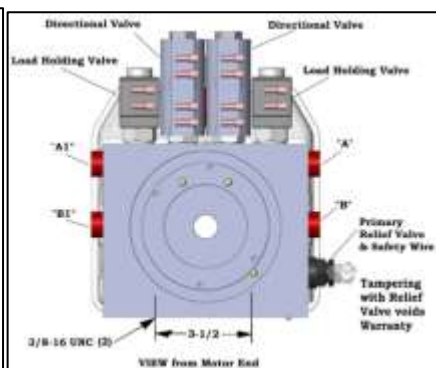

diagram A-3

**Installation**

- 1) Disconnect the Positive battery cable from the battery.
- 2) Install 9/16-18 SAE ORB, SAE #6, hydraulic fittings into ports "A", "B", "A1" and "B1". Torque fittings to 18 lb-ft.
- 3) Mount the Power Unit using two, 3/8-16 UNC mounting bolts (diagram A-2)
- 4) Remove the Filler/Breather Cap and fill the reservoir with hydraulic oil (see fluid recommendations). Replace the filler/breather cap.
- 5) Connect Hydraulic Lines to the two cylinders.
  - a) Check the torque specifications for the hose fittings.
  - b) Connect the Base end of the first Cylinder to the port "A" (UP) (Top location).
  - c) Connect the Rod end of the first Cylinder to port "B" (DOWN) (Bottom location)
  - d) Connect the Base end of the second Cylinder to the port "A1" (OUT) (Top location).
  - e) Connect the Rod end of the second Cylinder to port "B1" (IN) (Bottom location).
- 6) Connect the battery Ground cable to the Ground terminal of the DC Motor (Diagram A-3)
- 7) Connect the positive cable from the battery to the start solenoid (diagram A-3) (see Battery Cable Gauge table for proper gauge for your length of cables)
- 8) Holding the bottom nut with a wrench, torque the battery connections to 3 lb-ft.
- 9) Reconnect the Positive battery cable to the battery.
- 10) **FIRST CYLINDER (UP/DOWN):** Extend the first cylinder by pressing the UP button. Keep an eye on the oil level in the reservoir. With the cylinder fully extended, the oil level should not go below 1/2 full.
- 11) After the cylinder is fully extended, press the DOWN button to fully retract the cylinder.
- 12) Extend and retract the first cylinder a few times until all the air is removed from the hydraulic oil.
- 13) **SECOND CYLINDER (IN/OUT):** Extend the second cylinder by pressing the OUT button. Keep an eye on the oil level in the reservoir. With the cylinder fully extended, the oil level should not go below 1/2 full.
- 14) After the second cylinder is fully extended, press the IN button to fully retract the cylinder.
- 15) Extend and retract the second cylinder a few times until all the air is removed from the hydraulic oil.
- 16) After both cylinders are primed and fully retracted, recheck the level of the oil in the reservoir.



## Accessories

### BATTERY CABLES

Low voltage will cause the motor to run at higher amps and may cause damage to other electrical components. To minimize voltage drop, increase the gauge size of the battery cables as the length of the positive and ground cables increase.

Cable Length	Wire Gauge	Nominal OD (in).
1 to 2 feet	4 gauge	0.43
3 to 4 feet	2 gauge	0.49
5 to 7 feet	1 gauge	0.56
8 to 9 feet	1/0 gauge	0.61
10 to 12 feet	2/0 gauge	0.66
13 to 15 feet	3/0 gauge	0.72
16 to 19 feet	4/0 gauge	0.78

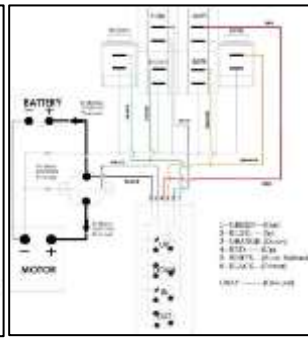
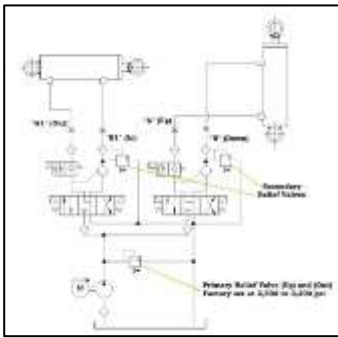

diagram A-4

diagram A-5

### KTi TROUBLE SHOOTING QUICK REFERENCE GUIDE

Possible Cause	Not Building Pressure	Motor Not Running	Cylinder Won't Extend	Cylinder Won't Retract	Won't Hold Load	Excessive Heat From Unit	Leakage of Hydraulic Fluid	Reverse Overflows	Cylinder Extends With Unit Not Operating	Struggles to Lift Load	Load Bounces When Cylinder Retracts	Start Solenoid Joint Clicks/Motor Not Engaging	Won't Lift Load (DC Motor Under Load)	Won't Lift Load (DC Motor Not Under Load)	Won't Lower	Start Solenoid Slays On	Cylinder won't Retract/Motor Under Load
Low Battery Voltage	<input type="checkbox"/>	<input type="checkbox"/>	<input type="checkbox"/>	<input type="checkbox"/>	<input type="checkbox"/>	<input type="checkbox"/>	<input type="checkbox"/>	<input type="checkbox"/>	<input type="checkbox"/>	<input type="checkbox"/>	<input type="checkbox"/>	<input type="checkbox"/>	<input type="checkbox"/>	<input type="checkbox"/>	<input type="checkbox"/>	<input type="checkbox"/>	<input type="checkbox"/>
Poor Ground Condition	<input type="checkbox"/>	<input type="checkbox"/>	<input type="checkbox"/>	<input type="checkbox"/>	<input type="checkbox"/>	<input type="checkbox"/>	<input type="checkbox"/>	<input type="checkbox"/>	<input type="checkbox"/>	<input type="checkbox"/>	<input type="checkbox"/>	<input type="checkbox"/>	<input type="checkbox"/>	<input type="checkbox"/>	<input type="checkbox"/>	<input type="checkbox"/>	<input type="checkbox"/>
Check Hand Control	<input type="checkbox"/>	<input type="checkbox"/>	<input type="checkbox"/>	<input type="checkbox"/>	<input type="checkbox"/>	<input type="checkbox"/>	<input type="checkbox"/>	<input type="checkbox"/>	<input type="checkbox"/>	<input type="checkbox"/>	<input type="checkbox"/>	<input type="checkbox"/>	<input type="checkbox"/>	<input type="checkbox"/>	<input type="checkbox"/>	<input type="checkbox"/>	<input type="checkbox"/>
Debris in Load Holding Valve	<input type="checkbox"/>	<input type="checkbox"/>	<input type="checkbox"/>	<input type="checkbox"/>	<input type="checkbox"/>	<input type="checkbox"/>	<input type="checkbox"/>	<input type="checkbox"/>	<input type="checkbox"/>	<input type="checkbox"/>	<input type="checkbox"/>	<input type="checkbox"/>	<input type="checkbox"/>	<input type="checkbox"/>	<input type="checkbox"/>	<input type="checkbox"/>	<input type="checkbox"/>
Thermal Pressure Lock	<input type="checkbox"/>	<input type="checkbox"/>	<input type="checkbox"/>	<input type="checkbox"/>	<input type="checkbox"/>	<input type="checkbox"/>	<input type="checkbox"/>	<input type="checkbox"/>	<input type="checkbox"/>	<input type="checkbox"/>	<input type="checkbox"/>	<input type="checkbox"/>	<input type="checkbox"/>	<input type="checkbox"/>	<input type="checkbox"/>	<input type="checkbox"/>	<input type="checkbox"/>
Coil Not Energizing	<input type="checkbox"/>	<input type="checkbox"/>	<input type="checkbox"/>	<input type="checkbox"/>	<input type="checkbox"/>	<input type="checkbox"/>	<input type="checkbox"/>	<input type="checkbox"/>	<input type="checkbox"/>	<input type="checkbox"/>	<input type="checkbox"/>	<input type="checkbox"/>	<input type="checkbox"/>	<input type="checkbox"/>	<input type="checkbox"/>	<input type="checkbox"/>	<input type="checkbox"/>
Bad Seals in Cylinder	<input type="checkbox"/>	<input type="checkbox"/>	<input type="checkbox"/>	<input type="checkbox"/>	<input type="checkbox"/>	<input type="checkbox"/>	<input type="checkbox"/>	<input type="checkbox"/>	<input type="checkbox"/>	<input type="checkbox"/>	<input type="checkbox"/>	<input type="checkbox"/>	<input type="checkbox"/>	<input type="checkbox"/>	<input type="checkbox"/>	<input type="checkbox"/>	<input type="checkbox"/>
Loose Motor	<input type="checkbox"/>	<input type="checkbox"/>	<input type="checkbox"/>	<input type="checkbox"/>	<input type="checkbox"/>	<input type="checkbox"/>	<input type="checkbox"/>	<input type="checkbox"/>	<input type="checkbox"/>	<input type="checkbox"/>	<input type="checkbox"/>	<input type="checkbox"/>	<input type="checkbox"/>	<input type="checkbox"/>	<input type="checkbox"/>	<input type="checkbox"/>	<input type="checkbox"/>
Packing on Cylinder Rod Worn Out	<input type="checkbox"/>	<input type="checkbox"/>	<input type="checkbox"/>	<input type="checkbox"/>	<input type="checkbox"/>	<input type="checkbox"/>	<input type="checkbox"/>	<input type="checkbox"/>	<input type="checkbox"/>	<input type="checkbox"/>	<input type="checkbox"/>	<input type="checkbox"/>	<input type="checkbox"/>	<input type="checkbox"/>	<input type="checkbox"/>	<input type="checkbox"/>	<input type="checkbox"/>
Noises Connected Backwards	<input type="checkbox"/>	<input type="checkbox"/>	<input type="checkbox"/>	<input type="checkbox"/>	<input type="checkbox"/>	<input type="checkbox"/>	<input type="checkbox"/>	<input type="checkbox"/>	<input type="checkbox"/>	<input type="checkbox"/>	<input type="checkbox"/>	<input type="checkbox"/>	<input type="checkbox"/>	<input type="checkbox"/>	<input type="checkbox"/>	<input type="checkbox"/>	<input type="checkbox"/>
Pump Not Priming	<input type="checkbox"/>	<input type="checkbox"/>	<input type="checkbox"/>	<input type="checkbox"/>	<input type="checkbox"/>	<input type="checkbox"/>	<input type="checkbox"/>	<input type="checkbox"/>	<input type="checkbox"/>	<input type="checkbox"/>	<input type="checkbox"/>	<input type="checkbox"/>	<input type="checkbox"/>	<input type="checkbox"/>	<input type="checkbox"/>	<input type="checkbox"/>	<input type="checkbox"/>
Clogged Orifice	<input type="checkbox"/>	<input type="checkbox"/>	<input type="checkbox"/>	<input type="checkbox"/>	<input type="checkbox"/>	<input type="checkbox"/>	<input type="checkbox"/>	<input type="checkbox"/>	<input type="checkbox"/>	<input type="checkbox"/>	<input type="checkbox"/>	<input type="checkbox"/>	<input type="checkbox"/>	<input type="checkbox"/>	<input type="checkbox"/>	<input type="checkbox"/>	<input type="checkbox"/>
Rust in Motor	<input type="checkbox"/>	<input type="checkbox"/>	<input type="checkbox"/>	<input type="checkbox"/>	<input type="checkbox"/>	<input type="checkbox"/>	<input type="checkbox"/>	<input type="checkbox"/>	<input type="checkbox"/>	<input type="checkbox"/>	<input type="checkbox"/>	<input type="checkbox"/>	<input type="checkbox"/>	<input type="checkbox"/>	<input type="checkbox"/>	<input type="checkbox"/>	<input type="checkbox"/>
Bad Diode	<input type="checkbox"/>	<input type="checkbox"/>	<input type="checkbox"/>	<input type="checkbox"/>	<input type="checkbox"/>	<input type="checkbox"/>	<input type="checkbox"/>	<input type="checkbox"/>	<input type="checkbox"/>	<input type="checkbox"/>	<input type="checkbox"/>	<input type="checkbox"/>	<input type="checkbox"/>	<input type="checkbox"/>	<input type="checkbox"/>	<input type="checkbox"/>	<input type="checkbox"/>
Check For Additional Valving On or Connected to Cylinder	<input type="checkbox"/>	<input type="checkbox"/>	<input type="checkbox"/>	<input type="checkbox"/>	<input type="checkbox"/>	<input type="checkbox"/>	<input type="checkbox"/>	<input type="checkbox"/>	<input type="checkbox"/>	<input type="checkbox"/>	<input type="checkbox"/>	<input type="checkbox"/>	<input type="checkbox"/>	<input type="checkbox"/>	<input type="checkbox"/>	<input type="checkbox"/>	<input type="checkbox"/>
Directional Valve Not Shifting Properly	<input type="checkbox"/>	<input type="checkbox"/>	<input type="checkbox"/>	<input type="checkbox"/>	<input type="checkbox"/>	<input type="checkbox"/>	<input type="checkbox"/>	<input type="checkbox"/>	<input type="checkbox"/>	<input type="checkbox"/>	<input type="checkbox"/>	<input type="checkbox"/>	<input type="checkbox"/>	<input type="checkbox"/>	<input type="checkbox"/>	<input type="checkbox"/>	<input type="checkbox"/>
Bad Start Solenoid	<input type="checkbox"/>	<input type="checkbox"/>	<input type="checkbox"/>	<input type="checkbox"/>	<input type="checkbox"/>	<input type="checkbox"/>	<input type="checkbox"/>	<input type="checkbox"/>	<input type="checkbox"/>	<input type="checkbox"/>	<input type="checkbox"/>	<input type="checkbox"/>	<input type="checkbox"/>	<input type="checkbox"/>	<input type="checkbox"/>	<input type="checkbox"/>	<input type="checkbox"/>
Dirty contacts in Motor control	<input type="checkbox"/>	<input type="checkbox"/>	<input type="checkbox"/>	<input type="checkbox"/>	<input type="checkbox"/>	<input type="checkbox"/>	<input type="checkbox"/>	<input type="checkbox"/>	<input type="checkbox"/>	<input type="checkbox"/>	<input type="checkbox"/>	<input type="checkbox"/>	<input type="checkbox"/>	<input type="checkbox"/>	<input type="checkbox"/>	<input type="checkbox"/>	<input type="checkbox"/>

## WIRELESS REMOTE INSTRUCTION

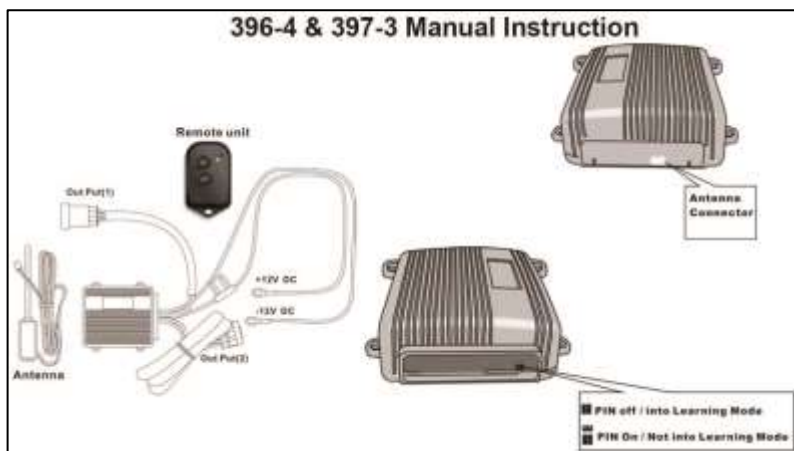

Wireless Remote Comes Preprogrammed

Installation

- 1.) Connect Out Put 1 to Power Unit
- 2.) Mount Wireless receiver
  - a. Select desired mounting location preferably in a sealed box and out of harms way
  - b. Antenna must be mounted outside, not in metal box.
- 3.) Connect Positive (*Red*) & Negative (*Black*) Ring Terminals to Power Unit not Battery

- a. Insure Power Unit has a designated ground wire
- 4.) Operate wireless unit to insure Unit is operating properly

Function

- 1.) This device is activated by pushing either button 1 or 2 to power the unit.
- 2.) 20 Minute shut off (receiver shuts down after being idle for 20 minutes)
  - a. Press both buttons 1 & 2 for 10- 20 seconds to end Shutdown Mode
  - b. When in Shutdown Mode, Wireless receiver is the only item shutdown, Out Put 2 is still active
- 3.) Operating Frequency: 315MHz

How to operate the Remote Learning mode

- 1.) Remove wired hand control to prevent accidental operation.
- 2.) Disconnect Positive (*Red*) & Negative (*Black*) Ring Terminals
- 3.) Remove program pin from the receiver to start Learning Mode.
- 4.) Reconnect Positive (*Red*) & Negative (*Black*) Ring Terminals (*Receiver will click*)
- 5.) Press either button 1 or 2 (receiver will click 2 to 9 times depending on how long you hold the button down)
- 6.) Replace program pin on the receiver to end Learning Mode.

(When in learning mode Remote Unit must be operated within 3-5 seconds to learn new code. Otherwise the

device will jump back and resume previous frequency.) **Unit may not operate below 11 Volts**

**ONBOARD BATTERY CHARGER & TESTER**

1. SPECIFICATIONS

ITEM	DESCRIPTION
Input	AC 120V, 60Hz, 0.4amp
Output	DC 12V, 1.5amp
Battery Cables	24 inches, 18AWG
Lead Wire	3-Prong Plug
Features	LED Self-resetting circuit breaker

2. OPERATION

- 1) Connect the positive (red) cable to the positive terminal of the battery.  
Connect the negative (Black) cable to the negative terminal of the battery.
- 2) Connect the power outlet (110VAC/60Hz) to the 3-Prong plug of the charger.
- 3) The LED on the battery charger will indicate the status of the charger.
- 4) The LED on the battery tester will indicate the statue of the battery and alternator/charging system.
- 5) To test a battery, the vehicle’s engine, lighting, and accessories must be off.
- 6) To test an alternator/charging system, the engine must be running at 2,000 RMP minimum, the lights and accessories must be turned off and the unit must be unplugged from the AC power.
- 7) Then simply push the “PUSH” button to get your test results.

3. LED Indication

Battery Charger

Light Color	On/Off	Condition
Green	On	AC power is present
	Off	Check wall receptacle for 110 volts or check lead connections, may be reversed.
Orange	On	Charging
	Off	Charged

Battery & Alternator Condition Tester

Red	Yellow	Blue	Green	Condition	Remedy
OFF	OFF	OFF	OFF	Battery dead (down 11.3V)	Please replace it
ON	OFF	OFF	OFF	Battery is poor (11.3 to 11.7V)	Please stop work and charge it to fully
ON	ON	OFF	OFF	Battery is fair (11.8 to 12.2V)	Please charge it to fully
ON	ON	ON	OFF	Battery is good (12.3 to 13.6V)	Please charge it for maintaining
ON	ON	ON	ON	Alternator/charging system is good	
--	--	--	OFF	Alternator/charging system is faulty	Please repair it

## 10 INSPECTION, SERVICE & MAINTENANCE

### 10.1 INSPECTION, SERVICE & MAINTENANCE SUMMARY CHARTS

You must inspect, maintain and service your trailer regularly to insure safe and reliable operation. If you cannot or are unsure how to perform the items listed here, have your dealer do them. Note: In addition to this manual, also check the relevant component manufacturer's manual.

#### Inspection and Service before each Tow

Item	Inspection / Service	Manual Section Reference
<b>Breakaway Brakes</b> > Electric > Hydraulic	Check operation Check operation	"Coupling to the Tow Vehicle" section
<b>Breakaway Battery</b>	Fully charged, connections clean	"Coupling to the Tow Vehicle" section and Section 10.2.3.3
<b>Brakes</b> > Electric > Surge	Check operation Check operation Check Master Cylinder Level	"Coupling to the Tow Vehicle" section
<b>Shoes and Drums</b>	Adjust	Section 8.2 & 10.2.1.4
<b>Safety Chains &amp; Hooks</b>	Check for wear, damage	"Coupling to the Tow Vehicle" section
<b>Coupler and Hitch Ball</b>	Check for cracks, pits, and flats. Replace w/ball & coupler having trailer GVW Rating. Grease.  Check locking device & replace when worn.	"Coupling to the Tow Vehicle" section  "Coupling to the Tow Vehicle" section Section 10.2.1.11
<b>Gooseneck Ball</b>	Check for cracks, pits, and flats. Replace w/ball & coupler having trailer GVW Rating. Grease. Check locking device & replace when worn.	"Coupling to the Tow Vehicle" section  "Coupling to the Tow Vehicle" section Section 10.2.1.13

## Inspection, Service & Maintenance

<b>Ring &amp; Pintle</b>	<p>Check for cracks, pits and flats. Replace w/ring and pintle having trailer GVW rating Grease.</p> <p>Check locking device &amp; replace when worn.</p>	<p>“Coupling to the Tow Vehicle” section</p> <p>“Coupling to the Tow Vehicle” section Section 10.2.5.2</p>
<b>Tires</b>	<p>Check tire pressure when cold. Inflate as needed.</p> <p>Check for damage.</p>	<p>Sections 7.1 &amp; 10.2.9</p> <p>Sections 7.1 &amp; 10.2.9</p>
<b>Wheels - Lug Nuts (Bolts) &amp; Hub</b>	<p>Check for tightness Tighten. For new and remounted wheels, check torque after first 10, 25 &amp; 50 miles of driving and after any impact</p>	<p>Section 7.1</p> <p>Sections 8.1 &amp; 10.2.13</p>

### Inspection and Service each Month

<b>Item</b>	<b>Inspection / Service</b>	<b>Manual Section Reference</b>
<b>Lubrication</b>	<b>Lubricate door hinges and dump body pivots</b>	<b>Section 10.2.11</b>

### Inspection and Service each 6 Months or 6,000 Miles

<b>Item</b>	<b>Inspection / Service</b>	<b>Manual Section Ref.</b>
<b>Brakes, electric</b> > Magnets > Controller (in tow vehicle)	<p>Check wear and current draw</p> <p>Check power output (amperage) and modulation</p>	<p>Section 10.2.1.7</p> <p>Section 10.2.1.6</p> <p>See Controller Mfr's Manual</p>
<b>Tires</b>	<p>Inspect tread and sidewalls thoroughly.</p> <p>Replace tire when treads are worn, when sidewall has a bulge, or sidewall is worn.</p> <p>Rotate Every 5,000 Miles</p>	<p>Section 10.2.9</p> <p>Section 10.2.9</p> <p>Section 10.2.9</p>

## Inspection, Service & Maintenance

Inspection and Service Each Year or 12,000 Miles

Item	Inspection / Service	Manual Section Reference
<b>Brakes, all types</b> > Shoes and drums	Check for scoring and wear. Replace per manufacturer's specifications	Section 10.2.1.3 See Brake Mfr's Manual
<b>Jack, Drop-leg</b>	Grease gears at top	See Jack Mfr's Manual
<b>Structure</b> > Frame members > Welds	Inspect all frame members, bolts & rivets. Repair or replace damaged, worn or broken parts. Inspect all welds. Repair as needed	Section 0  Section 10.2.1.2
<b>Wheels</b> > Wheel Bearings  > Rims	Disassemble / inspect / assemble and repack. Replace promptly if immersed in water Inspect for cracks & dents. Replace as needed.	Section 0 & See Axle Mfr's Manual  Section 0
<b>Structure</b> > Axle Attachment Bolts	Check BY DEALER	Section 0

### 10.2 INSPECTION AND SERVICE INSTRUCTIONS

#### AXLE BOLTS, FRAME, SUSPENSION, & STRUCTURE

#### **WARNING**

**Worn or broken suspension parts can cause loss of control and injury may result.**

**Have trailer professionally inspected annually and after any impact.**

To perform many of the inspection and maintenance activities, you must jack up the trailer.

When jacking and using jack stands, place them so as to clear wiring, brake lines, and suspension parts (springs, torsion bars, etc.). Place jacks and jack stands under the outer frame rail to which the axles are attached.

**⚠ WARNING**

**Never crawl under your trailer unless it is on firm and level ground and resting on properly placed and secured jack stands.**

**⚠ WARNING**

**Crushing hazard**

**The tow vehicle and trailer could be inadvertently moved while a person is under the trailer.**

**The tow vehicle engine must be off, ignition key removed and parking brakes set before entering the area under the trailer.**

**TRAILER STRUCTURE**

Wash the trailer as needed with a power washer and a detergent solution.

**10.2.1.1 Fasteners and Frame Members**

Inspect all of the fasteners and structural frame members for bending and other damage, cracks, or failure. Repair or replace any damaged fastener and repair the frame member. If you have any questions about the condition or method of repair of fasteners or frame members, get the recommendation of, or have the repair done by your dealer.

**⚠ WARNING**

**Broken or damaged fasteners or welds can cause injury or damage to trailer and contents.**

**Inspect for, and repair all damaged parts at least once a year.**

**10.2.1.2 Welds**

All welds can crack or fail when subjected to heavy loads or movement of cargo that was not properly tied to prevent movement. Any time that you know or suspect that the trailer has been subjected to heavy loads or movement of cargo, immediately inspect the welds and fasteners for damage. To prevent severe damage to your trailer, inspect all of the welds for cracks or failure at least once a year. If a weld failure is detected, contact your dealer.

**⚠ WARNING**

**Broken or damaged fasteners or welds can cause injury or damage to trailer and contents.**

**Inspect for, and repair all damaged parts at least once a year.**

**TRAILER BRAKES - ELECTRIC**

**10.2.1.3 Brake Shoes and Drums**

Properly functioning brake shoes and drums are essential to ensure safety. You must have your dealer inspect these components at least once per year, or each 12,000 miles. Brake adjustment is not covered under the axle warranty.

The brake shoes must be adjusted after the first 200 miles of use, and each 3,000 miles thereafter. Most axles are fitted with a brake mechanism that will automatically adjust the brake shoes when the trailer is “hard braked” from a rearward direction. Read your axle and brake manual to see how to adjust your brakes. If you do not have this manual, contact your dealer for assistance.

**10.2.1.4 Manually Adjusting Brake Shoes**

Some braking systems are not automatically adjusted by hard stopping. These brakes require manual adjustment. The following steps apply to adjust most manually adjustable brakes. Read your axle and brake manual to see how to adjust your brakes. If you do not have this manual, contact your dealer for assistance.

- Jack up the trailer and secure it on adequate capacity jack stands.
- Be sure the wheel and brake drum rotate freely.
- Remove the adjusting-hole cover from the adjusting slot on the bottom of the brake backing plate.
- With a screwdriver or standard adjusting tool, rotate the starwheel of the adjuster assembly to expand the brake shoes. Adjust the brake shoes out until the pressure of the linings against the drum makes the wheel very difficult to turn. Note: Your trailer maybe equipped with drop spindle axles. See axle manual for your axle type. You will need a modified adjusting tool for adjusting the brakes in these axles. With drop spindle axles, a modified adjusting tool with about an 80 degree angle should be used.
- Rotate the starwheel in the opposite direction until the wheel turns freely with a slight drag.
- Replace the adjusting-hole cover.
- Repeat the above procedure on all brakes.
- Lower the trailer to the ground.

**10.2.1.5 Brakes, Electric**

Two different types of electric brakes may be present on the trailer: an emergency electric breakaway system, which acts only if the trailer comes loose from the hitch



and the breakaway pin is pulled. The other brake is an electric braking system that acts whenever the brakes of the tow vehicle are applied.

### Breakaway Brake

**Breakaway Battery** - This battery supplies the power to operate the trailer brakes if the trailer uncouples from the tow vehicle. Be sure to check, maintain and replace the battery according to the battery manufacturer's instructions.

**Breakaway Switch** - This switch causes the breakaway battery to operate the electric brakes if the trailer uncouples from the tow vehicle.

The lanyard for the pull pin is connected to the tow vehicle, and the switch is connected to the trailer. To check for proper functioning of the switch, battery and brakes, you must pull the pin from the switch and confirm that the brakes apply to each wheel. You can do this by trying to pull the trailer with the tow vehicle, after pulling the pin. The trailer brakes may not lock, but you will notice that a greater force is needed to pull the trailer.

### **WARNING**

**If electric breakaway brakes do not operate when trailer is uncoupled from the tow vehicle, death or serious injury can occur.**

**Check emergency breakaway brake system BEFORE each tow.**

#### 10.2.1.6 Tow Vehicle Operated Electric Brakes

The electric brakes that operate in conjunction with the tow vehicle brakes must be "synchronized" so that braking is properly distributed to the tow vehicle brakes and the trailer brakes. For proper operation and synchronization, read and follow the axle/brake and the brake controller manufacturers' instructions. If you do not have these instructions, contact your dealer for assistance.

#### 10.2.1.7 Magnets for all Electric Brakes

To make certain an electrically-operated braking system will function properly, you must have your dealer inspect the magnets at least once a year, or each 12,000 miles. See the brake manual for wear and current inspection instructions.

### **TRAILER BRAKES – SURGE (IF EQUIPPED)**

#### 10.2.1.8 Surge Brake Master Cylinder

Check fluid level prior to using the trailer. The master cylinder (1) is located on the tongue of the trailer. The fluid level must be maintained at no less than ½ full, and no more than ½ inch from the top. Use DOT type 3 or 4 automotive brake fluid.



*Hydraulic Reservoir*

### **10.2.1.9 Hydraulic Surge Brake**

Before each tow, perform the following steps:

- Check that the brake master cylinder level as instructed above. Check for leaks and repair as required.
- Examine the actuator for wear, bent parts, corroded/seized parts, or other damage. Have the affected components replaced with genuine service parts.
- Check to determine that the actuator mounting bolts are tightened to the manufacturer's specification.
- Test the actuator and brake function as described in the Coupling to the Tow Vehicle section of this manual. Actuator travel over one inch indicates that the brakes need adjustment (or that the actuator has been structurally damaged). Actuator travel is the distance the coupler case assembly moves to the outer case during braking. Adjust the brakes following the instructions given in the brake installation manual. Failure to adjust brakes will result in loss of braking.
- Before storage or after extended use, apply motor oil to the coupler components and the internal rollers to keep them moving freely and to prevent corrosion.

See the surge brake manufacturer's manual for other inspection and maintenance activities. If you do not have this manual, contact your dealer for assistance.

### **10.2.1.10 Master Cylinder Bleeding**

Remove the master cylinder's cap and fill the reservoir to three quarters full with DOT-3 or DOT 4 brake fluid. DO NOT allow brake fluid to contact painted surfaces since it will damage the finish. Wipe up any spills immediately and wash the area with water.

Bleed the brake system either manually or with a pressure bleeder. Pressure bleeding equipment simplifies the process, and is available at most automotive supply stores. Use the instructions provided with the pressure bleeder. If you chose

to manually bleed the system, an assistant is required. Use the following steps to manually bleed the brake system:

- Disconnect the trailer from the tow vehicle and jack the trailer's tongue until it is horizontal. Make sure that the wheels are blocked so that the trailer will not roll away.
- Fill the master cylinder with fluid as described in 10.2.4.1.
- Install a bleeder hose on the bleeder screw of the farthest wheel cylinder from the actuator. If the trailer has multiple axles, bleed the rear axle first. Submerge the other end of the hose in a glass container of brake fluid, so that air bubbles can be observed.
- Open the bleeder screw and have your assistant stroke (but not release) the actuator. Brake fluid and/or air bubbles will flow into the jar. Close the bleeder screw. The helper can then allow the actuator to return to its rest position.

Repeat the process until no more bubbles are released with the stroke. Air trapped in the brake lines will greatly reduce your braking efficiency. Be sure to close the bleeder screw securely when the cylinder is fully bled. Repeat the bleeding operation at each wheel cylinder. During the bleeding process, replenish the master cylinder reservoir with fresh brake fluid so that the level does not fall below half full. This will ensure that no air is drawn into the system.

After all brakes have been bled, refill the master cylinder as described in section 10.2.4.1 before operating. Be sure to install the master cylinder filler cap.

### **WARNING**

**Use only fresh brake fluid from a sealed container. DO NOT reuse fluid. After filling and bleeding, refill the actuator. Failure to maintain an adequate fluid level may cause brake failure.**

## **TRAILER CONNECTION TO TOW VEHICLE**

### **10.2.1.11 Bumper Pull Coupler and Ball**

The coupler on the trailer connects to the ball attached to the hitch on the tow vehicle. The coupler, ball and hitch transfer the towing forces between the tow vehicle and the trailer. Before each tow, coat the ball with a thin layer of automotive bearing grease to reduce wear and ensure proper operation; and check the locking device that secures the coupler to the ball for proper operation.

See the coupler manufacturer's manual for other inspection and maintenance activities. If you do not have this manual, contact your dealer for assistance.

If you see or feel evidence of wear, such as flat spots, deformations, pitting or corrosion, on the ball or coupler, immediately have your dealer inspect them to determine the proper action to prevent possible failure of the ball and coupler system. All bent or broken coupler parts must be replaced before towing the trailer.

The coupler handle lever must be able to rotate freely and automatically snap into the latched position. Oil the pivot points, sliding surfaces, and spring ends with SAE 30W motor oil. Keep the ball pocket and latch mechanism clean. Dirt or contamination can prevent proper operation of the latching mechanism.

When replacing a ball, the load rating must match or exceed the GVWR of the trailer.

### **10.2.1.12 Ring and Pintle**

The ring on the trailer connects to the pintle attached to the hitch on the tow vehicle. The ring, pintle and hitch transfer the towing forces between the tow vehicle and the trailer. Before each tow, coat the ring with a thin layer of automotive bearing grease to reduce wear and ensure proper operation; and check the locking device that secures the pintle to the ring for proper operation.

See the pintle manufacturer's manual for other inspection and maintenance activities. If you do not have this manual, contact your dealer for assistance.

If you see or feel evidence of wear, such as flat spots, deformations, pitting or corrosion, on the ring or pintle, immediately have your dealer inspect them to determine the proper action to prevent possible failure of the ring and pintle system. All bent or broken coupler parts must be replaced before towing the trailer.

The pintle handle lever must be able to rotate freely and automatically snap into the latched position. Oil the pivot points, sliding surfaces, and spring ends with SAE 30W motor oil. Keep the ring pocket and latch mechanism clean. Dirt or contamination can prevent proper operation of the latching mechanism. When replacing a ring, the load rating must match or exceed the GVWR of the trailer.

### **10.2.1.13 Gooseneck Ball Receiver**

The gooseneck receiver on the trailer connects to a hitch-mounted ball on the towing vehicle. The receiver, ball and hitch transfer the towing forces between the tow vehicle and the trailer. Before each tow, coat the ball with a thin layer of automotive bearing grease to reduce wear and ensure proper operation; and check the locking device that secures the receiver to the ball for proper operation.

See the gooseneck ball receiver manufacturer's manual for other inspection and maintenance activities. If you do not have a manual for the receiver, contact your dealer for assistance.

If you see or can feel evidence of wear, such as flat spots, pitting or corrosion, on the ball or receiver, immediately have your dealer inspect them to determine the proper action to prevent possible failure of the ball and receiver system.

When replacing a ball, the load rating must match or exceed the GVWR of the trailer.

### LANDING LEG OR JACK

If a grease fitting is present, you must use a grease gun to lubricate the jack mechanism. Grease the gears in the top of hand-cranked jacks once a year, by removing the top of the jack and pumping or hand packing grease into the gears.

### LIGHTS AND SIGNALS

Before each tow, check the trailer taillights, stoplights, turn signals and any clearance lights for proper operation.

 <b>WARNING</b>
--

<b>To avoid risk of collisions, all lights must work.</b>
---

### WHEEL RIMS

If the trailer has been struck, or impacted, on or near the wheels, or if the trailer has struck a curb, inspect the rims for damage (i.e. being out of round); and replace any damaged wheel. Inspect the wheels for damage every year, even if no obvious impact has occurred.

### TIRES

Trailer tires may be worn out even though they still have plenty of tread left. This is because trailer tires have to carry a lot of weight all of the time, even when not in use. It is actually better for the tire to be rolling down the road than to be idle. During use, the tire releases lubricants that are beneficial to tire life. Using the trailer often also helps prevent flat spots from developing. The main cause for tire failure is improper inflation.

Before each tow, check the tire pressure to make sure it is at the level indicated on the tire sidewall or VIN label. Tire pressure must be checked while the tire is cold. Do not check tire pressure immediately after towing the trailer. Allow at least three hours for the tires to cool, if the trailer has been towed for as much as one mile.

Tires can lose air over a period of time. In fact, tires can lose 1-3 psi per month. This is because molecules of air, under pressure, weave their way from the inside of the tire, through the rubber to the outside. A drop in tire pressure could cause excessive heat build up. If the tire is under-inflated, even for a short period of time, the tire could suffer internal damage.

High towing speed in hot conditions degrades the tire significantly. As heat builds up during driving, the tire's internal structure starts to breakdown, compromising the strength of the tire. It is recommended to drive at moderate speeds.

Replace the tire before towing the trailer if the tire treads have less than 2/32 inch depth or the telltale bands are visible.

---

## Inspection, Service & Maintenance

---

A bubble, cut or bulge in a side wall can result in a tire blowout. Inspect both side walls of each tire for any bubble, cut or bulge; and replace a damaged tire before towing the trailer.

If you are storing your trailer for an extended period, make sure the tires are inflated to the maximum rated pressure indicated on the sidewall or VIN label and that you store them in a cool, dry place such as a garage. Use tire covers to protect the tires from the harsh effects of the sun.

### **WARNING**

**Worn, damaged or under-inflated tires can cause loss of control, injury and damage.**

**Check tires before each tow.**

Tire / Wheel Components – Limited Warranty:

Load Trail LLC, warrants, subject to the terms, conditions, and limitations state herein, tires, and wheels to be free from defects in materials and workmanship.





1. This Limited Warranty applies only to the original purchaser for two years from the warranty start date.
2. The warranty period for the coating of the wheel is ninety (90) days from the warranty start date.
3. 100 % replacement for any material or manufacturing defects.
4. The Limited Warranty does not cover incidental or consequential damages, including, but not limited to, lost time, inconvenience, loss of vehicle use, cost of towing or transportation, related property damage or consequential damages of any type of nature.
5. The tire is worn past last 3/32 of tread depth at any point on tread contact surface

The warranty does not apply to the following:

- Tires or wheels subjected to overloading, under-inflation, improper mounting, fitment to incorrect rim, purposeful abuse or chemical contamination.
  - Tires or wheels which have been patched, plugged or repaired or into which liquid balancers or sealants have been introduced.
6. This Limited Warranty makes no expressed claims of expected tire wear. Variables that affect tire wear are driving conditions, load and tire inflation pressure.

Note: All specifications subject to change without notice.

## Inspection, Service & Maintenance

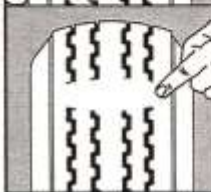
	<b>Condition</b>	<b>Possible Cause</b>	<b>Remedy</b>
	Even Center Wear	Over Inflation	Check & Adjust Pressure When Cold
	Inside & Outside Wear	Under Inflation	Check & Adjust Pressure When Cold
	Smooth, Side Wear - One Side	Loss of Camber or Overloading	Check & Unload As Necessary Have Alignment Checked
	"Feathering" Across The Face	Axle Not Square To Frame or Incorrect Toe In	Square Axles Have Alignment Checked
	Cupping	Loose Bearings or Wheel Balance	Check Bearing Adjustment and Wheel & Tire Balance
	Flat Spots	Wheel Lockup	Adjust Brakes

*Tire Inspection Chart*

## Inspection, Service & Maintenance

---

### **DEXTER AXLE IDENTIFICATION**

In the unlikely event that you should require service assistance from Dexter Axle, Please have the lot (serial) number of the axle available when you call.

On all axles produced after April 2001, this nine digit number can be found near the center on the rear side of the axle beam. Look for the words DEXTER AXLE And the lot number will be located directly under the name. For easier identification, rubbing a piece of chalk over the number may help bring out the engraving.

Recreational Vehicle axles that have been certified for use in Canada will also bear the letters CSA.





## Inspection, Service & Maintenance

### DEXTER MAINTENANCE SCHEDULE

Item	Function Required	3 Months or 6 Months or 12 Months or			
		Weekly	3,000 Miles	6,000 Miles	12,000 Miles
Brakes	Test that they are operational.	At Every Use			
Brake Adjustment	Adjust to proper operating clearance (not required with Nev-R-Adjust® brakes).		●		
Brake Magnets	Inspect for wear and current draw.			●	
Brake Linings	Inspect for wear or contamination.				●
Brake Controller	Check for correct amperage and modulation.			●	
Brake Cylinders	Check for leaks, sticking.				●
Brake Lines	Inspect for cracks, leaks, kinks.				●
Trailer Brake Wiring	Inspect wiring for bare spots, fray, etc.				●
Breakaway System	Check battery charge and switch operation.	At Every Use			
Hub/Drum	Inspect for abnormal wear or scoring.				●
Wheel Bearings and Cups	Inspect for corrosion or wear. Clean and repack.				●
Seals	Inspect for leakage. Replace if removed.				●
Springs	Inspect for wear, loss of arch.				●
Suspension Parts	Inspect for bending, loose fasteners and wear.			●	
Suspension Wet Bolts & Equalizers	Grease.		●		
Extreme Duty Bushings	Grease.		●		
Hangers	Inspect welds.				●
Wheel Nuts and Bolts	Tighten to specified torque values.		●		
Wheels	Inspect for cracks, dents, or distortion.			●	
Tire Inflation Pressure	Inflate tires to mfg's. specifications.	●			
Tire Condition	Inspect for cuts, wear, bulging, etc.		●		

### **WHEEL BEARINGS**

A loose, worn or damaged wheel bearing is the most common cause of brakes that grab.

To check your bearings, jack up trailer and check wheels for side-to-side looseness. If the wheels are loose, or spin with a wobble, the bearings must be serviced or replaced. Contact the axle manufacturer regarding any warranty considerations.

<b>⚠ WARNING</b>
------------------

<b>Never crawl under your trailer unless it is on firm and level ground and resting on properly placed and secured jack stands.</b>
---

### **LUBRICATION**

<b>⚠ DANGER</b>
-----------------

<b>Risk of death by crushing.</b>
-----------------------------------

<b>Empty dump body before using body prop.</b>
--

<b>⚠ WARNING</b>
------------------

<b>Risk of death by crushing.</b>
-----------------------------------

<b>Dump body or tilt deck can drop unexpectedly.</b>
--

<b>Never go under a raised dump body.</b>
---

<b>Use body prop for maintenance.</b>
---------------------------------------

<b>⚠ WARNING</b>
------------------

<b>Risk of death by crushing.</b>
-----------------------------------

<b>Make sure dump body is empty.</b>
--------------------------------------

<b>DO NOT manipulate the body safety prop if a person is near the control.</b>
--

The body prop supplied as part of the trailer is to be used only when the dump body is empty. The purpose of the body prop is a back-up to the hydraulic system and will hold the empty dump body in a raised position while performing maintenance on the hoist, trailer body, or the trailer itself.

## Inspection, Service & Maintenance

---

**DO NOT** use the body prop to support a loaded dump body.

**DO NOT** go under a raised dump body unless the dump body is supported by the body prop.

### 10.2.1.14 Dump Trailers

Pump grease into the dump body hinge fittings and rear door hinges every month.

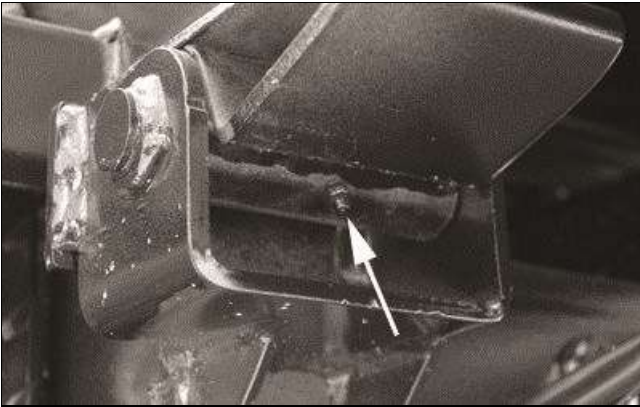

*Lubricate Dump Body Pivot Hinges*

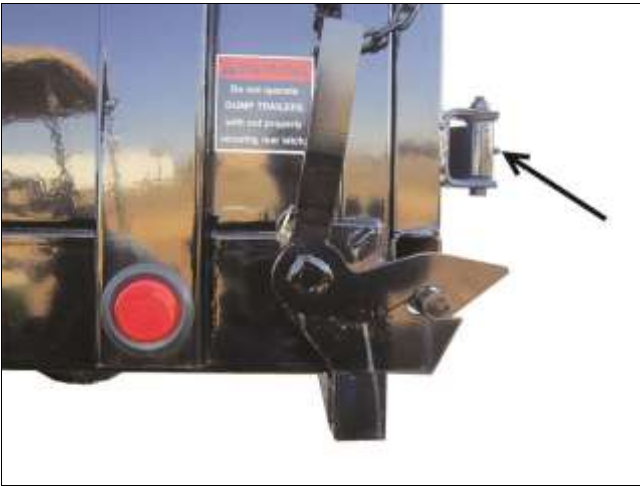

*Lubricate Door Hinges*

Park the trailer on a firm and level surface. Raise the dump body and place the body prop (1) in the upright position. Lower the dump body onto the body prop. The body prop (1) must engage the receiver (2).

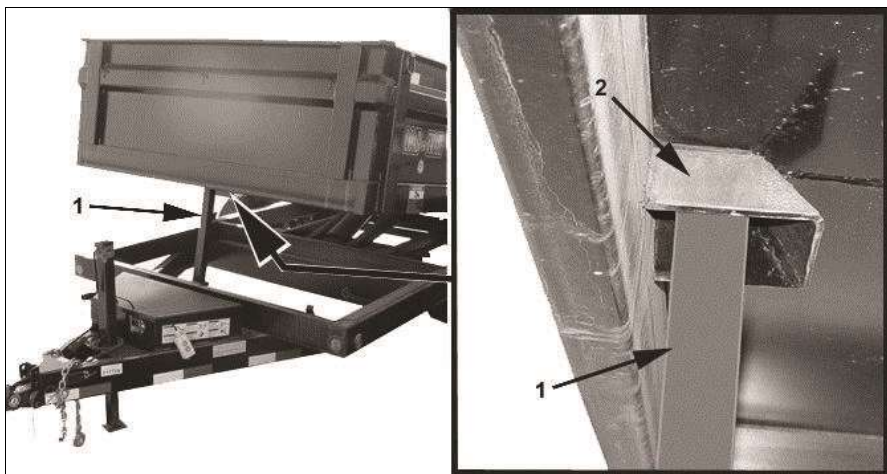

*Dump Trailer Body Prop Engaged*

Pump grease into the fittings on each end of the cylinder(s) and in the scissor mechanism (if equipped). The number of grease fittings and location on the scissor mechanism will vary by trailer model.



*Lubricate Scissor Mechanism*



*Lubricate Scissor Mechanism*

For trailers equipped with fold down sides, pump grease into each fitting on the fold down side hinges every month.

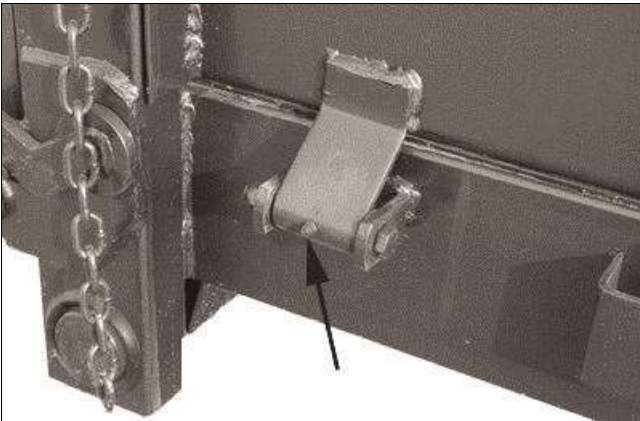

*Lubricate Fold Down Side Panel Hinges*

### 10.2.1.15 Tilt Deck Trailers

Pump grease into the tilt deck hinge grease fittings every month.

Park the trailer on a firm and level surface. Raise the tilt deck and place the safety prop (1) in the upright position. Lower the deck onto the safety prop. The safety prop (1) must engage the receiver (2).

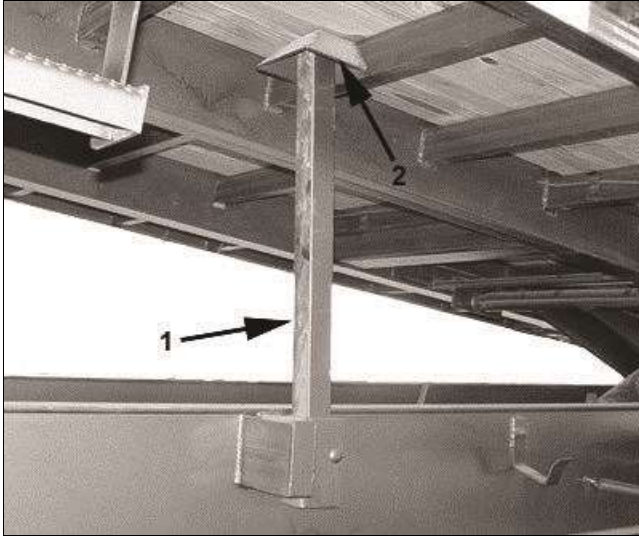

*Tilt Deck Trailer Safety Prop Engaged*

Pump grease into the fittings on each end of the cylinder and at each pivot point of the scissor mechanism. The number of grease fittings and location on the scissor mechanism will vary by trailer model.

### HYDRAULIC RESERVOIR

Check fluid level prior to using the trailer. The reservoir (1) is located inside the battery box. (Box on the tongue of the trailer illustrated in figure below.) The dump body must be fully lowered before checking fluid level. The reservoir should be filled to the full mark on the side of the reservoir. Fluid ejecting from the reservoir could indicate a low battery. (If the battery is not fully charged, the hydraulic pump will lose pressure causing hydraulic fluid to flow back into the hydraulic reservoir, overfilling the reservoir.)

KTI recommends using a premium hydraulic oil to ensure optimum performance and system life. Select oil that has anti-wear properties, rust and oxidation inhibitors, foam inhibitors and good stability. Examples of premium grade hydraulic oils: Chevron Rando HDZ, Mobil DTE 10, DTE 20 series, AMSOIL, and Shell Tellus.

Automotive Transmission Oils are acceptable under normal conditions.

Aviation Oils such as Valvoline ROYCO series or Mobil Aero HF or HFA may be used in **prolonged, extreme cold** environments.

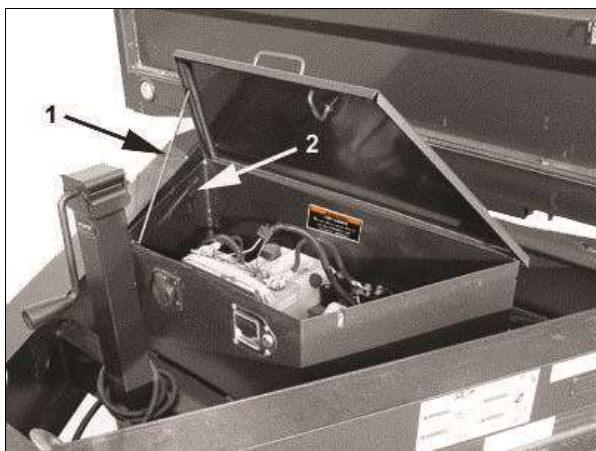

*Hydraulic Reservoir*

### LUG NUTS

Lug nuts are prone to loosen right after a wheel is mounted to a hub. When driving on a remounted wheel, check to see if the lug nuts are tight after the first 10, 25 and 50 miles of driving, and before each tow thereafter.

#### **⚠ WARNING**

**Lug nuts are prone to loosen after being first assembled. Death or serious injury can result.**

**Check lug nuts for tightness on a new trailer, and after re-mounting a wheel at 10, 25 and 50 miles.**

#### **⚠ WARNING**

**Metal creep between the wheel rim and lug nuts (bolts) can cause rim to loosen.**

**Death or injury can occur if wheel comes off.**

**Tighten lug nuts (bolts) before each tow.**

Tighten the lug nuts in three stages to the final torque for the axle size on your trailer, to prevent wheels from coming loose. Tighten each lug nut in the order shown in figure below. Use a calibrated torque wrench to tighten the fasteners. Verify that wheel studs are free of contaminants such as paint or grease, which may result in inaccurate torque readings. Over-tightening will result in breaking the studs or permanently deforming the mounting stud holes in the wheels, and will void the axle warranty.

**WHEEL TORQUE REQUIREMENTS**

5,200 lb. to 8,000 lb. Axles

Wheel Size	1 <sup>st</sup> Stage	2 <sup>nd</sup> Stage	3 <sup>rd</sup> Stage
12"	20-25	35-40	50-75
13"	20-25	35-40	50-75
14"	20-25	50-60	90-120
15"	20-25	50-60	90-120
16"	20-25	50-60	90-120
16.5" x 6.75"	20-25	50-60	90-120
16.5" x 9.75"	55-60	120-125	175-225
14.5" Demount	Tighten sequentially to		85-95
17.5" Hub Pilot Clamp ring & Cone nuts	50-60	100-120	190-210
17.5" Hub Pilot 5/8" Flange Nuts	50-60	90-200	275-325

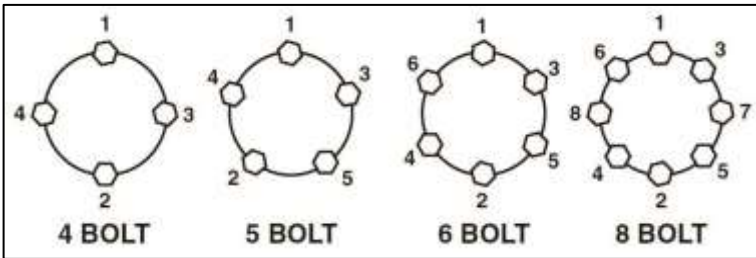

**⚠ CAUTION**

Proper matching of the tire/wheel combination is essential to proper function of your trailer running gear. Some tires may call for a maximum inflation pressure above the rim or wheel capacity. **DO NOT EXCEED MAXIMUM INFLATION PRESSURES FOR RIMS OR WHEELS.** Catastrophic failure may result.



## Inspection, Service & Maintenance

### 9,000 lb. to 15,000 lb. Axles

Description	Part No.	Application	Torque Min Ft-Lbs.	Torque Max Ft.Lbs.
$\frac{5}{8}$ -18 90° Cone Nut	006-109-00	Clamp Ring 033-052-01	190	210 Greased Threads
$\frac{3}{4}$ -10 Hex Nut	006-117-00	Demountable Rim Clamp	210	260
$\frac{3}{4}$ -16 Spherical Nut	006-064-01, 02 006-069-01, 02	Single Wheel Inner Dual	450 450	500 500
$1\frac{1}{8}$ -16 Spherical Nut	006-070-01, 02	Outer Dual	450	500
$\frac{5}{8}$ -18 Flange Nut	006-058-00	Wheels	275	325
M22-1.5	006-118-00	Swiveling Flange Nut	450	500

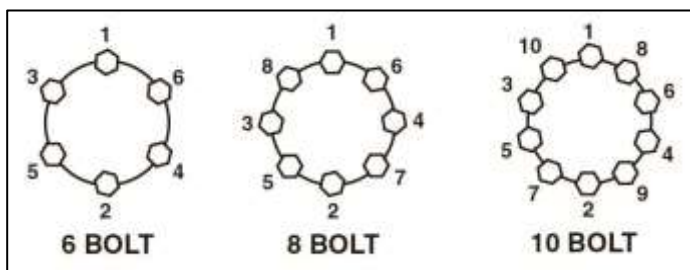

## CAUTION

Proper matching of the tire/wheel combination is essential to proper function of your trailer running gear. Some tires may call for a maximum inflation pressure above the rim or wheel capacity. **DO NOT EXCEED MAXIMUM INFLATION PRESSURES FOR RIMS OR WHEELS.** Catastrophic failure may result.

### HYDRAULIC DOVE TAIL ADJUSTMENT

Make sure Lever is in lock position (1) as shown below.



Dove Tail Lever

- Take a straight piece of metal and put under pins (2,3) as shown below.
- Adjust bolt (4) until there's a  $\frac{1}{4}$ " gap (5) between the piece of metal and arm.



Hydraulic Dove Tail Arm Adjustment

### TRAILER STORAGE PREPARATION

If your trailer is to be stored for an extended period of time or over the winter, it is important that the trailer be prepared properly.

1. Remove the emergency breakaway battery and store inside, out of the weather. Charge the battery at least every 90 days.
2. Jack up the trailer and place jack stands under the trailer frame so that the weight will be off the tires. Follow trailer manufacturer's guidelines to lift and support the unit. Never jack up or place jack stands on the axle tube or on the equalizers.

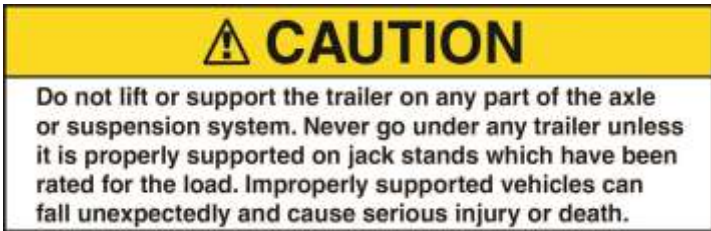

3. Lubricate mechanical moving parts such as the hitch, and suspension parts, that are exposed to the weather.
4. Boat trailer axles are subject to repeated immersion. Before storing, remove brake drums; clean, dry and re-lubricate moving brake components; inspect bearings – clean and re-lubricate.
5. On oil lubricated hubs, the upper part of the roller bearings are not immersed in oil and are subject to potential corrosion. For maximum bearing life, it is recommended that you revolve your wheels periodically (every 2-3 weeks) during periods of prolonged storage.

### **AFTER PROLONGED TRAILER STORAGE INSPECTION PROCEDURE**

Before removing trailer from jack stands:

1. Remove all wheels and hubs or brake drums. Note which spindle and brake that the drum was removed from so that it can be reinstalled in the same location.
2. Inspect suspension for wear.
3. Check tightness of hanger bolt, shackle bolt, and U-bolt nuts per recommended torque values.
4. Check brake linings, brake drums and armature faces for excessive wear or scoring.
5. Check brake magnets with an ohmmeter. The magnets should check 3.2 ohms. If shorted or worn excessively, they must be replaced.
6. Lubricate all brake moving parts using a high temperature brake lubricant (LUBRIPLATE or Equivalent).



7. Remove any rust from braking surface and armature surface of drums with fine emery paper or crocus cloth. Protect bearings from contamination while so doing.
8. Inspect oil or grease seals for wear or nicks. Replace if necessary.
9. Lubricate hub bearings. Refer to procedure in manual.
10. Reinstall hubs and adjust bearings per instructions in manual.
11. Mount and tighten wheels per instructions in manual.

### 10.3 ELECTRICAL CONNECTOR WIRING DIAGRAMS

#### 4 PIN CONNECTOR

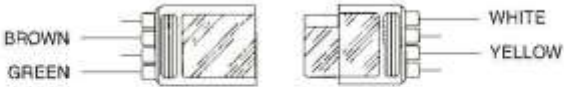

COLOR	DESCRIPTION
Brown	Tail Lights
Green	Right Turn
White	Ground
Yellow	Left Turn

#### 6 PIN CONNECTOR

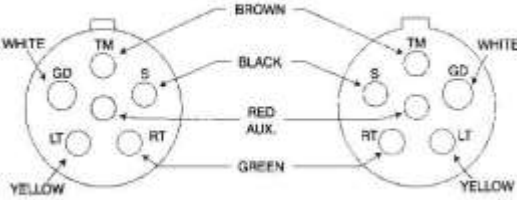

PLUG	COLOR	DESCRIPTION
GD	White	Ground
S	Black	Electrical Brakes (if equipped)
LT	Yellow	Left Turn Signal
RT	Green	Right Turn Signal
TM	Brown	Tail Lights
CENTER	Red	Charge Line

NOTE: Identify contacts by looking into the open end of plug or socket.

#### 7 PIN CONNECTOR

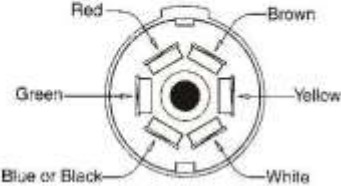

COLOR	DESCRIPTION
White	Ground
Blue or Black	Electrical Brakes (if equipped)
Yellow	Left Turn Signal
Green	Right Turn Signal
Brown	Tail Lights
Red	Charge Line

*Electrical Connectors*

**Note:** Center post on vehicle plug must be active with reverse indicator if trailer is equipped with hydraulic surge brakes.

NOTES \_\_\_\_\_

**Load Trail LLC  
220 FM 2216  
Sumner, TX 75486  
903-783-3900 Phone  
903-783-3903 Fax  
[www.loadtrail.com](http://www.loadtrail.com)**

### **Revision 2014**

**Please Note: Load Trail LLC cannot diagnose technical issues on the phone. We depend on our dealers to provide this service. If a dealer is unavailable, please take the unit to a qualified repair facility for diagnosis. If the unit is within the warranty period, contact the dealer first for assistance in processing the warranty claim.**

---

**\*OWNERS MANUAL IS SUBJECT TO CHANGE WITHOUT NOTICE\***