



Operating manual
Hands-free car kit
VoiceTalk BT

Index	3
Operating manual	4-16
Important instructions	4-7
Dialog survey	8-16
Caption	17
Notes	18

Important instructions

Remote control functions

Volume control - turning up

VoiceDial key:

Volume control - turning down

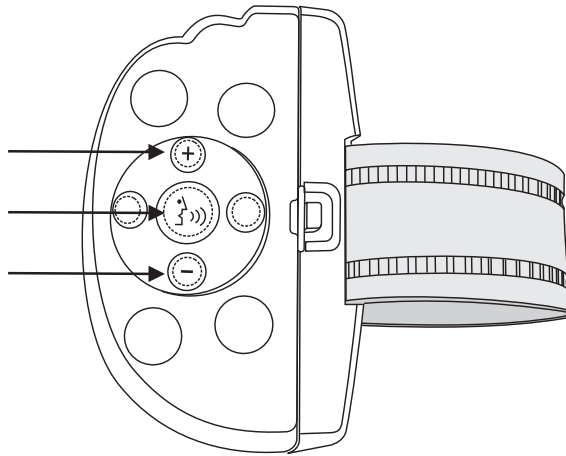

Plus key:

Press shortly: Volume control - louder

Press longer: Start to connect with the last connected mobile phone

VoiceDial key:

Press shortly: Start / stop the dialog, accept / terminate a call

Press longer: (status: phone connected) Voice Tags (choice of name) of the mobile phone can be called
(Status: phone not connected) modification of the profile in the hands-free set from hands-free(1 beep) to automatic (2 beeps)

Minus key:

Press shortly: Volume control - turning down volume

Press longer: Cancel to connect with the last connected mobile

Press shortly ≤ 3 seconds

Press longer ≥ 3 seconds

Caption

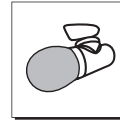

Microphone



Loudspeaker



Speaker-independent voice dialling



Speaker-dependent voice dialling of names in your phone book

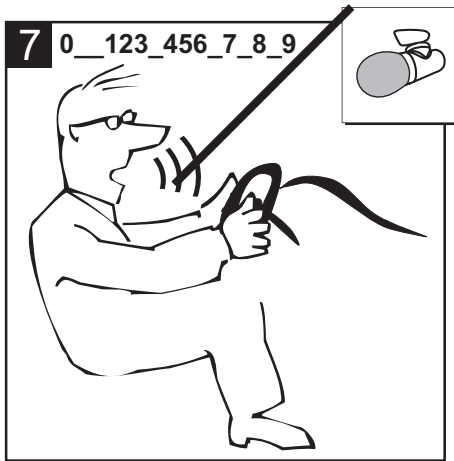
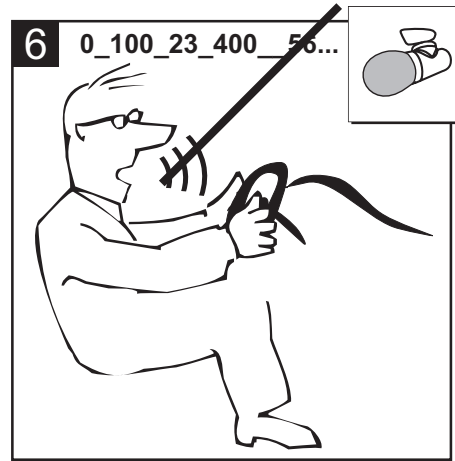

Connection of the remote control:

If you want to use another remote control with the hands-free set which was originally not included in the scope of delivery (e.g. a replacement remote control), you first of all have to connect it with the hands-free set. Please proceed as follows:

1. Remove batteries from the new remote control.
2. Interrupt the power supply of the hands-free set (e.g. turn the ignition off).
3. Now please press the VoiceDial key at the remote control and keep on pressing the key.
4. Reinsert the battery in the box of the remote control.
5. Now reestablish the power supply of the hands-free set.
6. If the remote control has been successfully connected, the hands-free set makes three beeps.

Status messages of the system

If the Bluetooth connection between the mobile phone and the hands-free set is not yet established and if you start the dialog by pressing the VoiceDial key shortly, you hear 2 beeps. If a Bluetooth connection is active you only hear 1 beep after pressing the key VoiceDial key. Certain functions and dialogs are only possible depending on the status of the hands-free set (Bluetooth connection active / not active).

Interconnection for the first time:

If you wish to establish a Bluetooth connection for the first time you must activate the Bluetooth function of your mobile phone and let it search for Bluetooth devices, in this case for a device labeled "VoiceTalk BT". If several devices were identified, please select the hands-free set and enter the PIN number 1234. The Bluetooth connection (interconnection) will then be established between your mobile phone and the hands-free set.

You will then be asked by the hands-free set to indicate a name for this connection, e.g. your name or the type of the mobile phone (see dialog overview). If you wish to use several telephones with the hands-free set, it makes sense to define a personal feature for distinction of the respective connections. The indicated name will then be stored in the register of devices of the hands-free set. When still no name is entered after three requests the hands-free set interrupts the input process. In this case no name will be stored, the mobile phone will however be connected.

The first interconnection of a mobile phone with the hands-free set is always only possible if you start with the mobile phone. An interconnection with the hands-free set is only feasible if no Bluetooth connection is already active. If you search for Bluetooth devices with your mobile phone and the hands-free set is already interconnected to another mobile phone the hands-free set will not be listed for you.

Please note that after a successful interconnection some mobile phones do not connect automatically with the hands-free set. The dialog "first-time interconnection" will then not be started by the hands-free set. You then have to establish the connection manually from your mobile phone. If the connection has not been established manually within 10 seconds, the hands-free set tries to establish it without storing the mobile phone in the list of devices. Please read the user manual of your mobile phone in case you find the procedure to be different from the usual procedure described in the previous paragraphs.

The dialog "first-time interconnection" does of course not apply to mobile phones already known and registered in the list of devices. In addition to the entry in the list of devices the settings for call and VoiceDial of the mobile phone are stored (separately for each mobile phone).

Please speak normally and clearly: Every digit of the telephone number must be spoken individually, but without interspersing the digits with artificial pauses. The system will work best, when the telephone number is spoken in blocks of three to five digits.

E.g.:

You enter the digit block by saying "Zero-one-nine-zero" and after a short pause the hands free car kit will repeat each digit and will then wait for you to speak the next digit or block of digits required for the telephone number. Should you enter the number by saying "Zero-one-ninety", the hands-free kit will not recognise this command.

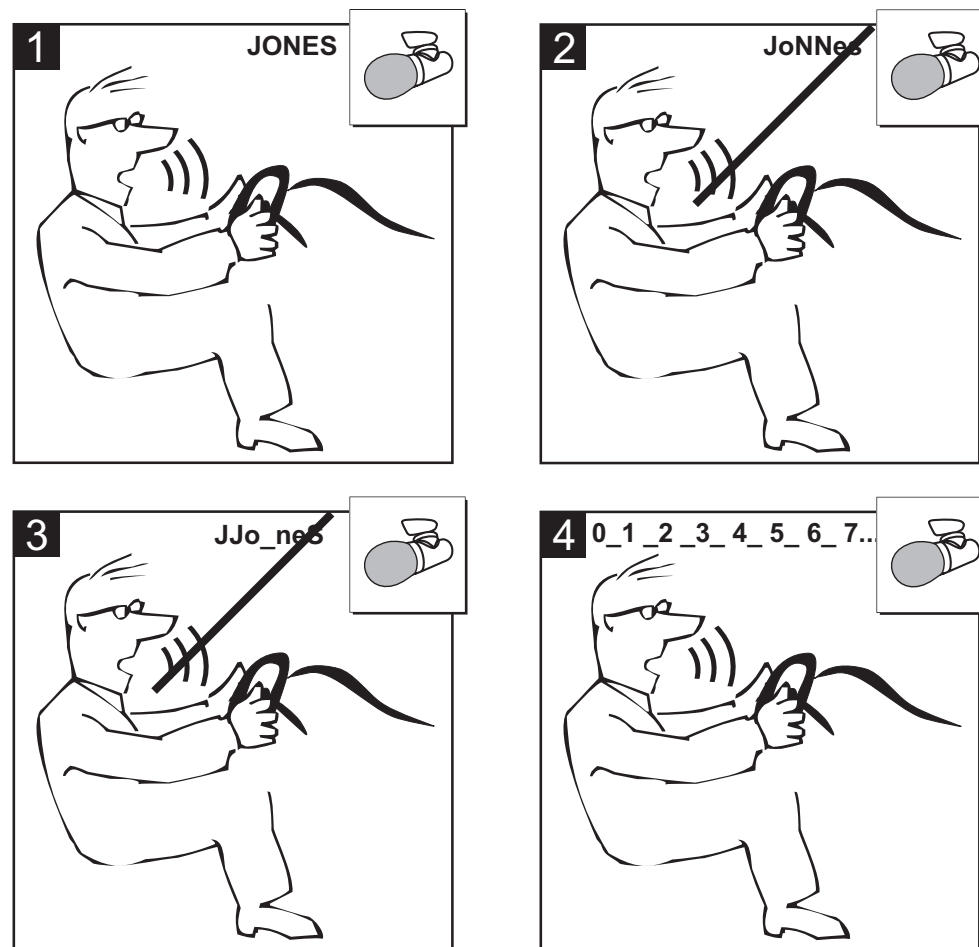

>> List names (list of entries from the directory)

- a) If the directory of the hands-free set is empty
 - << The directory is empty (END)**
- b) If entries are available in the directory of the hands-free set
 - << Name** (e. g. Jon Q. Public)
 - << ...**
 - << Name (END)**

>> Remove name (delete an entry from the directory)

- a) If the directory of the hands-free set is empty
 - << The directory is empty (END)**
- b) If entries are available in the directory of the hands-free set
 - << The name please** (e. g. John Q. Public)
 - >> Name**
 - << Name** (repetition of the name)
 - << Would you like to remove the name?**
 - a) If not
 - >> No (END)**
 - b) If yes
 - >> Yes**
 - << Are you sure?**
 - a) If not
 - >> No**
 - << Cancel (END)**
 - b) If yes
 - >> Yes**
 - << The name is being removed (END)**

>> Delete all names (delete all entries from the directory)

- a) If the directory of the hands-free set is empty
 - << The directory is empty (END)**
- b) If entries are available in the directory of the hands-free set
 - >> Do you like to remove all names?**
 - a) If not
 - >> No (END)**
 - b) If yes
 - >> Yes**
 - << Are you sure?**
 - a) If not
 - >> No**
 - << Cancel (END)**
 - b) If yes
 - >> Yes**
 - << Please wait. The phonebook is being removed (END)**

Interconnection with mobile phones already known:

If you have already stored an entry in the list of devices of the hands-free set you can also establish the Bluetooth connection with the remote control. For that purpose press the plus key longer than 3 seconds.

If the power supply of the hands-free set is interrupted and reestablished, the hands-free set independently tries to establish a Bluetooth connection with the mobile phone connected last.

Hands-free profile and headset:

Mobile phones with Bluetooth technology can be connected to other devices with the help of two types of profiles: the hands-free profile (also known as vehicle profile) and the headset profile (headphones). Depending on the mobile phone manufacturer, both or only one type of profile is supported by the respective type of mobile phone. The hands-free set searches for the most convenient profile.

However, it is not possible to add a mobile phone to the device list, if you use the headset profile. In the same way, you cannot call the mobile phone with the dialog "Connect". VoiceDial functions of the mobile phone to the hands-free set via the headset profile are also not possible. The mobile phone automatically accepts the incoming call and disconnects the connection to the hands-free set after the end of the call. During the connection in headset profile you can only accept or reject a call and adjust the volume. In order to switch to private mode (normal call via mobile phone) you can use the functions "Connect" and "Interrupt device".

If you do not yet have connected any mobile phone to the hands-free set, you can change the type of profile by pressing the VoiceDial key for a longer time. Here the settings hands-free (1 beep) or automatic (2 beeps) are possible. Please remember that the line quality can differentiate depending on the profile.

Dialog survey

The individual dialogs do not render the complete dialog text provided by the hands-free set, if the user once has not understood the input properly. The hands-free set then tries to get a new voice entry by the user or cancels the dialog. You can cancel the dialog anytime by pressing the VoiceDial key once more or enter the command "Cancel" (except you are memorizing a name at that moment).

>> = user speaks to hands-free set
<< = hands-free set speaks to user
(END) = end of dialog

>> = user speaks to hands-free set



<< = hands-free set speaks to user

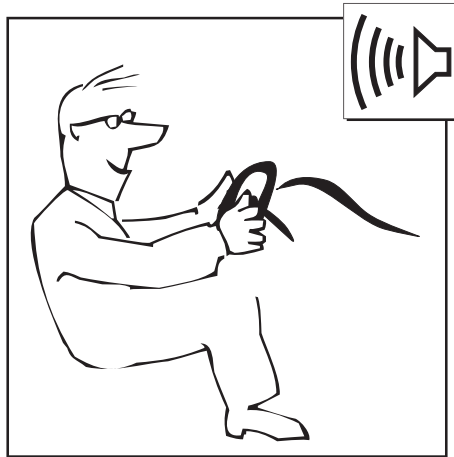

- c) Cancel the voice announcement
 - >> **Cancel**
 - << **Cancel (END)**
- d) Delete the complete number
 - >> **Delete all**
 - << **The number please**
- e) Delete a block backwards (e. g. for 111 222 333)
 - >> **Delete block**
 - << **Number 111 222**
 - Delete a block backwards (e. g. 012345)
 - >> **Delete block**
 - << **The Number please**

>> **Redial** (redialing of the phone number dialed last with the phone)
<< **The number is dialed (END)**

- >> **Store names** (store names and phone numbers of a contact max. 45)
 - a) If the directory of the hands-free set is full
 - << **The directory is full (END)**
 - b) If there is still storage space available in the directory of the hands-free set
 - << **The name please**
 - >> **Name** (e. g. John Q. Public)
 - << **Please repeat the name**
 - >> **Name** (John Q. Public)
 - a) If the name is already stored
 - << **The name is already stored**
 - b) If the name has not been stored yet
 - << **The number please**
 - >> **Number** (announcement of the complete phone number or announcement of blocks)
 - << **Number** (repetition of the phone number)
 - >> **Store**
 - << **The name "xyz" has been stored (END)**

- >> **Dial name** (call a stored entry from the directory)
 - a) If the directory of the hands-free set is empty
 - << **The directory is empty (END)**
 - b) If entries are available in the directory of the hands-free set
 - << **The name please**
 - >> **Name** (e. g. John Q. Public)
 - << **Name** (repetition of the name)
 - >> **Dial**
 - << **The number is dialed (END)**

In case of an active Bluetooth connection:

Disconnect device,
Dial number,
Redial,
Store name,
Dial name,
List names,
Remove name,
Delete all names

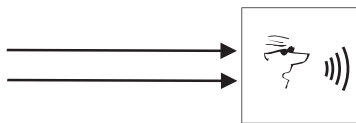

>> Disconnect device (connection to the connected mobile phone is interrupted)

<< Are you sure?

a) If yes

>> Yes

<< There is no device connected (END)

b) If not

>> No

<< Cancel (END)

>> Dial number (call establishment by entering the telephone number)

<< The number please

>> Number (e. g. 0049... it is recommended to enter number blocks)

<< Number

a) If the number has been understood correctly

>> Dial

<< The number is dialed (END)

b) If the number has not been understood correctly (e. g. 1048)

a) Correction of the phone number from the start

>> Delete first

<< Number (repetition of the complete number)

A digit can only be added to the number already entered, it cannot be attached ahead. Therefore, sometimes it could be more sensible to enter the complete number once more, if you detect mistakes in long number blocks.

...

b) Correction of the phone number backwards

>> Delete last

<< Number (repetition of the complete phone number, e. g. 104)

>> Number (e. g. 9)

<< Number (repetition of the complete phone number, e. g. 1049)

>> Dial

<< The number is dialed (END)

In case of inactive Bluetooth connection:

First connection of mobile phone (no initial dialog by user),

Connect,

Connect devices,

Delete device,

Remove all devices,

Status of device

The first connection with the hands-free set from your mobile phone is established.

<< The device name please

a) if you enter a name / description

>> Name (e. g. John Q. Public)

<< Please repeat the name

>> Name (e. g. John Q. Public)

<< The device "xyz" has been stored

b) if you do not enter a name / description

break of ~13 seconds

<< The device name please

break of ~13 seconds

<< The device name please

break of ~13 seconds

<< Cancel (END)

>> Connect (try to connect to the last connected mobile phone)

<< The device is being connected, please wait

a) If the connection of the device was successful

<< The device "xyz" is connected (END)

b) If the connection of the device was not successful

<< No device has been connected (END)

c) If the last connected mobile phone has connected by headset profile

<< Function not possible

>> Connect devices (try to connect to a mobile phone of the device list)

- a) If the device list is empty
 - << The device list is empty (END)**
- b) If the device list does only contain one entry
 - << The device 1 "xyz" (END)**
- c) If the device list contains entries
 - << The device 1 "xyz"**
 - << ...**
 - << ...**
 - << The device 4 "xyz"**
 - << The number (from the list) please!**
 - >> Number** (e. g. 1)
 - << Number**
 - a) If you have specified a number which has not been stored
 - << Function not possible, the number please**
 - b) If you have specified a number which is stored
 - >> Connect**
 - << The device "xyz" is connected, please wait**
 - a) If the connection of the device was successful
 - << The device "xyz" is connected (END)**
 - b) If the connection of the device has not been successful
 - << No device is connected (END)**

>> Delete devices (deletes an entry from the device list)

- a) If the device list is empty
 - << The device list is empty (END)**
- b) If the device list contains entries
 - << Do you want to remove the device?**
 - a) If not
 - >> No**
 - << Cancel (END)**
 - b) If yes
 - >> Yes**
 - << The device 1 "xyz"**
 - << ...**
 - << ...**
 - << The device 4 "xyz"**
 - << The number (from the list) please!**
 - >> Number** (e. g. 1)
 - << Number**
 - a) If you have specified a number which has not been stored
 - << Function not possible, the number please**
 - b) If you have specified a number which is stored
 - >> Delete**
 - << The device "xyz" has been removed (END)**

>> Remove all devices (deletes all entries from the device list)

- a) If the device list is empty
 - << The device list is empty (END)**
- b) If the device list contains entries
 - << Do you want to delete the device list?**
 - b) If yes
 - >> No**
 - << Cancel (END)**
 - b) If yes
 - >> Yes**
 - << Are you sure?**
 - a) If not
 - >> No**
 - << Cancel (END)**
 - b) If yes
 - >> Yes**
 - << The device list is empty. (END)**

In case of inactive or active Bluetooth connection:

Status device,
Play devices

>> Status device (indicates the current status of the Bluetooth connection)

- a) If no Bluetooth connection is available
 - << No device has been connected (END)**
- b) Bluetooth connection active and the device is stored in the device list
 - << The device "xyz" is connected (END)**
- c) Bluetooth connection active but the device is not stored in the device list (is possible, if no name has been entered during the initial connection)
 - << The device is connected (END)**

>> Play devices (specifies all entries from the device list)

- a) If the device list is empty
 - << The device list is empty (END)**
- b) If the device list contains entries
 - << The device 1 "xyz"**
 - << ...**
 - << ...**
 - << The device 4 "xyz" (END)**