



# MODEL BFT-44 DUAL CHANNEL SENSOR TRANSMITTER



Warning: Read & understand contents of this manual prior to operation. Failure to do so could result in serious injury or death.

**Buckeye Detection Systems**

110 Kings Road

Kings Mountain, NC 28086

1-800-438-1028

[www.buckeyefire.com](http://www.buckeyefire.com)



- Chapter 1 Safety Information ..... 1**
  - 1.1 Safety Information – Read Before Installation and Applying Power..... 1
  - 1.2 Contacting Buckeye Detection Systems ..... 1
- Chapter 2 General Description ..... 2**
  - 2.1 Introduction..... 2
  - 2.2 Ratings and Certifications ..... 2
  - 2.3 System Design Specifications ..... 2
- Chapter 3 Installation Instructions ..... 4**
  - 3.1 Sensor Location ..... 4
  - 3.2 Mounting the Enclosure ..... 4
  - 3.3 3-Wire 4-20 mA Mode Installation ..... 6
  - 3.4 BFT10-0388 Relay / RS-485 Modbus Option Installation ..... 7
  - 3.5 Sensor Installation ..... 9
- Chapter 4 General Operating Instructions ..... 11**
  - 4.1 Introduction..... 11
  - 4.2 Routine Sensor Calibration..... 11
  - 4.3 Alarm Outputs ..... 13
    - 4.3.1 Relay 1/2/3..... 14
      - 4.3.1.1 Alarm 1/2/3/FAULT..... 14
      - 4.3.1.2 Acknowledge..... 14
      - 4.3.1.3 Failsafe ..... 14
      - 4.3.1.4 Override ..... 14
  - 4.4 Channel Settings ..... 15
    - 4.4.1 Channel 1/2..... 15
      - 4.4.1.1 Alarm 1/2/3..... 15
        - 4.4.1.1.1 Setpoint..... 16
        - 4.4.1.1.2 Latching..... 16
        - 4.4.1.1.3 Trip On ..... 16
        - 4.4.1.1.4 On Delay(sec) ..... 16
        - 4.4.1.1.5 Off Delay(min)..... 16
        - 4.4.1.1.6 DeadBand %..... 16



4.4.1.1.7 Color..... 17

4.4.1.2 Fault Alarm..... 17

    4.4.1.2.1 Setpoint..... 17

4.4.1.3 Data From..... 17

    4.4.1.3.1 EC Sensor ..... 17

    4.4.1.3.2 Bridge Sensor ..... 20

    4.4.1.3.3 AI 4-20mA ..... 23

    4.4.1.3.4 Modbus 16bit..... 24

    4.4.1.3.5 Modbus 16 Signed ..... 25

    4.4.1.3.6 Modbus 32bit..... 27

4.4.1.4 Temp. Comp..... 28

4.4.1.5 Configure..... 29

    4.4.1.5.1 Measurement Name ..... 29

    4.4.1.5.2 E.Unit..... 29

    4.4.1.5.3 Zero ..... 29

    4.4.1.5.4 Span ..... 29

    4.4.1.5.5 Decimal Points ..... 29

    4.4.1.5.6 Channel On?..... 29

    4.4.1.5.7 Deadband (%)..... 29

    4.4.1.5.8 InCal mA..... 29

    4.4.1.5.9 Backup/Restore..... 30

4.4.1.6 Calibrate..... 30

**4.5 Comm Settings..... 31**

4.5.1 COM1/COM2 Settings..... 32

    4.5.1.1 BaudRate..... 32

    4.5.1.2 Parity ..... 32

    4.5.1.3 Timeout (ms)..... 32

    4.5.1.4 Poll Dly (ms) ..... 32

    4.5.1.5 Byte Order..... 33

    4.5.1.6 Enable LEDs..... 33

    4.5.1.6 Slave ID..... 33

4.5.2 Modbus TCP ..... 33

    4.5.2.1 Slave Byte Order..... 33



4.5.2.2	master Timeout (ms).....	33
4.5.2.3	master Poll Dly (ms).....	34
4.5.2.4	Enable LEDs.....	34
4.5.3	Network Settings.....	34
4.5.3.1	DHCP Enabled.....	34
4.5.3.2	Hostname.....	34
4.5.3.3	IP Address.....	34
4.5.3.4	Netmask.....	35
4.5.3.5	Gateway.....	35
<b>4.6</b>	<b>Security.....</b>	<b>35</b>
<b>4.7</b>	<b>System.....</b>	<b>36</b>
4.7.1	Version.....	37
4.7.2	Configure.....	37
4.7.2.1	Unit Name.....	37
4.7.2.2	Date.....	37
4.7.2.3	Time.....	37
4.7.2.4	Warmup (m).....	38
4.7.2.5	Cal PURGE (m).....	38
4.7.2.6	Block Neg.....	38
4.7.2.7	Send SensrLife.....	38
4.7.2.8	Alm REFRESH (m).....	38
4.7.3	Digital Input.....	39
4.7.4	View Event Log.....	39
4.7.5	Clear Event Log.....	40
4.7.6	View Sensor Life.....	40
<b>4.8</b>	<b>Diagnostics.....</b>	<b>41</b>
4.8.1	Relays.....	42
4.8.2	Analog Inputs.....	42
4.8.3	Analog Outputs.....	43
4.8.4	LED Test.....	43
4.8.5	Serial Ports.....	44
4.8.6	ADC Readings.....	44
	<b>Chapter 5 Modbus.....</b>	<b>45</b>



<b>5.1</b>	<b>Modbus TCP.....</b>	<b>45</b>
<b>5.2</b>	<b>Modbus Slave Writes .....</b>	<b>45</b>
<b>5.3</b>	<b>Modbus Slave Register Location.....</b>	<b>45</b>
	<b>Chapter 6 Special Features .....</b>	<b>53</b>
<b>6.1</b>	<b>Webpage .....</b>	<b>53</b>
6.1.1	Status Screen.....	54
6.1.2	Event Log Screen .....	55
6.1.3	Configure.....	56
6.1.3.1	Relay Config.....	56
6.1.3.2	Channel Config .....	57
6.1.3.3	System Config.....	58
6.1.3.4	Config Transfer .....	58
<b>6.2</b>	<b>Network connection .....</b>	<b>58</b>
6.2.1	Direct connection with crossover cable or hub/switch .....	58
6.2.2	Connecting the BFT-44 to an Existing LAN .....	60
6.2.3	Connecting the BFT-44 to an Isolated Network.....	61
6.2.4	Static IP Configuration .....	62
6.2.4.1	BFT-44 static ip configuration .....	62
6.2.4.2	Windows xp static ip configuration .....	62
6.2.4.3	Dyanmic ip configuration .....	65
6.2.5	Testing Connections.....	66
<b>6.3</b>	<b>Relay Option Board BFT10-0388.....</b>	<b>67</b>
6.3.1	RS-485 Modbus Communications Ports .....	67
6.3.2	Programmable Relays .....	68
6.3.3	Fault Relay.....	69
6.3.4	Digital Input.....	69
<b>6.4</b>	<b>Remote Sensor Option Board BFT10-2080.....</b>	<b>69</b>



## Chapter 1 Safety Information

### 1.1 SAFETY INFORMATION – READ BEFORE INSTALLATION AND APPLYING POWER

The following symbols are used in this manual to alert the user of important instrument operating issues:



This symbol is intended to alert the user to the presence of important operating and maintenance (servicing) instructions.



This symbol is intended to alert the user to the presence of dangerous voltage within the instrument enclosure that may be sufficient magnitude to constitute a risk of electric shock.

#### **WARNINGS:**

- **Shock Hazard** - Disconnect or turn off power before servicing this instrument.
- **WARNING- EXPLOSION HAZARD-** DO NOT REPLACE FUSE UNLESS POWER HAS BEEN SWITCHED OFF OR THE AREA IS KNOWN TO BE NON-HAZARDOUS.
- **WARNING- EXPLOSION HAZARD-** DO NOT DISCONNECT EQUIPMENT UNLESS POWER HAS BEEN SWITCHED OFF OR THE AREA IS KNOWN TO BE NON-HAZARDOUS.
- Use a properly rated CERTIFIED AC power (mains) cable installed as per local or national codes
- A certified AC power (mains) disconnect or circuit breaker should be mounted near the controller and installed following applicable local and national codes. If a switch is used instead of a circuit breaker, a properly rate CERTIFIED fuse or current limiter is required to be installed as per local or national codes. Markings for positions of the switch or breaker should state (I) for on and (O) for off.
- Clean only with a damp cloth without solvents.
- Equipment not used as prescribed within this manual may impair overall safety.

### 1.2 CONTACTING BUCKEYE DETECTION SYSTEMS

Buckeye Detection Systems  
110 Kings Road  
Kings Mountain, NC 28086  
1-800-438-1028  
[bfec@buckeyef.com](mailto:bfec@buckeyef.com)



## Chapter 2 General Description

### 2.1 INTRODUCTION

The state-of-the art BFT-44 sensor transmitter is an updated version of our proven BFT-48 transmitter. This versatile unit has a bright color display and embedded web page promoting simple intuitive user interface. The web page is accessed through the standard Ethernet connection and allows the transmission of data over existing network infrastructure to computers, tablets, smart phones and Buckeye Detection Systems BFT-64, 64 channel controller.

#### **Features include:**

- QVGA color TFT display which displays engineering units and monitored data graphically as a bar graph and 30-minute trend.
- Display changes color to indicate alarm status
- Ethernet: embedded webpage for configuration and HMI, Modbus TCP master/slave
- Webpage offers offsite viewing capabilities.
- Remote sensor abilities
- Single/Dual modes standard
- Modbus TCP, Modbus RTU, EC, bridge and 4-20mA inputs
- Magnetic switches allow "one man" sensor calibration in hazardous areas without area declassification with a simple magnetic wand.

#### **Optional features include:**

- Three programmable relays and a dedicated fault relay.
- Two individually programmable RS-485 ports for Modbus master or slave.

### 2.2 RATINGS AND CERTIFICATIONS

#### **NRTL CSA APPROVALS (File # 219995)**

BFT-44 with BFT10-0247 is Division 1 and 2 Group A, B, C, D Exia. Suitable for explosion proof installations

#### **EXPLOSION PROOF HOUSING**

Instrument enclosure suitable for Class 1, Division 1 and 2, Groups A, B, C and D

#### **POLYCARBONATE ENCLOSURE**

Instrument enclosure suitable for Class 1, Division 2, Groups A, B, C and D (Pending)

### 2.3 SYSTEM DESIGN SPECIFICATIONS

#### **ANALOG OUTPUTS**

BFT-44 Bridge models have 3-wire 4-20mA current source output with nominal 24VDC power supply

BFT10-0388 Relays / RS-485 Modbus® (Optional)

Relays are Form C 5AMP @ 30VDC and 240VAC RESISTIVE

RS-485 is 2-wire Modbus® RTU



**DISPLAY**

240X320 pixel LCD displays 30-minute trend, bar-graph and large engineering units, LED Backlight

**ACCURACY**

±1% of full scale

**AMBIENT TEMPERATURE RANGE**

-40 – 60 degrees C

**TEMPERATURE DRIFT**

Less than .1% per degree Celsius over ambient temperature range

**POWER SUPPLY**

10 - 30 VDC at 10 Watts max





## Chapter 3 Installation Instructions

### 3.1 SENSOR LOCATION

Factors such as air movement, gas density in relation to air, emission sources and environmental variables affect correct sensor location. Air movement by fans, prevailing winds and convection should be carefully evaluated to determine if a leak is more likely to raise gas levels in certain areas within the facility. Vapor density of a gas determines if it will rise or fall in air when there are no significant currents. Lighter than air gases should have the monitors mounted 12 – 18 inches (30 – 45 centimeters) above the potential gas leak and heavier than air gases should be this distance below. Even though the BFT-44 is designed for rugged service, sensors should be protected from environmental damage from water, snow, shock, vibration and dirt.

### 3.2 MOUNTING THE ENCLOSURE

The BFT-44 standard enclosure is a cast aluminum explosion-proof (NEMA 7) enclosure as shown in Figure 3-1. Figure 3-2 shows dimensions with the dual local sensor head 'Y' adaptor (BFT0010-1200) included. Figure 3-3 shows the dimensions, without the sensor head installed, of the BFT-44's polycarbonate enclosure.

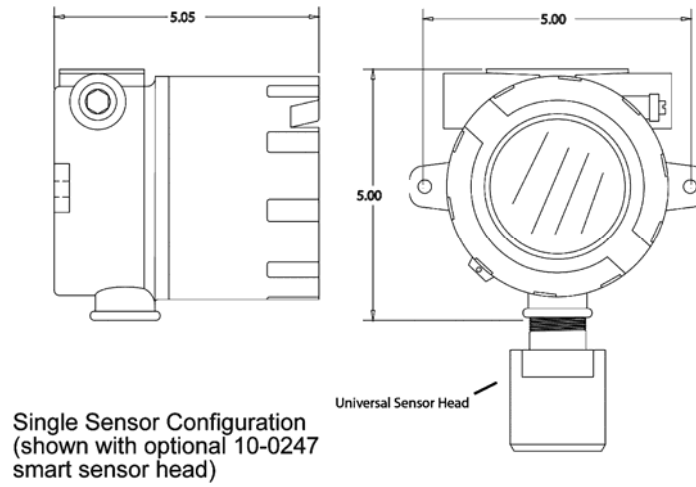

Figure 3-1 BFT-44 Explosion-Proof Housing

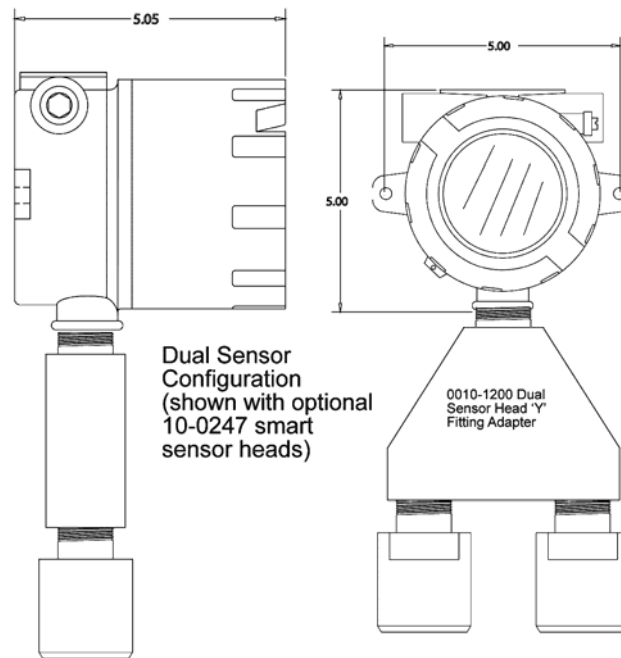

Figure 3-2 BFT-44 Explosion-Proof Housing with Dual Sensor Head Adaptor

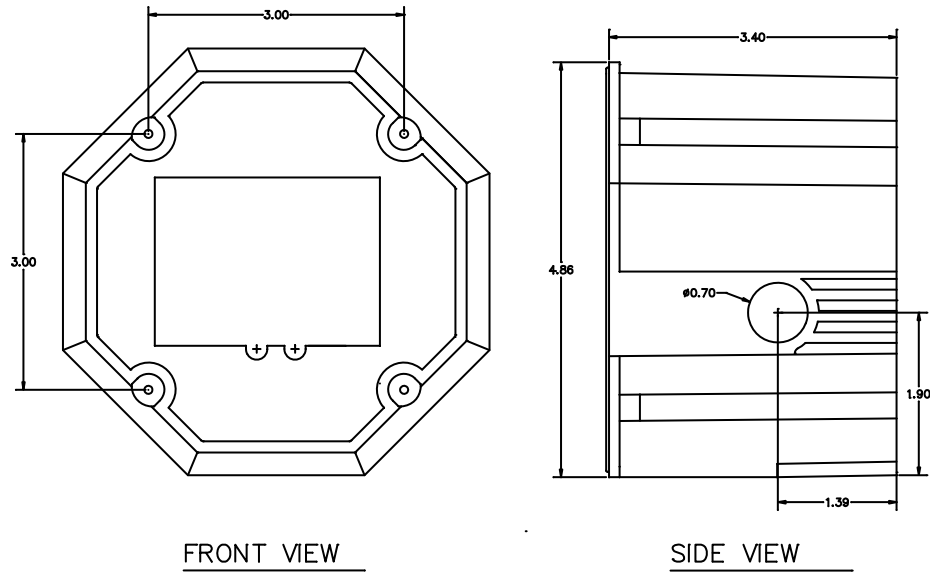

Figure 3-3 BFT-44 Poly Enclosure without Sensor Head

Modular design simplifies the installation of the BFT-44. A top Display Assembly is mounted with captive thumbscrews and is easily removed to access field-wiring terminals. An optional BFT10-0388 Alarm/RS-485 Modbus board mounts *piggyback* to the back of the Display Assembly. Wiring from simple bridge sensors terminates at the TB2 of the BFT10-0390 I/O PCB. The bottom BFT10-0390 I/O Power Supply board generates voltages needed for LCD, relays, RS-485 Modbus, Bridge and Electrochemical Smart Sensor Connections and Simple Bridge sensor.



**WARNING:** Qualified personnel should perform the installation according to applicable electrical codes, regulations and safety standards. Ensure correct cabling and sealing fitting practices are implemented. Do not aim the sensor pointing upward. Install the BFT-44 to a wall or bracket using the predrilled mounting flanges with I.D. 0.25 on 5 inch centers (Figure 3-2). If conduit is rigid and able to support the weight of the BFT-44, the mounting bolts may be omitted.



**CAUTION:** The sensor head should never be installed pointing upwards.

### 3.3 3-WIRE 4-20 MA MODE INSTALLATION

TB2 provides inputs for Channel 1 and Channel 2. By default it is set to provide a Simple Bridge input for Channel 1 and a 4-20mA input for Channel 2. However, a slight board modification will switch Channel 1 from a Simple Bridge input to a 4-20mA input. To switch Channel 1 to a 4-20mA input SB1 and SB2 must have their left pad and center pad connection cut and the center and right pad soldered together. This will provide 24V power to the first (leftmost) terminal of TB2 and a 4-20mA input at the terminal second from the left (Figure 3-4). J4 provides a connection for EC Smart Sensors for Channel 2 inputs. J5 provides a connection for Bridge or EC



Smart Sensors for Channel 1 inputs. J3 provides an Ethernet connection for connecting the BFT-44 to a network. TB1 provides terminals for 24V power input and common. Along with 4-20mA outputs for both Channel 1 and Channel 2.

**Instructions:** Remove the cover on the BFT-44. Loosen the two thumbscrews holding the display assembly in place and remove it. A 14-pin ribbon cable is attached with sufficient length to allow access to the I/O PCB mounted in the bottom of the enclosure (Figure 3-3). Power and signal connection are to TB1 where 24VDC, Signal and Common wires must be connected. A blocking diode protects the BFT-44 if polarity of the power supply is reversed, but it will not operate. Reassemble the BFT-44. Follow the procedures and recommendations in the receiver and power supply manuals to complete the installation. Be sure the BFT-44 enclosure and conduit are properly grounded. Apply power, and the BFT-44 should function.

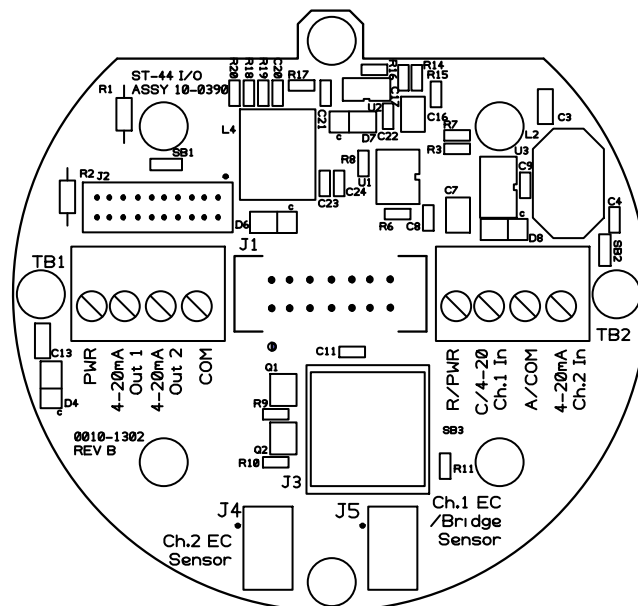

Figure 3-4 BFT10-0390 BFT-44 I/O Power Supply Board

### 3.4 B10-0388 RELAY / RS-485 MODBUS OPTION INSTALLATION

The optional BFT10-0388 Relay/RS-485 Modbus Option Board supplies three programmable alarm relays, a FAULT relay and two RS-485 Modbus RTU master/slave ports (Figure 3-5). This board is "piggybacked" behind the BFT10-0387 BFT-44 CPU/Display Board.



**Caution:** Alarm relays have dry contacts and power must be supplied from an external source. If this power source exceeds 3 amps, users should consider fusing relay wiring with 3 amp fuses. Contacts are rated for RESISTIVE loads! Inductive loads, such as contactor coils or motors, may cause contact arcing. This will shorten life and emit RFI into the sensor signals. Use appropriate arcing snubber and MOVs across inductive loads, and keep wiring away from signal wires. External wiring to TB2 should be shielded and protected from noise spikes to prevent false alarm resets or overrides.

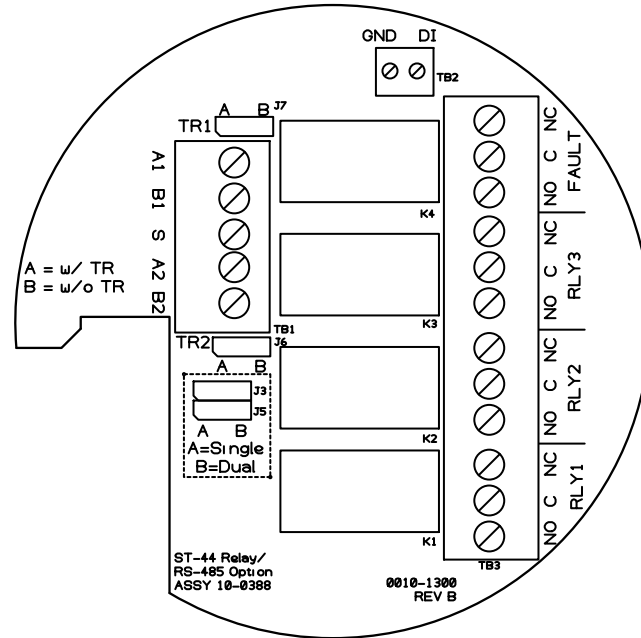
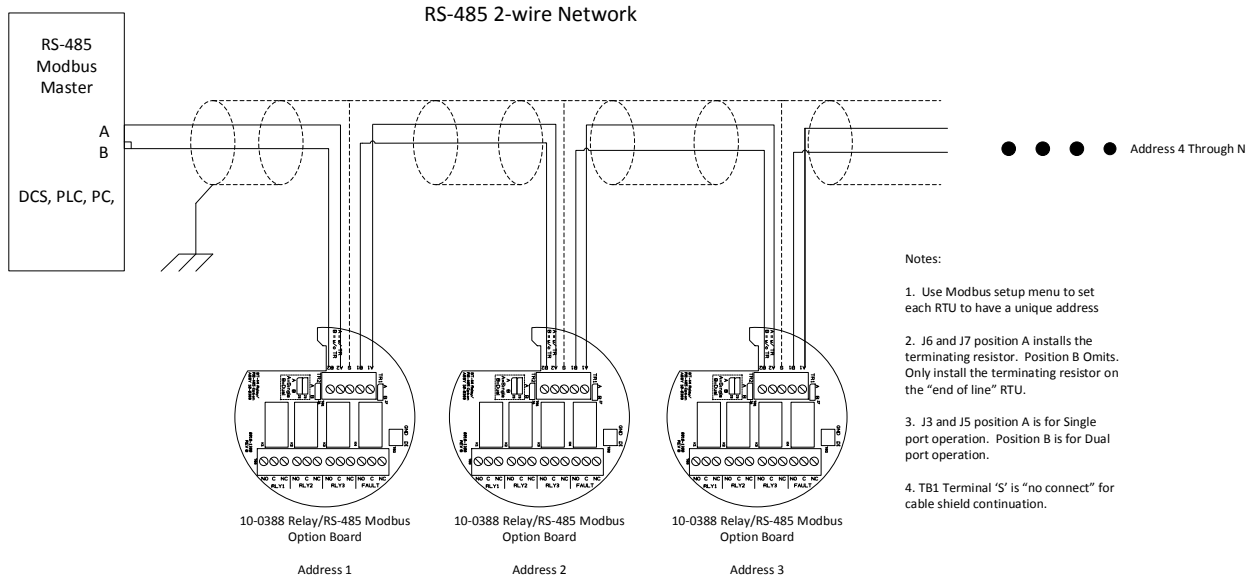

Figure 3-5 BFT10-0388 Relay/RS-485 Option Board

Remove the cover of the BFT-44 enclosure. Loosen the two thumbscrews holding the display assembly in place and remove it. A 14-pin ribbon cable is attached with sufficient length to access the back of the Display assembly where the Alarm/RS-485 Modbus board option is located. It is possible to use only the relays, only RS-485 or both. Relay terminals are labeled NO (Normally Open), NC (Normally Closed) or C (Common, or pole). These designators correspond to the shelf, or de-energized, state of the relays. The FAULT relay is always failsafe. Meaning, it is energized when there is not a fault condition, and therefore its action is reverse of the designators.

RS-485 Modbus networks should be wired as shown in Figure 3-6. Each BFT-44 represents an RTU, and must have a unique Remote ID address. Remote ID addresses are assigned in the Data From Menu discussed in [Section 4.4.1.3](#). Cabling must be a daisy chain as opposed to a star pattern for reliable operation. The "end of line" unit should have J6 and J7 installed in the A position.

With J3 and J5 in the A position, TB1 functions as a Single communication port with A1 tied to A2 and B1 tied to B2. With J3 and J5 in the B position, TB1 functions as a Dual communication port with A1 and B1 being port 1 and A2 and B2 being port 2.



*Figure 3-6 RS-485 Modbus Wiring*

### 3.5 SENSOR INSTALLATION

Many manufacturers offer industry standard electrochemical (EC) and catalytic bead sensors for toxic/oxygen and LEL combustible gas detection. These are referred to as simple sensors in this manual. The BFT-44 design accommodates users wishing to continue use of their existing catalytic bead Simple type of sensors, however, EC Simple sensors are not supported. The BFT-44 Smart Sensor interface also uses proven EC technology for toxic/oxygen and catalytic bead for LEL combustibles, but has taken this technology a step further. A tiny memory IC is incorporated into the BFT-44 factory supplied Smart Sensors allowing them to contain the entire database of BFT-44 parameters onboard the replaceable Smart Sensor assembly.

This unique Smart Sensor Interface may be used to configure Smart Sensors and/or BFT-44s from a PC rather than entering all variables via the magnetic key pad.

EC and catalytic bead smart sensors both plug into the BFT10-0247 Smart Sensor Head, which connects to the BFT-44 with its 8-conductor Smart Sensor Interface cable (Figure 3-7).

**Note:** BFT10-0247 Smart Sensor Heads with EC/Oxygen sensors may connect to J4 or J5 on the BFT10-0309 I/O Board. Bridge Smart sensors can only be connected to J5.

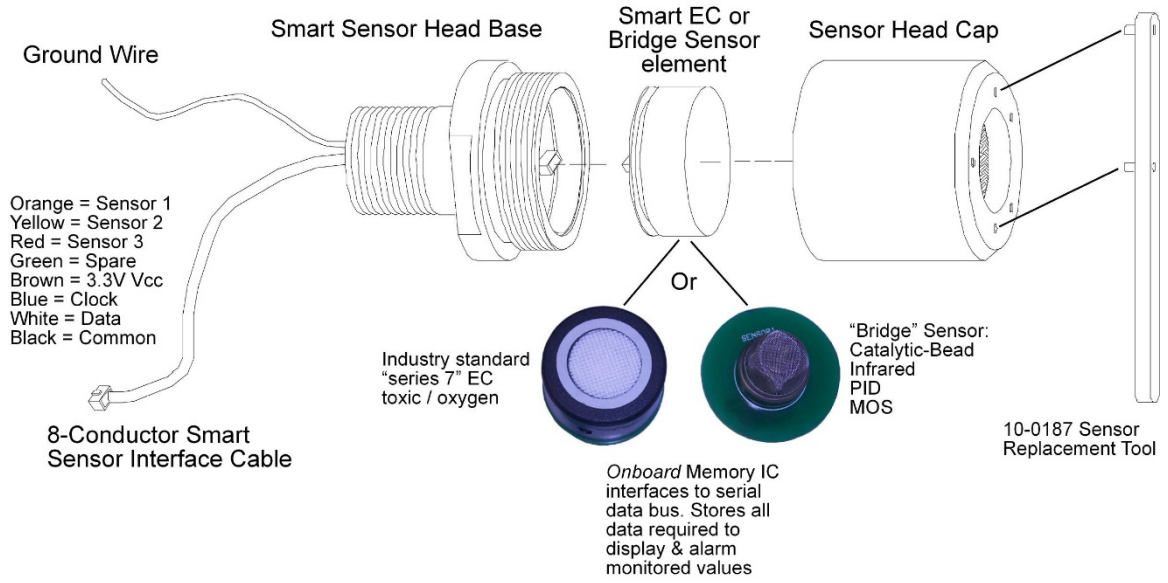

Figure 3-7 BFT10-0247 Smart Sensor Head Assembly



## Chapter 4 General Operating Instructions

### 4.1 INTRODUCTION

Swiping a magnetic wand past the Edit key, from any of the Data Display screens, displays the Main Menu. The Up and Down keys maneuver the selection marker up and down, and Edit selects the highlighted item to enter the sub menus. All items with a submenu are indicated by a right facing arrow at the end of the line. To edit menu item values swipe the Edit key, and use the Up/Down keys to edit the value. Once the desired value is entered, swipe the Edit key again to save the value. Swipe the Next key to reverse out of a submenu.

### 4.2 ROUTINE SENSOR CALIBRATION

Calibration is the most important function for ensuring correct operation of the BFT-44. The CAL MODE is designed to make calibration quick, easy and error free. A successful Zero and Span calibration requires only four keystrokes. The 4-20mA output indicates Cal Mode by transmitting the InCal mA as set in [Section 4.4.1.5.8](#) (default of 3mA). It then transmits 4mA during the subsequent Cal Purge Delay as set in [Section 4.7.2.5](#) to prevent external alarms during calibration. Local BFT-44 alarm relays (optional BFT10-0388 BFT-44 Relay/RS-485 Board) are inhibited during Cal Mode. Cal Mode is exited automatically if no keystrokes are detected after five minutes.

Follow these BFT-44 calibration guidelines:

1. Calibration accuracy is only as good as the calibration **gas** accuracy. Buckeye Detection Systems recommends calibration gases with National Institute of Standards and Technology (NIST) traceable accuracy to increase the validity of the calibration.
2. Do not use gas cylinders beyond their expiration date.
3. Calibrate a new sensor before it is put in use.
4. Allow the sensor to stabilize before starting calibration.
5. Calibrate on a regular schedule. Buckeye Detection Systems recommends once every 3 months, depending on use and sensor exposure to poisons and contaminants.
6. Calibrate only in a clean atmosphere, free of background gas.



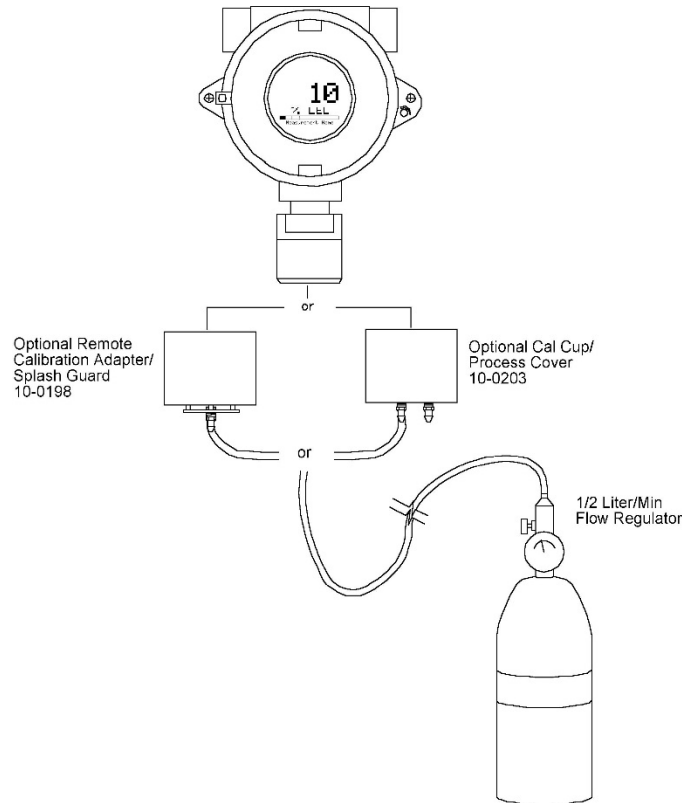

Figure 4-1 Calibration Gas Input

Use the following step-by-step procedure to perform Zero and Span calibrations (Figure 4-2 may be used for reference to the Menus.):

**Note:** The first three steps must be performed before the timer in the bottom right corner expires, 15 seconds, otherwise the BFT-44 will exit back to the Data Display Screen.

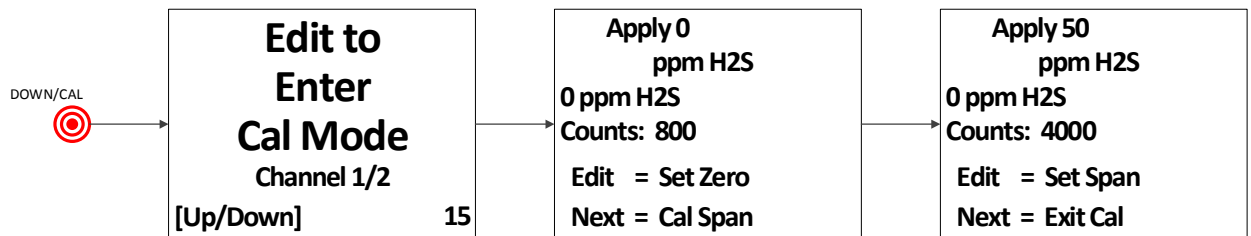

Figure 4-2 Cal Mode Flowchart and Menus

1. Enter Cal mode from any of the Data Display Screens by swiping the DOWN/CAL key.
2. Swipe the Up and/or Down key to select the Channel to be calibrated. **Note:** Only channels with Local Cal enabled, per [Section 4.4.1.3](#), will be available for calibration.
3. Swipe the EDIT key to enter Cal Mode.



4. Apply a clean Zero Gas (Figure 4-1), using the Cal Cup, part number BFT10-0203, or be sure there is no background target gas in the monitored area. After the reading is stable (approximately one minute), swipe the EDIT key to Set the Zero Calibration. To skip the Zero calibration and go to the Span calibration swipe the NEXT key. When a message that the Zero calibration was completed successfully, proceed to the next step.
5. Apply the correct, as indicated, Span gas (Figure 4-1) at 0.5 liters/min. After the reading is stable (approximately one minute), swipe the EDIT key to Set the Span Calibration. To skip the Span Calibration swipe the NEXT key. When a message that the Span calibration was completed successfully, the ST-44 will exit back to the Data Display Screen.
6. Remove the Cal Gas. Once the Cal Purge Delay ([Section 4.7.2.5](#)) has expired, normal alarm and relay functionality will be restored.

Calibration history records are logged, and may be viewed in the Sensor Information ([Section 4.4.1.3](#)).

### 4.3 ALARM OUTPUTS

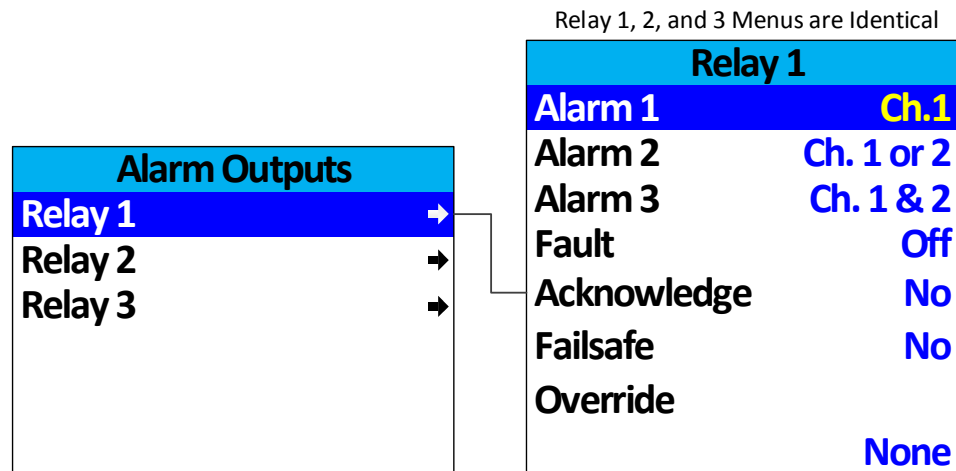

Figure 4-3 Alarm Outputs Menu Tree

The Alarm Outputs Menu is accessed via the Main Menu, and is used to configure the mapping of the three programmable relays to the alarm setpoints, and relay configuration items such as Acknowledge, Failsafe and Override.

The BFT10-0388 Relay/RS 485 Option Board has three programmable relays and a fourth relay which is dedicated to the Fault alarm.



**Note:** While these settings only affect relays if the BFT10-0388 BFT-44 Relay/RS 485 Option Board is installed, the menu options are always available for configuration purposes, regardless as to whether the option board is installed or not.



### 4.3.1 RELAY 1/2/3

Relay 1, 2, and 3 Menus are Identical

Relay 1	
Alarm 1	Ch.1
Alarm 2	Ch. 1 or 2
Alarm 3	Ch. 1 & 2
Fault	Off
Acknowledge	No
Failsafe	No
Override	None

Figure 4-4 Relay Menu

From this menu, you may select one of the three programmable relays for which you would like to change the settings or mapping.

#### 4.3.1.1 ALARM 1/2/3/FAULT

The Alarm 1, Alarm 2, Alarm 3 and Fault menu items determine the mapping of the relay to each of these alarm setpoints. The selection for each of these four items must all be met simultaneously to activate the relay. Options for each of these items are: Off, Ch.1, Ch.2, Ch.1 & 2, Ch.1 or 2.



**Example:** If you are in the Relay 1 menu, and have the following settings Alarm 1 set to Ch.1, Alarm 2 set to Ch.1 & 2 and Alarm 3 set to Ch.1 or 2. Relay 1 will energize in the event that the Alarm 1 setpoint for Channel 1 is reached **AND** The Alarm 2 setpoint for BOTH Channel 1 and Channel 2 are reached **AND** the setpoint for Alarm 3 is reached for either Channel 1 or Channel 2.

#### 4.3.1.2 ACKNOWLEDGE

Set to Yes means the UP/RESET key will set the relay to the normal state even if the alarm condition still exists. This is useful for silencing an audible device driven from the relay.

#### 4.3.1.3 FAILSAFE

Set to Yes means the relay de-energizes during alarm and energizes with no alarm. This is useful for signaling an alarm on a loss of power. The dedicated Fault alarm is always Failsafe.

#### 4.3.1.4 OVERRIDE

Override allows the user to have an OR type of condition for energizing/de-energizing a relay. The options are:

1. None
2. Ch1 Alarm 1



3. Ch1 Alarm 2
4. Ch1 Alarm 3
5. Ch1 Fault
6. Ch2 Alarm 1
7. Ch2 Alarm 2
8. Ch2 Alarm 3
9. Ch2 Fault
10. Ch1/2 Cal Zero
11. Ch1 Cal Span
12. Ch2 Cal Span
13. 1/2 Cal Zero/Span

An Override is necessary when you want the relay to trip when either of two different setpoints are reached. For Example, if you want Relay 1 to trip when channel 1 is in Alarm 1 or Fault, you can set the **Alarm 1** setting for Ch1 and set **Override** to Ch1 Fault.

## 4.4 CHANNEL SETTINGS

The Channel Settings Menu is accessed via the Main Menu.

### 4.4.1 CHANNEL 1/2

The Channel 1 and Channel 2 Menus are accessed via the Channel Settings Menu.

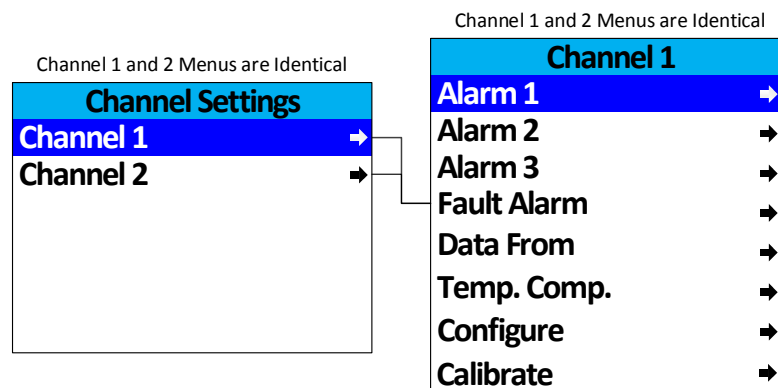

Figure 4-5 Channel 1/2 Menu Tree

#### 4.4.1.1 ALARM 1/2/3

Alarm 1, 2 and 3 Menus may be accessed from the Channel 1 and Channel 2 Menus. Alarm 1 is always enabled and has **Setpoint, Latching, Trip On, On Delay, Off Delay** and **Dead Band** settings. Alarm 2 has the same setting options as Alarm 1, but also adds the **Color** setting. Alarm 3 is the same as Alarm 2, but may be **Enabled** or **Disabled**.

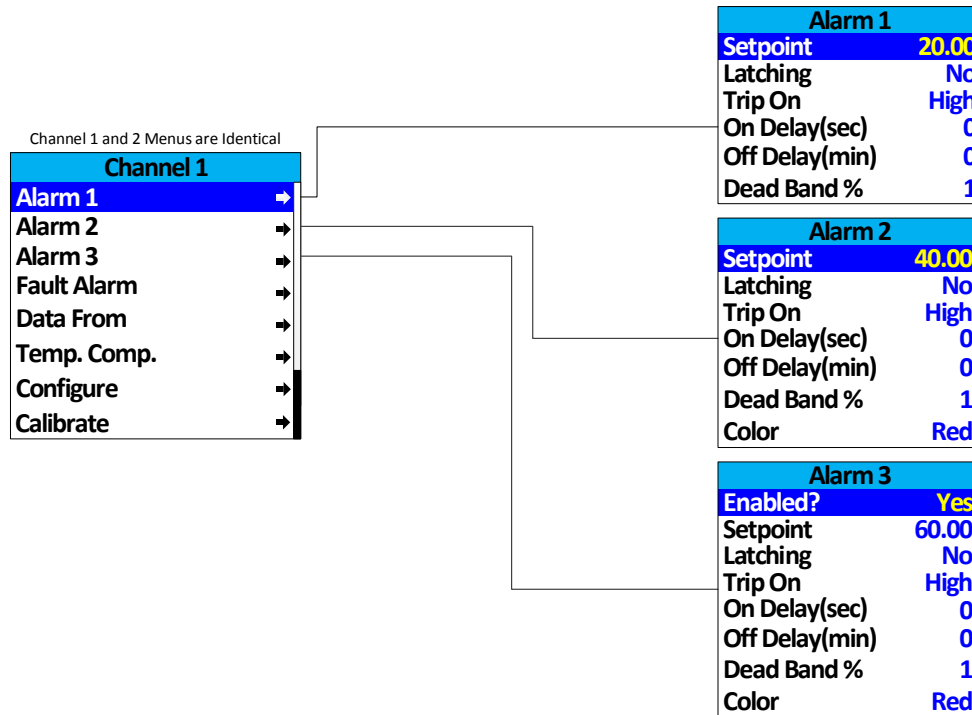

Figure 4-6 Alarm 1/2/3 Menu Tree

4.4.1.1.1 SETPOINT

**Setpoint** enters the engineering unit value where the alarm will trip. It may be negative and trip when monitored values fall out of range in this direction.

4.4.1.1.2 LATCHING

Setting **Latching** to YES causes the alarm to remain active even after the condition is gone, and to reset only when the UP/RESET key is swiped from a data display.

4.4.1.1.3 TRIP ON

Set **Trip On** to HIGH to have the alarm trip when the value goes above the setpoint. Set to LOW to trip when the value falls below the setpoint.

4.4.1.1.4 ON DELAY(SEC)

**On Delay** allows entering a maximum 10 second delay before this alarm becomes active. This is useful for preventing spurious alarms by brief spikes beyond the alarm setpoint.

4.4.1.1.5 OFF DELAY(MIN)

**Off Delay** allows entering a maximum 120 minute delay before clearing an alarm after the alarm condition is gone. This is useful for continuing an alarm function, such as operation of an exhaust fan, for a period of time after the alarm condition clears.

4.4.1.1.6 DEADBAND %

**Deadband** allows forcing low values to continue to read zero. This is useful when there are small amounts of background gases that cause fluctuating readouts above zero. The highest amount of Deadband allowed is 5%. **Note:** Deadband affects **all** outputs as well as the local reading.



#### 4.4.1.1.7 COLOR

Selecting **Color** changes the color associated with the particular alarm. Options are Red, Blue and Orange. **Note:** Alarm 1 is always set to Yellow.

#### 4.4.1.2 FAULT ALARM

The **Fault Alarm** is always enabled, and is accessed via the Channel 1 and Channel 2 menus.

##### 4.4.1.2.1 SETPOINT

**Fault Alarm** has a default setting of negative 10 with Low Trip set for YES. This makes it function as a FAULT alarm and trip when the monitored value falls to less than negative 10. It is important to adjust this value when the transmitter's span value is set for another value other than 100. For example, a typical span setting for monitoring oxygen level is 25 therefore the fault level value should be adjusted to -2.5 which is equal to negative 10% of full scale.

#### 4.4.1.3 DATA FROM

##### 4.4.1.3.1 EC SENSOR

Data From	
EC Sensor	
Remote Sensor	No
Min Raw	800
Max Raw	4000
Filter (second)	20
Polarity	NEG
PGA Gain	→
Heater Enabled	No
Heat(degC)	25.00
Local Cal	Yes

Figure 4-7 Data from EC Sensor Menu

##### 4.4.1.3.1.1 Remote Sensor

Enable **Remote Sensor** when using the optional Remote Sensor Board BFT10-2080, see [Section 5.4](#).

When enabled, two additional menu items appear for Remote ID and Interface. Remote ID matches the Remote ID of the Remote Sensor Board and is set between 1 and 247. Interface indicates which of the two COM ports are being used for that channel.

**Note:** In order to use the BFT10-2080 Remote Sensor Board, the BFT-44 must have a BFT10-0388 Relay/ RS-485 Option board installed.

##### 4.4.1.3.1.2 Min Raw

**Min Raw** defines the minimum range of input counts that provide Measurement Range read-out values. This menu entry is determined by the A/D converter resolution of the channel's input. For example, if the input is 0 at 800 then Min Raw should be set to 800.



If the input device's resolution is unknown, the live counts variable on the Analog inputs menu displays actual raw A/D counts currently being read by this channel. This reading may be used to test the input device for what A/D counts are provided for zero. Forcing the input device to read zero should provide the A/D counts value needed to make this channel's display also read zero.

#### 4.4.1.3.1.3 *Max Raw*

**Max Raw** defines the maximum range of input counts that provide Measurement Range read-out values. This menu entry is determined by the A/D converter resolution of the channel's input. For example, if the input is 100% at 4000 then Max Raw should be set to 4000.

If the input device's resolution is unknown, the live counts variable on the Analog inputs menu displays actual raw A/D counts currently being read by this channel. This reading may be used to test the input device for what A/D counts are provided for 100%. Forcing the input device to read 100% should provide the A/D counts value needed to make this channel's display also read 100%.

#### 4.4.1.3.1.4 *Filter (second)*

The **Filter** setting sets the number of seconds over which samples are averaged. This may be set from 0 to 60 seconds. If a channel has a noisy input the time may be increased to filter out some of the noise by averaging it over a longer period of time. This causes the reading to react slower to a change in input.

#### 4.4.1.3.1.5 *Polarity*

**Polarity** sets the polarity of the sensor POS for positive and NEG for negative.

#### 4.4.1.3.1.6 *PGA Gain*

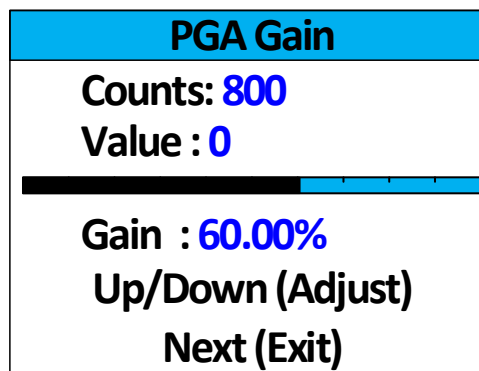

Figure 4-8 PGA Gain Menu

Depending upon the input type, BFT-44 inputs range from a few micro amps to hundreds of micro amps. **PGA Gain** is the adjustment that matches the input signal range to the BFT-44 input signal conditioning circuits. Altering the PGA Gain setting automatically resets previous calibration Offset and Gain values to Unit.

If it is determined the PGA Gain value is incorrect, apply the desired up-scale input and use the UP/DOWN keys to obtain the correct Value. Counts are the binary A/D value.



**Caution:** For standard installations, this is a factory adjustment. Do not use the PGA Gain menu for calibrating sensors. It should only be adjusted if a new measurement gas or input range is required.

#### 4.4.1.3.1.7 Heater Enabled

**Heater Enabled** enables the locally mounted heater/ temperature controller circuit on the EC Sensor Amplifier Series 7 board BFT10-0415 and the Series 4 board BFT10-0381. **Note:** This feature should only be used in low temperature environments.

#### 4.4.1.3.1.8 Heat (degC)

The **Heat** setting indicates the minimum temperature at which the temperature controller circuit will energize the heater if enabled. It may be set from -25 to 25C. **Note:** The Heater function should only be enabled in low temperature environments.

#### 4.4.1.3.1.9 Local cal

**Local Cal** allows the sensor to be calibrated locally from the BFT-44. To configure the Calibration Settings refer to [Section 4.4.1.6](#). For information on how to perform sensor calibration refer to [Section 4.2](#).

#### 4.4.1.3.1.10 View Sensor Info

Ch.1/2 Sensor	
Type:	ppm H2S
Zero:	0
Span:	100
SN:	XXXXXXXXXXXXXX
Born on:	12/12/12
Last cal:	12/12/12

Figure 4-9 Sensor Information Screen

**Sensor Info** includes the sensor's Type, Zero and Span values, Serial Number, Born on Date and the Date when the last Calibration was performed.





## 4.4.1.3.2 BRIDGE SENSOR

Data From	
Bridge Sensor	
Remote Sensor	No
Min Raw	800
Max Raw	4000
Filter (second)	20
PGA Gain	→
Bridge Volts	→
Balance	→
Local cal	Yes

Figure 4-10 Data from Bridge Sensor Menu

## 4.4.1.3.2.1 Remote Sensor

Enable **Remote Sensor** when using the optional Remote Sensor Board BFT10-2080, see [Section 5.4](#).

When enabled, two additional menu items appear for Remote ID and Interface. Remote ID matches the Remote ID of the Remote Sensor Board and is set between 1 and 247. Interface indicates which of the two COM ports are being used for that channel.

**Note:** In order to use the BFT10-2080 Remote Sensor Board, the BFT-44 must have a BFT10-0388 Relay/ RS-485 Option board installed.

## 4.4.1.3.2.2 Min Raw

**Min Raw** defines the minimum range of input counts that provide Measurement Range read-out values. This menu entry is determined by the A/D converter resolution of the channel's input. For example, if the input is 0 at 800 then Min Raw should be set to 800.

If the input device's resolution is unknown, the live counts variable on the Analog inputs menu displays actual raw A/D counts currently being read by this channel. This reading may be used to test the input device for what A/D counts are provided for zero. Forcing the input device to read zero should provide the A/D counts value needed to make this channel's display also read zero.

## 4.4.1.3.2.3 Max Raw

**Max Raw** defines the maximum range of input counts that provide Measurement Range read-out values. This menu entry is determined by the A/D converter resolution of the channel's input. For example, if the input is 100% at 4000 then Max Raw should be set to 4000.

If the input device's resolution is unknown, the live counts variable on the Analog inputs menu displays actual raw A/D counts currently being read by this channel. This reading may be used to test the input device for what A/D counts are provided for 100%. Forcing the input device to read 100% should provide the A/D counts value needed to make this channel's display also read 100%.



#### 4.4.1.3.2.4 Filter (second)

The **Filter** setting sets the number of seconds over which samples are averaged. This may be set from 0 to 60 seconds. If a channel has a noisy input the time may be increased to filter out some of the noise by averaging it over a longer period of time. This causes the reading to react slower to a change in input.

#### 4.4.1.3.2.5 PGA Gain

Depending upon the input type, BFT-44 inputs range from a few micro amps to hundreds of micro amps. **PGA Gain** is the adjustment that matches the input signal range to the BFT-44 input signal conditioning circuits. Altering the PGA Gain setting automatically resets previous calibration Offset and Gain values to Unit.

If it is determined the PGA Gain value is incorrect, apply the desired up-scale input and use the UP/DOWN keys to obtain the correct Value. Counts are the binary A/D value.



**Caution:** For standard installations, this is a factory adjustment. Do not use the PGA Gain menu for calibrating sensors. It should only be adjusted if a new measurement gas or input range is required.

#### 4.4.1.3.2.6 Bridge Volts

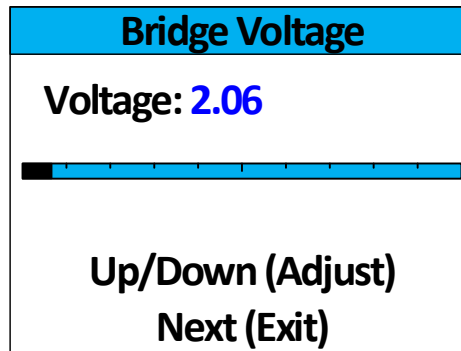

Figure 4-11 Bridge Voltage Adjust Menu

The **Bridge Voltage** is factory configured, and only requires field adjustment if the catalytic bead sensor is mounted remotely from the BFT-44 or if a new sensor is installed. BFT-44 bridge sensors may be from 2 to 6 volts excitation voltage at the sensor. This means, if the sensor is mounted a long distance away, the voltage at the BFT-44 may have to be higher in order to compensate for losses in the field wiring. Be careful not to exceed correct sensor voltage at the sensor's A and R terminals.



4.4.1.3.2.7 Balance

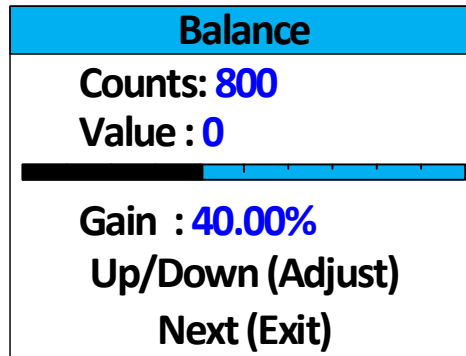

Figure 4-12 Bridge Balance Adjust Menu

The **Bridge Balance** is factory configured, and only requires field adjustment if the catalytic bead sensor is mounted remotely from the BFT-44 or if a new sensor is installed. Balance allows adjusting the balance of the catalytic bead sensor, and must only be performed with ZERO gas on the sensor. Balance is similar to a very coarse ZERO calibration, and does not need to be precise, since subsequent calibrations will correct for small errors. ZERO gas applied to the sensor should provide a reading of -3 to +3 on the Value in the Balance Menu.

4.4.1.3.2.8 Local Cal

**Local Cal** allows the sensor to be calibrated locally from the BFT-44. To configure the Calibration Settings refer to [Section 4.4.1.6](#). For information on how to perform sensor calibration refer to [Section 4.2](#).

4.4.1.3.2.9 View Sensor Info

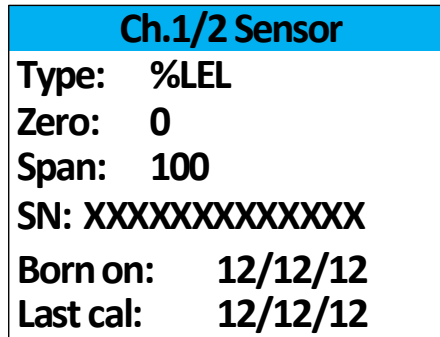

Figure 4-13 Sensor Information Screen

**Sensor Info** includes the sensor's Type, Zero and Span values, Serial Number, Born on Date and the Date when the last Calibration was performed.



## 4.4.1.3.3 AI 4-20MA

Data From	
AI 4-20mA	
Min Raw	800
Max Raw	4000
Filter (second)	5
Local Cal	Yes
Marker Menu	→

Figure 4-14 Data from Analog Input 4-20mA Menu

4.4.1.3.3.1 *Min Raw*

**Min Raw** defines the minimum range of input counts that provide Measurement Range read-out values. This menu entry is determined by the A/D converter resolution of the channel's input. For example, if the input is 0 at 800 then Min Raw should be set to 800.

If the input device's resolution is unknown, the live counts variable on the Analog inputs menu displays actual raw A/D counts currently being read by this channel. This reading may be used to test the input device for what A/D counts are provided for zero. Forcing the input device to read zero should provide the A/D counts value needed to make this channel's display also read zero.

4.4.1.3.3.2 *Max Raw*

**Max Raw** defines the maximum range of input counts that provide Measurement Range read-out values. This menu entry is determined by the A/D converter resolution of the channel's input. For example, if the input is 100% at 4000 then Max Raw should be set to 4000.

If the input device's resolution is unknown, the live counts variable on the Analog inputs menu displays actual raw A/D counts currently being read by this channel. This reading may be used to test the input device for what A/D counts are provided for 100%. Forcing the input device to read 100% should provide the A/D counts value needed to make this channel's display also read 100%.

4.4.1.3.3.3 *Filter (second)*

The **Filter** setting sets the number of seconds over which samples are averaged. This may be set from 0 to 60 seconds. If a channel has a noisy input the time may be increased to filter out some of the noise by averaging it over a longer period of time. This causes the reading to react slower to a change in input.

4.4.1.3.3.4 *Local Cal*

When enabled, this allows the sensor to be calibrated locally from the BFT-44. To configure the Calibration settings refer to [Section 4.4.1.6](#). For information on how to perform sensor calibration refer to [Section 4.2](#).



4.4.1.3.3.5 Marker Menu

Marker Menu	
Marker Enabled	No
Marker %	-15.63
Mark as	IN CAL
Sensor Life	NO

Figure 4-15 Marker Menu

Some monitors indicate special modes of operation such as Calibration or Maintenance by transmitting a special <4mA "Marker" value. The BFT-44 offers a 4-20mA **Marker Menu** for detecting inputs between -20% and 0% that represent such events. Once detected, the BFT-44 transmits a constant mA output equal to the Marker value.



**Caution:** Since FAULT alarms are also tripped in the < 4mA region it is important to understand that the Marker events override the FAULT alarm.

Selecting Yes in the *Marker Enabled* field activates the Marker. *Marker %* allows entering a value from -20% to 0% with up to three decimal points. *Mark as* allows entry of the up to six digit ASCII message the readout will display when the marker is detected.

4.4.1.3.4 MODBUS 16BIT

Data From	
Modbus 16bit	
Min Raw	800
Max Raw	4000
Remote ID	1
Alias	31001
Interface	COM1
Local cal	Yes

Figure 4-16 Data from Modbus 16-bit Menu

For additional information on Modbus slave configuration refer to [Chapter 5](#).

4.4.1.3.4.1 Min Raw

**Min Raw** defines the minimum range of input counts that provide Measurement Range read-out values. This menu entry is determined by the A/D converter resolution of the channel's input. For example, if the input is 0 at 800 then Min Raw should be set to 800.

If the input device's resolution is unknown, the live counts variable on the Analog inputs menu displays actual raw A/D counts currently being read by this channel. This reading may be used



to test the input device for what A/D counts are provided for zero. Forcing the input device to read zero should provide the A/D counts value needed to make this channel's display also read zero.

#### 4.4.1.3.4.2 *Max Raw*

**Max Raw** defines the maximum range of input counts that provide Measurement Range read-out values. This menu entry is determined by the A/D converter resolution of the channel's input. For example, if the input is 100% at 4000 then Max Raw should be set to 4000.

If the input device's resolution is unknown, the live counts variable on the Analog inputs menu displays actual raw A/D counts currently being read by this channel. This reading may be used to test the input device for what A/D counts are provided for 100%. Forcing the input device to read 100% should provide the A/D counts value needed to make this channel's display also read 100%.

#### 4.4.1.3.4.3 *Remote ID*

Each device on a Modbus network must have a unique Remote ID. When Data From is set to Modbus, **Remote ID** is where the slave's unique ID number is entered. Remote ID numbers up to 247 are valid.

#### 4.4.1.3.4.4 *Alias*

The **Alias** register numbers define the location of the variable representing the input value of the Modbus data received through the Communications ports. This number must be obtained from the manufacturer of the Modbus RTU device.

#### 4.4.1.3.4.5 *Interface*

The **Interface** assigns what communication port the Modbus slave is connected to and the channel will get its data from. The communication port that is assigned here must be configured as a Modbus Master.

#### 4.4.1.3.4.6 *Local Cal*

**Local Cal** allows the sensor to be calibrated locally from the BFT-44. To configure the Calibration Settings refer to [Section 4.4.1.6](#). For information on how to perform sensor calibration refer to [Section 4.2](#).

#### 4.4.1.3.5 MODBUS 16 SIGNED

Data From	
Modbus 16 Signed	
Min Raw	800
Max Raw	4000
Remote ID	1
Alias	31001
Interface	COM1
Local cal	Yes

Figure 4-17 Data from Modbus 16-bit Signed Menu

For additional information on Modbus slave configuration refer to [Chapter 5](#).



#### 4.4.1.3.5.1 *Min Raw*

**Min Raw** defines the minimum range of input counts that provide Measurement Range read-out values. This menu entry is determined by the A/D converter resolution of the channel's input. For example, if the input is 0 at 800 then Min Raw should be set to 800.

If the input device's resolution is unknown, the live counts variable on the Analog inputs menu displays actual raw A/D counts currently being read by this channel. This reading may be used to test the input device for what A/D counts are provided for zero. Forcing the input device to read zero should provide the A/D counts value needed to make this channel's display also read zero.

#### 4.4.1.3.5.2 *Max Raw*

**Max Raw** defines the maximum range of input counts that provide Measurement Range read-out values. This menu entry is determined by the A/D converter resolution of the channel's input. For example, if the input is 100% at 4000 then Max Raw should be set to 4000.

If the input device's resolution is unknown, the live counts variable on the Analog inputs menu displays actual raw A/D counts currently being read by this channel. This reading may be used to test the input device for what A/D counts are provided for 100%. Forcing the input device to read 100% should provide the A/D counts value needed to make this channel's display also read 100%.

#### 4.4.1.3.5.3 *Remote ID*

Each device on a Modbus network must have a unique Remote ID. When Data From is set to Modbus, **Remote ID** is where the slave's unique ID number is entered. Remote ID numbers up to 247 are valid.

#### 4.4.1.3.5.4 *Alias*

The **Alias** register numbers define the location of the variable representing the input value of the Modbus data received through the Communications ports. This number must be obtained from the manufacturer of the Modbus RTU device.

#### 4.4.1.3.5.5 *Interface*

The **Interface** assigns what communication port the Modbus slave is connected to and the channel will get its data from. The communication port that is assigned here must be configured as a Modbus Master.

#### 4.4.1.3.5.6 *Local Cal*

**Local Cal** allows the sensor to be calibrated locally from the BFT-44. To configure the Calibration Settings refer to [Section 4.4.1.6](#). For information on how to perform sensor calibration refer to [Section 4.2](#).



## 4.4.1.3.6 MODBUS 32BIT

Data From	
Modbus 32bit	
Remote ID	1
Alias	31001
Interface	COM1
Byte Order	BADC
Local cal	Yes

Figure 4-18 Data from Modbus 32-bit Menu

For additional information on Modbus slave configuration refer to [Chapter 5](#).

## 4.4.1.3.6.1 Remote ID

Each device on a Modbus network must have a unique Remote ID. When Data From is set to Modbus, **Remote ID** is where the slave's unique ID number is entered. Remote ID numbers up to 247 are valid.

## 4.4.1.3.6.2 Alias

The **Alias** register numbers define the location of the variable representing the input value of the Modbus data received through the Communications ports. This number must be obtained from the manufacturer of the Modbus RTU device.

## 4.4.1.3.6.3 Interface

The **Interface** assigns what communication port the Modbus slave is connected to and the channel will get its data from. The communication port that is assigned here must be configured as a Modbus Master.

## 4.4.1.3.6.4 Byte Order

**Byte Order** determines WORD and BYTE alignment of data at the remote Modbus transmitter when sending its 4 byte IEEE Floating Point values. With the selection bar on this entry, swipe the Edit key to toggle between the four possible modes. The default setting is BADC.

## 4.4.1.3.6.5 Local Cal

**Local Cal** allows the sensor to be calibrated locally from the BFT-44. To configure the Calibration Settings refer to [Section 4.4.1.6](#). For information on how to perform sensor calibration refer to [Section 4.2](#).





4.4.1.4 TEMP. COMP.

Temp. Comp.		
Temp	Gain	Offset
-40	1.00	+0.00
-30	1.00	+0.00
-20	1.00	+0.00
-10	1.00	+0.00
0	1.00	+0.00
10	1.00	+0.00
20	1.00	+0.00
30	1.00	+0.00
40	1.00	+0.00
50	1.00	+0.00
60	1.00	+0.00

Figure 4-19 Temperature Compensation Menu

**Temperature Compensation** allows the user to adjust the gain and offset that is applied to sensors to compensate for temperature drift. Factory supplied sensors are preprogrammed with these values which are automatically uploaded to the BFT-44 from the smart sensor. The default values are 1.000 for gain and 0.000 for offset. With these default values entered, there is no extra gain or offset applied to the sensor. This menu is not accessible unless a smart sensor, which is equipped with the temperature sensor, is installed. From this menu, you can adjust the gain and offset applied to the sensor at 10C increments from -40 to 60C. The gain is applied to the span value, and the offset is adjusted to make the sensor read zero at different temperatures.



#### 4.4.1.5 CONFIGURE

Configure	
Measurement Name	
E.Unit	PCTLEL
Zero	0.00
Span	100.00
Decimal Points	0
Channel On?	Yes
Deadband (%)	1.00
InCal mA	3.00
Backup/Restore	➔

Figure 4-20 Channel Configuration Menu

##### 4.4.1.5.1 MEASUREMENT NAME

**Measurement Name** may be edited to contain virtually any 16 character ASCII field. It is typically used to describe the monitored point by user tag number or other familiar terminology.

##### 4.4.1.5.2 E.UNIT

**Engineering Units (EUNIT)** may have up to a 10 character ASCII field. Many common gases have preconfigured EUNITs based upon the sensor type, and each may be edited in this menu.

##### 4.4.1.5.3 ZERO

**Zero** defines the reading to be displayed when 4mA (0%) is the BFT-44 output.

##### 4.4.1.5.4 SPAN

**Span** defines the reading to be displayed when 20mA (100%) is the BFT-44 output. The highest reading allowed is 9999 and include a polarity sign and a decimal point.

##### 4.4.1.5.5 DECIMAL POINTS

**Decimal Points** sets the resolution of the displayed reading and may be set to zero, one or two decimal points.

##### 4.4.1.5.6 CHANNEL ON?

**Channel ON** determines whether or not the channel is active and being used.

##### 4.4.1.5.7 DEADBAND (%)

**Deadband** allows forcing low values to continue to read zero. This is useful when there are small amounts of background gases that cause fluctuating readouts above zero. The highest amount of Deadband allowed is 5%. **Note:** Deadband affects **all** outputs as well as the local reading.

##### 4.4.1.5.8 INCAL MA

**InCal mA** determines the output when the channel is in Calibration mode. It may be set from 0 to 20mA. This signal may be used by the controller to determine that the unit is in calibration.



4.4.1.5.9 BACKUP/RESTORE

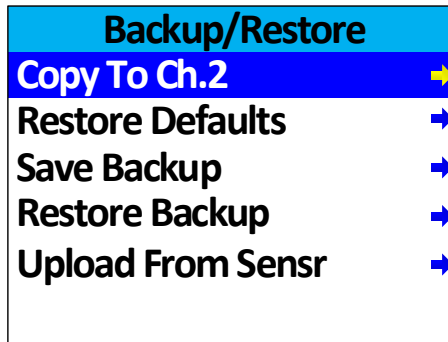

Figure 4-21 Configuration Backup/Restore Menu

The **Backup/Restore Menu** allows you to perform many operations dealing with the configuration of the BFT-44. Selecting *Copy To Ch.1/Ch.2* will copy the current channel's configuration to the other channel. *Restore Defaults* sets all configuration data back to factory defaults. *Save Backup* saves a copy of the configuration to non-volatile memory for restoration at a later time. *Restore Backup* will restore the configuration to the last saved Backup. *Upload From Sensr* will upload the sensor configuration data to the BFT-44.

4.4.1.6 CALIBRATE

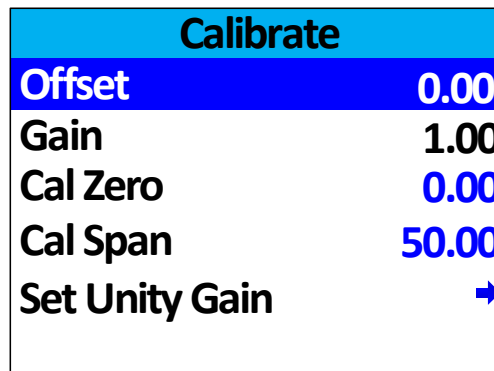

Figure 4-22 Channel Calibration Menu

The **Calibrate Menu** shows the settings for calibration. It will display any Offset or Gain currently applied, and allows you to enter the values for the zero and span gases that will be used during calibration. You may also reset the gain back to unity by selecting *Set Unity Gain*.



## 4.5 COMM SETTINGS

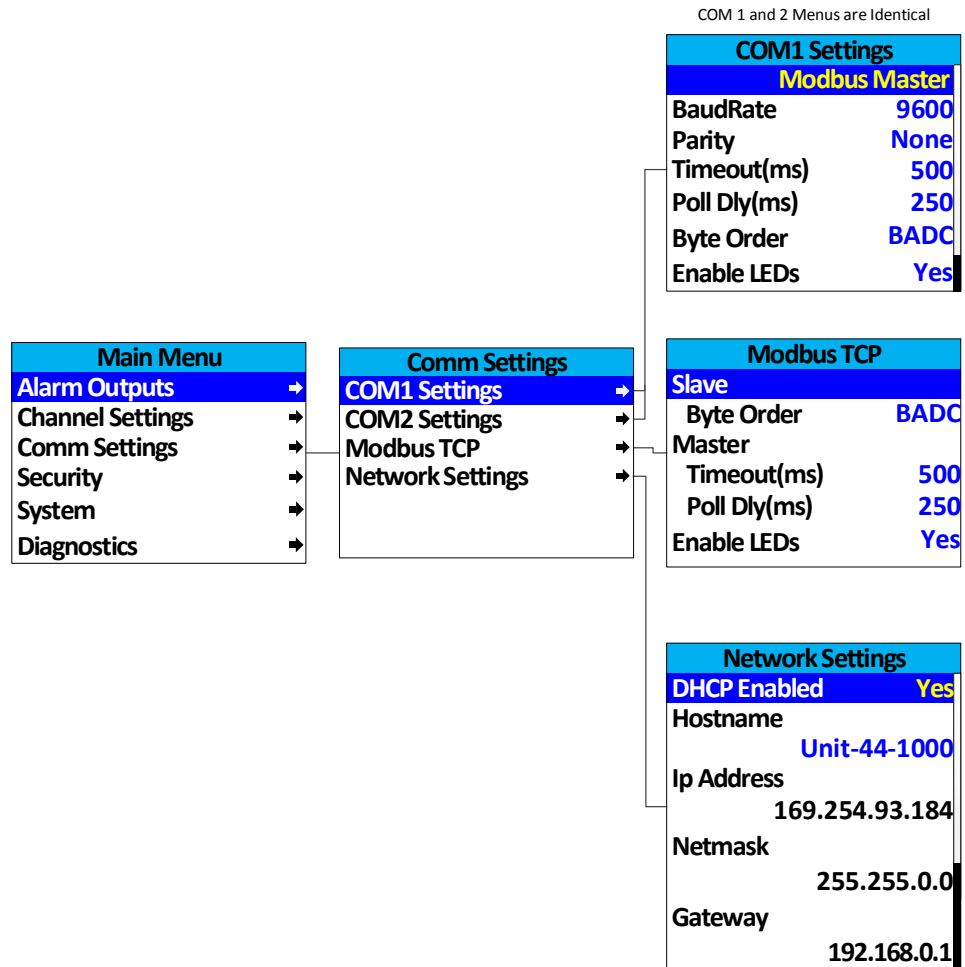

Figure 4-23 Comm Settings Menu Tree

**Comm Settings Menu** is accessed through the Main Menu. This menu is used to configure the two possible communication ports on the optional BFT10-0388 Relay/RS-485 Modbus Option Board.



## 4.5.1 COM1/COM2 SETTINGS

COM 1 and 2 Menus are Identical

COM1 Settings	
Modbus Master	
BaudRate	9600
Parity	None
Timeout(ms)	500
Poll Dly(ms)	250
Byte Order	BADC
Enable LEDs	Yes

Figure 4-24 COM1 and COM2 Settings Menu

The function parameter allows the communication ports to be set to **Modbus Master**, **Modbus Slave** or **Disabled**.

**Modbus Master Mode** allows the communication port to poll any device using the Modbus RTU protocol.

**Modbus Slave Mode** allows the communication port to be polled by any Modbus Master device using the Modbus RTU protocol.

Select **Disabled** to turn the port off if not needed.

### 4.5.1.1 BAUDRATE

**Baudrate** allows users to set the data rate of the communication port. The options include 9600, 19200, 38400, 57600 and 115200.

### 4.5.1.2 PARITY

A **Parity** bit is a bit that is added to ensure that the number of bits with the value "1" in a set of bits is even or odd. Parity bits are used as the simplest form of error detecting within code. The default is **None**.

### 4.5.1.3 TIMEOUT (MS)

The **Timeout** menu item affects the BFT-44's *Master* Modbus ports. **Timeout** is the length of time, in milliseconds, the controller waits before a Modbus request fails. Three consecutive failed requests must occur before a communication error is indicated. This item is useful for optimizing throughput to the BFT-44 from other slave RTUs.

### 4.5.1.4 POLL DLY (MS)

**Poll Dly** is the time in milliseconds the unit will delay between Modbus master requests.



#### 4.5.1.5 BYTE ORDER

**Byte Order** determines WORD and BYTE alignment of data at the remote Modbus transmitter when sending its 4 byte IEEE Floating Point values. Selecting this value cycles through four options ABCD, CDAB, BADC (default) and DCBA.

#### 4.5.1.6 ENABLE LEDS

**Enable LEDS** enables the RX and TX LEDs to flash green on valid transmit and receive transmissions. For ports configured as master, the RX LED will flash red if there is a Comm Error or if an exception is received. Slave ports will cause the RX LED to flash red under the same conditions, but can also cause the TX LED to flash red if an invalid function code is received or if the wrong register is given.



**Caution:** When using the LEDs to assist with troubleshooting it is important to note that LEDs may be enabled via Comm Port settings and Modbus TCP settings. So it is important to disable the LEDs for the ports which are not being tested.

#### 4.5.1.6 SLAVE ID

**Slave ID** is set to uniquely identify a BFT-44 in Modbus Slave mode. May be set to any value 1-247.

### 4.5.2 MODBUS TCP

Modbus TCP	
<b>Slave</b>	
Byte Order	BADC
<b>Master</b>	
Timeout(ms)	500
Poll Dly(ms)	250
Enable LEDS	Yes

Figure 4-25 Modbus TCP Menu

#### 4.5.2.1 SLAVE BYTE ORDER

If Modbus Slave is selected, **Slave Byte Order** determines WORD and BYTE alignment of data at the remote Modbus transmitter when sending its 4 byte IEEE Floating Point values. With the select bar on this entry, swiping the EDIT key toggles between the 4 possible modes. Min/Max Raw values are not used in this mode. Default is set to BADC.

#### 4.5.2.2 MASTER TIMEOUT (MS)

**Master Timeout** is the time in milliseconds before the unit gives up on a Modbus request and moves on to the next channel. After three consecutive timeouts, the channel enters the COM Error state.



#### 4.5.2.3 MASTER POLL DLY (MS)

**Master Poll Dly** is the time in milliseconds the unit will delay between Modbus Master requests.

#### 4.5.2.4 ENABLE LEDS

**Enable LEDS** enables the RX and TX LEDs to flash green on valid transmit and receive transmissions. For ports configured as master, the RX LED will flash red if there is a Comm Error or if an exception is received. Slave ports will cause the RX LED to flash red under the same conditions, but can also cause the TX LED to flash red if an invalid function code is received or if the wrong register is given.



**Caution:** When using the LEDs to assist with troubleshooting it is important to note that LEDs may be enabled via Comm Port settings and Modbus TCP settings. So it is important to disable the LEDs for the ports which are not being tested.

### 4.5.3 NETWORK SETTINGS

Network Settings	
DHCP Enabled	Yes
Hostname	Unit-44-1000
Ip Address	169.254.93.184
Netmask	255.255.0.0
Gateway	192.168.0.1

Figure 4-26 Network Settings Menu

See [Section 6.2](#) for integrating a BFT-44 into a network.

#### 4.5.3.1 DHCP ENABLED

**DHCP Enabled** allows the IP address to be set automatically by an external DHCP server. When this parameter is enabled, the unit can be accessed by its hostname or IP address. However, the IP address will be dependent on the DHCP server, and could potentially change.

#### 4.5.3.2 HOSTNAME

**Hostname** identifies the BFT-44 on a network as an alternative to the IP address.

#### 4.5.3.3 IP ADDRESS

**IP Address** identifies the BFT-44 on a network. This is automatically set when DHCP is enabled.



#### 4.5.3.4 NETMASK

Specify if your network requires. **Netmask** specifies the subnet addressing scheme. This is automatically set when DHCP is enabled.

#### 4.5.3.5 GATEWAY

**Gateway** is the IP address of the device that may connect this subnet to other networks. This is automatically set when DHCP is enabled.

## 4.6 SECURITY

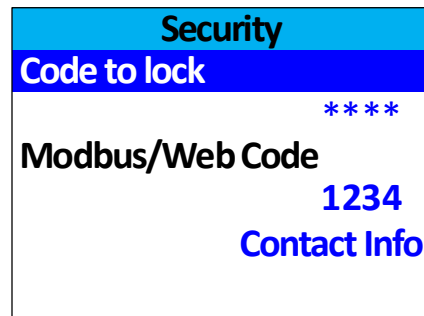

Figure 4-27 Security Menu

The **Security Menu** offers the ability to lock the BFT-44 using a four digit Code. Once enabled, the only actions that may be taken are to view the menus, view the data displays and perform calibrations. No fields may be edited without entering the Code to unlock in the Security Menu.

To enable the Security Mode, enter a four digit Code. **Note:** This is a one-time use code, which will be used to unlock the unit at a later time. Re-enter the Code to confirm and the BFT-44 will lock.

To disable the Security Mode, enter the four digit Code entered previously in the Security Menu.

The Modbus/Web Code is used on the embedded webpage to provide security by preventing inadvertent manipulation of the configuration from the webpage (See [Section 6.1](#)).

The Contact Info field is a 16 character ASCII field available for displaying a phone number or name of personnel who know the Code. Lost codes may be recovered by entering the locked security menu and entering the code 8621.





4.7 SYSTEM

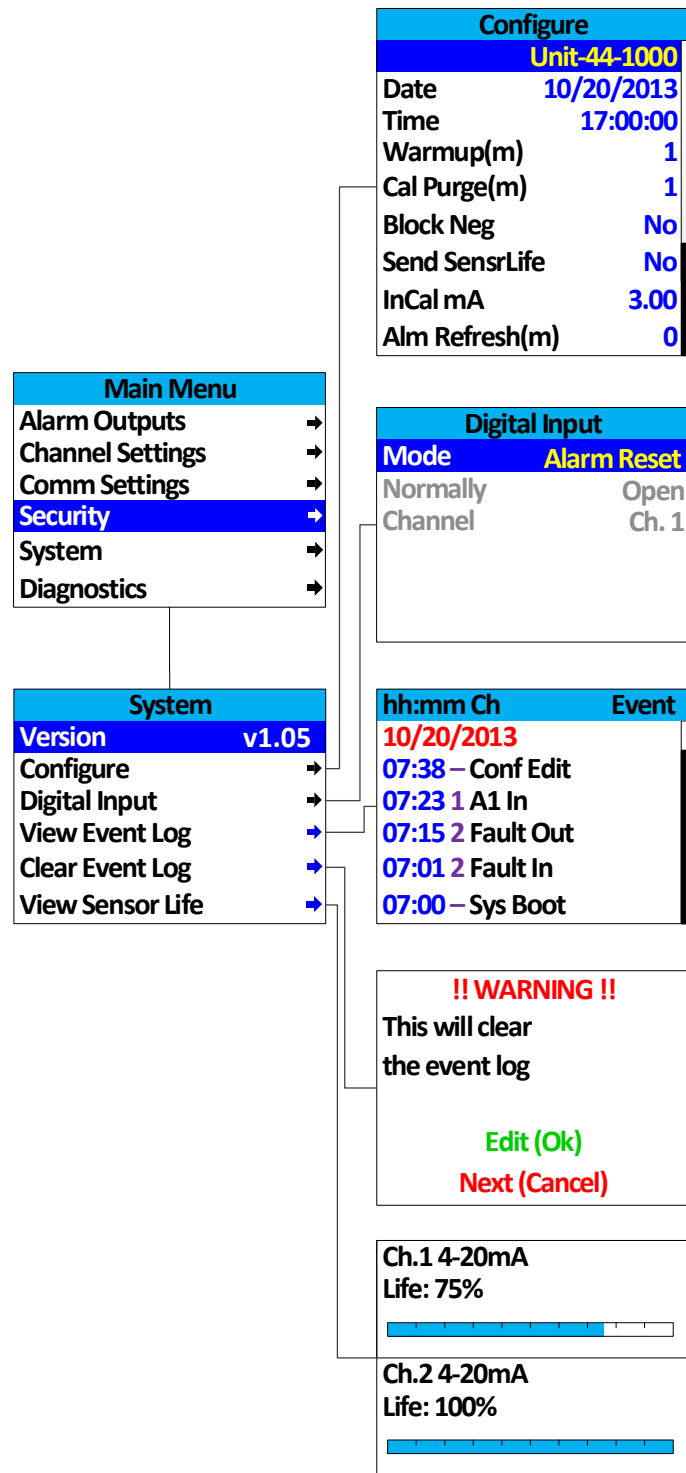

Figure 4-28 System Menu Tree

The **System Menu** is accessed through the Main Menu. System Menu items are items which effect the entire BFT-44, and are not specific to either channel. Submenus are accessed by highlighting the desired item and swiping the Edit key.



#### 4.7.1 VERSION

System	
Version	v1.05
Configure	→
Digital Input	→
View Event Log	→
Clear Event Log	→
View Sensor Life	→

Figure 4-29 System Menu

The **Version** line in the System Menu displays the version of firmware that is programmed in the BFT-44.

#### 4.7.2 CONFIGURE

Configure	
Unit-44-1000	
Date	10/20/2013
Time	17:00:00
Warmup(m)	1
Cal Purge(m)	1
Block Neg	No
Send SensrLife	No
Alm Refresh(m)	0

Figure 4-30 Configure System Menu

**Configure Menu** items are edited by highlighting the desired item and swiping Edit. Swipe UP and DOWN keys to change the value highlighted by the cursor and NEXT to move the cursor. Swipe EDIT again to save the value.

##### 4.7.2.1 UNIT NAME

**Unit Name** is used to assign the transmitter a name for use in the backup configuration file name. The unit name is limited to 16 characters.

##### 4.7.2.2 DATE

**Date** is used for Data and Event Logging. This is a factory setting, but may need to be adjusted for the end user's location.

##### 4.7.2.3 TIME

**Time** (24 hour clock) is used for Data and Event Logging. This is a factory setting, but may need to be adjusted for the end user's location.



#### 4.7.2.4 WARMUP (M)

**Warmup** is available to prevent unwanted alarm trips during sensor warmup. This time can be adjusted up to five minutes for sensors that take a long time to warm up.

#### 4.7.2.5 CAL PURGE (M)

**Cal Purge** is available to prevent unwanted alarm trips during calibration purge time. This time can be adjusted up to five minutes for sensors that take a long time to drift back down after calibration.

#### 4.7.2.6 BLOCK NEG

**Block Neg** prevents negative channel values from being displayed. It applies to both channels.

#### 4.7.2.7 SEND SENSRIFE

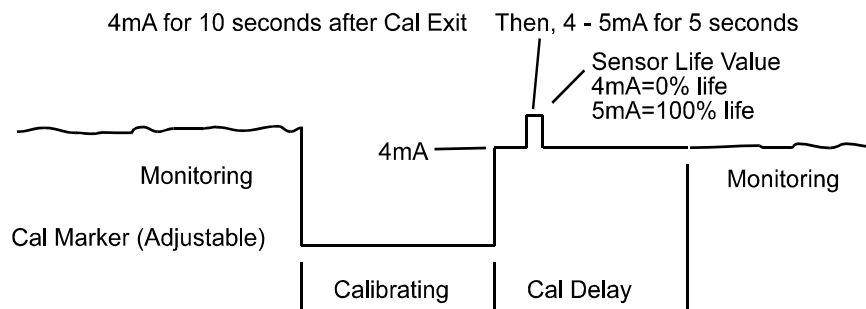

Figure 4-31 Send SensrLife Timing Diagram

Set for Yes, **Send SensrLife** causes the BFT-44 to transmit a sensor life value after successful calibrations during the Cal Purge Delay. Normal operation is the BFT-44 transmits 4mA during the Cal Purge Delay, but with Send SensrLife set to Yes it will transmit 4mA for the first 10 seconds then for 5 seconds it will transmit a value between 4mA and 5mA, with 4mA equal to 0% sensor life and 5mA equal to 100% sensor life. The output then returns to 4mA for the remainder of the Cal Purge Delay. For example, if after a calibration sensor life is 75%, the BFT-44 transmits 4.75mA during the 5 second interval.



**Note:** Send SensrLife should always be set for No unless the 4-20 mA receiver is capable of interpreting the sensor life signal. The Buckeye Detection Systems BFC-16 and BFC-64 are both capable of this function.

#### 4.7.2.8 ALM REFRESH (M)

**Alarm Refresh** allows reactivation of Acknowledged alarms after the time period expires. This feature is used primarily to restart audible alarm devices after having been silenced by an acknowledge function (via serial port or swiping the Up/Reset button). An entry of 0 minutes effectively disables the Alarm Refresh function. A maximum of 60 minutes is allowed.



### 4.7.3 DIGITAL INPUT

Digital Input	
Mode	Alarm Reset
Normally Channel	Open Ch. 1

Figure 4-32 Digital Input System Menu

If a digital input is installed on the BFT10-0388 Relay/RS-485 Option Board, the Digital Input Menu can be set to one of three available configuration options:

1. *Alarm Reset* – when selected any active alarms, acknowledge enabled, will be acknowledged and reset when an input is received.
2. *A3 Override* – when selected, Alarm 3 will be activated on the selected channels when a signal is received. The *Normally* menu option refers to the type of connection to the digital input. If the input is normally a short it should be set to Normally Closed, otherwise it should be set to open (This is useful in a similar manner to the Failsafe mode mentioned in [Section 4.3.1.3.](#))
3. *Flt Override* – when selected, the Fault Alarm will be activated on the selected channels when a signal is received. The *Normally* menu option refers to the type of connection to the digital input. If the input is normally a short it should be set to Normally Closed, otherwise it should be set to open (This is useful in a similar manner to the Failsafe mode mentioned in [Section 4.3.1.3.](#))

### 4.7.4 VIEW EVENT LOG

hh:mm Ch	Event
10/20/2013	
07:38	– Conf Edit
07:23	1 A1 In
07:15	2 Fault Out
07:01	2 Fault In
07:00	– Sys Boot

Figure 4-33 View Event Log System Menu

**View Event Log** displays the Event Log for the unit, which displays the last 100 events. Swipe up and down to scroll through the log. Entries have a date and time stamp followed by the channel number (or dash for system entries) and the type of event logged.

Logged events include:

1. Alarms/Fault In and Out
2. Alarm and Remote Alarm Resets



- 3. Alarm Refresh
- 4. Event Log Cleared
- 5. Configuration Changed
- 6. Calibration in and out
- 7. System and Cold Boots
- 8. Communication and Configuration Errors
- 9. Corrupt Sensor
- 10. Sensor Error
- 11. Configuration Edits

#### 4.7.5 CLEAR EVENT LOG

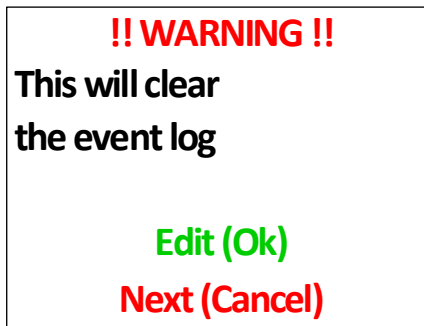

Figure 4-34 Clear Event Log System Menu

**Clear Event Log** clears the event log, swipe the Edit key to confirm.

#### 4.7.6 VIEW SENSOR LIFE

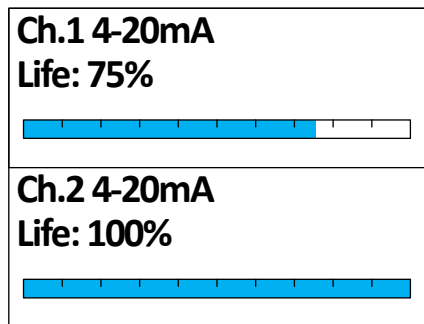

Figure 4-35 View Sensor Life System Menu

**View Sensor Life** provides an indication of the Sensor Life remaining. This percentage is calculated by comparing the amount of gain needed to be applied at the most recent calibration when compared to the amount of gain needed to be applied at the initial calibration.



## 4.8 DIAGNOSTICS

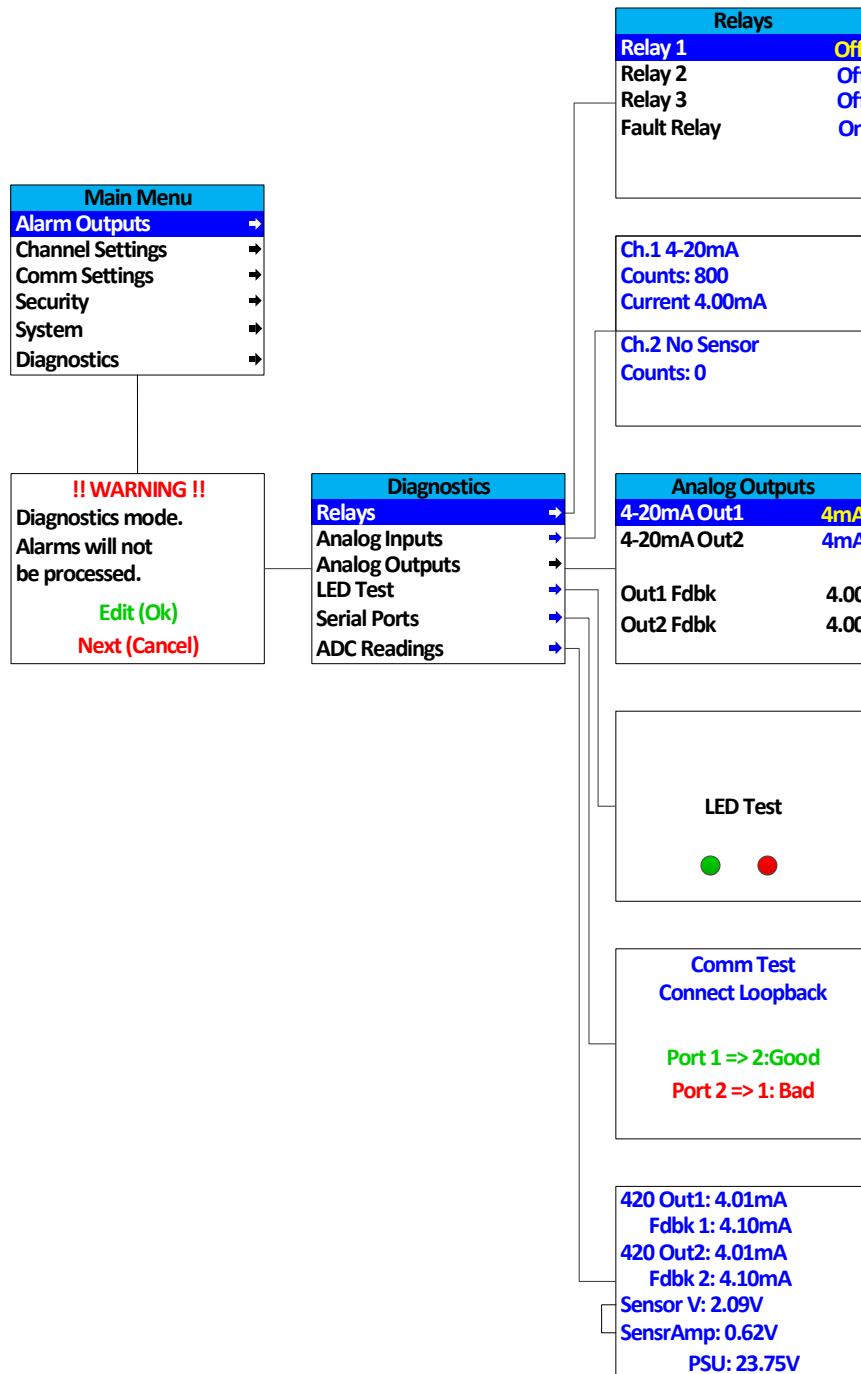

Figure 4-36 Diagnostics Menu Tree

A System Diagnostic Mode shown in Figure 4-36 may be entered during normal operation from the Main Menu. The entry menu offers useful routines for testing front panel LEDs, relays, serial ports, ADC readings and analog I/O. It is exited manually by swiping the Next key with a magnet, and automatically if no keys are swiped for five minutes.



**Caution:** It is very important to understand that **CHANNEL DATA IS NOT PROCESSED DURING THE SYSTEM DIAGNOSTICS MODE**. It is possible to miss important input values while utilizing this mode, and appropriate safeguards should be in place. However, the System Diagnostics Mode can prove invaluable when testing I/O since relays and analog outputs may be stimulated without driving inputs to precise levels.

#### 4.8.1 RELAYS

Relays	
Relay 1	Off
Relay 2	Off
Relay 3	Off
Fault Relay	On

Figure 4-37 Relay Diagnostics Menu

The **Relays Menu** allows manual actuation of the Relays (optional BFT10-0388 BFT-44 Relay/RS-485 Option Board) while in the System Diagnostics Mode. Highlight the relay to be actuated and swipe Edit. Confirm relay actuation, and swipe Edit again to de-energize the relay.

#### 4.8.2 ANALOG INPUTS

<b>Ch.1 4-20mA</b> <b>Counts: 800</b> <b>Current 4.00mA</b>
<b>Ch.2 No Sensor</b> <b>Counts: 0</b>

Figure 4-38 Analog Inputs Diagnostics Menu

The **Analog Inputs Menu** displays both channel's raw counts and input data.



### 4.8.3 ANALOG OUTPUTS

Analog Outputs	
4-20mA Out1	4mA
4-20mA Out2	4mA
Out1 Fdbk	4.03
Out2 Fdbk	4.04

Figure 4-39 Analog Outputs Diagnostics Menu

**Analog Outputs** manually stimulates the 4-20mA outputs by selecting the channel and swiping EDIT. Each swipe increments the output by 4mA from 0-20mA. The Out1 Fdbk and Out2 Fdbk can be useful in determining if there are issues with the output. A circuit is installed on each of the two outputs which measures the actual current flow out of the output terminals. If this number reads zero when an output is stimulated, it could indicate that there is a cut wire or some other failure in connection with the wiring to the controller.

### 4.8.4 LED TEST

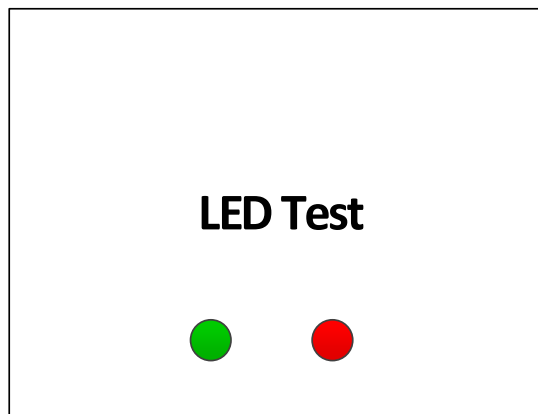

Figure 4-40 LED Test Diagnostics Menu

**LED Test** causes the two LEDs on the front panel to blink alternating red and green.





#### 4.8.5 SERIAL PORTS

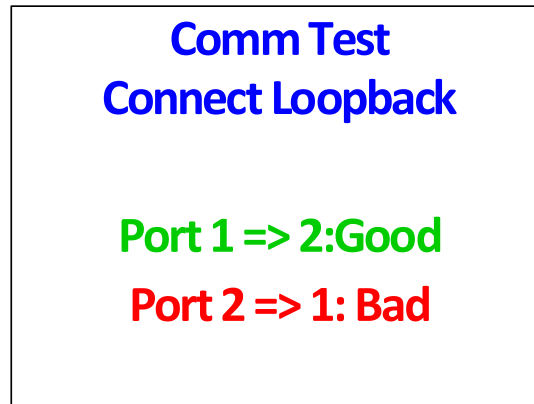

Figure 4-41 Serial Ports Diagnostics Menu

**Serial Ports** is used to test the two communication ports on the optional BFT10-0388 Relay/RS-485 Modbus Option Board. To test the Serial Ports connect A1 to A2 and B1 to B2, and set jumpers J3 and J5 to dual port mode, position B. The screen will then display a Good or Bad status report as shown in Figure 4-41.

#### 4.8.6 ADC READINGS

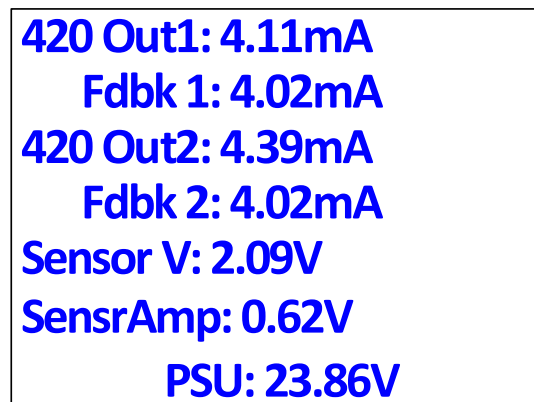

Figure 4-42 ADC Readings Diagnostics Menu

The **ADC Readings** displays Channel 1/2 4-20mA output and feedback current, sensor voltage for bridge inputs and sensor amplifier and power supply voltage as shown in Figure 4-42. These values may be useful to technicians when trying to determine whether or not a sensor is working properly.

The Fdbk1 and Fdbk2 can be useful in determining if there are issues with the output. A circuit is installed on each of the two outputs which measures the actual current flow out of the output terminals. If this number reads zero when an output is stimulated, it could indicate that there is a cut wire or some other failure in connection with the wiring to the controller.



## Chapter 5 Modbus

The BFT-44 may be equipped with two optional (BFT10-0388 Relay/RS-485 Modbus Option Board) RS-485 ports which can be independently configured as Modbus master or slave. Chapter 5 defines register locations of data available via the BFT-44 slave port.

### 5.1 MODBUS TCP

In addition to the RS-485 ports, the BFT-44 supports both master and slave Modbus TCP. Modbus TCP is always enabled through the Ethernet port. The unit can be polled by its IP Address. When Modbus TCP slave is used, the Slave ID field of the message is ignored. Channels can be configured to poll using the BFT-44's Modbus TCP master interface. Devices are polled by IP Address.

### 5.2 MODBUS SLAVE WRITES

The Modbus slave ports allow function code 5(write coil), as well as function code 6, and 16 (write holding registers). These function codes can be used to write configuration parameters to the BFT-44. By default, all Modbus writes are disabled except the unlock parameter 40099. The Modbus lock code can be written to register 40099 to enable writes to other registers. The unit will be unlocked for 10 minutes after the last write occurs. After the 10 minute timeout, the unit will automatically save any parameters that have been written to. All written parameters can be saved manually by writing a value of 1 to coil 95 or register 40095.

Writing parameters that span multiple register (such as 32bit floating points) requires function code 16. All registers must be written at once.

### 5.3 MODBUS SLAVE REGISTER LOCATION

The following table describes the BFT-44's Modbus slave database. Any portion of this data may be read by a Modbus master device such as a PC, PLC or DCS. Since the Modbus port is RS-485, multiple BFT-44s may be multi-dropped onto the same cable.

Variable Name	Alias	Read	Write	Notes
Ch 1 Analog Output Raw	31001	4	N/A	12 bit value; 800 = 4mA; 4000 = 20mA
Ch 2 Analog Output Raw	31002	4	N/A	12 bit value; 800 = 4mA; 4000 = 20mA
Ch 1 A2D Raw Counts	31003	4	N/A	12 bit value from A/D converter
Ch 2 A2D Raw Counts	31004	4	N/A	12 bit value from A/D converter
Ch 1 Sensor Life	31009	4	N/A	16 bit signed integer ranging from -1 to 100 where -1 indicates Cal Required
Ch 2 Sensor Life	31010	4	N/A	16 bit signed integer ranging from -1 to 100 where -1 indicates Cal Required
Ch 1 Sensor Temp	31011	4	N/A	16 bit integer from 1 to 4095 scaled for -55°C to +125°C



Ch 2 Sensor Temp	31012	4	N/A	16 bit integer from 1 to 4095 scaled for -55°C to +125°C
Ch 1 4-20mA Out FP	31210	4	N/A	32 bit floating point
Ch 2 4-20mA Out FP	31212	4	N/A	32 bit floating point
Ch 1 Output Feedback FP	31214	4	N/A	32 bit floating point
Ch 2 Output Feedback FP	31216	4	N/A	32 bit floating point
12V Input FP	31218	4	N/A	32 bit floating point
Sensor Volts FP	31220	4	N/A	32 bit floating point
Bridge Amp FP	31222	4	N/A	32 bit floating point
Bridge Out FP	31224	4	N/A	32 bit floating point
Product ID	32001	4	N/A	Factory use only
Version	32002	4	N/A	Factory use only
Custom Feature	32003	4	N/A	Factory use only
Customer ID	32004	4	N/A	Factory use only
Lock Status	32005	4	N/A	
Boot Year	32006	4	N/A	Last power-up time & date
Boot Month	32007	4	N/A	Last power-up time & date
Boot Day	32008	4	N/A	Last power-up time & date
Boot Hour	32009	4	N/A	Last power-up time & date
Boot Minute	32010	4	N/A	Last power-up time & date
Boot Second	32011	4	N/A	Last power-up time & date
SR 1 State	32020	4	N/A	True if relay #1 active
SR 2 State	32021	4	N/A	True if relay #2 active
SR 3 State	32022	4	N/A	True if relay #3 active
FR State	32023	4	N/A	True if fault relay active
Warmup	32025	4	N/A	True if unit in warm-up
SR 1 Flashing	32026	4	N/A	True if relay #1 flashing
SR 2 Flashing	32027	4	N/A	True if relay #2 flashing
SR 3 Flashing	32028	4	N/A	True if relay #3 flashing
FR Flashing	32029	4	N/A	True if fault relay flashing
DI State	32034	4	N/A	Digital input status
Ch 1 Fixed Point	33001	4	N/A	Compatible with GASMAX II
CH 2 Fixed Point	33002	4	N/A	Compatible with GASMAX II
Ch 1 Floating Point	33010	4	N/A	32 bit IEEE 754 float
Ch 1 Value String	33012	4	N/A	6 character string ;zero terminated
Ch 1 Temperature Float	33015	4	N/A	Sensor temperature
Ch 1 A1 Status	33017	4	N/A	True if alarm 1 active
Ch 1 A1 Flashing	33018	4	N/A	True if alarm 1 indicator flashing
Ch 1 A2 Status	33019	4	N/A	True if alarm 2 active
Ch 1 A2 Flashing	33020	4	N/A	True if alarm 2 indicator flashing



Ch 1 A3 Status	33021	4	N/A	True if alarm 3 active
Ch 1 A3 Flashing	33022	4	N/A	True if alarm 3 indicator flashing
Ch 1 Fault Status	33023	4	N/A	True if fault active
Ch 1 Comm Error	33024	4	N/A	True if comm error
Ch 1 Config Error	33025	4	N/A	True if config error
Ch 1 I/O Error	33026	4	N/A	True if input/output error
Ch 1 Cal Flag	33027	4	N/A	True if calibration in progress
Ch 1 Marker Flag	33028	4	N/A	True if marker active
Ch 1 Linearize	33029	4	N/A	True if linearization table active
Ch 1 Err Flashing	33030	4	N/A	True if channel error
Ch 2 Floating Point	33040	4	N/A	32 bit IEEE 754 float
Ch 2 Value String	33042	4	N/A	6 character string ;zero terminated
Ch 2 Temp Float	33045	4	N/A	Sensor temperature
Ch 2 A1 Status	33047	4	N/A	True if alarm 1 active
Ch 2 A1 Flashing	33048	4	N/A	True if alarm 1 indicator flashing
Ch 2 A2 Status	33049	4	N/A	True if alarm 2 active
Ch 2 A2 Flashing	33050	4	N/A	True if alarm 2 indicator flashing
Ch 2 A3 Status	33051	4	N/A	True if alarm 3 active
Ch 2 A3 Flashing	33052	4	N/A	True if alarm 3 indicator flashing
Ch 2 Fault Status	33053	4	N/A	True if fault active
Ch 2 Comm Error	33054	4	N/A	True if comm error
Ch 2 Config Error	33055	4	N/A	True if config error
Ch 2 I/O Error	33056	4	N/A	True if input/output error
Ch 2 Cal Flag	33057	4	N/A	True if calibration in progress
Ch 2 Marker Flag	33058	4	N/A	True if marker active
Ch 2 Linearize	33059	4	N/A	True if linearization table active
Ch 2 Err Flashing	33060	4	N/A	True if channel error
Alarm Reset	40001	N/A	3	Write to acknowledge alarm
System Name	40010	4	N/A	16 character ASCII text
Date Year	40020	3	N/A	Current time & date
Date Month	40021	3	N/A	Current time & date
Date Day	40022	3	N/A	Current time & date
Date Hour	40023	3	N/A	Current time & date
Date Minute	40024	3	N/A	Current time & date
Date Second	40025	3	N/A	Current time & date
Refresh Time	40026	3	N/A	Alarm refresh (minutes)
Warmup Time	40027	3	N/A	Warm up delay (minutes)
Cal Purge Time	40028	3	N/A	Cal purge delay (minutes)
Block Negative Flag	40029	3	N/A	True if prohibit display of neg values
Comm 1 Function	40030	3	N/A	MODBUS serial port #1
Comm 1 Baud Rate	40031	3	N/A	MODBUS serial port #1



Comm 1 Parity	40032	3	N/A	MODBUS serial port #1
Comm 1 Slave ID	40033	3	N/A	MODBUS serial port #1
Comm 1 Timeout	40034	3	N/A	MODBUS serial port #1
Comm 1 Poll Delay	40035	3	N/A	MODBUS serial port #1
Comm 1 Byte Order	40036	3	N/A	MODBUS serial port #1
Comm 1 Wireless T/O	40037	3	N/A	MODBUS serial port #1
Comm 1 LED Enable	40038	3	N/A	MODBUS serial port #1
Comm 2 Function	40040	3	N/A	MODBUS serial port #2
Comm 2 Baud Rate	40041	3	N/A	MODBUS serial port #2
Comm 2 Parity	40042	3	N/A	MODBUS serial port #2
Comm 2 Slave ID	40043	3	N/A	MODBUS serial port #2
Comm 2 Timeout	40044	3	N/A	MODBUS serial port #2
Comm 2 Poll Delay	40045	3	N/A	MODBUS serial port #2
Comm 2 Byte Order	40046	3	N/A	MODBUS serial port #2
Comm 2 Wireless T/O	40047	3	N/A	MODBUS serial port #2
Comm 2 LED Enable	40048	3	N/A	MODBUS serial port #2
DHCP Enabled	40050	3	N/A	Ethernet port; DHCP or fixed address
Host Name	40051	3	N/A	Ethernet port: 16 ASCII characters
IP Address	40066	3	N/A	Ethernet port: xxx.xxx.xxx.xxx
Net Mask	40070	3	N/A	Ethernet port: xxx.xxx.xxx.xxx
Gateway IP	40074	3	N/A	Ethernet port: xxx.xxx.xxx.xxx
Modbus TCP Byte Order	40080	3	N/A	MODBUS/TCP function
Modbus TCP Timeout	40081	3	N/A	MODBUS/TCP timeout (mSec)
Modbus TCP Poll Delay	40082	3	N/A	MODBUS/TCP poll delay (mSec)
Save Config	40095	N/A	3	Write command to save local config
Config Changed	40096	3	N/A	True if config changed since last read
Security Unlock	40099	3	N/A	TBD
Relay 1 A1 Votes	40101	3	N/A	Alarm relay #1 configuration
Relay 1 A2 Votes	40102	3	N/A	Alarm relay #1 configuration
Relay 1 A3 Votes	40103	3	N/A	Alarm relay #1 configuration
Relay 1 Fault Votes	40104	3	N/A	Alarm relay #1 configuration
Relay 1 Override	40105	3	N/A	Alarm relay #1 configuration
Relay 1 Ack	40107	3	N/A	Alarm relay #1 configuration
Relay 1 Failsafe	40108	3	N/A	Alarm relay #1 configuration
Relay 2 A1 Votes	40111	3	N/A	Alarm relay #2 configuration
Relay 2 A2 Votes	40112	3	N/A	Alarm relay #2 configuration
Relay 2 A3 Votes	40113	3	N/A	Alarm relay #2 configuration
Relay 2 Fault Votes	40114	3	N/A	Alarm relay #2 configuration
Relay 2 Override	40115	3	N/A	Alarm relay #2 configuration
Relay 2 Ack	40117	3	N/A	Alarm relay #2 configuration



Relay 2 Failsafe	40118	3	N/A	Alarm relay #2 configuration
Relay 3 A1 Votes	40121	3	N/A	Alarm relay #3 configuration
Relay 3 A2 Votes	40122	3	N/A	Alarm relay #3 configuration
Relay 3 A3 Votes	40123	3	N/A	Alarm relay #3 configuration
Relay 3 Fault Votes	40124	3	N/A	Alarm relay #3 configuration
Relay 3 Override	40125	3	N/A	Alarm relay #3 configuration
Relay 3 Ack	40127	3	N/A	Alarm relay #3 configuration
Relay 3 Failsafe	40128	3	N/A	Alarm relay #3 configuration
Force Sensor Upload	40141	3	N/A	Binary
Digital Input Mode	40150	3	N/A	Alarm ack or flow switch input
Digital Input Type	40151	3	N/A	Alarm ack or flow switch input
Digital Input Mode	40152	3	N/A	Alarm ACK or flow switch input
Send Sensor Life	40153	3	N/A	True if transmit sensor life value
Contact Info String	40160	3	N/A	16 ASCII characters (2 per register)
Ch 1 Measurement Name	40401	3	N/A	16 ASCII characters (2 per register)
Ch 2 Measurement Name	40409	3	N/A	16 ASCII characters (2 per register)
Ch 1 EUNITS	40423	3	N/A	10 ASCII characters (2 per register)
Ch 2 EUNITS	40428	3	N/A	10 ASCII characters (2 per register)
Ch 1 Preamp gain	40433	3	N/A	Contact factory
Ch 2 Preamp gain	40434	3	N/A	Contact factory
Ch 1 Cal Zero	42001	3	N/A	Modbus 32 bit IEEE 754 Floating Pt
Ch 1 Cal Span	42003	3	N/A	Modbus 32 bit IEEE 754 Floating Pt
Ch 1 Zero Value	42005	3	N/A	Modbus 32 bit IEEE 754 Floating Pt
Ch 1 Span Value	42007	3	N/A	Modbus 32 bit IEEE 754 Floating Pt
Ch 1 Fault Value	42009	3	N/A	Modbus 32 bit IEEE 754 Floating Pt
Ch 1 Alarm 1 Setpoint	42011	3	N/A	Modbus 32 bit IEEE 754 Floating Pt
Ch 1 Alarm 2 Setpoint	42013	3	N/A	Modbus 32 bit IEEE 754 Floating Pt
Ch 1 Alarm 3 Setpoint	42015	3	N/A	Modbus 32 bit IEEE 754 Floating Pt
Ch 1 Manual Gain	42017	3	N/A	Modbus 32 bit IEEE 754 Floating Pt
Ch 1 Manual Offset	42019	3	N/A	Modbus 32 bit IEEE 754 Floating Pt
Ch 2 Cal Zero Value	42021	3	N/A	Modbus 32 bit IEEE 754 Floating Pt
Ch 2 Cal Span Value	42023	3	N/A	Modbus 32 bit IEEE 754 Floating Pt
Ch 2 Zero Value	42025	3	N/A	Modbus 32 bit IEEE 754 Floating Pt
Ch 2 Span Value	42027	3	N/A	Modbus 32 bit IEEE 754 Floating Pt
Ch 2 Fault Value	42029	3	N/A	Modbus 32 bit IEEE 754 Floating Pt
Ch 2 Alarm 1 Setpoint	42031	3	N/A	Modbus 32 bit IEEE 754 Floating Pt
Ch 2 Alarm 2 Setpoint	42033	3	N/A	Modbus 32 bit IEEE 754 Floating Pt
Ch 2 Alarm 3 Setpoint	42035	3	N/A	Modbus 32 bit IEEE 754 Floating Pt
Ch 2 Manual Gain	42037	3	N/A	Modbus 32 bit IEEE 754 Floating Pt



Ch 2 Manual Offset	42039	3	N/A	Modbus 32 bit IEEE 754 Floating Pt
Ch 1 Alarm 1 Latch	43001	3	N/A	False = NO; True = YES
Ch 1 Alarm 1 Trip	43002	3	N/A	False = HIGH ;True = LOW
Ch 1 Alarm 1 On Delay	43003	3	N/A	Activation delay in seconds
Ch 1 Alarm 1 Off Delay	43004	3	N/A	Deactivation delay in minutes
Ch 1 Alarm 1 Hysteresis	43005	3	N/A	Percent of scale
Ch 1 Alarm 2 Latch	43011	3	N/A	False = NO; True = YES
Ch 1 Alarm 2 Trip	43012	3	N/A	False = HIGH ;True = LOW
Ch 1 Alarm 2 On Delay	43013	3	N/A	Activation delay in seconds
Ch 1 Alarm 2 Off Delay	43014	3	N/A	Deactivation delay in minutes
Ch 1 Alarm 2 Hysteresis	43015	3	N/A	Percent of scale
Ch 1 Alarm 2 Color	43016	3	N/A	TBD
Ch 1 Alarm 3 Latch	43021	3	N/A	False = NO; True = YES
Ch 1 Alarm 3 Trip	43022	3	N/A	False = HIGH ;True = LOW
Ch 1 Alarm 3 On Delay	43023	3	N/A	Activation delay in seconds
Ch 1 Alarm 3 Off Delay	43024	3	N/A	Deactivation delay in minutes
Ch 1 Alarm 3 Hysteresis	43025	3	N/A	Percent of scale
Ch 1 Alarm 3 Color	43026	3	N/A	TBD
Ch 1 Alarm 3 Enabled	43027	3	N/A	False = NO; True = YES
Ch 1 Data From	43031	3	N/A	Selection
Ch 1 Min Raw	43032	3	N/A	Binary (800)
Ch 1 Max Raw	43033	3	N/A	Binary (4000)
Ch 1 Remote ID	43034	3	N/A	Binary
Ch 1 Interface	43035	3	N/A	Binary
Ch 1 Byte Order	43036	3	N/A	Byte order
Ch 1 Alias	43037	3	N/A	Binary; 32 bit; 2x
Ch 1 IP Address	43039	3	N/A	Binary; 4x unsigned bytes
Ch 1 Port	43041	3	N/A	Binary; 32 bit; 2x
Ch 1 Remote Sensor	43043	3	N/A	Binary
Ch 1 DP	43079	3	N/A	Number of decimal points
Ch 1 Enable	43080	3	N/A	False = NO; True = YES
Ch 1 Deadband	43081	3	N/A	Modbus 32 bit IEEE 754 Floating Pt
Ch 1 Marker Enable	43083	3	N/A	False = NO; True = YES
Ch 1 Marker Percent	43084	3	N/A	Modbus 32 bit IEEE 754 Floating Pt
Ch 1 Marker Info	43086	3	N/A	6 ASCII characters
Ch 1 Marker Life	43089	3	N/A	Binary
Ch 1 Filter Count	43090	3	N/A	Binary ;0 to 60
Ch 1 Radio Reg	43091	3	N/A	Binary
Ch 1 Coefficient	43092	3	N/A	Binary
Ch 1 Bridge Voltage	43093	3	N/A	Modbus 32 bit IEEE 754 Floating Pt



Ch 1 Balance	43095	3	N/A	Binary
Ch 1 Heater Enable	43096	3	N/A	False = NO; True = YES
Ch 1 Heater Setpoint	43097	3	N/A	Modbus 32 bit IEEE 754 Floating Pt
Ch 1 Temp Comp -40	43099	3	N/A	32 bit FP Gain ;32 bit FP Offset
Ch 1 Temp Comp -30	43103	3	N/A	32 bit FP Gain ;32 bit FP Offset
Ch 1 Temp Comp -20	43107	3	N/A	32 bit FP Gain ;32 bit FP Offset
Ch 1 Temp Comp -10	43111	3	N/A	32 bit FP Gain ;32 bit FP Offset
Ch 1 Temp Comp 0	43115	3	N/A	32 bit FP Gain ;32 bit FP Offset
Ch 1 Temp Comp +10	43119	3	N/A	32 bit FP Gain ;32 bit FP Offset
Ch 1 Temp Comp +20	43123	3	N/A	32 bit FP Gain ;32 bit FP Offset
Ch 1 Temp Comp +30	43127	3	N/A	32 bit FP Gain ;32 bit FP Offset
Ch 1 Temp Comp +40	43131	3	N/A	32 bit FP Gain ;32 bit FP Offset
Ch 1 Temp Comp +50	43135	3	N/A	32 bit FP Gain ;32 bit FP Offset
Ch 1 Temp Comp +60	43139	3	N/A	32 bit FP Gain ;32 bit FP Offset
Ch 1 Sensor Type	43143	3	N/A	TBD
Ch 1 Send Sensor Life	43144	3	N/A	False = NO; True = YES
Ch 1 Cal mA Setting	43145	3	N/A	Modbus 32 bit IEEE 754 Floating Pt
Ch 1 Local Cal	43147	3	N/A	False = NO; True = YES
Ch 1 AI Range	43148	3	N/A	TBD
Ch 2 Alarm 1 Latch	43201	3	N/A	False = NO; True = YES
Ch 2 Alarm 1 Trip	43202	3	N/A	False = HIGH ;True = LOW
Ch 2 Alarm 1 On Delay	43203	3	N/A	Activation delay in seconds
Ch 2 Alarm 1 Off Delay	43204	3	N/A	Deactivation delay in minutes
Ch 2 Alarm 1 Hysteresis	43205	3	N/A	Percent of scale
Ch 2 Alarm 2 Latch	43211	3	N/A	False = NO; True = YES
Ch 2 Alarm 2 Trip	43212	3	N/A	False = HIGH ;True = LOW
Ch 2 Alarm 2 On Delay	43213	3	N/A	Activation delay in seconds
Ch 2 Alarm 2 Off Delay	43214	3	N/A	Deactivation delay in minutes
Ch 2 Alarm 2 Hysteresis	43215	3	N/A	Percent of scale
Ch 2 Alarm 2 Color	43216	3	N/A	TBD
Ch 2 Alarm 3 Latch	43221	3	N/A	False = NO; True = YES
Ch 2 Alarm 3 Trip	43222	3	N/A	False = HIGH ;True = LOW
Ch 2 Alarm 3 On Delay	43223	3	N/A	Activation delay in seconds
Ch 2 Alarm 3 Off Delay	43224	3	N/A	Deactivation delay in minutes
Ch 2 Alarm 3 Hysteresis	43225	3	N/A	Percent of scale
Ch 2 Alarm 3 Color	43226	3	N/A	TBD
Ch 2 Alarm 3 Enabled	43227	3	N/A	False = NO; True = YES
Ch 2 Data From	43231	3	N/A	Selection
Ch 2 Min Raw	43232	3	N/A	Binary (800)
Ch 2 Max Raw	43233	3	N/A	Binary (4000)





Ch 2 Remote ID	43234	3	N/A	Binary
Ch 2 Interface	43235	3	N/A	Binary
Ch 2 Byte Order	43236	3	N/A	Byte order
Ch 2 Alias	43237	3	N/A	Binary; 32 bit; 2x
Ch 2 IP Address	43239	3	N/A	Binary; 4x unsigned bytes
Ch 2 Port	43241	3	N/A	Binary; 32 bit; 2x
Ch 2 Remote Sensor	43243	3	N/A	Binary
Ch 2 DP	43279	3	N/A	Number of decimal points
Ch 2 Enable	43280	3	N/A	False = NO; True = YES
Ch 2 Deadband	43281	3	N/A	Modbus 32 bit IEEE 754 Floating Pt
Ch 2 Marker Enable	43283	3	N/A	False = NO; True = YES
Ch 2 Marker Percent	43284	3	N/A	Modbus 32 bit IEEE 754 Floating Pt
Ch 2 Marker Info	43286	3	N/A	6 ASCII characters
Ch 2 Marker Life	43289	3	N/A	Binary
Ch 2 Filter Count	43290	3	N/A	Binary ;0 to 60
Ch 2 Radio Reg	43291	3	N/A	Binary
Ch 2 Coefficient	43292	3	N/A	Binary
Ch 2 Bridge Voltage	43293	3	N/A	Modbus 32 bit IEEE 754 Floating Pt
Ch 2 Balance	43295	3	N/A	Binary
Ch 2 Heater Enable	43296	3	N/A	False = NO; True = YES
Ch 2 Heater Setpoint	43297	3	N/A	Modbus 32 bit IEEE 754 Floating Pt
Ch 2 Temp Comp -40	43299	3	N/A	32 bit FP Gain ;32 bit FP Offset
Ch 2 Temp Comp -30	43303	3	N/A	32 bit FP Gain ;32 bit FP Offset
Ch 2 Temp Comp -20	43307	3	N/A	32 bit FP Gain ;32 bit FP Offset
Ch 2 Temp Comp -10	43311	3	N/A	32 bit FP Gain ;32 bit FP Offset
Ch 2 Temp Comp 0	43315	3	N/A	32 bit FP Gain ;32 bit FP Offset
Ch 2 Temp Comp +10	43319	3	N/A	32 bit FP Gain ;32 bit FP Offset
Ch 2 Temp Comp +20	43323	3	N/A	32 bit FP Gain ;32 bit FP Offset
Ch 2 Temp Comp +30	43327	3	N/A	32 bit FP Gain ;32 bit FP Offset
Ch 2 Temp Comp +40	43331	3	N/A	32 bit FP Gain ;32 bit FP Offset
Ch 2 Temp Comp +50	43335	3	N/A	32 bit FP Gain ;32 bit FP Offset
Ch 2 Temp Comp +60	43339	3	N/A	32 bit FP Gain ;32 bit FP Offset
Ch 2 Sensor Type	43343	3	N/A	TBD
Ch 2 Send Sensor Life	43344	3	N/A	False = NO; True = YES
Ch 2 Cal mA Setting	43345	3	N/A	Modbus 32 bit IEEE 754 Floating Pt
Ch 2 Local Cal	43347	3	N/A	False = NO; True = YES
Ch 2 AI Range	43348	3	N/A	TBD
Ch 1 Value	45001	3	N/A	800 = "0"; 4000 = Full Scale
Ch 2 Value	45002	3	N/A	800 = "0"; 4000 = Full Scale
Ch 1 Value	45003/04	3	N/A	MODBUS 32 bit floating point



Ch 2 Value	45005/06	3	N/A	MODBUS 32 bit floating point
Ch 1 Alarm 1 Status	45007	3	N/A	"1" = Fault
Ch 1 Alarm 2 Status	45008	3	N/A	"1" = Fault
Ch 1 Alarm 3 Status	45009	3	N/A	"1" = Fault
Ch 1 Fault Status	45010	3	N/A	"1" = Fault
Ch 2 Alarm 1 Status	45011	3	N/A	"1" = Fault
Ch 2 Alarm 2 Status	45012	3	N/A	"1" = Fault
Ch 2 Alarm 3 Status	45013	3	N/A	"1" = Fault
Ch 2 Fault Status	45014	3	N/A	"1" = Fault
Ch 1 Sensor Life	45015	3	N/A	0-100 binary
Ch 2 Sensor Life	45016	3	N/A	0-100 binary
Ch 1 Sensor Temp	45017	3	N/A	Binary 0 - 4095
Ch2 Sensor Temp	45018	3	N/A	Binary 0 - 4095
Ch 1 Sensor Temp	45019/20	3	N/A	MODBUS 32 bit floating point
Ch 2 Sensor Temp	45021/22	3	N/A	MODBUS 32 bit floating point

## Chapter 6 Special Features

### 6.1 WEBPAGE

All BFT-44 transmitters come standard with an embedded webpage. The webpage gives remote access to view and configure parameters inside the transmitter. The required login allows the user to change configuration parameters directly from the computer.

The webpage requires a modern web browser. Supported browsers include Internet Explorer 8\*, Google Chrome, or Mozilla Firefox 2+. Viewing pages in an outdated browser will result in improperly drawn pages.

In order to view the webpage first the user must know the IP address or, if DHCP enabled, the transmitter's hostname. This information can be viewed from the Network Settings Menu (see [Section 4.5.3](#)). The user will be able to see channel data, event logs and configuration. If a parameter needs to be changed the user must login before the transmitter will accept the change. This login password can be changed in the Security menu under Modbus/Web Code (see [Section 4.6](#)). The default Modbus/Web Code is **1234**.

\* Internet Explorer does not allow access to hostnames that contain a '\_' character.



### 6.1.1 STATUS SCREEN

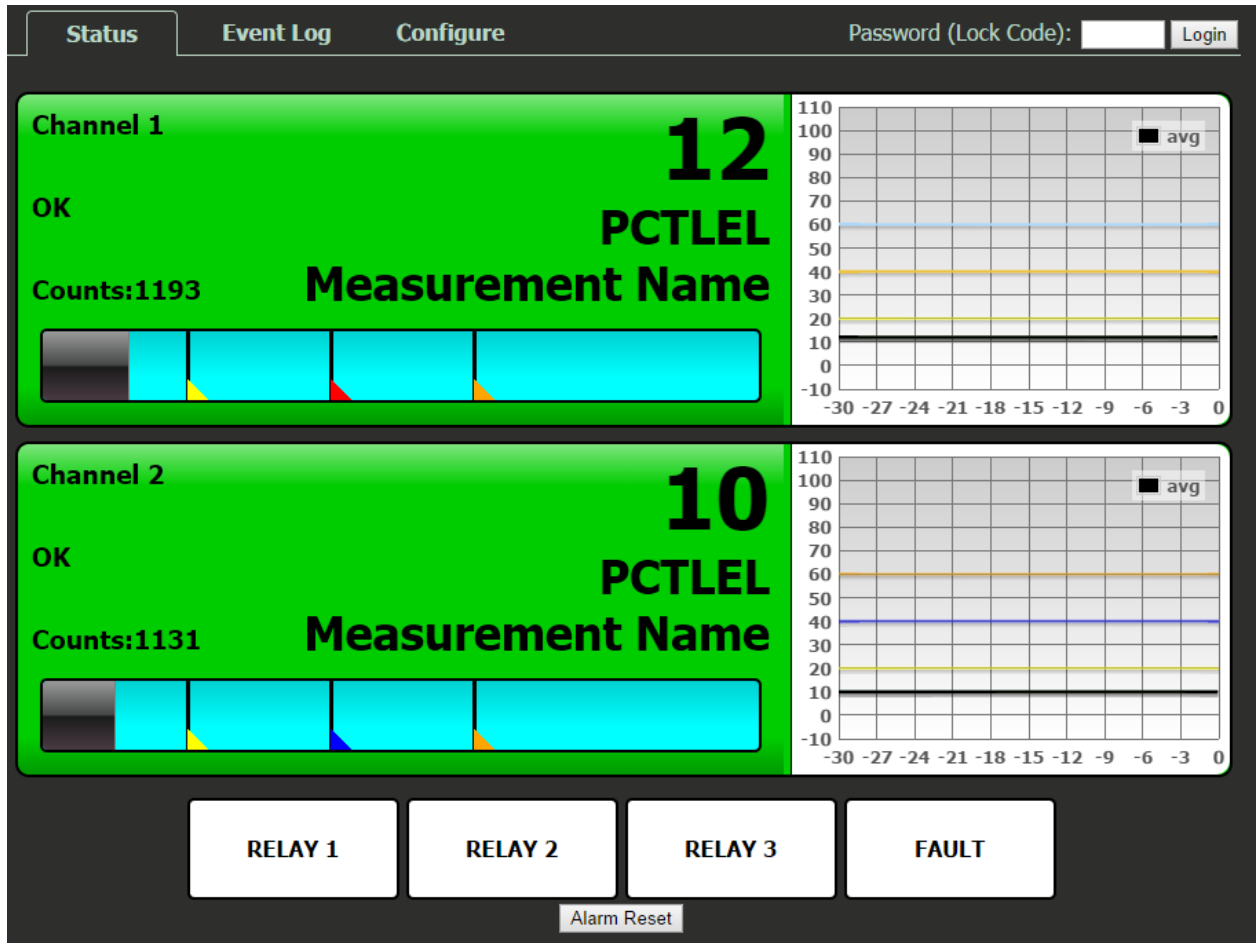

Figure 6-1 Status Screen

The **Status Screen** shown above (Figure 6-1) displays the active channels simultaneously depending on the transmitter's configuration. This screen, similar to the Dual Channel screen, displays the measurement name and reading, and uses colored cells that flash with new alarms to indicate alarm conditions. Once the alarms have been acknowledged by an operator, the cell will remain the appropriate color but will stop flashing, showing the alarm has been acknowledged.

The four alarm relay states are shown at the bottom of the screen. A red box indicates an energized (de-energized in fail safe) relay.

A thirty minute trend graph is viewable on the right hand side of the screen. Vertical tic marks are each 10% of full scale. Colored lines indicate alarm levels. Since each data point must be collected for several seconds before it may be displayed it is likely input values will fluctuate during this interval. In this case a light blue indicates a minimum value and a brown line indicates a maximum value.

The Status Screen is updated automatically every 15 seconds.



## 6.1.2 EVENT LOG SCREEN

Status	Event Log	Configure	Password (Lock Code): <input type="text"/> <input type="button" value="Login"/>	
			<input type="button" value="Refresh"/>	
	Date	Time	Channel	Event
0	09/24/2014	10:20	-	Conf Edit
	09/24/2014	10:05	2	Fault Out
	09/24/2014	10:05	2	Fault In
	09/24/2014	10:05	2	A2 Out
	09/24/2014	10:05	2	A3 Out
	09/24/2014	10:05	2	A3 In
	09/24/2014	10:05	2	A2 In
	09/24/2014	10:05	2	A2 Out
	09/24/2014	10:04	2	A3 Out
	09/24/2014	10:04	2	A3 In
10	09/24/2014	10:04	2	A2 In
	09/24/2014	10:04	2	A1 In
	09/24/2014	10:04	2	Fault Out
	09/24/2014	10:04	2	Fault In
	09/24/2014	08:32	-	Conf Edit
	09/24/2014	08:31	2	A1 Out
	09/24/2014	08:31	2	A2 Out
	09/24/2014	08:31	2	A3 Out
	09/24/2014	08:31	2	A3 In
	09/24/2014	08:29	2	A3 In

Figure 6-2 Event Log Screen

The **Event Log Screen** displays the last 100 events logged in the BFT-44. The events are logged in a first in first out format, in non-volatile memory.

Logged events include:

1. Alarms/Fault In and Out
2. Alarm and Remote Alarm Resets
3. Alarm Refresh
4. Event Log Cleared
5. Configuration Changed
6. Calibration in and out
7. System and Cold Boots
8. Communication and Configuration Errors
9. Corrupt Sensor
10. Sensor Error
11. Configuration Edits

The events are time and date stamped and if channel specific the number of the channel is shown in the third column in Figure 6-2 above.



### 6.1.3 CONFIGURE

The configuration pages allow viewing and editing of most system parameters. The exceptions are communication and security settings which must be set from the unit's magnetic switch interface. All changes made to the parameters will not be saved until the user has entered the correct login password.

#### 6.1.3.1 RELAY CONFIG

The screenshot shows the "Configure" tab of a web interface. At the top, there are tabs for "Status", "Event Log", and "Configure". To the right of the "Configure" tab is a "Password (Lock Code):" field with a "Login" button. The main content area is divided into three sections: "Standard Relay 1", "Standard Relay 2", and "Standard Relay 3". Each section contains a list of parameters with corresponding dropdown menus or checkboxes. "Standard Relay 1" has Alarm 1 (Ch. 1 only), Alarm 2 (none), Alarm 3 (none), Fault (none), Acknowledge (checkbox), Failsafe (checkbox), and Override (None). "Standard Relay 2" has Alarm 1 (none), Alarm 2 (Ch. 1 only), Alarm 3 (none), Fault (none), Acknowledge (checkbox), Failsafe (checkbox), and Override (None). "Standard Relay 3" has Alarm 1 (none), Alarm 2 (none), Alarm 3 (none), Fault (Ch. 1 only), Acknowledge (checkbox), Failsafe (checkbox), and Override (None). At the bottom of the form are "Reset" and "Save" buttons.

Figure 6-3 Relay Config Screen

The **Relay Config Screen** is shown in Figure 5-3. For information on how to configure the relays, refer to [Section 4.3](#).



6.1.3.2 CHANNEL CONFIG

Status    Event Log    **Configure**
Password (Lock Code):  Login

1 ▾ Ch. Down Ch. Up

**Alarm 1**

Setpoint

Latching

Trip On

On Delay (seconds)

Off Delay (minutes)

Deadband (%)

**Alarm 2**

Setpoint

Latching

Trip On

On Delay (seconds)

Off Delay (minutes)

Deadband (%)

Color

**Alarm 3**

Enabled

Setpoint

Latching

Trip On

On Delay (seconds)

Off Delay (minutes)

Deadband (%)

Color

**Temperature Compensation**

Gain	Offset
<input type="text" value="1.000"/>	<input type="text" value="0.000"/> -40°C
<input type="text" value="1.000"/>	<input type="text" value="0.000"/> -30°C
<input type="text" value="1.000"/>	<input type="text" value="0.000"/> -20°C
<input type="text" value="1.000"/>	<input type="text" value="0.000"/> -10°C
<input type="text" value="1.000"/>	<input type="text" value="0.000"/> -00°C
<input type="text" value="1.000"/>	<input type="text" value="0.000"/> 10°C
<input type="text" value="1.000"/>	<input type="text" value="0.000"/> 20°C
<input type="text" value="1.000"/>	<input type="text" value="0.000"/> 30°C
<input type="text" value="1.000"/>	<input type="text" value="0.000"/> 40°C
<input type="text" value="1.000"/>	<input type="text" value="0.000"/> 50°C
<input type="text" value="1.000"/>	<input type="text" value="0.000"/> 60°C

**Configure**

Channel Enabled

Tag

Engineering Units

Zero

Span

Decimal Places

Deadband (%)

In Cal Output (mA)

**Data From**

Source

Min Raw

Max Raw

Filter Count (seconds)

**Marker**

Marker Enable

Marker Percent

Marker Text

Sensor Life Enabled

**Fault**

Fault Setpoint

Figure 6-4 Channel Config Screen



The **Channel Config Screen** is shown in Figure 6-4. For information on how to configure channels refers to [Section 4.4](#).

### 6.1.3.3 SYSTEM CONFIG

Figure 6-5 System Config Screen

The **System Config Screen** is shown in Figure 6-5. For information on how to configure the system, refer to [Section 4.7](#).

### 6.1.3.4 CONFIG TRANSFER

Figure 6-6 Config Transfer Screen

The **Config Transfer Screen**, Figure 6-6, allows the transferring of system configuration to or from the unit via the webpage. When the download link is clicked, the unit saves the current configuration into a file and transfers it to the user. It should be save as a .cfg file. When uploading configuration, select a .cfg file and press upload. Note that the maximum length of a filename for an uploaded file is 28 characters. After a successful upload, the unit will restart and the webpage will attempt to refresh after 30 seconds.

## 6.2 NETWORK CONNECTION

### 6.2.1 DIRECT CONNECTION WITH CROSSOVER CABLE OR HUB/SWITCH

If a network is not available, or if it is desired to keep the BFT-44 and PC(s) completely separated from other computer, a simple network can be created.



The simplest network can be created by connecting the BFT-44 to a PC directly using an Ethernet crossover cable. Many modern computers have automatic detection/switching on the port. In most cases a normal patch cable can directly connect the BFT-44 to a PC.

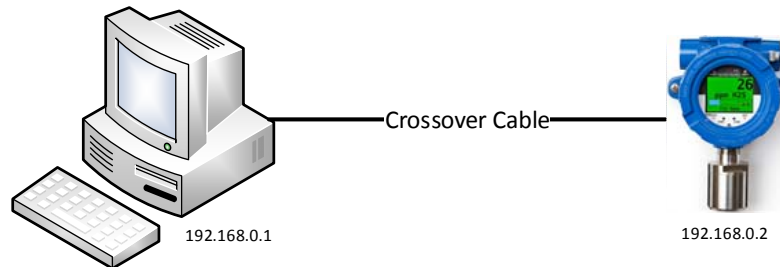

Figure 6-7 Direct Connection with Crossover Cable

If a crossover cable is not available, or if multiple computers need access to the BFT-44, a switch can be connected to the BFT-44 and one or more computer using standard patch cables.

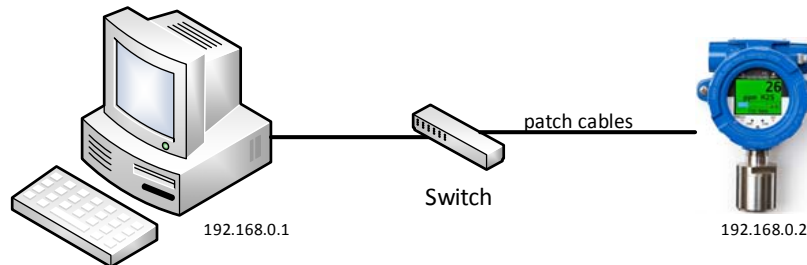

Figure 6-8 Direct Connection with Switch and Patch Cables

These simple networks will not likely have access to a DHCP server. In this case, if the BFT-44 is configured for DHCP, it will automatically select an IP address on the subnet 169.254.x.x. This subnet uses a netmask of 255.255.0.0 and is compatible with the default IP address chosen by Microsoft Windows. Simply connect the PC with a patch cable. Then view the BFT-44 'Communication Settings'-'>'Network Settings' Menu. The IP address field will show a value which can be entered into the web browser to view the webpage.

The recommended option for a permanent network is to set up a static IP on the BFT-44 and any other devices (or computers) on the network (See [Section 6.2.4](#)).





## 6.2.2 CONNECTING THE BFT-44 TO AN EXISTING LAN

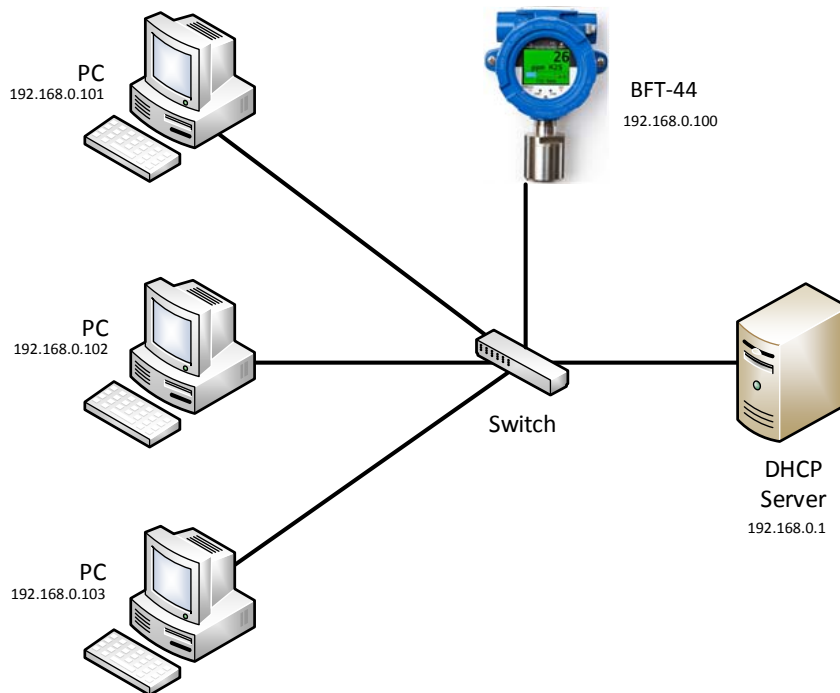

Figure 6-9 Connecting the BFT-44 to an Existing LAN

A typical network will have a DHCP server, a switch (sometimes combined) and several devices connected to that switch. An BFT-44 can normally be added to such a network simply by connecting the Ethernet port to the switch using an Ethernet patch cable. The BFT-44's default settings will allow it to obtain an IP address from the DHCP server. Once this happens, the BFT-44 can be accessed from computers and other devices on the network. Computers access the BFT-44 by hostname, or by IP address.

If more than one BFT-44 is on the network, and if they need to communicate with each other, it is recommended to use a static IP configuration (see [Section 6.2.4](#)). This is because there is a possibility that a dynamic address will be changed by the DHCP server. If the IP address is changed, communication will fail. Static configuration is necessary when using ModbusTCP master or slave mode over TCP/IP.

If accessing the BFT-44 from a computer or other device that can resolve its hostname, dynamic configuration is fine.



### 6.2.3 CONNECTING THE BFT-44 TO AN ISOLATED NETWORK

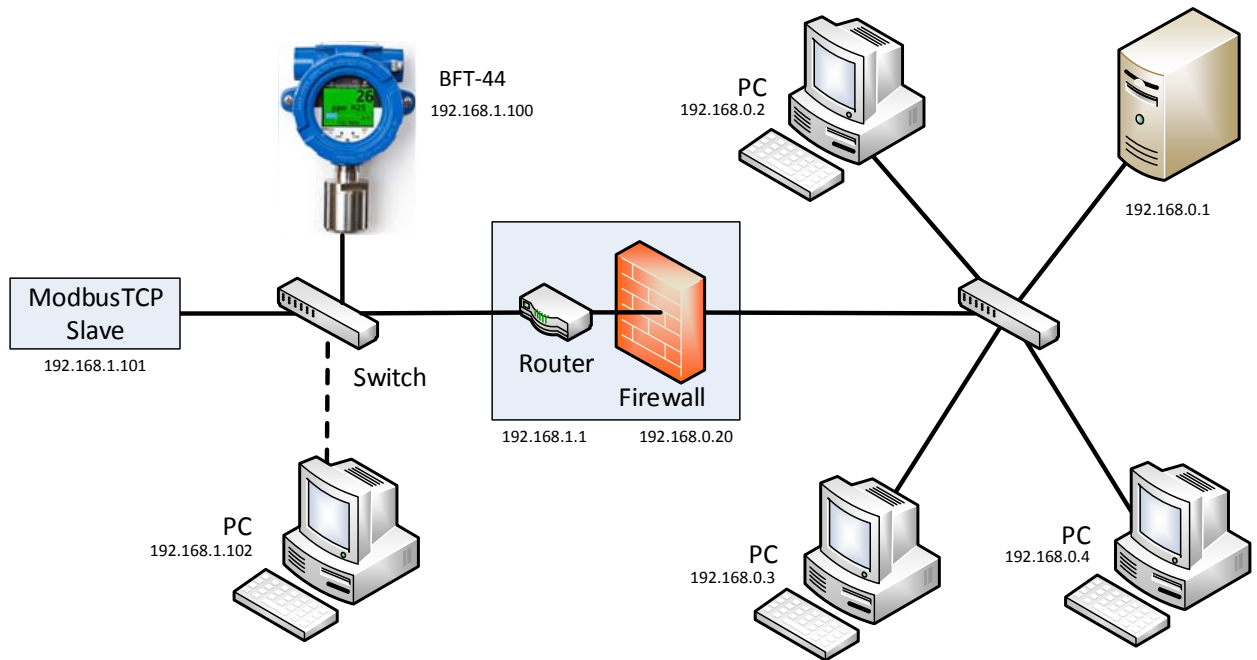

Figure 6-10 Connecting the BFT-44 to an Isolated Network

Another possible network configuration for the BFT-44 involves connecting the transmitter, with ModbusTCP slave devices, and possibly computers on a network. This network can then be isolated from a larger company network using a router/firewall. The isolated network will not see any traffic from the company network unless port forwarding rules are set up in the router. This configuration offers greater security and improved network performance when the company network has a large amount of traffic.

When creating an isolated network, make sure to use a different private IP address range than the outside network. For example, if the main network uses 192.168.0.0 – 192.168.0.255 with a netmask of 255.255.255.0, the isolated network could use 192.168.1.0 – 192.168.1.255 with the same netmask.

Port forwarding rules can usually be configured to only allow certain computers outside the firewall access to the BFT-44. The method for creating forwarding rules is heavily dependent on the router/firewall being used. See router documentation. The IP address or MAC address of the source (outside computer), Incoming port, destination (BFT-44) IP address, destination port, and protocol will need to be set. The source IP address should be set to allow a range or single IP address. Some firewalls can restrict access by MAC address. This can be used instead of or in addition to the source IP address. The protocols for forwarding rules should be TCP/IP. The destination ports should be 80 for access to the web server, and 502 for access to ModbusTCP.



In most cases, a router and firewall will separate the network from the internet. It is not recommended to forward ports from the internet to an BFT-44. In cases where offsite access is needed, a VPN, or tunnel, connection could be used to get inside the network.

## 6.2.4 STATIC IP CONFIGURATION

If you are setting up a Static IPs on a larger company network, make sure to consult your IT administrator to obtain an IP address. The IT administrator can also provide the correct netmask, and gateway. In this case, do not choose your own addresses or you could cause an address conflict with other devices on the network.

### 6.2.4.1 ST-44 STATIC IP CONFIGURATION

On the BFT-44, in the Network Settings Menu, disable DHCP. The IP address should be set to 192.168.0.x where 'x' is any number from 0 to 255. A typical address would be 192.168.0.76. The netmask should be set to 255.255.255.0. The gateway can be left as 0.0.0.0 unless the BFT-44 will be accessing ModbusTCP devices outside a router/firewall. If the BFT-44 needs to poll outside, devices, the gateway IP should be set. This is typically the IP address of a router.

Network Settings	
DHCP Enabled	No
Hostname	Unit-44-1000
Ip Address	192.168.0.76
Netmask	255.255.0.0
Gateway	0.0.0.0

Figure 6-11 Network Settings Menu



After making changes to the Network Settings Menu, a power cycle is required. Make sure to exit the menu before cycling power so that the changes are saved.

### 6.2.4.2 WINDOWS XP STATIC IP CONFIGURATION

These steps are similar but not exactly the same in other versions of Windows.

To connect a PC to a BFT-44 using static IP configuration, the PC must also be configured. First, access the PC's network adapter settings. In Windows XP, this can be found in the Control Panel -> Network Connections. Open the network adapter which is usually called 'Local Area Connection'.

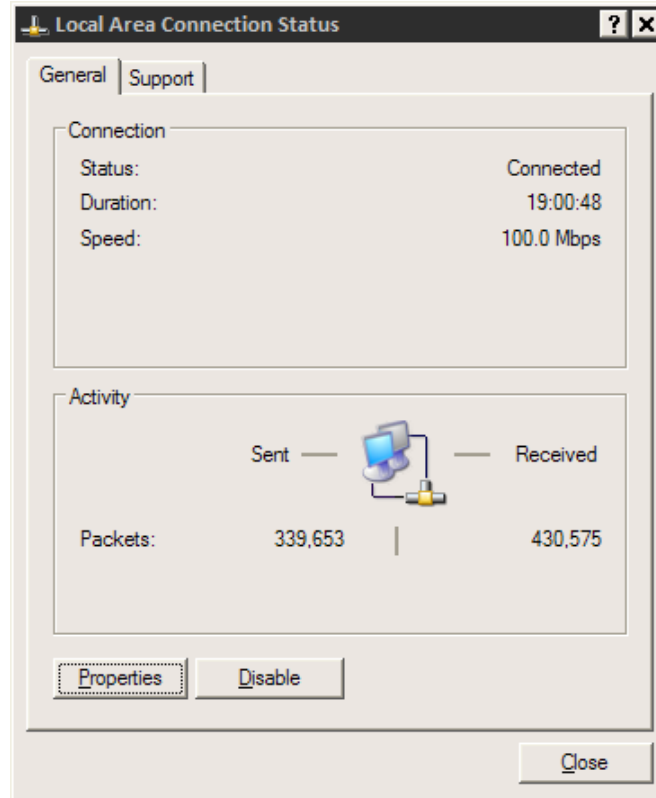

Figure 6-12 Local Area Connection

Click the Properties button.

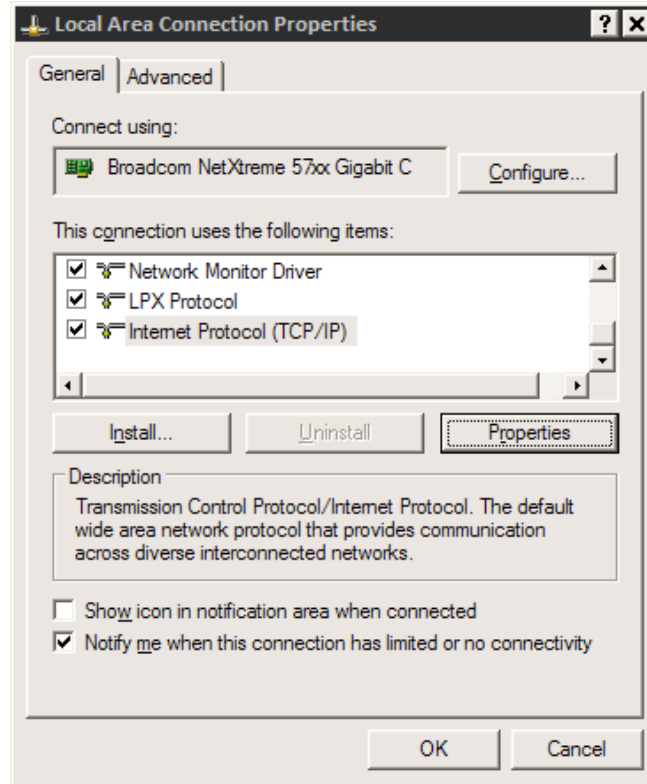

Figure 6-13 Local Area Connection Properties

Select "Internet Protocol (TCP/IP), and then click the Properties button.

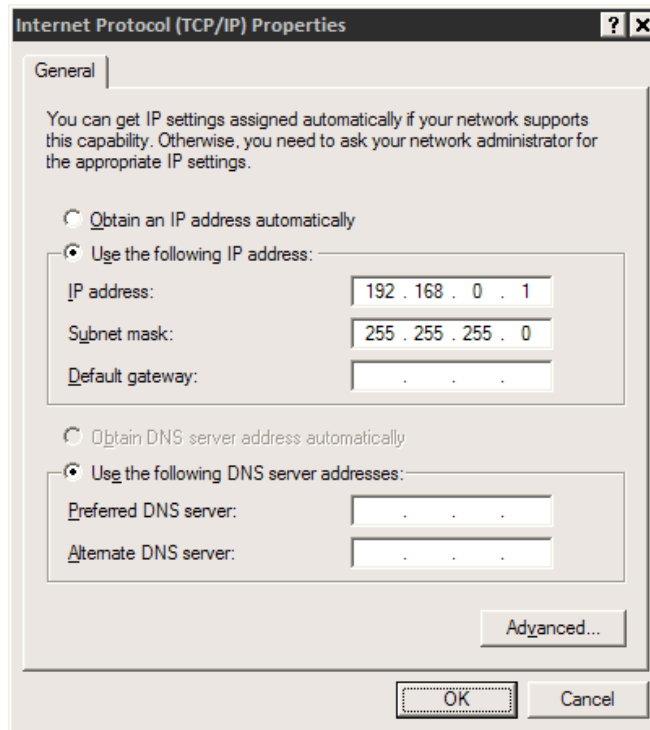

Figure 6-14 Internet Protocol (TCP/IP) Properties

Select "Use the following IP Address". The IP address should be chosen different than the one set on the BFT-44. For the network created in the 'BFT-44 Static IP Configuration', only the last digit can be changed. A typical choice is 192.168.0.1. The subnet mask is set to 255.255.255.0. If a gateway is present, its address should be set; otherwise it can be left blank. Click OK, and the OK again to apply these changes.

### 6.2.4.3 DYNAMIC IP CONFIGURATION

The BFT-44 defaults to use a dynamic IP address. This setting may be used if a DHCP server is available on the network. It is recommended for BFT-44s unless there are multiple BFT-44s that need to communicate to each other.



Network Settings	
DHCP Enabled	Yes
Hostname	Unit-44-1000
Ip Address	192.168.0.72
Netmask	255.255.0.0
Gateway	192.168.0.1

Figure 6-15 Network Settings Menu with DHCP Enabled

To enable dynamic IP, set DHCP to Yes in the Network Settings Menu. Power must be cycled before this change takes effect. Make sure to exit the menu so the settings are saved before cycling power.

A PC will normally have DHCP enabled by default. If not, follow the steps in [Section 6.2.4.2](#), except choose "Obtain IP Address Automatically" in the last step.

### 6.2.5 TESTING CONNECTIONS

To verify that an BFT-44 is accessible, bring up a command prompt. In Windows, this can be found by going to 'Start' -> 'Run'. Then type 'cmd' and press ok. From the command prompt, type ping and then the IP address of the unit. Verify that the 4 reply lines are printed.



### 6.3 RELAY OPTION BOARD BFT10-0388

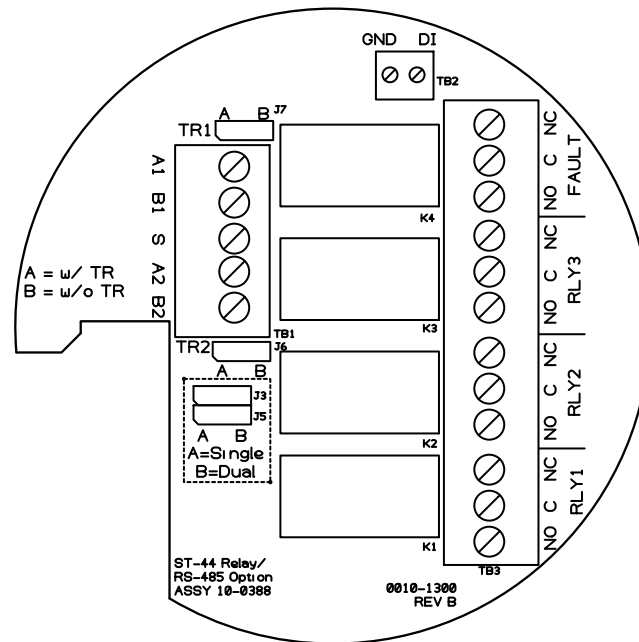

Figure 6-16 BFT10-0388 Relay/RS-485 Option Board

The BFT10-0388 Relay/RS-485 Option Board comes equipped with the following features:

1. (2) RS-485 Modbus Communication ports
2. (3) Programmable relays
3. Dedicated Fault Relay
4. Digital Input

The B10-0388 is installed as a "piggyback" board on the back of the BFT-44's BFT10-0387 CPU/Display Board.

#### 6.3.1 RS-485 MODBUS COMMUNICATIONS PORTS

The two available Modbus Communication ports may be configured to work as a single port or two independent ports by positioning J3 and J5 to the desired position. When the jumpers are installed in the A, or "Single", position, the two ports are tied together to form a single port, e.g. A1 = A2 and B1 = B2. When the jumpers are installed in the B, or "Dual", position, the two ports function independently A1 with B1 and A2 with B2.

Each communication port is configured independently as discussed in [Section 4.5.1](#). For details on Modbus Slave Registers refer to [Chapter 5](#).

RS-485 Modbus networks should be wired as shown in Figure 6-17. Each BFT-44 represents an RTU, and must have a unique Remote ID address. Remote ID addresses are assigned in the Data From Menus discussed in [Section 4.4.1.3](#). Cabling must be a daisy chain as opposed to a star pattern for reliable operation. The "end of line" unit should have J6 and J7 installed in the A position.



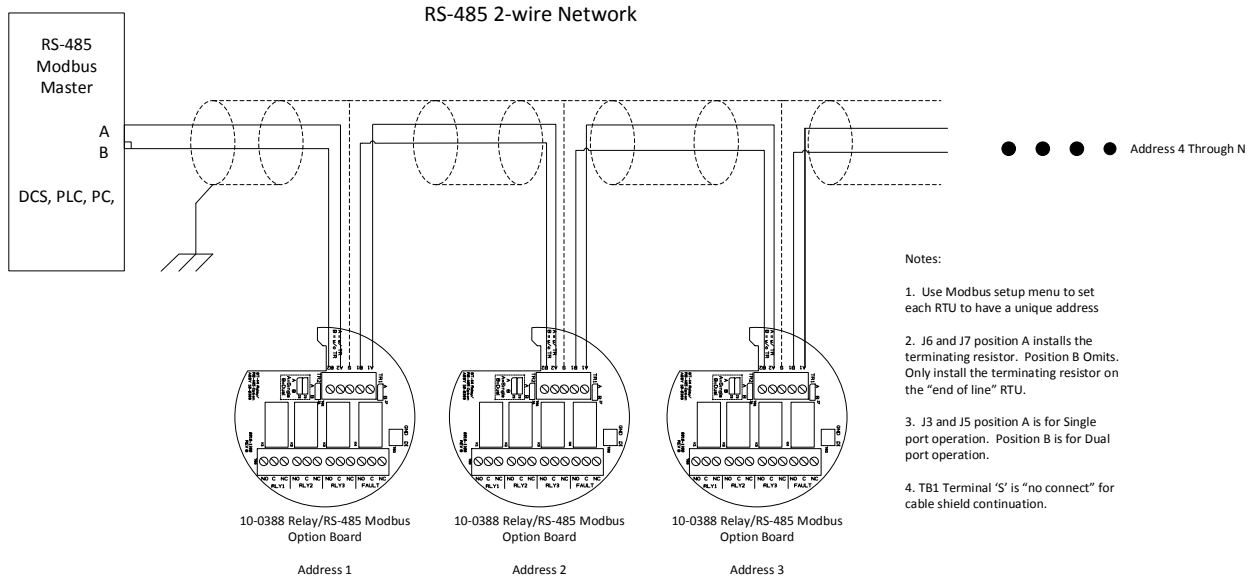

Figure 6-17 RS-485 Modbus Wiring

A convenient diagnostics tool is available to determine proper port configuration, and is discussed in [Section 4.8.5](#).

### 6.3.2 PROGRAMMABLE RELAYS



**Caution:** Alarm relays have dry contacts and power must be supplied from an external source. If this power source exceeds 3 amps, users should consider fusing relay wiring with 3 amp fuses. Contacts are rated for RESISTIVE loads! Inductive loads, such as contactor coils or motors, may cause contact arcing. This will shorten life and emit RFI into the sensor signals. Use appropriate arcing snubber and MOVs across inductive loads, and keep wiring away from signal wires. External wiring to TB2 should be shielded and protected from noise spikes to prevent false alarm resets or overrides.

The relays installed on the BFT10-0388 are Relays are rated as form C 5AMP @ 30VDC and 240VAC RESISTIVE type relays.

Relay terminals are labeled NO (Normally Open), NC (Normally Closed) or C (Common, or pole). These designators correspond to the shelf, or de-energized, state of the relays.

The three programmable relays are configured either locally at the BFT-44 or remotely using the embedded webpage. To configure the relays locally at the BFT-44 transmitter refer to [Section 4.3.1](#). To configure the relays via the embedded webpage refer to [Section 6.1.3.1](#). A convenient diagnostics tool is available for testing relay wiring and operation, and is discussed in [Section 4.8.1](#).



### 6.3.3 FAULT RELAY



**Caution:** Alarm relays have dry contacts and power must be supplied from an external source. If this power source exceeds 3 amps, users should consider fusing relay wiring with 3 amp fuses. Contacts are rated for RESISTIVE loads! Inductive loads, such as contactor coils or motors, may cause contact arcing. This will shorten life and emit RFI into the sensor signals. Use appropriate arcing snubber and MOVs across inductive loads, and keep wiring away from signal wires. External wiring to TB2 should be shielded and protected from noise spikes to prevent false alarm resets or overrides.

### 6.3.4 DIGITAL INPUT

## 6.4 REMOTE SENSOR OPTION BOARD BFT10-2080

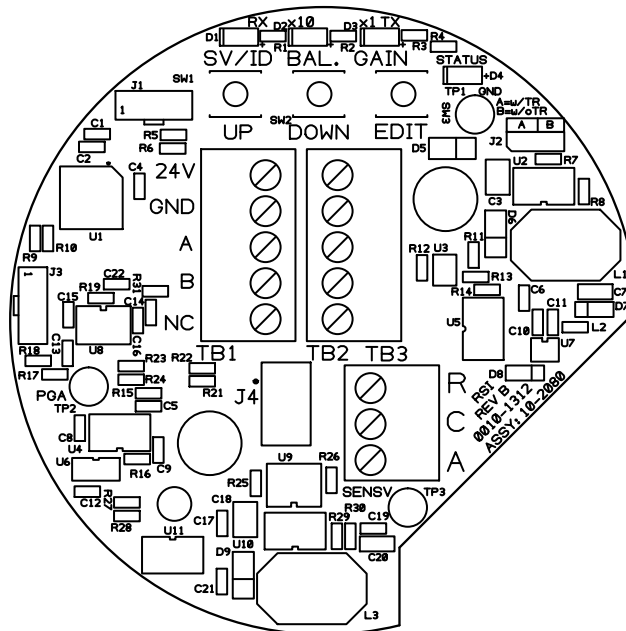

Figure 6-18 BFT 10-2080 Remote Sensor Option Board

Buckeye Detection Systems  
110 Kings Road  
Kings Mountain, NC 28086  
1-800-438-1028  
[www.buckeyefire.com](http://www.buckeyefire.com)  
[bfec@buckeyef.com](mailto:bfec@buckeyef.com)