

MasterCase



User manual

**LEGGI E CONSERVA
QUESTE ISTRUZIONI**

**READ AND SAVE
THESE INSTRUCTIONS**

CAREL
Technology & Evolution



We wish to save you time and money!

We can assure you that the thorough reading of this manual will guarantee correct installation and safe use of the product described.



BEFORE INSTALLING OR HANDLING THE DEVICE PLEASE CAREFULLY READ AND FOLLOW THE INSTRUCTIONS DESCRIBED IN THIS MANUAL.

This device has been manufactured to operate risk-free for its specific purpose, as long as:

it is installed, operated and maintained according to the instructions contained in this manual;
the environmental conditions and the voltage of the power supply correspond to those specified.

All other uses and modifications made to the device that are not authorised by the manufacturer are considered incorrect.

Liability for injury or damage caused by the incorrect use of the device lies exclusively with the user.

Please note that this unit contains powered electrical devices and therefore all service and maintenance operations must be performed by specialist and qualified personnel who are aware of the necessary precautions.

Disconnect the machine from the mains power supply before accessing any internal parts.

Disposal of the parts of the controller:

The controller is made up of metal and plastic parts and contains a lithium battery. All these parts must be disposed of according to the local standards in force.

General warnings - operating environments and connections

The following conditions represent correct installation:

1. do not install the instrument in environments with the following characteristics: wide and rapid fluctuations in ambient temperature; temperature and relative over the allowed limit; exposure to direct pressurised jets of water; high levels of magnetic and/or radio frequency interference (e.g. from transmitting antennae);
2. use cable ends suitable for the corresponding terminals. Loosen each screw and insert the cable ends, then tighten the screws. When the operation is completed, slightly tug the cables to check that they are sufficiently tight;
3. separate as much as possible the signal cables from the cables carrying inductive loads and power cables to avoid possible electromagnetic disturbance. Never insert power cables (including the electrical cables) and probe signal cables in the same conduits. Do not install the probe cables in the immediate vicinity of power devices (contactors, circuit breakers or similar);
4. reduce the path of the probe cables as much as possible, and avoid spiral paths that enclose power devices. To extend the probe cables, use cables with a minimum cross-section of at least 0.5mm²;
5. the cables connected to the contacts on the controller must be rated for the maximum operating temperature, determined by considering the maximum room temperature envisaged, added to the heating up of the controller itself, equal to 20°C;
6. suitably protect the load power lines on the controller with devices (circuit breakers) rated according to the loads connected.

Safety for operators and precautions when handling the controller

To protect the safety of operators and safeguard the controller, before doing any work on the panel always disconnect the power supply. Electrical damage may occur to the electronic components as a result of electrostatic discharges from the operator. Suitable precautions must be therefore be taken when handling these components, specifically:

- before handling any controller, earth yourself (not touching the board does not prevent a spike, as a 10000V discharge, easily reached with static electricity, can produce an arc of about 1cm);
- all materials must be kept inside their original package as long as possible. If necessary, take the controller from its package and place it into an antistatic package without touching the rest of the controller with your hands;
- absolutely avoid non-antistatic plastic bags, polystyrene or sponges;
- do not pass the controller directly to other operators (to prevent from electrostatic induction and discharges).

CONTENTS

1. General characteristics	3
1.1 Main characteristics of MasterCase	3
2. Layout of the hardware.....	5
2.1 Meaning of the inputs and outputs.....	5
2.2 Codes of the models and accessories.....	8
2.3 User interface	9
3. Installation	11
3.1 Electrical connections.....	11
3.2 Configuration of the controllers	11
4. LAN functions.....	14
4.1 Network defrost in multiplexed installations.....	14
4.2 Remote alarm signals.....	14
4.3 Transmission of control signals and probe readings.....	14
5. Setting the parameters	15
5.1 Classification of the parameters	16
5.2 "Password" parameters.....	16
5.3 /= temperature probe management parameters.....	18
5.4 r= temperature control parameters.....	20
5.5 c= times and safety parameters	21
5.6 d= defrost management parameters.....	23
5.7 A= alarm management parameters	27
5.8 F= evaporator fan management parameters.....	30
5.9 H= other settings	31
5.10 LAN parameters	33
5.11 "set point" parameters.....	33
5.12 t= HACCP parameters.....	35
5.13 RTC (Real Time Clock) parameters.....	37
5.14 P= electronic valve (EEV) option (code MGE0000020).....	38
6. Table of parameters	44
7. Alarms	49
7.1 Anomalous or special operation	49
7.2 Description of the signals and alarm codes shown on the display	50
8. Technical specifications.....	53

1. General characteristics

MasterCase is the integrated system designed by Carel for the complete management of showcases.

MasterCase controls and manages the entire refrigeration unit, both electrically and electronically.

The use of power relays means that MasterCase does not require an extra electrical panel, and can directly control the lights, defrost heaters, fans, cooling actuators, and so on.

MasterCase can be connected to a local network to coordinate operations on a group of utilities, synchronising defrosts or sharing probes.

Furthermore, MasterCase can be integrated into the PlantVisor system, which saves and displays all the data on the operation of the unit.

MasterCase is available for the control of showcases with both mechanical expansion valves and in the version with "built-in" driver for the management of proportional electronic expansion valves, which maximises the performance of the refrigeration unit.

The electronic valve optimises the evaporation temperature and superheating, and reduces the power consumption of the unit. Product conservation quality and lower weight loss are ensured by the greater temperature stability and the reduced need for defrosts using MasterCase.

1.1 Main characteristics of MasterCase

Power supply

230V alternating current

Appearance and assembly

The dark plastic container, the narrow, stretched shaped, and the rear supports for DIN rail mounting, make MasterCase ideal for supermarkets and for installation under the showcase.

In addition, the 220Vac power supply and the relay outputs with voltage signals for the various loads (lights, fans, defrost, etc...) mean significant time savings for the wiring and assembly of the electrical panel, the controller itself featuring an integrated electrical panel.

User interface

The user interface is from the series of standard PST terminals. This series, as well as being the same used by other Carel instruments (meaning a reduction in the number of product codes), offers various solutions: display only, small terminal with 3 digits and 3 buttons, and large terminal with 4 digits and 8 buttons. Each button is backlit by a LED to signal the status of the unit (actuators on, alarms, etc...).

The terminals are not required for the operation of the MasterCase, but rather are used to program the controller. The terminals can be installed at a distance of up to 10m from the instrument, and can be connected "live", that is, when the instrument is on, without creating problems in operation.

Energy Savings - Advanced Software

Thanks to the numerous and innovative functions featured, the MasterCase not only controls all the various configurations of the showcases, but also ensures considerable advantages in terms of energy savings. In fact, the use of the night-time set point, the possibility of different types of intelligent defrosts, and the control of electronic expansion valves are just some of the functions that allow significant energy savings to be achieved.

Local network (LAN)

The MasterCase instruments can be connected together to create a LAN (Local Area Network), in master-slave configuration, for the control of multiplexed showcases or multi-evaporator utilities.

Each instrument can be configured as either the master or a slave by simply setting a parameter.

This configuration allows the synchronisation and coordination of defrosts, the signalling of the status of the digital inputs, as well as the display on the master of any alarms active on the slaves.

Up to 6 instruments (1 master and 5 slaves) can be connected together.

The particularly reliable structure of the LAN (16-bit CRC error checking) means the values read by the control temperature and/or pressure probe on the master can be shared across the network, thus allowing a saving in the number of probes required.

Finally, as regards the supervision software, the master acts as the interface for the slaves, as only the master needs to be fitted with the serial card and connected to the RS485 line to be able to manage all the instruments in the local network.

Alarm log

Each unit can save up to 10 alarms. Each new alarm is recorded in the log, deleting the oldest event if necessary.

RTC

The MasterCase can be fitted with an RTC card (with backup battery) for managing the defrosts at set times. In addition, this option allows the use of other functions, such as the setting of a night-time set point starting and ending at set times, the saving of the age of the event in the alarm log, and so on.

Third probe

This is used to measure the temperature at the hot point of the showcase and is used to help determine the reference control temperature. In addition, it can be used to manage the defrost function on a second evaporator.

Duty Cycle setting

This function allows the utility to be operated even when there is a control probe fault. In these cases, operation will continue for a time (in minutes) equal to the value set for the parameter "duty setting" (c4), with a fixed off time of 15 minutes.

Multifunction output

The auxiliary outputs (AUX1 and AUX2) are programmable and can duplicate the function of any of the outputs already present. In addition, they can be used as alarm outputs or hot wire outputs, and can be configured as additional defrost outputs that are independent of the standard defrost output, associated with probe 3..

Multifunction input

A total of five programmable digital inputs are available (see the list of parameters). These allow numerous possibilities, such as the enabling of defrosts, the management of immediate or delayed alarms, the control of a door switch, etc.... In addition, a digital input known as the "virtual" input can be configured, which is not physically connected but rather managed via the local network.

Continuous cycle

The continuous cycle function allows the utility controlled to be forced on for a time set by parameter. This function may be useful when requiring a rapid reduction in temperature, even below the set point.

In-circuit testing

The MasterCase series is manufactured using the most advanced SMD technology. All the controllers undergo "in-circuit testing" to check the components installed..

Probes

The instruments are designed to operate with NTC probes, which offer greater precision across the rated operating range. The pressure probes used are ratiometric. All the probes can be supplied by CAREL.

Electronic valve

An optional card soldered directly onto the main board of the MasterCase (version MGE000020) can be used to control the operation of an electronic expansion valve with stepper motor. This allows the possibility to directly control the injection of refrigerant into the evaporator. Consequently, lower and more stable superheating values can be achieved, as well as a higher evaporation temperature and consequently higher humidity and a more constant temperature in the showcase, guaranteeing better conservation and quality of the products.

Watchdog (Surveillance)

This device prevents the microprocessor from losing control of the unit even in the presence of significant electromagnetic disturbance. In the event of abnormal operation, the watchdog re-establishes the initial operating status.

Electromagnetic compatibility

The instruments comply with the EU standards on electromagnetic compatibility.

CE mark and ISO 9001 certification

The quality and the safety of the MasterCase series instruments are guaranteed by CAREL's ISO 9001 certified design and production system, and by the CE mark on the product.

2. Layout of the hardware

2.1 Meaning of the inputs and outputs

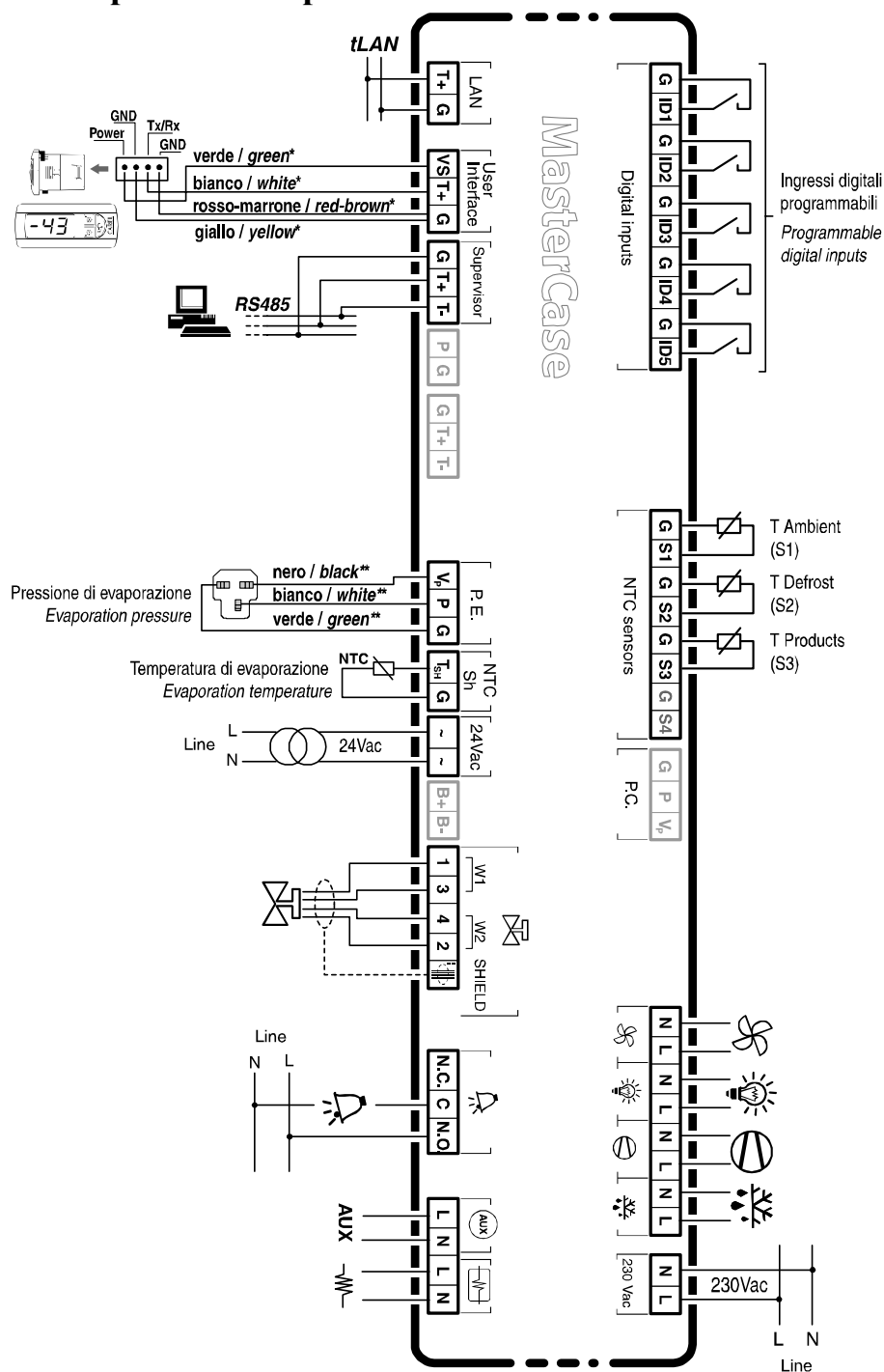

*: The colours refer to CAREL cables, codes PSTCON0300 and PSTCON1000

** : The colours refer to CAREL cables, code SPKC*

Digital inputs

- inputs from voltage-free contacts, with 8mA closing current;
- connection with removable terminals for wires from 0.25 to 2.5mm²;
- maximum length of the cables 30m for standards compatibility (surge);
- the function of the digital inputs can be programmed using the parameters (multifunction inputs);

G-DI1 → Multifunction digital input 1;

G-DI2 → Multifunction digital input 2;

G-DI3 → Multifunction digital input 3;

G-DI4 → Multifunction digital input 4;

G-DI5 → Multifunction digital input 5.

Temperature probe inputs (NTC sensors)

- inputs for standard Carel NTC probes (10 kΩ at 25 °C);
- connection with removable terminals for wires from 0.25 to 2.5mm²;
- maximum length of the cables 30m.

G-S1 → Room probe (S1);
 G-S2 → End defrost probe (S2);
 G-S3 → Third probe (S3);
 G-S4 → Not used.

P.C. (Condensing pressure)

→ **Featured but currently not managed**

**Fan output**

L → Line 4A 250Vac (Inductive Load)
 N → Neutral

**Light**

L → Line 1000VA 250Vac (Fluorescent Lamp)
 N → Neutral

**Compressor**

L → Line 12(12)A 2 Hp, 250Vac (Inductive Load)
 N → Neutral

**Defrost**

L → Line 12A 250Vac (Resistive Load)
 N → Neutral

230Vac

- Power supply input from mains to two removable screw terminals, with max 12A current rating
- minimum recommended cross-section of the wires from 1.5 to 2.5mm².

L → Line 230Vac +10/-15% 50/60 Hz
 N → Neutral 230Vac +10/-15% 50/60 Hz

**Alarm output**

C → Common 12 A 250Vac (Resistive Load)
 N.O. → Normally open (voltage-free contact)
 N.C. → Normally closed

**Auxiliary output (AUX2)**

L → Line 12A 250Vac (Resistive Load)
 N → Neutral

AUX Auxiliary output (AUX1)

L → Line
N → Neutral

12A 250Vac (Resistive Load)

Note for all the outputs:

removable screw terminals for cables with cross-section from 0.25 to 2.25 mm².

Electronic expansion valve

maximum length of the cables 10m;

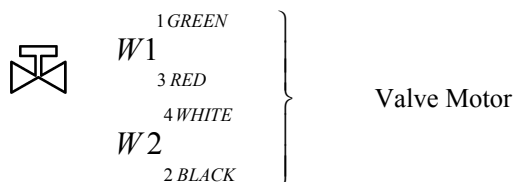

External backup battery

→ **Featured but currently not managed**

24Vac

20VA, 0.5A transformer;

~ → At the transformer 24Vac output

~ → At the transformer 24Vac output

Superheated gas temperature probe (NTC Sh)

Models for electronic valve only (code MGE0000020).

G-Tsh → NTC temperature probe for superheated gas (evaporator outlet)

P.E. (Evaporation pressure)

Models for electronic valve only (code MGE0000020).

for distances greater than 10m use shielded cable (2 wires plus shield connected to earth);

G → Earth (green)**

P → Signal (white)**

Vp → Power supply (black)**

** : *The colours refer to CAREL cables, code SPKC**

RS485 driver

→ **Featured but currently not managed**

PWM

→ **Featured but currently not managed**

Serial line connection (Supervisor)

- Connector for optional RS485 board to interface with supervisor;
- removable screw terminals for cables with cross-section from 0.25 to 2.25 mm²;
- serial speed envisaged 19200 bit/s;

G → Earth

T+ → Connection to the positive of the RS485 serial line

T- → Connection to the negative of the RS485 serial line

Terminals (Interface Display)

- three-wire serial connection, maximum length 10m
- power supply from the controller 24/35Vdc, 1.5 W max.

Vs → Power supply (Power – green)*
 T+ → Signal (Tx/Rx – white)*
 G → Earth (GND – red/brown and yellow)*

*: *The colours refer to CAREL cables, codes PSTCON0300 and PSTCON1000*

LAN (Local Area Network)

- local network connection to other controllers, max length 10m;
- removable screw terminals for wires with cross-section from 0.25 to 2.25mm².

T+ → Signal
 G → Earth

PROGRAMMING KEY

The programming key should only be used when the controller is disconnected from the power supply (220Vac terminals not live), and with the valve driver card powered (in models code MGE0000020 - 24Vac power supply terminals).

The product code of the programming key is PSOPZKEY00.

For details on how to use the key refer to the corresponding instruction sheet.

2.2 Codes of the models and accessories**CONTROLLERS**

CODE	DESCRIPTION
MGE0000010	MasterCase "basic" for showcases with TXV
MGE0000020	MasterCase with EXV driver option

OPTIONS AND ACCESSORIES

CODE	DESCRIPTION
MGEOPZSER0	Serial board
MGEOPZCLK0	Clock board
MGECON0010	Removable connector kit for MasterCase "basic"
MGECON0020	Removable connector kit for MasterCase EXV
PSOPZKEY00	Hardware programming key
PSOPZKEYA0	Hardware programming key with external 230 Vac power supply

USER INTERFACE

CODE	DESCRIPTION
PST00LR200	Large terminal, 8 buttons with red display, IR receiver, buzzer
PST00SR300	Small terminal, 3 buttons with red display, IR receiver, buzzer, 1 input for NTC probes, 2 digital inputs
PST00VR100	Red display, 1 input for NTC probes
PSTCON0300	3m connection cable
PSTCON1000	10m connection cable

2.3 User interface

The MasterCase uses the series of standard PST terminals as the user interface.

This series, as well as being the same used by other Carel instruments (consequently allowing a reduction in product codes), offers various solutions:

- small terminal with 3 digits and 3 buttons (code PST00SR300);
- large terminal with 4 digits and 8 buttons (code PST00LR200);
- remote display with 3 digits (code PST00VR100).

Important: the remote display will only work if one of the two terminals is also connected.

Each button is backlit by a LED to signal the status of the unit (outputs active, alarms, etc...).

The terminals are not required for the operation of the MasterCase, but rather are used to program the controller. The terminals can be connected "live", that is, when the instrument is on, without creating problems in operation.

2.3.1 Functions of the buttons and LEDs on the PJ Large terminal (PST00LR200)

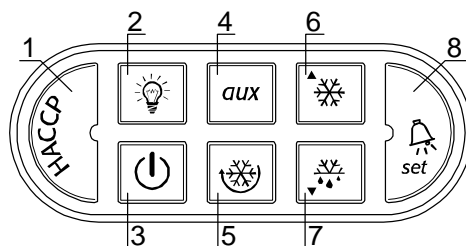

Button ① (red LED)

Normal operation

- pressed for 5 seconds eliminates the HACCP alarm and its signals (codes "HA" or "HF" on the display, the buzzer and the alarm relay) and in addition deletes all the corresponding data saved.

LED

- on steady: HACCP alarm.

Button ② (yellow LED)

Normal operation

- Pressed for 1 second activates /deactivates the AUX1 output relay (light)

LED

- on steady: AUX1 output relay (light) active.

Button ③ (green LED)

Normal operation

- Pressed for 5 seconds unit ON/OFF.

LED

- On steady: controller on.

Note: the ON/OFF function depends on an enabling parameter (if not enabled, the controller is always ON), the LED in any case displays the status.

Button ④ (yellow LED)

No function associated.

Button ⑤ (green LED)

Normal operation

- Pressed for 5 seconds activates or deactivates the continuous cycle.

LED

- on steady: continuous cycle on.

Button ⑥ (green LED)

Normal operation

- Pressed for 1 second switches the light on/off;
- pressed together with button 8 displays the value of the third probe (S3);
- pressed together with button 7 for 5 seconds activates or deactivates the continuous cycle.

Parameter programming

- Passes from one parameter to the next;
- increases the value of the parameter displayed.

LED

- On steady: compressor on;
- Flashing: compressor activation request in progress (cooling request).

Button ⑦ (yellow LED)Normal operation

- Pressed for 5 seconds starts a manual defrost, if the conditions are right;
- pressed together with button 6 for 5 seconds activates or deactivates the continuous cycle;
- pressed together with button 8 displays the value read by the end defrost probe (S2);
- pressed on controller power-up together with button 8 loads the default parameters.

Parameter programming

- Passes from one parameter to the previous;
- decreases the value of the parameter displayed.

LED

- on steady: defrost on;
- flashing: defrost request in progress.

Button ⑧ (red LED)Normal operation

- Mutes the audible alarm (buzzer) and deactivates the alarm relay, if active;
- pressed for 1 second displays and/or sets the set point;
- pressed for more than 5 seconds, with no alarms active, accesses the menu of type F parameters (frequent);
- pressed together with button 6 displays the value read by the third probe (S3);
- pressed together with button 7 displays the value read by the end defrost probe (S2);
- pressed on controller power-up together with button 7 loads the default parameters.

Parameter programming

- Displays the value of the selected parameter or exits the display;
- pressed for 5 seconds permanently saves the modifications made to the parameters.

LED

- on steady: alarm active.

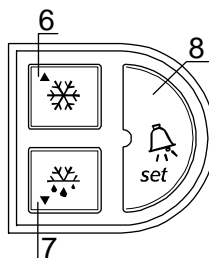
2.3.2 Functions of the buttons and LEDs on the PJ Small terminal (PST00SR300)

As regards the PJ Small terminal, the functions of the buttons are the same as seen for buttons ⑥, ⑦ and ⑧ on the PJ Large terminal.

3. Installation

3.1 Electrical connections

For details on the electrical connections to the main board, see the layout shown above.

WARNINGS

Avoid installing the controllers in environments with the following characteristics:

1. Relative humidity greater than 85%, non-condensing
2. Heavy vibration or shocks
3. Exposure to continuous water sprays
4. Exposure to corrosive or pollutant gases (e.g. sulphur or ammonia fumes, saline mist, smoke) so as to avoid corrosion and oxidisation
5. Strong magnetic and/or radio interference (therefore avoid installing the unit near transmitting antennae)
6. Exposure of the controllers to direct sunlight or the elements in general.

The following warnings must be heeded when making the connections during the pre-installation of the controllers:

1. The incorrect connection of the power supply may seriously damage the system.
2. Separate the probe signal and digital input cables as much as possible from the power and inductive load cables, to avoid possible electromagnetic disturbance. **Never lay the power cables and the probe cables in the same conduits.** Avoid installing the probe cables in the immediate vicinity of power devices (thermal magnetic circuit breakers and the like). Reduce the path of the probe cables as much as possible, and avoid paths that surround power devices. Only use IP67 sensors for the end defrost probe; position the probes with the bulb placed vertically to assist the draining of any condensate. Remember that the thermistor temperature probes (NTC) have no polarity and therefore can be connected in either order.
3. If a connection to the supervisory network is envisaged, connect the shield of the 485 cable to the 485 ground on the instrument.
4. In the MGE0000020 models, if a series of units are installed in the same electrical panel, do not supply the 24 Vac from a common transformer, but rather use a different transformer for each MasterCase.
5. The secondary of the transformers must not be earthed.

3.2 Configuration of the controllers

3.2.1 Parameters directly relating to the hardware

When configuring an instrument that has just been installed, there are a number of parameters that are strictly related to the hardware connections.

These parameters are as follows:

- A1, A2, ..., A5: configuration of the digital inputs;
- /A: probes present;
- /4: virtual control probe (determines which probe is used for the control functions)
- /7: presence of the remote display (determines the presence of the device and which probe is displayed on the remote display)
- H5, H6: configuration of the auxiliary outputs (AUX1 and aux2);
- H7: configuration of the control output (compressor output);
- P1^(*): type of valve;
- Pi^(*): type of pressure sensor;
- PH^(*): type of refrigerant used in the system.

^(*) only for models with the electronic valve control, code MGE0000020

For the meaning and configuration of the parameters, see the corresponding section further on in the manual.

3.2.2 Stand-alone, local network (LAN) and supervisor configuration

There are three fundamental parameters used to configure an instrument for operation in a network (LAN or supervisor) or stand-alone operation: In, H0 and Sn.

In defines the unit as master ($In=1$) or slave ($In=0$);

H0 represents the address of the instrument in the supervisor network, if master, or in the LAN for a slave;

Sn represents the number of slaves present in the LAN (to be set only on the master).

for the master:

- the parameter "In" must be set to 1;
- parameter "Sn" (slave number): from 1 to 5, according to the number of slaves present in the LAN;
- the parameter H0 (Serial address), in the event of connection to a supervisor network, must be set to a value equal to the sum of the address of the previous master plus its number of slaves plus one, that is:

$$H0 = H0_{\text{previous_master}} + Sn_{\text{previous_master}} + 1$$

When switching the instrument on, the display will show "uM", Master unit.

If the instrument is fitted with the RTC card, the following parameters also need to be set:

- parameters "td", "th", "t": day of the week, hour, minute;
- parameters "dx", "hx", "mx" (with $x=1, 2, \dots, 8$): days, hours and minutes corresponding to the defrost times, with 1 minute resolution (for defrosts at preset times).

for the slaves:

- the parameter "In" must be set to 0;
- parameter "H0": address of the slave in the LAN.

When switching the instrument on, the display will show "uSx" (with $x=1, \dots, 5$ - value of "H0").

NOTE: The addresses must be consecutive, always starting from 1.

Example:

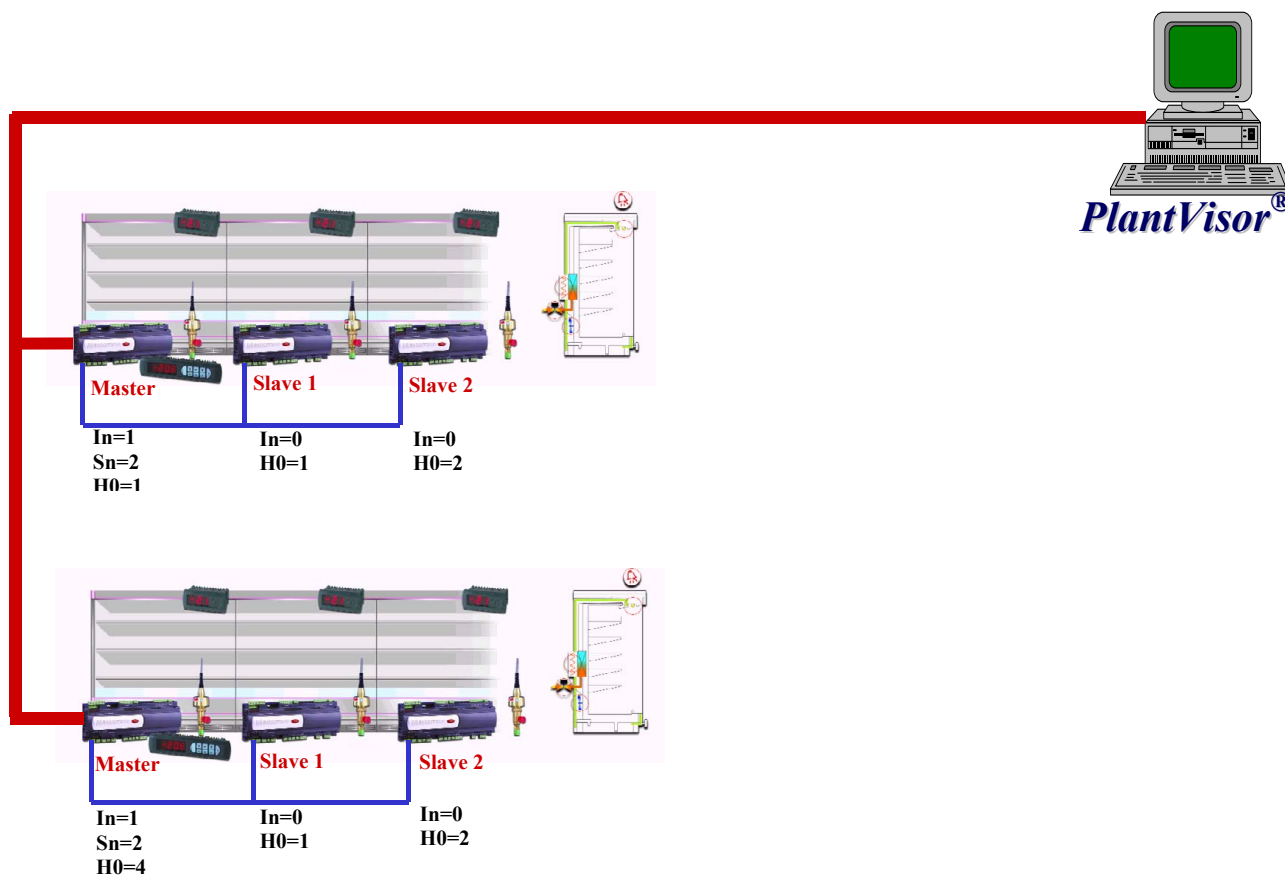

3.2.3 Selecting the main operating parameters





Setting the set point

The set point (parameter "St") is the main parameter, as it represents the reference value for the operation of the instrument.

It is simple to access and set, and this is done separately from the other parameters.

The default set point of the instrument is -20°C.

If this value is not compatible with the application, it can be modified as follows:

- press the  button for one second to display the value of the set point.
The value flashes;
- the value of the set point can be increased or decreased using the  and/or  buttons, until displaying the desired value;
- press  again to confirm the new value.

Parameters relating to the set point

Differential (control hysteresis) – parameter "rd"

The default of this parameter is 2°C.

The value is "RELATIVE", that is, it is related to the set point, being added to this value.

The set point represents the point at which the instrument is switched off, while the activation point (ON) is equal to the **set point (St) + differential (rd)**:

Temperature alarm thresholds – parameters "AH", "AL" and "Ad"

These parameters are used to set the temperature thresholds above which the alarms are activated (activation of the alarm relays and the buzzer on the terminal).

For these parameters too the value is "RELATIVE" to the set point.

AH: high temperature alarm;

AL: low temperature alarm;

Ad: delay time from when the threshold is exceeded to the activation of the alarm, in minutes.

The actual temperature thresholds are determined as follows:

high temperature threshold = set point (St) + AH;

low temperature threshold = set point (St) - AL;

The default values of these parameters are AH= 0 and AL= 0 (alarms not enabled) and the delay is Ad= 120 minutes.

Main defrost parameters

If the instrument is used for managing the defrost function, a number of parameters need to be checked when starting the instrument, in particular:

- dI: interval in hours between defrosts (if set times with the RTC option are not used);
- dP: maximum defrost duration;
- d0: type of defrost;
- dt: end defrost temperature.



3.2.4 Loading the default values of the parameters.

During the installation of the instruments the operating parameters may be set incorrectly.

In other cases, significant electromagnetic disturbance may cause errors on the instrument when saving the data, with the display of the error "EE" (data saving error).

In these and in other cases it may be useful to reset the instrument by assigning the parameters the default values.

To perform this operation, proceed as follows:

- disconnect the instrument from the power supply;
- press Set  and Down  at the same time and switch the instrument back on while holding the buttons;
- when the display shows the combination of characters "-- 3", release the buttons.

At this point the instrument is automatically rebooted and is ready to operate correctly.

NOTE: If the error "EE" occurs quite frequently, the controller should be checked as the memory may be compromised and the initial precision not guaranteed.

4. LAN functions

The MasterCase instruments can be connected together to create a LAN (Local Area Network), in master-slave configuration. The main purpose of the LAN is to allow communication between a series of instruments (maximum six: one master and five slaves) with synchronised operation, for the control of multi-evaporator utilities, such as multiplexed showcases.

Each instrument can be configured as either the master or a slave by simply setting a parameter.

This configuration allows the synchronisation and coordination of defrosts, the propagation of the status of the digital inputs, as well as display on the master of any alarms active on the slaves.

The particularly reliable structure of the LAN (16-bit CRC error checking) means the values read by the control temperature and/or pressure probe on the master can be shared across the network, thus allowing a saving in the number of probes required.

Finally, as regards the supervision software, the master acts as the interface for the slaves, as only the master needs to be fitted with the serial card and connected to the RS485 line to be able to manage all the instruments in the local network.

4.1 Network defrost in multiplexed installations

One of the functions that most requires synchronisation is the defrost function. The master controls the defrosts on all of the slaves connected.

It waits for the defrost to be completed on all of the units before sending the end network defrost signal.

The slaves that have completed the defrost must wait for the end defrost signal from the master before switching to the dripping phase. Once the end defrost signal is received, the slaves go into dripping mode.

The defrost on each single unit and the network defrost are in any case stopped after the maximum defrost time, set using the parameter ("dP", default 30 min.).

The network defrost is performed cyclically, at a programmable interval set for the parameter dI. It can also be started:

- manually (pressing  for 5s on the master);
- at set times (if the RTC option is present).

4.2 Remote alarm signals.

The unit configured as the master in a LAN can signal remote alarms present on the slave units, if enabled by setting the corresponding configuration parameter (parameter Ar = 1). All the masters are enabled for this function as default.

If a terminal or display is not essential for the operation of the unit, and indeed in a LAN the slave can operate perfectly without such user interface, this function is particularly useful for "centralising" the alarm management functions on the master.

If the master detects an alarm on a slave unit (probe error, high or low temperature error, etc....), the display shows the signal "nX" (alternating with the display of the temperature) where X = 1, 2, 3, ... 5, the LAN address of the slave in question. When the event occurs, the alarm relay on the master is activated.

The "nX" signal on the master unit can be inhibited for one minute by pressing .

4.3 Transmission of control signals and probe readings

The particularly reliable and fast structure of the LAN (16-bit CRC error checking) allows the value read by the control probe and/or pressure probe to be sent across the network, allowing savings in terms of both materials installed and installation time.

The transmission of the pressure probe signal must be enabled on the master using the parameter "PA", and the slave must be enabled to receive the signal using the parameter "Pb".

The control probe temperature sent by the master is set on the slaves by setting parameter "/A"=4.

5. Setting the parameters

The parameters have been grouped into two families:



- Frequent parameters (indicated by type F in the parameter tables)
- configuration parameters (indicated by type C), with access protected by a password to prevent unwanted tampering.

The parameters can be programmed as follows:







- from the keypad
- via LAN (download parameters from master to the connected slaves)
- via an RS485 serial connection, if the optional card is fitted.

To set the parameters from the keypad, proceed as follows.

Accessing the type "F" parameters







- press  for more than 5 seconds;
- the display shows the parameter "PP" (Parameter Password);
- press  and  to scroll the parameters.

Accessing the type "C" parameters

- press  for more than 5 seconds;
- the display shows the parameter "PP" (Parameter Password);
- press  ;
- press  or  until displaying 22 (password to access the type "C" parameters);
- confirm by pressing .
- the display shows the parameter "PP" again;
- press  or  until displaying the parameter to be modified.

Modifying the parameters

After having displayed the first parameter, either type C or type F, proceed as follows:

- press  or  until displaying the parameter to be programmed;
- press  to display the value of the parameter;
- modify the value using  and/or .
- press  to temporarily confirm the values saved and return to the display of the parameter code;
- repeat all the operations in the point "Modifying the parameters" to modify the values of other parameters.

Saving the new values:

- press the SET button  for five seconds per save the new value/values entered and exit the parameter modification procedure.

Important: only pressing  permanently saves the temporary values entered during the operation.

If the instrument is switched off before pressing  for five seconds, all the changes made and temporarily saved will be lost.

Exiting the programming procedure

To exit the procedure without modifying the parameters, do not press any button for at least 30 seconds (exit by TIMEOUT). In this way, the instrument returns to normal operation without making any modifications to the parameters.

5.1 Classification of the parameters

The parameters, as well as being divided by TYPE, are grouped into logical categories identified by the first letter or symbol. The following table shows the categories and the corresponding letters/symbols.

Letter/Symbol	Category
/	temperature probe management parameters
r	temperature control parameters
c	safety and control activation time parameters
d	defrost management parameters
A	alarm management parameters
F	evaporator fan management parameters
H	general configuration parameters (addresses, enabling, etc.)
t	clock and HACCP parameters
P	electronic valve management parameters

5.2 "Password" parameters

PP: access level password

The first parameter encountered when entering programming mode is a "password" parameter that allows access to all the parameters of the instrument; if the password is not entered, only the type "F" parameters can be accessed. This prevents access to the "C" parameters by unauthorised persons. Once having accessed the configuration parameters, the type "F" parameter can also be modified. The procedure for accessing and modifying the parameters is described above.

PS: alarm log password

- after having reached the parameter "PS" (Password Log).
- enter 44 as the password for accessing the alarm log
-  for more than 5 seconds to access the log.

ALARM LOG

All models of the MasterCase series feature an alarm log that saves up to 10 events. The models fitted with RTC also allow "the age" of each alarm to be saved, that is, the time in hours that has elapsed from when the alarm was recorded to when the log is accessed.

The following events are saved in the log:

- the high and low temperature alarms ("HI", "LO");
- the control probe error ("rE");
- the end defrost probe error ("E2");
- the defrost by temperature ended by timeout signal, if enabled as an alarm ("Ed");
- the loss of LAN communication by a controller in network, either the master unit or those configured as slaves ("MA" and "ux, with x= 1...5").

Accessing the display of the log

The alarm log is displayed by entering the value 44 for the password parameter "PS" and confirming by pressing the Set button for 5 seconds.



Description of the alarm log

If the alarm log is empty, the display shows three bars (\\\), otherwise the following information is displayed in sequence:

- the index of the alarm in the log, preceded on the left by a graphic symbol;
- the code of the alarm;
- the time elapsed in hours (only for units fitted with RTC) since the event was saved.

If the RTC is not fitted, the time is replaced by the symbol "___".

The three displays are shown cyclically in succession. In the log is scrolled by pressing the arrow buttons:

-  to display the older alarms
-  to display the more recent alarms.

The log can save 10 events. The alarms appear in the log according to the order they were saved in.

When a new alarm is saved, the older alarms are moved back a position in the list. If the log is full, the new alarm deletes the oldest alarm (FIFO logic: First In First Out).

If an alarm has been present in the log for over 199 hours, its age is replaced by the graphic symbol "___".

NOTE: If the current time value is lost on the instrument, the display shows "tC" and the age of all the alarms saved is replaced by the graphic symbol "___".

Exiting the log

Exit the display of the log by pressing  for one second, or alternatively do not press any button for 30 seconds.

Deleting the log

The alarm log can be deleted by pressing and holding  and  together for 5 seconds when the log is displayed. At the end of the operation the controller will exit the display of the log.

Pd: download password

- after having reached the parameter "Pd" (Download Password).
- enter 66 as the password on a master unit with slaves, to download the parameters from the master to the slaves for the configuration of a multiplexed island

- press  for more than 5 seconds to perform the download.

When the temperature is displayed again the download is complete.

DOWNLOAD PARAMETERS

All the MasterCase series instruments feature the possibility of transferring the values of the parameters from the master to the slaves via the LAN. This operation saves time when programming instruments in the same LAN with similar settings. The table below lists the parameters that can be transferred via LAN from the Master to the Slaves.

TABLE OF DOWNLOADABLE PARAMETERS

CODE	DESCRIPTION
/4	Virtual probe (%)
/6	Enable decimal point to display the temperature
/7	Remote display management
/9	Use third probe as end defrost probe
/A	Presence of probes
/t	User interface management
A0	Fan alarm differential
A7	Digital input reading delay time
Ad	Delay in reading high and low temperature alarms
AH	High temperature alarm upper band
AL	Low temperature alarm lower band
c0	Start control delay on power-up
c1	Minimum time between two successive starts
c2	Minimum OFF time
c3	Minimum ON time
c4	Safety control (Duty Cycle Setting function)
c6	Temperature alarm bypass time after continuous cycle
c8	Start control delay from the opening of the valve
cc	Duration of the "continuous cycle"
d0	Type of defrost
d2	Type of control for local network defrost
d3	Compressor operating time with temperature < 1°C before starting a defrost
d4	Defrost when switching the instrument on (YES/NO)
d5	Defrost delay when switching the instrument on
d6	Management of the terminal display and remote display during the defrost
d7	Enable skip defrost
d8	Alarm bypass time after defrost
d9	Defrost priority over compressor safety
dd	Dripping time
dI	Interval between defrosts
dP	Maximum defrost duration
dt	End defrost temperature
F0	Fan management (always on or slave to the fan controller)
F1	Fan set point
F2	Fans off when compressor off
F3	Fans off in defrost
Fd	Fans off in post-dripping
H1	Enable/disable remote control
H3	Enable ON/OFF from the keypad
H4	Enable ON/OFF from supervisor
r1	Minimum temperature set point allowed by the user
r2	Maximum temperature setting
r3	Enable defrost ended by timeout signal
r4	Night-time set point variation
r5	Enable maximum and minimum temperature monitoring
r6	Enable night-time control with the third probe
rd	Control differential
St	Control set point

Download failed signals

The master displays the failure of the download to a slave by showing the signal (alternating with the temperature) "dx", where x = 1, 2, ..., 5, that is, the value of the parameter "H0" corresponding to the slave on which the "data transfer" via LAN operation failed.

5.3 /= temperature probe management parameters

/	PROBE PARAMETERS	Type	Min.	Max.	UOM	Def.	Via LAN
/2	Measurement stability	C	1	15	-	1	
/4	Virtual probe (between S1 and S3) (0= probe 1; 100= probe 3)	C	0	100	-	0	•
/6	Enable decimal point (0= No, 1= Yes)	C	0	1	flag	1	•
/7	Remote display management only if a user terminal is connected 0= not present 1= room probe (S1) 2= end defrost probe (S2) 3= third probe (S3) 4= virtual probe 5= terminal probe	C	0	5	-	0	•
/8	Third probe calibration (S3)	C	-20.0	20.0	°C	0.0	
/9	Defrost also with third probe (S3) 1= the defrost finishes when the temperature of probes S2 and S3 are greater than "dt" (see also parameter "H5")	C	0	1	flag	0	•
/A	Probes present 0= room probe only (S1) 1= room probe (S1) and third probe (S3) 2= room probe (S1) and defrost probe (S2) 3= all present (S1), (S2) and (S3) 4= control probe sent by master (only on the slaves)	C	0	4	-	0	•
/C	Room probe calibration (S1)	F	-20.0	20.0	°C	0.0	
/d	End defrost probe calibration (S2)	C	-20.0	20.0	°C	0.0	
/t	User terminal display management 0= not present 1= room probe (S1) 2= end defrost probe (S2) 3= third probe (S3) 4= virtual probe 5= terminal probe	C	0	5	-	4	•

/C: calibration or offset of the room probe (S1)

The value assigned to this parameter is added to (positive value) or subtracted from (negative value) the temperature measured by probe S1. For example, to decrease the temperature by 2.3 degrees, set /C = -2.3. The offset may be set from -20 to +20 with precision to the tenth of a degree

- *Default: 0.0 (no offset to probe reading).*

/2: measurement stability

Defines the coefficient used to stabilise the temperature measurement. Low values assigned to this parameter offer a prompt response of the sensor to variations in temperature; the reading is however more sensitive to disturbance. High values, on the other hand, slow down the response but guarantee greater immunity to disturbance, meaning a more stable reading.

- *Default: 1.*

/4: virtual probe:

Defines a non-existent probe used for the normal control functions. This parameter determines the weighted average used to calculate the reference control probe value based on the reading of the room probe (S1) and the third probe (S3).

The formula is the following:

$$\text{virtual probe} = \frac{(100 - (/4)) \times S1 + (/4) \times S3}{100};$$

If set to 0, the virtual probe coincides with the room probe (S1); if set to 100, the virtual probe coincides with the third probe (S3). If control is based on the virtual probe (value of parameter "/4" between 0 and 100), the breakage of one of the two probes automatically moves control to the other probe.

- *Default: 0, room probe (S1).*

/6: decimal point

Enables or disables the display of the temperature with resolution to the tenth of a degree, in the range between -9.9 and 99.9 for the version with Small display, and between -99.9 and 999.9 for version with Large display.

0= display without decimal point;

1= display with decimal point.

- *Default: 1, decimal point used.*

/t: display on user interface

Selects the probe reading displayed on the interface terminal

0= Not present

1= Room probe (S1)

2= End defrost probe (S2)

3= Third probe 3 (S3)

4= Virtual control probe (depending on parameter /4)

5= Terminal probe (if present)

- *Default: 4, display virtual probe.*

/7: display on remote display

Selects the probe reading displayed on the remote display:

0= Not present

1= Room probe (S1)

2= End defrost probe (S2)

3= Third probe (S3)

4= Virtual control probe (depending on parameter /4)

5= Terminal probe (if present)

Warning: The remote display (code PST00VR100) only works if a terminal is also connected (code PST00SR300 or PST00LR200).

- *Default: 0, display not present.*

/8: third probe calibration

The value assigned to this parameter is added to (positive value) or subtracted from (negative value) the temperature measured by probe S3. For example, to decrease the temperature by 2.3 degrees, set /8 = -2. The offset may be set from -20 to +20 with precision to the tenth of a degree.

- *Default: 0.0 (no offset to probe reading).*

/9: defrost with probe 3

This parameter allows the third probe S3 to be used as the end defrost probe together with probe S2. In this case, the defrost by temperature ends when the temperature measured by both the probes is greater than or equal to the end defrost temperature (see parameter "dt"). Consequently, probe 3 can be used as a defrost probe on a second evaporator. When programming an auxiliary output as a defrost output, separate and independent management of the defrost on the second evaporator can be enabled by using probe S3 to manage the end defrost temperature (see parameters "H5" and "H6").

- *Default: 0.*

/d: end defrost probe calibration (S2)

The value assigned to this parameter is added to (positive value) or subtracted from (negative value) the temperature measured by probe S2. For example, to decrease the temperature by 2.3 degrees, set /C = -2. The offset may be set from -20 to +20 with precision to the tenth of a degree

- *Default: 0.0.*

/A: probes present

The value of this parameter tells the instrument whether the probes S2 and/or S3 are connected. The value of 4 only makes sense on controllers configured as slaves as, with this setting, the slaves no longer use their own probes for the control functions, but rather use the probe reading sent by the master.

Do not set the value 4 on a controller configured as master

The possible values of this parameter are as follows:

0= defrost probe and third probe absent

1= defrost probe absent and probe 3 present

2= defrost probe present and probe 3 absent

3= defrost probe and probe 3 both present

4= control probe sent by the master (**only for the slaves**).

The room probe (S1) is always considered as being present.

- *Default: 0.*

5.4 r= temperature control parameters

r	CONTROL PARAMETERS	Type	Min.	Max.	UOM	Def.	Via LAN
r1	Minimum set point value allowed by the user	C	-50.0	r2	°C	-50.0	•
r2	Maximum set point value allowed by the user	C	r1	90.0	°C	90.0	•
r3	Enable alarm "Ed" (defrost ended by timeout) 0= No, 1= Yes	C	0	1	flag	0	•
r4	Night-time set point (deviation from set point)	C	-20.0	20.0	°C	3.0	•
r5	Enable maximum and minimum temperature recording 0= No; 1= Yes	C	0	1	flag	0	•
r6	Night-time control with third probe S3 1= night-time control on third probe S3 0= night-time control on virtual probe	C	0	1	flag	0	•
rd	Differential (hysteresis)	F	0.1	20.0	°C	2.0	•
rH	Maximum temperature recorded in the interval "rt" (read-only parameter)	C	-	-	°C	-50.0	
rL	Minimum temperature recorded in the interval "rt" (read-only parameter)	C	-	-	°C	90.0	
rt	Time elapsed since the start of the maximum and minimum temperature recording interval (read-only parameter)	C	0	999	hours	0	

rd: differential

Establishes the value of the differential used in the temperature control.

The operation of this value can be described as follows:

$$\begin{aligned} \text{temperature} > \text{set point ("St")} + \text{differential ("rd")} &\rightarrow \text{controller ON} \\ \text{temperature} \leq \text{set point ("St")} &\rightarrow \text{controller OFF} \end{aligned}$$

The following figure illustrates the concept:

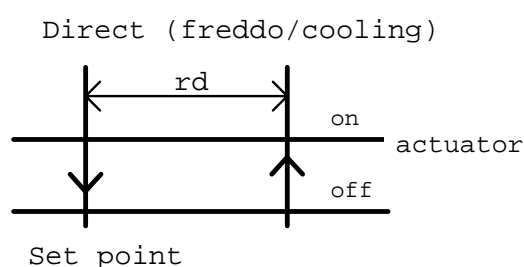

- Default: 2.0.

r1: Minimum temperature setting

Determines the minimum value that can be set for the set point. This parameter prevents the user from setting a set point that is lower than the value indicated by r1.

- Default: -50.0.

r2: Maximum temperature setting

Determines the maximum value that can be set for the set point. This parameter prevents the user from setting a set point that is higher than the corresponding value.

- Default: 90.0.

r3: enable end defrost by timeout signal

Enables the signal indicating the end of the defrost after the maximum time, set for the parameter "dP", using the code "Ed".

0= Signal disabled

1= Signal enabled

- Default: 0.

r4: deviation from the set point

The value set for this parameter will only be effective if the parameter "Stn" is set to 1 or In this case, the set point will change either when a digital input configured as the "curtain switch" is closed (see parameters A1...A5 = 7), or at a set time if the controller is fitted with the RTC option (see parameters "hSn" and "hSd"). The set point varies by the value with sign saved for the parameter "r4", as follows:

$$\text{new_set point} = \text{set point ("St")} + \text{"r4"}$$

- Default: 3.0.

r5: enable temperature monitoring

Enables temperature monitoring, recording the maximum ("rH") and minimum ("rL") temperatures reached in the interval "rt" (max 999h).

r5= 0: temperature monitoring disabled

r5= 1: temperature monitoring enabled on probe S1

The monitoring starts from when "r5" is assigned the value 1.

To disable temperature monitoring, set "r5" to 0. After 199 hours, the maximum monitoring time allowed by the instrument, the max. and min. temperatures are no longer recorded. Set "r5" again to start a new monitoring cycle.

- Default: 0.

r6: control with the third probe from digital input

This is used to move the temperature control to the third probe (S3) when a digital input configured as the "curtain switch" is closed (see parameters A1...A5 = 7).

r6= 0: no movement, control with virtual probe

r6= 1: when the digital input closes control is performed on probe S3

- Default: 0.

rt: temperature monitoring time

Once the temperature monitoring function (parameter "r5") has been enabled, this parameter records the time in hours from the start of the monitoring cycle.

Read-only parameter

- Default: 0.

rH: maximum temperature measured in the time "rt"

Once the temperature monitoring function (parameter "r5") has been enabled, this parameter records the maximum temperature reached since the start of the monitoring cycle.

Read-only parameter

- Default: -50.0.

rL: minimum temperature measured in the time "rt"

Once the temperature monitoring function (parameter "r5") has been enabled, this parameter records the minimum temperature reached since the start of the monitoring cycle.

Read-only parameter

- Default: 90.0

5.5 c= times and safety parameters

c	SAFETY TIME PARAMETERS	Type	Min.	Max.	UOM	Def.	Via LAN
c0	Start control delay from power up	C	0	15	min	0	•
c1	Minimum time between two successive starts	C	0	15	min	0	•
c2	Minimum OFF time	C	0	15	min	0	•
c3	Minimum ON time	C	0	15	min	0	•
c4	Safety control ("Duty cycle setting" function) 0= always OFF 100= always ON	C	0	100	min	0	•
c6	Temperature alarm bypass time after continuous cycle	C	0	15	hours	2	•
c8	Start control delay from the opening of the valve	C	0	120	s	5	•
cc	Continuous cycle duration	C	0	15	hours	4	•

c0: Control start delay when switching the instrument on

This parameter is used to delay, by a set time in minutes, the activation of the control functions from when the instrument is switched on. In multi-utility installations, the parameter "c0" can be used to avoid simultaneous starts of the various units, thus preventing the overloading of the refrigeration system when starting.

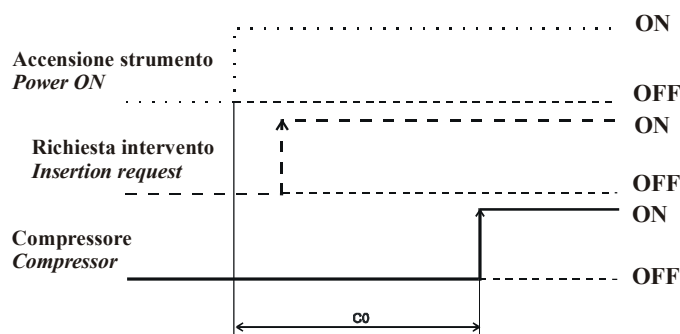

- Default: 0 (minutes).

c1: Minimum time between two successive starts

Sets the minimum time (in minutes) that must elapse between two activations of the controller, irrespective of the temperature and the set point. This parameter can be set so as to limit the number of starts per hour. For example, if the maximum number of starts per hour allowed is 10, simply set $c1=6$ to ensure that this limit is observed.

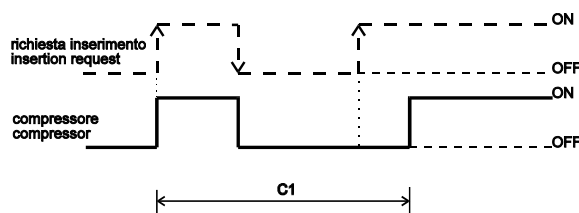

- Default: 0 (minutes).

c2: Minimum OFF time

Sets the minimum controller off time in minutes (compressor output). The compressor output is not reactivated until the minimum time selected ($c2$) has elapsed since the last deactivation. This parameter is useful for ensuring the balancing of the pressure after shut-down, in the case, for example, of systems with hermetic and capillary compressors.

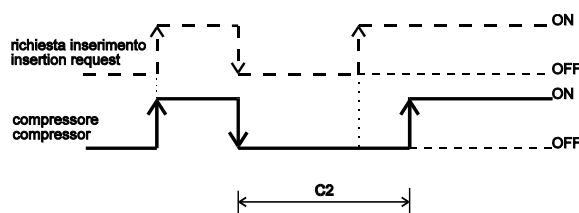

- Default: 0 (minutes).

c3: Minimum ON time

Sets the minimum control on time. The compressor output is not deactivated unless it has been activated for at least the time set.

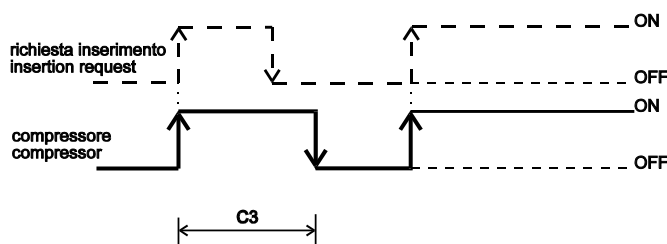

- Default: 0 (minutes).

c4: "Duty cycle setting" function (safety control)

If the "control probe error (rE)" alarm occurs (that is, probes S1 and/or S3 faulty), this parameter allows the controller to keep operating the cooling utility, thus reducing or limiting any damage while awaiting the elimination of the fault. In practice, as there is no longer any temperature control, the controller operates in cycles, with an ON time equal to the value assigned to the parameter "c4" (in minutes) and a fixed OFF time of 15 minutes.

Two values of $c4$ bring about specific situations:

" $c4$ "= 0, control **deactivated** (always OFF);

" $c4$ "= 100, control **always active** (always ON).

If control error occurs while the controller is in a defrost or continuous cycle, it instantly exits the current status and goes into "duty setting" mode.

It should be remembered that, in the event of a control error on a master/slave unit, local or manual defrosts and the continuous cycle functions are no longer available.

A master with a "control probe error (rE)" may, on the other hand, manage the defrosts on the slaves served (network defrost).

After the "Duty Cycle Setting", the temperature alarms are bypassed for 5 minutes.

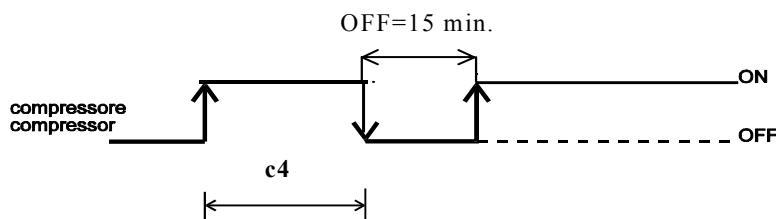

- Default: 0, control always off.

cc: continuous cycle duration

This is the time in hours that the controller is operated continuously for so as to lower the temperature, even below the set point. This function is started manually by pressing the buttons on the user interface. If cc=0, the continuous cycle is disabled. The controller exits the continuous cycle procedure when the time set for the parameter "cc" has elapsed, or alternatively when reaching the minimum temperature threshold set using the parameter "AL **minimum_threshold** = set point - AL).
- Default: 4 (hours).

c8: Start control delay from the opening of the valve

This parameter is used to set the number of seconds that must elapse between the opening of the electronic valve (in models code MGE000020) and the activation of the compressor output (start control).

The purpose is to avoid, above all in non-centralised systems with compressor on board, that the time required for the electronic valve to open is too long for the capacity of the compressor, implying the rapid emptying of the suction line and the consequent safety shutdown due to low pressure.

Any auxiliary output configured as a solenoid valve (parameters "H5" and/or "H6"= 9) will work in parallel with the electronic valve, that is, will open before the activation of the compressor output by the set time for this parameter.

- Default: 5 (seconds).

c6: alarm bypass after continuous cycle

This is the time in hours that the low temperature alarm is ignored, that is, not activated, after a continuous cycle. The low temperature alarm will be generated only if, after a time equal to the sum of "c6" (in hours) + "Ad" (in minutes), where "Ad" is the general delay for the temperature alarm, the temperature is still below the low temperature threshold (set point - "AL").

- Default: 2 (hours).

5.6 d= defrost management parameters

d	DEFROST PARAMETERS	Type	Min.	Max.	UOM	Def.	Via LAN
d0	Type of defrost 0= electric, end by temperature, time as safety 1= hot gas, end by temperature, time as safety 2= electric, end by time 3= hot gas, end by time	C	0	3	-	0	•
d2	Type of control for LAN defrost 0= start only 1= start and stop	C	0	1	flag	1	•
d3	Operating time with temperature of S2 lesser than 1°C before starting a defrost	C	0	192	hours	0	•
d4	Defrost when switching controller on (Yes, No)	C	0	1	flag	0	•
d5	Defrost start delay from controller power-up or on from digital input	C	0	180	min	0	•
d6	Display management during defrost 0= display the temperature alternating with the symbol "dF" 1= hold on last temperature displayed	C	0	1	flag	0	•
d7	Enable skip defrost function	C	0	1	flag	0	•
d8	Temperature alarm bypass time after defrost and/or open door	F	0	15	hours	1	•
d9	Priority of defrost over protection times (par. "c")	C	0	1	flag	0	•
dd	Dripping time	F	0	15	min	2	•
dI	Interval between two successive defrosts	F	0	192	hours	8	•
dM	Time between two successive cleaning cycles (CCM function)	C	1	999	hours	1	
dPM	Cleaning cycle duration (CCM function)	C	0	60	min	0	
dP	Maximum defrost time	F	1	180	min	30	•
dt	End defrost temperature	F	-50.0	30.0	°C	4.0	•

d0: type of defrost

Establishes the type of defrost:

- 0= electric heater, end by temperature or maximum safety time (timeout)
- 1= hot gas, end by temperature or maximum safety time (timeout)
- 2= electric heater, end by time
- 3= hot gas, end by time

- Default: 0, electric heater defrost, end by temperature.

d2: type of defrost control

Determines whether the instrument, in a LAN, at the end of the defrost waits for an end defrost signal or not.

"d2"= 0, the instrument completes the defrost without waiting for the stop signal (stand-alone instrument);

"d2"= 1, the instrument waits, at the end of the defrost, for the stop signal, which is usually sent by the master in a LAN of multiplexed cabinets.

Default: 1.

d3: operating time with evaporator temperature below 1°C before starting a defrost.

Determines how long the controller operates (solenoid valve output/compressor active) when the temperature measured by probe S2 is below 1°C, after which a defrost is performed. To disable this function set the parameter to 0. For temperature values above 1°C and/or when the controller is inactive, the time is not counted. Obviously, the time is managed by an incremental counter that is set to zero only after the set value has been reached and the corresponding defrost performed.

Default: 5 (hours).

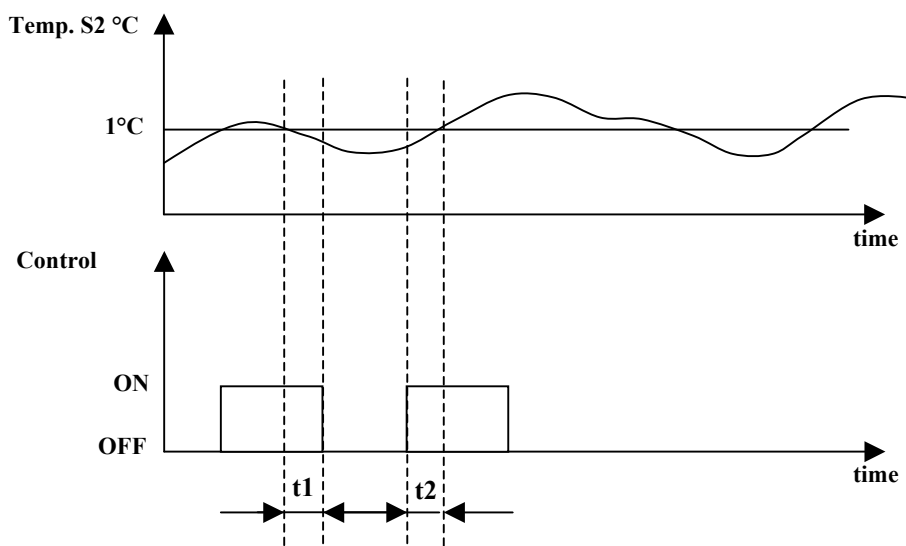

$$t1 + t2 + \dots + tn \geq d3 \rightarrow \text{Start defrost}$$

d4: defrost when the instrument is switched on

Starts a defrost when the instrument is switched on. The possible values are:

0 = no, no defrost is performed when switching the instrument on;

1 = yes, a defrost is performed when switching the instrument on.

This function may be useful in cases where, due to frequent power failures and the consequent resetting of the defrost timer (see parameter "d1"), the number of defrosts performed may be insufficient.

In multi-utility systems, to avoid the simultaneous defrosting of all the units when power returns, set parameter "d5", corresponding to the defrost delay, to different values.

- Default: 0.

d5: defrost delay when the instrument is switched on or from digital input

Represents the delay time in minutes before starting a defrost when the instrument is switched on (as set by parameter "d4") or from a digital input (set with parameters A1...A5 = 3 or 4).

- Default: 0.

d6: user interface and remote display management during defrosts

During the defrosts, two types of behaviour can be set for the user interface and the remote display:

0= display the temperature alternating with the symbol "dF" on both displays;

1= hold both displays on the last value displayed before the start of the defrost.

The display normally returns on both devices after the post-dripping phase (with normal control enabled).

- Default: 0.

SKIP DEFROST

d7: enable "skip defrosts"

This parameter enables the algorithm by which, based on the actual time elapsed during the last defrost, the following defrost is performed or skipped. The following rules are considered:

- the maximum number of consecutive defrosts that can be skipped is 3, that is, after the third defrost skipped, the following one is always performed;
- after switching the instrument on, the first 8 defrosts are always performed;
- the number of events to be skipped is increased by a maximum of 1 at a time;
- the manual defrosts (started on the user interface) or by digital input are always performed and counted;
- the function can only be used with the defrosts that end at temperature ("d0" = 0 or 1).

"d7" = 1 skip defrosts enabled;

"d7" = 0 skip defrosts disabled.

This function is based on a very simple but very effective principle. If the defrost lasts less than or equal to 65% of the time set for the parameter "dP" (maximum defrost time), the next defrost envisaged will be skipped. When the following defrost is performed, the check is repeated, and if the outcome is the same then the following two defrosts envisaged are skipped, and so on according to the criteria described above (maximum 3 successive defrosts skipped).

As soon as the defrost time exceeds 65% of the time "dP", the following defrost will be performed and the function will start again. The following is a graphic representation of the function.

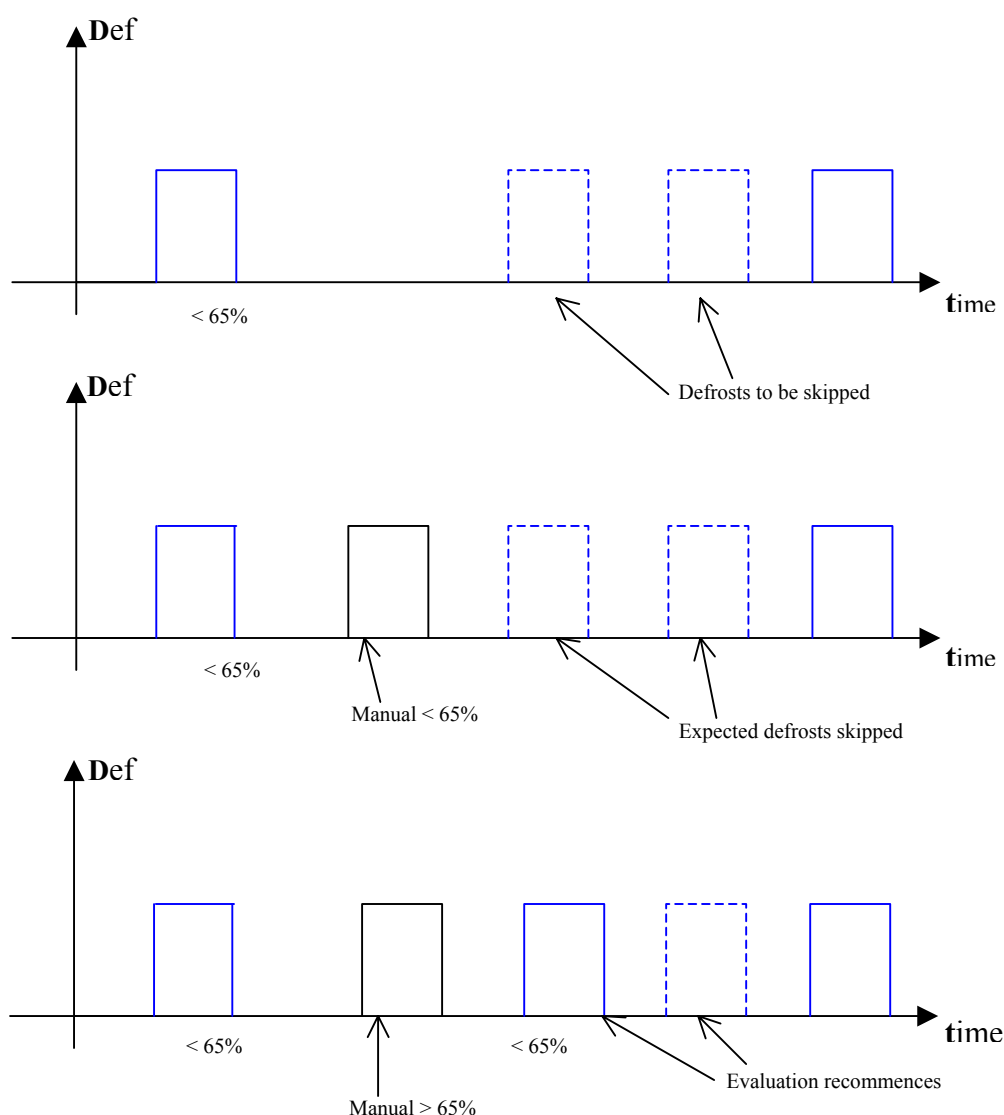

This function should be used with the programming of the defrosts equally distributed over the day (e.g. cyclical defrosts, parameter "dI"). This prevents skipping defrosts that would be the last before a long period programmed without defrosts (for example, when the clock is used to program the defrosting of the utility at night only).

Although this function can be used in combination with the other cases (for example, the function defined by parameter "d3"), it is recommended not to use these functions together so as to maintain better control over the defrosts performed and to be performed.

- Default: 0.

d8: alarm bypass time after defrost and/or door open

Indicates the time the temperature alarm signal is ignored from the end of a defrost and/or after the switching of a digital input configured as the "door switch" (see parameters A1...A5). In the latter case, it also indicates the maximum opening time for the door, in other words, after the set time, if the digital input (door) is still open, the instrument will start the control functions again, with an alarm signal on the display.

- Default: 1 (hours).

d9: priority of the defrost over the safety times and the activation of the control

Cancels the safety times set using the parameters in family "c" when starting the defrost.

0= the protection times are observed;

1= the defrost has higher priority and the times set with the "c" parameters are ignored.

- Default: 0.

dd: dripping time

This parameter is used to set the time in minutes following a defrost in which the controller and the evaporator fans (see parameter "F3") are stopped, so as to allow the evaporator to drip.

- Default: 2 (minutes).

dI: interval between "cyclical" defrosts

The parameter "dI" manages the so-called "cyclical" defrosts, in that they are repeated after the number of hours set for the parameter. The time is reset every time a defrost is performed (including non-cyclical defrosts). If the time "dI" is equal to 0 (dI=0), the cyclical defrosts are disabled. In a LAN, a cyclical defrost on the master also starts a defrost on the slaves connected (network defrost).

- Default: 8 (hours).

CASE CLEAN MANAGEMENT

This function is used to manage the periodical cleaning of the showcase. By setting two specific parameters ("dM" and "dPM") and selecting a digital input (see parameters "A1"..."A5"), the instrument can be programmed to "signal" the need for cleaning and "oblige" the user to intervene.

The instrument enters "standby" status (only after the opening of the digital input), in which the control functions are stopped and the inputs and outputs deactivated.

The function is active only if one of the digital inputs is set as a "case cleaning input" ("Ax"=10).

dM: time between two successive cleaning signals

This parameter is used to set the time in hours (range 1 1000) between one cleaning signal and the next. The time is counted starting from when a digital input is set ("Ax" to 10) or when the instrument is switched on and one of the inputs has already been set to that value. When the time has elapsed, the instrument displays the message "CCM" and the buzzer sounds. The buzzer can be muted in the normal way or by opening the corresponding digital input.

- Default: 1 (hours).

dPM: cleaning signal duration

This parameter is used to set the time in minutes (range 0 60) for the duration of the cleaning signal. When the time "dM" has elapsed, the controller awaits the opening of the digital input associated with this function, and only if the input remains open for a time at least equal to "dPM" will the signal on the display ("CCM") be cancelled and, unless already deactivated manually, the buzzer muted.. At this point, the counter "dM" will start again for the following signal. Otherwise the buzzer will sound again and the signal will remain on the display.

- Default: 0 (minutes).

dP: maximum defrost duration

Determines the duration of the defrost in minutes for defrosts by time ("d0" = 0 or 1). For defrosts by temperature ("d0" = 2 or 3), "dP" represents the maximum safety duration of the defrost, that is, the defrost will in any case stop after the time "dP", even if the end defrost temperature has not been reached.

- Default: 30 (minutes).

dt: end defrost temperature

This parameter is used to set the evaporator temperature measured by probe S2 at which the defrost is stopped. If when a defrost is started ("d0" = 0 or 1) the temperature ready by S2 is greater than the value of "dt", the unit goes directly into the dripping phase. If probe S2 is faulty, the defrost in any case ends after a maximum time (parameter "dP").

- Default: 4.

5.7 A= alarm management parameters

A	ALARM PARAMETERS	Type	Min.	Max.	UOM	Def.	Via LAN
A0	Temperature alarm return and fan activation differential (see parameter F1)	C	0.1	20.0	°C	2.0	•
A1...5	Digital input configuration	C	0	10	-	0	
A7	Alarm delay from digital input (Ax= 2)	C	0	180	min	0	•
A8	Virtual digital input configuration	C	0	10	-	0	
Ad	Temperature alarm delay	C	0	180	min	120	•
AH	High temperature alarm (deviation from the set point)	F	0	20.0	°C	0.0	•
AL	Low temperature alarm (deviation from the set point)	F	0	20.0	°C	0.0	•
Ar	Enable the master to signal the alarms on the slaves (only on the master)	C	0	1	flag	1	

A0: Fan and alarm differential

Represents the differential used to establish the temperature threshold for the deactivation of a high or low temperature alarm ("AL" and "AH") (see the figure below) and for the management of the fans (see parameter "F1").

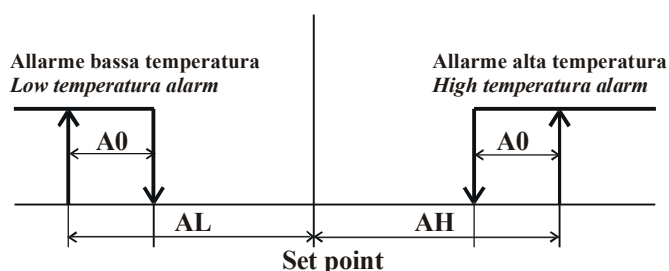

- Default: 2.0.

AH: High temperature alarm

This value is related to the set point. It indicates the maximum deviation allowed from the set point above which a high temperature alarm is activated, indicated by the code "HI" on the display and signalled audibly by the buzzer. In numerical terms:

$$\text{Control temperature} > \text{set point ("St")} + \text{"AH"} \rightarrow \text{HIGH TEMPERATURE ALARM ("HI")}$$

Changing the set point therefore automatically changes the alarm threshold.

The point at which the alarm is deactivated is as follows:

$$\text{Control temperature} \leq \text{set point ("St")} + \text{"AH"} - \text{"A0"}$$

When the alarm condition is no longer present the corresponding audible signal and message the display are automatically cancelled.

- Default: 0.0.

AL: Low temperature alarm

the maximum deviation allowed from the set point set point below which a low temperature alarm is activated, indicated by the code "LO" on the display and signalled audibly by the buzzer. In numerical terms::

$$\text{Control temperature} < \text{set point ("St")} - \text{"AL"} \rightarrow \text{LOW TEMPERATURE ALARM ("LO")}$$

Changing the set point therefore automatically changes the alarm threshold.

The point at which the alarm is deactivated is as follows:

$$\text{Control temperature} \geq \text{set point ("St")} - \text{"AL"} + \text{"A0"}$$

When the alarm condition is no longer present the corresponding audible signal and message the display are automatically cancelled.

It should be remembered that the low temperature alarm threshold is also used in the continuous cycle (see parameter "cc") as the minimum value for stopping the function.

- Default: 0.0.

NOTE: the temperature alarms are not generated in the following cases:

- during a defrost;
- during the continuous cycle.

Ad: temperature alarm delay

Indicates after how many minutes the temperature alarm is signalled from when the corresponding alarm threshold has been exceeded. If the alarm condition is longer present before the time "Ad" has elapsed, no alarm signal is generated. The temperature alarm delay has no effect on two special functions: the defrost and the continuous cycle. To delay a temperature alarm **after** these functions, use the parameters "d8" for the defrost and "c6" for the continuous cycle.

- Default: 120 (minutes).

DIGITAL INPUT CONFIGURATIONS

The MasterCase series instruments feature five digital inputs that can be configured using parameters A1, A2, A3, A4 and A5 (following A1...A5) respectively, associated with the inputs DI1 to DI5. In addition, a further parameter, "A8", is used to manage a digital input called the "virtual" input, as it is not physically present on the instrument, but rather associated with the status of digital input DI1 on the Master in a LAN (master-slave configuration). On a master controller, the input will be associated with a specific signal from the Supervisor, otherwise parameter "A8" will have no function.

The functions corresponding to each value of A4...A5 / A8 are described below:

A1...A5 / A8= 0: digital input disabled

The corresponding digital input is not used and ignores the closing/opening of any contacts connected to it.

A1...A5 / A8= 1: input associated with an immediate external alarm

The digital input can be connected to an external alarm that requires immediate activation (for example, high pressure alarm, etc...). The alarm is generated when the contact is opened, and causes the display of the code "IA", the activation of the buzzer and the total shutdown of the controller and all the related outputs.

When the alarm condition is no longer present, the unit returns to normal temperature control operation.

A1...A5/A8= 2: input associated with a delayed external alarm

The operating mode is the same as for value 1 above, in this case however the alarm signal can be delayed by a time, in minutes, equal to the value set for the parameter "A7".

A1...A5/A8= 3: input associated with a defrost enabling signal

This setting is used to enable/disable the defrost function. When the contact is open the defrost is inhibited, when the contact is closed the defrost is enabled. If the contact is closed, but there is no defrost request, the defrost is obviously not performed. If the contact is closed and a defrost is in progress, when the digital input is opened the current defrost is stopped and the successive defrosts are inhibited, until the next time the digital contact is closed.

Possible applications

This function is useful, for example, in the case of multiplexed showcases with hot gas defrost. In these systems, the defrosts are performed in "islands" and therefore, at any one time, some islands are enabled to defrost, and others are disabled. Another use of the function is to prevent defrosts on the units accessible to the public during opening times.

NOTE: the enabling/disabling of the defrost from a digital contact is effected locally. A master, with A1...A5/A8=3 and with the corresponding digital input open, may not defrost locally, while it may start the defrost on the units served (manual, cyclical or set time defrost).

A1...A5 / A8= 4: input associated with an immediate defrost from external contact

When the corresponding digital input is closed, a defrost is started, according to the criteria set for the type "d" parameters.

Possible applications

This function is useful when defrosts need to be performed on a series of utilities coordinated by an external timer. To avoid simultaneous defrosts, the parameter "d5" can be used to delay the start of the defrost on each unit. Another use of the function is to prevent defrosts on the units accessible to the public during opening times.

NOTE: in the case of a master with slaves, when its own digital contact closes a network defrost will start, even if the master will not defrost locally.

The following drawing explains the above function:

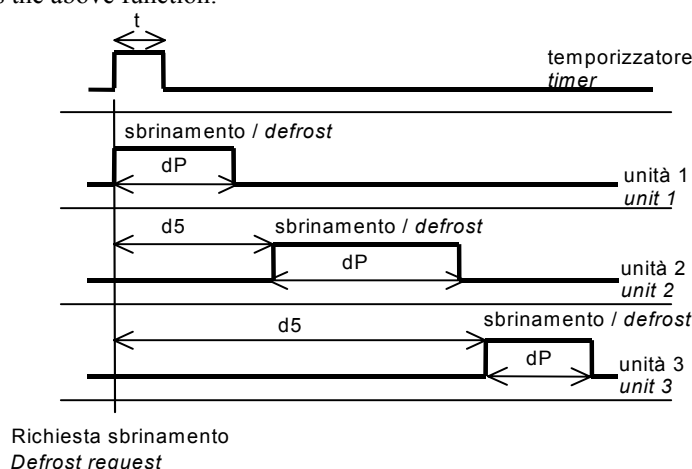

KEY:

t= impulse from the timer to start the defrost: the minimum duration must be 0.5 seconds

dP(1)= maximum defrost duration unit 1

d5(2)= defrost delay from external contact for unit 2. This must be greater than dP(1) otherwise the defrosts will overlap

Similar meanings for d5(3) and dP(3)

A1...A5 / A8= 5: door switch

This function is used to manage the door switch on a cold room. When the contact (door) is opened, the control functions and the fans are stopped and the light output is activated. When the contact closes the unit starts again in the previous operating mode, delaying any temperature alarms for a number of hours equal to the value of the parameter "d8". If the door, and consequently the contact, remain open for a time greater than "d8", the display shows the alarm code "dr" and the controller returns to the operating mode it was in prior to the opening of the door. Specifically:

- if the controller was in Duty Setting mode, it returns to Duty Setting;
- if the controller was in continuous cycle mode, it returns to continuous cycle mode, and the maximum duration of the continuous cycle is extended by the time the door was open;
- if the controller was in defrost mode, it remains in defrost mode;

When the controller is restarted, the set safety times are observed (see type "c" parameters).

A1...A5 / A8= 6: remote ON/OFF

By setting the input for this function the controller can be switched on/off using an external contact.

Contact closed= controller **ON**;

Contact open= controller **OFF**.

Switching off is not equivalent to disconnecting power, but rather is a "logical Off", that is, the controller goes into "standby", ignoring all the digital inputs and outputs, the defrost requests, continuous cycle and Duty Setting. The controller however still continues to display the temperature, alternating with the message "Off". If the instrument that is Off is a master connected to a series of slaves, it is in any case able to manage the network defrost and signal the alarms on the remote units.

A1...A5 / A8= 7: curtain switch

The digital input set to this value is used to activate/deactivate the "light" relay output when the corresponding contact is opened/closed. In addition, if the parameter "Stn" is set to 1, the set point will be varied by the value of the parameter "r4".

A1...A5 / A8= 8: "duty cycle setting" operation

The opening of the contact associated with the digital input set with this value will switch the controller to "duty setting" operation, as described earlier (see parameter "c4").

A1...A5 / A8= 9: door switch with controller ON

The behaviour of the controller when the digital input set to this value is opened is the same as for the "door switch" (An = 5) with the difference that in this case the outputs remain active (ON). This configuration can be used in cases where the door is opened and closed frequently, for short periods (frozen food display cabinets, etc...).

A1...A5 / A8= 10: Case Clean Management

This configuration of the digital input is used to manage the "case cleaning" function, as described earlier (see parameters "dM" and "dPM").

Warning

For the correct management of the functions associated with the digital inputs, the values of A1...A5, A8 must be different from one another, or alternatively must be equal to zero. That is, if A1...A5, A8 are assigned values other than zero, the following must be true: $A1 \neq \dots \neq A5 \neq A8$.

- Default: 0.

A7: external alarm detection delay

Sets the delay (in minutes) relating to the external alarm from digital input when A1...A5 / A8= 2.

- Default: 0 (minutes).

Ar: enable the master to signal the alarms on the slaves

This parameter allows the master unit to be enabled to display the presence in its LAN of one or more slaves with alarms. If an alarm is activated on a slave, on the master the display shows the signal "nx" alternating with the temperature, where x is the address of the slave in question (x = 1, ..., 5). This type of alarm also activates the buzzer and the alarm relay.

"Ar"= 0, function disabled;

"Ar"= 1, function enabled.

- Default: 1.

5.8 F= evaporator fan management parameters

F	FAN PARAMETERS	Type	Min.	Max.	UOM	Def.	Via LAN
F0	Fan management 0= fans always on (except cases F2, F3, Fd) 1= fans controlled according to absolute set point F1	C	0	1	flag	0	•
F1	Fan off time	F	-40.0	50.0	°C	5.0	•
F2	Fans off when control inactive (0= No, 1= Yes) <i>active only with F0= 0</i>	C	0	1	flag	1	•
F3	Fan management during defrost	C	0	2	-	1	•
Fd	Fan off time during post-dripping	F	0	15	min	1	•

F0: fan management

The fans can be managed by the "fan controller", which manages them according to the temperature measured by the end defrost probe S2 (see parameter "F1"), or alternatively can be always on, and stop when the controller is switched off (see parameter "F2").

"F0"= 0, fans managed based on the parameter "F2";

"F0"= 1, fans subject to the "fan controller " (see parameter "F1").

It should be remembered that if a dripping phase (see parameter "dd" ≠ 0) and/or post-dripping phase (see parameter "Fd" ≠ 0), is set, the fans are always off in these phases.

- Default: F0=0.

F1: (absolute) fan control set point (parameter valid only if F0=1)

The fans are controlled according to the following formula:

Temperature S2 < "F1" - "A0" → fans ON;

Temperature S2 ≥ "F1" → fans OFF.

- Default: 5.

F2: fans off when the controller is off (parameter valid only if F0=0)

This is used to decide whether the fans must be always on (except in cases "F3", "dd" and "Fd") or only when the controller is on.

"F2"= 0, no, fans always ON;

"F2"= 1, yes, fans off when controller off.

- Default: 0.

F3: fan management during defrost (parameter always valid)

This is used to decide whether the fans must be on or off during the defrost and during the dripping phase.

"F3"= 0, fans on during the defrost.

During the dripping wait (in the case of master-slave network defrost) and dripping times (if set by the parameter "dd") the fans are always off.

"F3"= 1, fans off during the defrost.

"F3"= 2, fans always on, during the defrost and also during dripping.

This is useful in the applications where the fans must always be on, yet a "pause"/dripping time is required after defrosting.

During the dripping wait (in the case of master-slave network defrost) and dripping times (if set by the parameter "dd") the fans are always on.

If a post-dripping time has been set (parameter "Fd" ≠ 0), during this time the fans are always off.

- Default: 1.

Fd: fans off in post-dripping

Indicates the time (in minutes) after the dripping phase (see parameter "dd"), known as the "post-dripping" phase, that the fans stay off for, even if the controller, and thus the power supply to evaporator, have already restarted. This is useful to allow the evaporator to return to the normal operating temperature after defrosting and to freeze the remaining moisture and droplets, thus avoiding wetting the goods inside the showcase when the fans are started.

- Default: 1 (minutes).

5.9 H= other settings

H	CONFIGURATION PARAMETERS	Type	Min.	Max.	UOM	Def.	Via LAN
H0	Serial address	C	0	199	-	1	
H1	Enable use of the remote control (<i>Infrared</i>)	C	0	1	flag	0	•
H2	ID code for using the remote control	C	0	99	-	0	
H3	Enable ON/OFF button on terminal	C	0	1	flag	1	•
H4	Enable ON/OFF from supervisor	C	0	1	flag	0	•
H5	Configuration of AUX1 output	C	0	9	-	0	
H6	Configuration of AUX2 output	C	0	9	-	5	
H7	Configuration of compressor output (only on the master)	C	1	2	-	1	

H0: serial address

Assigns the instrument an address to which it responds when connected to a supervisory or telemaintenance system. It is also used for the serial connection or network connection.

In a master-slave LAN configuration, for the slaves it represents the local address (from 1 to 5) in the LAN.

Make sure that if a series of Masters with their own LANs are connected to a supervisor network (RS485), the address of each master must be set considering the number of slaves present in the previous LAN. This concept is expressed by the following formula:

$$\text{"H0"} = \text{"H0"}_{\text{previous_master}} + \text{"Sn"}_{\text{previous_master}} + 1 - \text{Default: } 1.$$

H1: enable/disable remote control

Enables the use of the infrared remote control.

- Default: 0.

H2: remote control enabling code

This is used to enter a code to distinguish, when programming from the remote control, between various controllers located in the same area..

- Default: 0.

H3: enable ON/OFF from the keypad

Enables or disables the ON/OFF button on the user interface..

"H3"= 0, ON/OFF button disabled;

"H3"= 1, ON/OFF button enabled.

- Default: 1.

H4: enable ON/OFF from supervisor:

Enables or disables the remote ON/OFF from the supervisor.

This parameter has priority over the previous one, and consequently if the ON/OFF from supervisor is enabled (H4= 1), the ON/OFF button on the terminal is disabled irrespective of the value of H3.

"H4"= 0, remote ON/OFF from the supervisor disabled;

"H4"= 1, remote ON/OFF from the supervisor enabled.

- Default: 0.

H5: AUX1 configuration

This is used to configure the auxiliary output as a repeat of any one of the other outputs. Specifically:

"H5"= 0, output disabled;

"H5"= 1, compressor output;

repeats the operation of the main control output (symbol \ominus);

"H5"= 2, master/slave network compressor output;

this configuration must only be used on the Master unit. The output will be active while any of the units in a master/slave network (LAN) have a cooling request in progress;

"H5"= 3, light and/or curtain output;

"H5"= 4, fan output;

"H5"= 5, hot wire output (rail heat);

the output is always active except for when the control is in standby;

"H5"= 6, alarm output;

"H5"= 7, evaporator 1 defrost output;

manages a second defrost output that works in parallel with the main defrost output;

"H5"= 8, evaporator 2 defrost output;

in association with the setting of parameter "/9" = 1 (defrost with probe S3), a second defrost output can be managed, **independently** of the main output and related to the value read by probe S3. It can therefore be used to control an electric defrost heater on a second evaporator.

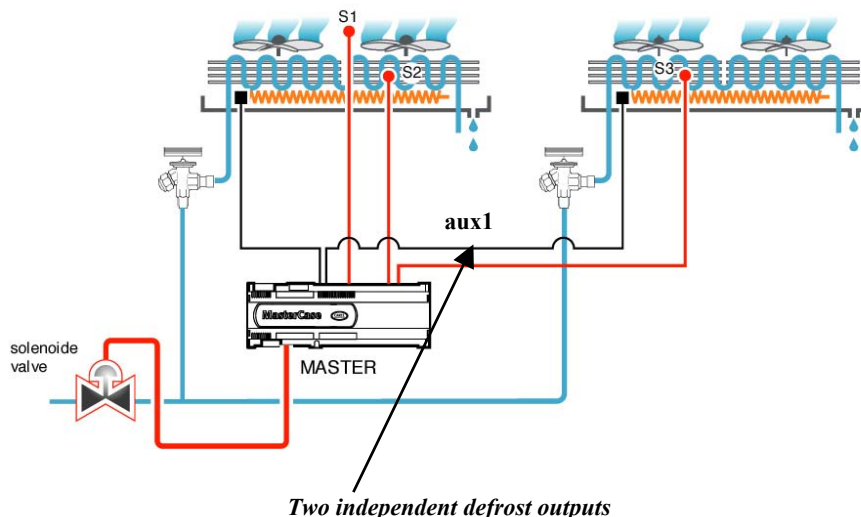

"H5"= 9, ON/OFF valve output (solenoid);
 works in parallel with the controller and can be used to control a solenoid valve;
 - Default: 0.

H6: AUX2 configuration

Same as parameter "H5". As default this output is configured for the control of the hot wire (rail heat).
 - Default: 5.

H7: compressor output configuration ⊖

This parameter is to be used only on the unit configured as the master.

"H7"= 1, compressor output (⊖).

The output will work in the traditional mode, that is, based on the control status of the unit.

"H7"= 2, master/slave network compressor output.

The output will be active while any of the units in a master/slave network (LAN) has a control request in progress. This configuration can be used in cases where a multiplexed cabinet or multi-evaporator utility has only one solenoid valve (or one compressor). In this case, simply connect the solenoid valve or the compressor to the master compressor output to manage the unit correctly.

Note that in this case any electronic valves managed by the Master unit will be closed or opened based on the control conditions and consequently independently from the compressor output.

- Default: 1.

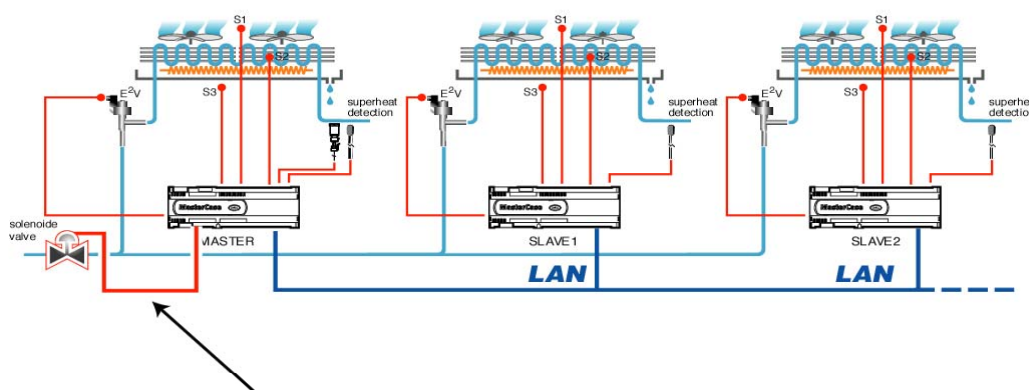

Connection of the solenoid valve (or compressor) to the master only

5.10 LAN parameters

	LAN PARAMETERS	Type	Min	Max	UOM	Def.
Sn	Number of slaves (only on the master) 0= LAN not present	C	0	5	-	0
In	Unit configuration, master or slave In= 1, Master unit In= 0, Slave unit	C	0	1	flag	0

Sn: number of slaves

This parameter is only valid on the controllers configured as the master (parameter "In" = 1) and is used, in a LAN, to tell the master controller how many slaves it must manage..

- Default: 0.

In: master/slave configuration

The value of this parameter configures the unit as the master or a slave. When the controller is started, the display will show "uM" (**Master unit**) if "In" = 1, or "uSx" (**Slave unit** number x, x = 1 ... 5: address of the slave in the LAN) if "In" = 0.

"In"= 1, unit configured as master;

"In"= 0, unit configured as slave.

- Default: 0.

Suggestions

- During the installation of a LAN make sure that the values of H0 on the various units are all different;
- the value assigned to H0 on any slave must not be higher than the value of "Sn" on the master;
- a LAN must not have more than one unit configured as master;
- the addresses of the slaves must be consecutive.

5.11 "set point" parameters

	SET POINT PARAMETERS	Type	Min.	Max.	UOM	Def.	Via LAN
St	set point - operating temperature	F	r1	r2	°C	-20.0	●
Stn	Select night-time set point mode	C	0	2	-	0	
hSn	Night-time set point start time	C	0	23	hours	0	
hSd	Night-time set point end time	C	0	23	hours	0	
SL1	Absolute minimum temperature, probe S1 SL1= 90°C function disabled	C	-50.0	90.0	°C	90.0	

St: temperature set point

Represents the reference control temperature.

See the paragraph dedicated to this parameter.

- Default: -20.0.

Stn: select "night-time" set point mode

Parameter Stn can be used to configure the automatic changeover of the set point.

The following values are available:

"Stn" = 0, no night-time set point.

No digital input programmed as a curtain switch ($Ax \neq 7$) \Rightarrow no action.

Digital input programmed as a curtain switch ($Ax = 7$) \Rightarrow when the status of the digital input changes, **only** the light output will be activated (action propagated across the LAN from the master to the slaves). No variation of the set point.

"Stn" = 1, set point change from digital input.

No digital input programmed as a curtain switch ($Ax \neq 7$) \Rightarrow no action.

Digital input programmed as a curtain switch ($Ax = 7$) \Rightarrow when the status of the digital input changes, the following will occur:

- activation of the light output (action propagated across the LAN from the master to the slaves.);
- change in the set point according to parameter "r4";
- change of control to the third probe (S3), according to parameter "r6".

“Stn” = 2, change from RTC.

If the controller is fitted with the RTC option, the set point can change from the daytime to the night-time value and vice-versa by setting two time bands (see parameters “hSn”, hSd” and the figure below). The actions carried out will be the same as described in the previous point (“Stn”=1 and Ax=7).

If a digital input is programmed as a curtain switch (Ax = 7), the change in the status of this input will **only** change the status of the light output.

- Default: 0.

hSn: Night-time set point start time

If the night-time set point from RTC is used (“Stn”=2), this parameter indicates the time when the set point changes (see parameter “r4”), along with the change in the reference probe, if set (see parameter “r6”).

See the figure below.

- Default: 0.

hSd: Night-time set point end time

If the night-time set point from RTC is used (“Stn”=2), this parameter indicates the time when the function and any related actions end.

See the figure below.

- Default: 0.

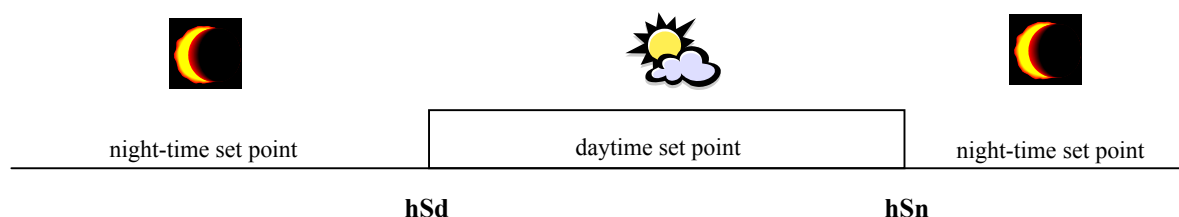

MINIMUM AIR OUTLET TEMPERATURE ALARM

This function should be used when the controller is set to use the "virtual probe" (parameter "/4" ≠ 0 and ≠ 100).

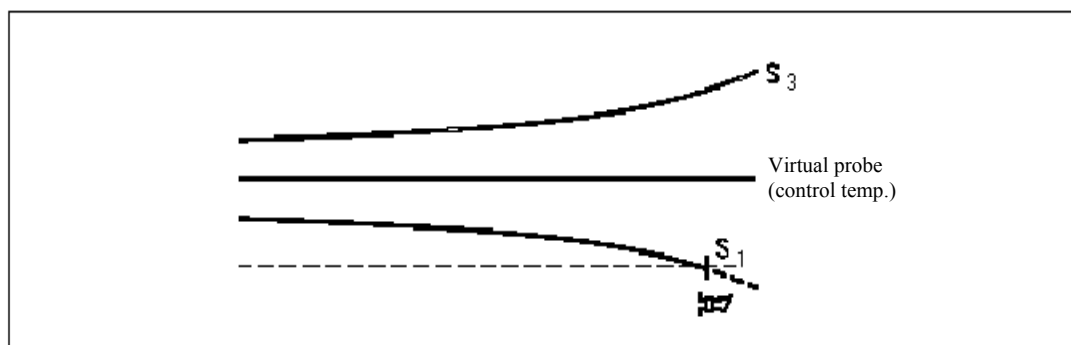

In this case, in fact, the temperature control is based on a "weighted" value of the two probes (S1 and S3). This means that despite the fact that the reference is constant, the temperature of the two probes may in reality differ significantly, with the risk of having an evaporator air outlet temperature (that is, the air that comes into contact with the product) that is dangerously low.

SL1: minimum temperature for probe S1

If the temperature read by probe S1 falls below the minimum value "SL1", the controller is stopped and an alarm is activated (code displayed => "L01"). When the temperature increases by 2°C above "SL1", the controller restarts and the alarm is reset.. If the value of the parameter "SL1" is equal to the maximum limit (90.0°C) and/or the parameter "/4" is set to 0, the function is disabled.

- Default: 90.0.

5.12 t= HACCP parameters

t	HACCP PARAMETERS	Type	Min.	Max.	UOM	Def.	Via LAN
tr	HACCP alarm delay 0= HACCP disabled	C	0	180	min	0	
tA	Type of HACCP alarm (read-only parameter) 0= no alarm 1= HA alarm 2= HF alarm	C	0	2	-	0	
tO	Weekday of the most recent HACCP alarm (read-only parameter)	C	0	7	day	0	
tH	Hour of the most recent HACCP alarm (read-only parameter)	C	0	23	hours	0	
tM	Minutes of the most recent HACCP alarm (read-only parameter)	C	0	59	min	0	
tt	Maximum temperature reached during the most recent HACCP alarm (read-only parameter)	C	-50.0	90.0	°C	-50.0	
tE	Duration of the HACCP alarm (read-only parameter)	C	0	240	hours	0	
to	Delete the data saved and the HACCP alarm	C	0	1	flag	0	

HACCP

This function allows advanced control of the operating temperature and the recording of any faults due to power failures or increases in the operating temperature for various reasons (faults, severe operating conditions, user errors, etc...).

This function can only be activated on the controllers with the RTC option inserted.

Two types of HACCP alarm are featured, identified on the display with the following codes respectively:

"HA" - if, during operation, the temperature measured is greater than the threshold represented by the sum of the parameters "AH" (high temperature alarm threshold) and "St" (set point), for a time greater than the sum of the parameter "tr" (specific for the HACCP alarms) and the parameter "Ad" (temperature alarm delay), the alarm HA is activated. When the event occurs the following data are saved::

- hour, minutes and weekday;
- type of alarm;
- maximum temperature reached after the activation of the alarm;
- duration of the alarm.

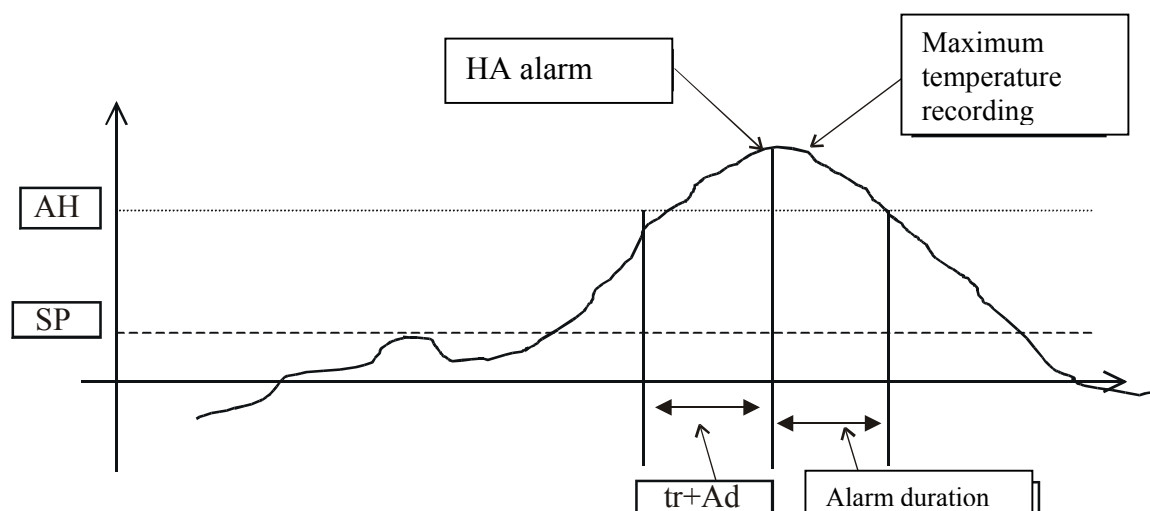

"HF" – this is activated after a power failure if, when power returns, the temperature is higher than the threshold represented by "AH" + "St". The following data are saved:

- hour, minutes and weekday;
- type of alarm;
- maximum temperature reached after the activation of the alarm;
- duration of the power failure.

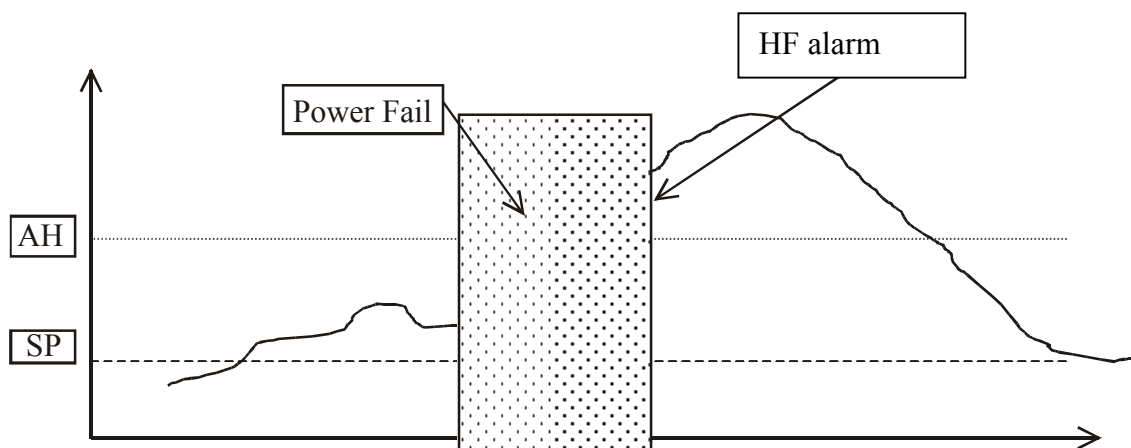

When an HA or HF alarm is activated, the display shows the codes "HA" or "HF", the alarm LED and the HACCP LED come on, the buzzer sounds and the alarm relay is activated.

Pressing SET for one second deactivates the alarm relay and mutes the buzzer. To delete the data saved, enter Parameter programming mode, set parameter "Ad" from 1 to 0 and confirm the operation, or alternatively press the HACCP button for 5 seconds (on the terminals where present, code PST00LR200)..

Note: the HF alarm is acquired and consequently the corresponding data are saved only if the power failure lasts for more than 1 minute.

tr: HA alarm delay

Delay in the activation of the HA alarm.

- Default: 0.

tA: type of HACCP alarm

Identifies the type of the last HACCP alarm ("HA" or "HF").

"tA"= 0, no alarm;

"tA"= 1, HA alarm;

"tA"= 2, HF alarm.

Read-only parameter

- Default: 0.

tO: weekday of last alarm

Displays the weekday on which the last HACCP alarm occurred.

"tO"= 1...7, Monday...Sunday.

Read-only parameter

- Default: 0.

tH: hour of last alarm

Displays the hour at which the last HACCP alarm occurred.

Read-only parameter

- Default: 0.

tM: minutes of last alarm

Displays the minutes at which the last HACCP alarm occurred.

Read-only parameter

- Default: 0.

tt: maximum temperature during alarm

Displays the maximum temperature reached during the last HACCP alarm.

Read-only parameter

- Default: -50.0.

tE: duration of the HACCP alarm

Duration in hours of the last HACCP alarm. In the case of an HF alarm (high temperature after power failure), this is the duration in hours of the power failure.

Read-only parameter

- Default: 0.

to: reset HACCP alarms

Deletes all the data saved for the HACCP alarm, restoring the default values.

This function can also be performed directly by pressing the specific HACCP button located on the large terminal (code PST00LR200).

- Default: 0.

5.13 RTC (Real Time Clock) parameters

	RTC PARAMETERS	Type	Min.	Max.	UOM	Def.	Via LAN
d1	Weekday of 1st defrost	C	0	10	-	0	
h1	Hour of 1st defrost	C	0	23	hours	0	
m1	Minutes of 1st defrost	C	0	59	min	0	
d2	Weekday of 2nd defrost	C	0	10	-	0	
h2	Hour of 2nd defrost	C	0	23	hours	0	
m2	Minutes of 2nd defrost	C	0	59	min	0	
-----	-----	-----	-----	-----	-----	0	
-----	-----	-----	-----	-----	-----	0	
d8	Weekday of 8th defrost	C	0	10	-	0	
h8	Hour of 8th defrost	C	0	23	hours	0	
m8	Minutes of 8th defrost	C	0	59	min	0	
td	Current weekday	F	1	7	-	1	
th	Current hour	F	0	23	hours	0	
t'	Current minutes	F	0	59	min	0	

td, th, t': current day, hour and minutes

These can be modified as if they were type "F" parameters.

dx, hx, mx: defrost times

These are respectively the weekday, hour and minutes set for the x -th defrost.

For example, to program a defrost for 3:30 on Monday morning, set $dx=1$, $hx=3$ and $mx=30$ ($x=1, 2, \dots, 8$).

To disable a defrost, set $dx=0$.

The possible values and the corresponding meanings are as follows:

0	No event
...7	Monday...Sunday
8	From Monday to Friday
9	Saturday and Sunday
10	Every day

Example:

if $dx=8$ the defrosts will be performed from Monday to Friday at hx hours and mx minutes;

if $dx=9$ the defrosts will be performed Saturday and Sunday at hx hours and mx minutes;

if $dx=10$ the defrosts will be performed every day at hx hours and mx minutes.

5.14 P= electronic valve (EEV) option (code MGE0000020)

The MasterCase controller is also available in a version with built-in control for electronic expansion valves (code MGE0000020).

The following components also need to be added:

- an NTC temperature probe for reading the evaporation temperature;
- a ratiometric pressure probe for reading the evaporation pressure;
- a motorised expansion valve;
- a 24Vac 20VA safety transformer (with 1A slow-blow fuse on the secondary).

**NOTE: The following must only be modified by CAREL or other authorized specialist personnel.
Do not modify the parameters without knowing the effective operation of such.**

P	VALVE PARAMETERS	Type	Min	Max	UOM	Def.	Via LAN
P1	Model of valve 0= CAREL E ² V*P (390 steps - BLACK stator) 1= Sporlan 2= CAREL E ² V*A (480 steps - RED stator) 3= Sporlan SEH 25	C	0	3	-	2	
P2	Dead band	C	0	10.0	°C	0.0	
P3	Superheating set point	C	0.0	25.0	°C	8.0	
P4	PID proportional gain	C	0.1	100.0	-	5.0	
P5	PID integration time	C	0	250	s	80	
P6	PID derivative time	C	0.0	100.0	s	0.0	
P7	Low superheating threshold	C	-10.0	P3	°C	4.0	
P8	Low superheating integration time	C	0	255	s/10	150	
PA	Enable transmission of pressure probe from master to slaves (only on the master)	C	0	1	flag	0	
Pb	Pressure probe from master (only on the Slaves)	C	0	1	flag	0	
Pc	Pressure probe alarm delay	C	0	255	min	5	
PH	Type of refrigerant: 0= R134a 6= R290 1= R22 7= R600 2= R404a 8= R600a 3= R410a 9= R717 4= R407c 10= R744 5= R507 11= R1270	C	0	11	-	2	
Pi	Evaporation pressure probe field 0= -1 - 5 bars 1= -1 - 10 bars 2= 0 - 35 bars	C	0	2	-	0	
OSH	Superheating Offset	C	0.0	60.0	-	0.0	
Phr	Enable fast update of the valve parameters to Supervisor 0= No; 1= Yes.	C	0	1	flag	0	
PM1	MOP threshold (saturated evaporation temperature)	C	-50.0	60.0	°C	60.0	
PM2	Integration time during MOP (close valve)	C	0	255	s/10	100	
PM3	MOP function activation delay	C	0	255	s	2	
PM4	Maximum superheated gas temperature	C	-50.0	80.0	°C	80.0	
Po1	Superheating (read-only parameter)	C	-	-	°C	-	
Po2	Valve opening percentage (read-only parameter)	C	0	100	%	-	
Po3	Superheated gas temperature (read-only parameter)	C	-	-	°C	-	
Po4	Saturated evaporation temperature (read-only parameter)	C	-	-	°C	-	
PrA	Enable step recovery in opening 0= No; 1= Yes.	C	0	1	Flag	1	
PSb	Standby position (number of steps)	C	0	3200	steps	80	
VISIBLE ONLY TO SUPERVISOR (VIA PC - PlantVisor® software)							
PF	Valve position (number of steps) (read-only parameter)	Sv	0	30000	steps	-	
PL	Evaporation pressure (read-only parameter)	Sv	-	-	bar	-	
CP1	Initial valve position (number of steps)	Sv	0	3000	steps	350	
Pdis	Disable PID	Sv	0	1	flag	0	
Pmp	Manual valve position	Sv	0	3000	steps	0	

P1: valve model

The MasterCase controller can manage 4 different models of valve. Parameter P1 is used to set the model installed.

"P1"= 0, CAREL E2V*P valve (390 steps - BLACK stator);

"P1"= 1, Sporlan valve (models SEI-0.5, SEI-1, SEI-2, SEI-3.5, SEI-6, SEI-8.5, SEI-11);

"P1"= 2, CAREL E2V*A valve (480passi - RED stator);

"P1"= 3, Sporlan model SEH 25 valve.

Note: *Whenever this parameter is modified, the controller must be turned off and on again so as to allow internal values associated with the type of valve chosen to be loaded.*

- Default: 2.

P2: dead band

The dead band is the semi-interval of temperature (\pm) around the superheating set point in which control is deactivated.

For example, setting this parameter to 1°C with a set point of 5°C means that the superheating can vary between 4°C and 6°C without the controller attempting to modify it. Outside of this interval, obviously, control resumes as normal. Values higher than 2°C are not recommended.

- Default: 0.0.

P3: superheating set point

The parameter P3 used to set the desired superheating value. This is the reference value that the controller "tends" towards by closing and opening the valve, and not the actual guaranteed superheating value. The latter depends on numerous factors, such as the operating conditions, the type and quality of the exchangers, the sizing of the valve, the position of the probes, etc....

Note: *too low values for set point may compromise the stability of the showcase control functions and bring about the unwanted return of liquid. It is recommended to not set the value below 3°C.*

- Default: 8.0.

P4: PID proportional gain

The Proportional, Integration and Derivative constants are the main parameters for the control of the electronic valve. These define the PID part of the superheating control. Refer to classic PID control theory for a more detailed description of their meanings.

The parameter "P4" represents the amplification factor (proportional gain).

The proportional constant (internal value **Kp**) defines the gain not for the PID control of the valve, but also for all the active protectors (low superheating threshold, MOP function).

- Default: 5.0.

P5: PID integration time

This represents the speed with which the controller reacts in order to reduce the error (that is, the difference between the actual superheating value read and the value set with the set point "P3"). In practice, it affects the number of steps that the valve can complete per unit of time. The value is proportionally opposite to the desired effect, that is, low values indicate a higher speed and vice-versa.

The integration time (internal value **Ti**) is expressed in seconds, if the parameter is set to zero the integration action is disabled.

- Default: 80 (seconds).

P6: PID derivative time

The value set for this parameter allows the PID part of the valve control to react to variations, both sudden and not, in the superheating value. In practice, there is a variation in the opening or closing of the valve that increases as the variation in the superheating value per unit of time increases, proportionally to the set value.

The derivative time (internal value **Td**) is expressed in seconds, if the parameter is set to zero, the derivative action is disabled.

- Default: 0.0 (seconds).

P7: Low superheating threshold

To prevent too low superheating values causing the return of liquid into the compressor or considerable instability in the system (swings), this parameter can be used to define a low superheating temperature threshold: below this value, an *additional* function to PID integration control starts, with a programmable constant (see parameter "P8" below). In practice, the "reaction" speed of the valve is increased.

- Default: 4.0 (°C).

P8: low superheating integration time

Below the threshold set with the previous parameter "P7", the electronic valve protection function will operate with the integration constant set with this parameter. In substance, the reaction speed of the valve will be increased, with this parameter allowing lower values than those that can be set for normal control (see "P5").

- Default: 150 (seconds/10).

PA: enable propagation of evaporation pressure probe on local network (only on the master)

In the event of a multiplexed showcase with the controllers connected in master/slave configuration, a single evaporation pressure probe can be connected to the Master and the value sent across the LAN to the slaves, so that all the multiplexed islands use the same probe.

"PA"= 0, propagation disabled;

"PA"= 1, propagation enabled.

Parameter to be set only on the master.

- Default: 0.

Pb: enable evaporation pressure probe via the local network (only on the slaves)

This enables the reception on the slaves of the pressure probe value transmitted by the master via the LAN.

"Pb"= 0, use the local pressure probe;

"Pb"= 1, use the pressure probe transmitted by the master via LAN.

Parameter to be set only on the slaves.

- Default: 0.

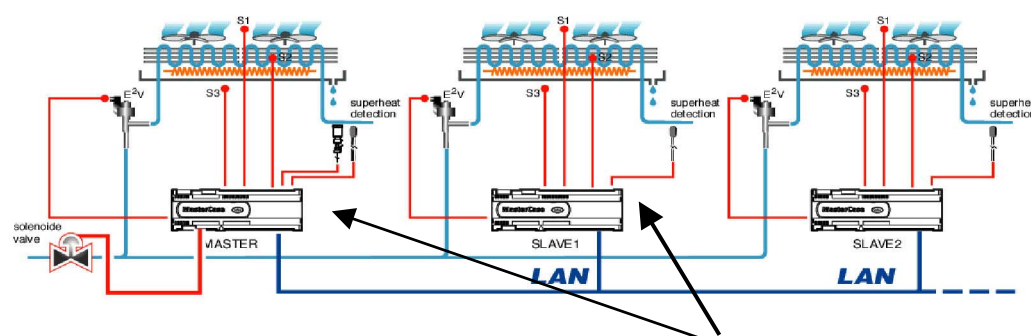

Use of just one pressure probe propagated from the master to the slaves

Pc: pressure probe alarm delay

The MasterCase controller checks that the pressure values read by the ratiometric pressure probes are within the limits envisaged for the model set (see parameter "Pi"). In addition, the probes are also checked to see if they are disconnected or short-circuited. In all these cases, a time can be set for the controller to wait for the fault to pass before signalling the alarm.

It should be remembered the controller also signals if the probes are out-of-range, and so the delay set must allow for any transitory excess pressure values on the unit.

- Default: 5, (minutes).

PH: refrigerant type

Parameter PH is used to set the type of refrigerant used in the system. Each value corresponds to type of gas, according to the following table:

0= R134a	6= R290
1= R22	7= R600
2= R404a	8= R600a
3= R410a	9= R717
4= R407c	10= R744
5= R507	11= R1270

- Default: 2 (R404a).

Pi: pressure probe model on the evaporator

This parameter is used to set the model of the probe installed at the evaporator outlet.

"Pi"= 0 probe with range -1 - 4.17 barg (0/75 psia);

"Pi"= 1 probe with range -1 - 9.34 barg (0/150 psia);

"Pi"= 2 probe with range 0 - 34.47 barg (0/500 psig).

In accordance with the operating pressure of the system, it is recommended to use the probe with the maximum value as near as possible to the max pressure reached during normal operation (excluding transitory conditions).

- Default: 0.

SMART THERMOSTAT

This function allows, using a parameter that acts on the superheating value measured, the typical swings in temperature due to the ON/OFF temperature control using the solenoid valve to be reduced or even eliminated. In practice, the closer the temperature gets to the set point, the further the controller decreases the cooling capacity of the evaporator, by closing the expansion valve. In the best cases, the real temperature of the showcase thus becomes very stable around the set point, without the solenoid valve ever closing, but rather by exclusively controlling the expansion of the refrigerant.

OSH: superheating offset

The parameter "OSH" is added to the superheating value by parameter P3 (internal operation of the software), proportionally to the difference between the controlled air temperature and the temperature set point. The lower the difference, the more weight the deviation determined by "OSH" will have. The consequent increase in the superheating set point will reduce the opening of the valve, thus preventing total closing due to the reaching of the threshold, and allowing the system to operate around the desired temperature (set point).

The function is active only in a band of temperatures between the set point and half of the set differential.

This function cannot be used in stand-alone refrigeration units, but rather only on centralised systems.

"OSH"= 0, function deactivated.

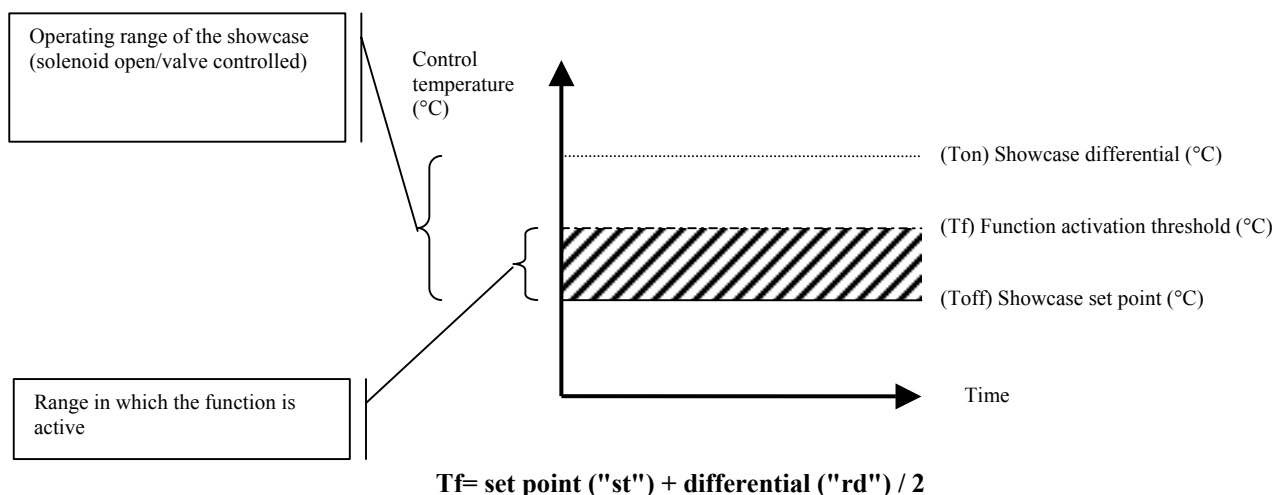

PRACTICAL EXAMPLES

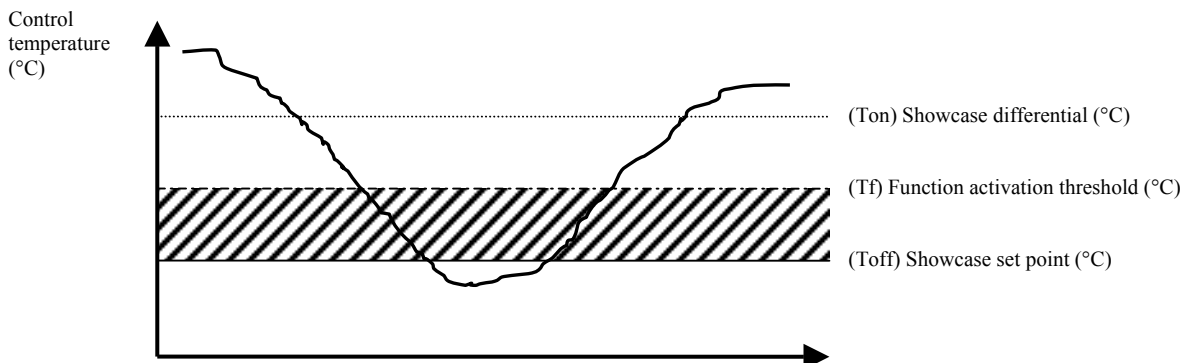

Function disabled or enabled with the value of the parameter OSH too low.

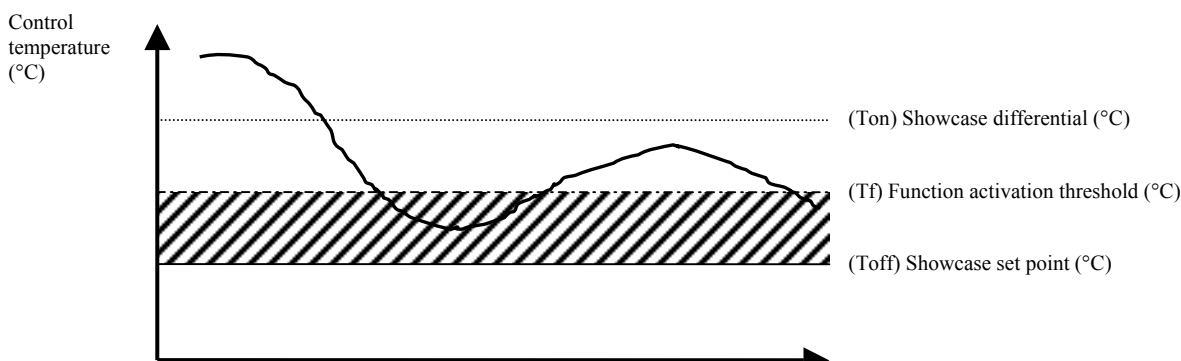

Function enabled with the value of the parameter OSH too high. The advantages of the function are not exploited adequately.

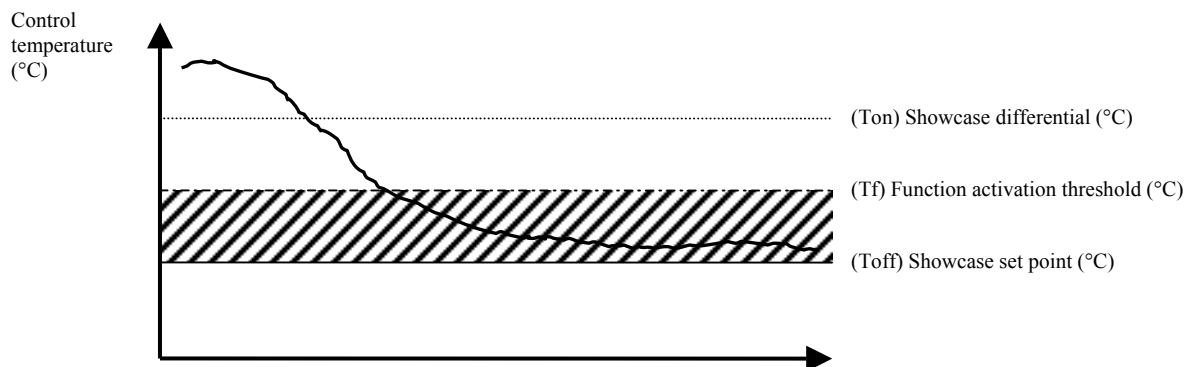

Function enabled with the optimum value of the parameter OSH. Except for sudden variations in the load or disturbance in the system, the showcase will remain in ON for a longer time than with traditional control, yet with a temperature and relative humidity that are much more stable and nearer to the set point.

- *Default: 0.0.*

Phr: enable fast update of the valve parameters to the Supervisor

As the variations in the values relating to the electronic valve (absolute position in number of steps, position as a percentage, evaporation pressure, superheated gas temperature, superheating, etc...) are more frequent compared to the others and are also important in evaluating the correct operation of the valve, a quicker update (every second instead of the normal 30 seconds) can be enabled for these variables to the supervision software.

In a network of instruments, it is recommended not to indiscriminately enable this parameter on all the instruments, but rather only one at a time for service and testing.

"Phr"= 0, fast update disabled;

"Phr"= 1, fast update enabled.

- *Default: 0.*

PM1: MOP threshold (saturated evaporation temperature)

This parameter defines the high suction pressure protection activation threshold (**Maximum Operating Pressure**) indicated in saturated °C. Above this value, the valve control ignores the superheating value (normal operation) and rather acts on the saturated suction temperature so as to return it and maintain it below the set value. The controller will begin to close the valve at a speed determined by the integration constant set for parameter "PM2".

- *Default: 60 (°C).*

PM2: integration time during MOP (close valve)

This represents the integration time for the high pressure protection function (MOP).

When the threshold set for parameter "PM1" is exceeded, the controller will begin to close the valve at a speed determined by the integration set for this parameter.

During this function, there may be variations in the evaporation temperature; in any case, swings of even 2°C can be considered physiological, as the MOP is a safety procedure and not a control routine.

- *Default: 100 (seconds/10).*

PM3: MOP function activation delay

This is the waiting time from the start of the controller for the activation of the MOP protection function. When the unit is started, this time must elapse before the MOP protection function is activated, so as to allow the unit to reach an evaporation pressure above the threshold value assigned to the MOP.

- *Default: 2 (seconds).*

PM4: maximum superheated gas temperature

This parameter sets the maximum temperature (thermometric) allowed for the gas leaving the evaporator. The value read is therefore measured by the superheated gas temperature probe (Tsh). This parameter limits the action of the MOP protection so that, when reached, it completely stops the corrective action of the MOP function until the temperature of the refrigerant returns below the set value. Setting the parameter to the maximum value (80°C) is equivalent to disabling the function.

- *Default: 80.0 (°C).*

Po1: display superheating value (read-only parameter)

By enabling parameter "Po1", the superheating value read by the MasterCase controller can be displayed. This value is equal to the difference between the temperature read by the superheated gas temperature probe (Tsh) and the saturated temperature corresponding to the evaporation pressure read by the ratiometric pressure transducer (P.E.).

Read-only parameter.

- *Default: -*

Po2: valve opening percentage (read-only parameter)

This represents the opening of the valve in percentage terms.

Read-only parameter.

- *Default: -*

Po3: superheated gas temperature (read-only parameter)

This corresponds to the reading of the temperature probe located on the evaporator outlet pipe (temperature of the superheated gas "Tsh").

Read-only parameter.

- Default: -

Po4: saturated evaporation temperature (read-only parameter)

This is the value of the evaporation pressure read by the ratiometric pressure transducer (P.E.) converted into the corresponding saturated temperature.

Read-only parameter.

- Default: -

PrA: enable step recovery in opening

The opening/closing of the valve by the controller and the reading of its position are logical values calculated by the controller itself and that do not necessarily correspond to the actual position. In fact, a series of different factors (electromagnetic disturbance, dirt accumulated inside the valve, etc...) may involve deviation in the actual steps of the valve compared to the controlled position. An automatic step recovery procedure has been implemented during the closing of the valve, and this parameter can be used to enable a step recovery function also during the opening of the valve.

"PrA"= 0, step recovery during opening disabled;

"PrA"= 1, step recovery during opening enabled.

- Default: 1.

PSb: standby position

This indicates the position, as the absolute number of steps, where the valve must move to when stopped (controller off, during defrosts, etc...).

Note: *although this value can be set to 0, for the CAREL valves it is recommended, for internal mechanical reasons, to set a minimum value of 10, keeping account that this value in any case corresponds to the closing of the valve.*

- Default: 80 (steps)

PARAMETERS VISIBLE ONLY TO SUPERVISOR (VIA PC - PlantVisor® software)

For reasons of safety or simply due to technical limits linked to the display, the following parameters are only made available to the supervision software running on a PC.

PF: valve position (number of steps) (read-only parameter)

This represents the position of the valve, as the absolute number of steps.

Note that this is the value calculated by the controller, that is, the position where the valve has been moved to based on the conditions measured. It is therefore an assumed value, not the real one, as physical phenomena, such as strong electromagnetic disturbance, mechanical blockages inside the valve and so on, may mean a lack of control over the steps of the valve, bringing it to unknown positions.

Read-only parameter

- Default: -

PL: evaporation pressure (read-only parameter)

This represents the value read by the ratiometric pressure transducer and is expressed in bars.

Read-only parameter

- Default: -

CP1: initial valve position (number of steps)

This is used to set the initial position where the valve moves to whenever the controller is started.

This parameter, in combination with parameter "c8", on one hand allows the rapid emptying of the suction line and the consequent stopping due to low pressure (in non-centralised systems with on-board compressor), and on the other to pre-position the valve for more ready resumption of control.

- Default: 350 (steps)

Pdis: disable PID

This parameter can be used to disable the PID control of the electronic valve and allow manual control (see parameter "Pmp").

Disabling the PID ("Pdis"= 1) will completely close the valve, which can then be opened or closed only by manual control using the parameter "Pmp" described below.

"Pdis"= 0, PID control enabled (valve controlled automatically);

"Pdis"= 1, PID control disabled (valve in manual control);

- Default: 0

Pmp: manual valve position

This is used to move the valve to the desired position of opening by setting the number of absolute steps required to reach such position.

This is possible only if the "automatic" control of the valve has been disabled using the parameter "Pdis" described above.

Set a number of steps that is consistent with the model of valve installed (see parameter "P1").

- Default: 0

6. Table of parameters

PASSWORD PARAMETERS		Type	Min.	Max.	UOM	Psw	Via LAN
PP	Parameter Password	F	00	199	-	22	
PS	Log Password	F	00	199	-	44	
Pd	Download Password	F	00	199	-	66	

PROBE PARAMETERS		Type	Min.	Max.	UOM	Def.	Via LAN
/	Measurement stability	C	1	15	-	1	
/4	Virtual probe (between S1 and S3) (0= probe 1; 100= probe 3)	C	0	100	-	0	•
/6	Enable decimal point (0= No, 1= Yes)	C	0	1	flag	1	•
/7	Remote display management 0= not present 1= room probe (S1) 2= end defrost probe (S2) 3= third probe (S3) 4= virtual probe 5= terminal probe	C	0	5	-	0	•
/8	Third probe calibration (S3)	C	-20.0	20.0	°C	0.0	
/9	Defrost also with third probe (S3) 1= the defrost finishes when the temperature read by probes S2 and S3 are greater than "dt" (see also parameter "H5")	C	0	1	flag	0	•
/A	Probes present 0= room probe only (S1) 1= room probe (S1) and third probe (S3) 2= room probe (S1) and defrost probe (S2) 3= all present (S1), (S2) and (S3) 4= control probe sent by master (only on the slaves)	C	0	4	-	0	•
/C	Room probe calibration (S1)	F	-20.0	20.0	°C	0.0	
/d	End defrost probe calibration (S2)	C	-20.0	20.0	°C	0.0	
/t	Terminal display management 0= not present 1= room probe (S1) 2= end defrost probe (S2) 3= third probe (S3) 4= virtual probe 5= terminal probe	C	0	5	-	4	•

ALARM PARAMETERS		Type	Min.	Max.	UOM	Def.	Via LAN
A0	Temperature alarm return and fan activation differential (see parameter F1)	C	0.1	20.0	°C	2.0	•
A1...5	Digital input configuration (see note 1) 0= disabled 1= immediate external alarm 2= delayed external alarm 3= enable defrost 4= start defrost from external contact 5= door switch 6= ON/OFF remote 7= night-time curtain switch 8= duty setting activation 9= door switch with control active 10= case cleaning (CCM)	C	0	10	-	0	
A7	Alarm delay from digital input (Ax= 2)	C	0	180	min	0	•
A8	Virtual digital input configuration	C	0	10	-	0	
Ad	Temperature alarm delay	C	0	180	min	120	•
AH	High temperature alarm (deviation from the set point)	F	0	20.0	°C	0.0	•
AL	Low temperature alarm (deviation from the set point)	F	0	20.0	°C	0.0	•
Ar	Enable the master to signal the alarms on the slaves (only on the master)	C	0	1	flag	1	

c	SAFETY TIME PARAMETERS	Type	Min.	Max.	UOM	Def.	Via LAN
c0	Start control delay from power up	C	0	15	min	0	•
c1	Minimum time between two successive starts	C	0	15	min	0	•
c2	Minimum OFF time	C	0	15	min	0	•
c3	Minimum ON time	C	0	15	min	0	•
c4	Safety control ("Duty cycle setting" function) 0= always OFF 100= always ON	C	0	100	min	0	•
c6	Temperature alarm bypass time after continuous cycle	C	0	15	hours	2	•
c8	Start control delay from the opening of the valve	C	0	120	s	5	•
cc	Continuous cycle duration	C	0	15	hours	4	•

d	DEFROST PARAMETERS	Type	Min.	Max.	UOM	Def.	Via LAN
d0	Type of defrost 0= electric, end by temperature, time as safety 1= hot gas, end by temperature, time as safety 2= electric, end by time 3= hot gas, end by time	C	0	3	-	0	•
d2	Type of control for LAN defrost 0= start only 1= start and stop	C	0	1	flag	1	•
d3	Operating time with temperature read by S2 less than 1°C before starting a defrost	C	0	192	hours	0	•
d4	Defrost when switching controller on (Yes, No)	C	0	1	flag	0	•
d5	Defrost start delay from controller power-up or on from digital input	C	0	180	min	0	•
d6	Display management during defrost 0= display the temperature alternating with the symbol "dF" 1= hold on last temperature displayed	C	0	1	flag	0	•
d7	Enable skip defrost function	C	0	1	flag	0	•
d8	Temperature alarm bypass time after defrost and/or open door	F	0	15	hours	1	•
d9	Priority of defrost over protection times (par. "c")	C	0	1	flag	0	•
dd	Dripping time	F	0	15	min	2	•
dI	Interval between two successive defrosts	F	0	192	hours	8	•
dM	Time between two successive cleaning cycles (CCM function)	C	1	999	hours	1	
dPM	Cleaning cycle duration (CCM function)	C	0	60	min	0	
dP	Maximum defrost time	F	1	180	min	30	•
dt	End defrost temperature	F	-50.0	30.0	°C	4.0	•

F	FAN PARAMETERS	Type	Min.	Max.	UOM	Def.	Via LAN
F0	Fan management 0= fans always on (except cases F2, F3, Fd) 1= fans controlled according to absolute set point F1	C	0	1	flag	0	•
F1	Fan off time	F	-40.0	50.0	°C	5.0	•
F2	Fans off when control inactive (0= No, 1= Yes) <i>active only with F0= 0</i>	C	0	1	flag	1	•
F3	Fan management during defrost 0= Fans on, off during dripping ("dd") 1= Fans off 2= Fans also on during dripping ("dd")	C	0	2	-	1	•
Fd	Fan off time during post-dripping	F	0	15	min	1	•

H	CONFIGURATION PARAMETERS	Type	Min.	Max.	UOM	Def.	Via LAN
H0	Serial address	C	0	199	-	1	
H1	Enable use of the remote control (<i>Infrared</i>)	C	0	1	flag	0	•
H2	ID code for using the remote control	C	0	99	-	0	
H3	Enable ON/OFF button on terminal	C	0	1	flag	1	•
H4	Enable ON/OFF from supervisor	C	0	1	flag	0	•
H5	Configuration of output AUX1 0= output disabled 1= compressor output 2= master/slave network compressor output 3= light and/or curtain output 4= fan output 5= hot wire output 6= alarm output 7= evaporator 1 defrost output 8= evaporator 2 defrost output 9= ON/OFF valve output (solenoid)	C	0	9	-	0	
H6	Configuration of output AUX2 (hot wire) for values see H5	C	0	9	-	5	
H7	Configuration of compressor output (only on the master) 1= compressor 2= master/slave network compressor	C	1	2	-	1	

	LAN PARAMETERS	Type	Min.	Max.	UOM	Def.	Via LAN
In	Configuration as master (In= 1) or slave (In= 0)	C	0	1	flag	0	
Sn	Number of slaves (only on master) 0= LAN not present	C	0	5	-	0	

r	CONTROL PARAMETERS	Type	Min.	Max.	UOM	Def.	Via LAN
r1	Minimum set point value allowed by the user	C	-50.0	r2	°C	-50.0	•
r2	Maximum set point value allowed by the user	C	r1	90.0	°C	90.0	•
r3	Enable alarm "Ed" (defrost ended by timeout) 0= No, 1= Yes	C	0	1	flag	0	•
r4	Night-time set point (deviation from set point)	C	-20.0	20.0	°C	3.0	•
r5	Enable maximum and minimum temperature recording 0= No; 1= Yes	C	0	1	flag	0	•
r6	Night-time control with third probe S3 1= night-time control on third probe S3 0= night-time control on virtual probe	C	0	1	flag	0	•
rd	Differential (hysteresis)	F	0.1	20.0	°C	2.0	•
rH	Maximum temperature recorded in the interval "rt" (read-only)	C	-	-	°C	-50.0	
rL	Minimum temperature recorded in the interval "rt" (read-only)	C	-	-	°C	90.0	
rt	Time elapsed since the start of the maximum and minimum temperature recording interval (read-only)	C	0	999	hours	0	

	SET POINT PARAMETERS	Type	Min.	Max.	UOM	Def.	Via LAN
St	set point - operating temperature	F	r1	r2	°C	-20.0	•
Stn	Select night-time set point mode	C	0	2	flag	0	
hSn	Night-time set point start time	C	0	23	hours	0	
hSd	Night-time set point end time	C	0	23	hours	0	
SL1	Absolute minimum temperature, probe S1 SL1= 90°C function disabled	C	-50.0	90.0	°C	90.0	

P	VALVE PARAMETERS	Type	Min	Max	UOM	Def.	Via LAN
P1	Model of valve 0= CAREL E ² V*P (390 steps - BLACK stator) 1= Sporlan 2= CAREL E ² V*A (480 steps - RED stator)	C	0	2	-	2	
P2	Dead band	C	0	10.0	°C	0.0	
P3	Superheating set point	C	0.0	25.0	°C	8.0	
P4	PID proportional gain	C	0.1	100.0	-	5.0	
P5	PID integration time	C	0	250	s	80	
P6	PID derivative time	C	0.0	100.0	s	0.0	
P7	Low superheating threshold	C	-10.0	P3	°C	4.0	
P8	Low superheating integration time	C	0	255	s/10	150	
PA	Enable transmission of pressure probe from master to slaves (only on the master)	C	0	1	flag	0	
Pb	Pressure probe from master (only on the slaves)	C	0	1	flag	0	
Pc	Pressure probe alarm delay	C	0	255	min	5	
PH	Type of refrigerant: 0= R134a 6= R290 1= R22 7= R600 2= R404a 8= R600a 3= R410a 9= R717 4= R407c 10= R744 5= R507 11= R1270	C	0	11	-	2	
Pi	Evaporation pressure probe field 0= -1 - 5 bars 1= -1 - 10 bars 2= 0 - 35 bars	C	0	2	-	0	
OSH	Superheating Offset	C	0.0	60.0	-	0.0	
Phr	Enable fast update of the valve parameters to supervisor: 0= No; 1= Yes.	C	0	1	flag	0	
PM1	MOP threshold (saturated evaporation temperature)	C	-50.0	60.0	°C	60.0	
PM2	Integration time during MOP (close valve)	C	0	255	s/10	100	
PM3	MOP function activation delay	C	0	255	s	2	
PM4	Maximum superheated gas temperature	C	-50.0	80.0	°C	80.0	
Po1	Superheating (read-only parameter)	C	-	-	°C	-	
Po2	Valve opening percentage (read-only parameter)	C	0	100	%	-	
Po3	Superheated gas temperature (read-only parameter)	C	-	-	°C	-	
Po4	Saturated evaporation temperature (read-only parameter)	C	-	-	°C	-	
PrA	Enable step recovery in opening 0= No; 1= Yes.	C	0	1	Flag	1	
PSb	Standby position (number of steps)	C	0	3200	steps	80	
VISIBLE ONLY TO SUPERVISOR							
PF	Valve position (number of steps) (read-only parameter)	Sv	0	30000	steps	-	
PL	Evaporation pressure (read-only parameter)	Sv	-	-	bar	-	
CP1	Initial valve position (number of steps)	Sv	0	3000	steps	350	
Pdis	Disable PID	Sv	0	1	flag	0	
Pmp	Manual valve position	Sv	0	3000	steps	0	

t	HACCP PARAMETERS	Type	Min.	Max.	UOM	Def.	Via LAN
tr	HACCP alarm delay 0= HACCP disabled	C	0	180	min	0	
tA	Type of HACCP alarm (read-only parameter) 0= no alarm 1= HA alarm 2= HF alarm	C	0	2	-	0	
tO	Weekday of the most recent HACCP alarm (read-only parameter)	C	0	7	day	0	
tH	Hour of the most recent HACCP alarm (read-only parameter)	C	0	23	hours	0	
tM	Minutes of the most recent HACCP alarm (read-only parameter)	C	0	59	min	0	
tt	Maximum temperature reached during the most recent HACCP alarm (read-only parameter)	C	-50.0	90.0	°C	-50.0	
tE	Duration of the HACCP alarm (read-only parameter)	C	0	240	hours	0	
to	Delete the data saved and the HACCP alarm	C	0	1	flag	0	

RTC PARAMETERS		Type	Min.	Max.	UOM	Def.	Via LAN
d1	Weekday of 1st defrost (See note 2)	C	0	10	-	0	
h1	Hour of 1st defrost	C	0	23	hours	0	
m1	Minutes of 1st defrost	C	0	59	min	0	
d2	Weekday of 2nd defrost (See note 2)	C	0	10	-	0	
h2	Hour of 2nd defrost	C	0	23	hours	0	
m2	Minutes of 2nd defrost	C	0	59	min	0	
-----	-----	-----	-----	-----	-----	0	
-----	-----	-----	-----	-----	-----	0	
d8	Weekday of 8th defrost (See note 2)	C	0	10	-	0	
h8	Hour of 8th defrost	C	0	23	hours	0	
m8	Minutes of 8th defrost	C	0	59	min	0	
td	Current weekday	F	1	7	-	1	
th	Current hour	F	0	23	hours	0	
t'	Current minutes	F	0	59	min	0	

Note 1

Value of A1...A5/A8	Meaning	Operation
0	Input not active	No function associated
1	Immediate external alarm	Contact open= alarm active
2	Delayed external alarm	Contact open= alarm active with delay set for parameter A7
3	Enable defrost	Contact open= defrost not enabled Contact closed= defrost active
4	Immediate activation of the defrost	Contact closed= the defrost starts immediately. This can be used, for example, when connected to an external mechanical timer.
5	Door switch	Contact open= door open. When the door is opened the controller and the fans stop. If the door remains open for a time greater than the value set for parameter d8, the controller and the fans start again and a terminal error is signalled.
6	Remote ON/OFF	Contact closed= ON; Contact open= OFF
7	Curtain switch	Contact closed= night curtain closed deactivation of light relay (with Stn= 0) + set point variation (with Stn =1) by the value set for r4.
8	"Duty cycle setting" from external contact	Contact closed= activation of duty cycle setting Contact open= deactivation, return to normal control
9	Door switch with control ON	As per function 5 but the control remains active
10	Case cleaning input (CCM)	Contact closed= the control is normal and the counter "dM" is active. Contact open= the control is in standby and the counter "dPM" is active.

Note 2

0	No event
1...7	Monday...Sunday
8	From Monday to Friday
9	Saturday and Sunday
10	Every day

7. Alarms

7.1 Anomalous or special operation

The MasterCase series instruments are able to automatically detect the main malfunctions. **Always check the connectors wired onto the cable from the terminal to the controller.**

In the event of malfunctions, the controller responds as follows:

- the malfunction is signalled on the display with an alarm code. In particular, the instrument displays the alarm code alternating with the temperature read by the probe (when possible);
- in the case of more than one alarm, these are displayed in sequence, alternating with the temperature;
- for some alarms the buzzer, if present, sounds and the alarm relay is activated.



Pressing  mutes the buzzer and de-energises the alarm relay, while the alarm code disappears only when the causes of the alarm are no longer present. The alarm codes are listed in the table below:

ALARM CODE	BUZZER and AUX relay	DESCRIPTION	MODELS where featured
rE	active	control probe error	ALL
E1	not active	room probe error	ALL
E2	not active	defrost probe error	ALL
E3	not active	probe 3 error	ALL
E0	not active	terminal probe error (on display)	ALL
IA	active	immediate external alarm	ALL, if the external alarm is connected
dA	active	delayed external alarm	ALL, if the external alarm is connected
LO	active	low temperature alarm	ALL
HI	active	high temperature alarm	ALL
EE	not active	data saving error	ALL
HA	active	HA alarm (HACCP)	ALL
HF	active	HF alarm (HACCP)	ALL
Ed	not active	defrost ended by time-out	ALL
dr	not active	door switch error (door open timeout)	ALL
Id	active	duty cycle setting alarm from digital input	ALL
CCM	active	case clean management	ALL
Edc	active	loss of internal communication between EEV driver board and controller	On MasterCase with EEV management (code MGE0000020)
Ed1	active	superheating temperature sensor (NTC Sh) on driver board out-of-range	On MasterCase with EEV management (code MGE0000020)
Ed2	active	evaporation pressure sensor (PE) on driver board out-of-range	On MasterCase with EEV management (code MGE0000020)
LO1	active	minimum temperature alarm on probe S1	ALL
dF	not active	defrost in progress	ALL
tC	not active	RTC invalid	On master with RTC
MA	not active	lost contact with the master	On slave units
uX (X= 1,...,5)	not active	slave X not communicating	On master units
nX (X= 1,...,5)	active	slave X alarm	On master units
dX (X= 1,...,5)	not active	download failed on slave X	On master units

7.2 Description of the signals and alarm codes shown on the display

rE

Control probe error:

- Probes not working: the probe signal is discontinued or short-circuited;
- Probes not compatible with the instrument.

If control is based on the virtual probe (value of parameter "/4" between 0 and 100), this error will be generated only when both the probes are broken. In fact, the breakage of just one of the two probes automatically moves control to the other probe.

E1

Room probe error (S1):

- Probe not working: the probe signal is discontinued or short-circuited;
- Probe not compatible with the instrument;

E2

Evaporator probe error (S2):

- Probe not working: the probe signal is discontinued or short-circuited;
- Probe not compatible with the instrument;

E3

Third probe error (S3):

- Probe not working: the probe signal is discontinued or short-circuited;
- Probe not compatible with the instrument;

E0

Terminal probe error or communication error between the terminal and controller.

This error appears only if the display of the terminal probe is selected using the parameters /t=5 or /7=5, on the interface or the remote display respectively.

It is cancelled if the display returns to one of the probes available.

- Probe not working: the probe signal is discontinued or short-circuited;
- Probe not compatible with the instrument;

The error can also appear when there is no communication between the controller and the terminal, even if the latter is in any case powered by the controller.

IA

Immediate alarm from digital input:

- Check the status of the digital input and the value of the corresponding parameter A1...A5 / A8.

dA

Delayed alarm from digital input:

- Check the status of the digital input and the value of the corresponding parameters A1...A5 / A8 and A7.

LO

Low temperature alarm.

The control probe has detected a temperature lower than the set point by a value greater than parameter "AL":

- check the parameters "AL", "Ad", "St" and "A0".

The alarm is reset automatically when the temperature returns within the set limits (see parameter AL).

HI

High temperature alarm.

The control probe has detected a temperature higher than the set point by a value greater than parameter "AH".

- check the parameters "AH", "Ad", "St" and "A0";
- check the correct operation of the temperature probes.

The alarm is reset automatically when the temperature returns within the set limits (see parameter "AH").

EE

Displayed during operation or on power-up

Data acquisition error.

- Try to restore the default parameter values.

HA

HACCP alarm, type HA.

A high temperature alarm has occurred according to the settings of parameters "tr", "Ad", "AH", "St".

- Check the HACCP parameters;;
- check the temperature and the correct operation of the temperature probes.

HF

HACCP alarm, type HF.

A high temperature alarm has occurred according to the settings of parameters "tr", "Ad", "AH", "St".

A power failure has occurred for more than one minute and when power returned the temperature was higher than the value set for AH+St.

- Check the HACCP parameters;
- Check the temperature.

Ed

The last defrost ended as the maximum time (parameter "dP") exceeded, before reaching the end defrost temperature. The signal is active only if parameter "r3" = 1. **The signal remains on until a defrost is performed that ends at the set temperature.**

- Check parameters "d0", "dt" and "dP";
- Check the efficiency of the defrost devices.

dr

The digital input configured as "door switch" (A1...A5, A8= 5) is open for a time greater than the value set for parameter d8.

- Check that the door is closed.
- Check the status of the contact connected to the input on the instrument.

Id

This is an immediate external alarm (as described by the alarm "IA"), with the difference that the controller will activate the "duty cycle setting" function (see the explanation for parameter "c4").

- Check the status of the digital input and the value of the corresponding parameter A1...A5 / A8.

CCM

This is the signal corresponding to the "periodical cleaning of the showcase" and that is activated when the time set for parameter "dM" has elapsed (see the description of parameters dM and dPM - Case Clean Management function).

- Check the setting of parameters "dM" and "dPM"
- Check the status of the digital input and the value of the corresponding parameter A1...A5 / A8.

Ede

Loss of internal communication between the controller and the built-in driver board (electronic valve option).

In this case, the alarm will cause the driver board to immediately close the electronic valve.

- try restarting the controller (switch it off and on again);
- check that the driver is powered (24Vac connection from external transformer).

The fault signal is automatically reset when the problem is no longer present.

Ed1

Evaporation pressure sensor (PE) on the driver board out-of-range.

The valve is controlled by reading the superheating, which in turn is the difference between the value measured by the pressure probe and the temperature probe (NTC Sh). If this probe is faulty or out-of-range, the controller is no longer able to manage the valve, and starts operating in safety mode (to avoid the presence of liquid at the evaporator outlet), while still guaranteeing a minimum of cooling to the showcase. The safety position is calculated by taking 50% of the average position of the valve in the last hour of operation.

The valve will remain in the safety position until the problem is no longer present, or in any case for no longer than 1 hour, after which the valve will be closed.

- check the electrical connections.;
- check the condition of the probe.

Ed2

Superheating temperature sensor (NTC Sh) on the driver board out-of-range.

See the description of the alarm "Ed1".

- check the electrical connections.;
- check the condition of the probe.

LO1

Temperature on probe S1 below the set value (see parameter "SL1"). The alarm is reset automatically when the temperature read by the probe increases by 2°C above the set threshold.

- check the setting of parameters "SL1" and "/4";
- check the position of the room probe (S1).

dF

Defrost in progress:

- This is not an alarm signal, but rather an indication that the instrument is performing a defrost.
- This appears only if parameter d6= 0, or d6= 2.

tC

RTC error on the units fitted with RTC and configured as master

- Set the hour and minutes from the user interface or via supervisor.

MA (on slave)

Loss of communication between the slave and the master.

- Check the electrical connections on the LAN;
- check the settings of the parameters "In", "Sn" and "H0";
- these network signals (on both master and the slave) are reset automatically as soon as communication is re-established between the master and slave.

"u1, ... u5" (on master)

Loss of communication with slave 1, ..., 5 (for at least one minute).

- Check the electrical connections on the LAN;
- check the settings of the parameters "In", "Sn" and "H0";
- these network signals (on both master and the slave) are reset automatically as soon as communication is re-established between the master and slave.

"n1,... n5" (on master)

slave n1, ..., n5 with local alarm.

- Check the status of the slave that is signalling the alarm and check the alarm code on the same.

"d1, ..., d5" (on master)

Parameter download failed to unit "uS1, ..., uS5"

- Check the wiring on the LAN;
- repeat the download procedure.

8. Technical specifications

Power supply	230Vac (-15%...+10%), 50/60 Hz	
Electronic valve power supply (24Vac terminals)	24Vac 20VA transformer (available only on code MGE000020)	
Probe inputs	4 inputs for NTC probes	
Type of probe - measurement accuracy	Carel standard NTC 10 W 25°C - ± 1 °C	
Measurement range	-50T90 (-58T195 °F) resolution 0.1°C	
Digital inputs	5 for non-optically isolated voltage-free contacts (open-closed contact 8Vdc - 8mA typical)	
LAN serial connection	two-wire AWG22-24 (maximum length 10m)	
Relay outputs: type of action and disconnection and number of operating cycles	Action type 1B (microswitching) UL: 250Vac 30,000 cycles EN60730: 100,000 cycles Note: changeover relay defined only for N.O. or N.C.	
Compressor/Valve	2 Hp 12(12)A 250Vac (min.100,000 cycles) UL: 12A 10 FLA 60 LRA 250Vac	
Defrost	12(4)A 250Vac (min.100,000 cycles) - 2500 W ->cosφ= 1	
Fans	¾ Hp 12(4)A 250Vac (min.100,000 cycles) - 500 W -> cosφ= 0.6	
Light	2 Hp 12(12)A 250Vac (min. 100,000 cycles) fluorescent lamp 1,000VA-110 uF (max. 15,000 cycles)	
Rail Heat (AUX2)	¾ Hp 12(4)A-250Vac (min.100,000 cycles) - 2500 W -> cosφ= 1	
AUX1	¾ Hp 12(4)A-250Vac (min.100,000 cycles)	
Alarm	SPDT contact 1HP 12(4)A-250Vac (min.100,000 cycles)	
250Vac power supply terminals	screw terminals, 12A 250Vac (UL 10A) minimum recommended cross-section 1.5...2.5 mm ² (for power supply to loads and controller)	
Terminals for I/O signals	screw terminals for cables with cross-section 0.25...2.5 mm ²	
I/O connections	max. length of signal cables: - temperature probes (NTC) max.30 m - digital inputs max.30m - pressure probes (ratiometric) max.10m - electronic valve motor outputs max 10m	the pressure probes and valve motor are available only on code MGE000020
LAN terminals	screw terminals for cables with cross-section 0.25...2.5 mm ²	
Carel supervision	screw terminals for cables with cross-section 0.25...2.5 mm ²	(only if supervisor board present, optional)
Installation	wall-mounting (rear of panel) by DIN rail	
Terminal/display	3-wire serial connection max. length 10m:	power supply supplied by the controller 24/35Vdc 1.5 W max.
	• optional PST Small or Large terminal	
	• optional display PST00VR100	
classification according to protection against electric shock	Class II when suitably integrated	transformer with double insulation and relay distance for reinforced insulation
RTC clock	management of days, hours, minutes: precision ±20 ppm (±10 min./year)	only if RTC clock board present
RTC data maintenance	10 years with non-rechargeable lithium battery	can only be replaced by specialist personnel
operating conditions -	10T50°C - non-condensing humidity	
storage conditions	-20T70°C - non-condensing humidity	
environment (type of pollution)	normal	
PTI of the insulating materials	250 V	
period of stress across the insulating parts	long	
category of resistance to heat and fire	fire category D (unsupervised operation)	
immunity against voltage surges	category 1	
class and structure of the software	Class A	
index of protection provided by the board	IP20 (IP40 only on the rounded front panel)	

Important: in models MGE000020, when installing a series of units in the same electrical panel, do not supply 24Vac power with just one common transformer, but rather fit each MasterCase with a transformer

CAREL

Technology & Evolution

CAREL S.p.A.
Via dell'Industria, 11 - 35020 Brugine - Padova (Italy)
Tel. (+39) 049.9716611 Fax (+39) 049.9716600
<http://www.carel.com> - e-mail: carel@carel.com

Agency:

*Cod. CAREL: +030220221
REL 1.1 dated 18/11/04*