

X52 and X59DF

Fish-Finding & Depth-Sounding Sonars

Installation and Operation

Instructions

**Copyright © 2004 Lowrance Electronics, Inc.
All rights reserved.**

Lowrance® is a registered trademark of Lowrance Electronics, Inc.

No part of this manual may be copied, reproduced, republished, transmitted or distributed for any purpose, without prior written consent of Lowrance. **Any unauthorized commercial distribution of this manual is strictly prohibited.**

Lowrance Electronics may find it necessary to change or end our policies, regulations, and special offers at any time. We reserve the right to do so without notice. All features and specifications subject to change without notice. All screens in this manual are simulated.

**For free owner's manuals and the most current information on
this product, its operation and accessories,
visit our web site:**

www.lowrance.com

Lowrance Electronics Inc.
12000 E. Skelly Dr.
Tulsa, OK USA 74128-2486
Printed in USA.

Table of Contents

Introduction	i
Capabilities and Specifications: X52 and X59DF	1
Installation & Accessories	3
Preparations	3
Transducer Installation	3
Recommended Tools and supplies	4
Selecting a Transducer Location	4
How low should you go?	5
Shoot-Thru-Hull vs. Transom Mounting	6
Transom Transducer Assembly and Mounting	7
Trolling Motor Bracket Installation	13
Transducer Orientation and Fish Arches	14
Shoot-Thru-Hull Preparation	15
Testing Determines Best Location	16
Shoot-Thru-Hull Installation	17
Speed/Temperature Sensors	19
Optional Temperature Sensor	19
Optional Speed Sensor Installation	19
Power Connections	20
Powering a NMEA 2000 Buss (NMEA 2000 Power cable)	21
Powering Your Unit	21
NMEA 2000 Cable Connections	24
NMEA 0183 Cable Connections	24
Mounting the Unit: Bracket, In-Dash or Portable	25
Other Accessories	29
Basic Sonar Operation	31
KEYBOARD BASICS	31
Memory	32
Menus	32
Main Menu	32
Sonar Menu	34
Pages	35
Basic Sonar Quick Reference	38
Sonar Operations	39
Fish Symbols vs. Full Sonar Chart	41
Other Free Training Aids	42
Advanced Sonar Options & Other Features	43
ASP™ (Advanced Signal Processing)	43
Alarms	44
Depth Alarms	44
Fish Alarm	45

Backlight Level	46
Calibrate Speed.....	46
Chart Speed.....	46
Grayline®	47
Contrast.....	48
Depth Cursor.....	49
Depth Range - Automatic	50
Depth Range - Manual	50
Depth Range - Upper and Lower Limits	51
To change the upper and lower limits:.....	51
To turn off upper and lower limits:	52
FasTrack™	52
Fish I.D.™ (Fish Symbols & Depths).....	52
FishTrack™	53
Overlay Data	54
Ping Speed & HyperScroll™.....	56
To change Ping Speed:.....	57
To adjust Sensitivity:	57
To turn off HyperScroll:.....	57
Pop-up Help.....	58
Reset Options	58
Reset Water Distance	59
Sensitivity & Auto Sensitivity.....	59
To turn Auto Sensitivity back on:	61
Set Keel Offset	61
Set Language	62
Software Version Information.....	62
Sonar Chart Mode.....	63
Sonar Page & Sonar Chart Display Options	63
Full Sonar Chart	63
Split Zoom Sonar Chart.....	64
Digital Data/Chart	65
Flasher.....	66
Sonar Simulator	66
Stop Chart	66
Surface Clarity	67
Units of Measure.....	68
Zoom Pan.....	70
Troubleshooting	71
Index.....	75

Introduction

Thank you for buying a Lowrance® sonar! Your unit is a high-quality sonar designed for both professional and novice fishermen. All Lowrance sonars have an automatic mode that finds and displays the bottom, fish, underwater structure and more – right out of the box. All you have to do is press the on (**PWR**) key.

However, if you want to fine-tune your unit, press the **MENU** key. The X52 and X59DF have several powerful features you can control by scrolling through easy-to-use menus with the arrow and menu keys.

To get started with your Lowrance sonar, first read the installation section. It contains instructions for mounting the sonar unit, the transducer and any optional accessories, such as a speed sensor.

Following recommended installation practices will pay off in optimum performance of your Lowrance sonar. Improper installation can cause problems down the road, *especially if the transducer is badly mounted.*

After you've read the installation instructions, install the unit and accessories. Then, read the rest of the manual. The more you know about your sonar, the better it will work for you.

Take advantage of the Simulator feature. It allows you to practice operating your sonar before you get it in the water. And when you finally head for your favorite fishing hole, take this manual along for reference.

Capabilities and Specifications: X52 and X59DF

General

- Case size:**..... 5.2" H x 5.4" W x 2.6" D (13.2 cm H x 13.6 cm W x 6.6 cm D) sealed, waterproof; suitable for saltwater use.
- Display:**..... High-contrast Film SuperTwist LCD; 4.0" (10.2 cm) diagonal viewing area.
- Resolution:**..... 240 pixels (vert.) x 160 pixel (horiz.) resolution; 38,400 total pixels
- Backlighting:**..... White LED backlit screen and keypad for night use.
- Input power:**..... 10 to 17 volts DC.
- Current drain:** 300 ma lights off; 400 ma lights on.
- Back-up memory:** Built-in memory stores sonar settings when unit is turned off.

Sonar

- Frequency:**..... 200 kHz (or 50/200 kHz – X59DF only).
- Transducers:** A dual-frequency Skimmer[®] transducer comes packed with the X59DF. It has 35°/12° cone angles. Single frequency models for X52 with a 20° cone angle are sold separately. Both models offer a wide fish detection area of up to 60° with high sensitivity settings.
- Transmitter:** 1500 watts peak-to-peak power (typical); 188 watts RMS power (typical).

Sonar sounding

- depth capability:** 800 feet (244 meters) at 200 kHz; 1500 feet (450 meters) at 50 kHz (X59DF only). Actual capability depends on transducer configuration and installation, bottom composition and water conditions. All sonar units typically read deeper in fresh water than in salt water.

- Depth display:**..... Continuous digital readout.

- Audible alarms:** Deep/shallow/fish.

- Automatic ranging:**..... Yes, with instant screen updates.

- Zoom bottom track:** Yes.

- Split-screen zoom:**..... Yes.

- Surface water temp:** Yes, with optional external temperature sensor, combo speed/temp sensor or transducer with built-in temp.

- Speed/distance log:** Yes, with optional speed sensor or combo speed/temp sensor.

NOTICE!

The storage temperature for your unit is from -4 degrees to +167 degrees Fahrenheit (-20 degrees to +75 degrees Celsius). Extended storage in temperatures higher or lower than specified will damage the liquid crystal display in your unit. This type of damage is not covered by the warranty. For more information, contact the factory's Customer Service Department; phone numbers are inside the manual's back cover.

Installation & Accessories

Preparations

You can install the sonar system in some other order if you prefer, but we recommend this installation sequence:

CAUTION:

You should read over this entire installation section before drilling any holes in your vehicle or vessel!

1. Determine the approximate location for the sonar unit, so you can plan how and where to route the cables for the transducer and power. This will help you make sure you have enough cable length for the desired configuration.
2. Determine the approximate location for the transducer and its cable route.
3. Determine the location of your battery or other power connection, along with the power cable route.
4. Install the transducer and route the transducer cable to the sonar unit.
5. Route the power cable from the unit's location to an appropriate power source and connect it there.
6. Connect the transducer/power cable to the unit and mount the sonar unit on the bracket.

Transducer Installation

These instructions will help you install your Skimmer[®] transducer on a transom, on a trolling motor or inside a hull. Please read all instructions before proceeding with any installation.

Your Skimmer transducer typically comes packaged with a one-piece stainless steel bracket for mounting it to the transom of your boat. The optional trolling motor mount uses a one-piece plastic bracket with an adjustable strap. These are "kick-up" mounting brackets. They help prevent damage if the transducer strikes an object while the boat is moving. If the transducer does "kick-up," the bracket can easily be pushed back into place without tools.

Read these instructions carefully *before* attempting the installation. Determine which of the installation methods is right for your boat.

Remember, the transducer location and installation is the most critical part of a sonar installation.

Recommended Tools and supplies

If you prefer the option of routing the cable through the transom, you will need a 5/8" drill bit. (If you intend to install an additional speed or temp sensor and route its cable through the same hole in the transom, you will need a 1" (25.4 mm) drill bit to accommodate all the cables.)

NOTE:

The following installation types also call for these recommended tools and required supplies that you must provide (supplies listed here are *not* included):

Single-frequency transom installations

Tools include: two adjustable wrenches, drill, #29 (0.136") drill bit, flat-head screwdriver. Supplies: none.

Dual-frequency transom installations

Tools: two adjustable wrenches, drill, #20 (0.161") drill bit, flat-head screwdriver. Supplies: four, 1" long, #12 stainless steel slotted wood screws.

Single-frequency trolling motor installations

Tools: two adjustable wrenches, flat-head screwdriver. Supplies: plastic cable ties.

Shoot-through hull installations

Tools: these will vary depending on your hull's composition. Consult your boat dealer or manufacturer. Other tools are a wooden craft stick or similar tool for stirring and applying epoxy, and a paper plate or piece of cardboard to mix the epoxy on. Supplies: rubbing alcohol, 100 grit sandpaper, specially formulated epoxy adhesive available from LEI (see ordering information on page 20). A sandwich hull also requires polyester resin.

Selecting a Transducer Location

1. The location must be in the water at all times, at all operating speeds.
2. The transducer must be placed in a location that has a *smooth flow* of water at all times. If the transducer is not placed in a smooth flow of water, interference caused by bubbles and turbulence will show on the sonar's display in the form of random lines or dots whenever the boat is moving.

NOTE:

Some aluminum boats with strakes or ribs on the outside of the hull create large amounts of turbulence at high speed. These boats typically have large outboard motors capable of propelling the boat at speeds faster than 35 mph. Typically, a good transom location on aluminum boats is between the ribs closest to the engine.

3. The transducer should be installed with its face pointing straight down, if possible. *For shoot-thru applications:* Many popular fishing boat hulls have a flat keel pad that offers a good mounting surface. On vee hulls, try to place the transducer where the deadrise is 10° or less.

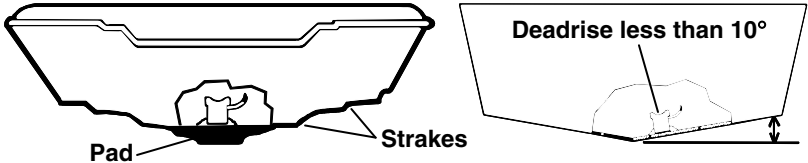

Left, vee pad hull; right, vee hull. A pod style transducer is shown here, but the principle is the same for Skimmers inside a hull.

4. If the transducer is mounted on the transom, make sure it doesn't interfere with the trailer or hauling of the boat. Also, don't mount it closer than approximately one foot from the engine's lower unit. This will prevent cavitation (bubble) interference with propeller operation.

5. If possible, route the transducer cable away from other wiring on the boat. Electrical noise from engine wiring, bilge pumps and aerators can be displayed on the sonar's screen. Use caution when routing the transducer cable around these wires.

CAUTION: Clamp the transducer cable to transom near the transducer. This will help prevent the transducer from entering the boat if it is knocked off at high speed.

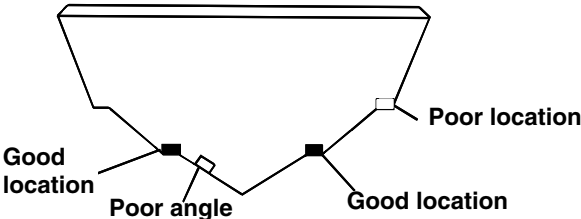
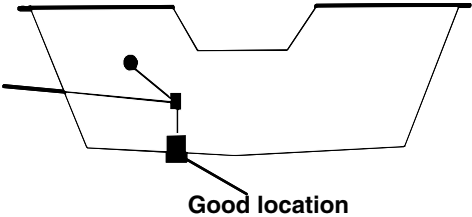

Good and poor transducer locations.

How low should you go?

For most situations, you should install your Skimmer transducer so that its centerline is level with the bottom of the boat hull. This will usually give you the best combination of smooth water flow and protection from bangs and bumps.

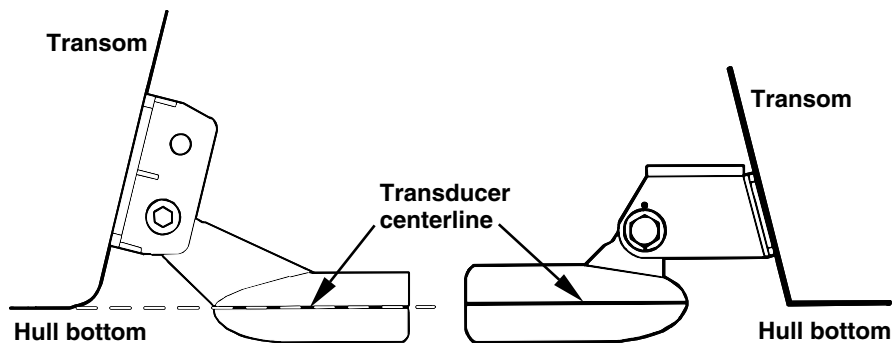

Align transducer centerline with hull bottom. A dual frequency transducer is shown at left and a single frequency transducer at right. However, there are times when you may need to adjust the transducer slightly higher or lower. (The slots in the mounting brackets allow you to loosen the screws and slide the transducer up or down.) If you frequently lose bottom signal lock while running at high speed, the transducer may be coming out of the water as you cross waves or wakes. Move the transducer a little lower to help prevent this.

If you cruise or fish around lots of structure and cover, your transducer may be frequently kicking up from object strikes. If you wish, you may move the transducer a little higher for more protection.

There are two extremes you should avoid. Never let the edge of the mounting bracket extend below the bottom of the hull. Never let the bottom – the face – of the transducer rise above the bottom of the hull.

Shoot-Thru-Hull vs. Transom Mounting

In a shoot-thru-hull installation, the transducer is bonded to the *inside* of the hull with epoxy. The sonar "ping" signal actually passes through the hull and into the water. This differs from a bolt-thru-hull installation (often called simply "thru-hull"). In that case, a hole is cut in the hull and a specially designed transducer is mounted *through* the hull with a threaded shaft and nut. This puts the transducer in direct contact with the water.

Typically, shoot-thru-hull installations give excellent high speed operation and good to excellent depth capability. There is no possibility of transducer damage from floating objects, as there is with a transom-mounted transducer. A transducer mounted inside the hull can't be knocked off when docking or loading on a trailer.

However, the shoot-thru-hull installation does have its drawbacks. First, some loss of sensitivity does occur, even on the best hulls. This varies from hull to hull, even from different installations on the same hull. This is caused by differences in hull lay-up and construction.

Second, the transducer angle cannot be adjusted for the best fish arches on your sonar display. (This is not an issue for flasher-style sonars.) Lack of angle adjustment can be particularly troublesome on hulls that sit with the bow high when at rest or at slow trolling speeds.

Third, a transducer **CAN NOT** shoot through wood and metal hulls. Those hulls require either a transom mount or a thru-hull installation.

Fourth, if your Skimmer transducer has a built in temp sensor, it will only show the temperature of the bilge, not the water surface temp.

Follow the testing procedures listed in the shoot-thru-hull installation section at the end of this instruction booklet to determine if you can satisfactorily shoot through the hull.

Transom Transducer Assembly and Mounting

The best way to install these transducers is to loosely assemble all of the parts first, place the transducer's bracket against the transom and see if you can move the transducer so that it's parallel with the ground.

The following instructions sometimes vary depending on the mounting bracket that came with your transducer. Single frequency Skimmers come with a one-piece stainless steel bracket, while dual frequency Skimmers come with a two-piece plastic mounting bracket. Use the set of instructions that fits your model.

1. Assembling the bracket.

A. One-piece bracket: Press the two small plastic ratchets into the sides of the metal bracket as shown in the following illustration. Notice there are letters molded into each ratchet. Place each ratchet into the bracket with the letter "A" aligned with the dot stamped into the metal bracket. This position sets the transducer's coarse angle adjustment for a 14° transom. Most outboard and stern-drive transoms have a 14° angle.

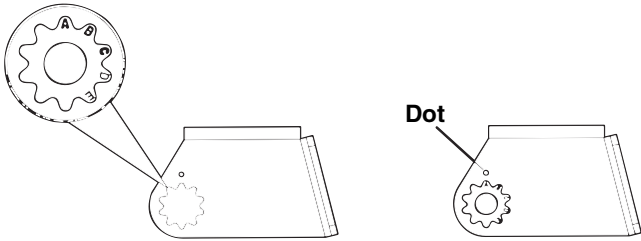

Align plastic ratchets in bracket.

B. Two-piece bracket: Locate the four plastic ratchets in the transducer's hardware package. Press two ratchets into the sides of the plastic bracket and two on either side of the transducer as shown in the following illustrations. Notice there are letters molded into each ratchet. Place the ratchets into the bracket with the letter "A" aligned

with the alignment mark molded into the bracket. Place the ratchets onto the transducer with the letter "A" aligned with the 12 o'clock position on the transducer stem. These positions set the transducer's coarse angle adjustment for a 14° transom. Most outboard and stern-drive transoms have a 14° angle.

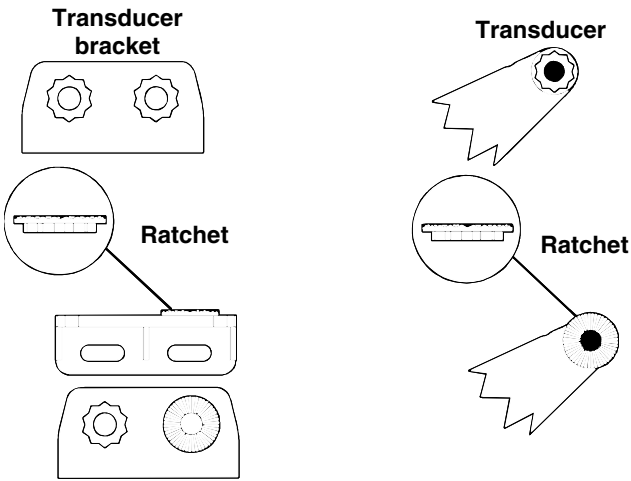
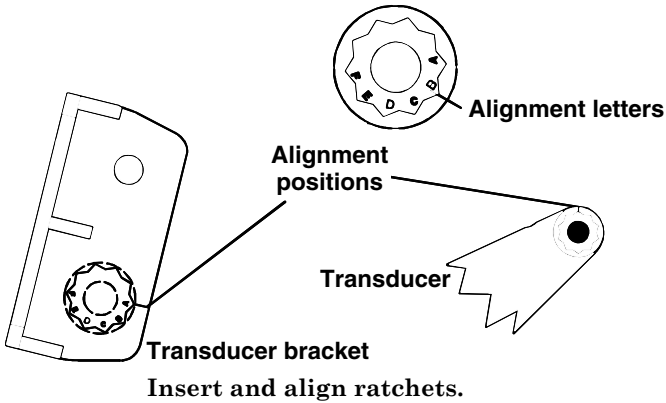

Add ratchets to bracket and transducer.

2. Aligning the transducer on the transom.

A. One-piece bracket: Slide the transducer between the two ratchets. Temporarily slide the bolt through the transducer assembly and hold it against the transom. Looking at the transducer from the side, check to see if it will adjust so that its face is parallel to the ground. If it does, then the "A" position is correct for your hull.

If the transducer's face isn't parallel with the ground, remove the transducer and ratchets from the bracket. Place the ratchets into the

holes in the bracket with the letter "B" aligned with the dot stamped in the bracket.

Reassemble the transducer and bracket and place them against the transom. Again, check to see if you can move the transducer so it's parallel with the ground. If you can, then go to step 3A. If it doesn't, repeat step 2A, but use a different alignment letter until you can place the transducer on the transom correctly.

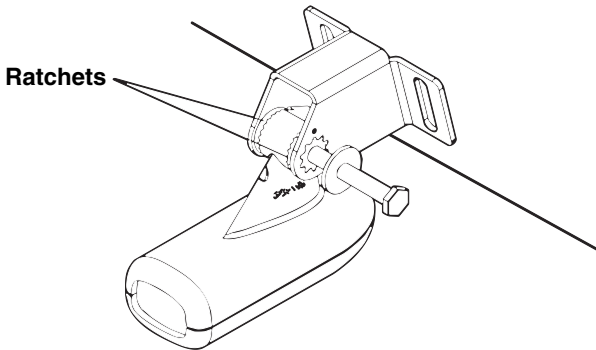

Insert bolt and check transducer position on transom.

B. Two-piece bracket: Assemble the transducer and bracket as shown in the following figure. Temporarily slide the bolt through the transducer assembly but don't tighten the nut at this time. Hold the assembled transducer and bracket against the transom. Looking at the transducer from the side, check to see if it will adjust so that its face is parallel to the ground. If it does, then the "A" positions are correct for your hull.

If the transducer's face isn't parallel with the ground, remove and disassemble the transducer and ratchets. Place the ratchets into the bracket holes with the letter "B" aligned with the bracket alignment mark. Place them on the transducer aligned with the 12 o'clock position on the transducer stem.

Reassemble the transducer and bracket and place them against the transom. Again, check to see if you can move the transducer so it's parallel with the ground. If you can, then go to step 3B. If it doesn't, repeat step 2B, but use a different alignment letter until you can place the transducer on the transom correctly.

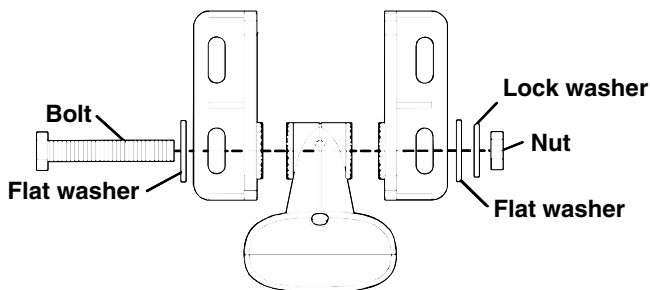

Assemble transducer and bracket.

3. Assembling the transducer.

A. One-piece bracket: Once you determine the correct position for the ratchets, assemble the transducer as shown in the following figure. Don't tighten the lock nut at this time.

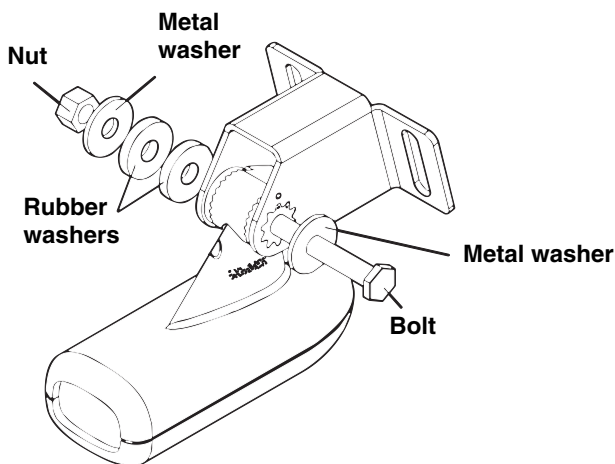

Assemble transducer and bracket.

B. Two-piece bracket: Once you determine the correct position for the ratchets, assemble the transducer as shown in the figure in step 2B. Don't tighten the lock nut at this time.

4. Drilling mounting holes.

Hold the transducer and bracket assembly against the transom. The transducer should be roughly parallel to the ground. The transducer's centerline should be in line with the bottom of the hull. Don't let the bracket extend below the hull!

Mark the center of each slot for the mounting screw pilot holes. You will drill one hole in the center of each slot.

Drill the holes. For the one-piece bracket, use the #29 bit (for the #10 screws). For the two-piece bracket, use the #20 bit (for the #12 screws).

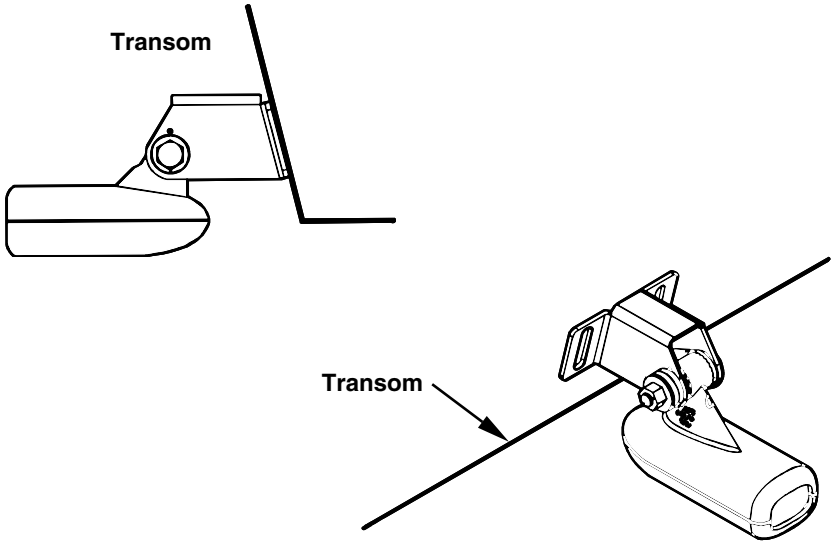

Position transducer mount on transom and mark mounting holes.
Side view shown at left and seen from above at right.

5. Attaching transducer to transom.

A. One-piece bracket: Remove the transducer from the bracket and re-assemble it with the cable passing through the bracket over the bolt as shown in the following figures.

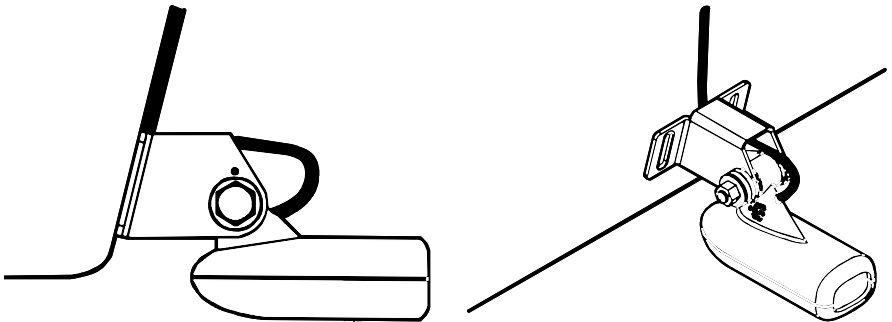

For single frequency Skimmer, route cable over bolt and through bracket. Side view shown at left and seen from above at right.

Both bracket types: Attach the transducer to the transom. Slide the transducer up or down until it's aligned properly with the bottom of the hull as shown in the preceding and following figures. Tighten the

bracket's mounting screws, sealing them with the sealant/adhesive compound.

Adjust the transducer so that it's parallel to the ground and tighten the nut until it touches the outer washer, then add 1/4 turn. *Don't over tighten the lock nut!* If you do, the transducer won't "kick-up" if it strikes an object in the water.

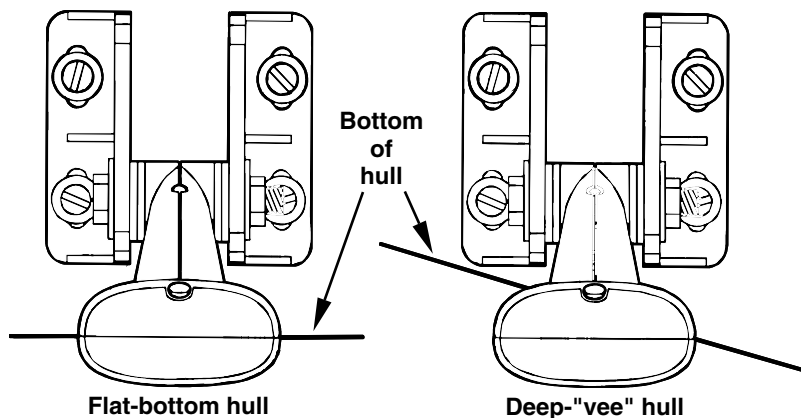

Align transducer centerline with hull bottom and attach transducer to transom. Rear view of dual frequency Skimmer shown.

- 6. Route the transducer cable through or over the transom to the sonar unit.** Make sure to leave some slack in the cable at the transducer. If possible, route the transducer cable away from other wiring on the boat. Electrical noise from the engine's wiring, bilge pumps, VHF radio wires and cables, and aerators can be picked up by the sonar. Use caution when routing the transducer cable around these wires.

WARNING:

Clamp the transducer cable to the transom close to the transducer. This can prevent the transducer from entering the boat if it is knocked off at high speed.

If you need to drill a hole in the transom to pass the connector through, the required hole size will depend on the connector on the end of your transducer's cable. If the transducer has a manual locking collar connector, you will need to drill a 1" hole. If it has a push-on self-sealing connector, you will need to drill a 5/8" hole.

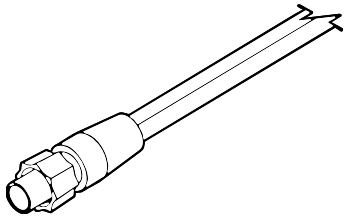

Manual locking collar connector
requires a 1" hole.

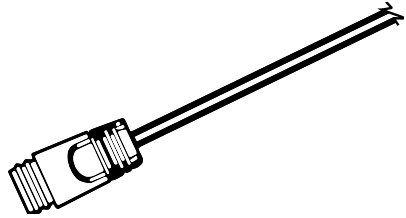

Push-on self-sealing connector
requires a 5/8" hole.

Caution:

If you drill a hole in the transom for the cable, make sure it is located above the waterline. After installation, be sure to seal the hole with the same marine grade above- or below-waterline sealant/adhesive used for the mounting screws.

- 7. Make a test run to determine the results.** If the bottom is lost at high speed, or if noise appears on the display, try sliding the transducer bracket down. This puts the transducer deeper into the water, hopefully below the turbulence causing the noise. Don't allow the transducer bracket to go below the bottom of the hull!

Trolling Motor Bracket Installation

1. Attach the TMB-S bracket to the transducer as shown in the following figure, using the hardware supplied with the transducer. (Note: The internal tooth washer is supplied with the TMB-S.)

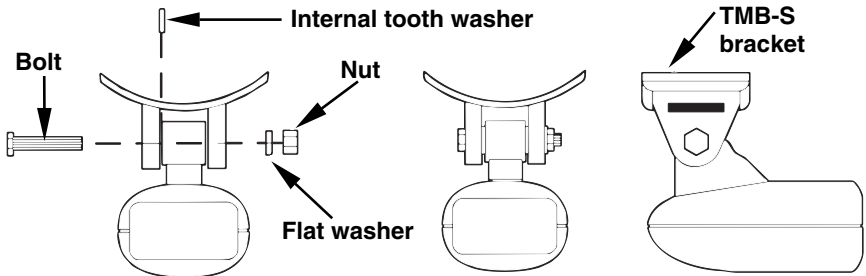

Attach motor mounting bracket to transducer.

2. Slide the adjustable strap supplied with the TMB-S through the slot in the transducer bracket and wrap it around the trolling motor. Position the transducer to aim straight down when the motor is in the water. Tighten the strap securely.
3. Route the transducer cable alongside the trolling motor shaft. Use plastic ties (not included) to attach the transducer cable to the trolling motor shaft. Make sure there is enough slack in the cable for the motor to turn freely. Route the cable to the sonar unit and the transducer is ready for use.

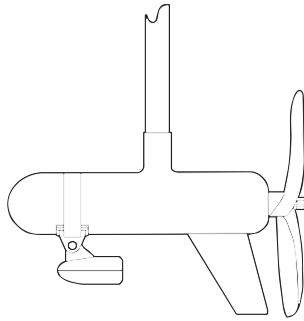

Transducer mounted on trolling motor, side view.

Transducer Orientation and Fish Arches

If you do not get good fish arches on your display, it could be because the transducer is not parallel with the ground when the boat is at rest in the water or at slow trolling speeds.

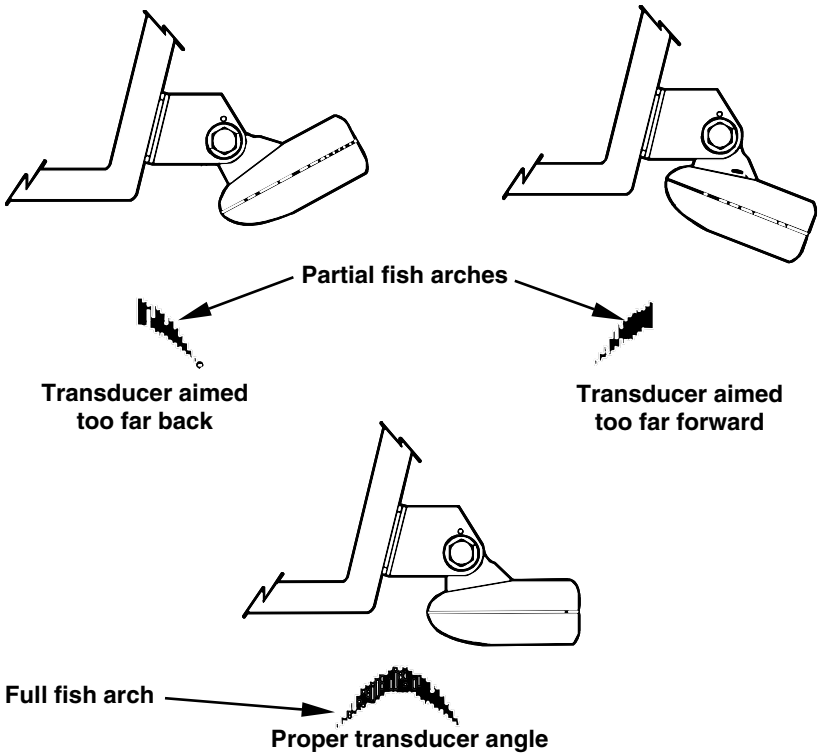

Transducer angles and their effects on fish arches.

If the arch slopes up – but not back down – then the front of the transducer is too high and needs to be lowered. If only the back half of

the arch is printed, then the nose of the transducer is angled too far down and needs to be raised.

NOTE:

Periodically wash the transducer's face with soap and water to remove any oil film. Oil and dirt on the face will reduce the sensitivity or may even prevent operation.

Shoot-Thru-Hull Preparation

The transducer installation inside a fiberglass hull must be in an area that does not have air bubbles in the resin or separated fiberglass layers. The sonar signal must pass through solid fiberglass. A successful transducer installation can be made on hulls with flotation materials (such as plywood, balsa wood or foam) between layers of fiberglass if the material is removed from the chosen area. See the figure below.

WARNING:

Do not remove any material from your inner hull unless you know the hull's composition. Careless grinding or cutting on your hull can result in damage that could sink your boat. Contact your boat dealer or manufacturer to confirm your hull specifications.

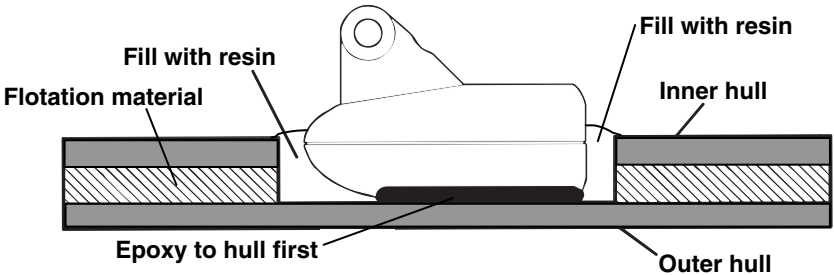

Epoxy the transducer to a solid portion of the hull.

For example, some (but not all) manufacturers use a layer of fiberglass, then a core of balsa wood, finishing with an outer layer of fiberglass. Removing the inner layer of fiberglass and the balsa wood core exposes the outer layer of fiberglass. The transducer can then be epoxied directly to the outer layer of fiberglass. After the epoxy cures for 24 hours, fill the remaining space with polyester resin. When the job is finished, the hull is watertight and structurally sound. Remember, the sonar signal must pass through *solid* fiberglass. Any air bubbles in the fiberglass or the epoxy will reduce or eliminate the sonar signals.

Testing Determines Best Location

Ideally, the shoot-thru transducer should be installed as close to the transom as possible, close to the centerline. This will give you the best performance during high speed maneuvers.

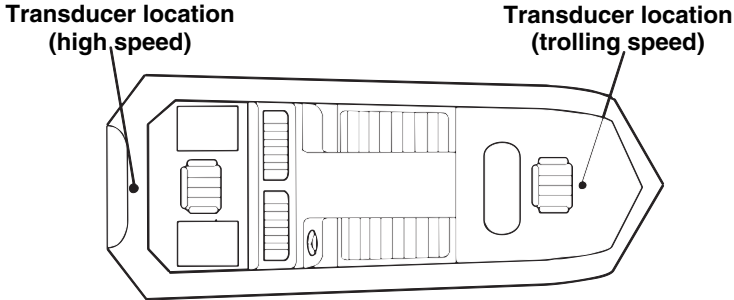

Shoot-thru-hull transducer locations for high speed or trolling speed operation.

To choose the proper location for shoot-thru-hull mounting, follow these testing procedures: (You may need a helper to complete these steps.)

1. Anchor the boat in about 30 feet of water. Add a little water to the sump of the boat. Plug the transducer into the sonar unit, turn it on, then hold the transducer over the side of the boat in the water. Adjust the sensitivity and range controls until a second bottom echo is seen on the display. (You'll need to turn off Auto Sensitivity, Auto Depth Range and ASP™. Try a range setting that is two to three times the water depth. The harder (more rocky) the bottom, the easier it will be to get a second bottom signal.) Don't touch the controls once they've been set.

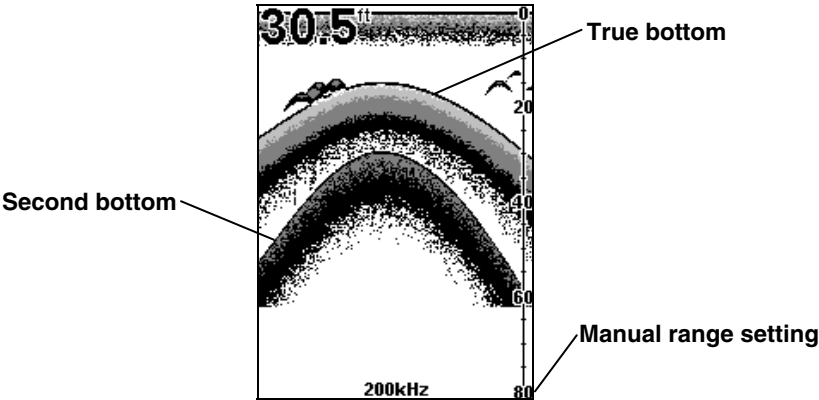

Example of a second bottom signal. Unit is in 30 feet of water, with range set at 80 feet and sensitivity set at 87 percent.

2. Next, take the transducer out of the water and place it in the water in the sump of the boat, face down. (The transducer face is shown in the

figure on the following page.) Notice how the signal strength decreases. The second bottom signal will probably disappear and the bottom signal intensity will likely decrease.

3. Now move the transducer around to find the best location with the strongest possible bottom signal. If you find a spot with an acceptable bottom signal, mark the location and move on to step 4.

If you can't get an acceptable bottom signal, try turning up the sensitivity by three or five keystrokes and then move the transducer around once more. If you find a spot that works, mark it and move on to step 4.

If you have to turn up sensitivity by more than five keystrokes to get a good signal, the transducer should be mounted on the outside of the hull. This is especially true if you have to turn sensitivity all the way up to get a decent bottom signal.

4. Most people can get good results by following steps 1 through 3, so this step is *optional*. If you want to make an extra effort to be absolutely sure that your selected location will work under all conditions, make a test run with the boat on plane and observe the bottom signal. You'll need to figure some way to prop the transducer into position while you make your test run. (A brick or two might be sufficient to hold it in place.)

5. When you're satisfied with a location, mark it and proceed with the installation.

Shoot-Thru-Hull Installation

If you are installing the transducer on a hull with flotation material sandwiched within the hull, refer to the subsection "Shoot-Thru-Hull Preparation," beginning on page 15.

1. Make sure the area is clean, dry and free of oil or grease, then sand both the inside surface of the hull and the face of the transducer with 100 grit sandpaper. The sanded hull area should be about 1-1/2 times the diameter of the transducer. The surface of the hull must be flat so the entire transducer face is in contact with the hull prior to bonding. After sanding, clean the hull and transducer with rubbing alcohol to remove any sanding debris.

WARNING:

Use *only* the epoxy available from LEI. It has been formulated to work with these installation procedures. Other epoxy types may be too thin or may not cure to the right consistency for optimum transducer performance.

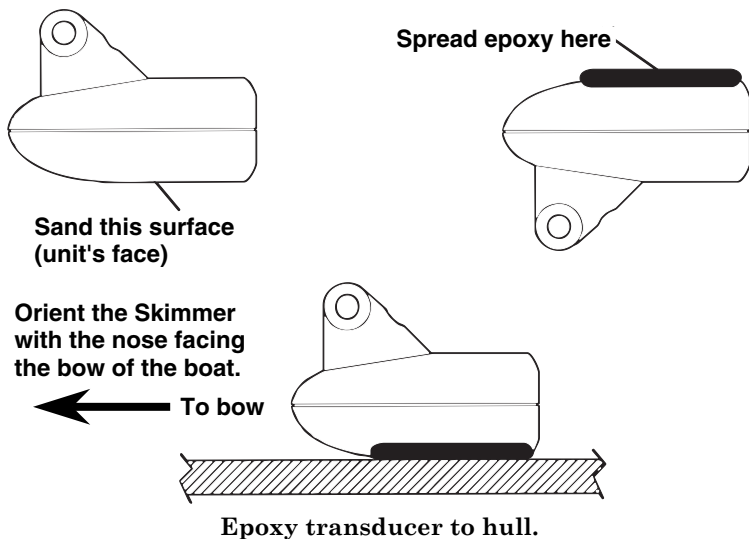

2. The epoxy consists of the epoxy itself and a hardener. Remove the two compounds from the package and place them on the paper plate.

Thoroughly stir the two compounds together until the mixture has a uniform color and consistency. Do not mix too fast or bubbles will form in the epoxy. After mixing, you have 20 minutes to complete the installation before the epoxy becomes unworkable.

Spread a thin layer of epoxy (about 1/16" or 1.5 mm thick) on the face of the transducer as shown in the previous figure. *Make sure there are no air pockets in the epoxy layer!* Then, apply the remaining epoxy to the sanded area on the hull.

3. Press the transducer into the epoxy, twisting and turning it to force any air bubbles out from under the transducer face. Stop pressing when you bottom out on the hull. When you're finished, the face of the transducer should be parallel with the hull, with a minimum amount of epoxy between the hull and transducer.

4. Apply a weight, such as a brick, to hold the transducer in place while the epoxy cures. Be careful not to bump the transducer while the epoxy is wet. Leave the weight in place for a minimum of three hours. Allow the epoxy to cure for 24 hours before moving the boat.

5. After the epoxy has cured, route the cable to the sonar unit and it's ready to use.

Speed/Temperature Sensors

Optional Temperature Sensor

All the units in this series can display water temperature from a single analog sensor. Your unit comes packed with a transducer with a temp sensor built into it. If you wish to purchase an optional additional sensor for your unit, refer to the accessory ordering information inside the back cover of this manual.

However, please note that the Sonar socket on your unit is designed to read only one temp sensor. Since your transducer contains a built-in temp sensor, attaching the optional temp sensor to your unit's Sonar socket will override the temperature information provided by the transducer's temp sensor. Your unit will *only* display the temperature provided by the optional sensor.

Optional Speed Sensor Installation

All the units in this series can display speed and distance traveled, but only the X59DF comes packed with a speed sensor. If you wish to purchase an optional additional sensor for your unit, refer to the accessory ordering information inside the back cover of this manual. The following instructions describe how to install the speed sensor.

Recommended tools for this job include: drill, 7/8" drill bit, 1/8" drill bit for pilot holes, screwdriver. Required supplies for this job include: four #8 stainless steel wood screws (3/4" long), *high quality, marine grade* above- or below-waterline sealant.

First find a location on the boat's transom where the water flow is smoothest. Don't mount the sensor behind strakes or ribs. These will disturb the water flow to the speed sensor. Make sure the sensor will remain in the water when the boat is on plane. Also make sure the location doesn't interfere with the boat's trailer. Typically, the sensor is mounted about one foot to the side of the transom's centerline.

Once you've determined the proper location for the unit, place the sensor on the transom. The bottom of the bracket should be flush with the hull's bottom. Using the sensor as a template, mark the hull for the screws' pilot holes. Drill four 1/8" holes, one in each end of the slots.

Mount the sensor to the hull using #8 stainless steel wood screws (not included). Use a *high quality, marine grade* above- or below-waterline sealant to seal the screws. Make sure the sensor is flush with the bottom of the hull and tighten the screws.

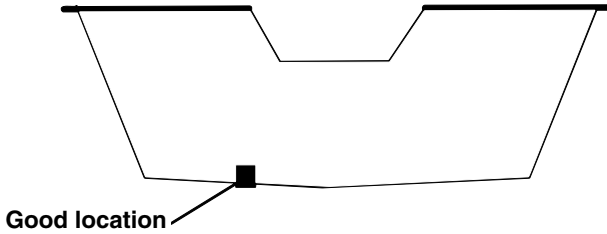

Stern view showing good location for mounting sensor on transom.

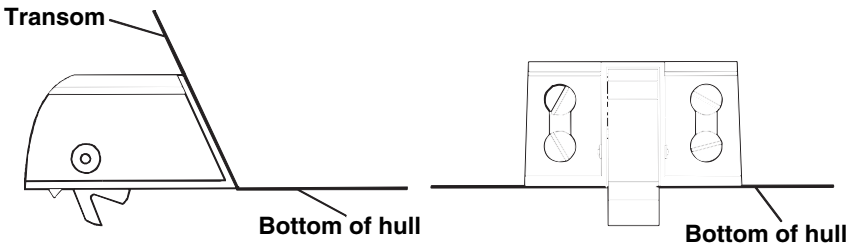

**Speed sensor mounting configuration:
side view (left) and rear view (right.)**

If the base of the transom has a radius, fill the gap between the transom and the sensor with the sealant. This will help ensure a smooth water flow.

Route the sensor's cable through or over the transom to the sonar unit. If you need to drill a hole in the transom to pass the connector through, the required hole size is 7/8".

CAUTION:

If you drill a hole in the transom for the cable, make sure it is located above the waterline. After installation, be sure to seal the hole with the same marine grade above- or below-waterline sealant used for the screws.

The sensor is now ready for use. Connect the sensor to the sonar socket on the back of your unit and connect the transducer to the speed sensor's socket. If you have any questions concerning the installation of the sensor, please contact your local boat dealer.

Power Connections

Your unit comes with a power/data cable that splits into three ends, each with several exposed wires (shown in the following figure). The end with 4 wires (blue, yellow, orange and shield) is a data cable that connects to a NMEA 0183 interface; the cable label says "RS-232 COMM". The end with three wires (red, black and shield) is a power cable that supports a NMEA 2000® buss; the cable label says "NMEA

2000 Power". The thicker three-wire cable (red, black and white) is the Power Supply for your unit (and optional external speaker connection for some units); it has no label on the cable.

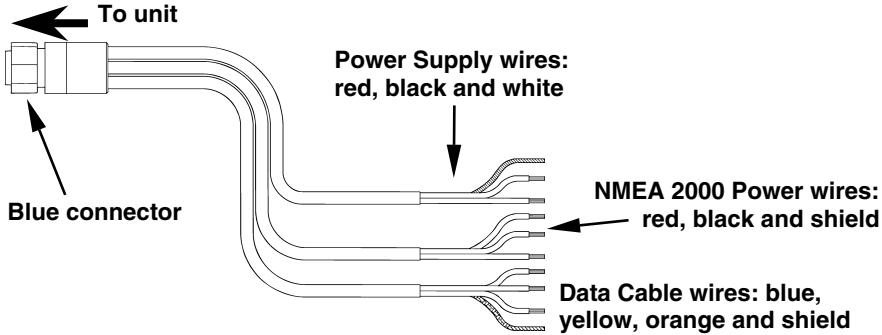

The Power/Data cable for this unit.

Depending on your configuration, you may not use all of these wires. (For example, many units cannot operate an optional external speaker, so the white wire on the Power Supply cable isn't functional.) The following segments include instructions for installing all the wires that you will use with this unit.

Powering a NMEA 2000 Buss (NMEA 2000 Power cable)

A NMEA 2000 buss must be connected to a power source to operate. If you have a pre-existing NMEA 2000 installation, it may already be connected to another power source. *If* your NMEA 2000 buss is already powered, you can ignore the NMEA 2000 Power cable. **Never attach two power sources to a single NMEA 2000 buss.**

If you do need to power your NMEA 2000 buss, attach the NMEA 2000 Power cable to your boat's battery just as indicated in the following segment for connecting your unit's Power Supply cable. The NMEA 2000 Power cable's red wire should be attached (with provided 3-amp fuse) to the boat battery's positive terminal, and the NMEA 2000 Power cable's black and shield wires should both be attached to the battery's negative terminal.

Powering Your Unit (Power Supply cable – red and black wires)

The unit works from a 12-volt battery system. For the best results, attach the power cable directly to the battery. You can attach the power cable to an accessory or power buss, however you may have problems

with electrical interference. Therefore, it's safer to go ahead and attach the power cable directly to the battery.

CAUTION:

When using the unit in a saltwater environment, we strongly recommend that you shut off the power supply to the power cable when the unit is not in use. When the unit is turned off but still connected to a power supply, electrolysis can occur in the power cable plug. This may result in corrosion of the plug body along with the electrical contacts in the cable and the unit's power socket.

In saltwater environments we recommend you connect the power cable to the auxiliary power switch included in most boat designs. If that results in electrical interference, or if such a switch is not available, we recommend connecting direct to the battery and installing an inline switch. This will let you shut off power to the power cable when the unit is not in use. When you are not using the unit, you should always shut off power to the power cable, especially when the power cable is disconnected from the unit.

If possible, keep the power cable away from other boat wiring, especially the engine's wires. This will provide the best isolation from electrical noise. If the cable is not long enough, splice #18 gauge wire onto it. The power cable has two wires, red and black. Red is the positive lead, black is negative or ground. (There is also a white wire to power an optional external speaker for some units. This unit does not use a speaker, so to prevent an electrical short, we recommend capping the exposed speaker wire end with a wire nut or electrical tape) Make sure to attach the in-line fuse holder to the red lead *as close to the power source as possible*.

For example, if you have to extend the power cable to the battery or power buss, attach one end of the fuse holder directly to the battery or power buss. This will protect both the unit and the power cable in the event of a short. It uses a 3-amp fuse.

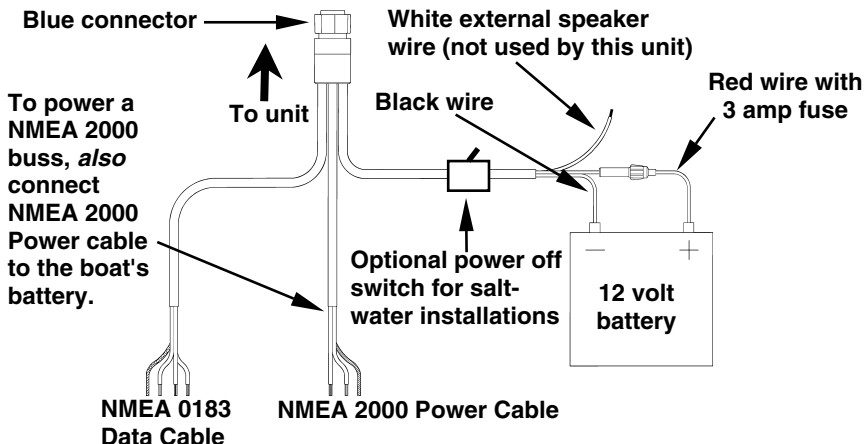

Power connections for the units in this series.

NOTES:

If you're powering a NMEA 2000 buss, you will attach *both* the NMEA 2000 Power cable *and* the unit's Power Supply cable to the boat's battery. To attach the NMEA 2000 Power cable, connect the red wire to battery's + and black and shield wires to battery's -.

If you are not powering a NMEA 2000 buss, we recommend capping all unused, exposed wire ends with wire nuts or electrical tape and tucking the excess cable out of the way. This will prevent an electrical short.

WARNING:

This product *must* be independently fused with the enclosed 3-amp fuse (or equivalent), even if you connect to a fused accessory or power buss.

If a malfunction happens inside the unit, extensive damage can occur if the enclosed fuse is not used. As with all electrical devices, this unit could be damaged to a point that it is unreparable and could even cause harm to the user when not properly fused.

CAUTION:

Do not use this product without a 3-amp fuse wired into the power cable! Failure to use a 3-amp fuse will void your warranty.

This unit has reverse polarity protection. No damage will occur if the power wires are reversed. However, the unit will not work until the wires are attached correctly.

An optional 8-foot, CA-4 external power cable with a cigarette lighter adapter is available from Lowrance.

NMEA 2000 Cable Connections

NMEA 2000 is a new buss network specifically designed for boats. This is a very young industry standard and, at the time of printing, few boats being built now have a NMEA 2000 buss installed. Over the next few years, however, NMEA 2000 will become much more common. To help you get the most out of this technology, your Lowrance unit is designed to work with a NMEA 2000 network as soon as it becomes available.

Connecting to a NMEA 2000 Network

Your unit can be connected to a NMEA 2000 buss, receiving sensor information from any Lowrance units attached to the buss. Contact LEI Extras (look inside back cover for accessory ordering information) for a NMEA 2000 buss adapter cable if you would like to do this. Simply attach the adapter cable's manual locking collar connector to the Network port on the back of the sonar unit and attach the other end to an available port on the NMEA 2000 buss, as shown in the following image.

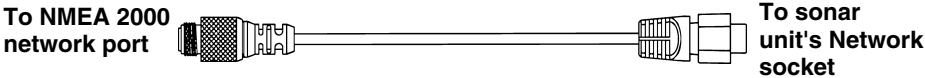

Lowrance unit direct connection to NMEA 2000 buss.

As soon as the unit is connected to the network, it will begin receiving shared information. Please note that the buss *must* be powered to operate. (For more on powering a NMEA 2000 buss, see the instructions earlier in this section.)

NMEA 0183 Cable Connections

NMEA is a standard communications format for marine electronic equipment. Your sonar unit cannot currently communicate with a NMEA 0183 network, so the Data cable wires *will not be used*. To prevent an electrical short, we recommend capping all unused, exposed wire ends with wire nuts or electrical tape and tucking the excess cable out of the way.

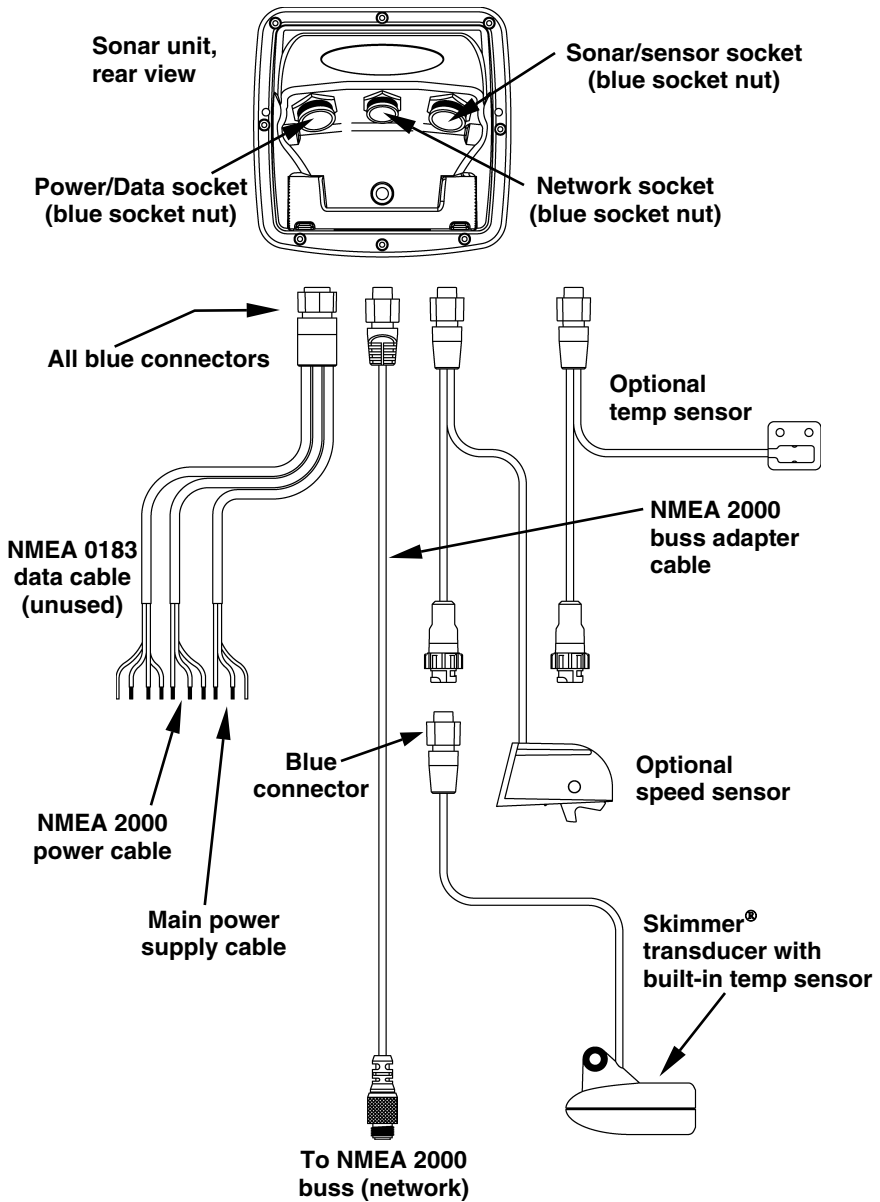

Cable connections for this unit.

Mounting the Unit: Bracket, In-Dash or Portable

You can install the unit on the top of a dash with the supplied gimbal bracket. It can also be installed in the dash or mounted on a portable power supply.

If you use the supplied bracket, you may be interested in the optional R-A-M[®] bracket mounting system. This converts the unit's gimbal bracket to a swivel mount, which can be used on the dash or overhead mounting positions.



Optional R-A-M mounting system.

Bracket Installation

Mount the unit in any convenient location, provided there is clearance behind the unit when it's tilted for the best viewing angle. You should also make sure there is enough room behind the unit to attach the power, transducer and data cables. (A drawing on the next page shows the dimensions of a gimbal-mounted unit.)

Holes in the bracket's base allow wood screw or through-bolt mounting. You may need to place a piece of plywood on the back side of thin fiberglass panels to reinforce the panel and secure the mounting hardware.

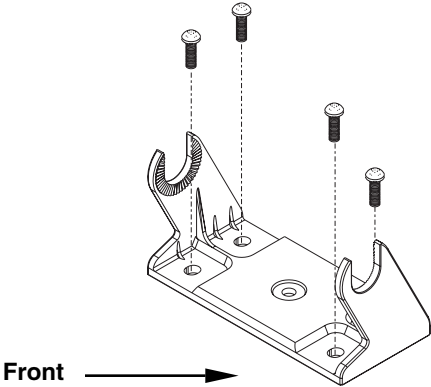

Install the gimbal bracket. Orient the bracket so the arms slope toward the front of your unit.

Drill a 1-inch (25.4 mm) hole in the dash for the power, transducer and data cables. The best location for this hole is immediately under the gimbal bracket location. This way, the bracket can be installed so that it covers the hole, holds the cables in position and results in a neat installation. Some customers, however, prefer to mount the bracket to the side of the cable hole — it's a matter of personal preference.

After drilling the hole, pass the transducer connector *up* through the hole from under the dash. Pass the power cable's bare-wire end *down* through the hole from the top.

If you wish, you can fill in the hole around the cables with a good marine caulking compound. (Some marine dealers stock cable hole covers to conceal the opening.) No matter what type of installation you prefer, be sure to leave enough slack in the cables to allow tilting or swiveling the unit. If you choose to fill in the hole, be sure to position the cables against the rear edge of the hole as you apply the fill material.

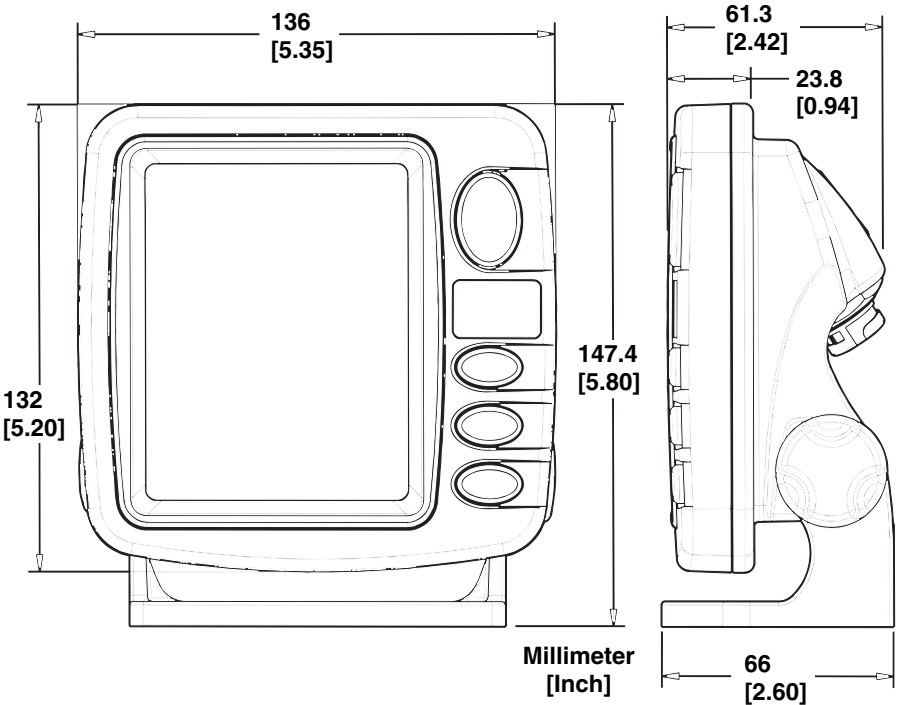

Front view (left) and side view (right) showing dimensions of X52 and X59DF sonar unit when mounted on gimbal bracket.

Before positioning the bracket, be sure to hold the cables against the rear edge of the hole. Then, slide the bracket over the hole and butt the rear of the bracket base firmly against the cables, thus pinning them in place against the side of the hole. Finally, fasten the bracket to the dash. Attach the unit to the gimbal bracket using the supplied gimbal knobs and washers.

In-Dash Installation

You can mount the unit in the dash with an optional FM-4 In-Dash Adapter Kit. The kit includes mounting hardware, a template for cutting the hole and an instruction sheet, part 988-0147-44.

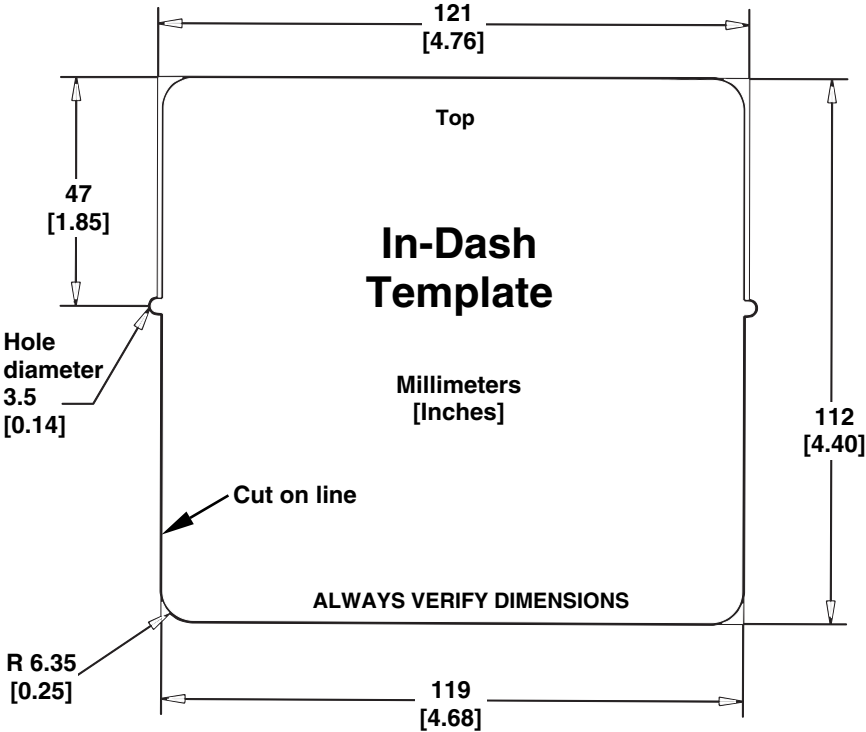

In-dash mounting template for X52 and X59DF sonars, showing dimensions. NOTE: The figure above is *not* printed to scale. A scaled template is available for free download from our web site, www.lowrance.com.

Portable Installation

Like many Lowrance products, this sonar unit is capable of portable operation by using an optional portable power pack. The power pack and an optional portable transducer expand the uses for your sonar unit. The power pack makes it easy to use the unit on your boat or take

it to the dock, on a float tube, on an ice fishing trip or use it as a second sonar in a friend's boat. Look inside the back cover of this manual for accessory ordering information.

Other Accessories

Two switch boxes are available for this unit. The SB-9BL transducer switch box switches two transducers to one sonar unit. The SB-10BL transducer switch box switches two sonar units to one transducer.

If these accessories are not available from your dealer, see the accessory ordering information on the inside back cover of this manual. Visit our web site for a complete listing of all the available accessories for your unit.

Notes

Basic Sonar Operation

KEYBOARD BASICS

The unit sounds a tone when you press any key. This tells you the unit has accepted a command. Numbers in the photo correspond to key explanations below:



Lowrance X59DF Sonar, front view, showing screen and keyboard.

1. MENU/PWR (menu and power)

This key appears in the manual text simply as **MENU**. Press this key to turn the unit on and off. While the unit is on, you can use this key to open the two major menus that access the many features that control the unit's operation. Press **MENU** once to access the Sonar Menu, or twice to access the Main Menu.

NOTE:

You must hold the **MENU** key down for a countdown of five in order to turn the unit off.

2. ENT/PAGES (enter and pages)

This key appears in the manual text simply as **ENT**. When viewing a menu or adjusting a feature, use this key to select a highlighted option. When no menus are on the screen, pressing this key will make the unit cycle through the four Sonar Chart Display Options.

3. EXIT

Press this key to clear menus from the screen and return to the Sonar Chart display. You will also use **EXIT** to cancel alarms, and to clear any information windows that may appear on the screen.

4. UP and DOWN ARROWS

These keys appear in the manual text as ↓ or ↑. Use these keys to move through the menu options and to adjust virtually every feature and function on the sonar unit.

Memory

This unit has permanent memory that saves all user settings, even when power is removed. It does not require, nor does it use an internal backup battery, so you never have to worry about replacement batteries.

Menus

Your sonar unit will work fine right out of the box with the factory default settings. You only need to learn a few basic functions to enhance your viewing. We'll discuss them briefly here, then talk about them and all the other commands in more detail in the next section, which begins on page 39.

Your unit has two primary menus that control its operation. They are the Main Menu and the Sonar Menu.

Main Menu

The Main Menu contains some basic function commands and some setup option commands. You access the Main Menu by pressing **MENU | MENU**. You run a command by using ↑ or ↓ to highlight the command and then pressing **ENT**. To clear the Main Menu screen and return to the Page display, press **EXIT**. (Remember, our text style for "**MENU | MENU**" means "press the Menu key twice." See a full explanation of our instruction text formatting on page 4, *Instructions = Menu Sequences*.)

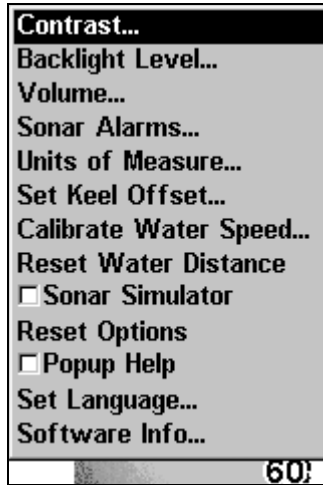

Main Menu.

Main Menu Commands

There are four "basic" Main Menu commands that you'll really want to read more about. They are:

- **Screen** commands (**CONTRAST** and **BACKLIGHT LEVEL**): change the appearance of the display screen. Use these commands to adjust how the screen looks under various lighting conditions.
- **Volume** command: controls sound levels for key strokes and alarms. If you don't like to hear a beep each time you press a key, you can turn all sounds off by setting the volume to zero. Sound is especially useful when used with the Fish I.D.TM fish symbol feature and fish alarm feature.
- **Sonar Alarms** command: turns alarms on or off and changes alarm thresholds. The fish alarm, used with Fish I.D., is the most popular use. It tells you when the sonar sees a fish. You can also set deep or shallow depth alarms.
- **Popup Help** command: turns the pop-up help boxes on or off. When you select a menu command, these information boxes appear to tell you what the command does or how to use the command. The default setting is on, which is really handy while you're learning.

The remaining Main Menu commands are for more advanced functions, mostly setting various sonar options. (They're all detailed in the Advanced Section.)

- **Units of Measure** command: selects the units of measure used for showing speed/distance, depth and temperature.

- **Set Keel Offset** command: calibrates the unit to show depth under the keel or actual depth from the surface.
- **Calibrate Water Speed** command: adjusts how a speed sensor measures water speed.
- **Reset Water Distance** command: resets water distance log to zero.
- **Sonar Simulator** command: turns the simulator feature on and off. Useful for learning how to operate the unit and all its functions.
- **Reset Options** command: returns all options and auto functions to their original factory settings. It's a great safety net while you're learning and experimenting with various settings.
- **Set Language** command: your unit has menus in 10 different languages. This command switches from one language to another.
- **Software Information** command: tells you which version of the operating software is loaded in your unit.

Sonar Menu

The Sonar Menu contains commands for the major sonar features and options. You access the Sonar Menu by pressing the **MENU** key one time. You run a command by using the \uparrow or \downarrow to highlight the command and then pressing **ENT**. To clear the menu screen and return to the Page display, press **EXIT**.

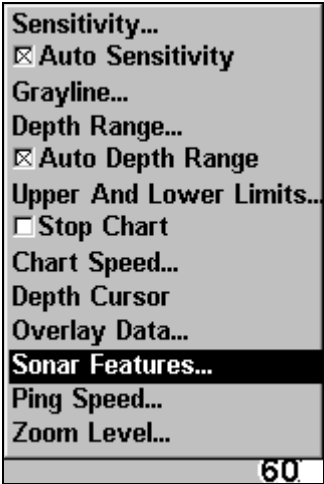

Sonar Page Menu. Most of these functions are discussed in the Advanced Section.

Sonar Menu Commands

The Sonar Menu contains commands for the major sonar features and options. Most of them are only described in detail in the Advanced

Section, but Sensitivity and Auto Sensitivity are important basic functions that are discussed both here and in the Advanced Section. The other Sonar Menu commands include:

- **Grayline™** command: separates fish and structure near the bottom from the actual bottom, and defines bottom composition/hardness.
- **Depth Range** command: manually sets the depth range shown on the sonar chart.
- **Auto Depth Range** command: automatically sets the depth range shown on the sonar chart to always keep the bottom in view.
- **Upper and Lower Limits** command: sets the upper and lower depth limits of the sonar chart. Lets you zoom in on a specific portion of the water column.
- **Stop Chart** command: stops the sonar chart from scrolling. Used when you want to "freeze" the image for closer study.
- **Chart Speed** command: sets the scrolling speed of the sonar chart.
- **Depth Cursor** command: displays a cursor line on the sonar chart which allows you to accurately measure the depth of a sonar target.
- **Overlay Data** command: chooses what types of information (such as water temperature) to show overlaid on the sonar chart screen.
- **Sonar Features** command: launches the Sonar Features menu which controls many functions and options, including screen chart mode, auto depth and sensitivity, surface clarity, noise rejection, Fish I.D.™ symbols, the zoom bar and zone bar.
- **Ping Speed** command: sets the rate at which sonar pings are made.
- **Zoom** command: controls the display size of sonar signal images.

Pages

This unit has four major display options. They are the Full Sonar Chart, Split Zoom Sonar Chart, Digital Data and Flasher.

You access the various display modes by pressing the **ENT/PAGES** key. As you press this key, the unit cycles among the four page options. To return to a previous page, simply press **ENT** until the desired page appears again.

The Full Sonar Chart is the main display option. This is a "cross-section" view of the water column beneath the boat. The chart moves across the screen, displaying sonar signal echoes that represent fish, structure and the bottom.

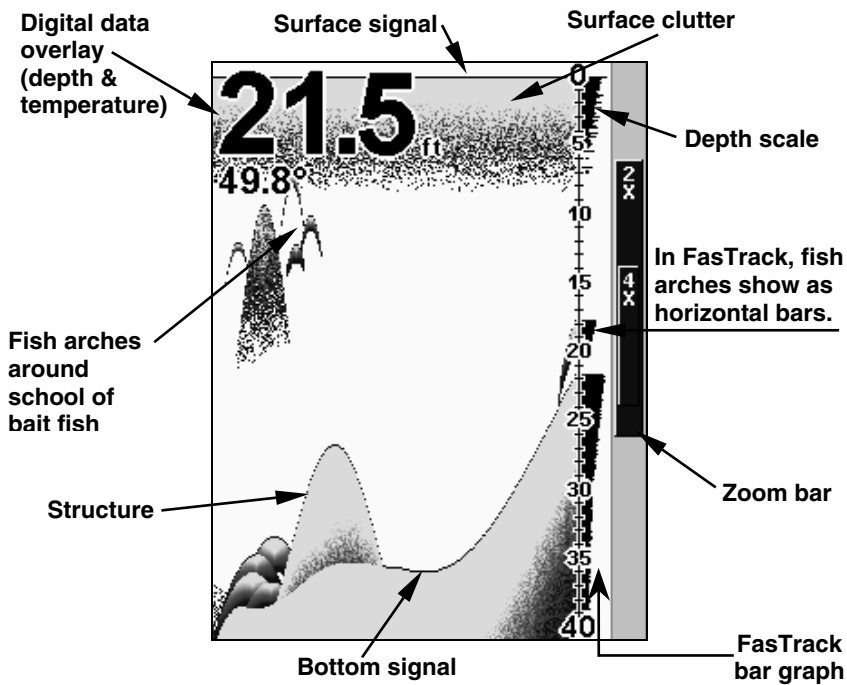

Sonar Page, showing full sonar chart mode.

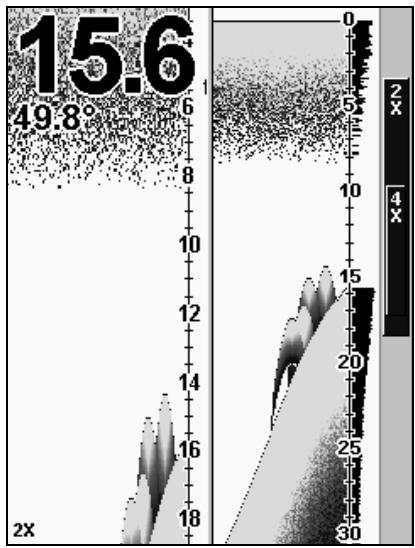
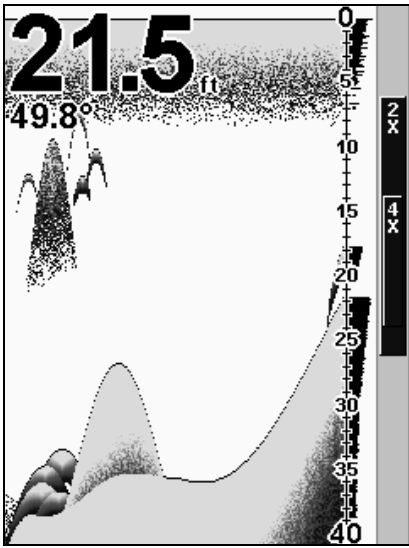

Sonar chart display options (from left) full sonar chart and split zoom.

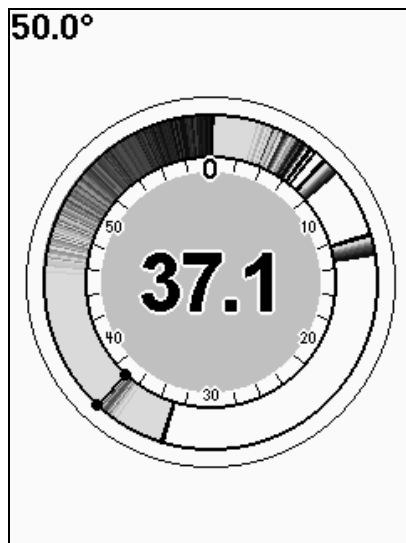
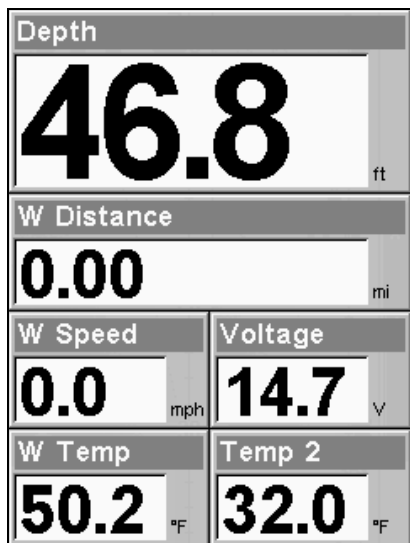

Sonar chart display options (from left) digital data and flasher.

You can customize how the Sonar Page pictures and other data are displayed in many ways. We'll discuss all of those features and options in the Advanced Section, but to show you how easy the sonar unit is to operate, the following page contains a simplified, 10-step quick reference that will cover most fish finding situations. The quick reference describes how your unit will operate with all the sonar features in their automatic modes, which are set at the factory.

Basic Sonar Quick Reference

1. Mount the transducer and unit. Connect the unit to electric power and the transducer.
2. Launch your boat.
3. To turn on the unit, press and release **MENU** key.

4. Head for your fishing grounds. Your unit automatically displays digital depth and surface water temperature in the corner of the screen.

The auto settings will track the bottom, displaying it in the lower portion of the screen. The full sonar chart will scroll from right to left, showing you what's under the boat as you cruise across the water.

5. As you're watching the sonar returns, you can change the display by:

Zoom in to enlarge the chart for more detail, or...

Zoom out to return to full chart mode.

Press **MENU** | **↑** | **ENT** to select which Zoom Mode you want to use.

6. If necessary, adjust sensitivity to improve chart readability. Press **MENU** | **ENT** and the Sensitivity Menu will appear on the left of your screen. Use **↑** and **↓** to change the setting.

Boosting sensitivity will show more information on your screen, which may cause clutter. Reducing sensitivity will filter out some information, but could omit important images. We recommend adjusting sensitivity until the background is lightly "peppered" — that is, scattered dots appear, but individual objects (like fish arches or bottom structure) can be easily picked out of the background.

7. Watch the display for the appearance of fish arches. When you see arches, you've found fish! Stop the boat and get your lure or bait into the water at the depth indicated on the sonar chart.

8. Gauge the fish depth by visually comparing the fish arches with the depth scale on the right side of the screen, or get a more accurate measure with the Depth Cursor. Press **MENU** | **↓** to **DEPTH CURSOR** | **ENT**. Press **↓** (or **↑**) to align the cursor line with the fish arch. The exact depth appears in a box at the right end of the cursor line. To clear the cursor, press **EXIT**.

9. If you are drifting at a very low speed or anchored, you are not moving fast enough for a fish to return the tell-tale fish arch signal. As you drift over a fish, or as a fish swims through the transducer's signal cone, the fish echo will appear as a straight line suspended between the surface and the bottom.

10. To turn off the unit, press and hold **MENU** key for three seconds.

Sonar Operations

As you can see from the quick reference on the previous page, basic operation is pretty easy, right out of the box. If you are a sonar novice, try operating the unit with the factory defaults until you get a feel for how it's working.

As you're learning the basics, there is one setting you might want to tinker with from time to time — Sensitivity.

Sensitivity controls the unit's ability to pick up echoes. If you want to see more detail, try increasing the sensitivity, a little at a time. There are situations when too much clutter appears on the screen. Decreasing the sensitivity can reduce the clutter and show the strongest fish echoes, if fish are present. As you change the sensitivity setting, you can see the difference on the chart as it scrolls.

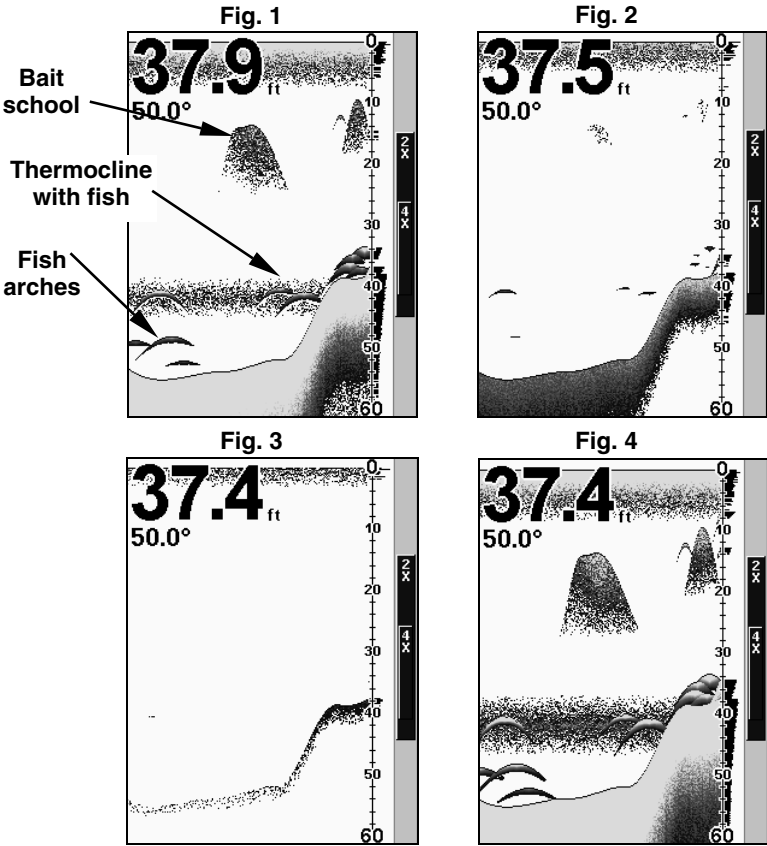

These figures show results of different sensitivity levels on the same location. Fig. 1: Sensitivity set at 87 percent. Typical of full auto mode. Fig. 2: Sensitivity set at 50 percent. Fig. 3: Sensitivity set at 20 percent. Fig. 4: Sensitivity set at 100 percent.

You can change the sensitivity level whether you are in Auto Sensitivity mode or Manual Sensitivity mode. The adjustment method works the same in both modes, but it gives you slightly different results.

Adjusting sensitivity in Auto Sensitivity Mode is similar to manually adjusting a car's speed with the accelerator pedal while cruise control is on. You can tell the car to run faster, but when you let off the gas the cruise control *automatically* keeps you from running slower than the minimum speed setting. In the sonar unit, auto mode will let you increase sensitivity to 100 percent, but the unit will *limit* your *minimum* setting. This prevents you from turning sensitivity down too low to allow automatic bottom tracking. When you change the setting with auto turned on, the unit will continue to track the bottom and make minor adjustments to the sensitivity level, with a bias toward the setting you selected.

Adjusting sensitivity in Manual Sensitivity Mode is similar to driving a car without cruise control — you have *complete* manual control of the car's speed. In the sonar unit, manual mode allows you to set sensitivity at 100 percent (maximum) or zero percent (minimum.) Depending on water conditions, the bottom signal may completely disappear from the screen when you reduce sensitivity to about 50 percent or less!

Try adjusting sensitivity in both auto and manual modes to see how they work.

To adjust sensitivity:

1. Press **MENU | ENT**.
2. The Sensitivity Control Bar appears. Press ↓ to decrease sensitivity; press ↑ to increase sensitivity. When it's set at the desired level, press **EXIT**. (When you reach the maximum or minimum limit, a tone sounds.)

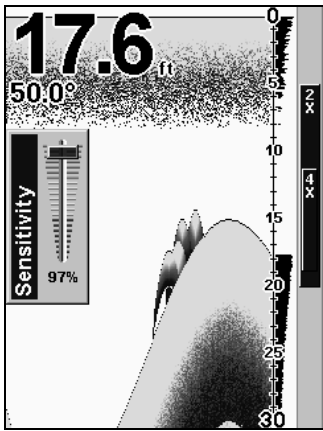

The Sensitivity Control Bar.

NOTE:

If you want to change the sensitivity in Manual Mode, first turn off Auto Sensitivity: from the Sonar Page, press **MENU** | ↓ to **AUTO SENSITIVITY** | **ENT** | ↑ to **SENSITIVITY** | **ENT**. Press ↓ or ↑ to pick a different sensitivity setting. When it's set at the desired level, press **EXIT**.

Important Tip:

While you are experimenting and learning, it's possible to scramble the settings so that the sonar picture disappears from your screen. If that happens, remember that it's easy to switch back to full automatic operation by simply restoring the factory auto settings. Here's how:

To Restore Factory Settings

1. Press **MENU** | **MENU** | ↓ to **RESET OPTIONS** | **ENT**.
2. The unit asks if you want to reset all the options. Press ↑ or ↓ to **YES** | **ENT**. All options are reset, and the unit reverts back to the original settings.

Fish Symbols vs. Full Sonar Chart

You may have noticed in the quick reference that we used fish arches in full sonar chart mode for our example, and not the popular Fish I.D.[™] fish symbol feature. Here's why.

Fish I.D. is an easier way for a sonar novice to recognize a fishy signal return when he sees it. However, locating fish by symbol *only* has some limitations.

Your sonar unit's microprocessor is remarkably powerful, but it can be fooled. Some of the echoes *calculated* to be fish could be tree limbs or turtles! *To see what's under your boat in maximum detail, we recommend you turn off Fish I.D. and begin learning to interpret fish arches.*

Fish I.D. is most handy when you're in another part of the boat or performing some task that prevents you from watching the sonar screen. Then, you can turn on Fish I.D. and the audible fish alarm. When that lunker swims under your boat, you'll hear it!

Fish I.D. can also be useful when you want to screen out some of the sonar detail gathered by your unit. For example, in one case fishermen in San Francisco Bay saw clouds of clutter in the water but no fish arches. When a down rigger was pulled up, it brought up several small jellyfish. The fishermen switched their Lowrance sonar to Fish I.D., which screened out the schools of jellyfish and clearly showed the game fish there as fish symbols.

Other Free Training Aids

The following section discusses Fish I.D., fish alarms and other features in greater detail. If you or a friend has Internet access, you can also learn more about interpreting what you see on your sonar screen. Visit our web site, **WWW.LOWRANCE.COM**. Be sure to check out the free Sonar Tutorial, which includes animated illustrations and more pictures of actual sonar returns, all described in detail. There's even a "printer friendly" version of the tutorial available on our web site...it makes a great supplement to this operation manual!

Advanced Sonar Options & Other Features

Material in this section is arranged in alphabetical order.

ASP™ (Advanced Signal Processing)

The ASP™ feature is a noise rejection system built into the sonar unit that constantly evaluates the effects of boat speed, water conditions and interference. This automatic feature gives you the best display possible under most conditions.

The ASP feature is an effective tool in combating noise. In sonar terms, noise is any undesired signal. It is caused by electrical and mechanical sources such as bilge pumps, engine ignition systems and wiring, air bubbles passing over the face of the transducer, even vibration from the engine. In all cases, noise can produce unwanted marks on the display.

The ASP feature has four settings — Off, Low, Medium and High. If you have high noise levels, try using the "High" ASP setting. However, if you are having trouble with noise, we suggest that you take steps to find the interference source and fix it, rather than continually using the unit with the high ASP setting.

There are times when you may want to turn the ASP feature off. This allows you to view all incoming echoes before they are processed by the ASP feature.

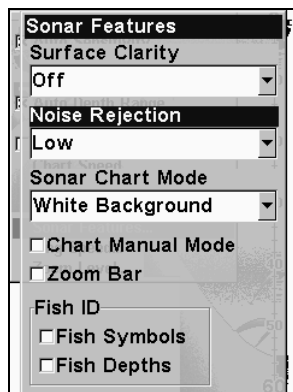

In the Sonar Features menu, Noise Rejection is selected with ASP in the default low setting.

To change the ASP level:

1. From the Sonar Page, press **MENU** | ↓ to **SONAR FEATURES** | **ENT**.
2. Press ↓ to **NOISE REJECTION** | **ENT**.
3. Press ↓ or ↑ to select a setting, then press **ENT**.
4. To return to the previous page, press **EXIT** | **EXIT**.

Alarms

This unit has two different types of sonar alarms. The first is a Fish Alarm. It sounds when the Fish I.D.[™] feature determines that an echo is a fish.

The other alarm is the Depth Alarm, which has both a Shallow and a Deep setting. Only the bottom signal will trigger this alarm. This is useful as an anchor watch, a shallow water alert or for navigation.

Depth Alarms

The depth alarms sound a tone when the bottom signal goes shallower than the shallow alarm's setting or deeper than the deep alarm's setting. For example, if you set the shallow alarm to 10 feet, the alarm will sound a tone if the bottom signal is less than 10 feet. It will continue to sound until the bottom goes deeper than 10 feet.

The deep alarm works just the opposite. It sounds a warning tone if the bottom depth goes deeper than the alarm's setting. Both depth alarms work only off the digital bottom depth signals. No other targets will trip these alarms. These alarms can be used at the same time or individually.

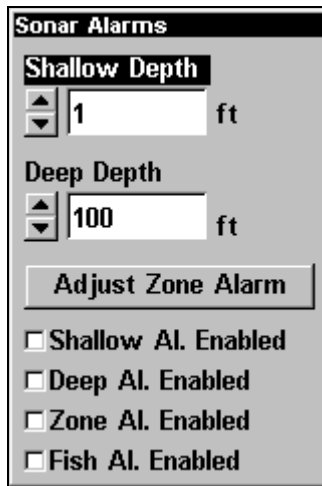

The Sonar Alarms menu.

To adjust and turn on the shallow alarm:

1. Press **MENU | MENU | ↓** to **SONAR ALARMS | ENT.**
2. Press **↓** to **SHALLOW ALARM DEPTH | ENT.**
3. Press **↑** or **↓** until the depth is correct, then press **ENT.**
4. Press **↑** to **SHALLOW ALARM ENABLED | ENT | EXIT.**
5. To turn off the alarm, press **MENU | MENU | ↓** to **SONAR ALARMS | ENT | ENT | EXIT.**

To switch to a different depth setting, open the Sonar Alarms menu and repeat the instructions in step 3 above.

To adjust and turn on the deep alarm:

1. Press **MENU | MENU | ↓** to **SONAR ALARMS | ENT**.
2. Press **↓** to **DEEP ALARM DEPTH | ENT**.
3. Press **↑** or **↓** until the depth is correct, then press **ENT**.
4. Press **↑** to **DEEP ALARM ENABLED | ENT | EXIT**.
5. To turn off the alarm, press **MENU | MENU | ↓** to **SONAR ALARMS | ENT | ↓** to **DEEP ALARM ENABLED | ENT | EXIT**.

To switch to a different depth setting, open the Sonar Alarms menu and repeat the instructions in step 3 above.

Fish Alarm

Use the fish alarm for a distinctive audible alarm when fish or other suspended objects are detected by the Fish I.D.™ feature (Fish I.D. must be turned on for the Fish Alarm to work). A different tone sounds for each fish symbol size shown on the display.

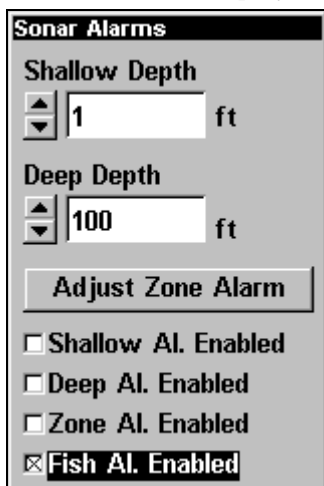

Sonar Alarms menu with Fish Alarm selected. The check box to the left is checked, indicating the alarm is turned on.

To turn the fish alarm on:

1. Press **MENU | MENU | ↓** to **SONAR ALARMS | ENT**.
2. Press **↓** to **FISH ALARM | ENT | EXIT**.
3. To turn off the alarm, press **MENU | MENU | ↓** to **SONAR ALARMS | ENT | ↓** to **FISH ALARM | ENT | EXIT**.

Backlight Level

The unit defaults to the maximum backlight level. To adjust the display's backlight level:

Press **MENU | MENU | ↓** to **BACKLIGHT LEVEL | ENT**. The **BACKLIGHT LEVEL** slider bar appears. Press **↑** or **↓** to move the bar. At The lower end of the scale backlighting is turned off; the upper end is maximum backlight level.

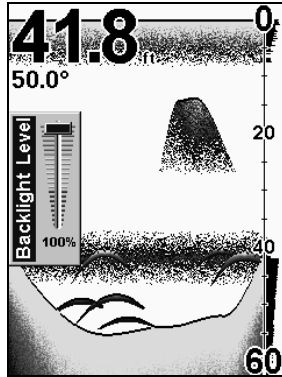

The Backlight Level control bar appears automatically whenever you turn on the unit.

Calibrate Speed

The speed sensor can be calibrated to compensate for inaccuracies. Before you change the setting, first calculate the percentage that the speed is off. You will enter this percentage in a moment.

For example, if you figure the sensor is reading 10 percent faster than actual speed, you will enter $- 10$ in the calibration window. If the sensor is reading 5 percent slower than true speed, you will enter $+ 5$ in the window.

Perform your test in relatively calm water free of current, if possible. (Unless, of course, you are taking the current speed into consideration when making your calculation.) After you have a correction figure, here's how to enter it:

1. Press **MENU | MENU | ↓** to **CALIBRATE WATER SPEED | ENT**.
2. Enter the number you calculated earlier: press **↑** or **↓** to change the displayed number. Continue until the percentage is correct, then press **EXIT**.

Chart Speed

The rate that echoes scroll across the screen is called the chart speed. The default is maximum; we recommend that you leave the speed set there for virtually all fishing conditions.

However, you might consider experimenting with chart speed when you are stationary or drifting very slowly. You may sometimes achieve better images as you slow down the chart speed to match how fast you are moving across the bottom.

If you are at anchor, ice fishing or fishing from a dock, experiment with a chart speed around 50 percent. If you are drifting slowly, try a chart speed around 75 percent. When you are stationary and a fish swims through the sonar signal cone, the image appears on the screen as a long line instead of a fish arch. Reducing the chart speed may result in a shorter line that more closely resembles a regular fish return.

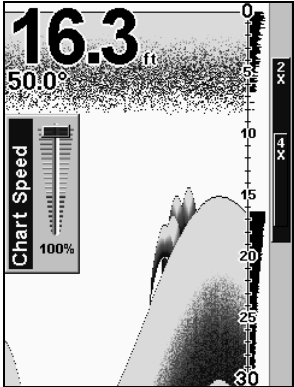

The Chart Speed Control Bar.

If you do experiment with chart speed, remember to reset it to maximum when you resume trolling or moving across the water at higher speed. To change chart speed:

1. From the Sonar Page, press **MENU** | ↓ to **CHART SPEED** | **ENT**.
2. The Chart Speed Control Bar appears. Press ↓ to decrease chart speed; press ↑ to increase chart speed.
3. When it's set at the desired level, press **EXIT**.

Grayline®

Grayline lets you distinguish between strong and weak echoes. It "paints" gray on targets that are stronger than a preset value. This allows you to tell the difference between a hard and soft bottom. For example, a soft, muddy or weedy bottom returns a weaker signal which is shown with a narrow or no gray line. A hard bottom returns a strong signal which causes a wide gray line.

If you have two signals of equal size, one with gray and the other without, then the target with gray is the stronger signal. This helps distinguish weeds from trees on the bottom, or fish from structure.

Grayline is adjustable. The factory default for this unit is 69 percent. Since Grayline shows the difference between strong and weak signals, adjusting the sensitivity may also require a different Grayline level. The level chosen by the sonar unit at power on is usually adequate for most conditions. Experiment with your unit to find the Grayline setting that's best for you.

To change the Grayline level, press **MENU** until the **GRAYLINE** menu appears.

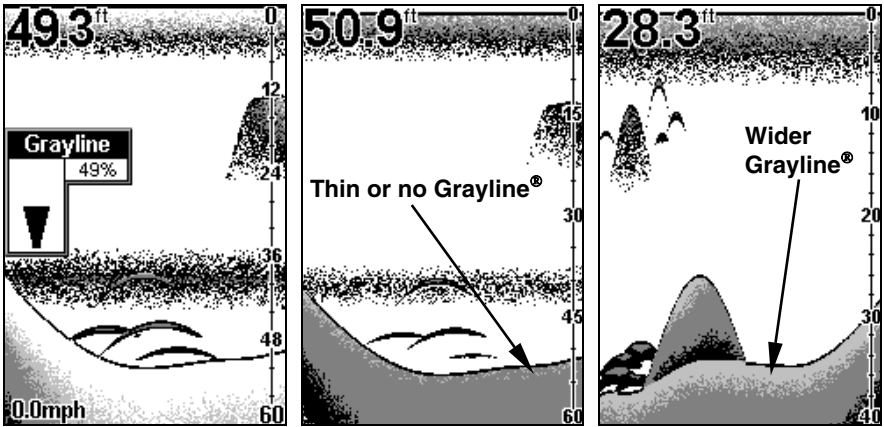

At left, Grayline menu screen. Center, little Grayline indicates a soft bottom, probably sand or mud. At right, the wider Grayline indicates a harder, rocky bottom.

Press **UP ARROW** to increase the level or press **DOWN ARROW** to decrease it. The percentage of Grayline in use shows in this menu. Echoes scrolling onto the screen will also show the effects of the Grayline change. If you reach the maximum or minimum level, a tone sounds alerting you to the limits. Press **PWR** to clear the menu.

Contrast

To adjust the display's contrast:

Press **MENU | MENU | ENT**. The **CONTRAST** slider bar appears. Press **↑** or **↓** to move the bar. The lower end of the scale is minimum contrast; the upper end is maximum contrast.

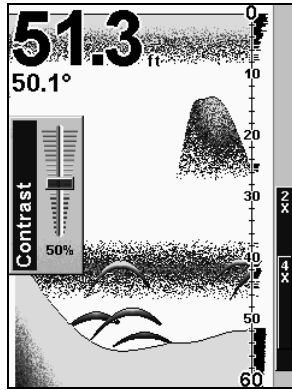

The Contrast control bar.

Depth Cursor

The depth cursor consists of a horizontal line with a digital depth box on the right side. The numbers inside the box show the depth of the cursor.

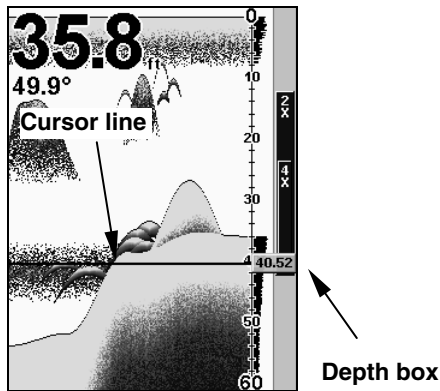

Sonar chart with the depth cursor active. The line indicates the large fish is 40.52 feet deep.

The cursor can be moved to any location on the screen, letting you pinpoint the depth of a target.

1. From the Sonar Page, press **MENU** | ↓ to **DEPTH CURSOR** | **ENT**.
2. The depth cursor appears. Press ↓ to lower the cursor line; press ↑ to raise the cursor line.
3. To clear the depth cursor, press **EXIT**.

Depth Range - Automatic

When turned on for the first time, the bottom signal is automatically placed in the lower half of the screen. This is called Auto Ranging and is part of the automatic function. However, depending upon the bottom depth and the current range, you can change the range to a different depth. To do this:

1. From the Sonar Page, press **MENU** | ↓ to **DEPTH RANGE** | **ENT**.

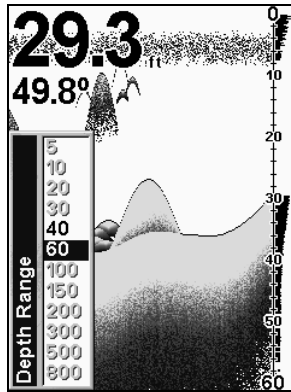

The Depth Range Control Scale.

2. The Depth Range Control Scale appears. Press ↑ or ↓ to select a different depth range. Range numbers in gray cannot be selected.
3. When the new range is selected, press **EXIT** to clear the menu.

Depth Range - Manual

You have complete control over the range when the unit is in the manual mode. There are 12 depth ranges, from 5 feet to 800 feet.

To switch to Manual Depth Range:

1. First, turn off automatic depth range. From the Sonar Page, press **MENU** | ↓ to **AUTO DEPTH RANGE** | **ENT**.
2. Press ↑ to **DEPTH RANGE** | **ENT** and the Depth Range Control Scale appears.
3. Press ↓ or ↑ to select a different depth range.
4. When the new range is selected, press **EXIT** to clear the menu.

To turn Auto Depth Range on again:

1. From the Sonar Page, press **MENU** | ↓ to **AUTO DEPTH RANGE** | **ENT** | **EXIT**.

NOTE:

The sonar's depth capability depends on the transducer installation, water and bottom conditions, and other factors.

Depth Range - Upper and Lower Limits

Virtually any segment of the water column can be displayed by using the upper and lower limit feature. This lets you pick the shallow and deep depth range limits that are shown on the screen, provided there is at least 5 feet between the upper and lower limit you select. For example, a range from 12 feet to 34 feet could be used.

Changing the upper and lower limits gives you far greater control over the depth range. This feature lets you "zoom in" the display in almost unlimited combinations. Nearly any segment of the water column, from the surface to the bottom can be shown. This enlarges the sonar targets to best suit your fishing needs and water conditions.

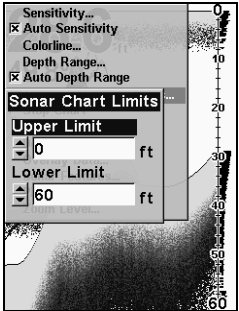

Sonar Chart Limits menu, with Upper Limit selected.

To change the upper and lower limits:

1. From the Sonar Page, press **MENU** | **↓** to **UPPER AND LOWER LIMITS** | **ENT**. The Sonar Chart Limits menu appears, with Upper Limit selected.
2. To set the upper limit, press **ENT**. Press **↑** or **↓** until the depth is correct, then press **EXIT**.

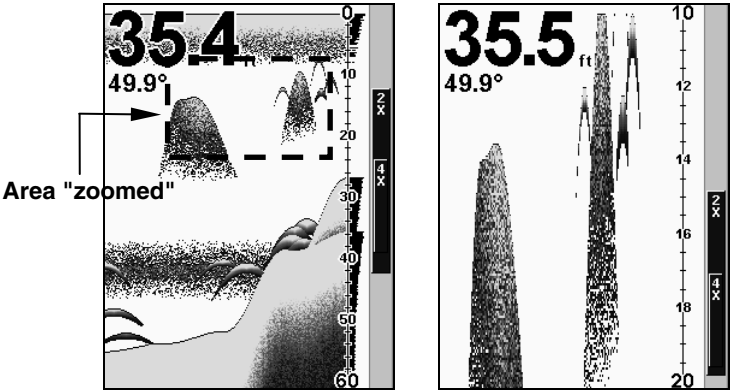

Normal display, in auto depth range mode, left. At right, display "zoomed" with Upper and Lower Limits focusing on the portion of the water column from 10 feet to 20 feet deep.

3. To set the lower limit, press ↓ to **LOWER LIMIT** | **ENT**. Press ↑ or ↓ until the depth is correct, then press **EXIT** | **EXIT** | **EXIT**.

To turn off upper and lower limits:

1. From the Sonar Page, press **MENU** | ↓ to **AUTO DEPTH RANGE** | **ENT** | **EXIT**.

FasTrack™

This feature automatically converts all echoes to short horizontal lines on the display's far right side. The graph on the rest of the screen continues to operate normally. FasTrack gives you a rapid update of conditions directly under the boat. This makes it useful for ice fishing, or when you're fishing at anchor. When the boat is not moving, fish signals are long, drawn out lines on a normal chart display. FasTrack converts the graph to a vertical bar graph that, with practice, makes a useful addition to fishing at a stationary location.

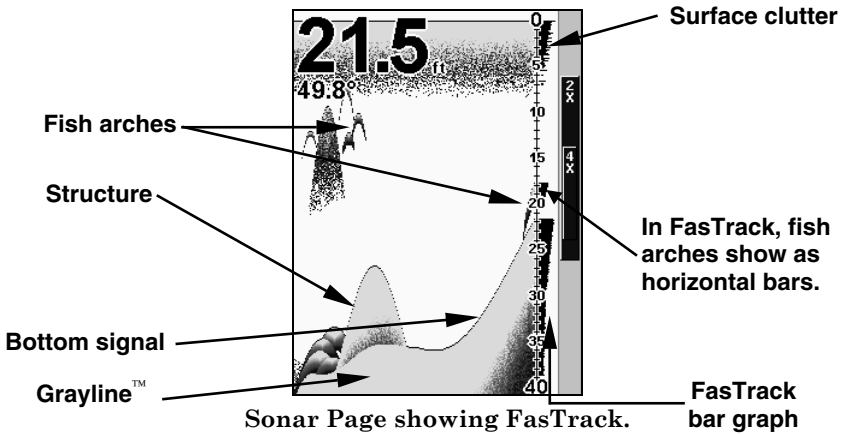

Fish I.D.™ (Fish Symbols & Depths)

The Fish I.D. feature identifies targets that meet certain conditions as fish. The microcomputer analyzes all echoes and eliminates surface clutter, thermoclines, and other signals that are undesirable. In most instances, remaining targets are fish. The Fish I.D. feature displays fish symbols on the screen in place of the actual fish echoes.

There are several fish symbol sizes. These are used to designate the relative size between targets. In other words, Fish I.D. displays a small fish symbol when it thinks a target is a small fish, a medium fish symbol on a larger target and so on.

The sonar's microcomputer is sophisticated, but it can be fooled. It can't distinguish between fish and other suspended objects such as trotlines, turtles, submerged floats, air bubbles, etc. Individual tree limbs

extending outwards from a group of limbs is the hardest object for the Fish I.D. feature to distinguish from fish.

You may see fish symbols on the screen when actually, there are no fish. The reverse is also true.

Does that mean Fish I.D. is broken? No — the feature is simply interpreting sonar returns in a specific way to help take some of the work out of reading the screen. Remember: Fish I.D. is one of the many tools we provide so you can analyze your sonar returns for maximum fish finding information. This and other features can help you successfully "see" beneath the boat under varied water and fishing conditions. So, practice with the unit in both the Fish I.D. mode and without to become more familiar with the feature. The default for Fish I.D. is off.

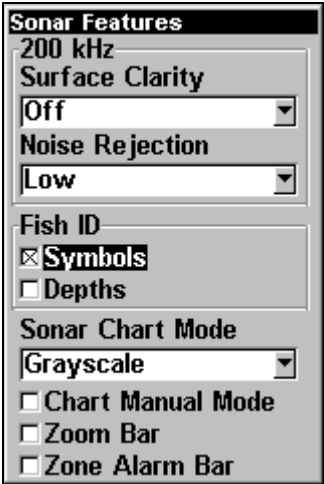

Sonar Features menu with Fish I.D. Symbols selected. When the check box to the left is checked, the feature is on.

To turn the Fish I.D. feature on:

1. From the Sonar Page, press **MENU** | **↓** to **SONAR FEATURES** | **ENT**.
2. Press **↓** to **FISH ID SYMBOLS** | **ENT** | **EXIT** | **EXIT**.

To turn off Fish I.D., repeat these instructions.

FishTrack™

The FishTrack feature shows the depth of a fish symbol when it appears on the display. This lets you accurately gauge the depth of

targets. This feature is available only when the Fish I.D. feature is on. The default setting for FishTrack is off.

To turn on FishTrack:

(**Note:** These instructions will turn on FishTrack *and* Fish I.D. at the same time.)

1. From the Sonar Page, press **MENU** | ↓ to **SONAR FEATURES** | **ENT**.
2. Press ↓ to **FISH ID DEPTHS** | **ENT** | **EXIT** | **EXIT**.

To turn off FishTrack, repeat these instructions. Turning off FishTrack in this manner will not turn off Fish I.D. symbols.

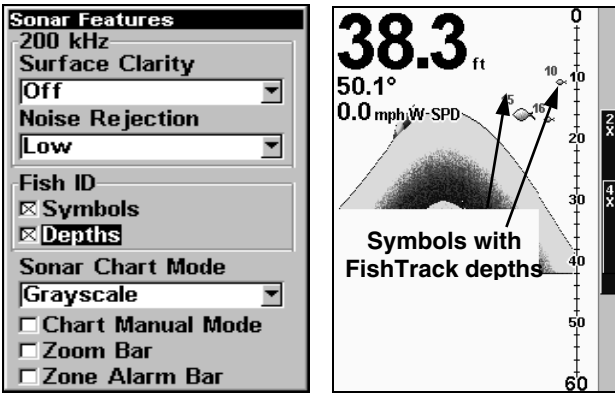

Sonar Features menu with Fish I.D. Depths selected. When the check box to the left is checked, the feature is on. At right, Sonar Page showing Fish I.D. symbols and FishTrack depths turned on.

HyperScroll™

See the entry on Ping Speed, which controls the HyperScroll feature.

Noise Rejection

See the entry on Advanced Signal Processing in this section.

Overlay Data

To change the digital data shown on top of the sonar page:

1. Press **MENU** | ↓ to **OVERLAY DATA** | **ENT**.
2. Press ↓ or ↑ to select *Data Type* | **ENT**.

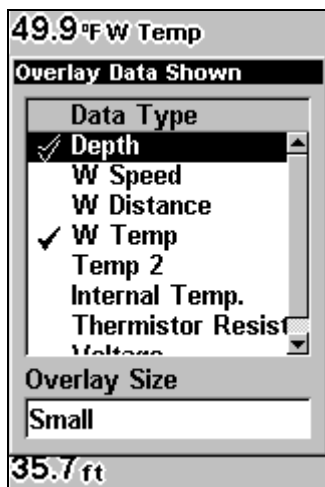

The Overlay Data selection menu.

When selected, a check mark appears beside the data type. (If you wish, you may now use ↓ or ↑ to select other Data Types for display.)

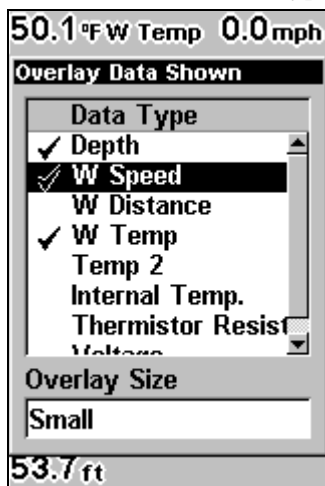

Data list showing "Water Speed" selected to display on Sonar Page.

3. To return to the previous page, press **EXIT | EXIT**.

To turn off displayed data:

1. Press **MENU | ↓** to **OVERLAY DATA | ENT**.

2. Press ↓ or ↑ to select *Data Type*, then press **ENT** until the check mark to the left of the selected data type disappears. (If you wish, you may now use ↓ or ↑ to select other Data Types to turn off.)

3. To return to the previous page, press **EXIT | EXIT**.

To change displayed data font size:

1. Press **MENU | ↓** to **OVERLAY DATA | ENT**.

2. Press **↓** or **↑** to select *Data Type*, then press **ENT**. The **DATA SIZE** (displayed in the bottom of the Overlay Data Shown window) cycles through available sizes. Keep pressing **ENT** until it shows the desired *Data Size*, then press **EXIT**.

The selected data type will be displayed in the new size. (To change the font size for another Data Type, press **ENT** and repeat these steps, beginning with step two above.)

3. To return to the previous page, press **EXIT**.

Tip:

If you wish, you can change the displayed data font size when you select a data type:

1. Press **MENU | ↓** to **OVERLAY DATA | ENT**.

2. Press **↓** or **↑** to select *Data Type* | press **ENT**. repeatedly until the desired font size is shown.

The data will be shown in the new font size. To return to the previous page, press **EXIT | EXIT**.

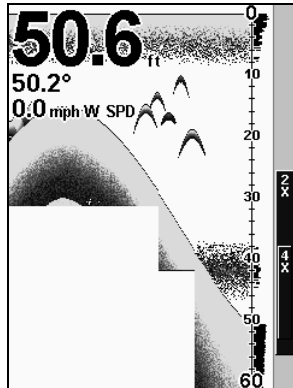

Sonar chart with Overlay Data turned on. This example shows Depth, Water Temperature and the Water Speed of the boat.

Ping Speed & HyperScroll™

Ping Speed controls the rate at which the transmitter and transducer broadcast sonar sound waves — pings — into the water. The unit has a default ping speed of 50 percent. At normal boating speeds, this automatically provides enough return echoes to refresh the screen and scroll the chart at maximum chart speed.

However, when you are running at high speeds, or just want the fastest possible screen update, you may want to use the HyperScroll™ feature. When you change the Ping Speed to any setting greater than 50 percent, the unit automatically enters HyperScroll mode.

These faster ping rates allow you to maintain a high-detail picture on the screen, and the screen refresh rate and chart scroll speed can keep pace with the boat as it moves quickly over the bottom terrain.

When using HyperScroll, you may also need to manually decrease the sensitivity for optimum performance. Depending on water depth and other conditions, HyperScroll may cause a second bottom echo to return to the transducer during the next ping cycle, or sounding. This can result in a large amount of clutter appearing on the screen. If this occurs, just decrease the sensitivity to a level that eliminates the clutter. When you turn HyperScroll off, you can return to your original sensitivity level.

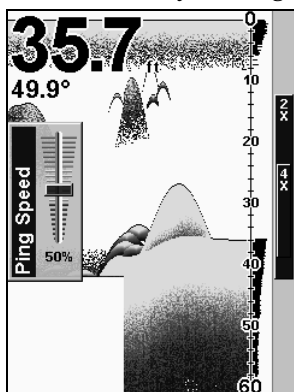

The Ping Speed Control Bar at default setting.

To change Ping Speed:

1. From the Sonar Page, press **MENU** | **↓** to **PING SPEED** | **ENT**.
2. The Ping Speed Control Bar appears. Press **↑** to increase ping speed; press **↓** to decrease ping speed. When it's set at the desired level, press **EXIT**.

To adjust Sensitivity:

1. From the Sonar Page, press **MENU** | **ENT**.
2. The Sensitivity Control Bar appears. Press **↓** to decrease sensitivity; press **↑** to increase sensitivity. When it's set at the desired level, press **EXIT**. (When you reach the maximum or minimum limit, a tone sounds.)

To turn off HyperScroll:

1. From the Sonar Page, press **MENU** | **↓** to **PING SPEED** | **ENT**.

2. The Ping Speed Control Bar appears. Press ↓ to decrease ping speed to 50 percent. When it's set at the desired level, press **EXIT**.

When you boost ping speed and switch into HyperScroll, the width of the FasTrack bar graph display doubles in width at the right side of the screen. This allows you to better see the virtually instantaneous sonar returns, just as you would on a flasher sonar unit. For more information on FasTrack, see it's entry in this section.

Pop-up Help

Help is available for virtually all of the menu labels on this unit. By highlighting a menu item and leaving it highlighted for a few seconds, a "pop-up" message appears that describes the function of the menu item. This feature is on by default.

To set up Popup Help: Press **MENU | MENU | ↓** to **POPUP HELP**. With the option highlighted, press **ENT** to check it (turn on) and uncheck it (turn off). After the option is set, press **EXIT** to return to the page display.

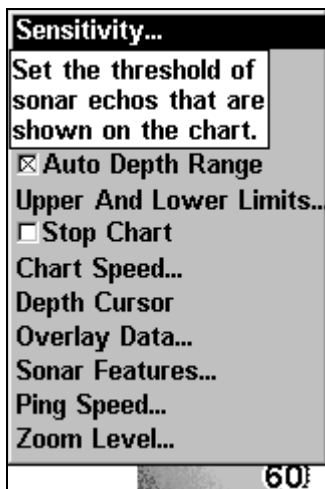

Example showing the Pop-up Help message for the Sensitivity command, located on the Sonar Menu.

Reset Options

This command is used to reset all features, options and settings to their original factory defaults. This is useful when you have changed several settings and want to return the unit to basic automatic operation.

1. Press **MENU | MENU | ↓** to **RESET OPTIONS | ENT**.
2. Press ↑ or ↓ to **Yes | ENT**.

3. All the menus are cleared and all options are returned to the factory settings.

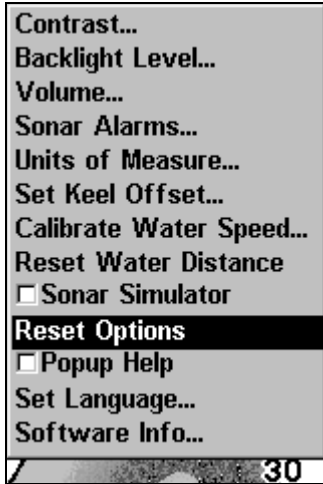

Main Menu with Reset Options command selected.

Reset Water Distance

The sonar chart's Digital Data display option includes a window that shows distance traveled, called Water Distance ("W Distance"). This information is calculated from an optional water speed sensor. The Water Distance window can be reset to zero using the Reset Water Distance command.

Press **MENU|MENU|↓** to **RESET WATER DISTANCE|ENT**. The menus are cleared and the water distance is reset to 0.00.

Screen Contrast and Backlight Level

See the separate entries in this section for Contrast and Backlight Level.

Sensitivity & Auto Sensitivity

The sensitivity controls the ability of the unit to pick up echoes. Sensitivity can be adjusted, because water conditions vary greatly. A low sensitivity level (from zero to 50 percent) excludes much of the bottom information, fish signals, and other target information.

High sensitivity levels let you see this detail, but it can also clutter the screen with many undesired signals. Typically, the best sensitivity level shows a good solid bottom signal with Grayline and some surface clutter.

Automatic Sensitivity

The default sensitivity mode is automatic. The unit bases the sensitivity level on water depth and conditions. When the unit is in the automatic mode, sensitivity is automatically adjusted to keep a solid bottom signal displayed, plus a little more power. This gives it the capability to show fish and other detail.

However, situations occur when it becomes necessary to increase or decrease the sensitivity. This typically happens when you wish to see more detail, so an increase in sensitivity is indicated. Or, wave action and boat wakes can create enough tiny air bubbles to clutter much of the water column. In that case, a decrease in sensitivity is indicated to reduce some of the clutter.

The control bar used to adjust sensitivity up or down is the same whether the unit is in the automatic or manual mode. In automatic you can adjust sensitivity up to 100 percent but the unit will limit your *minimum* setting. In auto, the unit will continue to make small adjustments, allowing for the setting you selected.

In manual mode, you have *complete* control over sensitivity, with the ability to set it anywhere from zero to 100 percent. Once you select a level in manual, the unit will continue to use that exact sensitivity setting until you change it or revert to auto mode.

To adjust sensitivity in auto mode:

1. Press **MENU | ENT**.
2. The Sensitivity Control Bar appears. Press ↓ to decrease sensitivity; press ↑ to increase sensitivity. When it's set at the desired level, press **EXIT**. (When you reach the maximum or minimum limit, a tone sounds.)

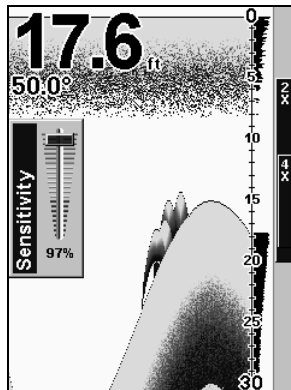

The Sensitivity Control Bar.

To adjust sensitivity in manual mode:

1. First, turn off Auto Sensitivity: from the Sonar Page, press **MENU** | ↓ to **AUTO SENSITIVITY** | **ENT**.
2. Press ↑ to **SENSITIVITY** | **ENT** and the Sensitivity Control Bar appears. Press ↓ or ↑ to pick a different sensitivity setting. When it's set at the desired level, press **EXIT**.

To turn Auto Sensitivity back on:

From the Sonar Page, press **MENU** | ↓ to **AUTO SENSITIVITY** | **ENT** | **EXIT**.

NOTE:

To return to the original factory setting for Auto Sensitivity, see the entry in this section on Reset Options. If sensitivity is in manual mode, the Reset Options command will switch back to Auto and reset the factory setting at the same time.

Tip:

For quicker sensitivity adjustments, try leaving the Sensitivity Control Bar on the screen as the chart scrolls. You can see the changes on the screen as you press the up or down arrows. This is handy when there's a lot of clutter in the water, and you are matching the sensitivity to rapidly changing water conditions.

Set Keel Offset

This unit measures water depth from the face of the transducer. Since the transducer is installed below the water surface, the distance displayed by the digital depth, chart depth scale, chart cursor or fish symbols is *not* the exact water depth. If the transducer is 1 foot below the surface, and the screen shows the water depth as 30 feet, then the actual depth is 31 feet.

On sailboats or other large vessels with deep drafts, the distance between the transducer installation and the keel or lower engine unit can be several feet. In those cases, an inexact depth reading could result in grounding or striking underwater structure. The Keel Offset feature eliminates the need for the navigator to mentally calculate how much water is under his keel.

Keel Offset lets you calibrate the digital depth indicators: chart depth scale, chart cursor depth and fish symbol depth displayed on the screen. To calibrate the depth indicators, first measure the distance from the face of the transducer to the lowest part of the boat. In this example, we will use 3.5 feet. We enter this as a *negative* 3.5 feet, which makes the depth indicators perform as if the transducer's lower in the water than it really is.

1. Press **MENU** | **MENU** | ↓ to **SET KEEL OFFSET** | **ENT**.

2. The Keel Offset dialog box appears. Press ↓ to so that the displayed number shows a minus (–) sign instead of the plus (+) sign.

3. Press ↓ until the number shows – 3.5, then press **EXIT**. The depth indicators now accurately show the depth of water beneath the keel.

NOTE:

If knowing the exact depth of water beneath the keel is less important, you can calibrate the depth indicators so that they show the actual water depth from surface to bottom. To do this, first measure the distance from the face of the transducer up to the surface (the water line on the boat). In this example, we will use 1.5 feet. This will be entered as a *positive* 1.5 feet, which makes the depth indicators perform as if the transducer's higher in the water than it really is.

1. Press **MENU | MENU | ↓** to **SET KEEL OFFSET | ENT**.

2. The Keel Offset dialog box appears with a plus (+) sign at the front of the box.

3. Press ↑ until the displayed number is + 1.5, then press **EXIT**. The depth indicators now accurately show the water depth from surface to bottom.

Set Language

This unit's menus are available in 10 languages: English, French, German, Spanish, Italian, Danish, Swedish, Russian, Dutch and Finnish. To select a different language:

1. Press **MENU | MENU | ↓** to **SET LANGUAGE | ENT**.

2. Use ↓ or ↑ to select a different language and press **ENT**. All menus now appear in the language you selected.

Software Version Information

From time to time, Lowrance updates the operating system software in some of its products. These software upgrades are usually offered to customers as free downloads from our web site, www.lowrance.com. These upgrades make the unit perform better or introduce a new feature or function. You can find out what software version is running in your sonar unit by using the Software Information command.

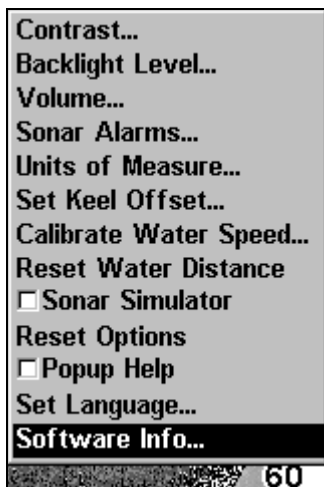

The Main Menu with Software Information command selected.

1. Press **MENU | MENU | ↓** to **SOFTWARE INFO | ENT**.
2. Read the information displayed on the screen.
3. To return to the last page displayed, press **EXIT|EXIT**.

Sonar Chart Mode

Grayscale is the default setting for the sonar chart, but we offer other variations to suit your viewing preferences. You can select the chart to be displayed in grayscale, reverse grayscale, bottom black, or fishreveal.

To change the chart mode scheme:

1. From the Sonar Page, press **MENU | ↓** to **SONAR FEATURES | ENT**.
- 2.. Press **↓** to **SONAR CHART MODE | ENT**.
3. Press **↓** or **↑** to *Mode Name* | **ENT**.
4. Press **EXIT | EXIT** to return to the Sonar Page.

Sonar Page & Sonar Chart Display Options

This unit offers four chart display options. To cycle through them, press **EXIT** to clear any menus, then press **ENT** repeatedly until the desired mode appears.

Full Sonar Chart

This is the default mode used when the unit is turned on for the first time or when it's reset to the factory defaults.

The bottom signal scrolls across the screen from right to left. Depth scales on the right side of the screen aid in determining the depth of

targets. The line at the top of the screen represents the surface. The bottom depth and surface temperature (if equipped with a temperature sensor or a transducer with a temp sensor built in) show at the top left corner of the screen.

The FasTrack™ display shows just to the right of the scale. This changes all echoes into short horizontal bars, replicating a flasher sonar. The zoom bar on the far right shows the area that's magnified when the zoom is in use. (See the Zoom section for more information.)

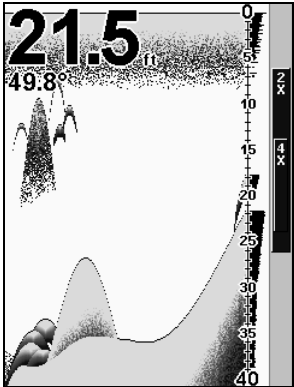

Full Sonar Chart. The Overlay Data (depth and water temperature) are each set to a different text size.

Split Zoom Sonar Chart

A split chart shows the underwater world from the surface to the bottom on the right side of the screen. The left side shows an enlarged version of the right side.

The zoom range shows at the bottom left corner of the screen.

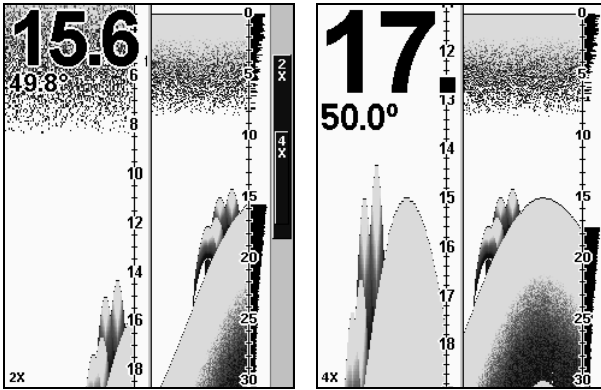

Split Zoom Sonar Chart. Image at left shows the left window zoomed to 2X. The right image shows the left window zoomed to 4X. The depth overlay data is set to the default large text size; the water temperature is set to the medium text size.

Digital Data/Chart

This mode shows six large digital boxes or windows containing: Water Depth; Water Speed (from an optional speed sensor); Water Distance (distance traveled or logged, it also requires a speed sensor); Surface Water Temperature; Temperature #2 and the unit's Voltage.

NOTE:

Temperature #2 requires an additional optional temperature sensor.)

Depth	
46.8 ft	
W Distance	
0.00 mi	
W Speed	Voltage
0.0 mph	14.7 v
W Temp	Temp 2
50.2 °F	32.0 °F

Digital Data/Chart

Flasher

The Flasher page represents a flasher style sonar. A circular dial shows all returning echoes at a high screen refresh rate. It uses the Grayline feature to show weaker targets as lighter shades. The bottom depth is also shown as a black bar across the outer circle.

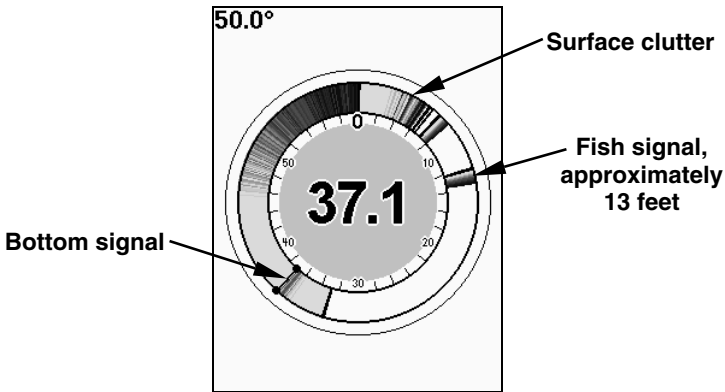

Flasher page.

Sonar Simulator

This unit has a built-in simulator that lets you run it as if you were on the water. All sonar features and functions are useable. When in simulator mode, you will see [Simulated] in the Sonar Page title bar. To use the simulator:

1. From the Sonar Page, press **MENU | MENU | ↓** to **SONAR SIMULATOR | ENT**.
2. Turn off Sonar Simulator by pressing **MENU | MENU | ↓** to **SONAR SIMULATOR | ENT | EXIT**.

NOTE:

If you turn on your unit before attaching a transducer, it may enter a demo mode. The words "demo mode" flash on the bottom of the screen and a sonar chart plays much like the simulator. Unlike the simulator, the demo mode is for demonstration only, and will automatically stop as soon as you turn on the unit with a transducer attached. The simulator will continue to function normally.

Stop Chart

If you are running multiple units on a boat, there are times when you may want to turn off the sonar. This command turns off the sonar and

stops the chart from scrolling. Sonar restarts automatically each time you turn on your unit.

Press **MENU** | ↓ to **STOP CHART** | **ENT** | **EXIT**.

To turn on sonar and start the chart scrolling again, repeat the above step.

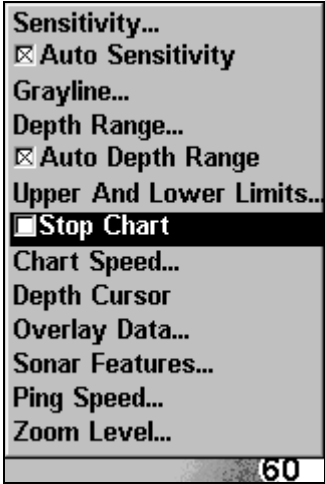

Sonar Menu with Stop Chart command selected. The box is unchecked, indicating that the chart is scrolling across the screen.

Surface Clarity

The markings extending downward from the zero line on the chart are called "surface clutter." These markings are caused by wave action, boat wakes, temperature inversion and more.

The surface clarity control reduces or eliminates surface clutter signals from the display. It does this by changing the sensitivity of the receiver, decreasing it near the surface and gradually increasing it as the depth increases.

There are three levels of surface clarity available: low, medium, or high. It can also be turned off. The default level is off.

To adjust the Surface Clarity level:

1. From the Sonar Page, press **MENU** | ↓ to **SONAR FEATURES** | **ENT** | **ENT**.

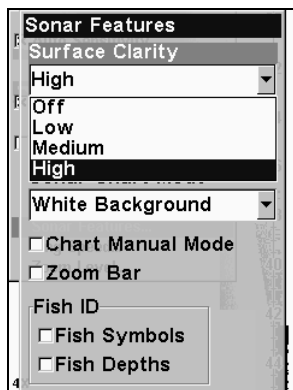

Sonar Features menu with Surface Clarity selected.

2. Press ↓ or ↑ to select *clarity level* | EXIT | EXIT | EXIT.

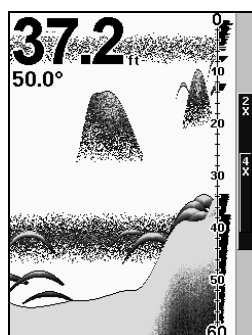
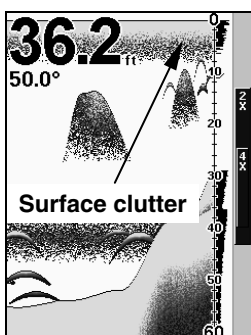

In the illustration at left, Surface Clarity is turned off.
The right view shows Surface Clarity set at High.

Units of Measure

This menu sets the speed and distance (statute or nautical miles, meters), depth (feet, fathoms, or meters) and temperature (degrees Fahrenheit or Celsius). To change the units:

Press **MENU | MENU | ↓** to **UNITS OF MEASURE | ENT.**

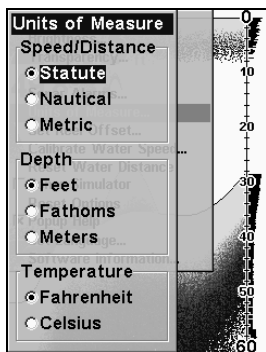

The Units of Measure Menu.

To set Units of Measure: Press ↓ to the desired units, then press **ENT**. After all the options are set as desired, press **EXIT|EXIT** to return to the page display.

Upper and Lower Limits

See the entry in this section for Depth Range - Upper and Lower Limits

Volume

This command adjusts the speaker volume, which controls the sound levels for keystrokes and alarms. If you want to turn off all sounds, set the volume to zero.

To adjust volume:

1. Press **MENU | MENU | ↓** to **VOLUME | ENT**.
2. The Volume Control Bar appears. Press ↓ to decrease the volume; press ↑ to increase the volume. When it's set at the desired level, press **EXIT**.

Zoom & Zoom Bar

"Zooming" the display is used to enlarge small detail, fish signals and the bottom with its associated structure.

The 2X zoom doubles the size of all echoes on the screen. The 4X zoom quadruples the size of the echoes. You can also turn on a zoom bar on the far right side of the screen; this shows which echoes will be displayed on the screen when the Zoom commands are used.

For example, turning on the 2X zoom will show all echoes that are between the top and bottom of the 2X zoom bar. The 4X zoom will show only the echoes between the top and bottom of the 4X zoom bar.

To switch to zoom:

1. Press **MENU** | ↓ to **ZOOM LEVEL** | **ENT**.
2. The Zoom Level menu appears. Press ↓ or ↑ to select the desired zoom level, then press **ENT** | **EXIT** to set the zoom and clear the menu.
3. To select a different zoom or turn zoom off, repeat steps 1 and 2.

To turn on the Zoom Bar:

1. Press **MENU** | ↓ to **SONAR FEATURES** | **ENT**.
2. The Sonar Features menu appears. Press ↓ to **ZOOM BAR** | **ENT** | **EXIT** | **EXIT**.
3. To turn off the Zoom Bar, repeat steps 1 and 2.

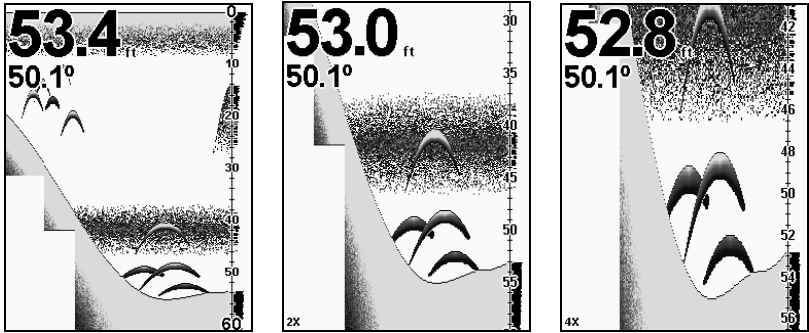

At left, Sonar Page, normal view. Center, same view zoomed to 2X. Right, same view zoomed to 4X

Tip:

From the Sonar Menu, you can go directly to the Zoom Level command with one keystroke. Instead of pressing the down arrow (↓) to reach the command, press the up arrow (↑) instead. This will take you from "Sensitivity" to "Zoom Level," because the menu "wraps" around in a circle. This trick also works on the main menu!

Zoom Pan

Your unit has the handy ability to quickly zoom in on any portion of the water column with just the touch of an arrow key. The Zoom Pan feature lets you rapidly move the zoomed area up and down to different depths. By "pointing" your zoom at different portions of the chart as it scrolls, you can get a good, close-up look at structure or cover below you.

To use Zoom Pan, switch to a manual depth Range setting (see page 46) and turn on 2X or 4X Zoom. Then, simply press ↑ or ↓ to pan up and down the water column.

Troubleshooting

If your unit is not working, or if you need technical help, please use the following troubleshooting section before contacting the factory customer service department. It may save you the trouble of returning your unit for repair. For contact information, refer to the last page, just inside the back cover of this manual.

Unit won't turn on:

1. Check the power cable's connection at the unit. Also check the wiring.
2. Make sure the power cable is wired properly. The red wire connects to the positive battery terminal, black to negative or ground.
3. Check the fuse.
4. Measure the battery voltage at the unit's power connector. It should be at least 11 volts. If it isn't, the wiring to the unit is defective, the battery terminals or wiring on the terminals are corroded, or the battery needs charging.

Unit operates only in demo mode:

1. The transducer has not yet been connected or has been disconnected. To leave demo mode, make sure the transducer is securely connected before turning the unit on.

Unit freezes, locks up, or operates erratically:

1. Electrical noise from the boat's motor, trolling motor, or an accessory may be interfering with the sonar unit. Rerouting the power and transducer cables away from other electrical wiring on the boat may help. Route the sonar unit's power cable directly to the battery instead of through a fuse block or ignition switch
2. Inspect the transducer cable for breaks, cuts, or pinched wires.
3. Check both the transducer and power connectors. Make sure both are securely plugged in to the unit.

Weak bottom echo, digital readings erratic, or no fish signals:

1. Make sure the transducer is pointing straight down. Clean the face of the transducer. Oil, dirt and fuel can cause a film to form on the transducer, reducing its effectiveness. If the transducer is mounted inside the hull, be sure it is shooting through only one layer of fiberglass and that it is securely bonded to the hull. When attaching a transducer to the inside of a hull, **ONLY** use the epoxy available from LEI (order information is inside the back cover). Do **NOT** use RTV silicone rubber adhesive or any other type of epoxy. The LEI epoxy is

specially formulated so that it will cure properly for shoot-through applications.

2. Electrical noise from the boat's motor can interfere with the sonar. This causes the sonar to automatically increase its Discrimination or noise rejection feature. This can cause the unit to eliminate weaker signals such as fish or even structure from the display.

3. The water may be deeper than the sonar's ability to find the bottom. If the sonar can't find the bottom signal while it's in the automatic mode, the digital sonar display will flash continuously. It may change the range to limits far greater than the water you are in. If this happens, place the unit in the manual mode, then change the range to a realistic one, (for example, 0-100 feet) and increase the sensitivity. As you move into shallower water, a bottom signal should appear.

4. Check the battery voltage. If the voltage drops, the unit's transmitter power also drops, reducing its ability to find the bottom or targets.

Bottom echo disappears at high speeds or erratic digital reading or weak bottom echo while boat is moving

1. The transducer may be in turbulent water. It must be mounted in a smooth flow of water in order for the sonar to work at all boat speeds. Air bubbles in the water disrupt the sonar signals, interfering with its ability to find the bottom or other targets. The technical term for this is cavitation.

2. Electrical noise from the boat's motor can interfere with the sonar. This causes the sonar to automatically increase its Discrimination or noise rejection feature. This can cause the unit to eliminate weaker signals such as fish or even structure from the display. Try using resistor spark plugs or routing the sonar unit's power and transducer cables away from other electrical wiring on the boat.

No fish arches when the Fish I.D. feature is off:

1. Make sure the transducer is pointing straight down. This is the most common problem if a partial arch is displayed.

2. The sensitivity may not be high enough. In order for the unit to display a fish arch, it has to be able to receive the fish's echo from the time it enters the cone until it leaves. If the sensitivity is not high enough, the unit shows the fish only when it is in the center of the cone.

3. Use the Zoom feature. It is much easier to display fish arches when zoomed in on a small range of water than a large one. For example, you will have much better luck seeing fish arches with a 30 to 60 foot range than a 0 to 60 foot range. This enlarges the targets, allowing the display to show much more detail.

4. The boat must be moving at a slow trolling speed to see fish arches. If the boat is motionless, fish stay in the cone, showing on the screen as straight horizontal lines.

Noise

A major cause of sonar problems is electrical noise. This usually appears on the sonar's display as random patterns of dots or lines. In severe cases, it can completely cover the screen with black dots, or cause the unit to operate erratically, or not at all.

To eliminate or minimize the effects of electrical noise, first try to determine the cause. With the boat at rest in the water, the first thing you should do is turn all electrical equipment on the boat off. Make sure the engine is also off. Turn your sonar on, then turn off Noise Reject [also known as the ASP feature (Advanced Signal Processing)]. Sensitivity should be set at 90-95 percent. There should be a steady bottom signal on the display. Now turn on each piece of electrical equipment on the boat and view the effect on the sonar's display. For example, turn on the bilge pump and view the sonar display for noise. If no noise is present, turn the pump off, then turn on the VHF radio and transmit. Keep doing this until all electrical equipment has been turned on, their effect on the sonar display noted, then turned off.

If you find noise interference from an electrical instrument, trolling motor, pump, or radio, try to isolate the problem. You can usually reroute the sonar unit's power cable and transducer cable away from the wiring that is causing the interference. VHF radio antenna cables radiate noise when transmitting, so be sure to keep the sonar's wires away from it. You may need to route the sonar unit's power cable directly to the battery to isolate it from other wiring on the boat.

If no noise displays on the sonar unit from electrical equipment, then make sure everything except the sonar unit is turned off, then start the engine. Increase the RPM with the gearshift in neutral. If noise appears on the display, the problem could be one of three things; spark plugs, alternator, or tachometer wiring. Try using resistor spark plugs, alternator filters, or routing the sonar unit's power cable away from engine wiring. Again, routing the power cable directly to the battery helps eliminate noise problems. Make sure to use the in-line fuse supplied with the unit when wiring the power cable to the battery.

When no noise appears on the sonar unit after all of the above tests, then the noise source is probably cavitation. Many novices or persons with limited experience make hasty sonar installations which function perfectly in shallow water, or when the boat is at rest. In nearly all cases, the cause of the malfunction will be the location and/or angle of the transducer. The face of the transducer must be placed in a location

that has a smooth flow of water at all boat speeds. Read your transducer owner's manual for the best mounting position.

Index

A

Accessories, 1, 3, 25, 26, 29
Alarms, 33, 44, 45; Depth
Alarms, 44; Fish Alarm, 44,
45
Antenna, 73
ASP™ (Advanced Signal
Processing), 16, 43

B

Backlights / Lighting, 1, 33, 46,
59
Batteries, 3, 21, 22, 23, 32, 71,
72, 73

C

Calibrate Speed, 46
Chart Speed, 35, 46, 47
Communications Ports, 20, 21,
23, 24
Contrast, 33, 48, 49, 59
Cursor, 35, 38, 49, 61

D

Depth Cursor, 35, 38, 49
Depth Range, 16, 35, 50, 51, 52,
64, 70, 72; Automatic, 50;
Manual, 50; Upper and
Lower Limits, 35, 51, 69
Display Options, 31, 35, 63, 64,
65

F

FasTrack™, 52
Fish Depths, 53
Fish I.D.™, 33, 35, 41, 44, 45,
52
Fish Symbols, 33, 35, 41, 44,
45, 52; Interpreting, 41
FishTrack™, 53
Frequency, 2

G

Grayline®, 35, 47

H

HyperScroll™, 54, 56, 57

I

Installation, 3, 17, 19, 26, 28
Introduction: Specifications, 1

K

Keel Offset, 34, 61, 62
Keyboard, 31

L

Languages, 34, 62

M

Main Menu, 31, 32, 33, 59, 63

N

NMEA, 20, 21, 23, 24
Noise Rejection, 43, 54

O

Overlay Data, 35, 54, 55, 56, 64

P

Page Displays, 35; Digital Data,
35, 59, 65
Ping Speed, 35, 54, 56, 57, 58;
HyperScroll™, 54, 56, 57
Pop-up Help, 58
Power, 1, 2, 3, 20, 21, 22, 23,
24, 25, 26, 27, 28, 31, 32, 38,
48, 60, 71, 72, 73
Product Specifications, 1

R

Range, 16, 35, 50, 51, 52, 64,
70, 72; Automatic, 50;
Manual, 50; Upper and
Lower Limits, 51, 69
Reset Options, 34, 41, 58, 59, 61

Reset Water Distance, 34, 59
Route, 3, 4, 5, 11, 12, 13, 18, 20,
71, 73

S

Sensitivity, 16, 35, 38, 39, 40,
41, 57, 58, 59, 60, 61, 70, 73
Simulator, 1, 34, 66
Software Version Information,
62
Sonar Chart Color Mode, 63
Sonar Chart Display Options,
31, 35, 63, 64, 65
Sonar Menu, 31, 32, 34, 58, 67,
70
Sonar Operation: Quick
Reference, 38
Speaker, 21, 22, 69
Speed Sensors, 1, 2, 19, 20, 34,
46, 59, 65
Stop Chart, 35, 66, 67

Surface Clarity, 67, 68

T

Temperature Sensors, 2, 4, 7,
19, 64
Transducer, 1, 2, 3, 4, 5, 6, 7, 8,
9, 10, 11, 12, 13, 14, 15, 16,
17, 18, 19, 20, 26, 27, 28, 29,
38, 43, 50, 56, 57, 61, 62, 64,
66, 71, 72, 73; Mounting, 7,
13; Shoot-Thru-Hull, 6, 15, 17

U

Units of Measure, 33, 68, 69
Upper and Lower Limits, 35,
51, 69

Z

Zooming, 2, 35, 38, 64, 69, 70,
72; Zoom Bar, 69, 70; Zoom
Pan, 70

LOWRANCE ELECTRONICS FULL ONE-YEAR WARRANTY

"We," "our," or "us" refers to LOWRANCE ELECTRONICS, INC., the manufacturer of this product. "You" or "your" refers to the first person who purchases this product as a consumer item for personal, family or household use.

We warrant this product against defects or malfunctions in materials and workmanship, and against failure to conform to this product's written specifications, all for one (1) year from the date of original purchase by you. **WE MAKE NO OTHER EXPRESS WARRANTY OR REPRESENTATION OF ANY KIND WHATSOEVER CONCERNING THIS PRODUCT.** Your remedies under this warranty will be available so long as you can show in a reasonable manner that any defect or malfunction in materials or workmanship, or any non-conformity with the product's written specifications, occurred within one year from the date of your original purchase, which must be substantiated by a dated sales receipt or sales slip. Any such defect, malfunction, or non-conformity which occurs within one year from your original purchase date will either be repaired without charge or be replaced with a new product identical or reasonably equivalent to this product, at our option, within a reasonable time after our receipt of the product. If such defect, malfunction, or non-conformity remains after a reasonable number of attempts to repair by us, you may elect to obtain without charge a replacement of the product or a refund for the product. **THIS REPAIR, OR REPLACEMENT OR REFUND (AS JUST DESCRIBED) IS THE EXCLUSIVE REMEDY AVAILABLE TO YOU AGAINST US FOR ANY DEFECT, MALFUNCTION, OR NON-CONFORMITY CONCERNING THE PRODUCT OR FOR ANY LOSS OR DAMAGE RESULTING FROM ANY OTHER CAUSE WHATSOEVER. WE WILL NOT UNDER ANY CIRCUMSTANCES BE LIABLE TO ANYONE FOR ANY SPECIAL, CONSEQUENTIAL, INCIDENTAL, OR OTHER INDIRECT DAMAGE OF ANY KIND.**

Some states do not allow the exclusion or limitation of incidental or consequential damages, so the above limitations or exclusions may not apply to you.

This warranty does NOT apply in the following circumstances: (1) when the product has been serviced or repaired by anyone other than us; (2) when the product has been connected, installed, combined, altered, adjusted, or handled in a manner other than according to the instructions furnished with the product; (3) when any serial number has been effaced, altered, or removed; or (4) when any defect, problem, loss, or damage has resulted from any accident, misuse, negligence, or carelessness, or from any failure to provide reasonable and necessary maintenance in accordance with the instructions of the owner's manual for the product.

We reserve the right to make changes or improvements in our products from time to time without incurring the obligation to install such improvements or changes on equipment or items previously manufactured.

This warranty gives you specific legal rights and you may also have other rights which may vary from state to state.

REMINDER: You must retain the sales slip or sales receipt proving the date of your original purchase in case warranty service is ever required.

**LOWRANCE ELECTRONICS
12000 E. SKELLY DRIVE, TULSA, OK 74128
(800) 324-1356**

How to Obtain Service...

...in the USA:

We back your investment in quality products with quick, expert service and genuine Lowrance parts. If you're in the United States and you have technical, return or repair questions, please contact the Factory Customer Service Department. Before any product can be returned, you must call customer service to determine if a return is necessary. Many times, customer service can resolve your problem over the phone without sending your product to the factory. To call us, use the following toll-free number:

800-324-1356

8 a.m. to 5 p.m. Central Standard Time, M-F

Lowrance Electronics may find it necessary to change or end our shipping policies, regulations, and special offers at any time. We reserve the right to do so without notice.

...in Canada:

If you're in Canada and you have technical, return or repair questions, please contact the Factory Customer Service Department. Before any product can be returned, you must call customer service to determine if a return is necessary. Many times, customer service can resolve your problem over the phone without sending your product to the factory. To call us, use the following toll-free number:

800-661-3983

905-629-1614 (not toll-free)

8 a.m. to 5 p.m. Eastern Standard Time, M-F

...outside Canada and the USA:

If you have technical, return or repair questions, contact the dealer in the country where you purchased your unit. To locate a dealer near you, visit our web site and look for the Dealer Locator (www.lowrance.com/support/dealerlocator). Or, you can consult your telephone directory for listings.

Accessory Ordering Information for all countries

To order Lowrance accessories, please contact:

1) Your local marine dealer. Most quality dealers that handle marine electronic equipment should be able to assist you with these items.

To locate a Lowrance dealer near you, visit our web site and look for the Dealer Locator (www.lowrance.com/support/dealerlocator). Or, you can consult your telephone directory for listings.

2) U.S. customers: LEI Extras Inc., PO Box 129, Catoosa, OK 74015-0129
Call 1-800-324-0045 or visit our web site www.lei-extras.com.

3) Canadian customers can write:

Lowrance/Eagle Canada, 919 Matheson Blvd. E. Mississauga, Ontario L4W2R7 or fax 905-629-3118.

Shipping Information

If it becomes necessary to send a product for repair or replacement, you must first receive a return authorization number from Customer Service. Products shipped without a return authorization will not be accepted. When shipping, we recommend you do the following:

1. Please do not ship the knobs or mounting bracket with your unit.
2. If you are sending a check for repair, please place your check in an envelope and tape it to the unit.
3. For proper testing, include a brief note with the product describing the problem. Be sure to include your name, return shipping address and a daytime telephone number. An e-mail address is optional but useful.
4. Pack the unit in a suitable size box with packing material to prevent any damage during shipping.
5. Write the Return Authorization (RA) number on the outside of the box underneath your return address.
6. For your security, you may want to insure the package through your shipping courier. Lowrance does not assume responsibility for goods lost or damaged in transit.

Visit our web site:



L[®] LOWRANCE

We Lead, We Find, You Win.[™]

Lowrance Pub. 988-0151-211

Printed in USA 111904

Copyright © 2004
All Rights Reserved
Lowrance Electronics, Inc.