



Type SUP021 YDR

165895600 Rev.01 del 10-11-2003

OPERATING INSTRUCTIONS
MODE D'EMPLOI
INSTRUCCIONES DE USO

FOR YOUR SAFETY CAREFULLY READ THE OPERATING INSTRUCTIONS.
POUR VOTRE SÉCURITÉ, LISEZ SOIGNEUSEMENT LES INSTRUCTIONS D'EMPLOI.
LEER ATENTAMENTE ESTAS INSTRUCCIONES DE USO ANTES DE UTILIZAR LA MÁQUINA

FOR HOUSEHOLD USE ONLY

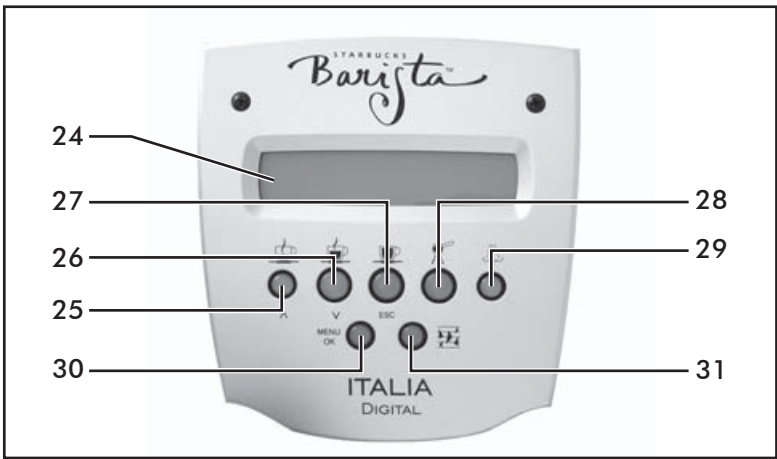
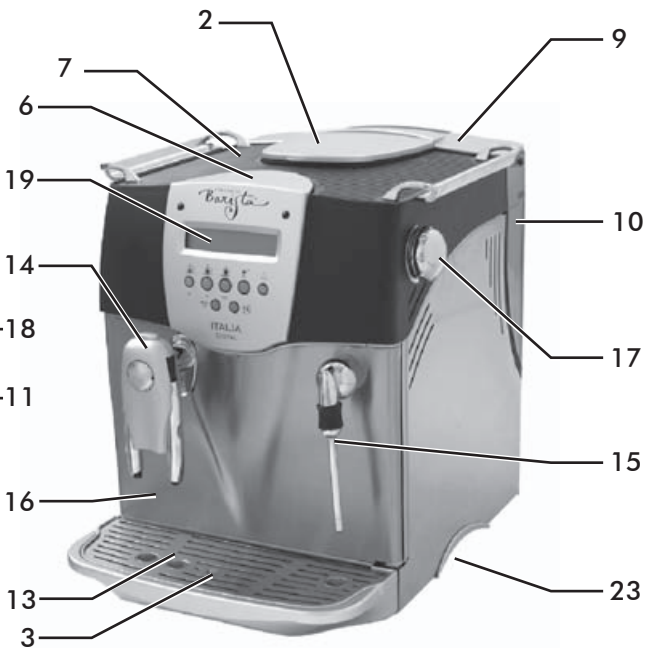
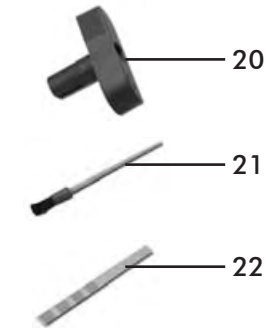
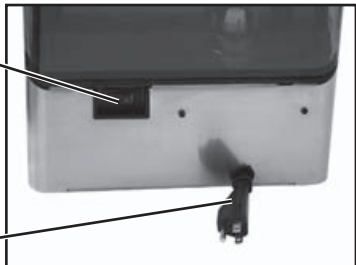
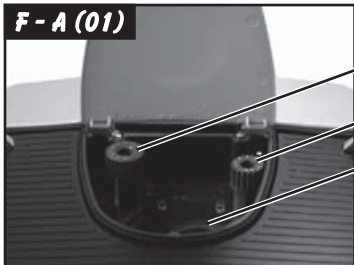

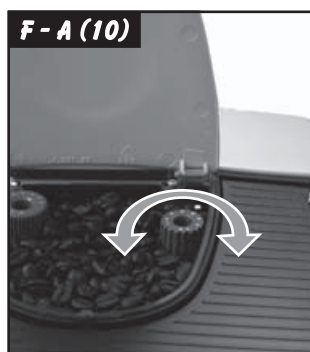
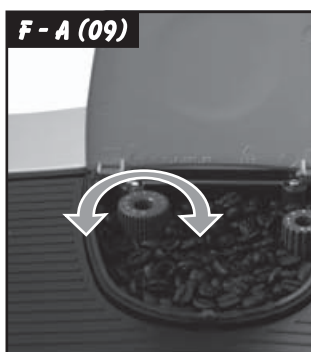
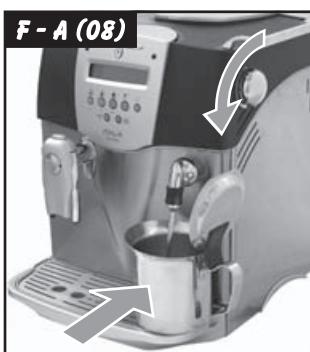
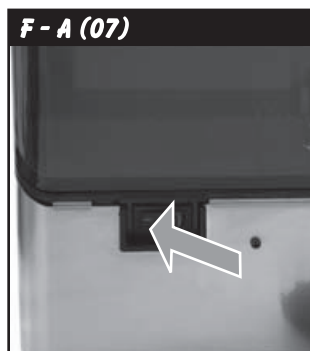
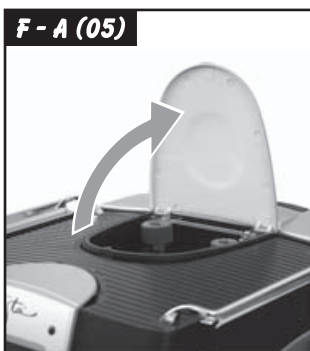
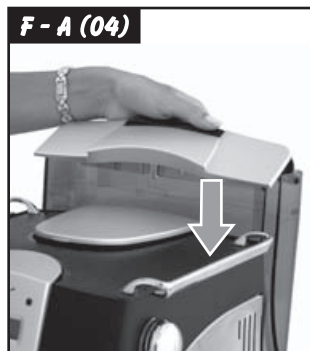

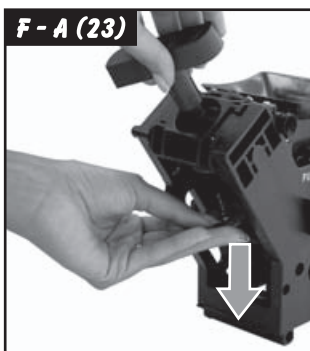
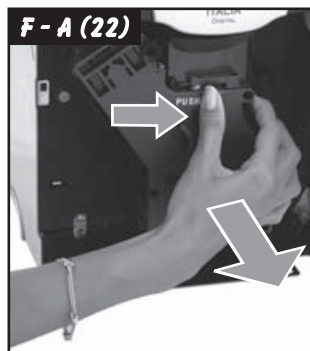
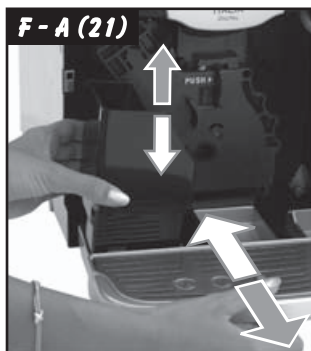
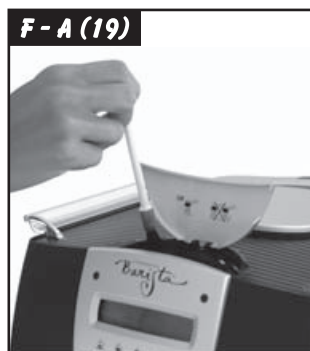
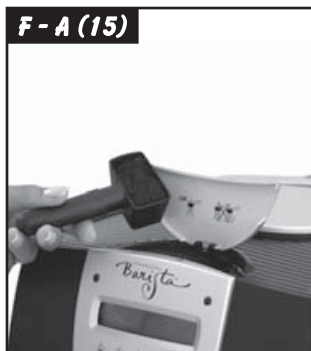
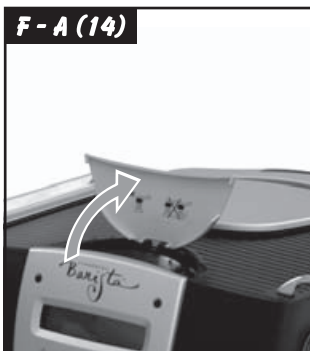

IMPORTANT SAFEGUARDS

When using electrical appliances, basic safety precautions should always be followed to reduce the risk of fire, electric shock, and/or injury to persons, including the following:

- 1 Read all instructions and information in this instruction book and any other literature included in this carton referring to this product before operating or using this appliance.
- 2 Do not touch hot surfaces. Use handles or knobs.
- 3 To protect against fire, electric shock and personal injury do not immerse cord, plugs or appliance in water or other liquid.
- 4 Close supervision is necessary when any appliance is used by or near children.
- 5 Unplug from outlet when not in use and before cleaning. Allow to cool before putting on or taking off parts, and before cleaning the appliance.
- 6 Do not operate any appliance with a damaged cord or plug or after the appliance malfunctions or has been damaged in any way. Return appliance to the nearest authorized service centre for examination, repair or adjustment.
- 7 The use of accessory attachments not recommended by the appliance manufacturer may result in fire, electric shock or personal injury.
- 8 Do not use outdoors.
- 9 Do not let cord hang over edge of table or counter, or touch hot surfaces.
- 10 Do not place on or near a hot gas or electric burner, or in a heated oven.
- 11 Always turn appliance **"OFF"**, then plug cord into the wall outlet. To disconnect, turn switch to **"OFF"**, then remove plug from wall outlet.
- 12 Do not use appliance for other than intended household use.
- 13 Use extreme caution when using hot steam.

CAUTION

This appliance is for household use. Any servicing, other than cleaning and user maintenance, should be performed by an authorized service centre. Do not immerse base in water. To reduce the risk of fire or electric shock, do not disassemble the base. There are no user serviceable parts inside. Repair should be done by authorized service personnel only.

- 1 Check voltage to be sure that the voltage indicated on the nameplate agrees with your voltage.
- 2 Never use warm or hot water to fill the water tank. Use cold water only.
- 3 Keep your hands and the cord away from hot parts of the appliance during operation.
- 4 Never clean with scouring powders or hard implements. Simply use a soft cloth dampened with water.
- 5 To avoid your coffee maker scaling up, use purified or bottled water.

INSTRUCTIONS FOR THE POWER SUPPLY CORD

- A A short power-supply cord is provided to reduce risks of getting tangled up or tripping over a longer cord.
- B Longer extension cords are available and may be used if care is exercised in their use.
- C If a long extension cord is used:
 - 1 the marked electrical rating of the extension cord should be at least as great as the electrical rating of the appliance.
 - 2 if the appliance is of the grounded type, the extension cord should be a grounding type
 - 3 the cable does not hang from the table to avoid the risk of getting caught up in it.

SAVE THESE INSTRUCTIONS

1 GENERALITIES

This espresso machine is designed to make espresso using both whole bean coffee and ground coffee; it can also supply steam and hot water.

This appliance has been designed for household use and is not suitable for continuous or commercial use.

 **The Starbucks Limited Warranty will be invalidated by the following:**

- **Incorrect use and not in keeping with the intended use.**
- **Repairs not carried out by authorized service centers.**
- **Tampering with the supply cord.**
- **Tampering with any machine part.**
- **Use of non-original spare parts and accessory attachments.**
- **Lime scale and / or freezing damage.**

1.1 Reading this instruction book

 **The following symbols have been used to facilitate reading:**

 **The caution triangle denotes all instructions important for the safety of the user. Follow these instructions scrupulously to avoid serious injury!**

 **This symbol denotes information that should be taken into account to get the most out of the appliance.**

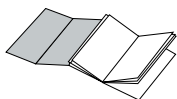

The figures referred to in the text can be found on the cover flap.

Keep these pages open when reading the instructions.

1.2 Using this instruction book

Keep these instructions in a safe place and share them with any other person who uses this espresso machine.

For additional information contact Starbucks Warranty Services directly at 1.800.933.7876.

2 TECHNICAL SPECIFICATIONS

• Nominal Voltage	120 V – 60 Hz
• Rated Output	1250 W
• Material of Body	Stainless steel / Thermoplastic (ABS)
• Dimensions (l x h x d) (mm / inches)	265 x 360 x 400 / 10.5 x 14.2 x 15.75
• Weight (Kg / pounds)	11 / 24.25
• Cord Length (mm / Inches)	1200 / 4
• Water Tank	Removable
• Water Tank (L/ oz)	1.8 L / 60 oz
• Coffee Container Capacity (g / pounds)	180g of coffee beans / 1/3 lb of coffee beans
• Pump Pressure (bar)	15
• Safety Devices	Boiler pressure safety valve Safety thermostat

If you have any questions about the technical specifications, please contact Starbucks Warranty Services directly at 1.800.334.5553.

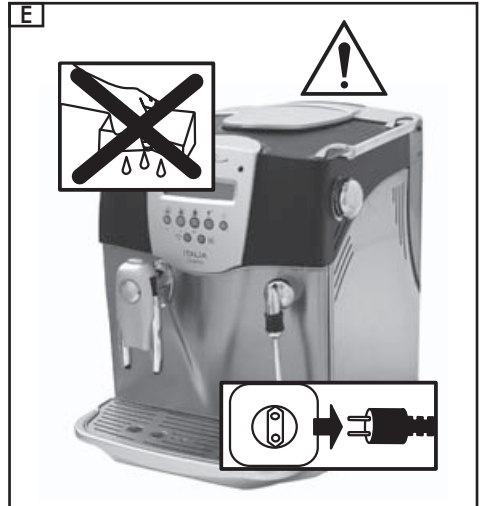
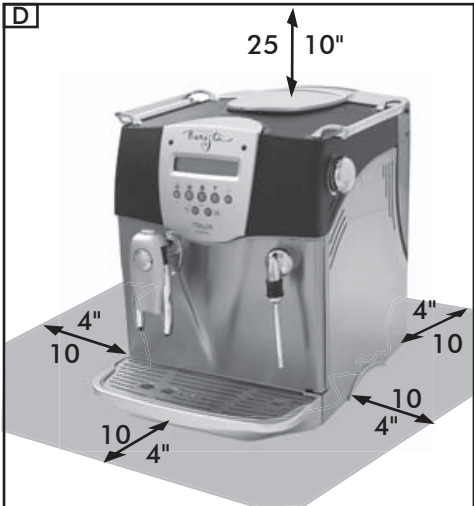
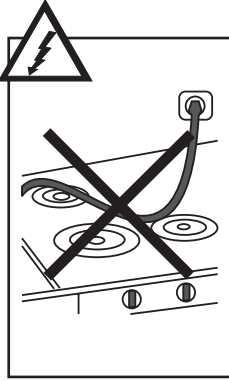
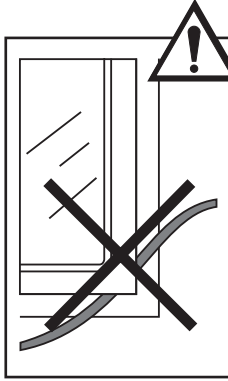
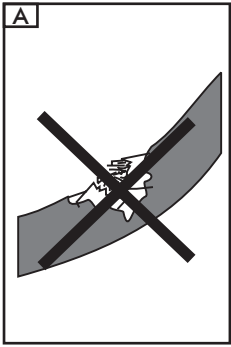

3 SAFETY STANDARDS



To avoid electric shock, never allow contact between electrical parts and water or any other liquid.

Steam and hot water can cause serious burn injuries. Never direct the steam or the hot water jet toward any part of your body.

To further prevent burns, do not touch hot surfaces. Use handles or knobs. Only touch the nonmetal (rubber) grip when positioning the steam wand. Never touch the steam/hot water nozzle once it has heated; it is extremely HOT.

Intended Use

- This espresso machine is intended for household use only.
- Disassemble your Starbucks Barista Digital Italia only as directed in this manual. Do not remove screws and do not attempt internal repairs.
- The espresso machine must be used only by adults who are in full control of their mental and physical capacities.

Power Supply

- Connect the espresso machine to a suitable outlet only.
- The voltage must match the one specified on the nameplate of the appliance (120V), located on the bottom of the machine.

Power Supply Cord (Fig. A)

- Never use the espresso machine if it has a damaged cord or plug.
- If the machine has a damaged cord or plug, contact Starbucks Warranty Services for return of the machine to an authorized repair center.
- Do not let the cord touch sharp edges, very hot objects and oily surfaces.
- Do not carry or pull the espresso machine by the cord.

Questions? Call us at 1.800.933.7876

- Do not pull the cable to remove the plug, and do not touch the plug with wet hands or feet.
- Avoid letting the cord dangle from tables or raised surfaces.

Preventing Injury (Fig. B)

- Ensure that the machine is out of the reach of children.
- Children are not aware of the risks involved in electrical appliances.
- Do not leave packing material near children.

Scalding Hazard (Fig. C)

- Hot water and steam can cause serious burns. Do not direct the flow of steam and/or hot water from the steam wand toward yourself or others.
- Always use the correct handles or knobs.
- Do not insert objects through the openings in the appliance.

Space necessary for installation, usage, and maintenance. (Fig. D)

- Place the machine on a flat, even surface.
- The machine must be positioned in a safe place where it cannot be knocked over or cause injury.
- Choose a position that is well-lit, clean and where a wall socket is easily accessible.
- To prevent melting or damage to the casing, do not rest the machine on or near hot surfaces or near open flames.
- Place the espresso machine at least 4 inches/ 10 cm away from walls and cooking tops.
- Do not keep the machine at a temperature below 32° Fahrenheit (F)/0° Celcius (C); frost may damage the machine.
- The wall outlet must be reachable at all times.
- Do not use the espresso machine outdoors.

Cleaning (Fig. E)

- Before cleaning the espresso machine, switch the ON/OFF switch (8) to OFF; then remove the plug from the wall outlet.
- Wait for the machine to cool down.

- Never immerse the appliance in water! Avoid splashes.
- Never tamper with the machine's inside parts.
- For detailed cleaning instructions, see page 20 or the enclosed instructional DVD.

Storing the Starbucks Barista Digital Italia

- When the appliance is not used at least once per two-hour period, switch the appliance to OFF and remove the plug from the wall outlet.
- Store it in a dry place, away from children.
- Protect it from dust and dirt.
- Drain the boiler of the machine. To do so, start dispensing steam, remove the water tank from the machine, and wait for the **NEED TO PRIME** message to be displayed. Unplug the unit and allow it to cool down completely.
- Do not store the machine at a temperature below 32° F / 0° C.

Maintenance

- If the espresso machine falls and you see or suspect damages or malfunctions, immediately remove the plug from the wall. Never use faulty machines.
- Repairs must be made by an authorized service center only. Call Starbucks Warranty Services directly at 1.800.933.7876. for more information.

Fire

- In the event of a fire, use carbon dioxide (CO₂) extinguishers. Do not use water or powder extinguishers.

DESCRIPTION OF PARTS

See Fig. 01

- 1 Coffee bean container
- 2 Coffee bean container cover
- 3 Full tray indicator (located on drip tray)
- 4 Grind control knob
- 5 Dose control knob
- 6 Ground coffee doser cover
- 7 Cup-warmer plate
- 8 ON/OFF switch, located on back of machine (ON = position "I" – OFF = position "O")
- 9 Water tank cover
- 10 Water tank
- 11 Coffee grounds drawer
- 12 Power cord
- 13 Drip tray
- 14 Height adjustable coffee dispenser
- 15 Swiveling Steam wand
- 16 Access door
- 17 Steam knob
- 18 Brew unit
- 19 Control panel
- 20 Brew unit key
- 21 Cleaning brush
- 22 Water hardness test strip
- 23 Rotating base

CONTROL PANEL

- 24 Illuminated digital display
- 25 Single shot/double shot button
When programming this is the CURSOR ^ UP button
- 26 One long shot/Two long shot button
When programming this is the CURSOR v DOWN button
- 27 1 Coffee/2 Coffees button
When programming this is the ESCAPE (ESC) button
- 28 Ground coffee button
- 29 Steam button
- 30 Digital display programmable MENU button and selected function confirmation OK button
- 31 Descale button

4 INSTALLING THE ESPRESSO MACHINE

For your safety and the safety of third parties, follow the "Safety Standards" (see Chapter 3).

4.1 Packaging

The original packaging was designed and made to protect the appliance during shipment. We recommend you keep it for future needs.

4.2 Getting Started

- Remove the espresso machine from the packaging and position it in a suitable location that meets the requirements specified and described in the safety standards (Chapter 3).
- Make sure that the drip tray (Fig. 01, pos. 13), the coffee grounds drawer (11) and the brew unit (18) are fitted correctly and the front cover (16) is closed.
- Keep the cleaning brush (21) and the brew unit key (20) near the appliance.

4.3 Preparing the Starbucks Barista Digital Italia for use

- Open the water tank cover and remove the tank (Fig. 02) using the built-in handle. Rinse and fill the tank with fresh, cold water (Fig. 03); we recommend that you do not exceed the MAX level mark. Replace the water tank in its housing (Fig. 04) and reposition the cover on its original position.

 **Always fill the tank (10) with fresh, cold water. Hot water and other liquids can damage the tank and/or the appliance. Do not operate the appliance without water. Make sure that there is enough water inside the tank.**

- Lift the coffee bean container cover (Fig.05).

- Pour whole bean coffee into the container (Fig. 06).

 **Use whole bean coffee only. Ground and instant coffee, as well as other items, cause damage to the appliance. Note: this machine is designed for use with Starbucks® Coffee.**

- Close the container cover.
- Insert the plug into a suitable wall outlet after making sure that the ON/OFF switch (8) is in the OFF position.
- When not in use, keep the ON/OFF switch of the appliance in the OFF position. To switch ON the espresso machine, simply press the switch (Fig. 07) located on the back of the machine.

4.4 Priming the Pump

- To prime the pump, direct the steam wand (Fig. 01, item 15) toward the drip tray or place a cup under the steam wand.
- Turn the knob counterclockwise (Fig. 08). Wait for water to flow regularly from the steam wand. Shut off the flow by turning the steam knob clockwise.

 **Note: You must prime the pump of the espresso machine if the machine is switched ON for the first time, the machine has not been used for a long time, the water tank has been emptied completely or if indicated on the digital display.**

- When the display shows SELECT SHOT SIZE/READY FOR USE the Starbucks Barista Digital Italia is ready for use.

4.5 Programming the Starbucks Barista Digital Italia

Now that you have prepared the Starbucks Barista Digital Italia and primed the pump, it's time to program the machine to set all the automatic functions that it offers.

THE PROGRAMMABLE AUTOMATIC FUNCTIONS

- A) Program the RINSING function: This function serves to clean/rinse and heat the inner circuit that goes from the brewing group to the coffee dispenser. An ounce of fresh water will pass through the circuit to clean any impurities. It will prepare the machine to deliver a clean shot. If you wish not to activate this function you will need to program it to OFF. (See display # 10 below.)
- B) Program the LANGUAGE of the display: This function allows you to program the display language. You have a choice of 8 languages: English, Italiano (Italian), Français (French), Deutsch (German), Nederlands (Dutch), Portugues (Portuguese), Espagnol (Spanish) and Polish.
- C) Program the WATER HARDNESS: You can determine the water hardness by dipping the test strip in the water from your faucet. Simply fill up the water tank, dip this strip and count how many squares have changed color from 1 to 4. Now you can input this number into the water hardness program. The water hardness program will determine when the machine will need to be descaled. The harder the water, the sooner the descaling will happen. If your water is set to hardness #1 your machine will have to be descaled much later than if you set it to hardness #4. If you don't wish to perform the water hardness test then simply use the default water hardness #3. The default settings will indicate when you have to perform the descaling function.
- D) Program the CUP WARMER: The cup warmer allows you to keep your cups warm, so that the beverage you are preparing will be poured into pre-heated cups and your coffee will stay warmer longer. You can fit approximately 6 espresso demi cups or 4 cappuccino cups on the cup warmer. If you wish you can turn off the cup warmer function.
- E) Program the coffee TEMPERATURE: This machine allows you to program the brewing temperature. There are 5 choices: minimum, low, medium, high and maximum. The temperature will vary depending on many factors such as weather, type of coffee, water and type of beverage you are making. If you like your beverages very hot for Lattes and Cappuccinos, you should select maximum or high temperature. If you prefer a beverage that is not as hot, such as a coffee or even a long shot of espresso, you should select medium. If you prefer a beverage not too hot because you like your Americano just right, you should select low or minimum.
- F) Program the PRE-BREWING function: This function is designed for the espresso coffee lover. It's an option that you may decide to use, depending on your taste. Basically the pre-brewing function, ON, will slightly dampen the ground coffee dose a few seconds before the shot is pulled. This helps compact the coffee and extract better espresso; it also improves the crema on the shot. If you want more coffee extraction or a stronger brew, you must program LONG. If you don't want the PRE-BREWING function at all, program it to the OFF position.
- G) Program the PRE-GRINDING function: This feature is designed to speed up the service when you have to make several consecutive shots. If this function is ON, the grinder will grind 2 shots when you press the shot button once. This means that it

will always keep a grounded coffee shot in the chamber, ready for the next pull. By grinding the next shot in advance, you can make a lot of beverages in sequence. On the other hand if you don't intend to make several consecutive beverages, it's better to turn this feature in the OFF position. If the pre-ground dose stays in the chamber for a long time, it will be stale the next time you brew.

H) Program the TIMER: This machine has a timer that can be programmed to place the machine in the stand-by energy-saving mode for a maximum of 3 hours. The timer setting range starts at 15 minutes and goes up by 15 minute intervals until you reach a maximum of 3 hours. The 3-hour timer will function only if the clock is in the OFF position.

I) Program the CLOCK functions: The CLOCK display is part of the main menu. It has a series of subfunctions. The subfunctions of the CLOCK MENU are:

- CLOCK (not to be confused with the CLOCK display on the main menu): This function is used to program the ON or OFF time that you want the machine to start and stop. When you activate this function the TIMER function will be set OFF.
- ON/OFF TIME: This is a submenu display of the CLOCK that allows you to program the ON and OFF time as described above.
- CLOCK TIME: Here you simply input your local time on the clock; for example 06:00A (6 a.m.) or 06:00P (6 p.m.) The time of the day will only be displayed when the main power switch is ON.
- SHOW CLOCK TIME: This is simply a display that will show you what time it is.

We will now take you through the various functions that you will experience on the digital display.

When you turn the machine to the ON position (using the main power switch on the back of the machine) the display will read as follows:

SELF TEST

1)

SELF TEST is the first display that you will read when the machine is turned on. It will stay on for approximately 3 seconds and then the next display below will be shown.

RINSING
WARMING UP...

2)

The RINSING/WARMING UP display tells you that the machine will perform a rinsing cycle. This means it will rinse all the circuits by passing hot water through. The machine is also warming up to reach the required temperature for brewing, hot water and steaming.

RINSING

3)

About an ounce of water from the rinsing cycle will flow out of the coffee dispenser and be collected in the drip tray.

SELECT SHOT SIZE
READY FOR USE

4)

This display tells you that you can now select your shot size. Before you do this, you will want to program all the options for the first time. Start by pressing the MENU/OK button and you will get the display message below:

ENERGY SAVING *
RINSING

5)

If you wish to put the machine in energy-saving mode, press the MENU/OK button once more. This will lower the temperature of the machine boiler and of the cup warmer.

The display will next read:

6) ENERGY SAVING

The machine is now on ENERGY SAVING mode. If you wish to continue programming press the MENU/OK button. The machine display will change to SELF TEST:

7) SELF TEST

SELF TEST will be displayed for about 3 seconds and then the display will read WARMING UP...:

8) WARMING UP...

Now press the MENU/OK button again and your display once again will read ENERGY SAVING/ RINSING:

9) ENERGY SAVING RINSING *

Now press once the CURSOR v DOWN button on the control panel (this is also the One long shot/ Two long shot button) and the display will show:

10) RINSING LANGUAGE *

Press the MENU/OK button again to choose whether you want to have the rinsing function on or off. The display will now read:

11) RINSING ON

To select RINSING ON just confirm MENU/OK.
To select RINSING OFF press the CURSOR ^ UP button. (This is also the Single shot/ Double shot button) The display will now read OFF and you must press MENU/OK to confirm this choice. Now proceed to program the next function LANGUAGE/ WATER HARDNESS.

12) LANGUAGE WATER HARDNESS *

To go into the LANGUAGE selection, just press the MENU/OK button. The display the LANGUAGE you prefer, move the CURSOR v DOWN button and pick from the languages displayed.

The default setting is ENGLISH.

The other languages in order are: ITALIANO (Italian), FRANÇAIS (French), DEUTSCH (German), NEDERLANDS (Dutch), PORTUGUES (Portuguese), ESPAGNOL (Spanish) and POLISH. As soon as the language has been chosen, press the MENU/OK button to confirm your choice and then move the CURSOR v DOWN button. You will see WATER HARDNESS/CUP WARMER displayed.

13) WATER HARDNESS CUP WARMER *

Now select the WATER HARDNESS. First test the water from your faucet to determine your water hardness.

Dip the hardness strip provided with the machine into the water tank for 1 second. You will have a choice of 4 different water hardnesses. If you don't wish to perform the test, then set the hardness at number 3. To select the hardness on the display, move the CURSOR v DOWN button or the CURSOR ^ UP button until you find the right number. Once you have made your choice, press the MENU/OK button. The CUP WARMER is the next function when you press the cursor down.

14) CUP WARMER TEMPERATURE *

The CUP WARMER can be set ON or OFF. Press the MENU/OK button to go into the CUP WARMER function, confirm the CUP WARMER ON function or move the cursor down to select CUP WARMER OFF and then confirm by using the MENU/OK button. Now if you move the CURSOR v DOWN button, you will be ready to program the brewing temperature.

15) TEMPERATURE PRE-BREWING *

Press the MENU/OK button to go into the different TEMPERATURE settings. You are now ready to program the temperature for brewing. There are 5 choices: maximum - high - medium - low - minimum.

Move the cursor up or down to make your choice of temperature. Once you have selected the temperature you must confirm it by pressing the MENU/OK button.

Now if you move the CURSOR v DOWN button, you will be ready to program the PRE-BREWING function.

16) PRE-BREWING PRE-GRINDING *

Program the PRE-BREWING function to ON, LONG or OFF. Press the MENU/OK button to go into the PRE-BREWING function.

Then move the cursor up or down to make the choice and confirm with the MENU/OK button. Go to the next function by moving the cursor down. The next function is PRE-GRINDING.

17) PRE-GRINDING TOTAL BREWED *

Press the MENU/OK button to go into the PRE-GRINDING feature.

Program the PRE-GRINDING function ON or OFF. Move the cursor up or down to make the choice and then confirm with the "MENU/OK" button. Go to the next function by moving the cursor down. The next function is TOTAL BREWED.

18) TOTAL BREWED TIMER *

There is no need to program this display. TOTAL BREWED is a counter that tells you how many shots have been brewed. Just press the MENU/OK button to see the total number. Now move the cursor down. The next function to program will be the TIMER.

19) TIMER CLOCK *

Now program the timer. Press the MENU/OK button and the display will read STANDBY AFTER. Simply move the cursor up or down to program the standby function of the timer from 15 minutes to 3 hours. Confirm the standby time with the MENU/OK button and then move the cursor again to the next function, CLOCK.

20) CLOCK DEFAULT SETTINGS *

You must select whether you would like this function ON or OFF. Move the cursor up or down and then press MENU/OK to confirm. The display will read: CLOCK/CLOCK TIME.

21) CLOCK CLOCK TIME

The CLOCK function is used for setting the start-up time ON. To access the menu press the MENU/OK key and select by moving the cursor up or down. To confirm your selection press the MENU/OK key again.

When you activate this function you automatically deactivate the TIMER function. (On the display #23 ON/OFF Time) we will explain how to select and set the time ON and OFF. Go now to the next function #22.

22) CLOCK TIME ON/OFF TIME

The CLOCK TIME function is used to set the actual time that will be displayed when the machine is switched to ON.

This is a very important function because it will make the previous function (21 CLOCK) work correctly and obey the timings that you have set for the machine to turn ON and OFF. To access the menu press the MENU/OK key and select the correct time with the cursor keys. Then press MENU/OK to confirm hours and proceed to program the minutes. To confirm the selected minutes press MENU/OK.

ON/OFF TIME
SHOW CLOCK TIME

23)

This function serves the purpose of programming the ON and OFF time of your machine. To access the menu, press the MENU/OK key. Program the ON time (hours) by using the CURSOR ^ UP and CURSOR v DOWN keys and then confirm your selection with the MENU/OK key. Now program the ON (minutes) by using the CURSOR ^ UP and CURSOR v DOWN keys. Once you have finished confirm your time with the MENU/OK key.

Now you must select a TIME when you want the machine to turn OFF. To access the menu press the MENU/OK key. Program the OFF time (hours) by using the UP and DOWN keys and then confirm your selection with the MENU/OK key. Now program the OFF (minutes) by using the UP and DOWN keys. Once you have finished, confirm your time with the MENU/OK key.

i Please note that if the ON and OFF times are the same, the software will ignore the selection.

i A word about the clock: 08:00 a.m. Is displayed as 08:00A and 08:00 p.m. is displayed as 08:00P.

i We recommend leaving the machine ON if it is going to be used every hour or so. If you are not going to use it for several hours, we recommend the machine be turned OFF.

SHOW CLOCK TIME
CLOCK

24)

This function and display serves to visualize the TIME at day. You can only see the TIME displayed when the machine is ON or in STAND-BY mode. If you turn the machine OFF (by turning off the power switch on the back), the clock will turn OFF. If you turn the machine ON, there is no need to reset the clock .

i NOTE: Press the ESC button twice to return to the beginning (back to the SELF TEST display). You can also return at any moment in the program by pressing the ESC button twice.

OTHER MESSAGES ON THE DIGITAL DISPLAY

You will also experience the following messages on the display:

- SINGLE SHOT Machine is brewing one shot.
- DOUBLE SHOT Machine is brewing a double or two shots.
- ONE LONG SHOT Machine is brewing a longer shot, using the same amount of coffee for one shot and more water.
- 2 LONG SHOTS Machine is brewing two longer shots.
- 1 COFFEE Machine is brewing one coffee.
- 2 COFFEES Machine is brewing two coffees.
- BREW UNIT MISSING You must put the brewing group back in the machine or make sure that it's correctly inserted.
- GRINDER EMPTY You must refill the bean hopper with whole bean coffee.
- BREW UNIT BLOCKED The brew unit is blocked. Contact Warranty Services.
- GRINDER BLOCKED The grinder is blocked. Contact Warranty Services.
- NO GROUNDS DRAWER You must place the grounds drawer back on the base of the drip tray and insert it back in the machine.
- FILL WATER TANK Refill the water tank with fresh clean water.
- EMPTY GROUNDS Empty the grounds drawer. This function must be done with the machine ON. **Caution: If the drawer is emptied with the appliance OFF, coffee will not be dispensed when the machine is switched ON.**
- OPEN DOOR Close the door of the machine.
- NEED TO PRIME Prime the machine circuit as described in point 4.4 of the manual.
- STEAMING Machine is making steam.
- HOT WATER Machine is dispensing hot water.
- PRE GROUND COFFEE The pre-ground coffee function has been selected. The machine will brew the pre-ground coffee.
- PRE-BREWING The PRE-BREWING function is on.
- DECALCIFY It's time to decalcify.

5 THE COFFEE BURR GRINDER (FIG. 09)

 **Caution!** Only turn the grind control knob, found inside the coffee bean container (Fig. 09), when the coffee grinder is working. Do not insert ground and/or instant coffee in the coffee bean container. Do not insert anything other than whole bean coffee in the container. Do not use frozen coffee beans.

The coffee burr grinder contains dangerous moving parts; keep fingers and/or other objects away. Before carrying out any operations in the coffee bean container, switch OFF the machine and remove the plug from the wall outlet. Do not insert coffee beans when the coffee burr grinder is in motion.

The quality and the taste of the drinks you can make on the Starbucks Barista Digital Italia depend on 4 things; the quality of the coffee, the quality of the water, the grind size and the dose (amount of beans to be ground per cup).

The Starbucks Barista Digital Italia was designed to use Starbucks® coffee. We recommend using Starbucks® coffee to make the best.

The Starbucks Barista Digital Italia comes with a grind adjusting knob (Fig. 09). To use this feature, turn the adjustable knob when the coffee burr grinder is working, and only in increments of 2 numbers at a time; the numbers displayed on the knob indicate the coarseness of the grind.

The manufacturer has set the knob to achieve a single shot based on the standards Starbucks uses in its stores. If the ground coffee is too fine, turn the knob toward the higher values; if the ground coffee is too coarse, turn the knob toward the lower values.

You will note the change only after pulling three to four shots.

You should change the grind position if the espresso shot does not pour optimally:

If your shot pours too fast, then the grind is too coarse. You should adjust the grind to make it finer.

If your shot pours too slow, then the grind is too fine. You should adjust the grind to make it coarser.

6 ADJUSTING THE COFFEE DOSE (FIG.10)

You may select the quantity of coffee (dose) that you wish to grind per cup / shot between (6g) and (9g). The manufacturer has set the dose system to achieve a single shot of espresso based on the standards Starbucks uses in their stores.

To change the dose, simply turn the knob (Fig. 10) found inside the coffee container. Turn it counter-clockwise (toward the “+” to increase the dose and clockwise (toward the “-”) to decrease the dose.

You must adjust the dose before pressing the coffee dispenser button.

This system allows you to obtain a shot of espresso to your personal liking.

7 THE COFFEE DISPENSER

 **Note:** If the appliance does not dispense coffee, check the water level in the tank.

- Before making coffee, make sure that the display reads SELECT SHOT SIZE/ READY FOR USE and that the water tank and the coffee container are full.
- Place the empty coffee cups on the cup-warmer plate for pre-heating.

 **Note:** The cups to be pre-heated must be empty; pre-heating the coffee cups will allow you to keep your coffee warmer.

- Place 1 or 2 coffee cups under the coffee dispenser spouts; you can adjust the height of the dispenser by moving it up or down manually (Fig. 11).
- It is possible to use big cups by raising the dispensing unit nozzles and moving the dispensing unit body toward the machine. (Fig. 12 & 13). The coffee dispenser can also be removed completely.

7.1 Making espresso shots with whole bean coffee

- To dispense the brewed espresso, press the correct brewing button (25), (26) or (27). The display will read "1 SINGLE SHOT", "1 LONG SHOT" or "1 COFFEE".

To make 1 coffee, position a single coffee cup under the coffee dispenser spouts and press the button (25), (26) or (27) only once; to make 2 coffees, position two coffee cups under the spouts and press the button (25), (26) or (27) twice.

In this operating mode, the appliance automatically grinds and doses the right quantity of coffee. Making a double shot requires two grinding and dispensing cycles, which are automatically managed by the machine.

The coffee will stop flowing automatically when the pre-set level is achieved (see Para. 7.3).

- You can stop the flow by pressing the brew button during the brew cycle.

7.2 Making shots with ground coffee

i In this operating mode, you must add ground coffee to the ground coffee doser.

! **Note:** At each coffee dispensing, it is possible to put a maximum quantity of 1 scoop ground coffee into the ground coffee doser; higher quantities may cause machine malfunction. 1 scoop = 7g / ¼ oz of ground coffee.

! Only use coffee ground for espresso (6). Placing whole bean coffee, instant coffee and other materials inside the doser causes damage to the espresso machine.

! Keep fingers away from the ground coffee doser since there are moving parts.

Measure the right quantity of ground coffee to place in the doser for one shot.

To make two shots, you must go through the entire process twice.

- Press the ground coffee button (28) to select the function; the display will read PRE-GROUND COFFEE.
- Lift the cover of the ground coffee doser (Fig. 14).
- Draw a maximum quantity of 1 scoop (7g / ¼ oz of ground coffee).
- Fill the doser with 1 scoop (Max) of the ground coffee (Fig. 15).
- Close the cover of the ground coffee doser.
- To make the shot, press the desired brew button (25), (26) or (27); the display will read 1 SINGLE SHOT, 1 LONG SHOT or 1 COFFEE depending on the button selected.
- The dispensing cycle begins.
- The shot will start to come out of the spout (14).
- The shot will stop flowing automatically when the preset level is reached (see Para. 7.3). You can interrupt the flow of coffee by pressing the button (25), (26) or (27).
- Then the machine automatically returns to the normal operating mode (see Para. 7.1).

7.3 Adjusting the quantity of coffee per cup

Your espresso machine has been programmed to make either an espresso shot (25), a long shot (26) or a coffee Americano (27). You can adjust the machine to make any kind of shot you prefer; single, double, long, tall, short ~ the decision is yours.

To adjust the programmed values, place a cup under the coffee dispenser (14), press the button of the desired type of coffee (25), (26) or (27) and keep it pressed. Do not let go!

Once the machine has ground the beans, tamped the coffee, and begins to pull the shot, wait for the machine to fill the cup up to the desired level and then release the button. Once you release the button, the machine is now programmed to always pull that same amount every time.

When you program the function of the quantity of coffee per shot, the digital display will read "PROGRAM QUANTITY".

i **Note:** keep the button (25), (26) or (27) pressed during the entire coffee dispensing process.

In this way, the espresso is programmed to supply the quantity of coffee you selected (from 0-12 oz).

8 GETTING HOT WATER FROM THE STEAM WAND

! **Caution:** Scalding hazard! Splashing may occur at the start. The steam wand can reach high temperatures; avoid touching directly with your hands.

- To dispense hot water the display mode must say **SELECT SHOT SIZE/READY FOR USE**. Proceed as follows when the espresso machine is ready to dispense hot water:
- Place a cup and/or pitcher under the steam wand (Fig.16).
- Turn the knob counter clockwise as shown in Fig.16. The display will read **HOT WATER**.
- When you have obtained the desired quantity of hot water, turn the knob clockwise to shut off the flow.

9 MAKING STEAM

i **Steam can be used to froth the milk for your favorite espresso beverage.**

! **Caution:** Scalding hazard! Splashing may occur at the start. The steam wand can reach high temperatures; avoid touching directly with your hands.

- Before dispensing steam, wait for the **SELECT SHOT SIZE/READY FOR USE** display to appear. The appliance is now ready to dispense steam.

i **Note:** When you turn the steam knob some water will come out first, than steam will start flowing regularly.

- Press the steam button (29). The display will say **STEAMING**.
- Direct the steam wand (15) towards the drip tray and turn the steam knob (17) for a few seconds so that any residual water comes out of the steam wand. Continue until only steam is dispensed.
- Turn the knob (17) to **OFF**.

i **Fill a frothing pitcher with milk. For best results when steaming, the milk should be cold.**

- Immerse the steam wand into the milk to be frothed and turn the knob (17); turn the container slowly with up-down movements to make uniform frothing (Fig.17).
- After using the steam for the desired time, shut off the steam by closing the steam knob.
- Press the button (29) again to bring the machine back to its standard operation mode.
- Clean the steam wand with a damp cloth (Fig.18).

10 CARE & CLEANING

General Cleaning

- Maintenance and cleaning should only be carried out when the appliance is **OFF**, cold and disconnected from the power supply.
- Do not immerse the appliance in water and do not wash the parts in the dishwasher.
- Do not use abrasives or chemicals (solvents) for cleaning.
- Do not dry the machine and/or any of its parts using a microwave and/or conventional oven.
- We recommend you clean the water tank and change the water daily.
- Clean the ground coffee doser daily.
 - Use the supplied brush to clean the doser (Fig.19).
- To clean the appliance, use a soft cloth dampened with water.

Questions? Call us at 1.800.933.7876

- Clean the service area and the brew unit.
- We recommend you empty and clean the drip tray (13) and the coffee grounds drawer (11) daily; to carry out this operation you must open the front cover (Fig. 20) and remove the drip tray (Fig. 21); then you can empty and clean all the components.
- When the red indicator (3) rises, the drip tray shall be emptied.
- The coffee dispenser can be removed (Fig. 24):
 - lower the dispensing unit nozzles
 - take the dispensing unit as shown in Fig. 24, and remove it from its housing
 - wash the whole unit with warm water.

10.1 The brew unit

i **The brew unit (18) must be cleaned each time you fill the coffee bean container, or at least once a week.**

- Switch off the espresso pressing the ON/OFF switch (8) to the "OFF" position and remove the plug from the wall outlet.
- Open the access door (16). Remove the drip tray (13) and the coffee grounds drawer.
- Remove the brew unit by holding it by its handle and pressing the PUSH button (Fig. 22).
- Make sure that the two steel filters are free from any coffee residues.
The top filter can be removed by unscrewing the plastic pin counterclockwise using the specific supplied key (Fig.23).
- Wash the coffee dispenser only with warm water; do not use detergents. Then accurately wash and dry all its components. **NEVER PUT INTO A DISHWASHER.**
- Refit the filter and carefully screw the plastic pin back on using the specific key. Do not over-tighten.
- Clean the compartment inside the machine.
- Holding it by its handle, insert the brew unit into its housing until it snaps into place.
- Insert the coffee grounds drawer, the drip tray plate and the drip tray.
- Close the access door (16).

11 DESCALING

Scaling occurs naturally when the appliance is used. Approximately every 3 to 4 months you should descale it and also when you notice a reduction in the water flow.

Descaling is important in order to guarantee a good performance, a normal functioning and a good beverage.

To descale you can use a Starbucks product the Starbucks® Barista Cleaner and Descaler especially for this purpose. Please ask Warranty Services for information.



DO NOT use vinegar to descale.

The display will read: **DECALCIFYING/READY FOR USE**, this is just another way of saying descaling.

To proceed with descaling you must follow these instructions:

1. Mix the solution with water as specified on the package and fill the water tank.
The display will read:
DECALCIFYING/ READY FOR USE
2. Switch on the appliance ON /OFF power switch (8).
3. Press the button (31) ON and hold for 5 seconds to select the function.
The display will read:
DECALCIFYING/OPEN KNOB
4. Direct the steam wand (13) towards the drip tray.
5. Position a cup of adequate size under the steam wand and turn the steam knob (17) counterclockwise. The espresso machine starts the descaling cycle.
The display will show:
MACHINE IS DESCALING
6. At the end of the cycle, the flow of the descaling solution is shut off.
The display will read:
DECALCIFYING FINISHED/CLOSE KNOB
7. Turn the knob of the hot water wand (17) clockwise to OFF. The display will now read:
RINSE MACHINE/FILL WATER TANK

8. Rinse the water tank and fill with fresh drinking water. The display will now read :
RINSE MACHINE/PRESS KEY
9. Position a cup of adequate size under the steam wand and press button (31) The display will read :
RINSING/OPEN KNOB
10. Empty 2/3 of the contents of the water tank by turning the steam knob(17) counterclockwise;. The display will read:
MACHINE IS RINSING
11. When the rinsing has finished the display will read:
RINSING FINISHED/CLOSE KNOB
12. To shut off the flow, turn the knob (17) clockwise .
Prime and let the machine warm up.

11.1 Descaling interrupted:

i If the descaling cycle is interrupted by turning OFF the machine. It starts automatically again when you turn the machine ON.

The cycle can be interrupted by closing the knob (17)(clockwise) and then pressing on button (31). The display will say: DECALCIFYING INTERRUPTED/EMPTY WATERTANK

! **Attention: After the above operation, you must empty the water tank and wash it with fresh drinking water. The machine circuit must be rinsed with a complete rinsing cycle. The display will read:**
RINSE MACHINE/PRESS KEY

At this point you must proceed, following point (8) of the descaling instructions in Chapter 11.

12 LEGAL INFORMATION

- This instruction book contains the necessary information to use and maintain your appliance correctly.
- The information should be viewed as a guideline to use and maintain your coffeemaker safely. The information is not exhaustive. For additional information on topics not covered

in this book, please contact the authorized service centers or the manufacturer directly.

- All the manufacturer's obligations and liabilities are based on the relative sale contract that also specifies all warranty terms and conditions.
- The contractual warrantee terms and conditions are not limited or extended based on this instruction book.
- This instruction book contains information protected by copyright.
- This instruction book cannot be photocopied or translated into other languages without the explicit written consent of the manufacturer.

13 SCRAPPING

- Make any appliances not in use unusable.
- Detach the plug from the wall outlet and cut the electric cord.
- Deliver broken machine to a suitable collection center.

14 TROUBLESHOOTING

Problem	Cause	Troubleshooting
The appliance does not switch ON.	The appliance is not connected to the outlet.	Connect the appliance to the outlet.
The coffee is too cold.	The cups are cold.	Heat the cups using the cup warmer.
No hot water or steam.	The hole of the steam nozzle is clogged.	Clean the steam nozzle hole with a pin.
Coffee is dispensed slowly.	Coffee is too fine.	Change the coffee blend or adjust grinding as specified in Para. 5. Decrease the dose (Para. 6).
	Dirty brew unit.	Clean the brew unit (Par. 10).
The coffee has little "crema." (cream - froth layer).	The blend is not suitable, the coffee is not freshly ground, or is ground too coarsely.	Change the coffee blend or adjust grinding as described in Para. 5. Increase the dose (Para. 6) Program on the PRE-BREWING function ON.
The appliance takes too long to heat or a limited volume of water comes out of the nozzle.	The circuit of the appliance is clogged by scaling.	De-scale the appliance.
The brew unit is jammed.	The brew unit is not snapped into its housing.	Switch ON the appliance. Close the service cover. The brew unit automatically returns to its initial position.
	Coffee grounds drawer in place.	Remove the coffee grounds drawer before removing the brew unit.
No coffee is dispensed.	No water.	Fill the tank with water and fill the circuit.
	Dirty brew unit.	Clean the brew unit.
	Dose is too large.	Decrease the dose.
	Circuit not filled.	Prime machine.
	Programmed coffee level too low .	Reprogram coffee button to higher volume ((Para. 7.3).
Coffee is dispensed outside the dispenser.	The coffee dispenser is not fitted correctly.	Refit the coffee dispenser.
	The coffee dispenser is clogged.	Clean the coffee dispenser and its spouts.
Coffee comes out too quickly.	Too little ground coffee inside the ground coffee container.	Fill the container with 7g of ground coffee (not instant coffee).
	Coarse coffee blend.	Change the type of blend.
	Dose is too small.	Increase the dose.
Water comes out of the drip tray.	The drip tray is too full.	Check the position of the red indicator and empty the drip tray.