

FURUNO

Publication No. OM-E2241-OE

OPERATOR'S MANUAL

ECHOSOUNDER

MODEL FE-400

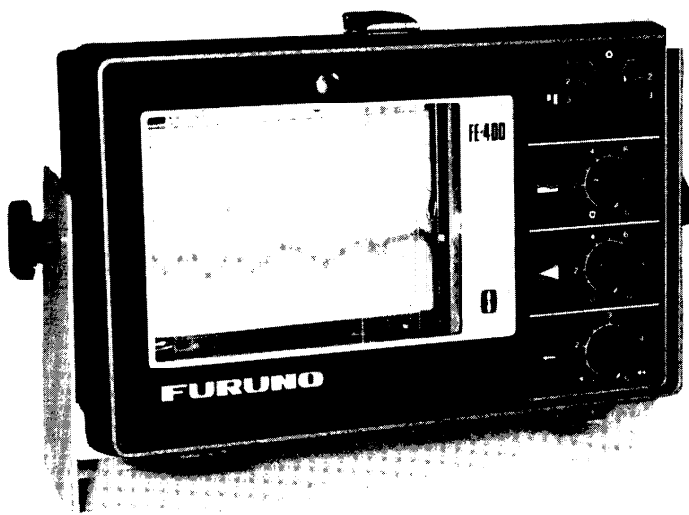

FURUNO ELECTRIC CO., LTD.
NISHINOMIYA, JAPAN

February 1980 Revised

8002200K
PRINTED IN JAPAN

CONTENTS
* * * * *

SPECIFICATIONS	1 thru 4
CHAPTER 1. INSTALLATION	1-1 thru 1-3
1-1. Recorder Unit	1-1
1-2. Power Supply	1-1
1-3. Transducer	1-1
CHAPTER 2. OPERATION	2-1 thru 2-6
2-1. Description of Controls and Switches	2-1
2-2. Operating Procedure	2-4
2-3. Adjustment of Zero Line	2-4
2-4. Replacement of Recording Paper	2-6
CHAPTER 3. OBSERVATION OF RECORDING	3-1 thru 3-5
3-1. Detecting Area	3-1
3-2. Observation of Recording	3-1
CHAPTER 4. MAINTENANCE	4-1 thru 4-2
4-1. Cleaning & Lubrication	4-1
4-2. Replacement of Stylus Assembly	4-2
CHAPTER 5. TROUBLESHOOTING	5-1 thru 5-2
5-1. Troubleshooting Flow Chart	5-1
SCHEMATIC DIAGRAMS	S-1

FURUNO

SPECIFICATIONS OF FE-400

1. DEPTH RANGE

	DEPTH RANGES	SOUNDING RATES (PPM)	FREQ.
FE-400A	0 - 30 - 60 - 90 meters	422	200kHz 50kHz
	0 - 60 - 120 - 180 meters	211	
FE-400AF	0 - 15 - 30 - 45 fathoms	422	200kHz 50kHz
	0 - 30 - 60 - 90 fathoms	211	
FE-400AT	0 - 90 - 180 - 270 feet	422	200kHz 50kHz
	0 - 180 - 360 - 540 feet	211	
FE-400B	0 - 40 - 80 - 120 meters	317	200kHz 50kHz
	0 - 80 - 160 - 240 meters	158.5	
FE-400BF	0 - 20 - 40 - 60 fathoms	317	200kHz 50kHz
	0 - 40 - 80 - 120 fathoms	158.5	
FE-400BT	0 - 120 - 240 - 360 feet	317	200kHz 50kHz
	0 - 240 - 480 - 720 feet	158.5	
FE-400C	0 - 80 - 160 - 240 meters	158	50kHz
	0 - 160 - 320 - 480 meters	79	
FE-400CF	0 - 40 - 80 - 120 fathoms	158	50kHz
	0 - 80 - 160 - 240 fathoms	79	
FE-400CT	0 - 240 - 480 - 720 feet	158	50kHz
	0 - 480 - 960 - 1440 feet	79	

2. INDICATION

Straight line recorder

3. RECORDING PAPER

Dry Electro-sensitive Paper
Type PD-1015, 100mmx15m
Effective Paper Width, 90mm

4. PAPER ADVANCE

5-20mm/min, continuously
adjustable

5. FREQUENCY

FE-400A/B: 200kHz or 50kHz
FE-400C : 50kHz

6. PULSE LENGTH

1ms

7. OUTPUT POWER

100W

8. POWER SUPPLY

DC11-15V, 6W average
DC19-40V with optional
built-in power adaptor

9. COATING COLOUR

Newtone Grey No. 3

10. EQUIPMENT LIST

STANDARD

1. Recorder Unit
(W/vinyl cover & Bracket)
2. Transducer
200B-5N (For 200kHz)
Beam width: 10°
(3dB down)
50B-5N (For 50kHz)
Beam width: 50°
(3dB down)
3. Spare Parts
Lamp(P-12) 1pc.
Fuse(F-7161, 2A) 1pc.
Stylus assembly 1pc.
Recording Paper 3rolls
Sandpaper 1sheet

OPTIONAL

- 1) Power Adaptor
for DC19-40V (To be
fitted in the recorder)
- 2) Transducer Adaptor
(For use with 50B-6G
or 200B-5)

A

送受波器コネクタ(4P)
XDR CONNECTOR

アース端子
GROUNDING TERMINAL

電源コネクタ(2P)
POWER CONNECTOR

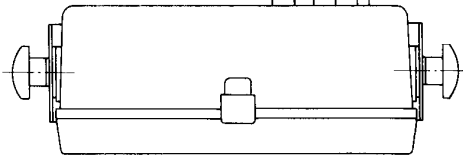

B

C

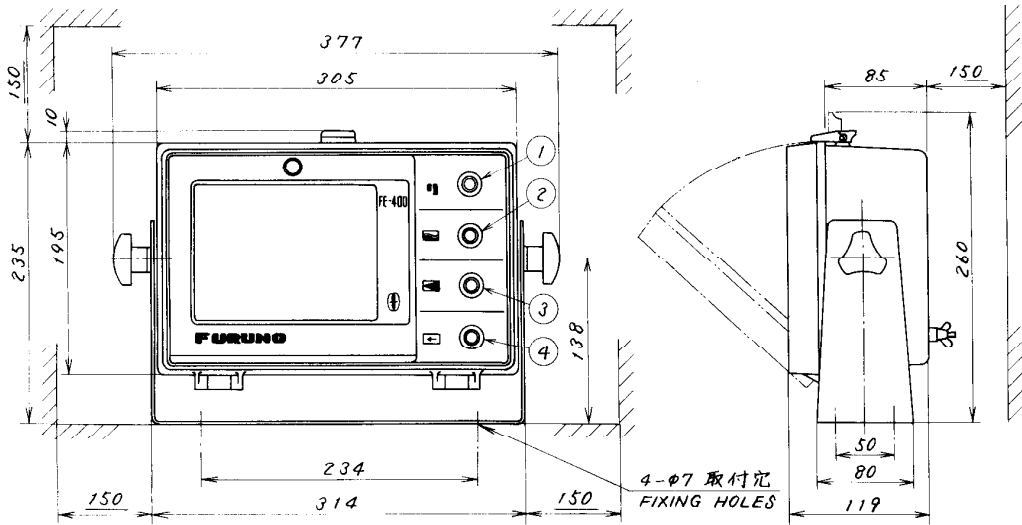

D

4	紙送り速度 PAPER SPEED		1		
3	感度つまみ GAIN		1		
2	判別つまみ WHITE-LINE		1		
1	電源 深度範囲つまみ POWER & RANGE		1		
品番 ITEM	品名 NAME	材質 MATERIAL	数量 QTY	図番 DWG. NO.	摘要 REMARKS

承認 APPROVED	Oct. 12. '78 <i>[Signature]</i>	三角法 THIRD ANGLE PROJECTION		名称 TITLE	記録器外觀図 RECORDER
検図 CHECKED	Oct. 17. '78 <i>[Signature]</i>	尺度 SCALE	1/5		
製図 DRAWN	Oct. 11. '78 <i>[Signature]</i>	重量 WEIGHT	5 kg	図番 DWG. NO.	C 2241-001-B

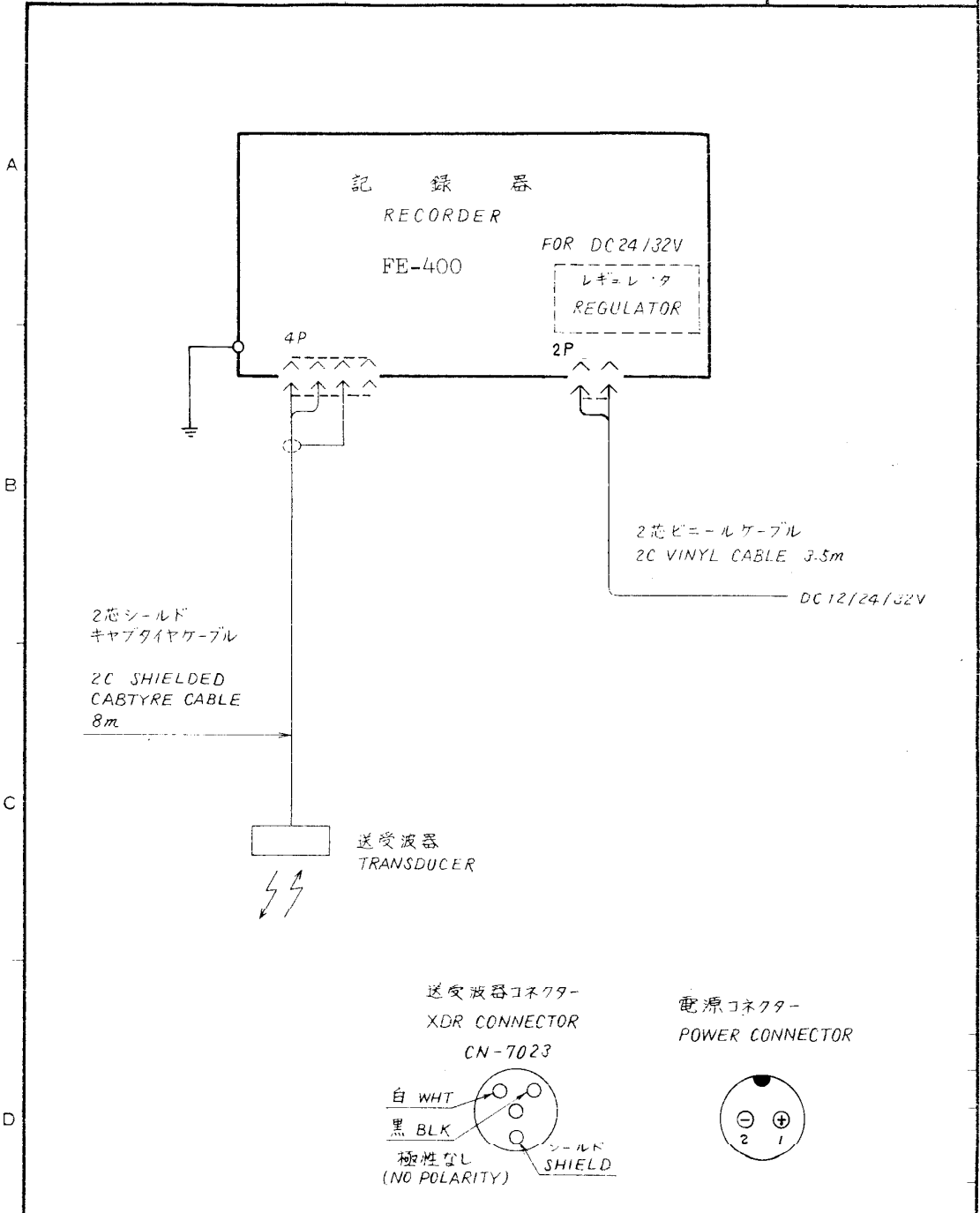

承認 APPROVED	品番 ITEM	品名 NAME	材質 MATERIAL	数量 QTY	図番 DWG. NO.	備考 REMARKS
APR. 19. 79 <i>[Signature]</i>		三角法 THIRD ANGLE PROJECTION				
検図 CHECKED	APR. 18. 79 <i>[Signature]</i>	尺 SCALE			FE-400 結線図 CABLING DIAGRAM	
製図 DRAWN	APR. 18. 79 <i>[Signature]</i>	重量 WEIGHT	kg	番 DWG. NO.	C 2 2 4 1 - 0 0 3 - B	

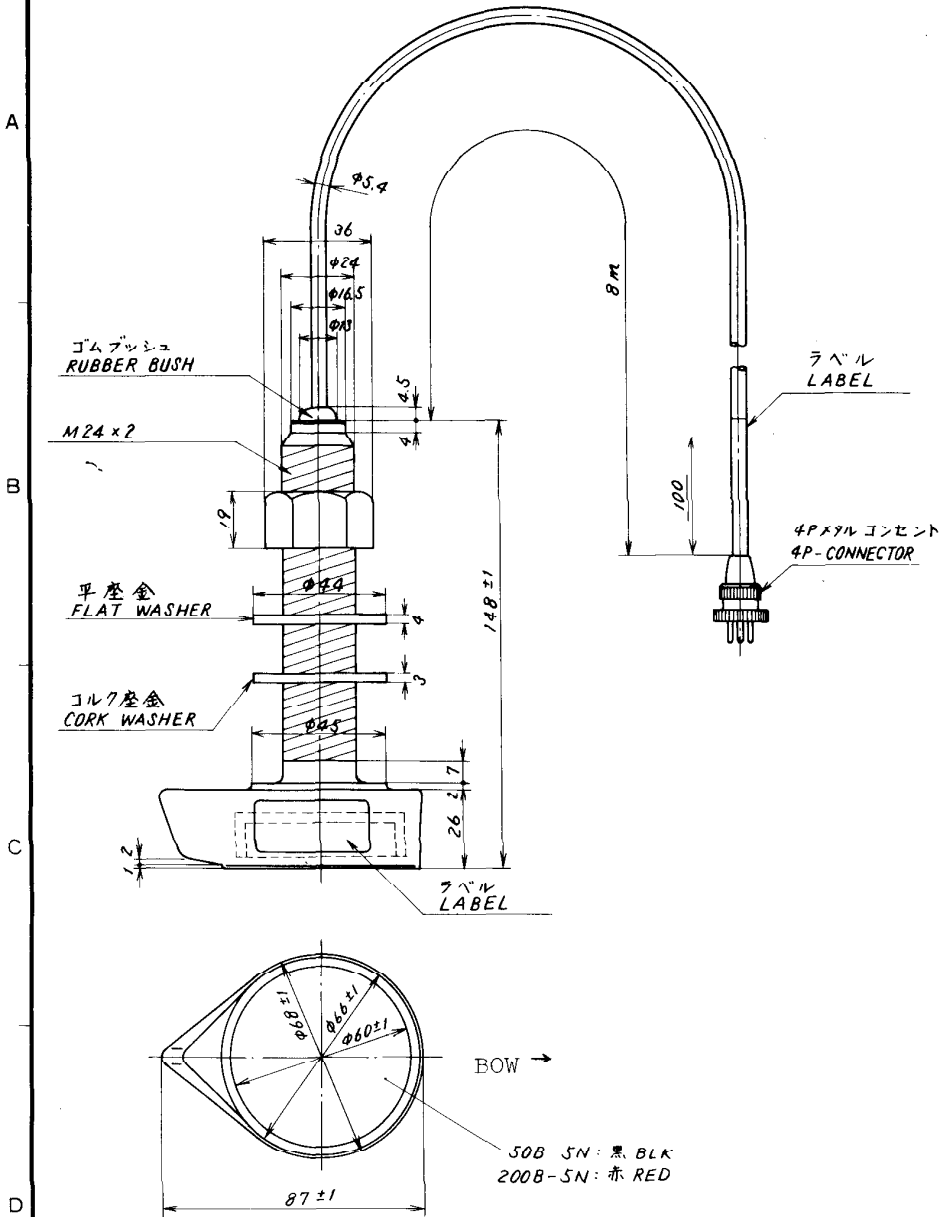

品番 ITEM	品名 NAME	材質 MATERIAL	数量 QTY	回番 DWG. NO.	摘要 REMARKS
承認 APPROVED	三角法 THIRD ANGLE PROJECTION	名称 TITLE	送受波器 TRANSDUCER		
検図 CHECKED	尺度 SCALE	1/2			
製図 DRAWN	重量 WEIGHT	kg	図番 DWG. NO.	C 2241-002-B	

Chapter 1. INSTALLATION

1-1. Recorder Unit

Prior to mounting, select a place easy and convenient for operation, for example, dashboard of steering room. Fix the mounting bracket at a suitable place with four wood-screws or bolts and nuts. Note that the recorder unit is connected to the transducer, power supply and ship's structure(grounding).

In case that the recorder is resonant with boat's vibration, remove the rubber cushion attached to the inner side of the mounting bracket. See below.

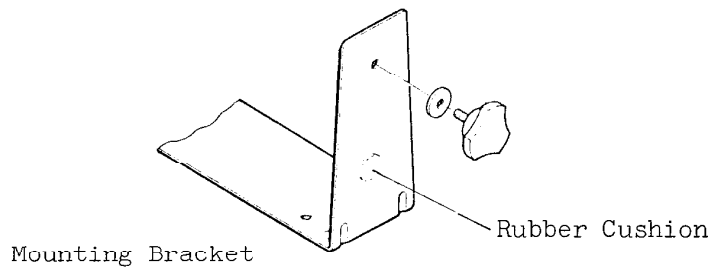

1-2. Power Supply

The recorder can be operated from DC11-15V as standard. DC19-40V is also available with optional built-in power adaptor. Be careful of the polarity when connecting to the power supply.

1-3. Transducer

Fig. 1-1 shows examples of transducer installations. The transducer is usually installed through the hull bottom after making a small hole.

Precautions for transducer installation:

1. Select a place as far from engine and generator as possible. In small boat, the mid-boat position is usually a good place for the transducer.
2. Make a hole of 25mm dia. on the hull plate. Refer to the drawing C2241-002-B.
3. Pass the transducer cable through attached nut and washers.

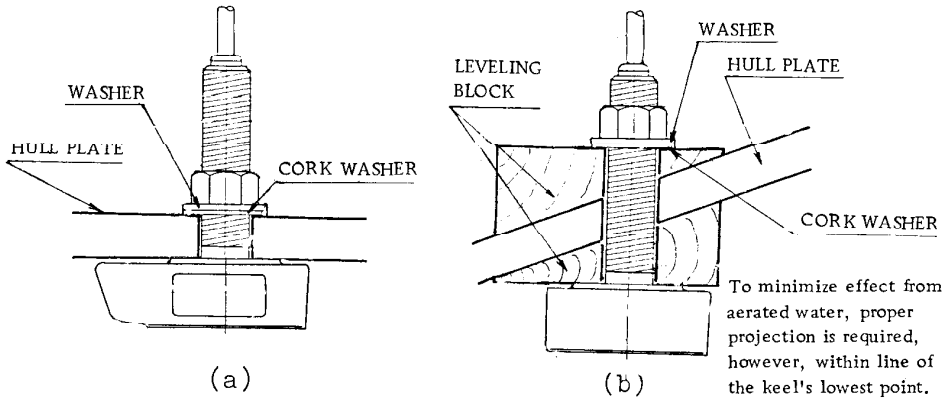
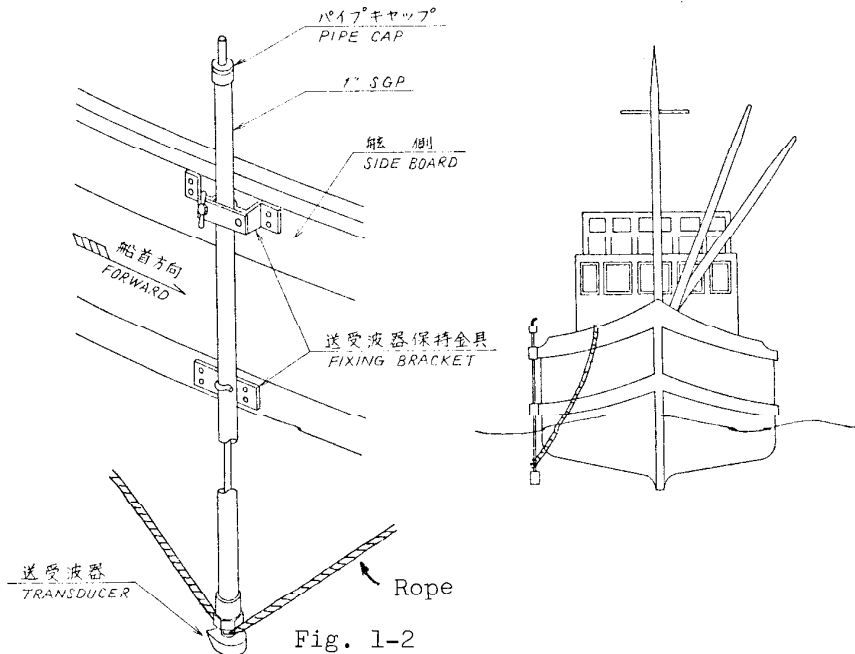

Fig. 1-1

4. Fix the transducer with the nut hand-tight.
5. When the hull bottom is slant, make the transducer face straight down by adding leveling blocks. Refer to Fig. 1-1 (b).

Fig. 1-2 shows the example of sideboard installation. In this case, the transducer should be submerged deep enough to avoid the effect of air bubbles during cruising.



FURUNO

NOTE:

1. When making a hole thru leveling block, take into account that the hole may become smaller in water due to expansion.

CHAPTER 2. OPERATION

2-1. Description of Controls and Switches

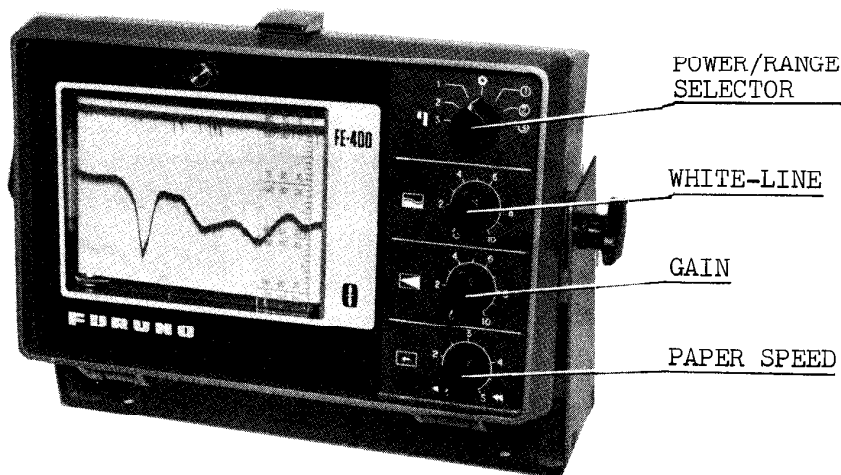

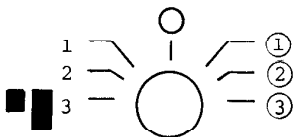

Fig. 2-1 Front Panel Controls

POWER/RANGE
SELECTOR 

This switch has two functions; power supply "On-Off" and selection of sounding range.



The sounding range is arranged on either side of "○"(Off-position). The left side (1, 2, 3) is for shallow water sounding and the right side (①, ②, ③) for deep sounding respectively.

GAIN 

The sensitivity of the amplifier is controlled by this knob. Turn this knob clockwise to get clear and distinct recording.

WHITE-LINE 

Turn this knob clockwise, and a white-line appears just below the seabed contour. This function facilitates detecting fish schools near or in contact with the seabed. If not required, turn it fully counterclockwise(Off-position).

PAPER SPEED



The paper advance speed is controlled by this knob. It varies from 5mm/min. (◀) to 20mm/min. (◀◀).

ILLUMINATION

When illumination is required, turn this switch to ON. See Fig. 2-2.

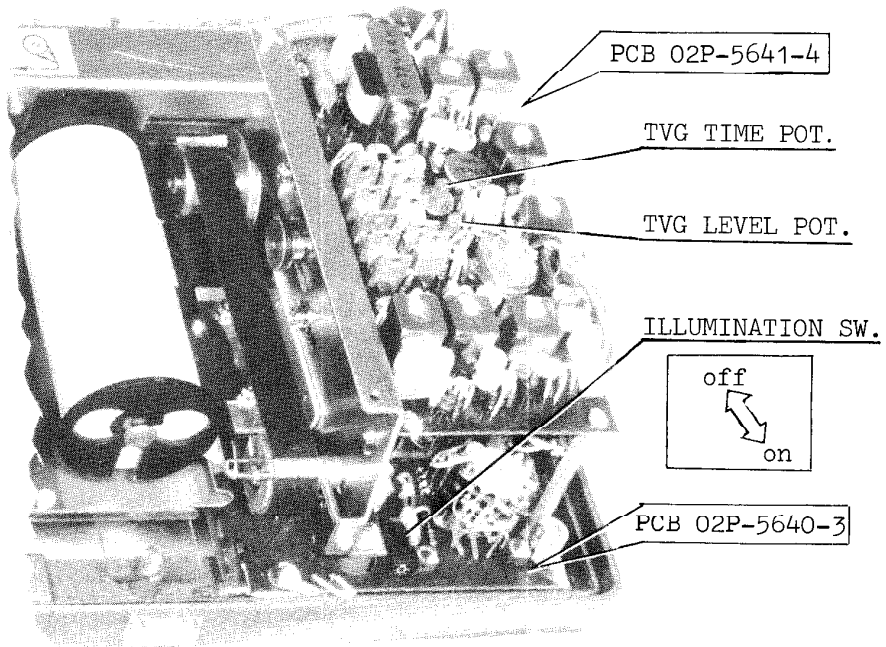

Fig. 2-2 Internal Controls & Switch
(Front Door Opened)

TVG LEVEL POT. & TVG TIME POT.

TVG(Time Varied Gain) function is incorporated to improve the echo presentation, namely to eliminate surface noise which may mask small object.

Refer to Fig. 2-2 which shows the location of these POTS. They are set at fully counterclockwise(minimum) position at the factory. Therefore, they are required to adjust with respect to fishing ground condition or customer's request.

TVG LEVEL POT. controls the degree of TVG effect. Refer to Fig. 2-3(a). Turn it clockwise for reducing the amplifier gain at close range. Fig. 2-3(b) shows the samples of TVG LEVEL setting.

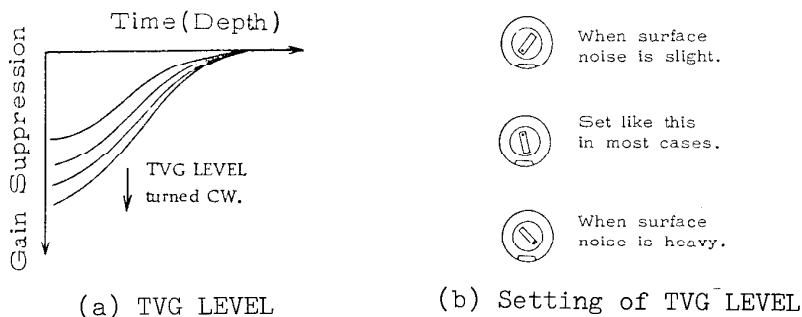

Fig. 2-3

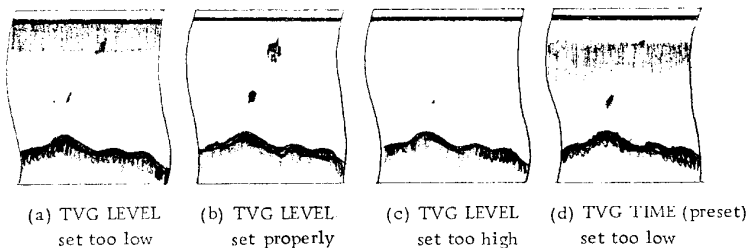

Fig. 2-4 TVG Effect

When the surface noise cannot be effectively eliminated as in Fig. 2-4(d), adjust TVG TIME POT. control for proper TVG range. Refer to Fig. 2-5(a). Turn it clockwise for expanding the effective range(depth) of TVG. Fig. 2-5(b) shows the examples of TVG TIME setting.

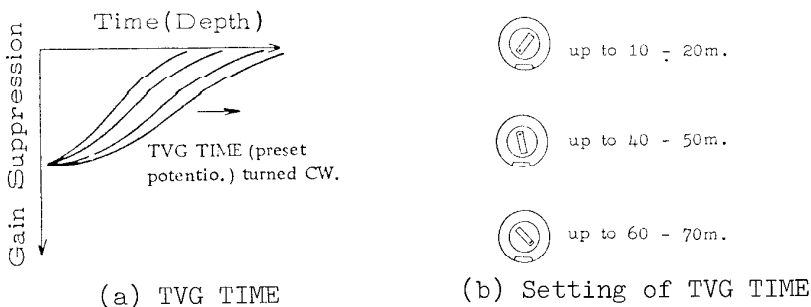

Fig. 2-5

2-2. Operating Procedure

1. Turn POWER/RANGE SELECTOR to desired sounding range, and power is applied to the equipment.
2. Turn GAIN control knob clockwise until noise slightly appears on the recording paper, then turn it counterclockwise a little.
3. If the zero line is plotted outside "0" of scale, correct its position referring to the para. 2-3, below.
4. Turn WHITE-LINE control knob clockwise when the detection of fish schools near or in contact with the seabed is required.
If not required, keep it fully counterclockwise (Off-position).
5. Adjust the PAPER SPEED knob for desired paper advance speed.

2-3. Adjustment of Zero Line

When the zero line is plotted outside "0" of scale, it can be corrected by the zero line adjuster.

To do this

1. Remove the plastic front panel by loosening the fixing screw. See Fig. 2-7.
2. Loosen the setscrew of zero line adjuster by hand, and move it until the zero line comes to "0" reading of scale. See Fig. 2-6.
3. Tighten the setscrew and put back the front panel as it was.

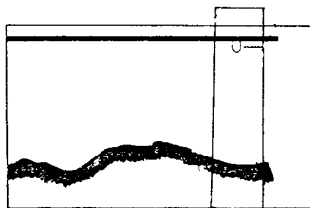

(a) Zero line plotted above "0" of scale.

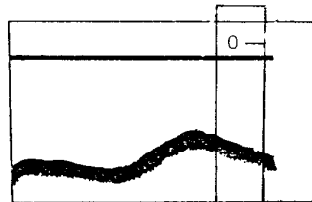

(b) Zero line plotted below "0" of scale.

Fig. 2-6



(a)

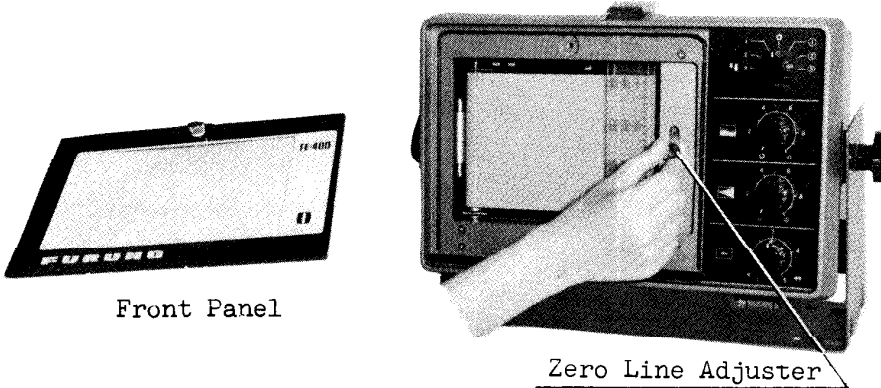

Front Panel

Zero Line Adjuster

(b)

Fig. 2-7

NOTE: The zero line can be shifted up to the half of paper width only on basic ranges, starting at zero. This feature enables the recording paper to be used two or more times.

When re-using the used-up paper, wind it tightly with its reel core held by hand, then set it again referring to Fig. 2-8 in para. 2-4.

FURUNO

2-4. Replacement of recording paper

Prior to the replacement, turn the POWER/HAUGE switch to "O" (Off-position) and open the cabinet door towards you after releasing the clasp.

Procedure

1. Send the recording belt to the rotating direction of hand until the stylus is clear of the paper.
2. Rotate the paper winding roller knob clockwise to wind-up the used paper. (Fig. 2-9 (A) (B))
3. Remove the brims and take out the used-up paper roll and paper feeding spool.
4. Set the new paper to the paper feeding shaft.
5. Insert the end of the paper into the slot of the winding spool, which was the paper feeding spool, and wind it two or three turns, then set it to the paper winding shaft. (Fig. 2-9 (C))
6. Put back the brims and connect the paper use by the paper winding roller. (Fig. 2-9 (D))
7. Lock the clasp as it was.

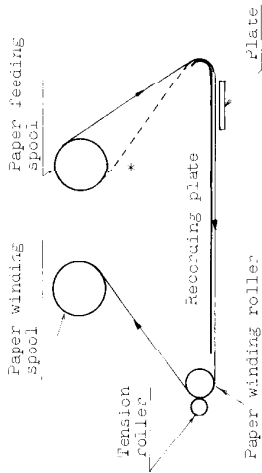

* Dashed line for re-using the used-up paper

Fig. 2-8 recording Paper set-up

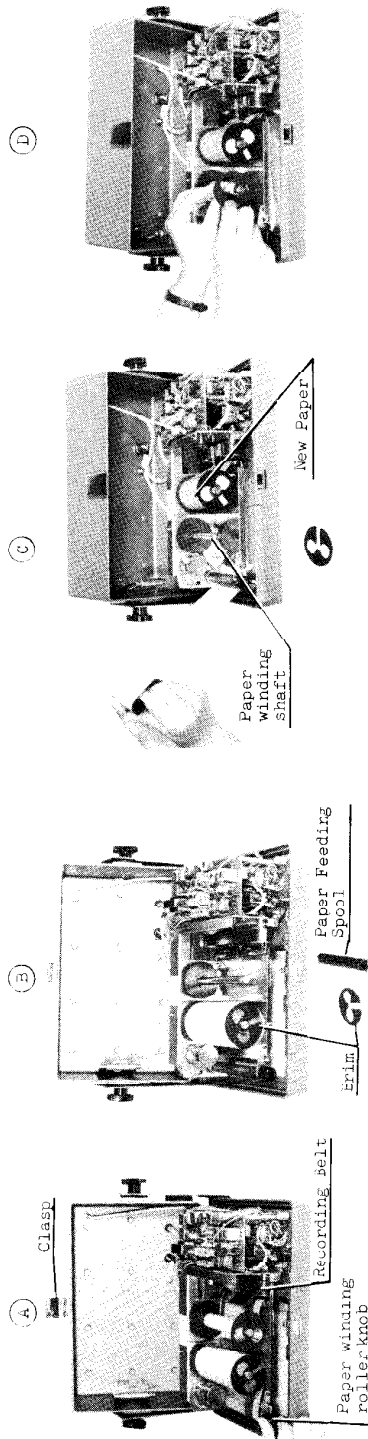

Fig. 2-9

CHAPTER 3. OBSERVATION OF RECORDING

3-1. Detecting Area

The detecting area varies depending on the main beamwidth (beam extent) as shown below. The objects out of the main beam but close to the beam, may also be presented in less dense and size.

Generally beamwidth depends on transmission frequency; narrower beamwidth is obtained with higher frequency.

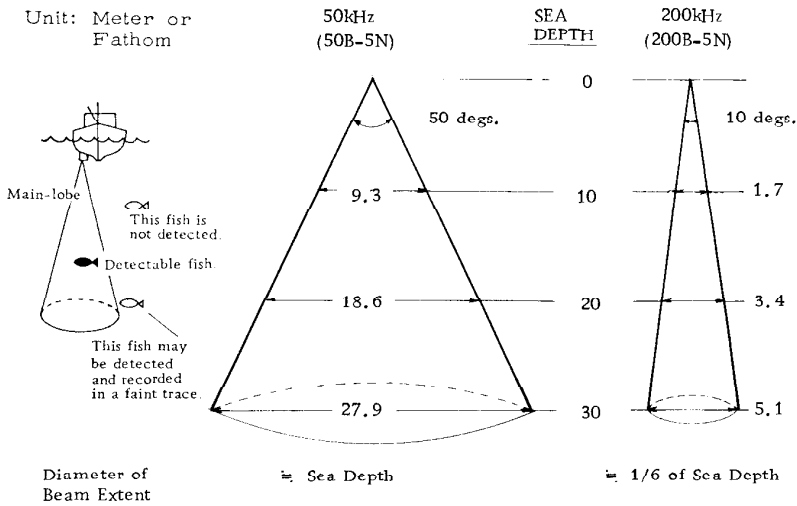

Fig. 3-1

3-2. Observation of Recording

Refer to Fig. 3-2, an example of recording.

1. Zero Line

The zero line appears at the upper edge of the recording paper when the basic range (e.g. 0 - 30m in type A) is selected. In the other range (shifted range) setting, no zero line appears. The line shows the position of the transducer installed on the ship's bottom or sideboard of boat.

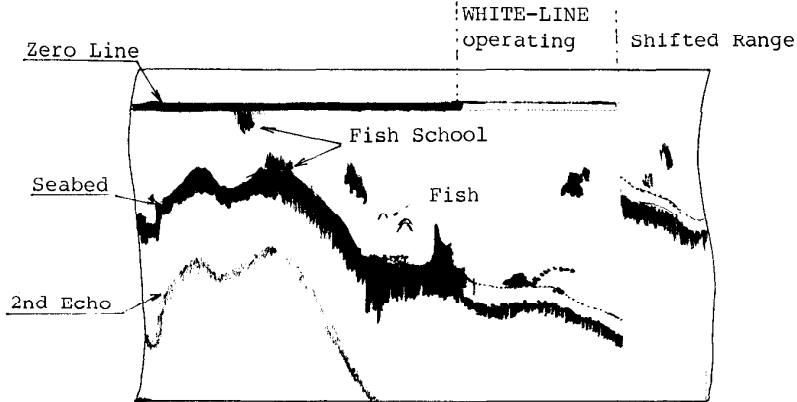

Fig. 3-2 Example of Recording

2. Echoes from Fish School

Fish echoes will generally be plotted between the zero line (no zero line in case of shifted ranges) and first echo of seabed. Usually the fish echo trace is weaker than the seabed echo trace because the reflection surface of fish is smaller and its reflection property is weaker comparing with seabed.

The size of fish school is ascertained from the density of the recording. The GAIN control should be adjusted carefully in order to get a clear recordings.

3. Seabed

The strongest echo is coming from the seabed. Under the shallow depth sounding, the second or third reflection may appear at recurring intervals. The intensity of the seabed echo can be used to determine the feature of the bottom (e.g. soft or hard). The harder the bottom is, the wider the bottom trace is. Beamwidth and amplifier gain also effect the seabed echotrace. Refer to Fig. 3-3 & 3-4.

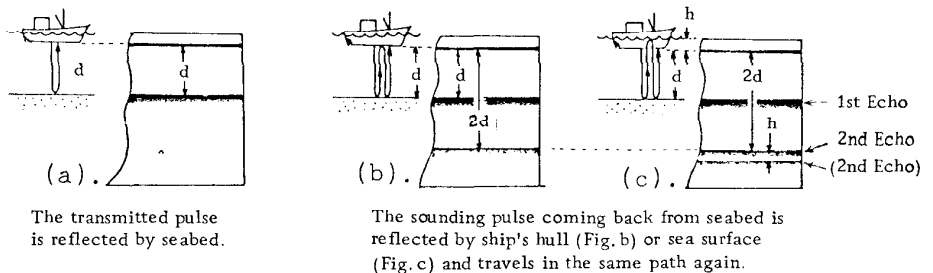

Fig. 3-3

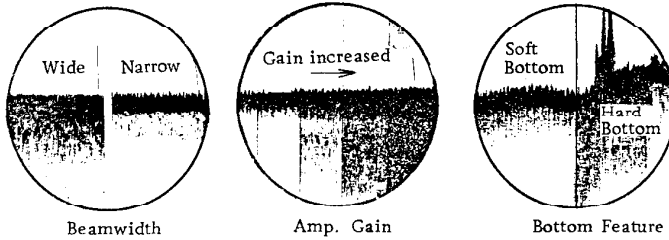
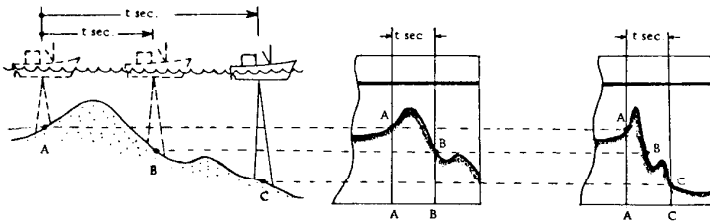

Fig. 3-4

The seabed sometimes appears on the recording paper as if it is very much diminished in size in paper advancing direction. This is based on the relation between ship's speed and paper advancing speed. At a constant paper advancing speed, the appearance of the echo trace is varies with the change of ship's speed as shown below.



(a). Slow Speed (b). Fast Speed

Fig. 3-5

When the sounding frequency is different, the seabed echo is also traced in different form as shown in Fig. 3-6.

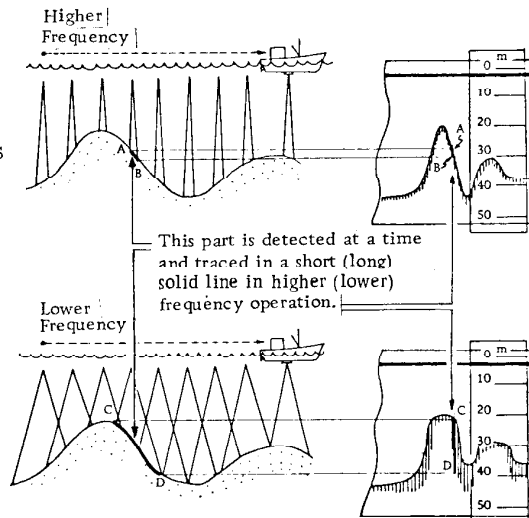

Fig. 3-6

4. Surface Noise

Noise appearing near the zero line is caused by the wake of another boat or aeration. Similar noise sometimes appears when a plancton layer or water temperature difference (thermocline) exists.

The function of TVG is to eliminate the noise masking surface fish and to give clear identification of fish echoes.

5. White-Line

Generally, fish schools on or close to the seabed are plotted on the recording paper as if they were small rising of seabed. For the identification of such fish schools, white-line function is useful.

When the while-line circuit is active, the echotrace of seabed is discriminated by a white belt following a thin and feeble line, on which fish close to or in contact with the seabed is recorded. If the seabed line is shaped as shown in Fig. 3-7(a), it is difficult to judge what the rising portion is; rock, any wreckage or bottom fish. The white-line function will then give a suggestion to make a correct judgement. If the rising portion is either rocks, wreckage or protruding parts of the seabed, the seabed line will become like Fig. 3-7(b). If it is a group of bottom fish, the seabed trace will be as Fig. 3-7(c).

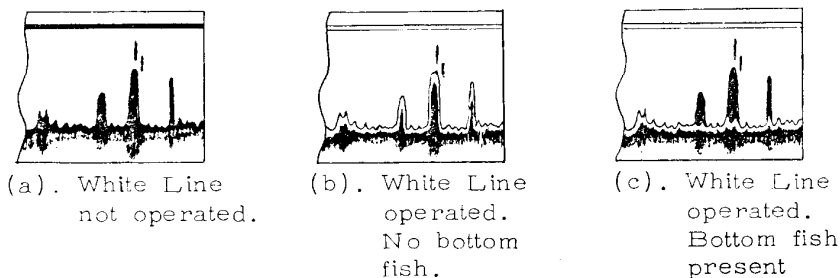

Fig. 3-7

6. Interference and Induction

Fig. 3-8 shows the noise caused by the acoustic effect by the swing of the ship, screw noise, induction from other electric wirings, spark and interference from other echosounders. In some cases, reduction of amplifier gain may moderate the appearance of these noises, but it is hard

to eliminate the noise completely without rectifying the noise source. Noise caused by electric induction, such as the one from generator or motor brushes, is plotted in irregular dots or blackening over the recording paper. The interference noise is shown in form of parallel broken lines having regular interval.

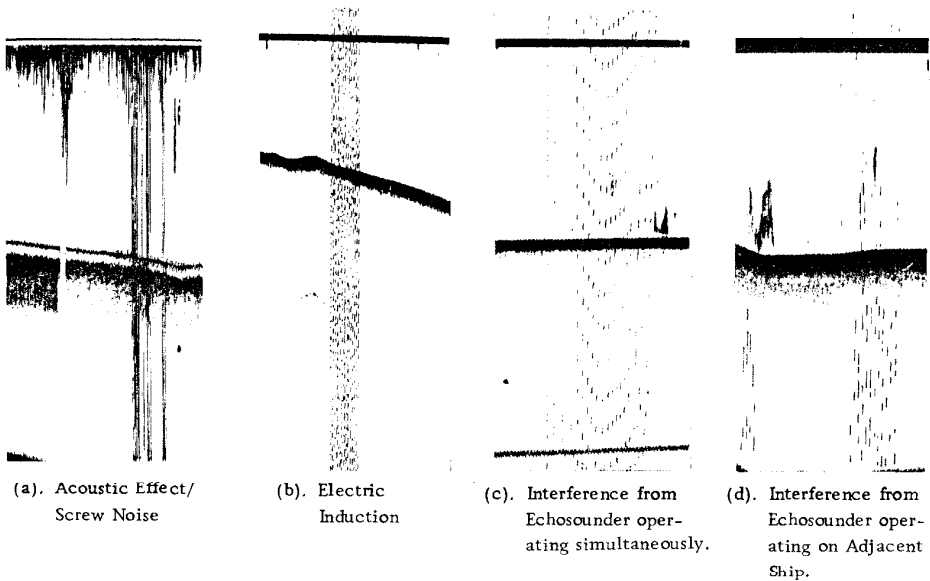

Fig. 3-8

7. Effect of Pitching and Rolling

If the boat rolls and pitches on rough sea, the normal echotrace becomes a zigzag; sawtooth recording.

8. Effect of Sidelobes

When the shape of the seabed is steep, a ghost image is caused by the sidelobe of the beam but this should not cause confusion as it is almost lighter than the actual seabed trace. Refer to Fig. 3-9(a). The effect of sidelobes may also appear on a flat seabed as shown in Fig. 3-9(b).4

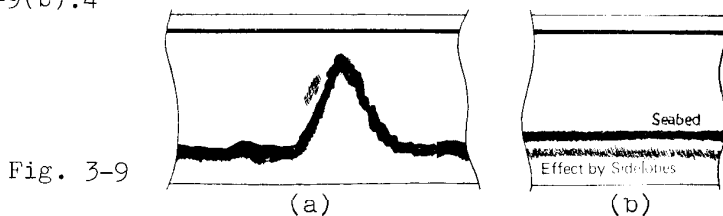

Fig. 3-9

CHAPTER 4. MAINTENANCE

To expect full performance for a long period, periodic inspection and maintenance are necessary. Also connection at the plug-jacks should be kept clean and tight.

4-1. Cleaning & Lubrication

1. Cleaning

As dry electrosensitive paper is used in this set, some carbon powder will pile up on the inner parts around the recording belt. Sweep off the carbon powder with a brush to avoid possible malfunction.

When cleaning, open the front door towards you after releasing the clasp & support string, then sweep off the carbon powder. Refer to Fig. 4-1.

2. Lubrication

When paper winding can not be done smoothly or mechanical noise is encountered, unhook the support string and check the gear engagement, then, if necessary, apply a thin coat of grease to the portions as shown in Fig. 4-1.

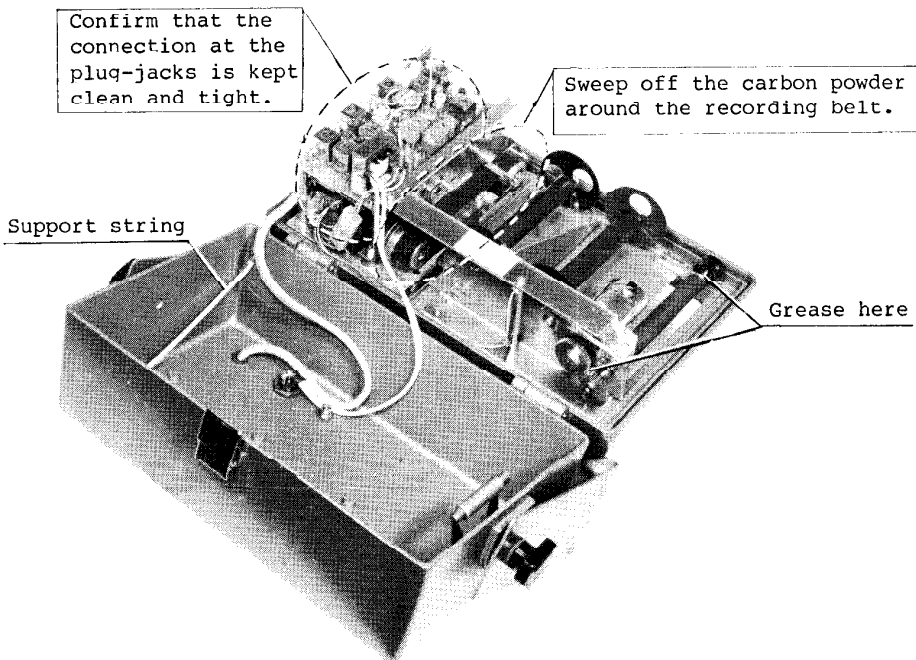

Fig. 4-1

4-2. Replacement of Stylus Assembly

Fig. 4-2 shows the stylus assembly.

When the stylus has worn and becomes shortened causing a poor recording, replace the whole stylus assembly.

In case that the stylus assembly is replaced, round the nib of the stylus by sandpaper or something.

Type: FDW-2250- \triangle

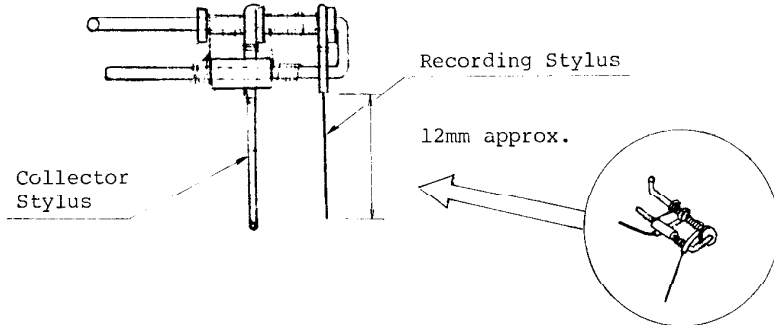
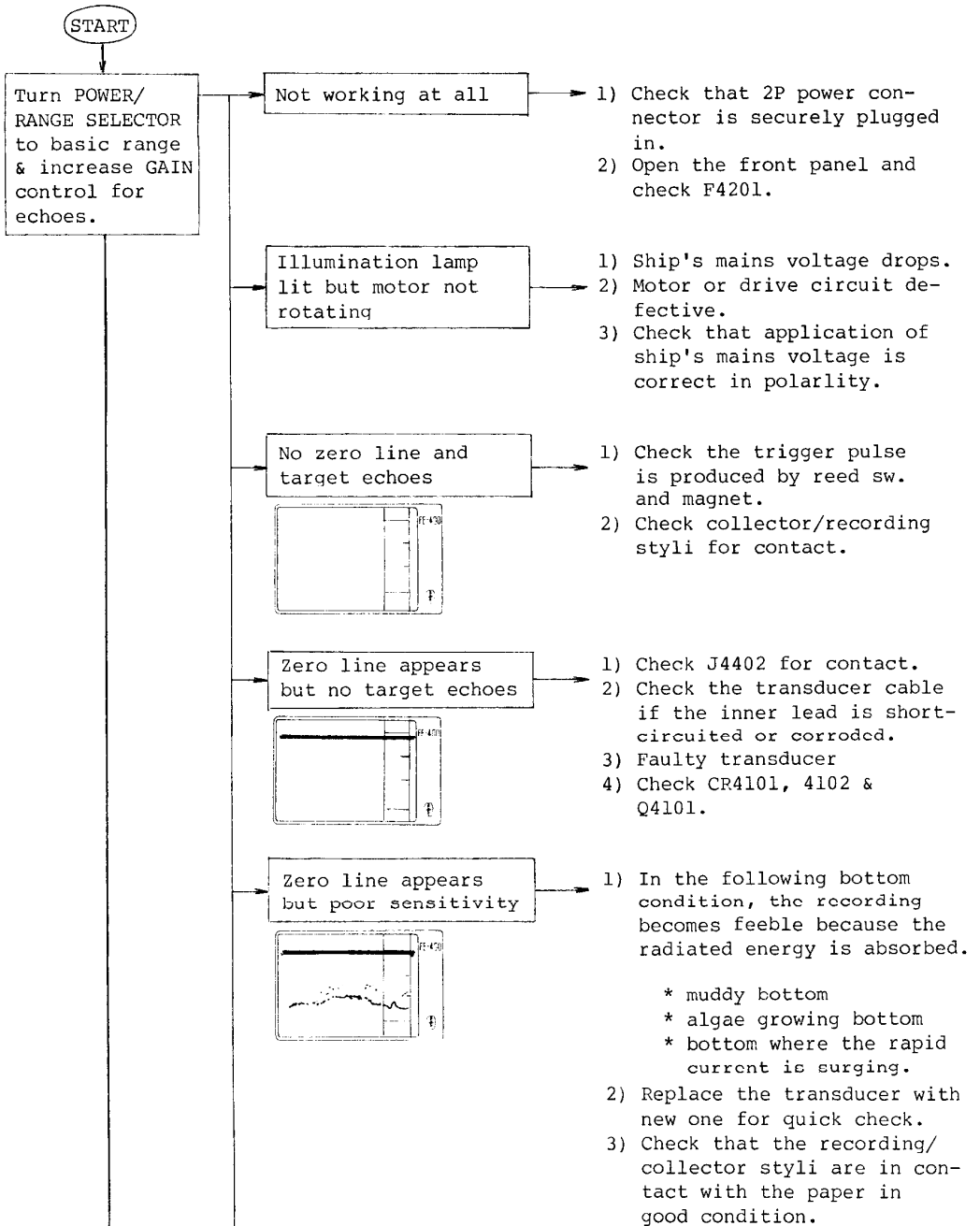
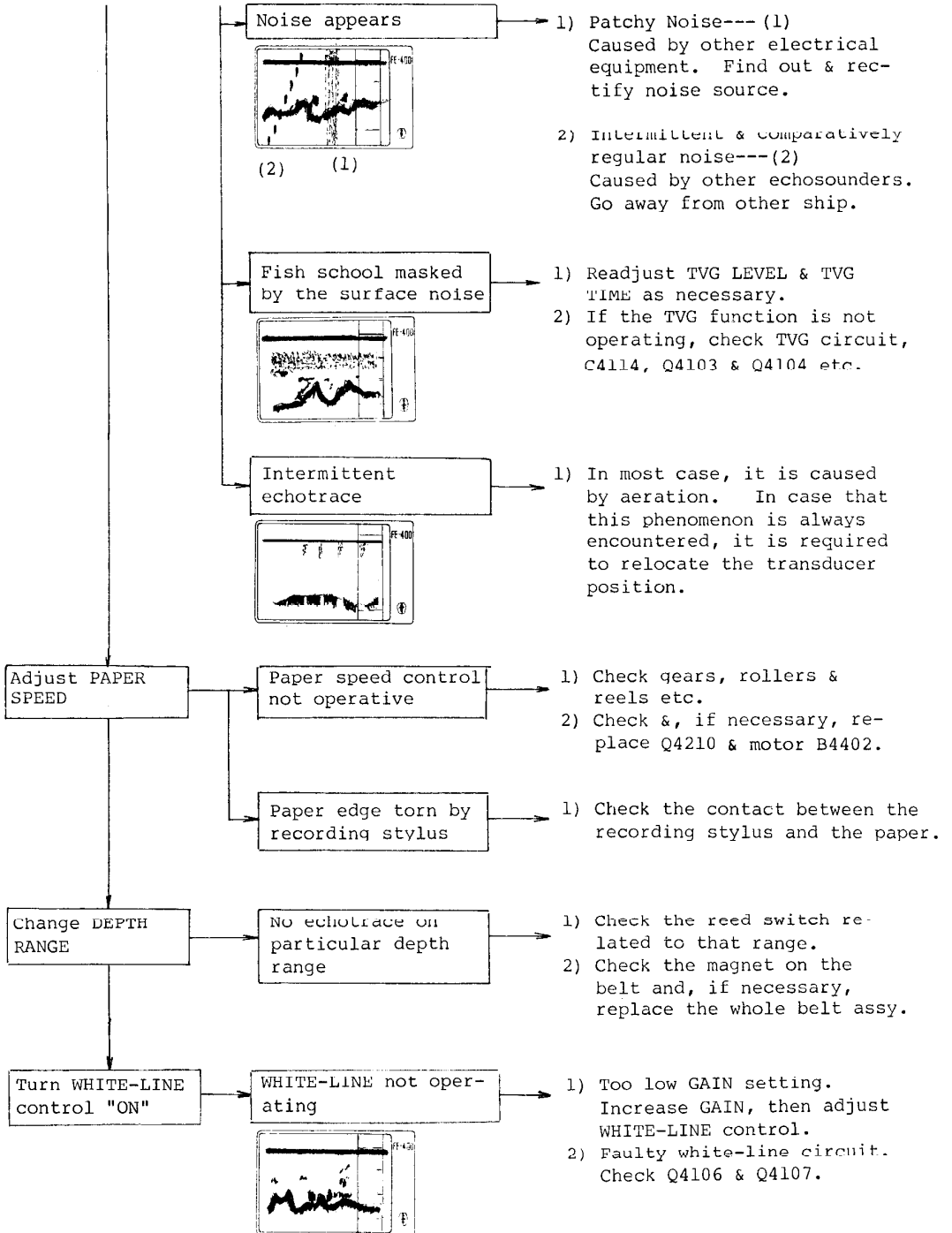

Fig. 4-2 Stylus Assembly

CHAPTER 5. TROUBLESHOOTING

5-1. Troubleshooting Flow Chart





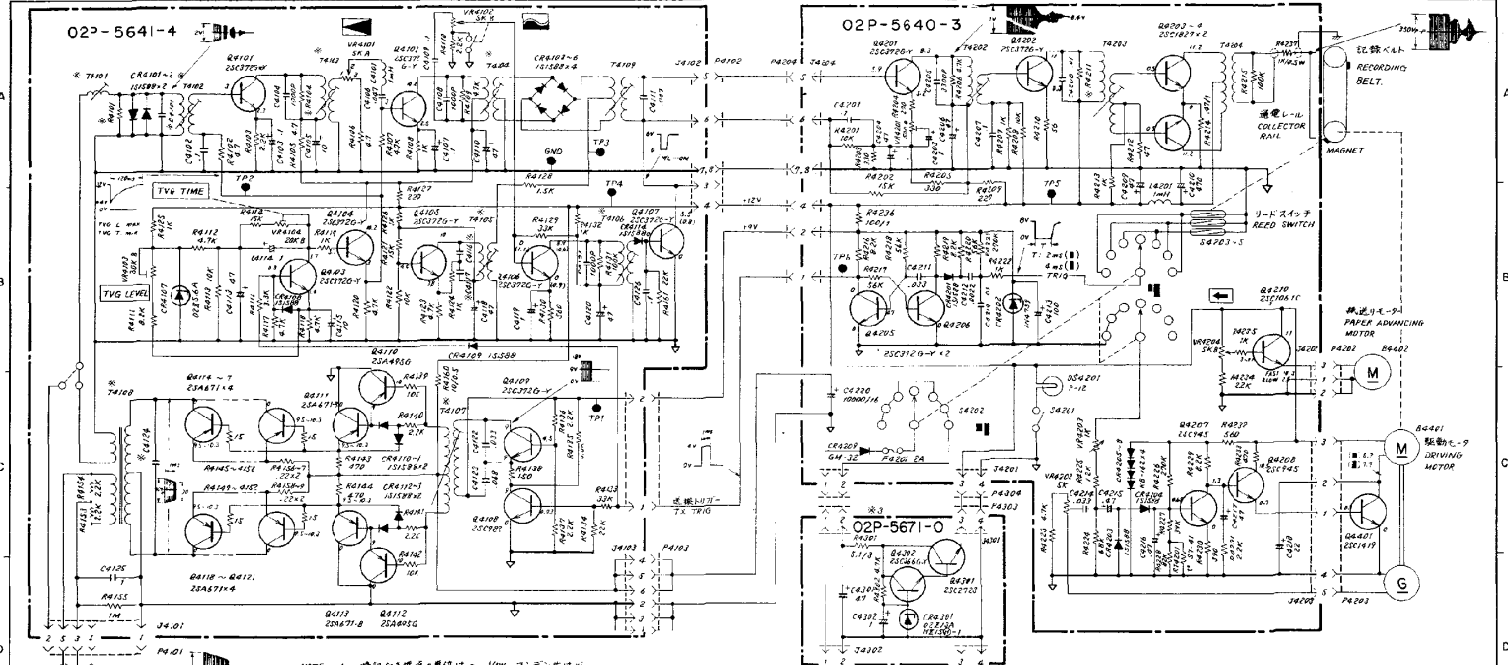

NOTE 1. 特記なき抵抗値はΩ, V.W. 3.3等ナシ也。
 ALL RESISTANCE IN OHMS, V.W. AND CAPACITANCE IN MICROFARADS.
 2. *印の部品の足数は型式は送振周波数、トランス、下是参照。
 * PARTS DIFFERENT ON SYSTEM FREQUENCY. SEE TABLE BELOW.
 3. *3 定電圧基板 02P-5671-0 は DC24/22V 時のみ使用。
 PCB 02P-5671-0 IS USED ONLY FOR DC24/22V INPUT.

	T4101	T4102	T4103	T4104	T4105	T4106	T4107	T4108	C4101	C4116	C4117	C4126	R4141	R4211	R104
50KHZ	T4101	T4102	T4103	T4104	T4105	T4106	T4107	T4108	C4101	C4116	C4117	C4126	R4141	R4211	R104
200KHZ	T410A	T4102A	T4103A	T4104A	T4105A	T4106A	T4107A	T4108A	C4101A	C4116A	C4117A	C4126A	R4141A	R4211A	R104A

* 送振周波数/D.C.電圧は最大
 W/L 断り測定、1 月以内 W/L 断り
 動作にて測定。
 WAVEFORMS & DC VOLTAGES ARE MEASURED
 WITH "GAIN" MAX "W/L" OFF VALUES IN
 1 月 WITH W/L MAX.

船内電源 SHIPS MAINS
 + (WHY) DC12V
 - (BLK) DC24/22V 送3
 Approved
 Checked
 Drawn

TITLE
FE-400 魚群探知機 ECHOSUNDER

DWS, No. C 2241-004-F