

FURUNO

OPERATOR'S MANUAL

COLOR VIDEO SOUNDER

MODEL FCV-552

This manual applies to sets with
serial number 8320-1876 and after.

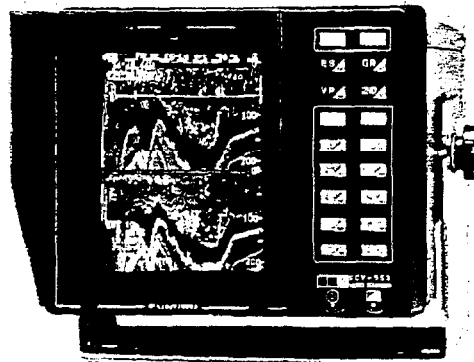

FURUNO ELECTRIC CO., LTD.
NISHINOMIYA, JAPAN

A WORD TO FURUNO FCV-552 OWNERS :

Congratulations on your choice of the FURUNO FCV-552 Dual Frequency Color Video Sounder! We are confident that you will enjoy many years of operation with this fine piece of equipment.

For over 30 years Furuno Electric Company has enjoyed an enviable reputation for quality and reliability throughout the world. This dedication to excellence is furthered by our extensive global network of agents and dealers.

The FCV-552 Color Video Sounder is just one of the many Furuno developments in the field of echosounding. The compact, lightweight but rugged unit is easy to install and operate and is suitable for both fresh and salt water applications.

This unit is designed and constructed to give the user many years of trouble-free operation. However, to obtain optimum performance from this unit, you should carefully read and follow the recommended procedures for installation, operation and maintenance. No machine can perform to the utmost of its ability unless it is installed and maintained properly.

We would appreciate feedback from you, the end-user, about whether we are achieving our purposes.

Thank you for considering and purchasing Furuno equipment.

CONTENTS

	<u>Page</u>
1. FEATURES	1
2. OPERATIONAL CONTROLS	2 to 3
CONTROLS AND KEYS ON THE FRONT PANEL	2
FUNCTION OF CONTROLS AND KEYS	2
3. BASIC RULE OF KEY OPERATION	4 to 5
PRIMARY AND SECONDARY FUNCTIONS OF TOUCHPAD KEY	4
RULE OF KEYING OPERATION	4
4. PICTURE MODE	6
ES PICTURE PAGE.....	6
GR PICTURE PAGE	6
VP PICTURE PAGE	6
5. ES PAGE OPERATION	7 to 21
BASIC OPERATION	7
Power on/off	7
Adjusting Brilliance	7
Selecting Presentation Mode	7
Normal Picture Range Selection	9
Bottom-Lock Expansion Range Selection	11
Gain Control	11
Adjusting TVG (Time Varied Gain)	11
Picture Advance Speed Selection	12
Noise Limiter	12
Clutter	13
USEFUL FUNCTIONS	13
Picture Record/Recall	13
Target Depth Measurement by VRM	14
Alarm	14
Automatic Bottom Tracking	14
Transmission Rate Selection	17
Distance-to-go Preset	18
Color Selection for Day and Nighttime Operations	18
Depth Unit Selection	19
Selecting Source of Speed Data	19
Turning-off Depth Scale	20
Temperature Unit Selection	20
INDICATORS	21

6. GR PAGE OPERATION	22 to 25
OPERATION	22
Selecting Picture Advance Speed	22
Water Temperature Alarm Setting	23
Plotting and Recalling Event Mark	24
INDICATORS	25
7. VP PAGE OPERATION	26 to 29
OPERATION	26
Selecting Range Scale	26
Plotting and Recalling Event Mark	26
Color Selection for Day and Nighttime Operations	27
Depth Unit Selection	27
Selecting Source of Speed Data	27
INDICATORS	28
8. INTERPRETING THE DISPLAY	30 to 34
TEST PATTERN	30
ZERO LINE	30
SEABED	31
Bottom Profile	31
Bottom Nature	31
FISH SCHOOLS	32
Fish Quantity	32
Bottom Fish	32
PLANKTON/CURRENT RIP	33
Plankton	33
Current Rip	33
SURFACE NOISE	33
AERATION	33
ZIG-ZAG BOTTOM	34
FALSE IMAGE	34
INTERFERENCE	34
9. IF SOMETHING SHOULD GO WRONG WITH YOUR UNIT	35 to 38
OPERATION CHECK	35
SYSTEM DIAGNOSIS	38

10. INSTALLATION	39 to 43
DISPLAY UNIT	39
TRANSDUCER	41
Examples of Transducer Installation	42
FCV-552 CABLING DIAGRAM	43
11. HOW TO CHANGE INTERNAL SETTINGS	44 to 45
12. SPECIFICATIONS	46 to 48
SCHEMATIC DIAGRAMS	49 to 55
APPENDIX	
HOOKING UP SHIP'S POSITION DATA FROM POSITION FIXING EQUIPMENT	AP-1
Furuno LC-90 Loran Navigator	AP-1
Furuno FSN-50 Satellite Navigator	AP-2
Other Make Position Fixing Equipment with NMEA 0183 Data Format	AP-2
DEFAULT SETTING	AP-3

1. FEATURES

The FCV-552 is a dual-frequency color video sounder which has a large variety of functions by means of a state of the art computer technology, all contained in a splash-proof rugged aluminum case that is compact to fit almost any size boat.

- 1) Three pages of pictures (single or dual frequency echo sounding picture, water temperature graph* and course plotting*), which are concurrently plotted and selectively projected onto the screen, triple the display capability.
- 2) 8-color presentation (including background) shows the variations in echo intensity, on a 8" diagonal CRT. Detailed information on fish density and the nature of the bottom are obtainable. For operation in a bright environment, a 6-color presentation mode is available.
- 3) Picture record/recall function permits later reference.
- 4) Digital display of ship's position*, own ship's speed and water temperature* in addition to water depth ensures finding of best fishing ground and safe navigation.
- 5) Four picture advance speeds for various fishing conditions. Ship's speed dependent advance is also available for presentation with constant horizontal scale regardless of ship's speed.
- 6) Six basic ranges, from 0-10m to 0-1000m. Unit of measurement may be changed from meters to fathoms, feet or passi/braza.
- 7) Range phasing allows the start of basic range to be set from zero to a maximum of 1000 meters, and automatic bottom tracking mode permits unattended range phasing operation.
- 8) Variable range marker measures exact target depth.
- 9) Either a bottom alarm or a fish alarm may be activated. The operator is alerted when bottom echoes or fish echoes between the transducer and the bottom enter into the operator preset alarm zone. Also a water temperature alarm* is available to find a location where fish habit.
- 10) Six pulselengths from 0.2 to 3.6 msec. for excellent short range and deep range performance.
- 11) Powerful noise limiter ensures interference-free operation on congested fishing grounds.
- 12) Universal 11-40VDC power supply, drawing less than 50W of power.

* Optional position fixing equipment and speed/temperature sensor device are required.

2 OPERATIONAL CONTROLS

The front part of the display unit is separated into two sections: controls on the right-hand side, and the CRT on the left-hand side. Every touchpad control has associated with it an indication on the screen using the same label found on the touchpad. Changing a touchpad setting will cause a corresponding change in the indication on the screen, as well as a change in the appearance of the echoes being viewed.



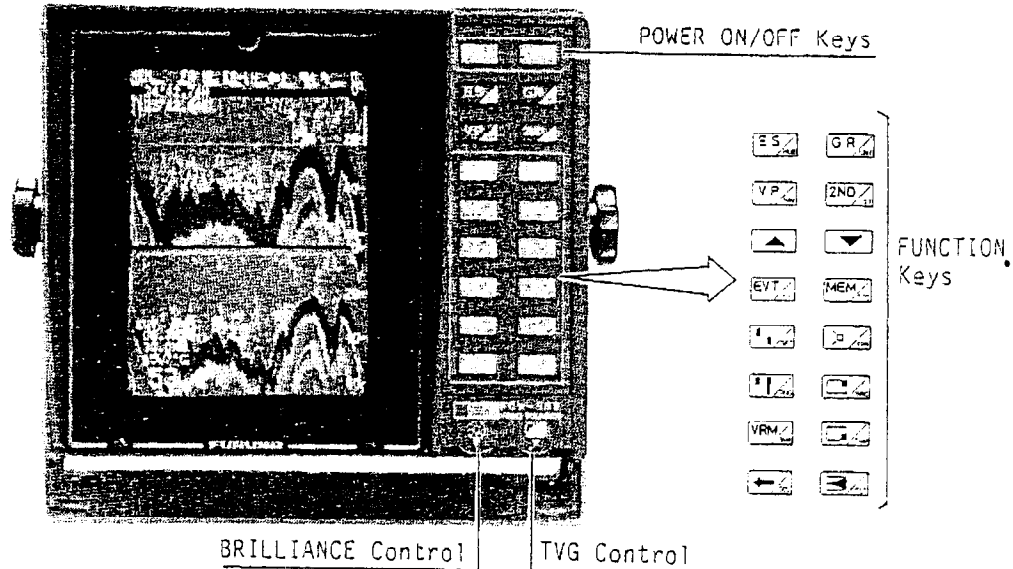





















CONTROLS AND KEYS ON THE FRONT PANEL



FUNCTION OF CONTROLS AND KEYS

KEY	FUNCTION
	Turns ON.
	Turns OFF. Press and keys simultaneously.

KEY	PRIMARY FUNCTION	SECONDARY FUNCTION
	Changes function of keys from primary to secondary.	Changes function of keys from secondary to primary.
	Selects ES (Echo Sounder) page. Press the or key to select presentation mode.	Selects presentation color for daylight or night viewing.

	Selects GR (Graph) page. Press the  or  key to set picture advance speed.	Selects depth measurement unit; M, FT, FA, P/B.
	Selects VP (Video Plotter) page.	Selects source of ship's speed data. INT: from speed sensor. EXT: from Ioran navigator. OFF: ship's speed not displayed. In INT mode, compensation value for speed error can be entered.
	Plots event mark. Press the  key and then  key to plot the event mark. Press the  key and then the  to recall the event mark.	Selects noise limiter function. OFF: No function N1: Low N2: Medium N3: High
	Stores or plays back the picture. Press the  key and then the  key to store the picture. Press the  key and the  key to playback the picture.	Sets either distance-to-go or distance run.
	Sets phased range (display start depth).	Selects auto-shift or manual-shift of range phasing.
	Selects basic range of ES picture page and plotting range of VP picture page.	Reprograms basic range.
	Selects alarm function; OFF, BA (bottom alarm), FA (fish alarm)	Selects KP (Keying Pulse) rates.
	Sets upper alarm zone.	Selects bottom-lock expansion range.
	Sets lower alarm zone.	Selects unit of temperature measurement °C or °F.
	Moves the variable range marker.	Bottom-lock expansion marker ON/OFF.
	Selects picture advance speed.	Depth scale ON/OFF.
	Adjusts gain.	Sets level of clutter suppression.
	Adjusts screen brilliance.	
	Adjusts IVG.	

3. BASIC RULE OF KEY OPERATION

PRIMARY AND SECONDARY FUNCTIONS OF TOUCHPAD KEY.

As you may have noticed from the table on pages 2 and 3, most touchpad keys perform two different functions of primary and secondary and the **[2ND]** key serves to change the function of all keys. Every depressing of the key changes the functions between primary and secondary.

For operator's convenience, the key layout as illustrated in (b) is displayed over the screen while the secondary function is selected. In other words, while the normal picture as in (a) is displayed, all keys perform the primary function.

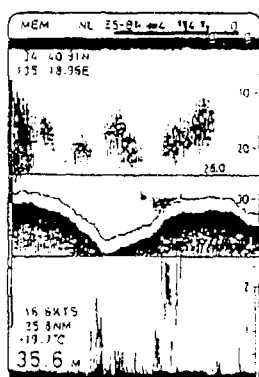

(a)

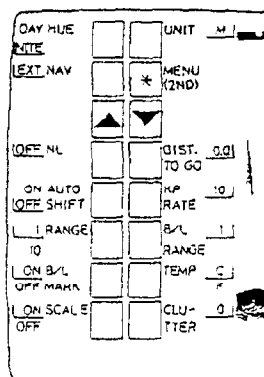

(b)

RULE OF KEYING OPERATION

PRIMARY FUNCTION

For the primary function the keying operation is done through two steps, though there are a few exceptions which will be mentioned later on.

- 1) First hit the desired function key. For example, if you want to change the Basic Range Setting, hit the **[1.2]** key.
- 2) Then press the **▲** or **▼** keys to change the setting of the selected function.

SECONDARY FUNCTION



For the secondary function some keying operations are done through two steps just as you do for the primary function. The others are done through a single keystroke; if you press the desired function key, the setting will change.

Look at the key layout shown above. You will see that some key symbols have two item names displayed beside them and the others only one.

When two item names are displayed, the setting can be changed by just pressing the corresponding function key. Every pressing of the key moves the underline "L" between the item names.







In the illustration shown at right, AUTO SHIFT is presently OFF since the underline "L" is appearing under the OFF. If you press the  keys, this underline moves under the ON and the automatic bottom tracking mode is selected.

Single Key Stroke

 ON AUTO  *
 OFF SHIFT

Double Key Stroke

*  CLU- 5
TTER

When only one item name is displayed, the setting can be changed in two steps of key operation: function key and then the  or  key. An example to this is the  key. To change the setting of the clutter, you have to press the  key and then the  or  key.

4. PICTURE MODE

This unit is continuously producing the following three pages of pictures internally, and you may display one of the pages on the screen at any time you wish.

ES PICTURE PAGE

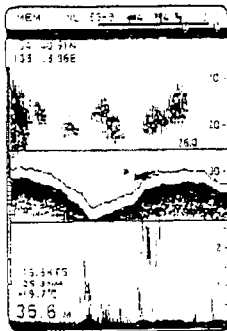

Echo sounder picture is displayed on this page.

Press the **ES** key to display the ES picture page.

GR PICTURE PAGE

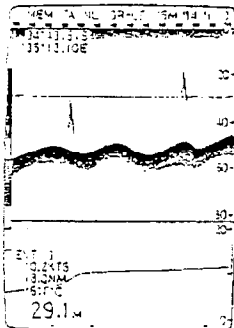

Echo sounder picture is displayed on the upper 2/3 of the screen, and the rest of the screen is utilized to produce the water temperature graph (the optional speed/ temperature sensor is required). Since the picture advance speed can be set very low, you may observe long-term transition of underwater conditions and temperature.

Press the **GR** key to display the GR picture page.

VP PICTURE PAGE

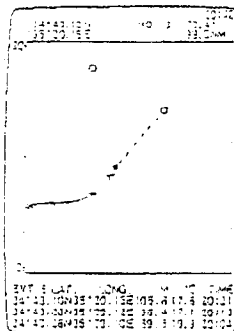

This page can be used when your unit is connected to a position fixing equipment. In this mode, the unit works as a Video Plotter, displaying ship's position on the chart.

Press the **VP** key to display the VP picture page.

Note that three pages are produced concurrently. While you are watching the ES Picture on the screen, for example, the GR and VP Pictures are also being produced simultaneously though they are not seen on the screen.

5 ES PAGE OPERATION

This chapter mainly describes operations on the ES (Echo Sounder) page, which is obtained by pressing the **ES** key.

BASIC OPERATION

POWER ON/OFF

(Power-on)

Press the **PWR** key. A picture will be displayed in a few seconds when the CRT is warmed up.

Note: Since most of the key settings are backed up with the built-in battery, you will have a picture with the last used settings.

(Power-off)



Press the **PWR** and **OFF** keys simultaneously.





ADJUSTING BRILLIANCE

Turn the  knob to adjust the picture brilliance.

Note: To change the brilliance of the background, see page 45.

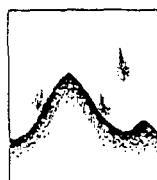
SELECTING PRESENTATION MODE

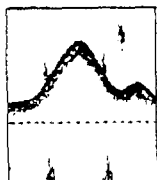
The ES picture page has six presentation modes and you may select one of them with the  or  key.

Mode	Normal (High Freq.)	Normal (Low Freq.)	Dual Freq.
Symbol	"H"	"L"	"LH"
Picture			
Mode	Normal + Bottom-Lock (High Freq.)	Normal + Bottom-Lock (Low Freq.)	Low Freq. Nor- mal + Mix
Symbol	"HB"	"LB"	"MX"
Picture			

(Procedure)

1. Press the **ES** key.
2. Press the **▲** or **▼** key to change the presentation mode. The symbol of the selected mode is displayed at the top center of the screen.

Presentation Mode

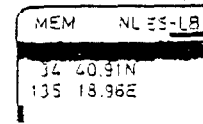

NOTE: For the bottom-lock expansion picture, the seabed contour must be steadily and distinctly plotted in red or reddish brown. Adjust the  (gain) for the best seabed presentation.

(How the MIX mode works.)



The MIX mode compares echo intensity between low and high frequencies, and displays echoes from small fish in discriminative colors. This can be performed by utilizing the general tendency that small fish return stronger echo against a high frequency rather than a low frequency. How it actually works is shown below.

- 1) If an echo on the high frequency is stronger than the corresponding echo on the low frequency, the high frequency echo is displayed because it may be a small fish.
- 2) If the echo on the low frequency is stronger than or equal to the echo on the high frequency, it is less likely to be a small fish and displayed in blue.
- 3) If the echoes on both frequencies have the intensity corresponding to reddish brown or red, they are displayed in reddish brown or red; this is necessary to display the transmission line and seabed in reddish brown or red.

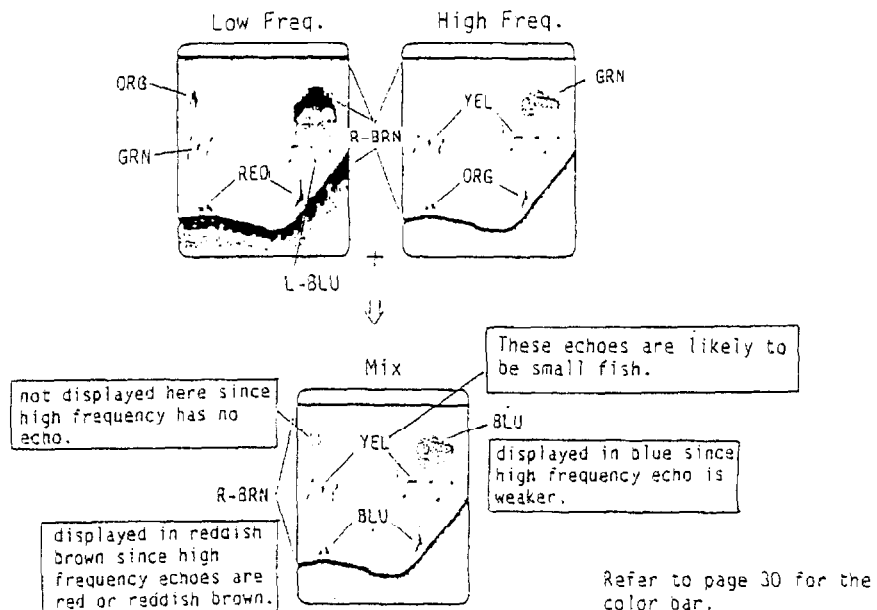
In short, the echoes displayed in orange thru light blue are likely to be small fish.



NORMAL PICTURE RANGE SELECTION

The  (Basic Range) and  (Range Phasing) keys used together determine the under water area you will observe on the screen. To understand how range selection works, imagine that we are throwing a viewing "window" into the water column, where the Basic Range changes the vertical width of the window and the Range Phasing moves the window anywhere in the water column.

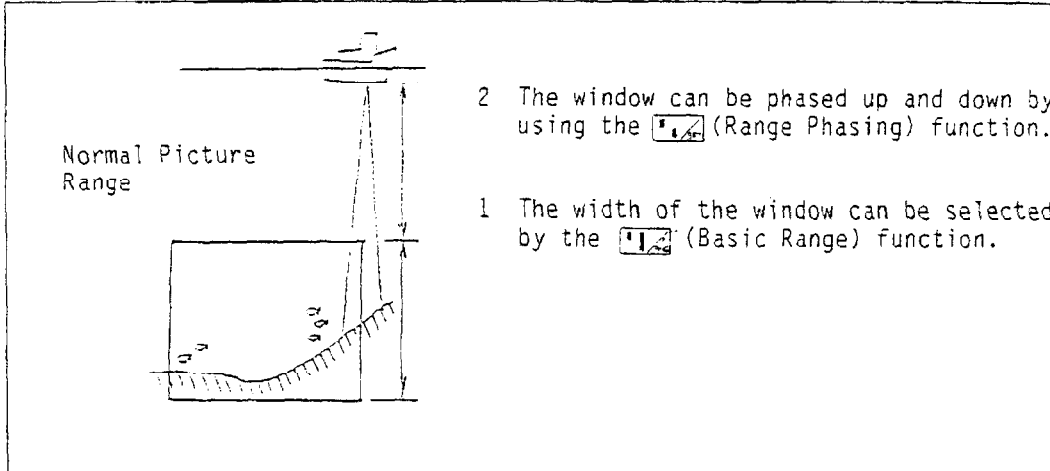



Basic Range Selection

Six basic range "windows" have been programmed at the factory as below. However they can be operator-reprogrammed as explained on page 10.

Basic Range	1	2	3	4	5	6
Meters	10	20	40	80	160	300
Feet	30	60	120	250	500	1000
Fathoms	5	10	20	40	80	160
P/B	6	12	25	50	100	200



(Procedure)

1. Press the  key.
2. Press the  key to increase the basic range and press the  key to lower it.

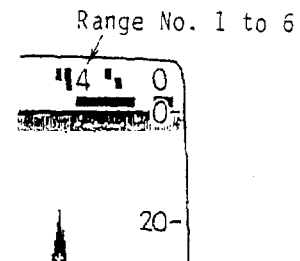
The range selected is displayed at the top of the screen to the right of the basic range indicator.







Range Phasing

The basic (window) selected can be moved up and down with the ,  and  keys. Step of range phasing differs with the basic range selected.

Basic Range	Phasing Step
Less than 500m (FT, FA, P/B)	1m(FT, FA, P/B)
Greater than 500m(FT, FA, P/B)	10m(FT, FA, P/B)

(Procedure)

1. Press the  key.
2. Press the  key to move the range window downward and the  key to move it upward. The amount of range phasing, i.e., the depth at the upper limit of the window, is digitally indicated at the top right corner of the screen with the "  " symbol.

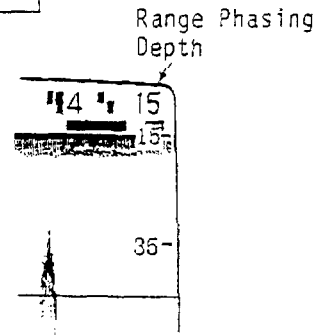

(How to move the window quickly between extreme points)



If you are presently using a small Basic Range and a large Phased Range setting to set the start of the display window and should you want to change the phasing back to zero, then you would find that this can be accomplished by holding down the  key continuously. The speed of change is slow at first but since it gradually increases you would get back to zero phasing quickly.

Reprogramming Basic Range



When the factory-set basic ranges are not suitable to your use, you may reprogram them as follows. Any basic range can be replaced with one picked up from table below.

	Meters	Feet	Fathoms	P/B		Meters	Feet	Fathoms	P/B
1	5	15	2	3	11	150	500	80	100
2	10	30	5	6	12	200	600	100	120
3	20	60	10	12	13	250	800	120	150
4	30	100	15	20	14	300	1000	150	200
5	40	120	20	25	15	400	1200	200	250
6	50	150	25	30	16	500	1500	250	300
7	60	200	30	40	17	600	2000	300	400
8	80	250	40	50	18	800	2500	400	500
9	100	300	50	60	19	1000	3000	500	600
10	120	400	60	80	20				

(Procedure)

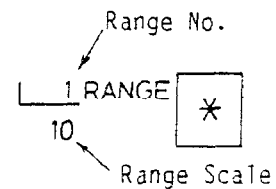
1. Select the secondary function of keys by pressing the  key.
2. Watching the setting information displayed next to the "RANGE", press the  key a few times until the range number you wish to reprogram is displayed.







3. Press the  or  key several times until the desired range scale is displayed below the range number you selected at step 2.
4. To reprogram other range numbers, repeat steps #2 and #3.

BOTTOM-LOCK EXPANSION RANGE SELECTION

The Bottom-lock expansion range can be selected among the six ranges shown below.

No.	M	FA	FT	P/B
1	2.5	10	1.2	2.5
2	5	20	2.5	5
3	10	40	5	10
4	20	80	10	20
5	40	160	20	40
6	80	300	40	80

(Procedure)



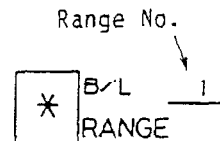

1. Select the secondary function of keys by pressing the  key.
2. Press the  key.
3. Press the  or  key until the desired range number is displayed next to the "B/L RANGE".



GAIN CONTROL

The gain control adjusts the sensitivity of the receiver. Normally, the gain is set to the point just below where excessive noise appears on the screen. As a general rule of thumb, use a higher gain setting for greater depths and a lower setting for shallower waters.

(Procedure)

1. Press the  key, and the present gain settings are displayed together with an asterisk at the left top on the screen. The gain can be adjusted for the frequency marked with the asterisk.
2. Press the  key to increase the gain and the  key to decrease it.
3. To adjust the gain of the other frequency, press the  key, and the asterisk will move.

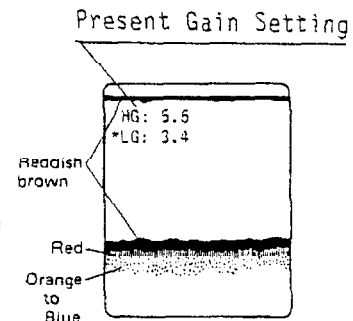

ADJUSTING TVG (TIME VARIED GAIN)

As the range between the transducer and target increases, the amount of power received from the target decreases because it is dissipated on the outward and return journey. To compensate for the propagation loss, the TVG

suppresses amplification of echoes at shallow depths and increases amplification as the depth increases.

In addition to compensating propagation loss, the TVG also helps eliminate surface noise which may mask shallow targets. The effective range extends to 50 meters. Set the TVG between 3 - 5 for normal fishing.

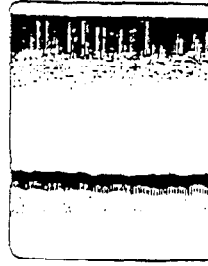

TVG "OFF"

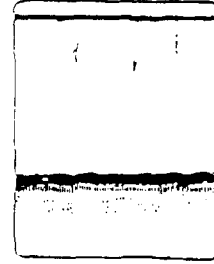

TVG "ON"

PICTURE ADVANCE SPEED SELECTION

Because the picture is built up one scan line at a time, from right to left across the screen, the amount of time you can observe the same echo is directly related to the picture advance speed.

There are five speeds available as tabulated below;

On-screen Indicator	"0"	"1"	"2"	"3"	"4"
Speed	Freeze	Slow	Medium	Fast	Fastest



where in the freeze position the display will remain frozen indefinitely.

When selecting an advance speed, keep in mind the following guidelines.

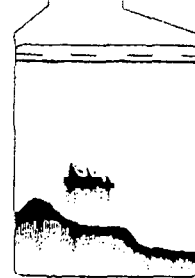
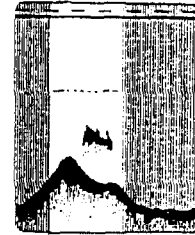
- 1) At faster advance speeds ("3" or more), care should be taken not to misjudge the size of the school; a fast advance speed will expand the size of the school horizontally across the screen.
- 2) A slower advance speed ("2" or less) however will contract the size of the fish school across the screen.



(Procedure)



1. Press the  key.
2. Press the  key to increase the speed and the  key to decrease it.

NOISE LIMITER

When interference from other echo sounders operating nearby or other types of electrical interference exist, you may use the Noise Limiter to eliminate or reduce the interference.

(Procedure)

1. Select the secondary function of the keys by pressing the  key.

2. Press the  key.
3. Press the  or  key. Every pressing changes the number of correlation between OFF and N3. Select N1 for normal use. N3 is the strongest level.



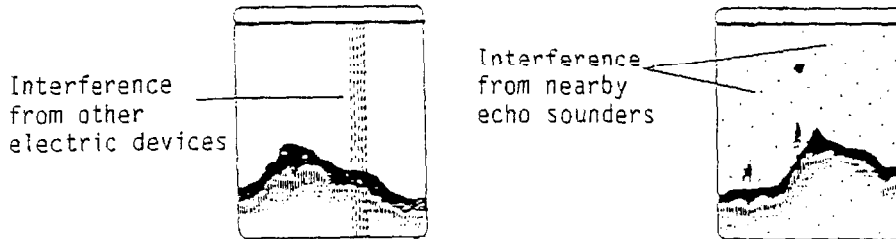

Note: If the Noise Limiter is left in N3 when no interference exists, weak echoes may be missed or eliminated.



CLUTTER

When blue dots appear on the whole screen, use the clutter function to eliminate them.

(Procedure)

1. Select the secondary function of the keys by pressing the  key.
2. Press the  key.
3. Press the  key to suppress blue dots on the screen. While the  key is pressed, numeric figure is displayed next to the "CLUTTER" increases. Normally set it between 3 and 5. Too high a setting causes weak echoes to be eliminated.
4. To turn off the clutter function, set the numeric figure to "0" by pressing the  key.

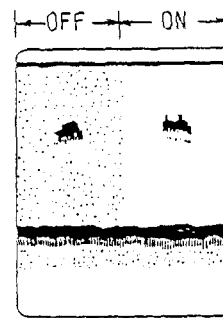

Clutter Setting



USEFUL FUNCTIONS

PICTURE RECORD/RECALL

The picture displayed on the screen can be stored in the memory and can be recalled at any time.



(Procedure)

Picture Record

1. Press the  key.
2. Press the  key. The picture stops advancing and is stored into the memory. Every time the key is depressed new picture is recorded, overwriting the stored picture.

3. To return to the normal picture, press any key.

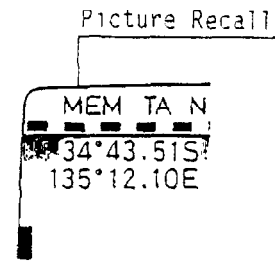

Picture Recall

1. Press the  key.
2. Press the  key. The recalled picture bears "MEM" indication at the top left corner.
3. To return to the normal picture, press any key.



TARGET DEPTH MEASUREMENT BY VRM

(Procedure)

1. Press the  key.
2. Press the  or  key.
The green Variable Range Marker line which runs horizontally across the screen moves up and down. The depth of the marker line is digitally indicated above the line.





ALARM





There are times when you will be preoccupied with other tasks and unable to concentrate on watching the picture. In such cases, it would be a good choice to use the alarm function. This function enables you to monitor echoes from fish schools and seabed through sound from the built-in speaker.

There are two types of alarm:

- 1) Fish alarm (FA) : Only fish echoes can trigger the alarm; the echoes which are plotted below the seabed contour are ignored.
- 2) Bottom alarm (BA): Only the seabed contour can trigger the alarm.

(Procedure)

- 1) Press the  key to select the type of the alarm; fish alarm or bottom alarm. The "FA" or "BA" will be indicated at the left top of the screen.
- 2) Preset the alarm zone with the , ,  and  keys.

Press of the  key followed by the  keys changes the width of the upper-alarm zone, which is indicated by a white bar as illustrated below, and the   keys set the lower alarm zone. When both the upper and lower alarm zone bars are extended through one another, the crossover section of the bars becomes white and upper and lower portions disappear as illustrated below. This is the Midwater Alarm Zone.

- 3) To turn off the alarm function, erase the "FA" or "TA" indication by pressing the  key.

FA: Fish Alarm
BA: Bottom Alarm

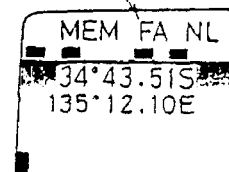

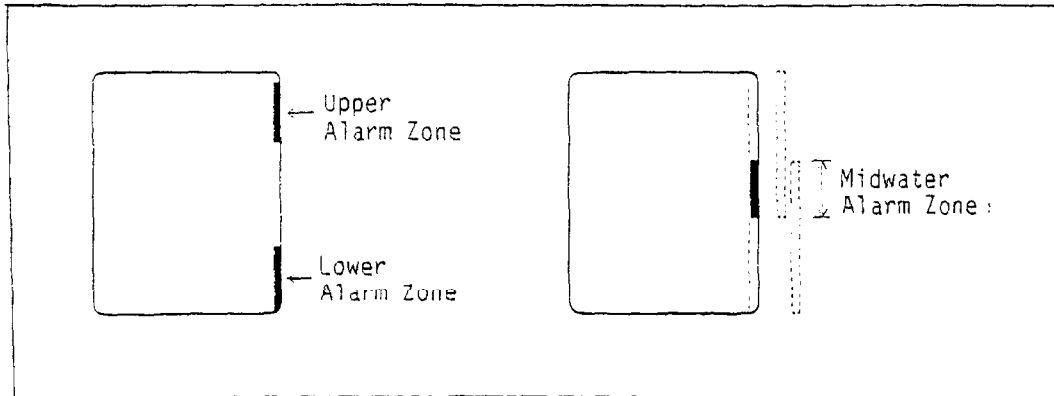

NOTE

- 1) An echo with a weak color can not trigger the alarm; the fish must be plotted in YELLOW or higher gradation color in the "FA" mode and the seabed must be RED or REDDISH BROWN in the "BA" mode.
- 2) An echo which is plotted within 1m from the zero line can not trigger the alarm.

Typical Applications

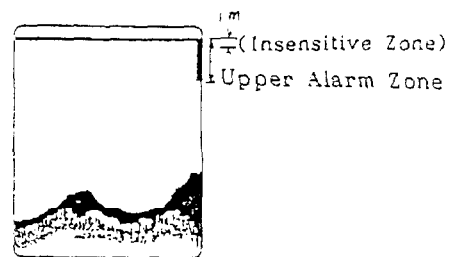

1) Bottom Alarm (Mode: "BA")

The Bottom Alarm can be thought of as a zone extending from the transducer down to a depth of water greater than the draft of the boat. In waters where the depth is known to dramatically and suddenly rise without warning, it may be a good idea to set the Bottom Alarm 5 (or even 10) meter below the boat's draft to warn of impending danger. For example if your boat has a draft of 3 meters you may want to set a lower limit of 5 meters below the transducer as an alarm zone.



Bottom Alarm

2) Fish Alarm for Bottom Fishing (Mode: "FA")

For bottom fishing, the alarm is set from the lower right-hand edge of the display upwards to a level set by the operator above the bottom. For example, if you are in 53 meters of water and your range setting is 0 to 60 meters, you might set the upper edge of the indicator bar at 43 meters. Now any fish that appears in the region between the bottom and 43 meters will sound the alarm. You would use the  and  keys to move the indicator bar.

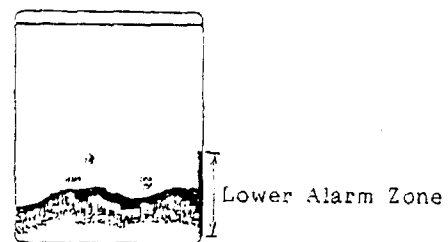

Bottom Fish Watch

3) Fish Alarm for Surface/Midwater Fishing (Mode: "FA")

For surface or midwater fishing, you want the Fish Alarm to sound should fish appear in an area somewhere between the transducer and the bottom. However, an alarm set all the way from the transducer downwards may cause a lot of false alarms because of surface turbulence. Thus you would probably want to set the top edge of the alarm zone to be below the surface turbulence seen on the screen.

Let's say that a particular species of fish you want to catch normally are found in the range between 30 and 60 meters, and the range shown on the screen is presently 0 to 120 meters. The key strokes, in this case are as illustrated below.

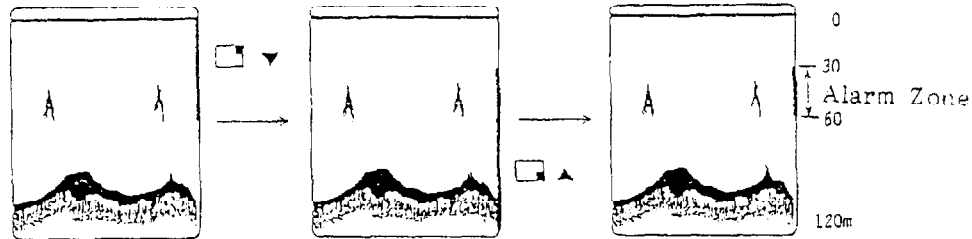

Surface/Midwater Fish Watch

AUTOMATIC BOTTOM TRACKING

The automatic bottom tracking function shifts the Basic Range window up and down automatically to track the seabed on the lower half of the screen.

The basic range window jumps up when the seabed trace rises up over the center of the normal picture, jumps down when it disappears from the lowest limit of the picture. The step of jumping is 1/4 of the basic range in use.

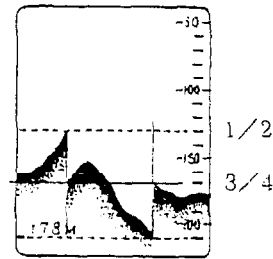

(Procedure)

1. Select the secondary function of the keys by pressing the **2ND** key.
2. Press the **ON/OFF** key. Every pressing turns on/off the automatic bottom tracking function.

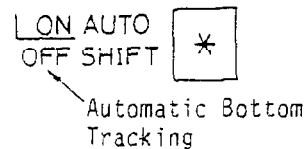

- NOTE 1. The "AUTO" indication appears at the top of the E/S page screen.
2. When the seabed return becomes weak, the AUTO function is disabled and the basic range scale keeps on shifting to search for seabed echoes. To continue AUTO mode, increase the GAIN for the stable reception of the seabed.
 3. The manual range phasing is disabled during the automatic bottom tracking.

TRANSMISSION RATE SELECTION

The transmission rate, i.e., recurrence rate of sounding pulses, can be changed in 11 steps as tabulated below;

Item Indicator	"0"	-----	"10"	S
TX Rate	lowest	-----	highest	AUTO



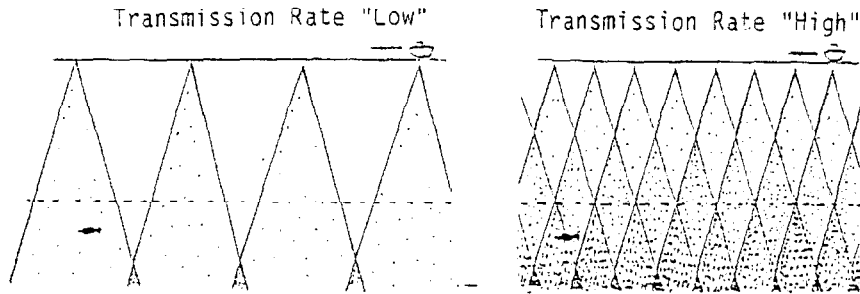

where "S" indicates that the transmission rate automatically changes in accordance with the ship's speed.

Usually the highest rate "10" is used since the higher the rate, the higher underwater information can be collected as shown below and it is advantageous to detect small fish.



You may however reduce the rate if the 2nd or 3rd seabed echo appears above the first echo and interferes with observation of wanted echoes.

(Procedure)

1. Select the secondary function of the keys by pressing the  key.
2. Press the  key.
3. Press the  key to increase the transmission rate and the  key to decrease it, while watching the figure displayed next to the "PULSE RATE".

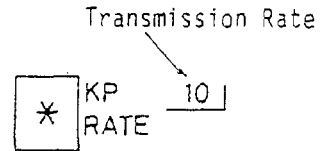

(Advantage of ship's speed dependent mode)

NOTE 1. For the ship's speed dependent mode, the ship's speed information must be fed from the optional sensor device or external navigation equipment.

As you may be aware of, a target is plotted wider horizontally when the ship's speed is low and tends to appear narrow when high because the time which the ship passes over the target differs. Thus you must always bear in mind the ship's speed when judging the size of a target (fish school) on the screen.

The solution for this inconvenience is the "S" (Ship's Speed Dependent) mode. Since the transmission rate and as a result the picture advance speed changes in proportion to the ship's speed, the horizontal scale of the picture is not influenced by the change of ship's speed and you can directly compare the sizes of fish schools with the echoes on the screen.

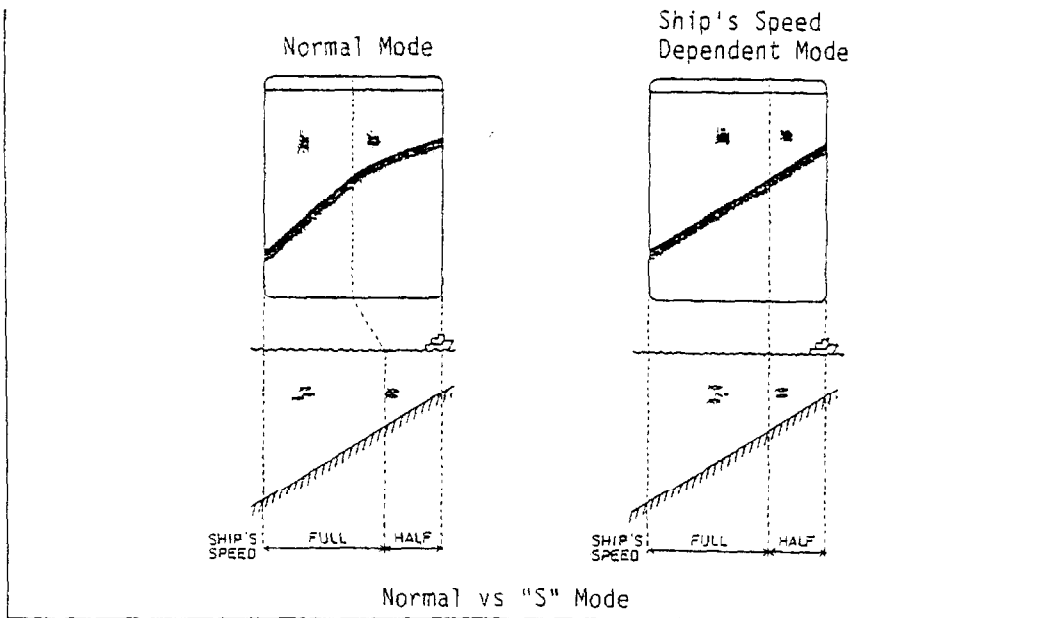

DISTANCE-TO-GO PRESET

When the optional speed/temperature sensor or position fixing equipment is connected to your FCV-552, the "Distance-to-go" can be displayed at the lower left corner of the screen by using the **MEM** key. See page 21. Since the "distance-to-go" decreases automatically as the ship moves, you may always read the up-to-date distance to the destination.

(Procedure)

1. Select the secondary function of the keys by pressing the **2ND** key.
2. Press the **MEM** key.
3. Preset the distance to the destination or waypoint by pressing the **▲** and **▼** keys. The preset value is displayed on the E/S page screen and will be counted down as the ship moves. Note that if the ship passes through the destination, the minus (-) mark is attached to the distance value and afterwards the value is counted up.

Distance-to-go
(can be set between
0.0 and 99.9)

***** DIST. TO GO 0.0

- NOTE: 1. Since the "distance-to-go" readout decreases so long as the boat moves regardless of the ship's heading direction, an error of distance run introduced if the ship takes the zig-zag course.
2. If "0.0" is set at step #3, it functions as the "distance-run indicator; the minus mark (-) is attached to the distance value and the mileage is counted up to -99.9 as the ship moves.

COLOR SELECTION FOR DAY AND NIGHTTIME OPERATIONS

On this color sounder, targets are painted in 7 colors (background in DEEP BLUE) in accordance with the echo strength.

However when the equipment is used in a bright environment, it is recommended to select the 6-color display (5 colors on BLUE background) because the bright background is easier to see.

Level	Strongest ←————→ No signal							
	7	6	5	4	3	2	1	0
Nighttime Mode	Reddish Brown	Red	Orange	Yellow	Green	Light Blue	Blue	Deep Blue
Daytime Mode	Red		Orange	Yellow	Green	Light Blue		Blue

(Procedure)

1. Select the secondary function of the keys by pressing the **[2ND]** keys.
2. Press the **[ES]** key. Every pressing of the key changes the color between the daytime and nighttime modes.

DEPTH UNIT SELECTION

The depth unit can be changed among meters(M), feet(FA), passi/braza(P/B).

(Procedure)

1. Select the secondary function of the keys by pressing the **[2ND]** key.
2. Press the **[GR]** key.
3. Press the **[▲]** or **[▼]** key to select the desired unit.
4. Turn off the set and then turn it on.

SELECTING SOURCE OF SPEED DATA

When the unit is connected to the speed/temperature sensor and/or the position fixing equipment, you can select the source of the speed data. (The speed data is used for the ship's speed dependent mode of the picture advance speed and the distance-to-go indication.)

(Procedure)

1. Select the secondary function of the keys by pressing the **[2ND]** key.
2. Press the **[VP]** key.
3. Press the **[VP]** key again until "INT" is displayed next to the NAV when the speed data from speed/temperature sensor is selected and "EXT" when that from the position fixing equipment. When "OFF" is selected, no speed data is input to the unit.
4. When "INT" is selected and there exists an error in speed indication, press the **[▲]** or **[▼]** key to compensate the display. The range of compensation is within +10%.



EX. Ship's speed: 10 knots } Set "-10%" for compensation.
 Indication: 11 knots }

NOTE: When "OFF" is selected, entry of the ship's position and the temperature data are disabled and therefore they are not displayed on the screen.

TURNING-OFF DEPTH SCALE

The depth scale can be turned off with the  key.



(Procedure)

1. Select the secondary function of the keys by pressing the  key.
2. Press the  key. Every pressing of the key turns on and off the depth scale.

TEMPERATURE UNIT SELECTION

The unit of the water temperature indication can be changed between Centigrade and Fahrenheit.

(Procedure)

1. Select the secondary function of the keys by pressing the  key.
2. Press the  key. Every pressing of the key changes the unit between Centigrade and Fahrenheit.

INDICATORS

The following illustration shows all the various indicators that show up on the ES picture page. As most of the indicators have been explained in connection with the keying operations, explanation is given to only a few items.

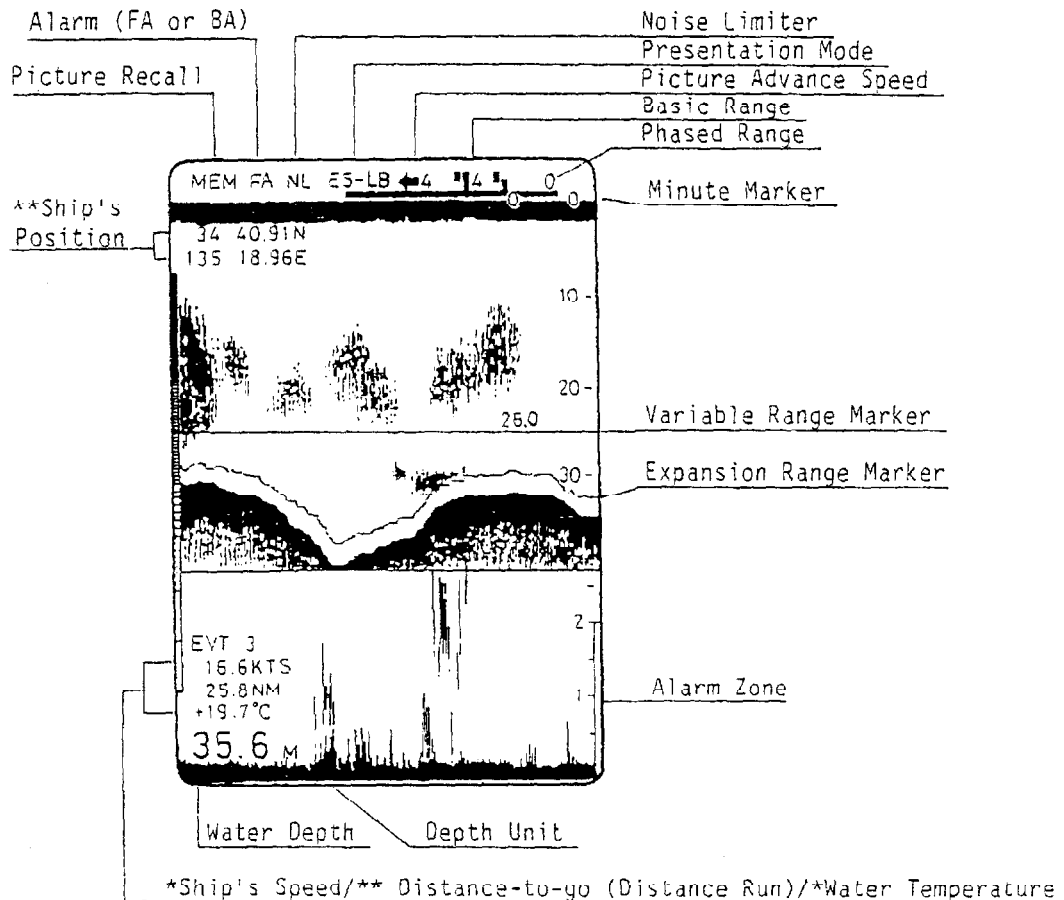

- * Optional speed/temperature sensor or position fixing equipment required.
- ** Position fixing equipment required. (Readout is not provided while the CYC or SNR lamp of the connected Ioran navigator is on.)

















- Color Bar : Gives reference of color gradation; reddish to bluish color for strongest to weakest echo return.
- Minute Marker: One complete minute is shown with a 30 sec. horizontal bar and 30 sec. blank space. By observing the number of minute marks on the screen, you can determine the amount of history being displayed on the screen.
- Water Depth : This indicator shows the depth from the transducer to the seabed. The unit is capable of reading depths beginning from 1m below the transducer. This minimum depth is necessary to prevent locking onto the surface turbulence rather than the bottom. In order to obtain depth readout, the bottom must be displayed on the screen. Correct depth readout is displayed even when the picture advance rate is set to "0."

6. GR PAGE OPERATION

This chapter focuses on the operations of the GR (Graph) page, which is obtained by pressing the  key.

OPERATION

Most of the key operations on this page are the same as shown on the ES page and reference pages are shown in the table below.

Name	Refer to page
Adjusting Brilliance ( control)	7
Normal Picture Range Selection ( and  keys)	9
Gain Control ( key)	11
Adjusting TVG ( key)	11
Noise Limiter ( key)	12
Clutter ( key)	13
Picture Record/Recall ( key)	13
Target Depth Measurement by VRM ( KEY)	14
Automatic Bottom Tracking ( key)	16
Transmission Rate Selection ( key)	17
Distance-to-go Preset ( key)	18
Color Selection for Day and Nighttime Operations ( key)	18
Selecting Source of Speed Data ( key)	19
Depth Unit Selection ( key)	19
Turning-off Depth Scale ( key)	20

The following describes the operations which are not used in the ES page operations.



SELECTING PICTURE ADVANCE SPEED

Unlike the picture advance speed of the ES page, the picture advance speed on the GR page is set in minutes or hours which shows the time an echo moves from the left edge to the right edge of the screen, in other words, amount of history being displayed on the screen.

Since the speed can be set extremely slow, 2 hours at maximum, a long history of picture is presented on the screen and recognition of seabed shape becomes easier. Similarly, from the historical temperature graph on the lower part of the screen a current rip, which usually causes sudden change of water temperature, can be found.

(Procedure)

1. Press the  key.

- Press the  or  key to select the picture advance speed. The speed can be selected among 15 minutes, 30 minutes, 1 hour and 2 hours, and the selected speed is displayed at the top of the screen.

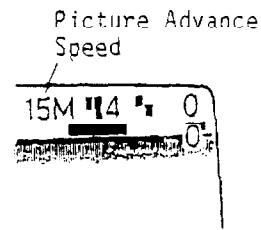







WATER TEMPERATURE ALARM SETTING

All fish species have their respective habitable water temperature ranges and if the temperature is far out of the ranges you can hardly expect a good catch.

The water temperature alarm function warns you by audible sound that you are within or out of the desired temperature ranges.

(Procedure)

Out-of-Range Alarm



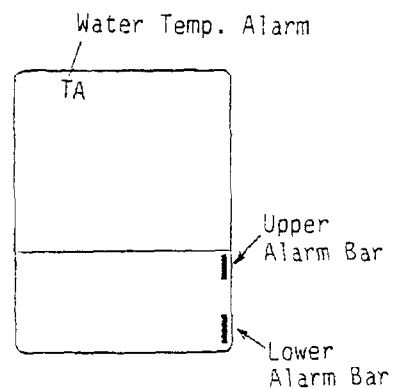

- Press the  key. The "TA" indication will appear at the top of the screen.
- Press the  key and then the  key until the upper alarm bar which extends from the top of the temperature screen as illustrated at right reaches the upper limit of the desired temperature range. If you overshoot the range desired, use the  key to correct it.
- Press the  key and then the  key until the upper alarm bar extends to the lower limit of the desired temperature range.



Whenever the water temperature goes out of the desired temperature range, the background color of the "TA" indication changes to white and the alarm is released.

- To turn off the Alarm function, press the  key.

In-Range-Alarm

- Press the  key.
- Press the  key and then the  key until the upper alarm bar extends to the lower limit of the desired temperature range.
- Press the  key and then the  key until the lower alarm bar extends through the upper alarm bar and reaches the upper limit of the desired temperature range.

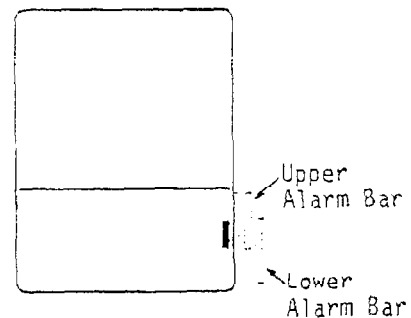

The crossover section of the bars becomes white. This is the in-range alarm zone and the alarm is released when the water temperature goes into this range.

- To turn off the alarm function, press the  key.



NOTE: The ES page alarm (fish alarm/bottom alarm) and the GR page alarm (water temperature alarm) can be used simultaneously, that is, even while the GR page is displayed, the fish or bottom alarm of the ES page is functioning. To distinguish which alarm is releasing the sound, the background of the "TA" or "FA"/"BA" indication on the top left of the screen becomes white while the sound is being released.

PLOTTING AND RECALLING EVENT MARK

When you wish to temporarily store the data of a certain point, use the event mark function. The latitude/longitude, depth temperature and time can be stored for 16 points and recalled later.



(Procedure)

Plotting an Event Mark

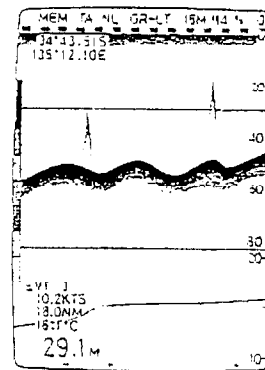
1. Press the  key.
2. Press the  key. The orange event mark "+" is plotted at the bottom left of the screen, and the data at that point is stored in the memory.
Note that only the latest event mark is orange and all other marks which have been plotted in the past are green.



Recalling an Event Mark

1. Press the  key.
2. Press the  key repeatedly until the color of the event mark whose data you wish to recall changes to orange, and the data of that event mark is displayed on the VP page. See page 28.

- NOTE:
- 1) It is not compulsory to plot the event mark from the GR page. It can be plotted from E/S and VP pages too by using the procedure mentioned above.
 - 2) The event marks and their data are not stored in the backup memory. The important ones should be noted down before turning off the power.

INDICATORS

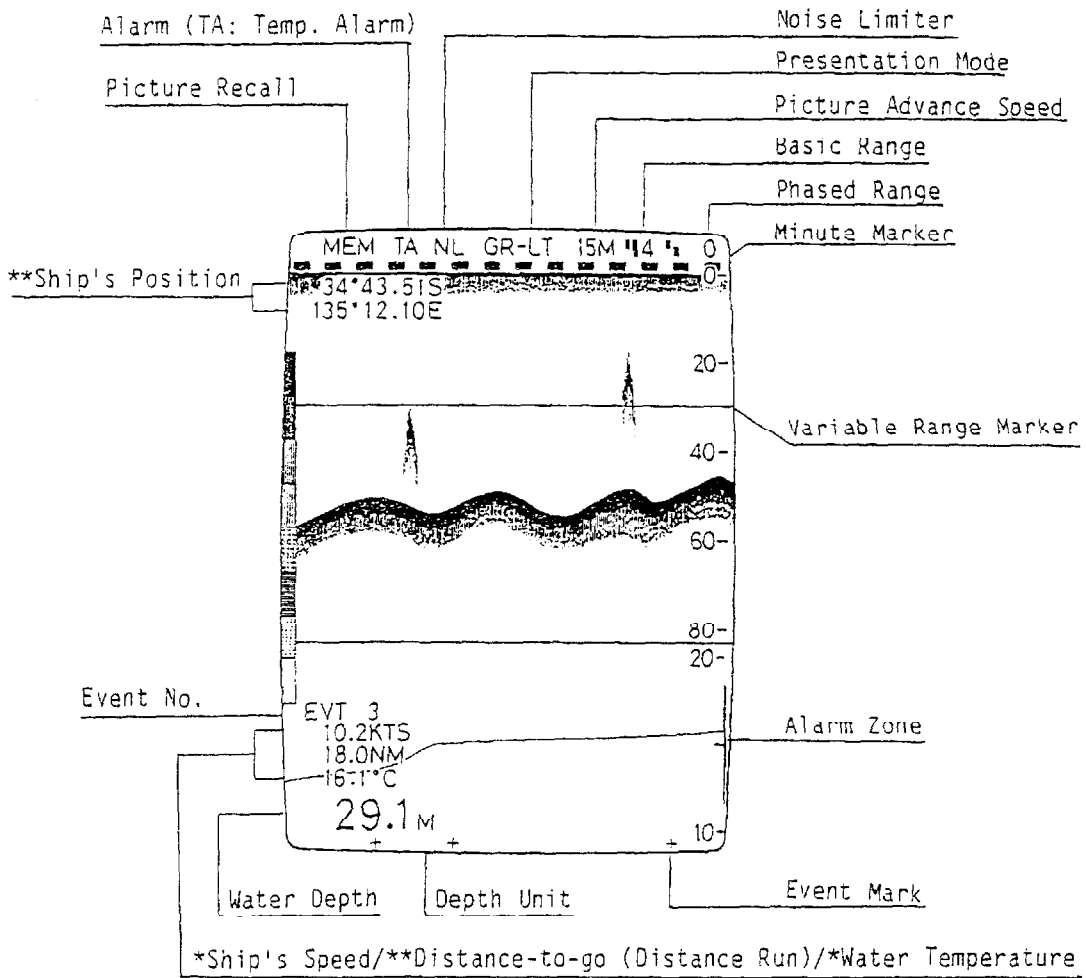

- * Optional speed/temperature sensor or position fixing equipment required.
- ** Position fixing equipment required. (Readout is not provided while the CYC or SNR lamp of the connected loran navigator is on.)

Water Temperature: The display range is from -5° to +30°. The temperature scale automatically changes in 5° or 10° steps when the temperature reaches upper/lower limit of the displayed scale.

7. VP PAGE OPERATION

This chapter describes operations of the VP (Video Plotter) page, which is obtained by pressing the **VP** key. Note that you can use this page only when your FCV-552 is connected to a position fixing equipment.

Note: The VP page does not operate while the CYC or SNR lamp of the connected loran navigator is on.

OPERATION

SELECTING RANGE SCALE

The ship's course line is plotted on a square area (called a "chart") on the screen as shown on page 28. The range scale selected determines how many miles each side of the square chart corresponds to. Five scales are available: 1, 2, 5, 10, 20 and 30 miles, and one of them is selected as follows.

Note: Ship's position data from loran or sat-nav is plotted directly on the video RAM and not stored in the form of latitude and longitude. Thus all past course line is erased if the range scale is changed.

(Procedure)

1. Press the **RT** key.
2. Press the **▲** or **▼** key until the desired scale is selected.

PLOTTING AND RECALLING EVENT MARK

Plot and recall of the event mark on the VP page is performed in the same manner as is done on the GR page.

(Procedure)

Plotting Event Mark

1. Press the **EVT** key.
2. Press the **▼** key. The orange event mark "+" is plotted at the own ship's position on the chart, and the data (lat./long. or loran LOP, depth temperature, etc.) for that point is displayed at the lower part of the screen.

Recalling Event Mark

1. Press the **EVT** key.
2. Press the **▲** key a few times until the color of the event mark whose data you wish to recall changes to orange. The data for that point is displayed at the lower part of the screen together with those for two other event marks entered immediately before that.

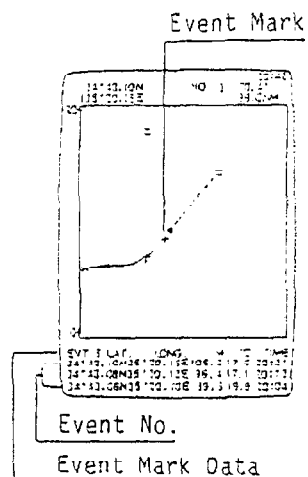

NOTE: 1. The event mark entered on the VP page is automatically plotted on the VP page.

2. Refer to page 44 for selection of lat./long. or loran LOP.

COLOR SELECTION FOR DAY AND NIGHTTIME OPERATION

Refer to page 18.

DEPTH UNIT SELECTION

Refer to page 19.

SELECTING SOURCE OF SPEED DATA

Refer to page 19.

INDICATORS

An example of the VP page picture is shown below. This section describes how to interpret it.

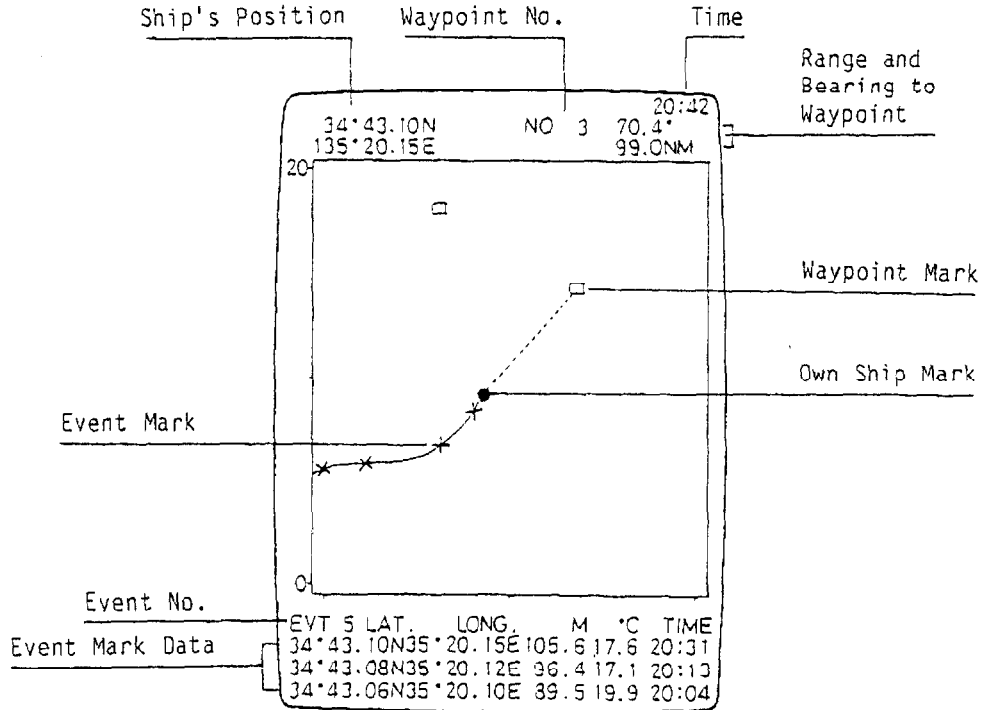

The chart is drawn in the North-up orientation.

Marks

- 1) Own Ship Mark : Plotted with a white circle.
- 2) Waypoint Mark : The "To" waypoint entered in the position fixing equipment is plotted; the present waypoint in red and the past one in yellow. The broken line connects the present waypoint and the own ship mark when the distance between the two marks is less than twice the range scale of the chart, i.e., the broken line is drawn even if the waypoint is located outside the displayed chart if the distance is less than twice the range scale.
- 3) Event Mark : Plotted on the course line as described on page 26.

Data

- 4) Ship's Position: Latitude and longitude of ship position.
- 5) Time : Present time or time elapsed after turning on the position fixing equipment. When the position fixing equipment is not connected, time elapsed after turning on the FCV-552 is displayed. In the latter case, the time data bears an asterisk (*).

- 6) Waypoint No. : "To" waypoint number entered in the position fixing equipment.
- 7) Range and Bearing to Waypoint : Range and bearing to "To" waypoint
- 8) Event Mark Data: Event number for the event mark which is shown in orange on the chart is displayed at the top left corner and its data just below the number. The lower two data are for the two older event marks. The data comprises, from the left, latitude/longitude (or loran LOP), water temperature and the time the event mark was plotted.

Note:

1. Hundred digit of the longitude is not displayed. Take care not to misread the indication.
2. How the waypoint number is displayed is different with respect to the connected position fixing equipment.

(How the chart is shifted)

When the ship mark reaches a side of the chart being displayed, the chart is automatically shifted by a half of the range scale of the chart. Let's suppose that the ship started moving from point "S" when the chart shown in the solid lines was displayed, and finally reached point "D." In this case, the chart is shifted three times.

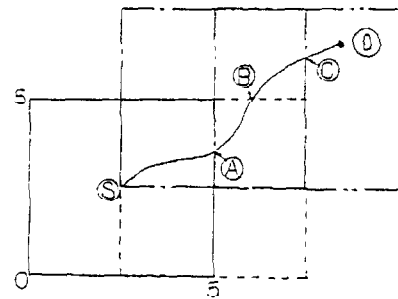

First at point "A" when the ship reached the right edge of the solid line chart, the chart is shifted along the x-axis and comes to the area shown in a dotted line. Second at point "B", it is shifted along the Y-axis and comes to the area shown in one-dash broken lines. Third at point "C," the chart is shifted along the X-axis again.

8. INTERPRETING THE DISPLAY

Using some typical examples, this section describes how to interpret the echogram on the screen.

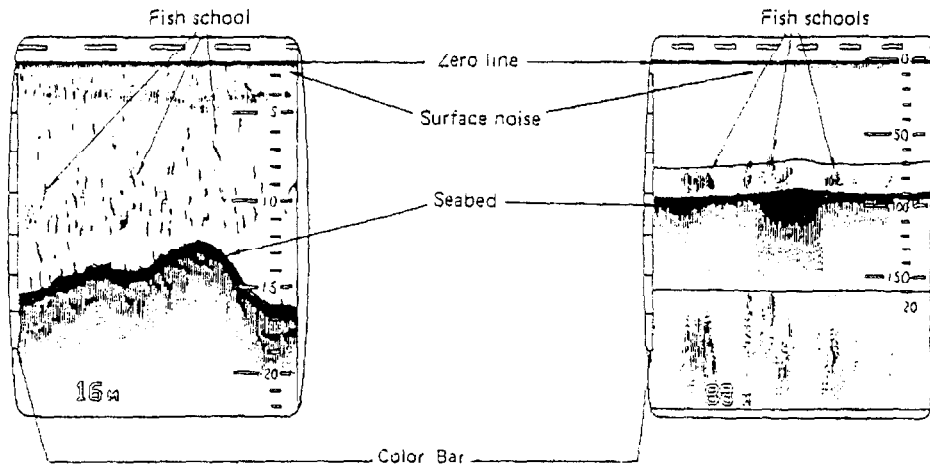

COLOR BAR

The color bar shows the relation between the echo intensity and the echo color on the screen. The top color (reddish brown) is used for the strongest echo and the lower colors for the weaker echoes. It can be used as a reference to estimate a density of fish school, fish species and hardness of seabed from the picture.

The number of color can be changed from 8 to 6 with the 2nd function of the  key.

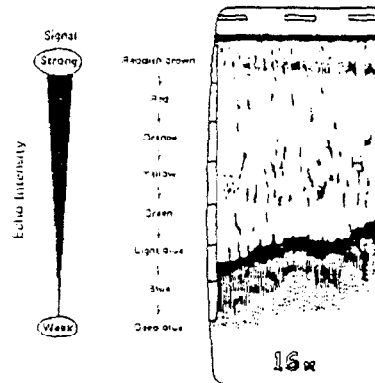

ZERO LINE

The zero line represents the transducer's position, and moves off the screen when a phased range is used.



SEABED

Echoes from the seabed are normally strong and displayed in reddish brown or red, but colors and width will vary with bottom material, water depth, frequency, pulselength, and sensitivity.

BOTTOM PROFILE

A hard and rough seabed appears with a longer tail because it reflects more of the ultrasonic pulse. Because of their stronger return, shallow seabed echoes appear wider than deep ones even when all bottom conditions are equal. Also, a longer seabed tail appears on slopes because of the difference in travelling time at both edges of the beam angle.

In the rugged bottom, echoes are reflected on many different planes, overlapping to present a three-dimensional effect.

BOTTOM NATURE

The nature of seabed is known from the intensity and length of the seabed tail. Generally, when observing the seabed nature, lower sounding frequency is used, the pulselength is set to long and the gain setting is kept unchanged.

In the hard and craggy bottom, the seabed appears in reddish brown with a long tail.

In the muddy or sandy bottom, the echoes appear less reddish and with a short tail. However, the bottom with sediment may give a long tail if a low frequency sounding is used.

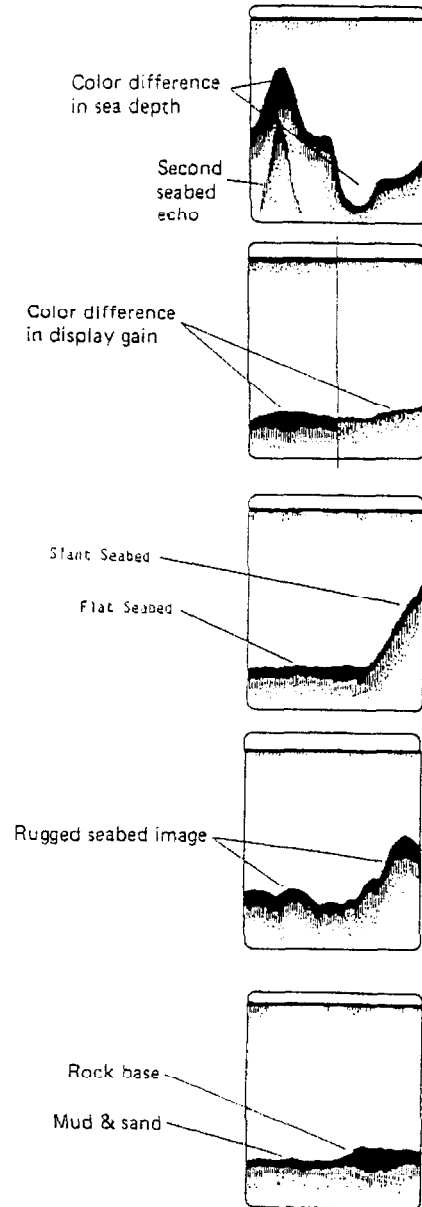

FISH SCHOOLS

FISH QUANTITY

The fish quantity can be estimated to a certain extent from fish echoes on the screen if the following two basic characteristics are kept in mind.

Size of Fish School

Usually the size of fish echoes on the screen is proportional to the actual size of fish school. However if two fish echoes appear at different depths with the same size, the fish school at shallower depth is larger because the ultrasonic beam widens as it propagates and fish school in deep water is displayed larger.

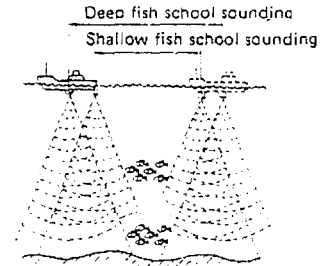
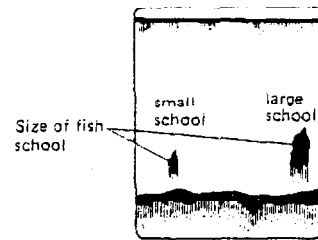

Density of Fish School

If two fish schools appear with the same color at different depths, the one at a deeper water is denser because the ultrasonic wave attenuates as it propagates and the fish school in deep water tends to be displayed in a weaker color,

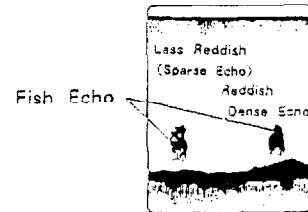

BOTTOM FISH

Bottom fish can be easily distinguished from the seabed because both are displayed in different colors. Thus, a white line is not required as it is with a recording paper echo sounder.

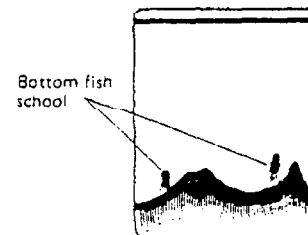

PLANKTON/CURRENT RIP

Plankton

A plankton layer, a likely place to find fish, is displayed in green or blue dots. It usually descends in the day and rises at night.

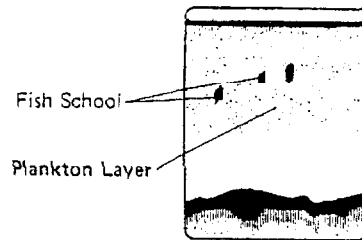

Current Rip

If two ocean currents meet with different speeds, directions and water temperatures, a current rip is developed. Since plankton and air bubbles collect there, it is displayed as shown at right.

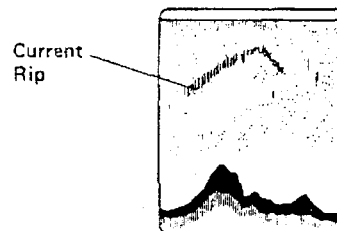

SURFACE NOISE

When the sea is rough or the ship passes over a wake surface noise may appear. Adjust the TVG or CLUTTER to clear surface clutter.

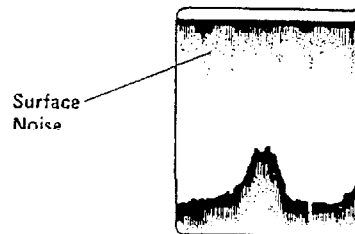

AERATION

Interference (from ship vibration, engine noise, electric equipment, other echo sounders, sonar etc.) may sometimes appear on the screen. Most interference can be rejected by the Noise Limiter. See page 12. Interference appearing at the same interval or near the transmission keying rate may not be rejected.

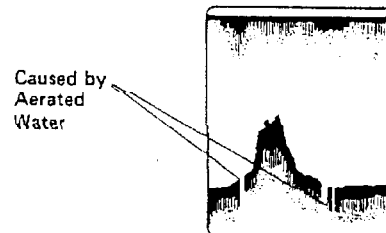

ZIG-ZAG BOTTOM

The bottom contour zig-zags when the ship rolls and pitches heavily because the sounding direction fluctuates and the distance to the seabed varies.

Zig-zag seabed image

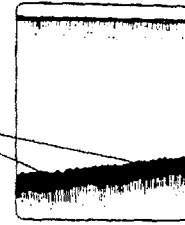

FALSE IMAGE

The following false echoes are detected by the sidelobe of the ultrasonic wave:

- * above seabed contour at steep rising
- * below seabed contour in shallow water

False image



Main lobe

Side lobe

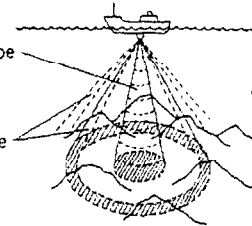

INTERFERENCE

Interference (from ship vibration, engine noise, electric equipment, other echo sounders, sonar etc.) may sometimes appear on the screen. Most interference can be rejected by the Interference rejector. See page 13. Interference appearing at the same interval or near the transmission keying rate may not be rejected.

Interference from nearby echo sounders

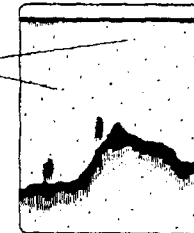

Interference from other electric devices

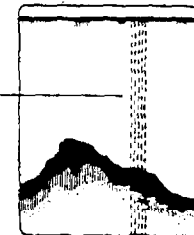

9. IF SOMETHING SHOULD GO WRONG WITH YOUR UNIT

If the unit does not operate properly, perform the following Operation Check to determine whether your unit is really defective. If there is a problem, proceed to the System Diagnosis section (p.38), and report the results at service call.

OPERATION CHECK

No Echo Presentation, But Scale Shows

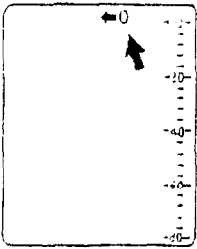

* Is the PICTURE ADVANCE SPEED anywhere but "0" (freeze)?

No Zero Line

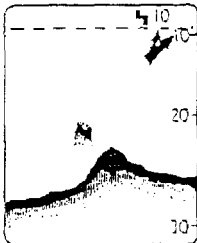

* Is the PHASED RANGE reading "0"?

Low Sensitivity

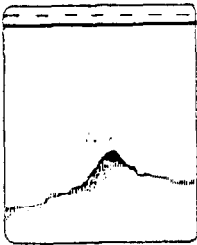

Are the GAIN and CLI (clutter) keys and TVG control properly set?

Multiple Seabed Traces

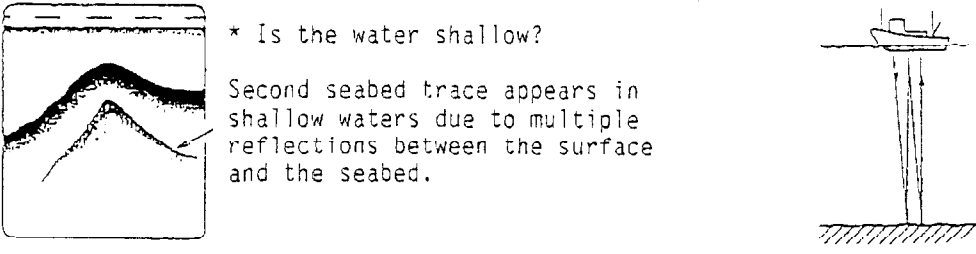

* Is the water shallow?

Second seabed trace appears in shallow waters due to multiple reflections between the surface and the seabed.

Zigzagged Seabed Trace/Occasional Loss of Echo Plotting

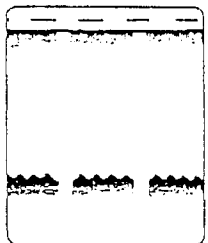

* Is the sea rough?

Zigzagged seabed trace is plotted when the boat pitches and rolls.

When the boat passes through aerated water, propagation of sound wave is blocked, causing loss of echo plotting. This often occurs when the boat goes astern, or when crossing a wake.

No Water Depth Readout/Bottom-lock Inoperative

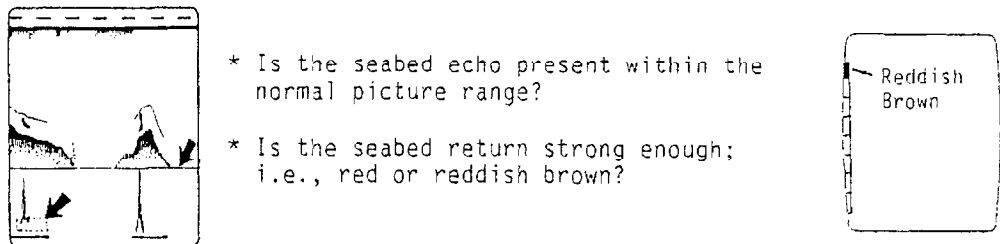

* Is the seabed echo present within the normal picture range?

* Is the seabed return strong enough; i.e., red or reddish brown?

Reddish Brown

Automatic Bottom Tracking Inoperative

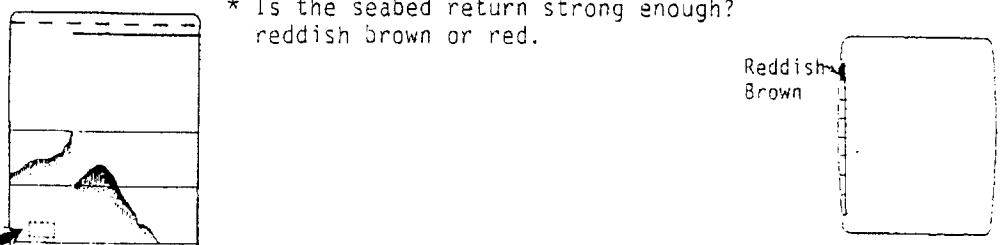

* Is the seabed return strong enough? reddish brown or red.

Reddish Brown

Picture Distorted

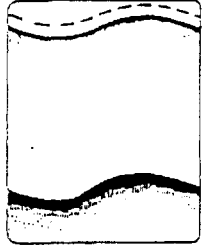

- * Is a magnetic field generator (heavy duty transformer, rectifier, etc.) nearby?

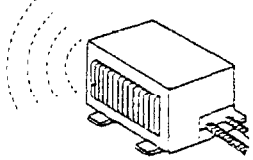

Different Color Picture or Marker



- * Is the BRILLIANCE control set properly?
- * Confirm the display color for day or night operation is properly set.

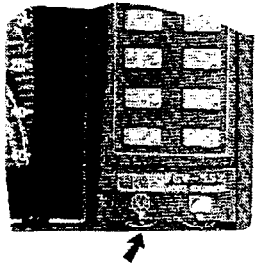

Color Impurity in a Particular Area

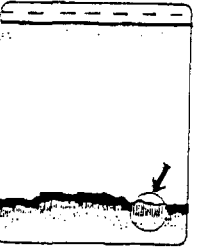

- * Did you approach the screen with a magnetic field generator?
- * Turn the POWER switch off and on for degaussing. If not completely cleared, call for repair.

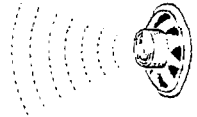

Occasional Disturbance and Random Noise

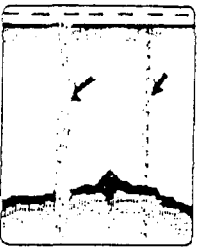

- * Are the connection cables laid near equipment or cables that generate noise? If so, separate them.

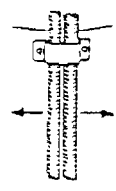

Heavy Noise and Interference



- * Is the GAIN key set properly?
- * Is the equipment properly grounded with a copper wire?
- * If this occurs only when vessel is moving, has transducer been faired-in properly?

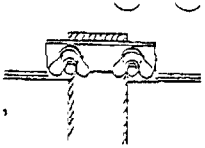

SYSTEM DIAGNOSIS

Your unit is provided with the self-check facilities which may be initiated by the following operation:

- (1) Turn off the power pressing the PWR and OFF keys at the same time.
- (2) Press the PWR key again while pressing any key on the control panel until something appears on the screen.

In a few seconds, the self-check page is displayed on the screen as follows.

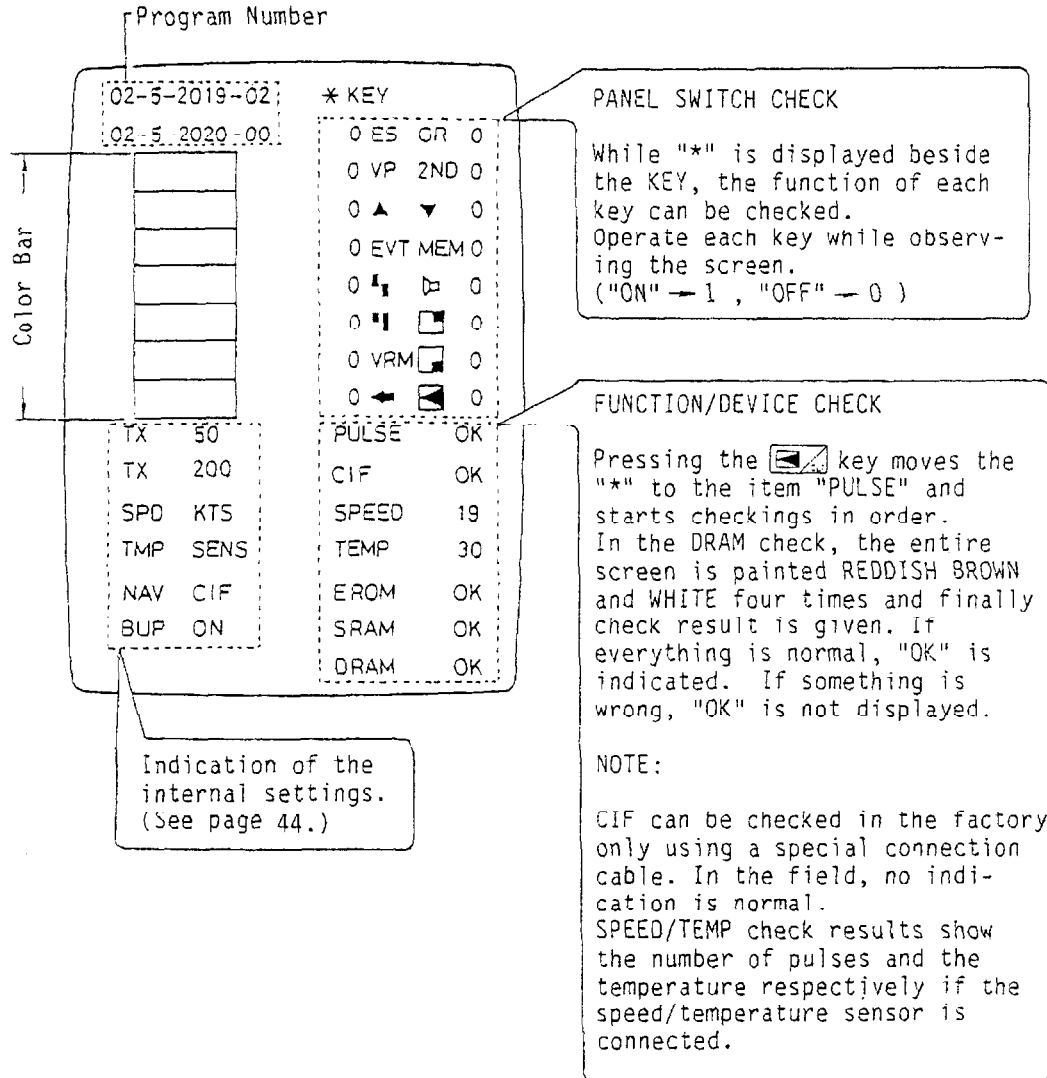

- (3) To terminate the system diagnosis, turn off the power pressing the PWR and OFF keys at the same time.

10. INSTALLATION

DISPLAY UNIT

Install the display unit at a place,

- . at least one meter away from the magnetic field generating device.
- . not exposed to the direct sunlight and water splash.
- . free from electric noise and interference.
- . away from radiotelephone and its feeder cable.

Allow service/ventilation space indicated below.

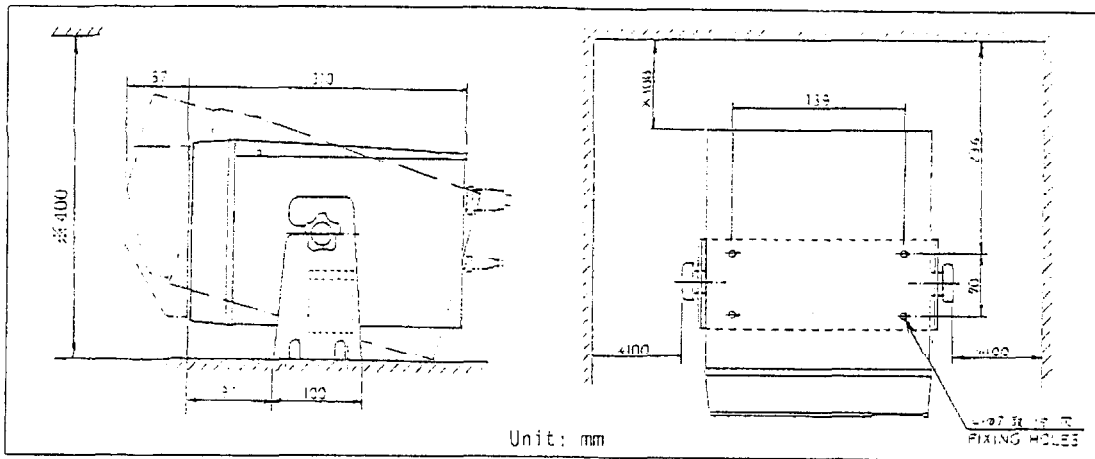

Mounting Procedure

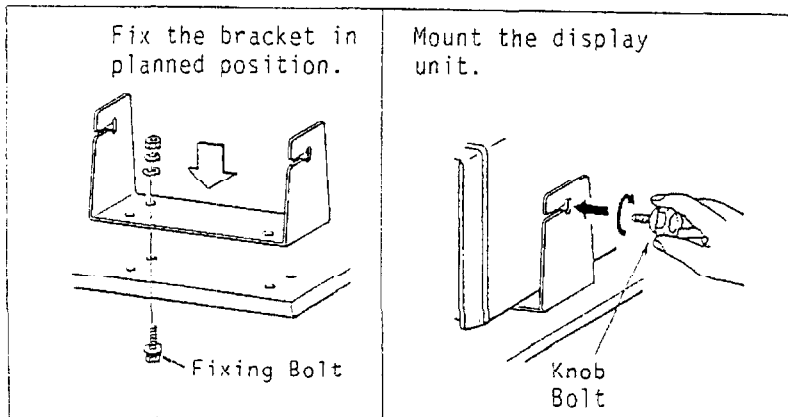

NOTE: OVERHEAD MOUNTING ALLOWED, BUT NO BULKHEAD MOUNTING.

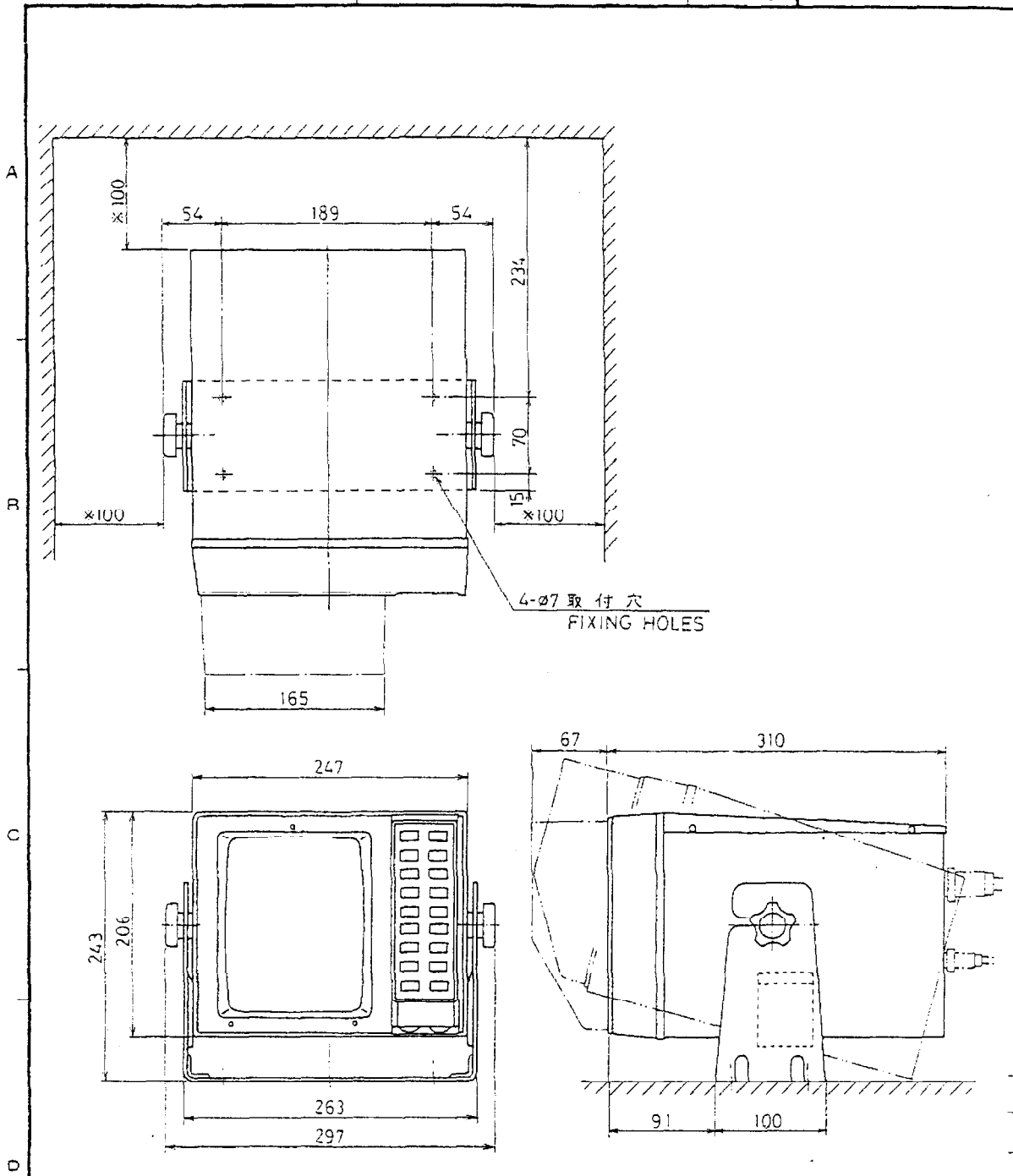

※ 保守用スペース
SERVICE SPACE

承認 APPROVED	品番 ITEM	品名 NAME	材質 MATERIAL	数量 QTY	図番 DWG. NO.	概要 REMARKS
MAY. 15. '97 T. NAKANO		三角法 THIRD ANGLE PROJECTION				
検図 CHECKED	MAY. 13. '97 T. NAKANO	尺度 SCALE				名称 TITLE FCV-550 指示器 /551 DISPLAY UNIT /552
製図 DRAWN	MAY. 13. '97 H. USHIO	重量 WEIGHT		8 kg	図番 DWG. NO.	C2309-002-A

TRANSDUCER

The performance of the color video sounder depends greatly upon the transducer position. A place least affected by AIR BUBBLES should be selected since turbulence blocks sounding capability. Also select a place least influenced by ENGINE NOISE. The following figures show typical transducer installation site, examples of transducer mounting.

It is known that bubbles are at a minimum at the place where the first bow wave falls and the next wave rises at general cruising speed. In small slow-speed boats, the following position is usually a good place.

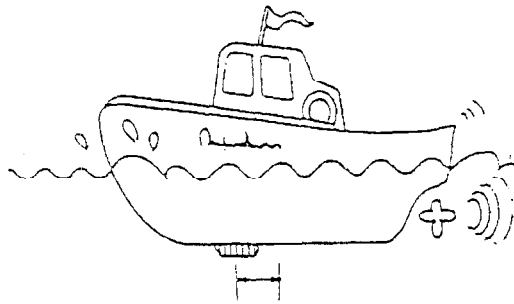

1/2 thru 1/3 of ship's length from bow

For high speed boats, select a place where the transducer is always in contact with the water.

The transducer can also be installed on the sideboard using a pipe and clamps, but note that the boat has to be small in size and its speed slow.

NOTE: The face of the transducer must be parallel with the sea bottom in the normal cruising trim of the boat.

Examples of Transducer Installations

HULL BOTTOM MOUNT

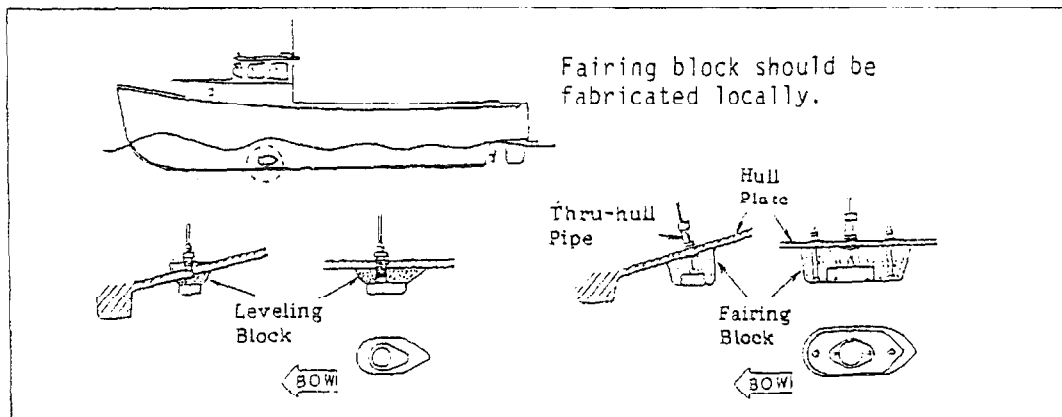

SIDEBOARD MOUNT

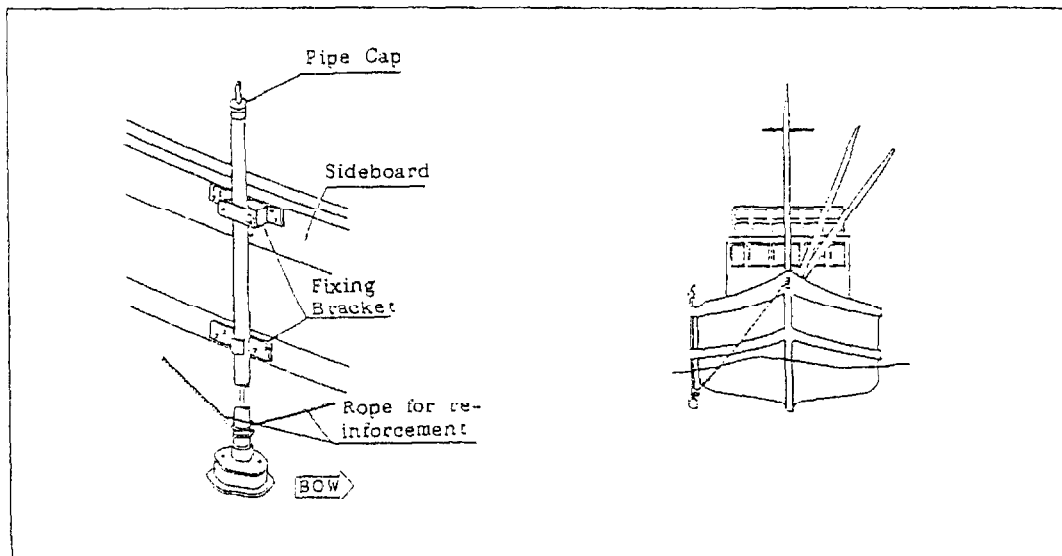

TRANSOM MOUNT

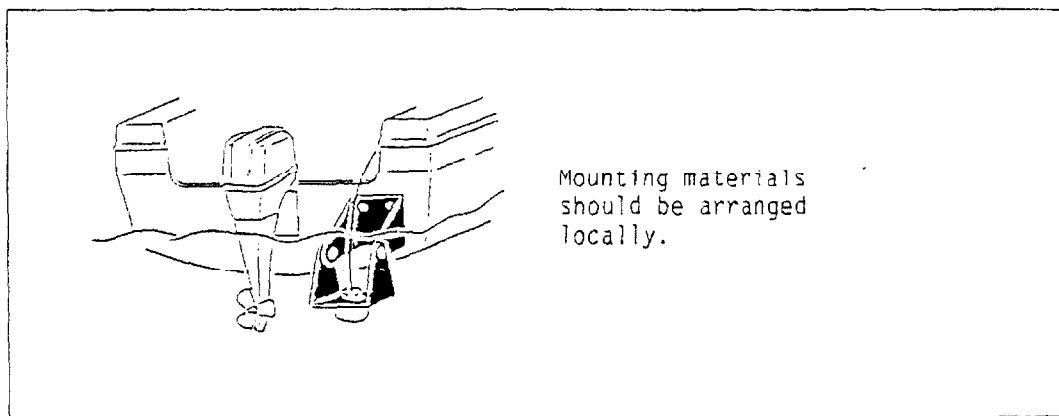

FCV-552 CABLING DIAGRAM

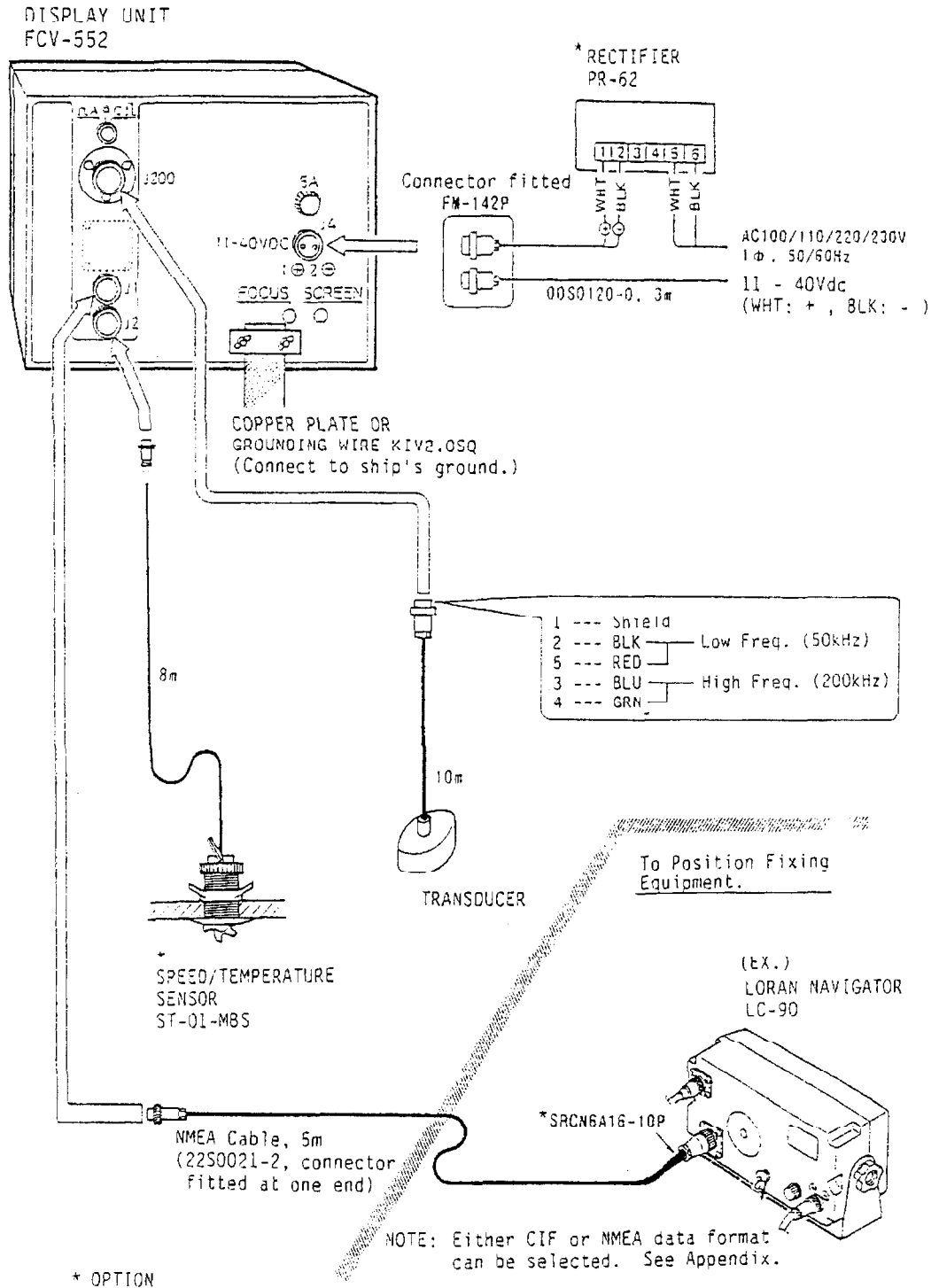

11. HOW TO CHANGE INTERNAL SETTINGS

It is necessary to change/confirm the internal settings at installation according to user's preferences, combined navigational equipment/optional sensor etc.

* Change of the internal settings is required;

- 1) when taking the ship's position data in NMEA data format.
- 2) when taking the temperature data from a navigational equipment.
- 3) when changing the display specification.

* Procedures

- 1) Turn off the power pressing the PWR and OFF keys at the same time.
- 2) Remove the cabinet cover.
- 3) Change the settings of DIP switch S1 referring to the figure/table below.
- 4) The settings of #1 and #2 can be confirmed on the screen selecting the GR or VP display mode.
- 5) The settings of #3 to #6 can be confirmed by the system diagnosis.

[DIP switch S1 setting on MIN PC Board O2P6003]

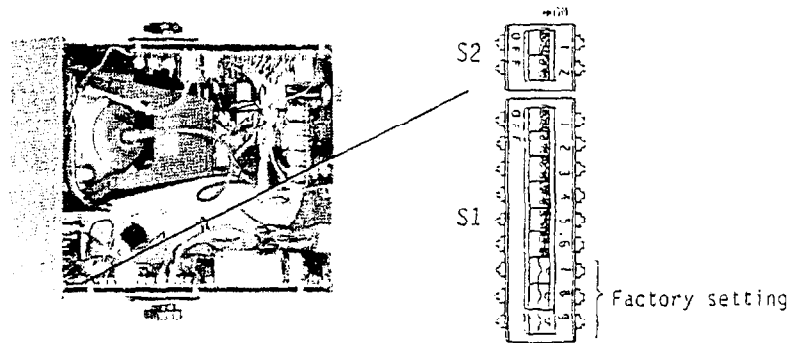

	No.	Items	Setting	
			ON	OFF
SI	1	Temperature Range (TMP RNG)	10°C	5°C
	2	Position Data (LOP)	L/L	LOP
	3	Memory Back up (BUP)	ON	OFF
	4	Data Format (NAV)	CIF	NMEA
	5	Temperature (TMP)	SENS	NAV
	6	Speed Unit (SPD)	KTS	MPH
	7	* Factory Setting		
	8			
	9			

No.	Item	Setting						
S2	1	Brilliance of	OFF	Dark	OFF	Mid.	ON	Bright
	2	Background	OFF		ON		ON	

- NOTE: 1.  shows the standard setting in factory.
2. When sending the MIN PC board 02P6003 for repair, set the memory back up setting (#3 of S1) to "OFF".

12. SPECIFICATIONS OF FCV-552 SOUNDER

1. Basic Display Range

Each basic range listed below can be phased in 1m (Ft, Fa, P/B) steps upto 500m (Ft, Fa, P/B) and 10m (Ft, Fa, P/B) steps upto 1000m (3000Ft, 500Fa, 600P/B).

Range No.	1	2	3	4	5	6
Meters	10	20	40	80	160	300
Feet	30	60	120	250	500	1000
Fathoms	5	10	20	40	80	160
P/B	6	12	25	50	100	200

P: Passi B: Braza

Basic range scale (unit and value) can be changed with the front panel keys on user's demand.

2. Bottom-Lock Range

Range No.	1	2	3	4	5	6
Meters	2.5	5	10	20	40	80
Feet	10	20	40	80	160	300
Fathoms	1.2	2.5	5	10	20	40
P/B	2.5	5	10	20	40	80

4. Automatic Bottom Tracking

Bottom tracking feature automatically phases the range so that the bottom is always displayed on the lower portion of the basic range.

5. Display

8" rectangular color CRT. Echoes are displayed in 6 (for daytime use) or 8 (for nighttime use) colors on the front panel key.

6. Presentation Mode

ES (Echo sounder) Mode

"H" or "L" : Normal (High or Low Frequency)

"HB" or "LB": Normal (High or Low Frequency, 2/3) & Bottom-Lock Expansion (1/3)

"LH" : Normal (High and Low Frequencies, each 1/2)

"MX" : Mixed (High and Low Frequencies)

GR (Graph) Mode

"H" or "L" : Normal (High or Low Frequency, 2/3) & Graphic Data Logging of Water Temperature (1/3)

VP (Video Plotter) Mode

"VP": Ship's Track Plotting

Note: GR and VP modes are available when optional speed/temperature sensor and position fixing equipment are connected.

7. Picture Recording

One page of picture on any presentation mode can be stored and recalled anytime.

8. Picture Advance Speed (for ES mode only)

Setting	0	1	2	3	4
Scan Line/ Transmission	FREEZE	1/6	1/4	1/2	1/1

9. Alarm

Bottom or fish alarm is selected on the front panel keys. In addition, a water temperature alarm is available when a speed/temperature sensor device is connected optionally.

10. Pulselength and Repetition Rate

Max. Display Range (Basic Range + Phased Range)	Pulse Repetition (pulses/min)				Pulselength (ms)
	Normal		Ship's Speed Dependent		
	min.	max.	2kts	20kts	
0 - 24m	230	610	61	610	0.2
25 - 79m	170	300	30	300	0.4
80 - 199m	108	150	15	150	0.8
200 - 399m	85	110	11	110	1.2
400 - 639m	56	70	7	70	1.2
640 - 1279m	*2	*1	*3	*1	2.0
Above 1279m	*2	*1	*3	*1	3.6

- NOTE 1. In the Normal mode, the pulse repetition rate can be manually changed in 11 steps between min. and max. rates.
 2. In the ship's speed dependent mode, it varies between min. and max. rates in the range of 2 to 20knots. At less than 2knts, it is kept at the min. rate.
 3. *1: 45000/end range, *2: 45000/(end range + 120), *3: 4500/end range

11. Noise Limiter

Rejects unwanted signals by comparing last and present echoes in strength every transmit cycle.

12. Output Data

Water depth, water temperature data can be sent out in CIF or NMEA format if the speed/temperature sensor is connected.

13. Transmit Frequency and Output Power

50 and 200kHz, 500Wrms

14. Power Supply

11-40Vdc, universal, less than 50W

COMPLETE SET

No.	Name	Type	Code No.	Q'ty
1	Display Unit	CV-552		1
2	Installation	CP02-02800	000-024-798	1 set
3	Accessories	FP02-01400	000-024-943	1 set
4	Spare Parts	SP02-02300	000-024-732	1 set

TRANSDUCER & HULL BOTTOM/SIDEBOARD INSTALLATION MATERIALS (OPTION)

Frequency	Transducer (Code No.)	Hull Bottom Installation			Sideboard Installation	
		Ship's Hull	Tank (Code No.)	Thru-hull Pipe (Code No.)	Type	Pipe length (Code No.)
50/200kHz	50/200-1T (000-015-003)	Steel	T-603 (000-015-509)	TFB-5000 (000-015-206)	T-63	2.3m (000-015-326) 2.7m (000-015-562)
		FRP	T-603-F (000-015-510)	TRB-1000 (000-015-215)		
		Wood	T-603-W (000-015-511)	TFB-1000 (000-015-201)		
			T-64 (000-015-327)	TPB-9000 (000-015-213) TPB-1100 (000-015-214)		
	50/200-12M (000-015-042)	FRP Wood				

INSTALLATION MATERIALS

No.	Name	Type	Code No.	Q'ty
1	Power Cord	00S0120, 3m	000-104-058	1
2	Vinyl Wire	KIV 2.0SQ Black	000-554-516	1
4	NMEA Cable	22S0021-2, 5m	000-109-517	1
5	Rubber Bush	02-073-2001-0	100-066-510	1

ACCESSORIES

No.	Name	Type	Code No.	Q'ty
1	Bracket	FP02-01410	001-373-880	1
2	Filter	FP02-01420	001-373-890	1
3	Liner	3.1x10x2.0(C2801P)	000-864-817	1
4	Knob Bolt Assembly	FP02-00250	001-336-840	2
5	Viewing Hood	02-043-1301-2	204-313-012	1
6	Cover	02-074-1431-0	000-801-095	1

SPARE PARTS

No.	Name	Type	Code No.	Q'ty
1	Fuse	FGBO-A 5A AC125V	000-549-064	3

OPTIONS

No.	Name	Type	Code No.
1	Speed/temperature sensor	ST-01MSB	000-109-505
2	Connector	SRCN6A16-10P	000-508-663
3	Rectifier	PR-62, 100Vac	000-013-484
		" , 110Vac	000-013-485
		" , 220Vac	000-013-486

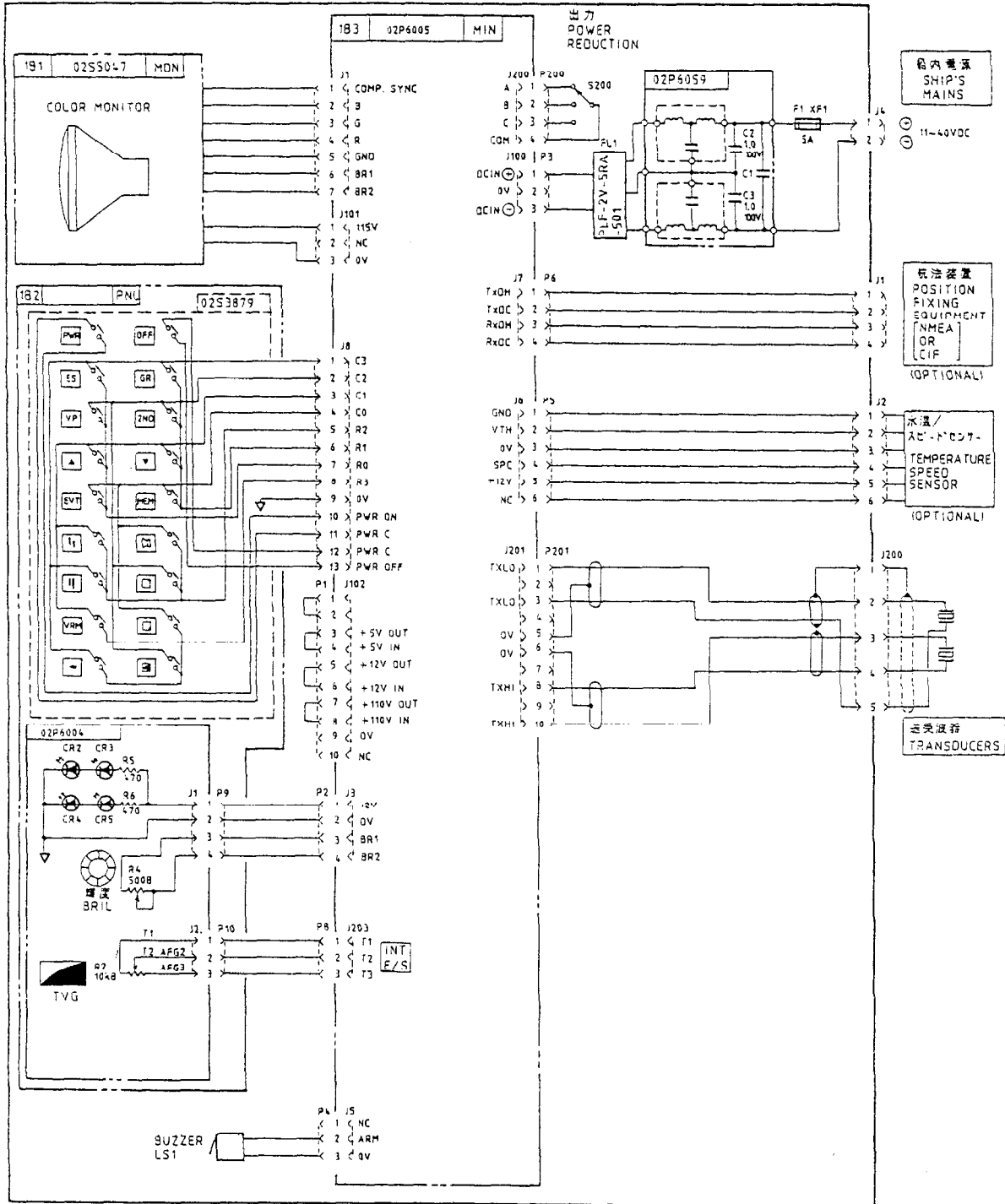

TITLE: FCV-552
指示部回路図
DISPLAY UNIT
DWG.NO. C2309-003-A

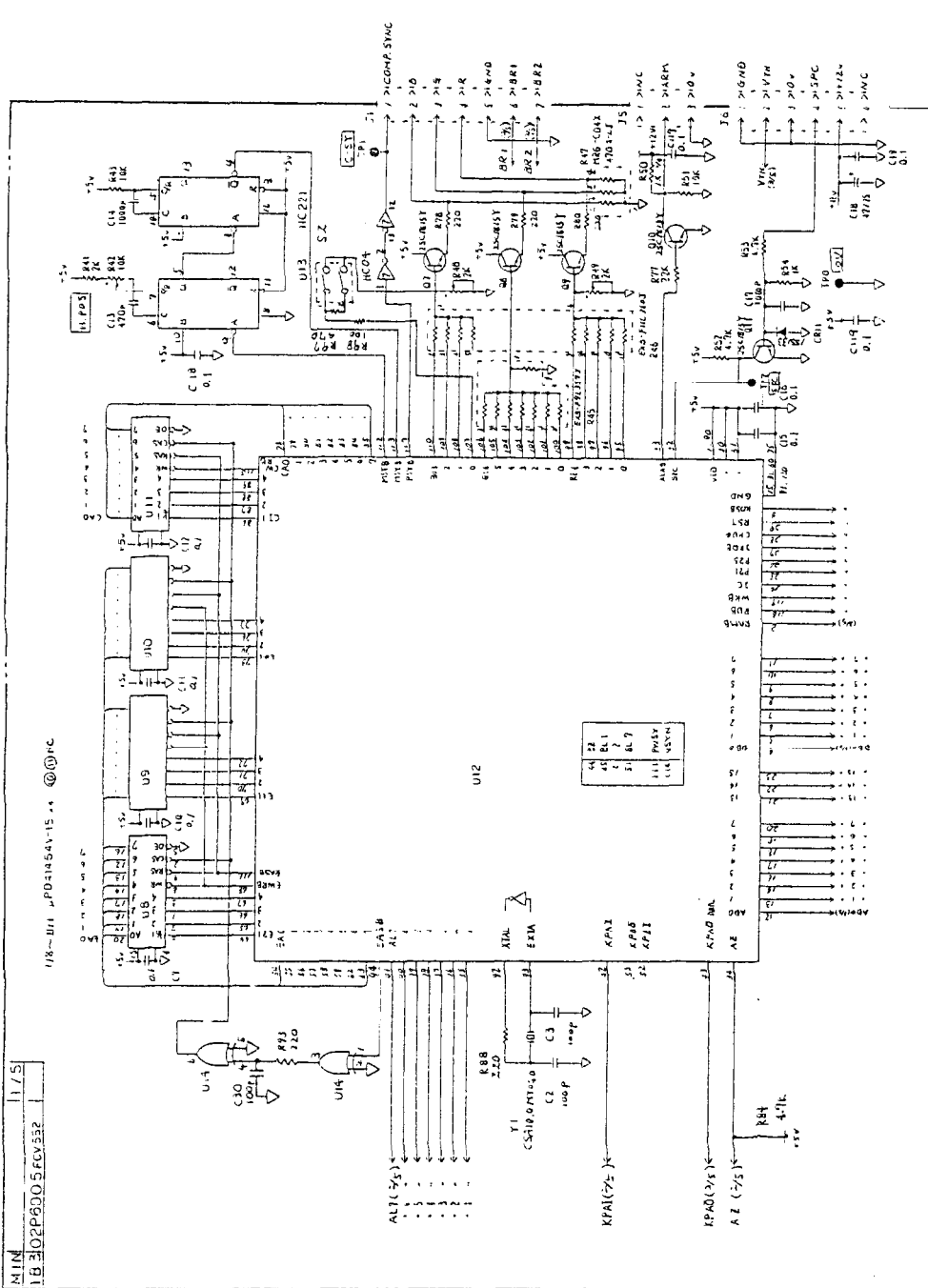

MIN
1B 302P000 5FCV532 11/5

TITLE: FCV-552
MIN BOARD (1/5)
DWG. NO. C2309-004-A

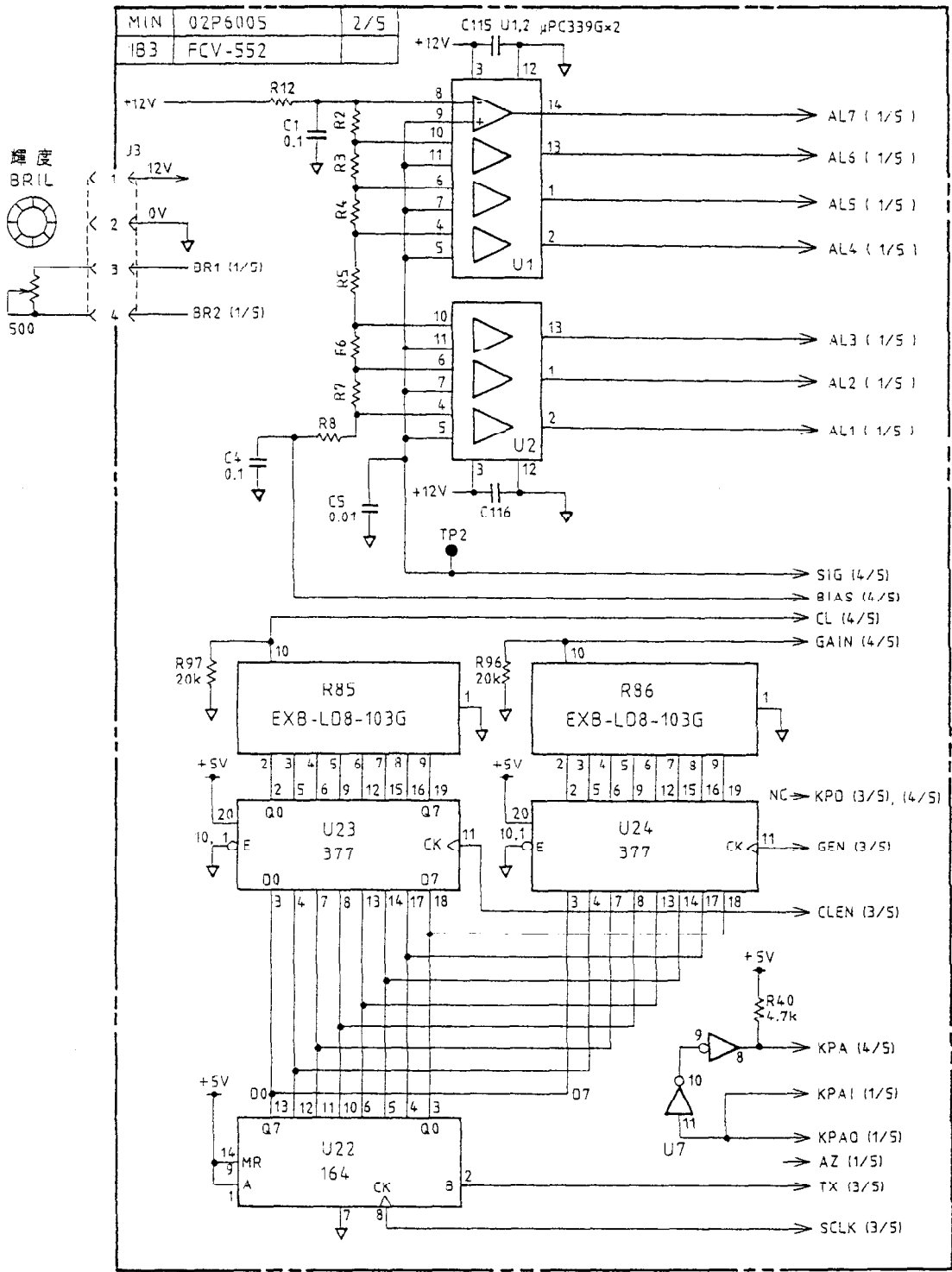

TITLE: FCV-552
 MIN 基板
 BOARD (2/5)
 DWG.NO. C2309-005-A

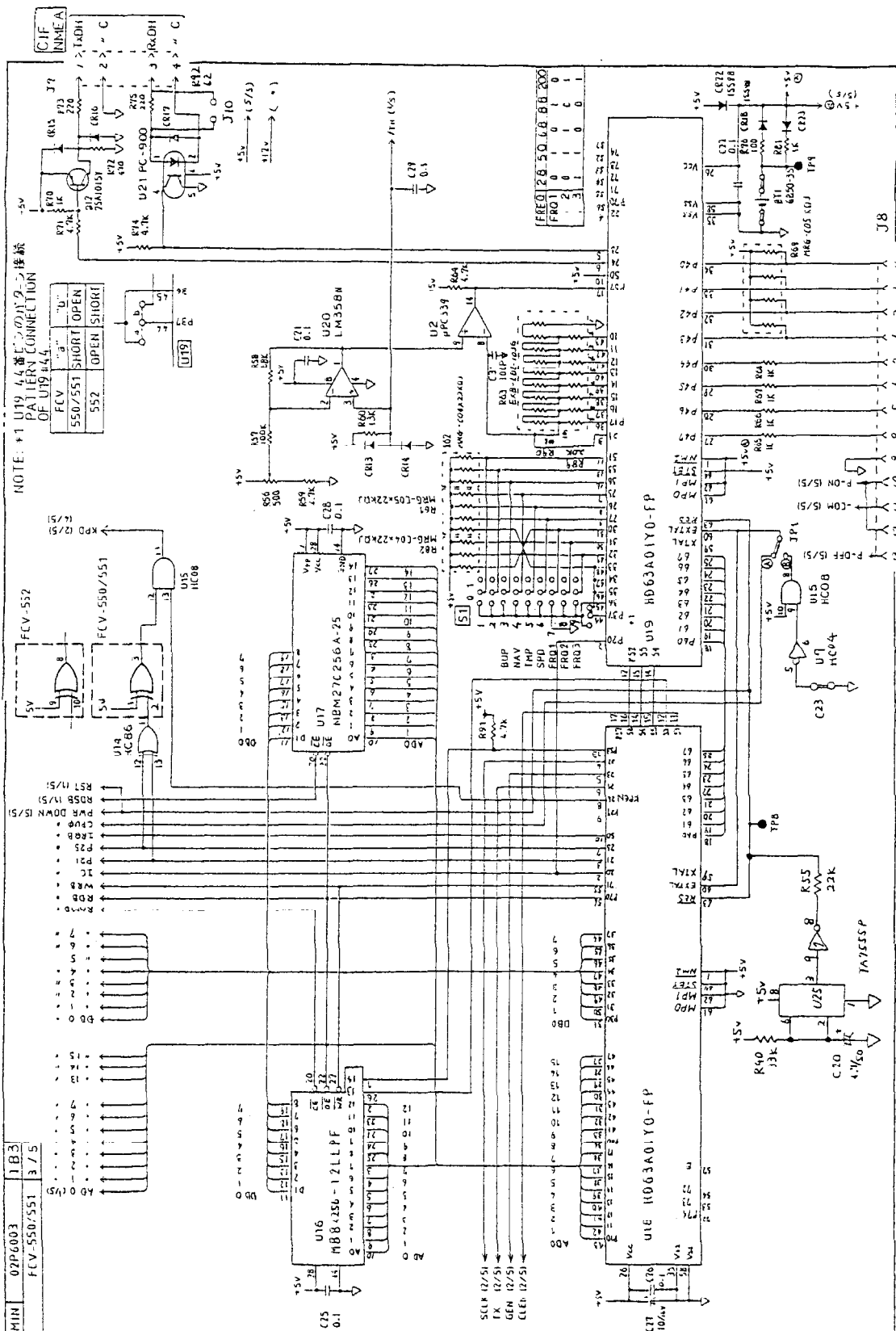

NOTE: *1 U19 44ピンスイッチのON/OFF接続
PATTERN CONNECTION
OF U19 44.

FLV-552
FLV-550/551
U15 HCOB
U14 HCB6
U13 HCB6
U12 HCB6
U11 HCB6
U10 HCB6
U9 HCB6
U8 HCB6
U7 HCB6
U6 HCB6
U5 HCB6
U4 HCB6
U3 HCB6
U2 HCB6
U1 HCB6

MIN 02P6003 1B3
FCV-550/551 3 3/5

SECRET
FX 10/251
GEN 10/251
CLEAR 10/251

TITLE: FCV-550/551/552
MIN BOARD (3/5)
BOARD
EWG.NO. C2308-009-A

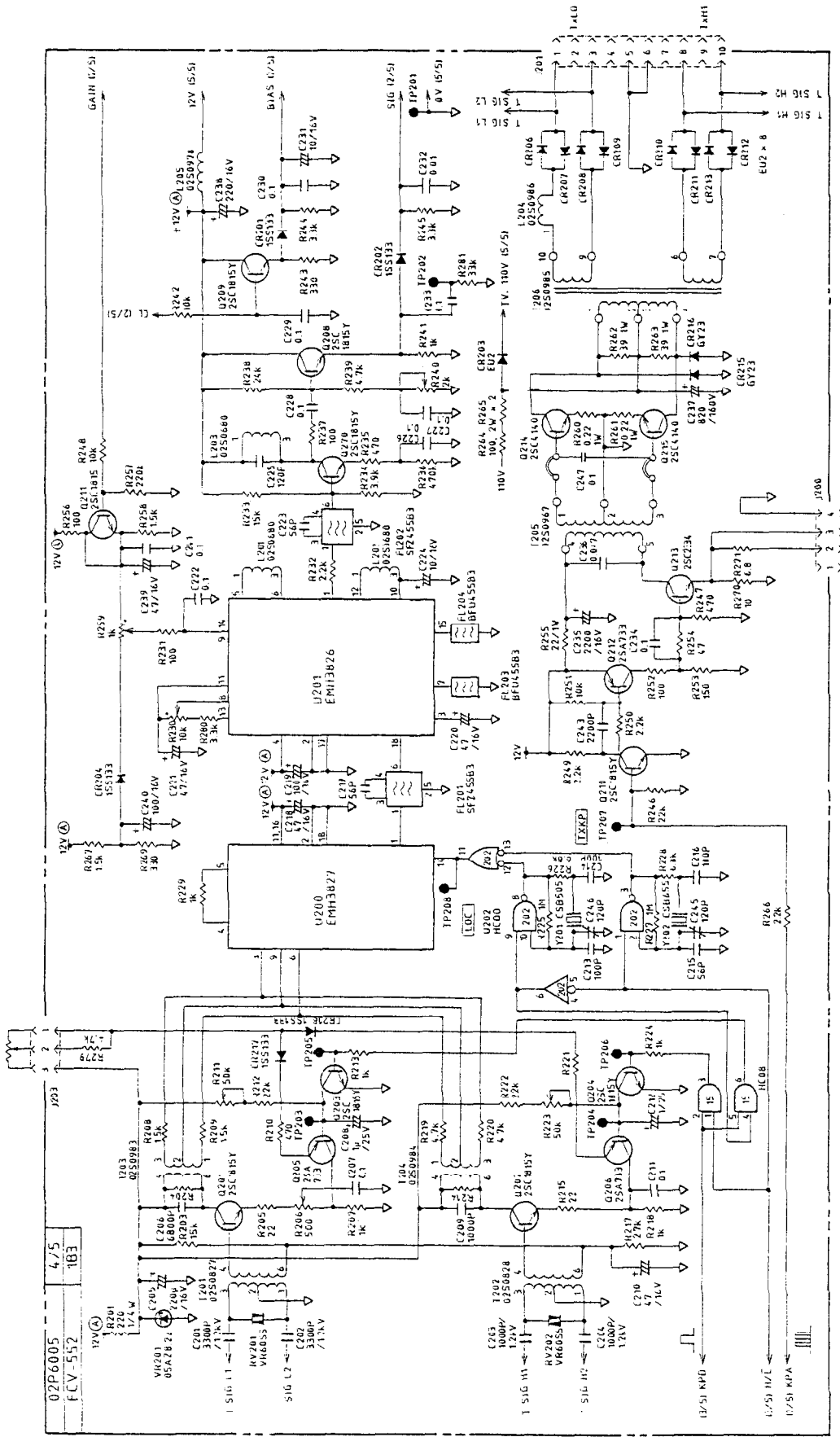

TITLE: FCV-552
 基板
 MIN BOARD
 (4/5)
 DWG NO. C2309-007-B

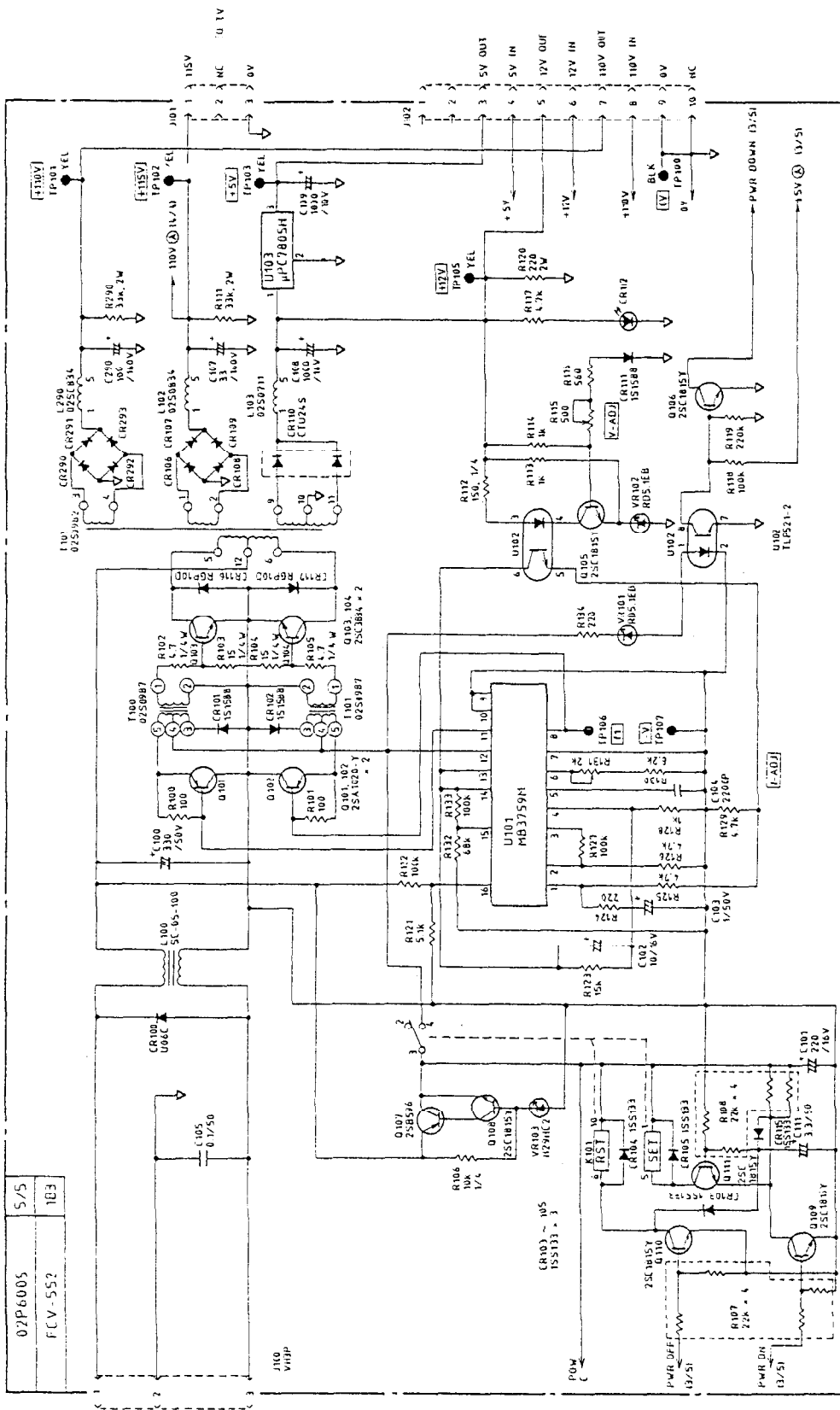

02P6005	S/S
FCV-552	103

TITLE:	FCV-552 MIN BOARD (5/5)
DWG. NO.	C2309-008-A

FURUNO

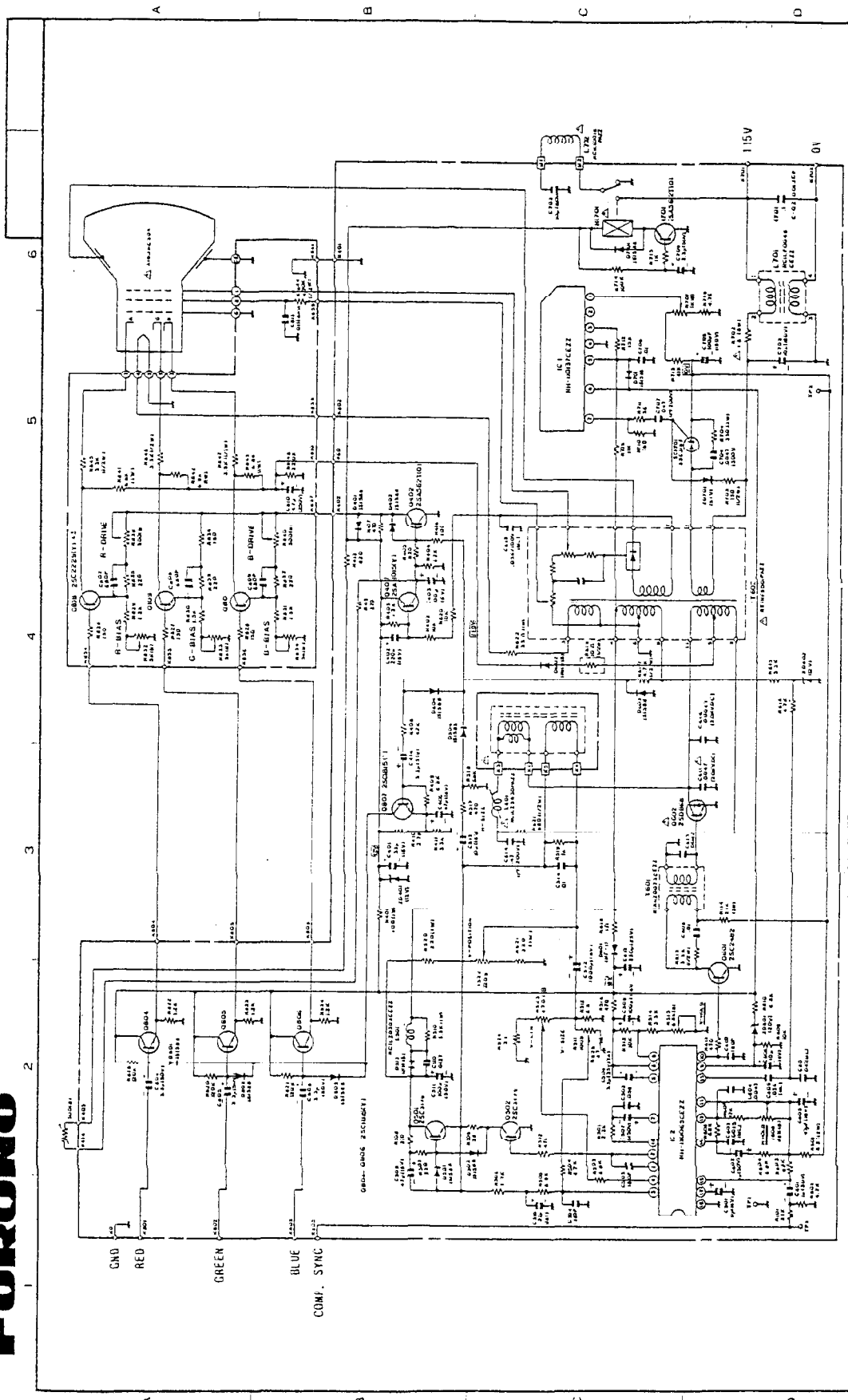

APPROVED	1/10/1977	6	TITLE
CHECKED	1/10/1977	6	AIQABDSP15
			COLOR MONITOR
			DWG NO
			C2308-013-A
			DATE
			1/10/1977

△印: 製造工程検査品です。交換時には必ずこの記号の部品を交換して下さい。

FCV-559/551/552

FURUNO ELECTRIC CO. LTD.

APPENDIX

HOOKING UP SHIP'S POSITION DATA FROM POSITION FIXING EQUIPMENT

◆ FURUNO LC-90 LORAN NAVIGATOR

Connection

To interface the LC-90 with the video sounder, the connector SRCN6A16-10P (Code No. 000-508-663) is optionally required.

This sounder can accept either FURUNO CIF or NMEA 0183 format data, and may be connected to either Port-1 (pin #1 and #2) or Port-2 (pin #5 and #6) of the LC-90. If you wish to connect an autopilot (NMEA 0180) to the LC-90, however, you should connect this sounder to Port-1, leaving Port-2 for the autopilot. Note that only Port-2 can output the data of NMEA 0180 format.

According to the output port (Port-1 or Port-2) you selected, solder the yellow and green leads to the connector (pin #1/2 or pin #5/6) and connect the both units.

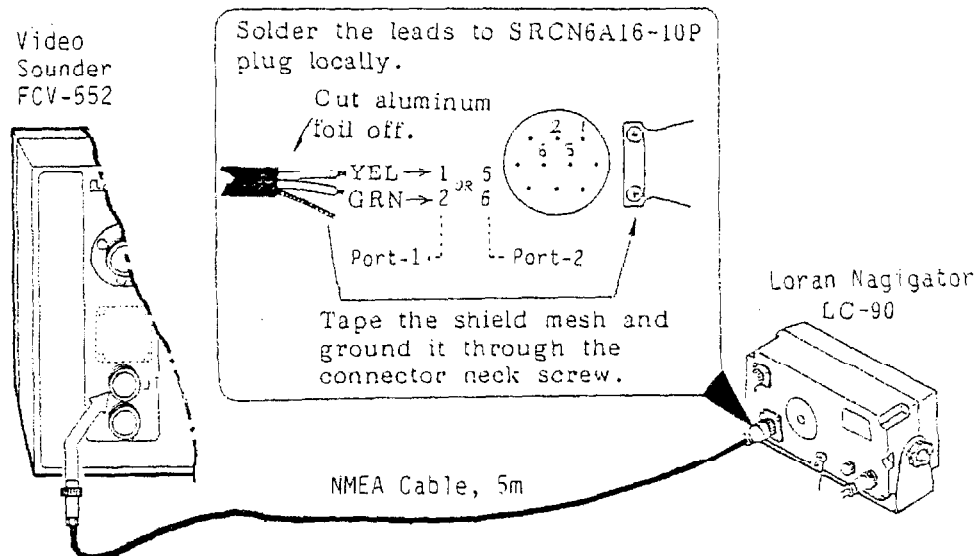

Selection of the data format

After having connected the sounder to the Ioran navigator LC-90, select the output format on the LC-90 side following the procedures below.

- (1) Press **#** and **3** keys in order to select Function 3, and the formats assigned to Port-1 and Port-2 will be presented as shown right.
- (2) Press **▼** key until the cursor moves down to the P-1 line.
- (3) Press **CLR** key.
- (4) Press **+/-** key several times until "183" or "CIF" is displayed at the right of the port number where your unit is connected.
- (5) Press **ENT** key.

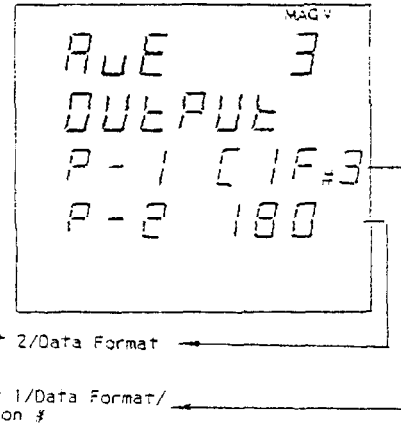

◆ FURUNO FSN-50 SATELLITE NAVIGATOR

To interface with the FSN-50, the NH-11P connector assembly is optionally required. The FCV-552 color video sounder can accept only the data transferred in NMEA 0183 format from the satellite navigator, therefore should be connected to #1/2 of the J402 on the CPU BOARD as shown below.

Selection of the data format is performed by the jumper wire between #10 and #11 on the connector.

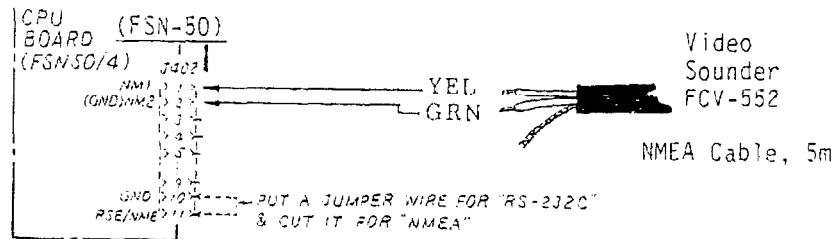

◆ OTHER MAKE POSITION FIXING EQUIPMENT WITH NMEA 0183 DATA FORMAT

As the NMEA cable is supplied as the installation materials, procure a plug for the accompany position fixing equipment locally. The wiring is similar to the above diagram: connect the yellow and green leads to the SIGNAL and RETURN lines respectively. And ground the shield of the cable with the CHASSIS of the equipment.

Sentences which can be input/output to/from this color sounder are listed below.

Input (Data accepted by FCV-552)	Output (Data output to interfaced set)
Ⓐ S--ZLZ (Local time)	Ⓐ SYCMTW (Water temperature)
Ⓑ S--GLL (Latitude/longitude)	Ⓑ \$\$DOBT (Depth)

Ⓒ \$--WPL (Waypoint number) Ⓓ \$--VTG (Distance-to-go) Ⓔ \$--MTW (Water temperature) Ⓕ \$--BOD (Bearing-to-go) Ⓖ \$--BWC (WPL + VTG + BOD)	
Note: BWC is displayed with priority.	

***** NOTE *****

When the ship's position data in the NMEA #183 data format is taken from the connector to which other equipment is already hooked (parallel connection), change the setting of jumper block J10 on MIN board to the other side so that R92 (62 ohms) is incorporated into the circuit.

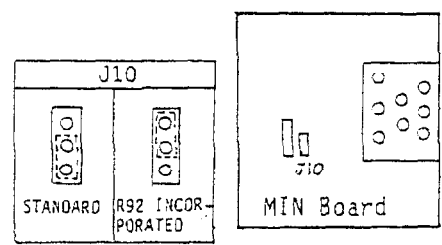

DEFAULT SETTING

The FCV-552 default to the following settings when the memory backup is turned off.

Primary Function

Function	Default Setting
Picuter mode	ES page
ES page presentation mode	Normal
ES page basic range scale	80m
ES page range phasing	0
ES page picture advance speed	4
GR page picture advance speed	15 min.
VP page range scale	1 n.m.
Gain setting	0
Alarm	Off

Secondary Function

Function	Default Setting
Color (Hue)	Day
Source of speed data	Off
Noise limiter	Off
Range phasing	Manual
Basic ranges	10, 20, 40 80, 160, 300m
Bottom-lock expansion range marker	On
Depth scale	On
Depth unit	M
Distance-to-go	0
KP rate	10
Bottom-lock expansion range	2.5m
Temperature unit	°C
Clutter	0