

FURUNO

OPERATOR'S MANUAL

*COLOR LCD
SEARCHLIGHT SONAR*

MODEL **CH-270**

ECF

(Elemental Chlorine Free)

The paper used in this manual
is elemental chlorine free.

FURUNO ELECTRIC CO., LTD.

9-52 Ashihara-cho,
Nishinomiya, 662-8580, JAPAN

Telephone : +81-(0)798-65-2111

Fax : +81-(0)798-65-4200

• FURUNO Authorized Distributor/Dealer

All rights reserved. Printed in Japan

Pub. No. OME-13220-D

(DAMI) CH-270

A : JUN . 2003

D : JUN . 03, 2010



* 0 0 0 1 4 6 9 9 5 1 3 *

IMPORTANT NOTICES

- This manual is intended for use by native speakers of English.
- No part of this manual may be copied or reproduced without written permission.
- If this manual is lost or worn, contact your dealer about replacement.
- The contents of this manual and equipment specifications are subject to change without notice.
- The example screens (or illustrations) shown in this manual may not match the screens you see on your display. The screen you see depends on your system configuration and equipment settings.
- Store this manual in a convenient place for future reference.
- FURUNO will assume no responsibility for the damage caused by improper use or modification of the equipment (including software) by an unauthorized agent or a third party.
- When it is time to discard this product it must be done according to local regulations for disposal of industrial waste. For disposal in the USA, refer to the Electronics Industries Alliance (<http://www.eiae.org/>).



SAFETY INSTRUCTIONS



WARNING



ELECTRICAL SHOCK HAZARD Do not open the equipment.

Only qualified personnel should work inside the equipment.

Immediately turn off the power at the switchboard if water leaks into the equipment or something is dropped in the equipment.

Continued use of the equipment can cause fire or electrical shock. Contact a FURUNO agent for service.

Do not disassemble or modify the equipment.

Fire, electrical shock or serious injury can result.

Immediately turn off the power at the switchboard if the equipment is emitting smoke or fire.

Continued use can cause fatal damage to the equipment. Contact a FURUNO agent for service.

Make sure no rain or water splash leaks into the equipment.

Fire or electrical shock can result if water leaks in the equipment.



WARNING

Keep heater away from equipment.

A heater can melt the equipment's power cord, which can cause fire or electrical shock.

Use the proper fuse.

The fuse in the hull and transceiver units protects them from overcurrent, equipment fault and reverse polarity of the ship's mains. If a fuse blows replace it with fuse of the same amperage. Use of a fuse of different amperage can result in damage to the equipment.

Retract the transducer before turning off the power.

Damage to the transducer may result unless it is retracted.
Wait until the transducer switch [↑] lights steadily and then turn off the power.

CAUTION

Do not exceed 20 knots when operating the equipment and do not exceed 15 knots when lowering or raising the transducer.

The transducer shaft may become damaged.

Do not use the equipment for other than its intended purpose.

Wrongful use of the equipment may result in personal injury or damage to the equipment.

WARNING LABELS

Warning labels are attached to the display, transceiver and hull units. Do not remove the labels. If a label is missing or illegible, contact a FURUNO agent or dealer.

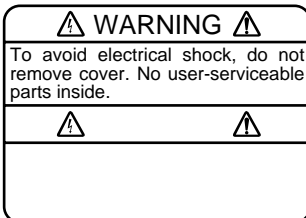

Name: Warning Label (1)
Type: 86-003-1011-0
Code No.: 100-236-230

DISPLAY UNIT,
TRANSCIVER
UNIT

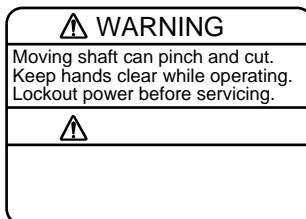

Name: "Finger Catch"
Warning Label
Type: 06-021-4015-0
Code No.: 100-281-590

HULL UNIT

CAUTION

WORKING WITH THE SONAR OIL

Precautions

- Keep oil away from eyes. Wear protective goggles when working with the oil. The oil can cause inflammation of the eyes.
- Do not touch the oil. Wear protective gloves when working with the oil. The oil can cause inflammation of the skin.
- Do not ingest the oil. Diarrhea and vomiting may result.
- Keep the oil out of reach of children.

Emergency procedures

- If the oil enters eyes, flush with clean water about 15 minutes. Consult a physician.
- If the oil is ingested, see a physician immediately.
- If the oil contacts skin, wash with soap and water.

Disposal of oil and its container

Dispose of oil and its container in accordance with local regulations. For further details, contact place of purchase.

Storage

Seal container to keep out foreign material. Store in dark, cool place.

TFT LCD

The high quality TFT (Thin Film Transistor) LCD displays 99.99% of its picture elements. The remaining 0.01% may drop out or light, however this is an inherent property of the LCD; it is not a sign of malfunction.

TABLE OF CONTENTS

FOREWORD	vii
SYSTEM CONFIGURATION	ix
1. OPERATIONAL OVERVIEW	1-1
1.1 Control Description.....	1-1
1.2 Remote Controller	1-2
1.3 Turning the Power On/Off.....	1-3
1.3.1 Power on	1-3
1.3.2 Power off	1-4
1.4 Raising, Lowering the Transducer	1-5
1.4.1 Lowering the transducer	1-5
1.4.2 Raising the transducer	1-5
1.5 Choosing a Display	1-6
1.6 Adjusting Screen Brilliance, Panel Dimmer.....	1-7
1.7 Adjusting the Gain.....	1-7
1.8 Basic Menu Operation.....	1-8
2. HORIZONTAL MODE	2-1
2.1 Operational Overview.....	2-1
2.2 Typical Horizontal Mode Display	2-2
2.3 Choosing the Range.....	2-3
2.4 Choosing Sector Width.....	2-4
2.5 Choosing Train Center	2-5
2.6 Choosing the Tilt Angle	2-6
2.6.1 Choosing the tilt angle	2-6
2.6.2 Relation between tilt angle and echo	2-7
2.6.3 Tilt angle for surface fish.....	2-8
2.6.4 Suitable tilt angle	2-9
2.7 Choosing the Training Speed	2-10
2.8 Finding Echo Position with the Cursor.....	2-10
2.9 Event Marker.....	2-11
2.9.1 Inscribing the event marker.....	2-11
2.9.2 Deleting all event markers.....	2-12
2.10 Depth and Horizontal Range Markers.....	2-12
2.11 Adjusting the Picture	2-13
2.11.1 Suppressing bottom and surface reflections	2-13
2.11.2 Suppressing bottom tail	2-14
2.11.3 Displaying weak echoes clearly	2-14
2.11.4 Erasing weak echoes.....	2-17
2.11.5 Enlarging fish echoes (horizontal expansion display).....	2-18
2.12 Target Lock	2-19
2.12.1 Choosing target lock mode	2-19
2.12.2 Manual reverse mode	2-19
2.12.3 Position mode.....	2-20
2.12.4 Echo mode	2-21

2.13	Horizontal Menu Overview	2-23
2.14	Interpreting the Horizontal Display	2-25
2.14.1	How the horizontal mode picture is painted	2-25
2.14.2	Sample echo displays	2-26
2.14.3	Combination display examples	2-30
3.	VERTICAL SCAN MODE	3-1
3.1	Operational Overview	3-1
3.2	Displaying Vertical Scan Mode Display	3-2
3.2.1	Typical vertical scan mode display	3-2
3.2.2	How the vertical scan picture is painted.....	3-3
3.2.3	Horizontal/vertical scan display	3-4
3.3	Choosing the Range	3-6
3.4	Choosing Train Center	3-6
3.5	Choosing Display Sector.....	3-7
3.6	Choosing Sector Center.....	3-8
3.7	Choosing the Tilt Speed.....	3-9
3.8	Finding Echo Position with the Cursor	3-9
3.9	Event Marker	3-10
3.9.1	Entering an event marker	3-10
3.9.2	Deleting all event markers	3-11
3.10	Depth and Horizontal Range Markers	3-11
3.11	Adjusting the Picture.....	3-12
3.11.1	Displaying weak echoes clearly.....	3-12
3.11.2	Suppressing noise and interference	3-14
3.11.3	Gain adjustment	3-14
3.11.4	Resolution color	3-15
3.11.5	Suppressing clutter.....	3-15
3.11.6	Choosing horizontal range expansion factor.....	3-16
3.12	Interpreting the Vertical Scan Display	3-17
3.12.1	Sample echo displays	3-17
4.	ECHO SOUNDER MODE.....	4-1
4.1	Operational Overview	4-1
4.2	Typical Echo Sounder Display	4-2
4.3	Choosing the Range	4-3
4.4	Train Direction	4-4
4.5	Choosing Tilt Angle.....	4-4
4.6	Choosing Picture Advance Speed	4-4
4.7	Measuring Range by Cursor	4-5
4.8	Event Marker	4-5
4.8.1	Inscribing the event marker	4-6
4.8.2	Deleting all event markers	4-6
4.9	Range Marker.....	4-7
4.10	Adjusting the Picture.....	4-8
4.10.1	Displaying weak echoes clearly.....	4-8
4.10.2	Finding echo strength (A-scope display).....	4-10
4.10.3	Gain adjustment.....	4-11

TABLE OF CONTENTS

4.10.4 Resolution color	4-11
4.10.5 Suppressing clutter	4-12
5. MENU OPERATION	5-1
5.1 COM1 Menu	5-1
5.1.1 Displaying the COM1 menu	5-1
5.1.2 COM1 menu description	5-1
5.2 COM2 Menu	5-2
5.2.1 Displaying the COM2 menu	5-2
5.2.2 COM2 menu description	5-2
5.3 Short-cut Menu, Preset Menu	5-3
5.3.1 Choosing short-cut or preset	5-3
5.3.2 Changing setting of preset key	5-5
5.3.3 Changing setting of short-cut key	5-6
5.4 SYSTEM Menu	5-8
5.4.1 Displaying the SYSTEM menu	5-8
5.4.2 SYSTEM SETTING 1 menu description	5-9
5.4.3 SYSTEM SETTING 2 menu description	5-11
5.4.4 Sonar (horizontal) mode range settings	5-13
5.4.5 Vertical scan mode range settings	5-14
5.4.6 Echo sounder mode range settings	5-15
5.4.7 Track range settings	5-16
5.4.8 Color palette	5-17
5.4.9 Language	5-18
5.4.10 System backup	5-18
5.4.11 Loading backup data	5-18
5.4.12 Transducer frequency adjustment	5-19
5.4.13 Demonstration mode	5-19
5.4.14 Restoring all default settings	5-20
6. MAINTENANCE, TROUBLESHOOTING	6-1
6.1 Preventive Maintenance	6-1
6.2 Cleaning the Equipment	6-1
6.3 Hull Unit Maintenance	6-2
6.3.1 Lubrication	6-2
6.3.2 Manually raising, lowering transducer	6-2
6.4 Transducer Maintenance	6-3
6.5 Fuse Replacement	6-3
6.6 Troubleshooting	6-4
6.7 Error Messages	6-5
6.8 Diagnostics	6-6
6.9 Test Pattern	6-8
MENU TREE	M-1
SPECIFICATIONS	SP-1
INDEX	IN-1

FOREWORD

Thank you for purchasing the CH-270 Color LCD Searchlight Sonar. We are confident you will discover why FURUNO has become synonymous with quality and reliability.

Dedicated in the design and manufacture of marine electronics equipment for more than half a century, FURUNO Electric Company has gained an unrivaled reputation as a world leader in the industry. This is the result of our technical excellence as well as our worldwide distribution and service network.

Please carefully read and follow the safety information and operating and maintenance instructions set forth in this manual before attempting to operate the equipment and conduct any maintenance. Your sonar will perform to the utmost of its ability only if it is operated and maintained in accordance with the correct procedures.

Features

The CH-270 displays underwater objects on a bright 10.4-inch color LCD display, in 8 (or 16) colors according to received echo strengths. Alternatively, the interface unit permits connection of a commercial CRT or LCD monitor to act as the main, backup or remote display. Operating frequency is 180 kHz.

The main features of the CH-270 are

- High definition active matrix color LCD.
- Target lock on a fish school or stationary position (reef, etc.).
- Audible detection of echoes frees the operator from continuous watch of the display.
- Compact display and hull units permit installation where space is limited.
- Interface IF-8000 permits use of a commercial monitor in lieu of FURUNO-supplied display unit.
- Automatic pulselength switching for optimum performance in short and long ranges.
- Eight operational modes: Horizontal, Horizontal Expansion, Vertical Scan, Echo Sounder, Horizontal/Vertical Scan, Horizontal/History, Horizontal/Video Plotter and Horizontal/Strata.
- Automatic retraction of transducer at operator-chosen ship's speed between 5 and 15 knots.
- CUSTOM MODE keys provide one-touch setup of the equipment or short-cut key function.
- Tracing of ship's track with connection of position-fixing equipment (GPS, etc.).
- One of the echo strengths may be displayed in white to enhance the specific echo level.
- The "Vertical Search" feature provides a cross-sectional view of the vertical plane, which is useful for evaluating fish school concentration.

Usage Precautions

- The Motion Sensor MS-100 compensates for ship's pitching and rolling. However, it does not compensate for load unbalance. Use Clinometer BS-704 if compensation for load unbalance is required.
- If the equipment will not be used for a long time, shut off the power to it at the mains switchboard to prevent battery discharge.
- If the soundome is to be operated while the ship is dry-docked, set the transmitter output power to "MIN(imum)," on the COM1 menu. Damage to the train/tilt assy. may result if the transducer is operated with maximum transmitter power when the ship is dry-docked.
- When the ship is dry-docked check the soundome for signs of electrolytic corrosion. Find the reason for the corrosion and attach a zinc plate to the location as an anticorrosion measure.

SYSTEM CONFIGURATION

CH-270 (350 stroke)

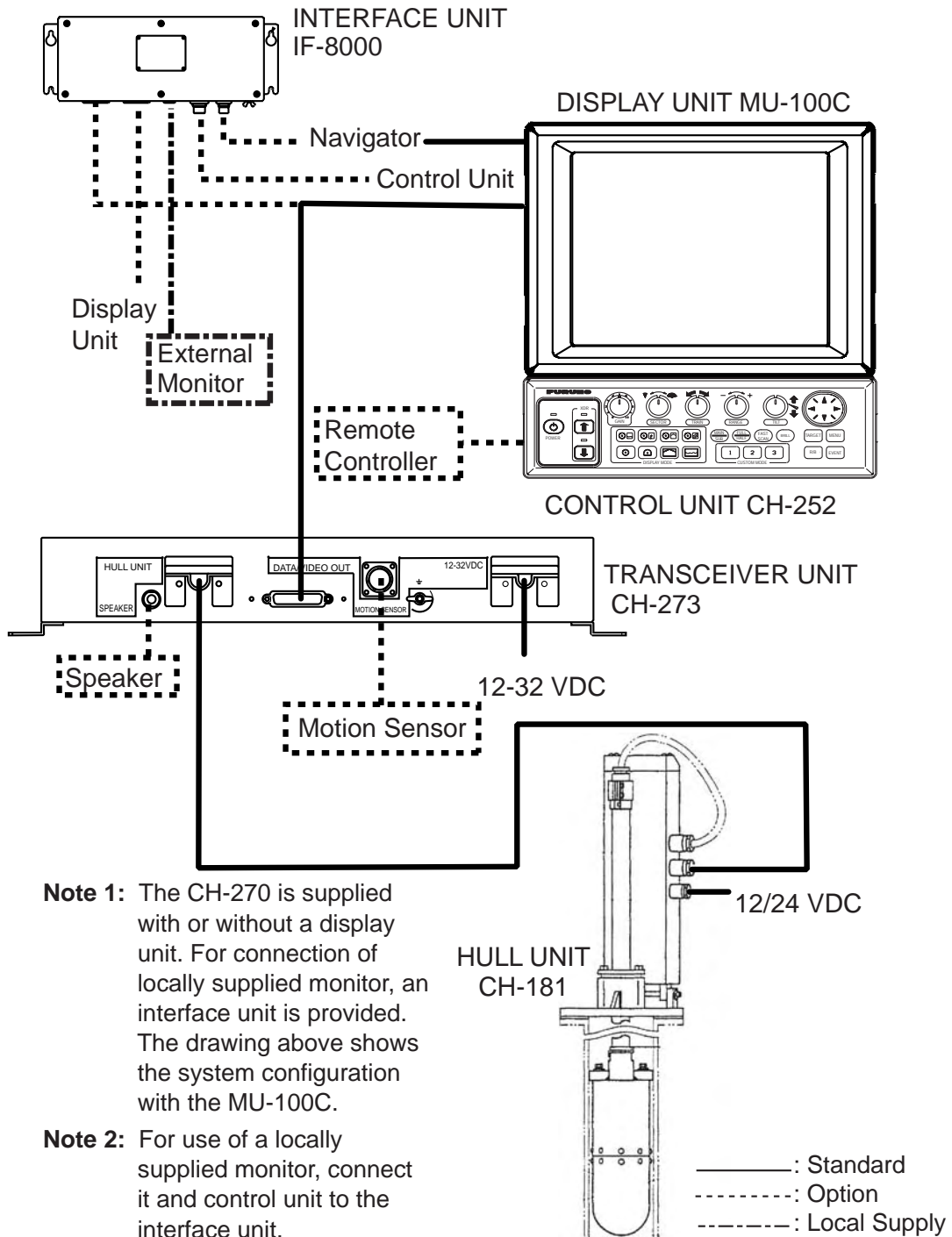

How to remove the hard cover (system with locally supplied monitor only)

Place your thumbs at the locations shown with circles in the illustration at right, and then lift the cover while pressing it with your thumbs.

SYSTEM CONFIGURATION

CH-270 (250 stroke)

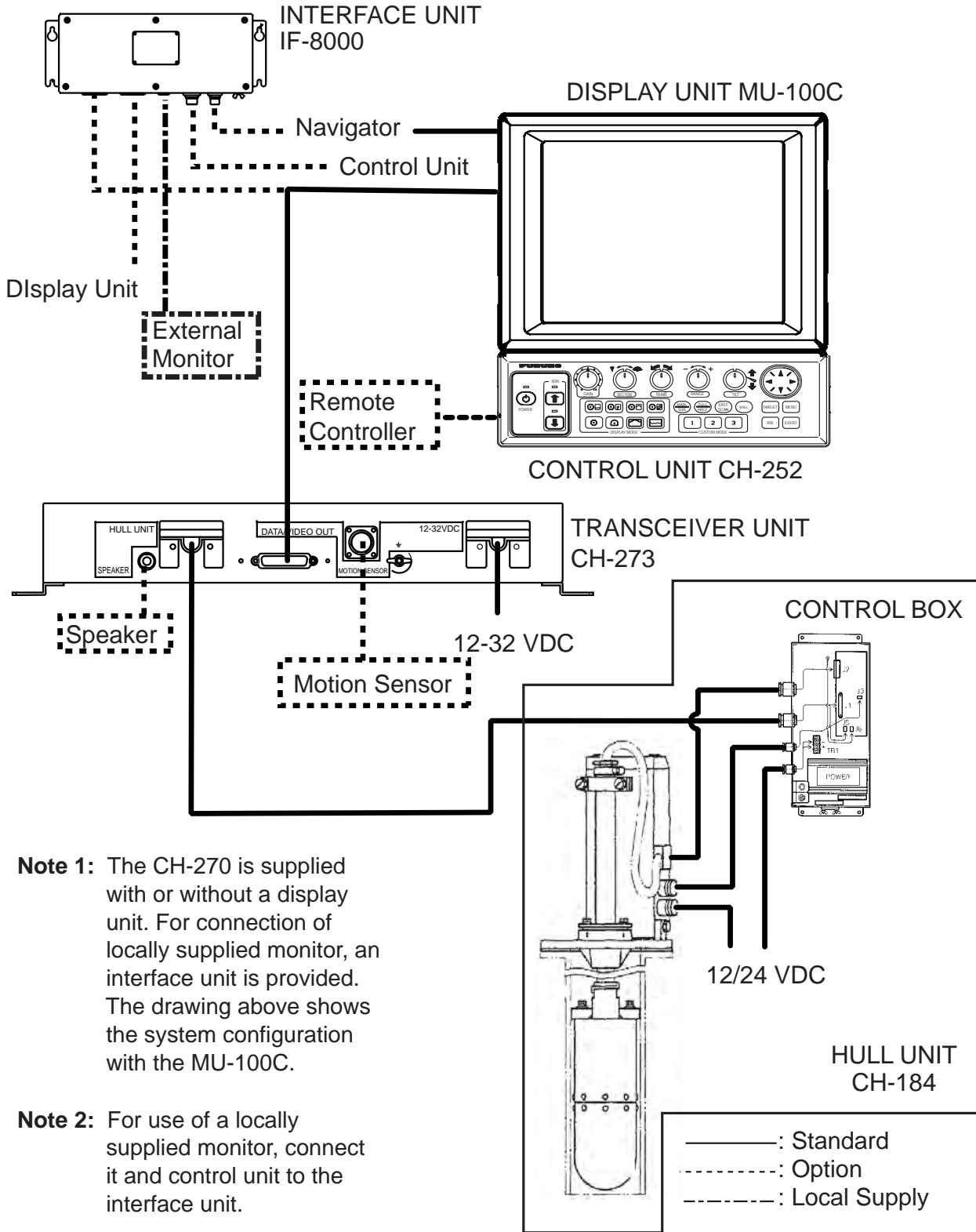

Note 1: The CH-270 is supplied with or without a display unit. For connection of locally supplied monitor, an interface unit is provided. The drawing above shows the system configuration with the MU-100C.

Note 2: For use of a locally supplied monitor, connect it and control unit to the interface unit.

1. OPERATIONAL OVERVIEW

1.1 Control Description

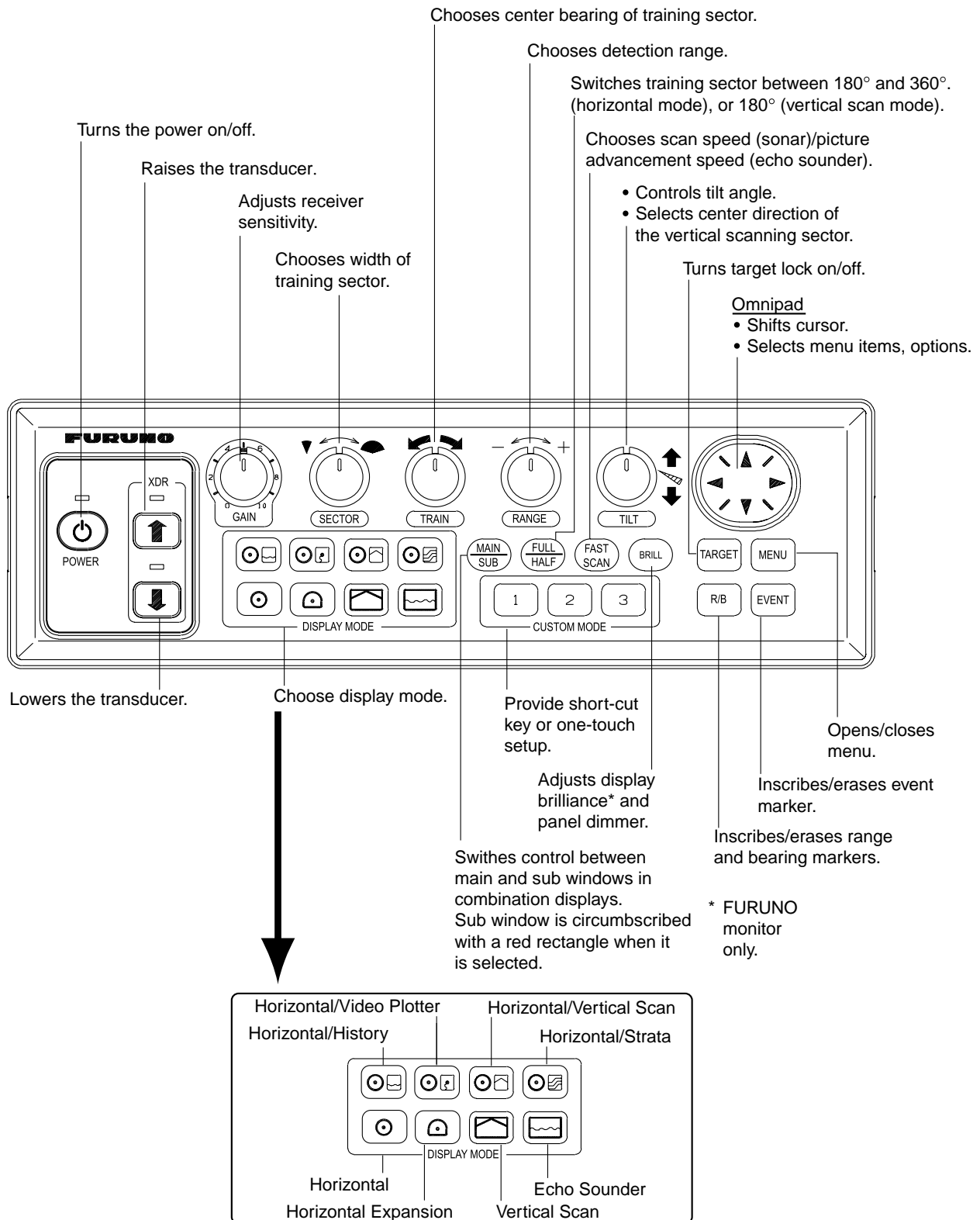

Control unit

1.2 Remote Controller

The Remote Controller CH-256 (option) provides armchair control over range, tilt, target lock and training range.

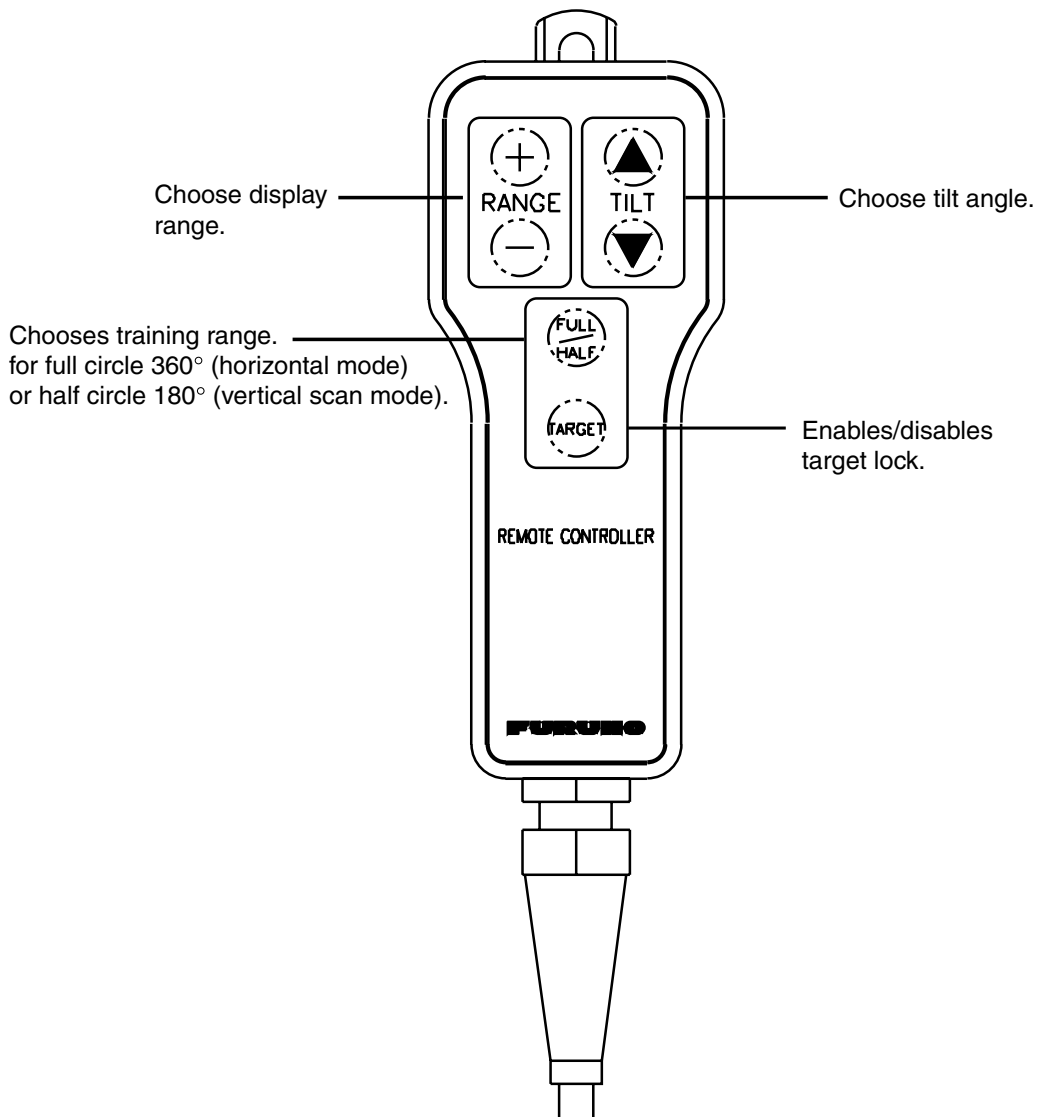

Remote controller

Note: The remote controller can also be used with a commercial monitor.

1.3 Turning the Power On/Off

1.3.1 Power on

Press the [POWER] switch on the control unit until you hear a “click.” A beep sounds, the lamp above the switch lights and the startup display appears (for four seconds).



Startup display

Note 1: Wait at least five seconds before reapplying the power.

Note 2: The first time the power is applied after installation, the language selection screen appears. English is selected; press the [MENU] key to erase the screen and continue.

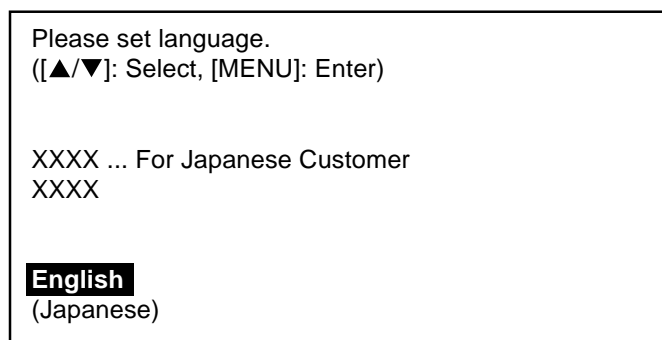

Language selection screen

Note 3: The example screens shown in this manual may not match the screens you see on your display. The screen you see depends on your system configuration and equipment settings.

1. OPERATIONAL OVERVIEW

1.3.2 Power off

1. Press the [↑] switch on the control unit. The lamp above the switch blinks while the transducer is being raised and lights steadily when it is fully raised.

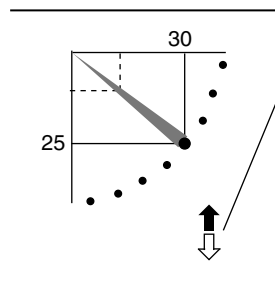

Transducer status indicator

- Up arrow is filled when transducer has been retracted into the tank.
- Down arrow is filled when transducer has been fully lowered.
- Appropriate arrow flashes during raising/lowering of transducer.

NOTE: When the transducer is being raised automatically (auto raise feature), the arrows are filled and the up arrow flashes. When the transducer has been fully retracted, the up arrow lights and the down arrow becomes hollow.

Transducer status indicator

2. Press the [POWER] switch after the lamp above the [↑] switch lights steadily.

Note 1: The transducer is automatically retracted into the tank if the [POWER] switch is pressed before retracting the transducer. However, for safety purposes, make it a habit to retract the transducer before turning off the power.

Note 2: After changing settings, wait at least one minute before turning off the equipment to allow the equipment to memorize settings. This will enable the equipment to start up with the last-used settings. No harm will result to the equipment if this is not done.

Note 3: The hull unit remains powered when power is turned off at the control unit. Therefore, if the sonar is not to be used for a long period turn it off at ship's mains switchboard.

1.4 Raising, Lowering the Transducer

1.4.1 Lowering the transducer

With the boat at the fishing ground, press the [↓] switch to lower the transducer. The lamp above the switch blinks while the transducer is being lowered and lights when it is completely lowered. The down arrow on the transducer status indicator is filled when the transducer is completely lowered.

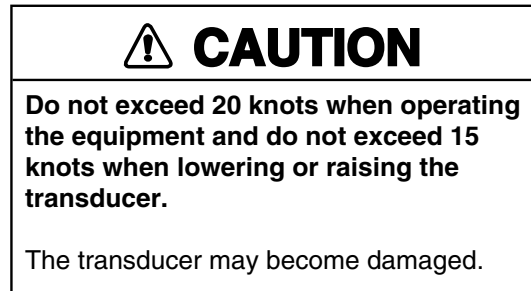

1.4.2 Raising the transducer











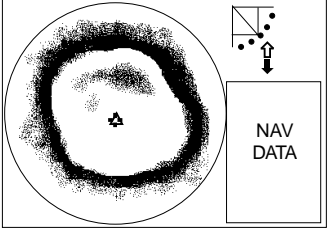

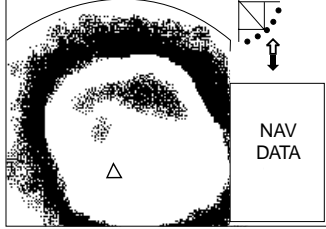

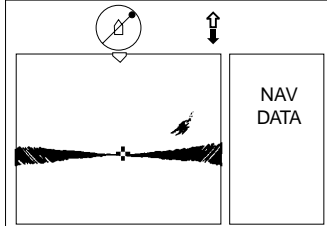
Press the [↑] switch to raise the transducer. The lamp above the switch blinks while the transducer is being raised and lights steadily when it is fully raised. The up arrow of the transducer status indicator is filled when the transducer is fully raised.

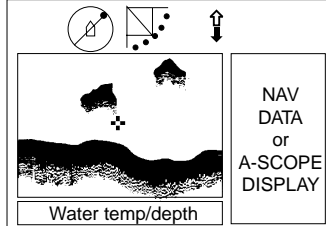
Note 1: With speed input, the transducer can be automatically raised when the ship's speed exceeds a speed between 5 and 15 knots. For further details about the automatic retraction feature, see AUTO RETRACTION in paragraph 5.4.3.

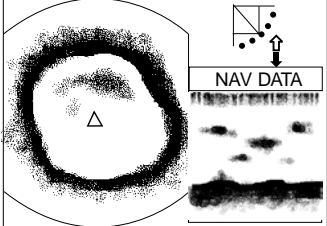
Note 2: Audio and visual alarms may be released when ship speed goes higher than allowed for a certain transducer operation. For further details, see SPEED ALARM MESSAGE in paragraph 5.4.3.

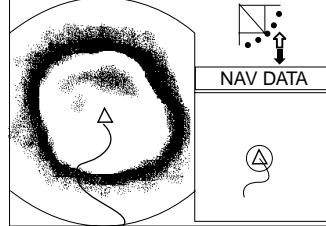
1.5 Choosing a Display

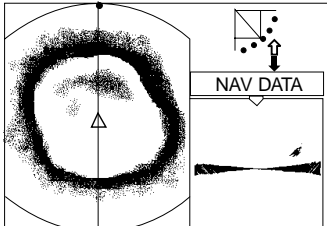
This sonar has eight display modes and you may choose one with one of the DISPLAY MODE keys. Refer to the chapter shown in the illustration for more information about each mode.

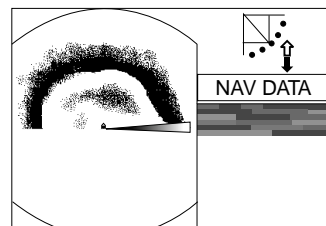
Key	Picture	Key	Picture
	 <p><u>HORIZONTAL</u></p> <p>This mode provides 360 degree coverage. Useful for general search. (Chapter 2)</p>		 <p><u>HORIZONTAL EXPANSION</u></p> <p>Zoomed horizontal picture appears over the entire screen. (Chapter 2)</p>
	 <p><u>VERTICAL SCAN</u></p> <p>Vertical section of underwater conditions appears on the entire screen. (Chapter 3)</p>		 <p><u>ECHO SOUNDER</u></p> <p>Using a fixed spot beam this display shows fish echoes below or around the vessel. (Chapter 4)</p>
	 <p><u>HORIZONTAL/HISTORY</u></p> <p>The horizontal picture appears in the main window; the history picture in the sub window. Useful for showing history of fish movement, distribution. (Chapter 2)</p>		 <p><u>HORIZONTAL/VIDEO PLOTTER</u></p> <p>The horizontal picture appears in the main window and the video plotter picture, which traces ship's track, in the sub window. (Chapter 2)</p>
	 <p><u>HORIZONTAL/VERTICAL SCAN</u></p> <p>The horizontal picture appears in the main window; the vertical scan picture in the sub window. Note that the vertical scan display may be located below the horizontal display, with both displays nearly equal in size. (Chapter 3)</p>		 <p><u>HORIZONTAL/STRATA</u></p> <p>The horizontal picture appears in the main window; the strata picture in the sub window. The strata picture shows bottom undulations in different colors. It is useful in bottom trawling to avoid projections. (Chapter 2)</p>

Display modes

1.6 Adjusting Screen Brilliance, Panel Dimmer

Screen brilliance can be adjusted in nine levels and the panel dimmer (backlighting) in four.

1. Press the [BRILL] key to open the dialog box for screen brilliance and panel dimmer. Do the next step within four seconds; otherwise the dialog box will be erased.

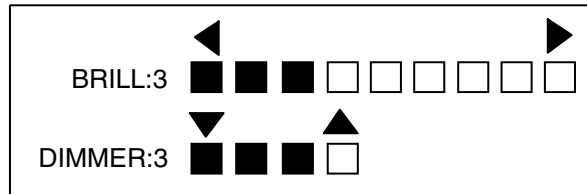

Brilliance, panel dimmer dialog box

2. Operate ◀ or ▶ to adjust screen brilliance (0 is the lowest brilliance; 9 the highest). The [BRILL] key may also be operated to adjust brilliance.
3. Operate ▲ or ▼ to adjust the panel dimmer (0 is the lowest level; 4 is the highest).
4. Press the [MENU] key to register settings and close the dialog box. Note that the dialog box is automatically erased if there is no control operation within about four seconds.

Note: The brilliance of a commercial monitor cannot be adjusted with the [BRILL] key. Use the associated control on the monitor.

1.7 Adjusting the Gain

The [GAIN] control adjusts the sensitivity of the receiver. Normally, the control is adjusted so that the bottom echo is displayed in reddish-brown mixed with red. Initially set the gain between "4" and "6" and then fine tune according to fishing ground, etc.

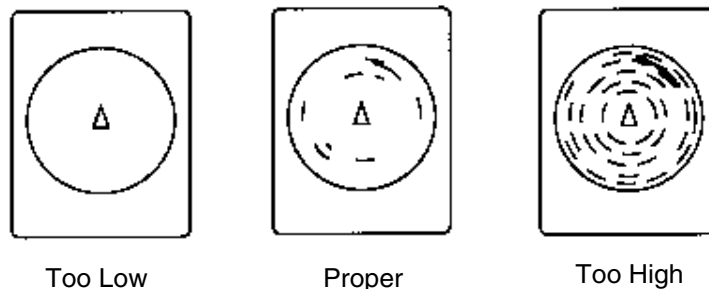

How to adjust the gain

1.8 Basic Menu Operation

The menu, consisting of seven menus, mostly contains items which once preset do not require frequent adjustment. Below is the procedure for basic menu operation.

1. Press the [MENU] key to open the menu. The last-used menu is displayed. (In the example below, the COM2 menu is shown.)

Note: Either PRESET or SHORT-CUT appears between ES and SYS at the top of the menu depending on the setting of CUSTOM KEY on the SYSTEM SETTING 1 menu. For further details, see paragraph 5.3.

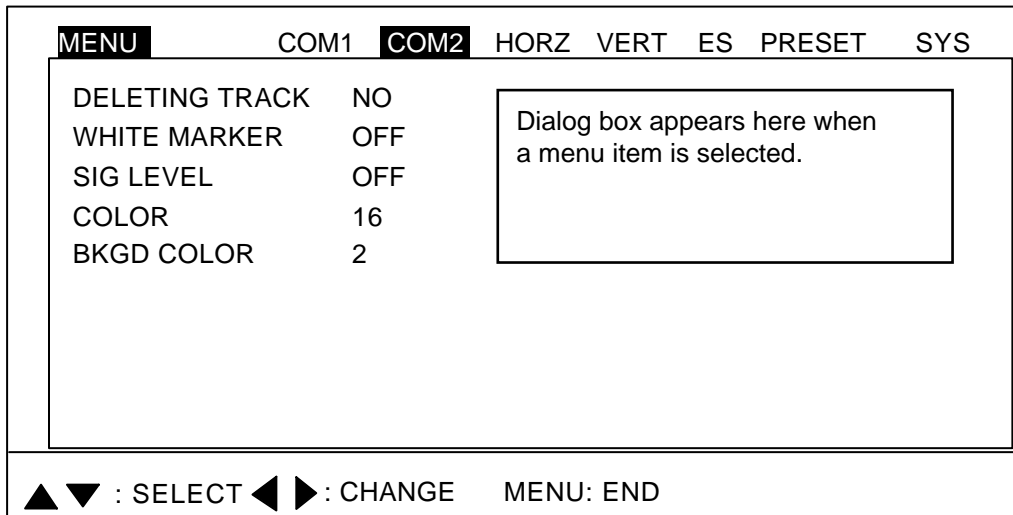

COM2 menu

2. To choose a menu, press ▲ to choose MENU at the top of the screen (if it is not already chosen) and then press ◀ or ▶ to choose menu desired.
3. Press ▲ or ▼ to choose menu item desired. Menu help is provided at the bottom of the screen.
4. Press ▶ to open the corresponding dialog box. The example below shows the dialog box for DELETING TRACK in the COM2 menu.

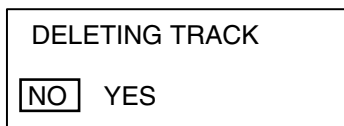

Dialog box for deleting track

5. Press ◀ or ▶ to choose option desired. If input of numeric data is required, use ◀ or ▶ to lower or raise the figure, respectively.
6. Press ▲ or ▼ to close the dialog box and return to the menu, or press the [MENU] key to register your selection and close the menu.

2. HORIZONTAL MODE

2.1 Operational Overview

The figure below shows the typical horizontal mode operating sequence.

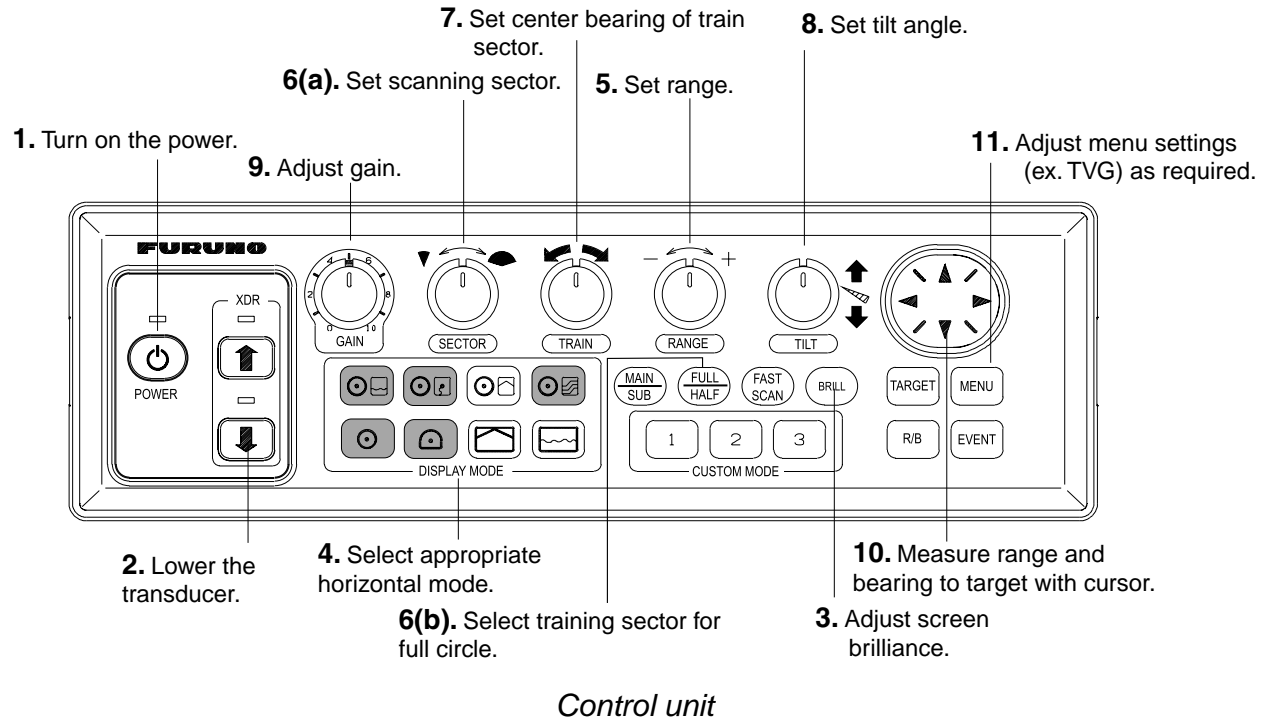

2.3 Choosing the Range

The [RANGE] control chooses the detection (display) range. Choose the range according to either the fish species being searched or the depth desired. 15 ranges are available.

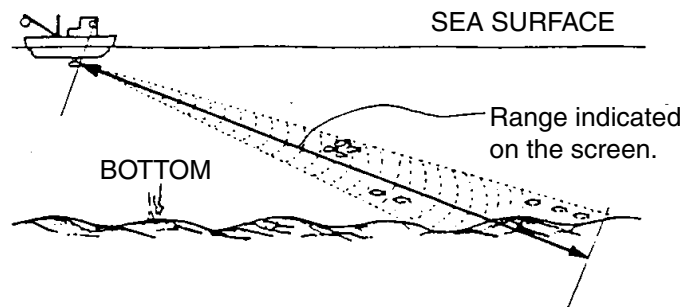

How to choose the range

Default horizontal mode range settings

Range No.	Meters	Feet
1	10	40
2	20	80
3	40	120
4	60	200
5	80	300
6	100	400
7	120	500
8	160	600
9	200	700
10	250	800
11	300	1000
12	400	1200
13	500	1500
14	600	2000
15	800	2500

Normally, the range is set so that the bottom is traced at the lower part of the screen (like an echo sounder). Each time the [RANGE] control is operated the newly chosen range briefly appears in large characters at the screen top. Range is always displayed at the top right-hand corner of the screen.

Note 1: Unit of range measurement may be chosen from among meters, feet, fathoms, passi/braza and Hiro (Japanese), with UNIT on the SYSTEM SETTING 1 menu. For further details, see UNIT in paragraph 5.4.2.

Note 2: Ranges may be freely preset as desired. For further details, see paragraph 5.4.4.

2.4 Choosing Sector Width

Sector means the width of the transducer training. The [SECTOR] control chooses the training (display) area among the sixteen positions shown in the table below. Clockwise rotation of the control increases the sector width; counterclockwise rotation decreases it.

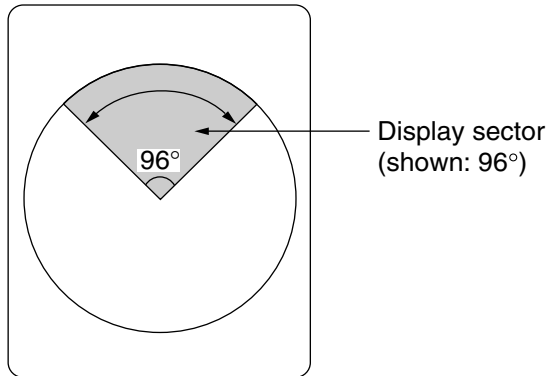

Display sector

	1	2	3	4	5	6	7	8	9	10	11	12	13	14	15	16
Sector width (°)	6	24	48	72	96	120	144	168	192	216	240	264	288	312	336	360

In the full-circle mode (360°) the direction of training is clockwise; in the half-circle mode the direction is clockwise to counterclockwise alternately.

One-touch selection of 360° sector

Each pressing of the [FULL/HALF] key alternately chooses 360° sector (full circle) or 168° sector (half circle). If the [SECTOR] control is operated following the selection of the full-circle display, the next pressing of the [FULL/HALF] key presents the full-circle display.

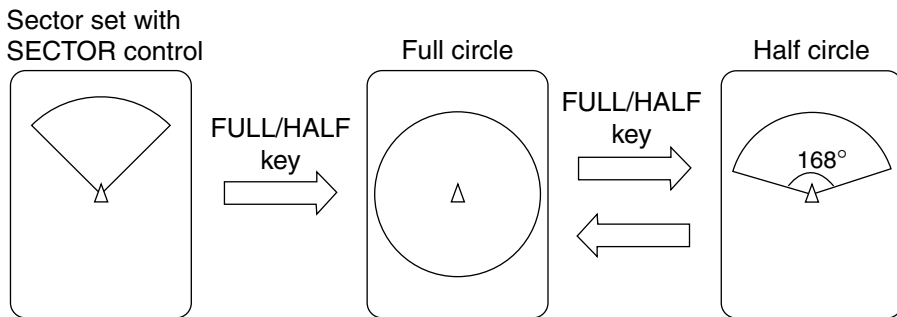

How the FULL/HALF key works

2.5 Choosing Train Center

The [TRAIN] control chooses the center direction of the detection range. The range of adjustment is 0° to 354° in increments of 6°. The chosen bearing is shown with a filled circle, the train indicator, on the bearing scale.

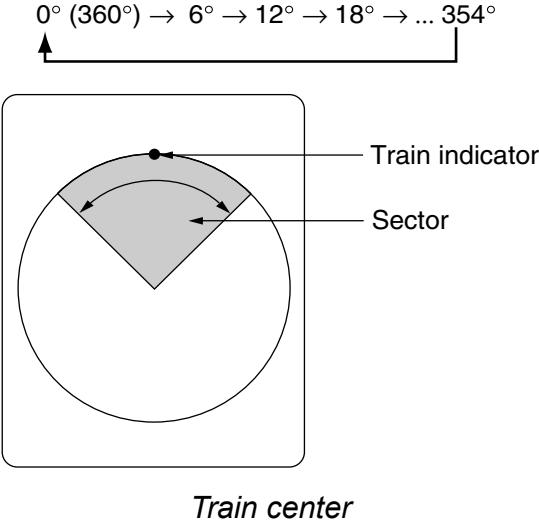

2.6 Choosing the Tilt Angle

2.6.1 Choosing the tilt angle

The tilt angle shows the direction to which the sound wave is emitted. When the sound wave is emitted horizontally, the tilt angle is said to be 0° and when emitted vertically, 90° . To set a tilt angle, operate the [TILT] control. Watch the tilt angle indication and the tilt angle indicator at the top right corner of the screen. The tilt angle can be set in increments of 1° , from $+5^\circ$ (upward) to 90° (downward). Automatic tilt selection is also available. See AUTO TILT on page 2-24 for details.

Choose the tilt angle depending on target fish. For surface fish choose a small angle (about 5°) to minimize sea surface reflections and for bottom fish, a large angle (about 40°) to search a wide area.

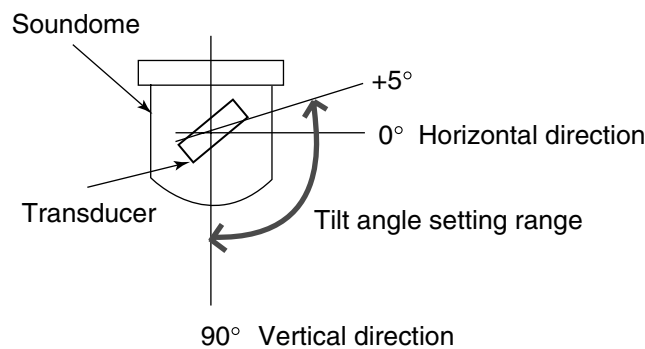

Sounding beam and tilt angle

2.6.2 Relation between tilt angle and echo

Refer to the illustration below to see the relation between tilt angle and bottom echo.

Case 1: Tilt angle 30° to 40°: This tilt angle will display the entire bottom since it is captured by the full width of the beam.

Case 2: Tilt angle 10° to 20°: This tilt angle will only display half the bottom since it is only captured by the lower half of the beam.

Case 3: Tilt angle 0° to 5°: This tilt angle may or may not capture the bottom since the returning echo is weak.

The figure below illustrates how two fish schools "a" and "b" are displayed on the screen using three different tilt angles.

Case 1 (Tilt angle 30° to 40°): Fish school is obscured by the bottom.

Case 2 (Tilt angle 10° to 20°): Fish school is located above the bottom (midwater).

Case 3 (Tilt angle 0° to 5°): Fish school is located close to the bottom.

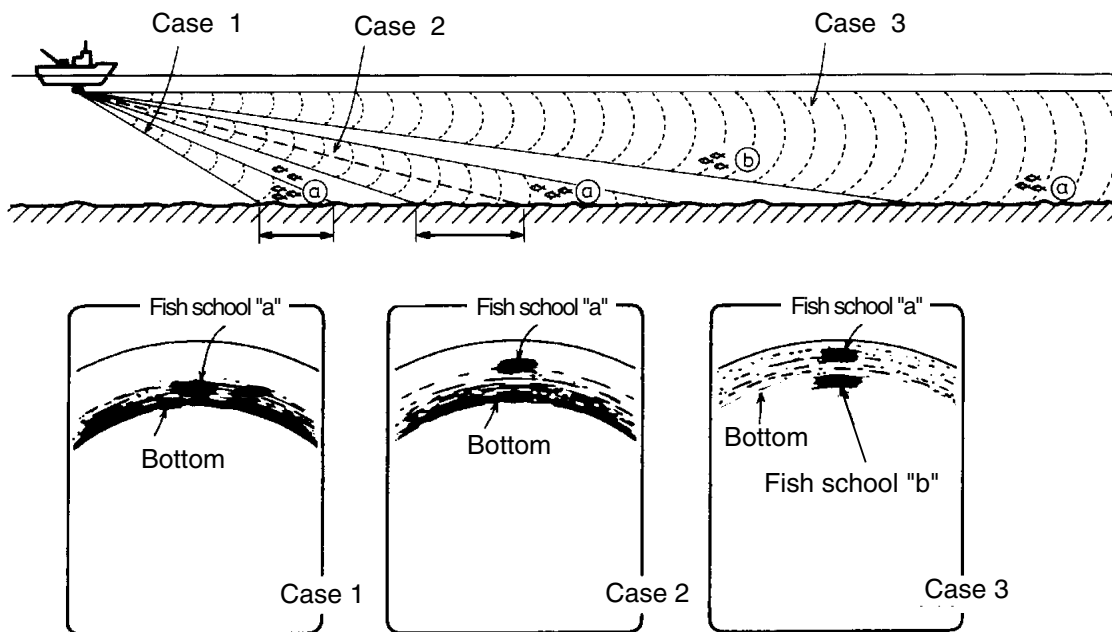

Fish echo and tilt angle

Points to consider

- Normally, a vertically distributed fish school is a better sonar target than the bottom, because it reflects the transmitted pulse back toward the transducer.
- In case 3, both fish schools “a” and “b” are presented. Generally speaking, however, midwater fish schools tend to be larger than bottom fish schools and they are often displayed near the bottom on the display.
- It is difficult to detect bottom fish when they are not distributed vertically.

2.6.3 Tilt angle for surface fish

Sound emitted from the sonar transducer forms an oval-shaped beam with a width of approximately 8° in the vertical direction (vertical beam width). The tilt angle is indicated by the angle between the center line of the beam and the horizontal plane. Then, if the tilt angle is set to 0° , the center line is parallel with the sea surface and one half of the emitted sound goes upward, toward the sea surface.

This causes one half of the emitted sound to be reflected toward the transducer and displayed on the screen as sea surface reflections. When the sea is calm, since the sound is reflected just like a light hitting a mirror at a narrow incident angle, it propagates away and the sea surface reflections become negligible.

However if the sea is not calm enough, they will become dominant and interfere with observation of wanted echoes. To minimize these sea surface reflections and to search fish schools effectively, the tilt angle is usually set between 5° and 6° so the upper portion of the beam becomes almost parallel with the sea surface. When the sea is rough, the tilt angle is slightly increased to lessen the affect of sea surface reflections.

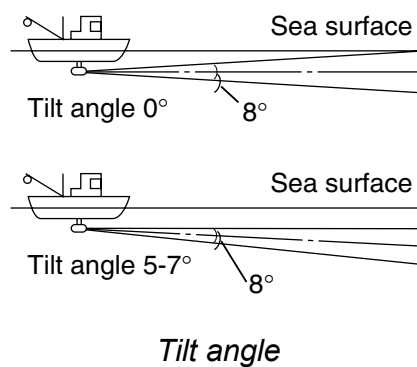

2.6.4 Suitable tilt angle

The figure below illustrates the relationship among tilt angle, depth and detection range. Refer to it to find out the suitable tilt angle for a given depth/detection range.

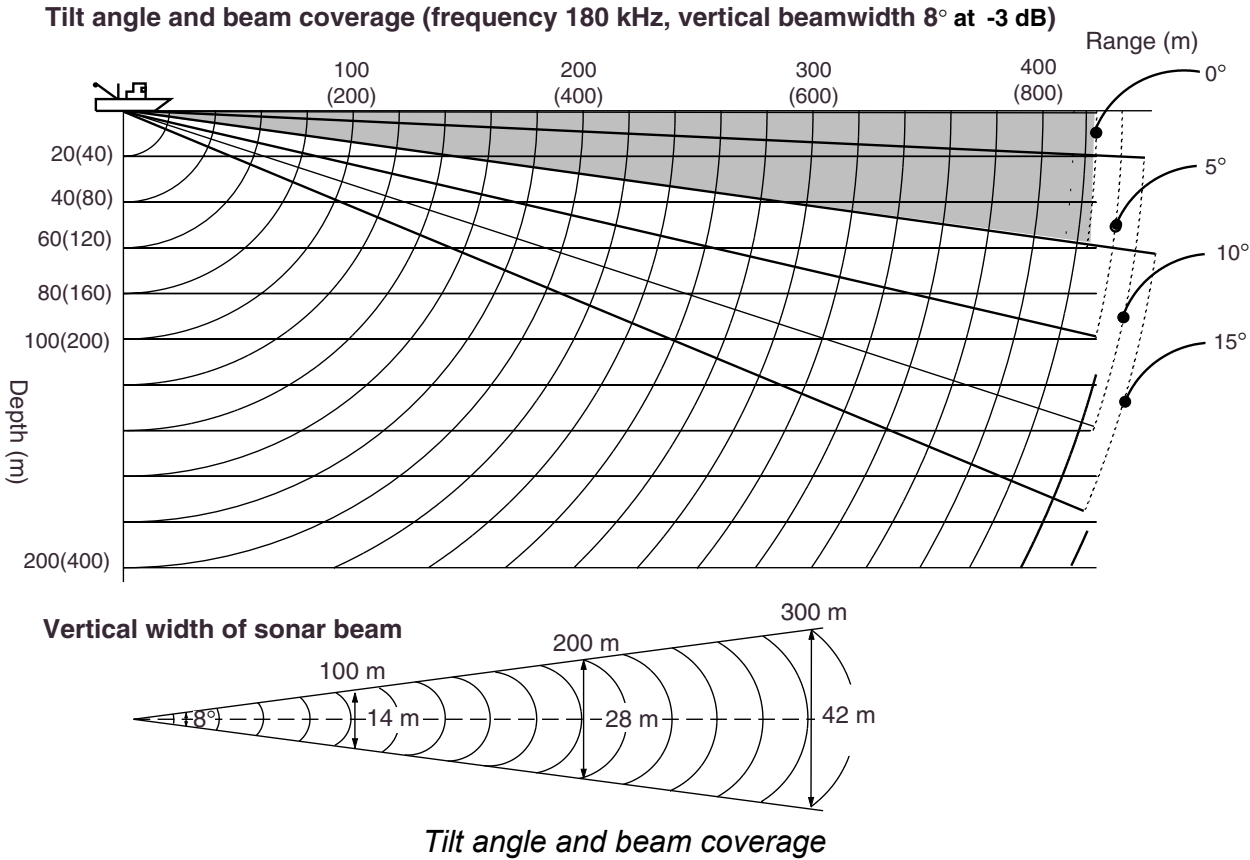

2.7 Choosing the Training Speed

The training speed determines how fast the transducer scans the sounding sector. Two choices are available, normal speed and high speed, and one may be chosen with the [FAST SCAN] key. Each time the key is pressed, "NORM" (normal speed) or "FAST" (high speed) momentarily appears at the screen top.

Normal (6°): 60 transmissions required to complete the full 360° picture.

High (12°): 30 transmissions required to complete the full 360° picture.

The time required to train a full circle depends on range used and other factors. The table below shows the time required to complete one full circle on each range.

Range		1	2	3	4	5	6	7	8	9	10	11	12	13	14	15
Unit	ft	40	80	120	200	300	400	500	600	700	800	1000	1200	1500	2000	2500
Time required (sec) for one full circle	Norm	11	11	11	11	11	11	13	15	17	20	25	30	37	49	61
	Fast	11	11	11	11	11	11	12	14	15	16	19	21	25	31	37
Unit	m	10	20	40	60	80	100	120	160	200	250	300	400	500	600	800
Time required (sec) for one full circle	Norm	11	11	11	11	11	11	11	14	17	21	25	33	41	49	65
	Fast	11	11	11	11	11	11	11	13	14	16	18	22	26	30	38

Note 1: The above values are for reference purposes. The actual training speed may vary.

Note 2: The range setting must be at least 160 meters to activate high-speed training.

2.8 Finding Echo Position with the Cursor

The cursor measures horizontal range, depth and bearing. Operate the Omnipad to place the cursor where desired. Cursor position data appears at the top left-hand corner on the screen.

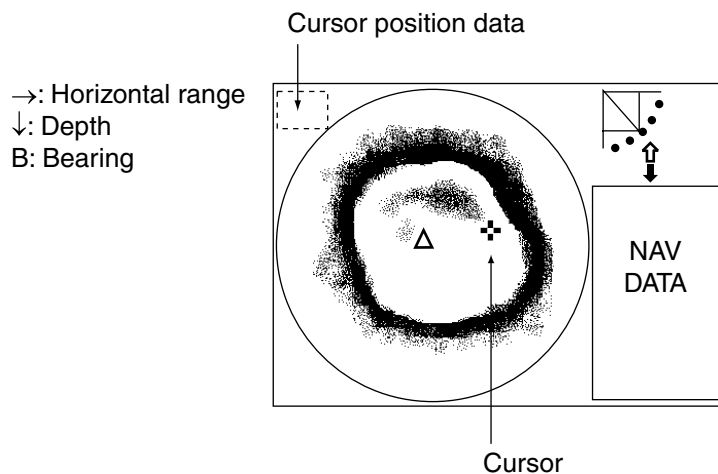

Location of cursor position data

2.9 Event Marker

The event marker functions to mark important locations on the screen, and five may be inscribed. Each time the [EVENT] key is pressed the “latest event marker” (⊕) is inscribed at the cursor location and all previously entered event markers are shown by the “previous event marker” (+). When the capacity for event markers is reached, the eldest event marker is erased from the screen to make room for the latest.

Note 1: With position data input the event marker moves with ship's movement. The event marker can be inscribed without position data, however it will be stationary.

Note 2: The event marker cannot be inscribed from the sub window (strata, history and video plotter displays). It can only be inscribed from the main window.

Note 3: The latitude and longitude position of the event marker can be output to a video plotter and that position inscribed on the plotter's screen with the external waypoint mark (X). Each press of the [EVENT] key outputs event marker position. For further details, see TARGET L/L in paragraph 5.4.2.

Note 4: The tilt angle must be less than 75 degrees to use this feature.

2.9.1 Inscribing the event marker

1. Operate the Omnipad to place the cursor on the location desired for an event marker.
2. Press the [EVENT] key to inscribe the event marker. Event marker data appears at the bottom left-hand corner.

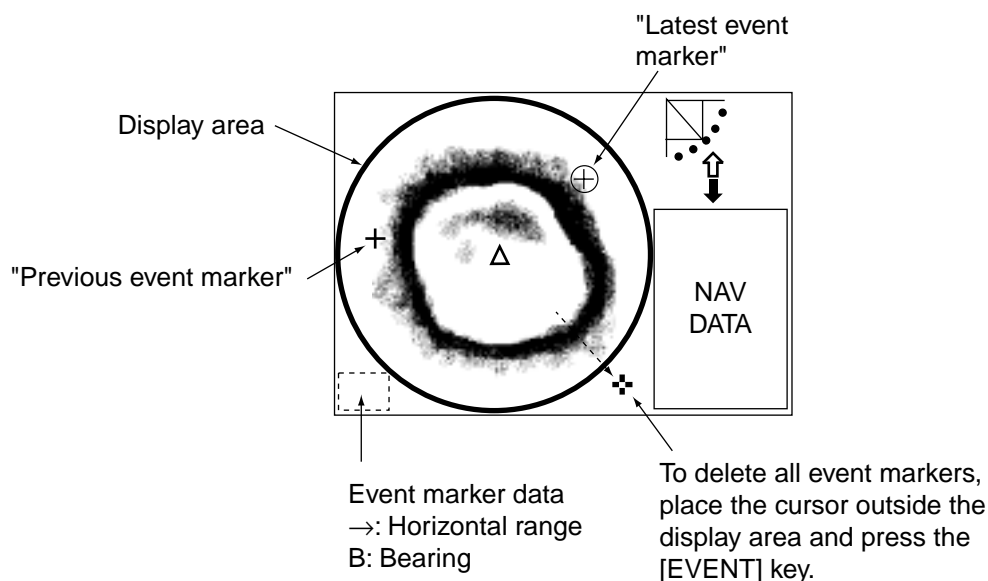

How to use the event marker

2.9.2 Deleting all event markers

All event markers can be erased from the screen as follows:

1. Operate the Omnipad to place the cursor outside the display area.
2. Press the [EVENT] key to show the following dialog box. Do the next step within four seconds; otherwise the dialog box will be erased.

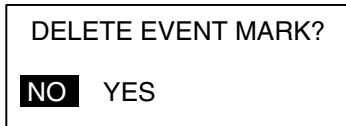

3. Press ► to choose YES and then press the [MENU] key. All event markers are then erased from the screen.

2.10 Depth and Horizontal Range Markers

The horizontal range, depth and bearing to a fish school can be measured by using the range and bearing markers.

1. Operate the Omnipad to place the cursor on the location desired.
2. Press the [R/B] key to display the range and bearing markers. Horizontal range, depth and bearing to the cursor location are shown at the bottom right-hand corner of the screen.
3. To erase the range and bearing markers, place the cursor at the intersecting point of the depth and horizontal markers or outside the display area and then press the [R/B] key.

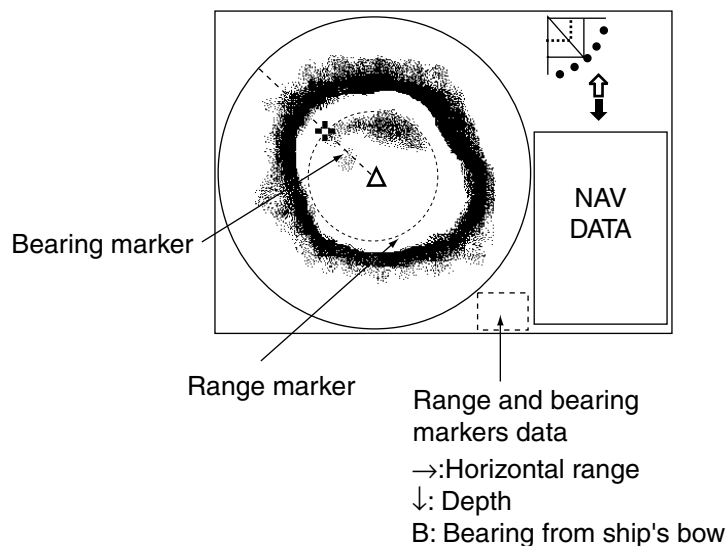

Range and bearing markers

2.11.2 Suppressing bottom tail

As described earlier, fish schools near the bottom are sometimes difficult to detect because you have to discriminate fish echoes from the bottom reflections. To discriminate fish echoes near the bottom, choose the short Tx pulselength on the COM1 menu to decrease the tail of bottom reflections.

1. Press the [MENU] key to open the menu.
2. Press ▲ to choose MENU and then press ◀ to choose the COM1 menu.
3. Press ▲ or ▼ to choose PULSELENGTH and then press ▶ to show the PULSELENGTH dialog box.

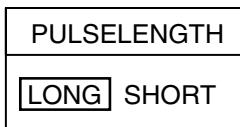

4. Press ▶ to choose SHORT. For long-range detection, be sure to return the setting to LONG.
5. Press the [MENU] key to register your selection and close the menu.

2.11.3 Displaying weak echoes clearly

Echoes from targets (such as the bottom or a fish) return to the transducer in order of the distance to them, and when their intensities are compared at the transducer face, those from nearer targets are generally stronger when their reflecting properties are nearly equal. The sonar operator will be quite inconvenienced if these echoes are directly displayed on the screen, since he won't be able to judge the actual size of the target from the size of echoes displayed on the screen. To overcome this inconvenience, use the TVG function. It compensates for propagation loss of sound in water: amplification of echoes on short range is suppressed and gradually increased as range increases, so that similar targets are displayed in similar intensities irrespective of the ranges to them.

The TVG also functions to suppress unwanted echoes and noise which appear in a certain range area on the screen.

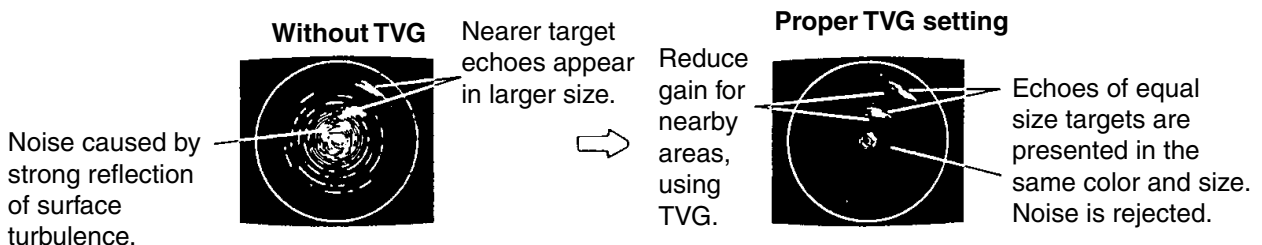

How TVG works

Note: Excessive TVG may eliminate short-range echoes.

To adjust TVG:

1. Press the [MENU] key to open the menu.
2. Press ▲ to choose MENU and then press ◀ or ▶ to choose HORZ.

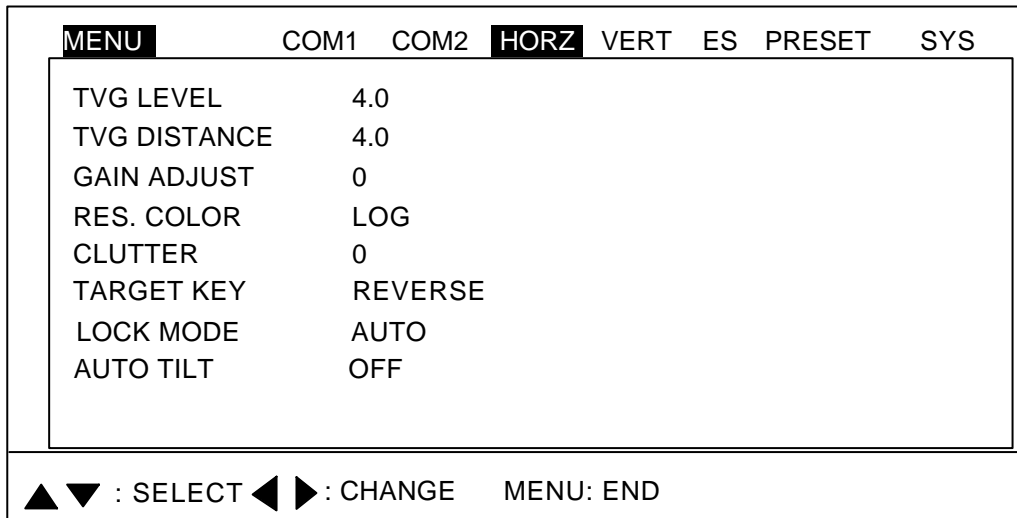

HORZ menu

3. Press ▲ or ▼ to choose TVG DISTANCE and then press ▶. The following dialog box appears.

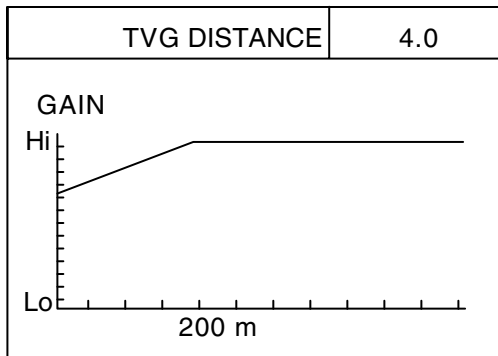

4. Press ◀ or ▶ to set TVG distance between 3.0 and 5.0 (130-320 m) to decrease amplification of echoes on short range. As a general rule, use a higher setting for low frequency transducer; a lower setting for high frequency transducer. The larger the figure the greater the distance at which TVG works. When you change a TVG setting (DISTANCE or LEVEL), the TVG line changes from solid to dashed; the solid line denotes current TVG setting.

TVG Distance Setting	0	0.5	1.0	1.5	2.0	2.5	3.0	3.5	4.0	4.5	5.0	10.0
Meters	3	8	20	40	60	100	130	160	200	250	320	1000
Feet	10	30	70	130	210	330	410	520	660	820	1040		3280
Passi/braza	2	5	10	20	40	60	80	100	120	150	180		600
Fathoms	2	5	10	20	40	60	80	100	110	140	170		550

2. HORIZONTAL MODE

5. Press the [MENU] key to register your selection and close the menu.
6. To suppress reflections from the sea surface or plankton, choose TVG LEVEL and then press ►.

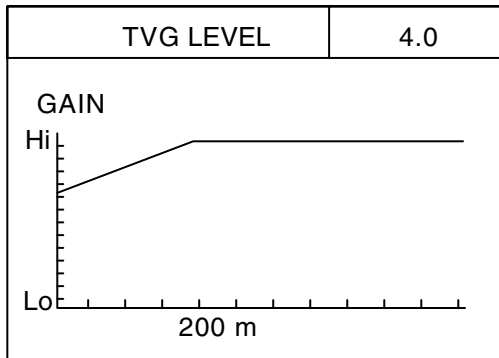

7. Press ◀ or ▶ to adjust TVG LEVEL, considering sea conditions. The setting range is 0 to 10, however a setting between 2.0 and 5.0 should provide satisfactory results. The higher the figure the less the gain over distance.
8. Press the [MENU] key to register your selection and close the menu.

Watch a distant fish echo which is approaching own ship. Observe the color of the fish echo while adjusting tilt angle so the fish echo is within the sounding beam. If the color and size of the echo stay the same as the echo approaches own ship, the TVG setting is proper. If the echo suddenly becomes smaller, the TVG level may be too high.

2.11.4 Erasing weak echoes

Weak echoes such as interference can be erased from the screen. This is useful when you want to observe a fish school echo.

1. Press the [MENU] key to open the menu.
2. Press ▲ to choose MENU.
3. Press ◀ or ▶ to choose COM2.

MENU	COM1	COM2	HORZ	VERT	ES	SHORT-CUT	SYS
DELETING TRACK NO WHITE MARKER OFF SIG LEVEL OFF COLOR 16 BKGD COLOR 2							
▲ ▼ : SELECT ◀ ▶ : CHANGE MENU: END							

COM 2 menu

4. Press ▲ or ▼ to choose SIG LEVEL.
5. Press ▶ to open the dialog box.

SIG LEVEL	OFF
OFF 1 14 	8-color display: OFF, 1-6 16-color display: OFF, 1-14
(OFF, 1-14)	

Signal level dialog box

6. Press ◀ or ▶ to choose echo color to erase. Pressing ▶ erases echoes from weak to strong in ascending order of strength. You can see which echo color is erased by watching the color bar.
7. Press the [MENU] key to register your selection and close the menu.

2.11.5 Enlarging fish echoes (horizontal expansion display)

Fish echoes may be enlarged by using the horizontal expansion display. Press the  key to show the horizontal expansion display. The direction of expansion depends on the train direction as shown in the table below.

Train center direction	Position after expansion	Remarks
318° – 42°	Moves to screen bottom	For viewing forward
48° – 132°	Moves to left side of screen	For viewing starboard side
138° – 222°	Moves to screen top	For viewing aft
228° – 312°	Moves to right side of screen	For viewing port side

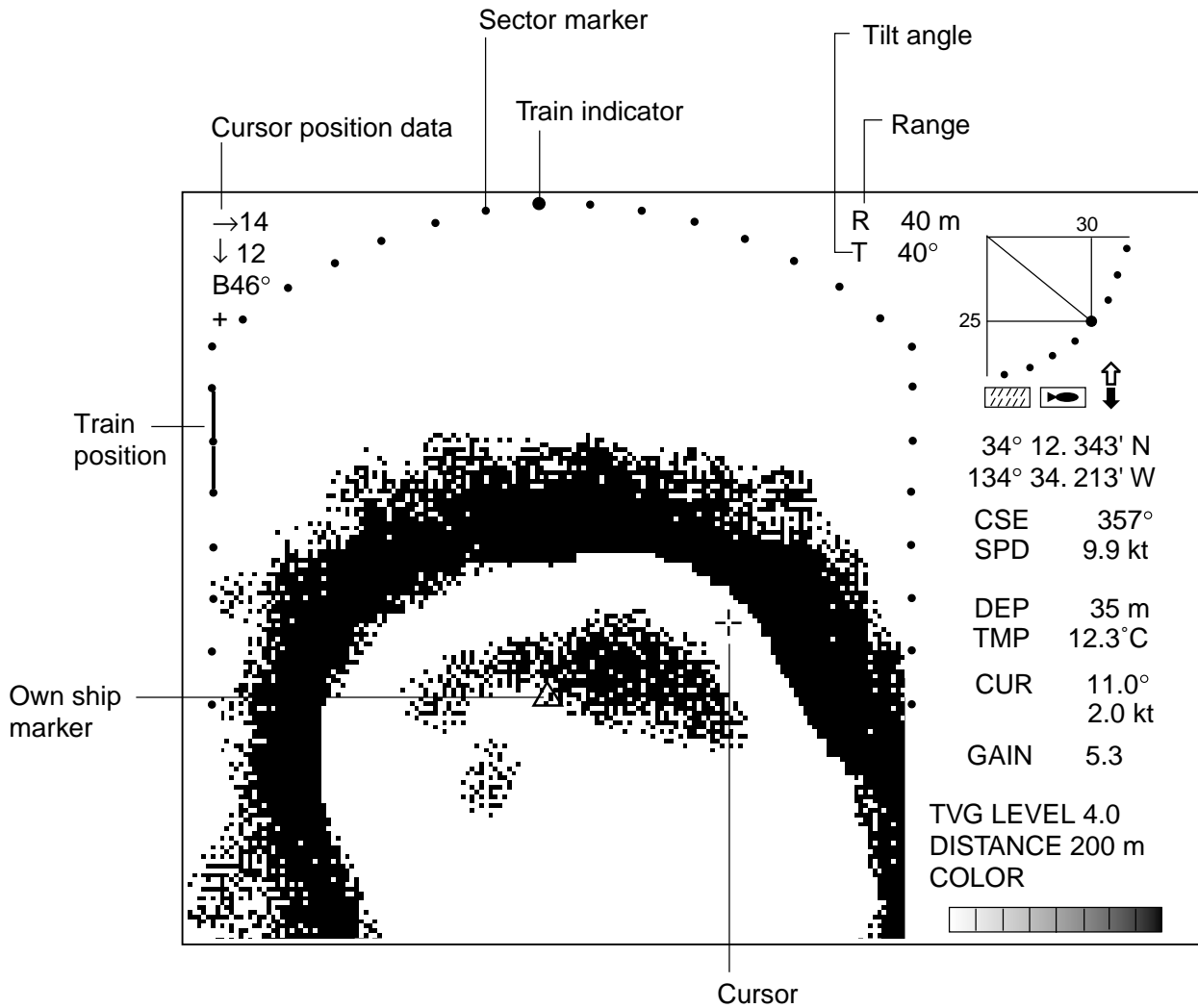

Horizontal expansion display

2.12 Target Lock

Three types of target lock modes are available.

Manual reverse: The transducer train direction is reserved manually. This is the default target lock function setting and it may be used in both horizontal and vertical scan modes.

Position: Tracks stationary position (such as a reef) using position data from a navigator. Available in the horizontal mode.

Echo: Tracks fish echo either manually or automatically. Available in the horizontal mode.

2.12.1 Choosing target lock mode

1. Press the [MENU] key to open the menu.
2. Press ▲ to choose MENU and then press ◀ or ▶ to choose the HORZ menu.
3. Press ▲ or ▼ to choose TARGET KEY.
4. Press ▶ to show the following dialog box.

TARGET KEY		
REVERSE	POS	ECHO

5. Press ◀ or ▶ to choose option desired.
6. Press the [MENU] key to register your selection and close the menu.

2.12.2 Manual reverse mode

The transducer train direction is reversed manually, thereby emphasizing possible fish echoes.

Note: This function is inoperative in the echo sounder mode. In the vertical scan mode the manual reverse mode is automatically chosen regardless of the setting in paragraph 2.12.1.

To activate the manual reverse mode:

1. Choose REVERSE following the procedure in paragraph 2.12.1.
2. Press the [TARGET] key to reverse the transducer train direction when a fish school appears. "REVERSE" momentarily appears at the screen top when the key is pressed and then the transducer train direction is reversed.

2.12.3 Position mode

This mode tracks a stationary position (such as a reef) using position data fed from a navigator.

Note 1: If the [TARGET] key is operated when using the horizontal/vertical scan combination mode, the train angle is automatically pointed toward target direction while the target lock marker is displayed. When target lock is canceled the previously used train angle is restored.

Further, vertical search (see paragraph 5.3.3) is conducted with the vertical scan mode settings of range, tilt and display range. Note that the horizontal range settings of the vertical scan mode cover the horizontal mode range.

Note 2: This mode requires position data. When there is no position data the message "NO POSITION DATA." appears for five seconds and tracking is automatically cancelled. Check the navigator.

Note 3: HORZ RANGE on the VERT menu cannot be adjusted while the position mode is active. Beeps sound when you attempt to change its setting.

Note 4: The tilt angle must be less than 75 degrees to use this feature.

To use the position mode:

1. Choose POS following the procedure in paragraph 2.12.1.
2. Use the Omnipad to choose the location to track.
3. Press the [TARGET] key.

The message "POS LOCK" appears momentarily at the screen top, the target lock marker is displayed at the cursor position and the target lock indicator appears at the top right-hand corner of the screen while tracking (with position data from external equipment) is occurring. If the position goes out of the display area, target lock is automatically cancelled and the target lock indicator and target lock marker disappear.

The train range is fixed at 48° and train and tilt are automatically adjusted to track the position selected. The [SECTOR], [TRAIN], [TILT], [RANGE] and [FULL/HALF] controls are inoperative during tracking. When you attempt to operate them the message "TARGET LOCKING NOW" appears, accompanied by the aural alarm.

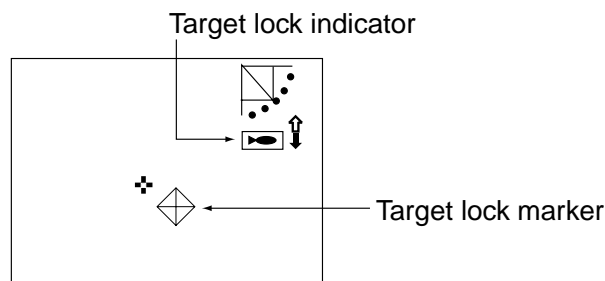

Target lock indicator

4. To turn off the target lock, press the [TARGET] key again. The message "LOCK END" momentarily appears, the target lock marker and the target lock indicator disappear and previously used sector, train and tilt settings are restored. Also, the latitude and longitude indication now shows current position.

2.12.4 Echo mode

The echo mode tracks a fish school, either automatically or manually. The default setting is automatic, and you can choose automatic or manual with “LOCK MODE” in the HORZ menu.

Automatic echo tracking mode

The automatic echo target lock function automatically tracks a fish school appearing in the operator-chosen target lock area. If the tracked fish school goes out of the area in the range direction, tracking is suspended until it or a new fish school comes into the area.

To use the automatic echo tracking mode:

1. Choose ECHO following the procedure in paragraph 2.12.1.
2. Set LOCK MODE to AUTO on the HORZ menu.
3. Press the [TARGET] key. The dialog box below appears at the screen center, the message “ECHO LOCK” appears for three seconds at the top of the screen, the target lock area appears in the current train area and the target lock indicator appears at the right-hand side of the screen.

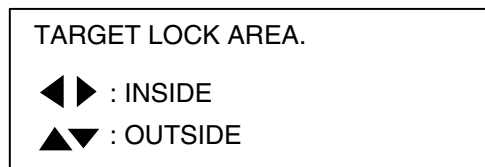

4. Use the [SECTOR] and [TRAIN] controls and the Omnipad to set the detection area. Do not include bottom echoes in the zone, so that target lock will not be activated by bottom echoes.

When a target of red or reddish-brown color is detected in the target lock area, the target lock indicator blinks and a buzzer sounds to call the operator’s attention.

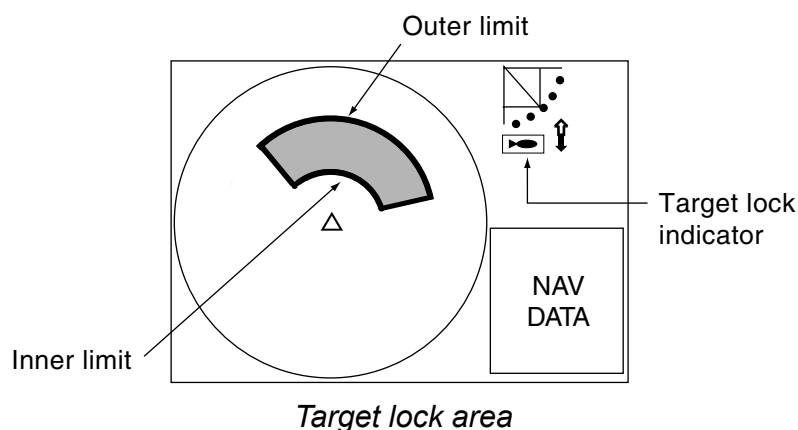

2. HORIZONTAL MODE

When the fish echo is lost the tilt angle is automatically changed as below to continue tracking the echo:

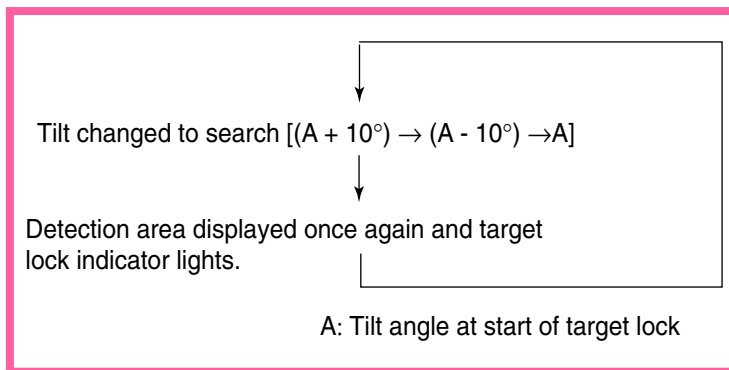

5. To turn off the target lock, press the [TARGET] key again. The message "LOCK END" appears for three seconds at the screen top, the target lock indicator disappears and operation continues with current train and tilt settings.

To use the manual echo tracking mode:

1. Choose ECHO following the procedure in paragraph 2.12.1.
2. Choose LOCK MODE to MANUAL on the HORZ menu.
3. Press the [TARGET] key when a wanted target echo appears.

The message "ECHO LOCK" appears along with the target lock indicator. Then, the transducer train direction is reversed and searching starts with the current tilt angle. When a target echo appears, the transducer train direction is again reversed automatically, the buzzer sounds and the target lock indicator blinks.

If the fish echo is lost, the tilt angle is automatically changed as below to continue tracking.

1. Tilt angle is changed by +10° (A+10°).
(A is the tilt angle used when tracking began.)
2. Tilt angle is changed by -20° (A-10°).
3. If the echo could not be found, tracking is cancelled and tilt angle A is restored.

4. To quit the target lock, press the [TARGET] key again. The message "LOCK END" appears momentarily.

2.13 Horizontal Menu Overview

This section presents an overview of the items on the HORZ menu.

1. Press the [MENU] key to open the menu.
2. Press ▲ to choose MENU and then press ◀ or ▶ to choose the HORZ menu.

MENU	COM1	COM2	HORZ	VERT	ES	PRESET	SYS
TVG LEVEL	4.0						
TVG DISTANCE	4.0						
GAIN ADJUST	0						
RES. COLOR	LOG						
CLUTTER	0						
TARGET KEY	REVERSE						
LOCK MODE	AUTO						
AUTO TILT	OFF						

▲ ▼ : SELECT ◀ ▶ : CHANGE MENU: END

HORZ menu

Horizontal menu description

TVG LEVEL: Compensates for propagation loss of sound in water. For further details, see paragraph 2.11.3.

TVG DISTANCE: Sets distance at which TVG works. For further details, see paragraph 2.11.3.

GAIN ADJUST: Adjust the gain here when there is disparity in gain level between the main and sub windows.

RES. COLOR: Sets transfer characteristics of input signal level versus display echo level. Echo strength is emphasized in order of CUBE, SQUARE, LINEAR, LOG, and you can observe the characteristics of each by watching the color bar as you change the setting.

LOG: Displays weak to strong echoes in their respective levels. This is the default setting, and is suitable for general use.

LINEAR: Downplays the weak echoes when compared with LOG. Effective for suppressing weak echoes such as plankton.

SQUARE: Strong echoes are emphasized more than in LINEAR.

CUBE: Strong echoes are emphasized even more than in SQUARE.

2. HORIZONTAL MODE

CLUTTER: Low intensity echoes, often caused by sediments in water, are painted on the screen as a large number or random dots. This noise can be suppressed. The higher the number (setting) the weaker the echoes which are erased.

TARGET KEY: Chooses target lock function among reverse, position and echo. For further details, see paragraph 2.12.

LOCK MODE: Chooses how to track fish echo in “echo” target lock, automatically or manually. For further details, see paragraph 2.12.

AUTO TILT: Turns automatic tilt on or off. The choices are $\pm 2^\circ$, $\pm 4^\circ$, $\pm 6^\circ$, and $\pm 10^\circ$. Automatic tilt adjusts the tilt angle in the following sequence:

$B \rightarrow (B-A) \rightarrow B \rightarrow (B+A) \rightarrow B \rightarrow (B-A) \rightarrow B \rightarrow (B+A) \dots$

B: Current tilt angle

A: Auto tilt setting

For example, the tilt angle is 30° and the automatic tilt setting is 4° . Then, the tilt angle is changed in the following sequence: $30^\circ \rightarrow 26^\circ \rightarrow 30^\circ \rightarrow 34^\circ \rightarrow 30^\circ \rightarrow 26^\circ \rightarrow 30^\circ \rightarrow 34^\circ \dots$

2.14 Interpreting the Horizontal Display

This section provides information necessary for interpreting the horizontal display.

2.14.1 How the horizontal mode picture is painted

As shown below, the search beam is emitted from the soundome at a certain tilt angle. The information (target echoes) obtained by this beam is displayed in 6° (or 12°) sectors on the screen. With training through the entire area, a large cone shape area is formed, providing continuous pictures on the display.

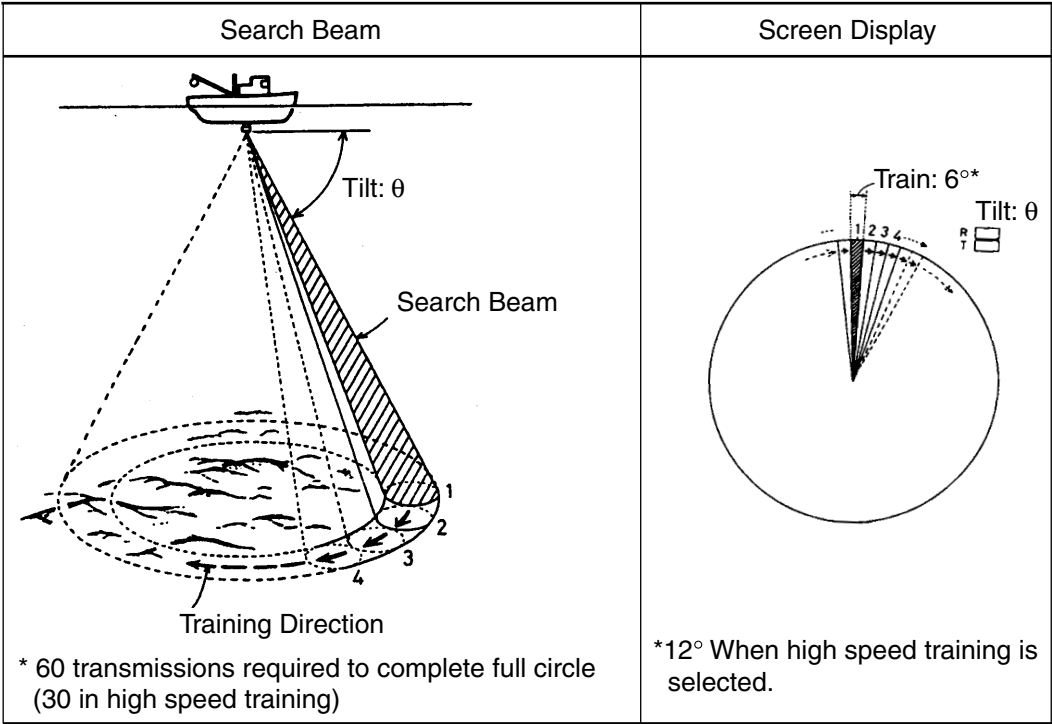

How the horizontal mode picture is painted

2.14.2 Sample echo displays

Bottom echoes

When the tilt angle is changed, the bottom echo illustrated below will appear on the display. When the tilt is decreased (toward 0°), the bottom trace becomes wider and weaker. By observing the bottom condition on the display, you can prevent damage to the net.

(A) Flat bottom

Tilt angle: 10° to 15°

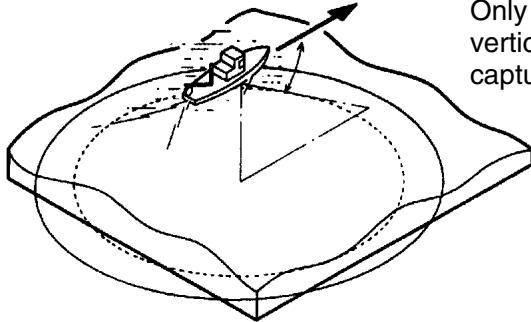

Decreased tilt angle
Only half of
vertical beam width
captures the bottom.

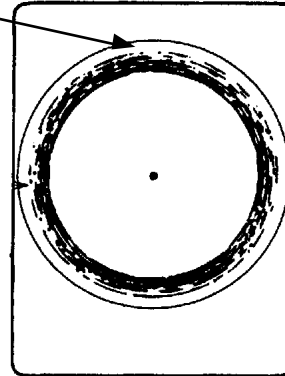

(B) Flat bottom

Tilt angle: 20° or more

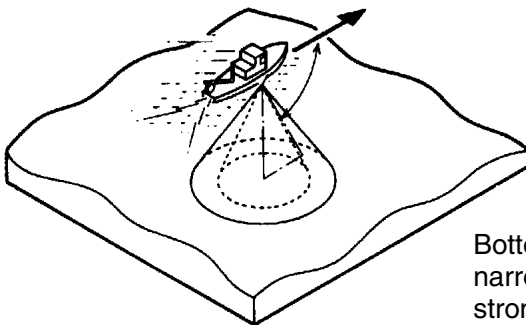

Bottom is displayed
narrower and in
stronger colors when
compared to (A).

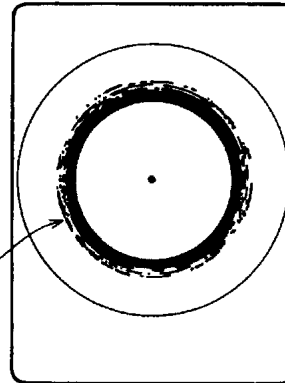

(C) Sloping bottom

Tilt angle: 20° or more

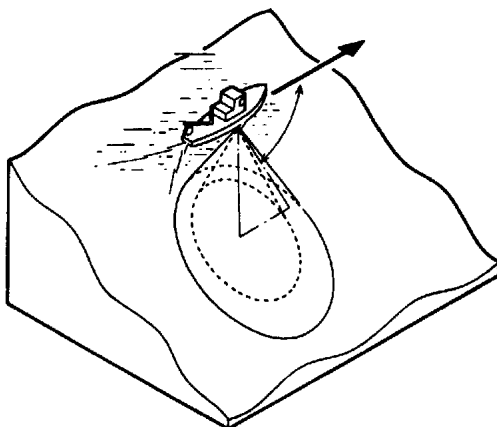

Shallow bottom
is displayed in
a strong color
and with a
short tail.

Bottom

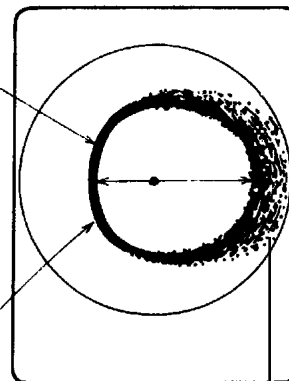

The deeper, sloping
bottom echo is displayed
in a weak color and
with a long tail.

Bottom echoes

Fish schools

A fish school appears as a mass of echoes on the screen. The color of the mass shows the density of fish schools on the sonar beam. To find distribution and center point of a fish school, try several different tilt angles.

(A) Sea surface fish
Tilt angle: 0° to 10°

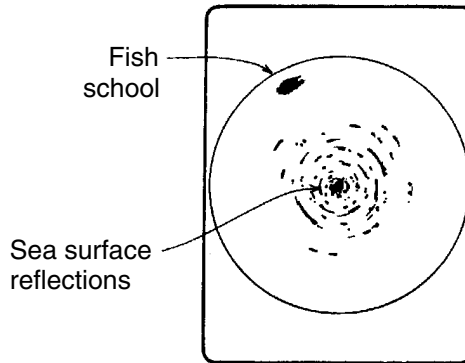
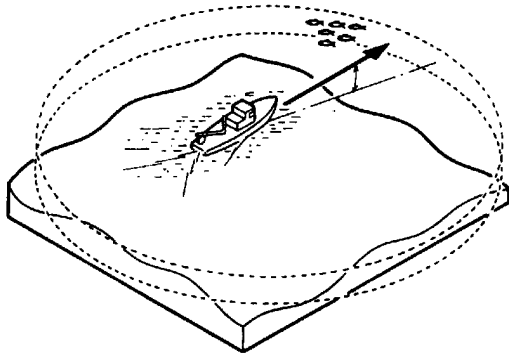

Bottom echo not displayed because of decreased tilt angle. Sea surface reflections are present.

(B) Midwater, bottom fish Tilt angle: 30° or more
Fish echo which appears before bottom can be detected.

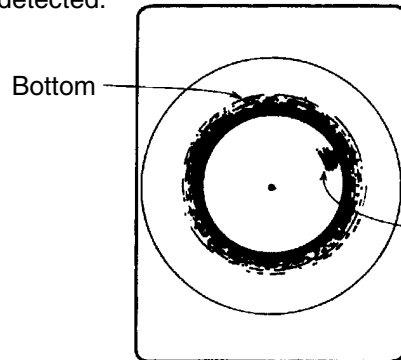
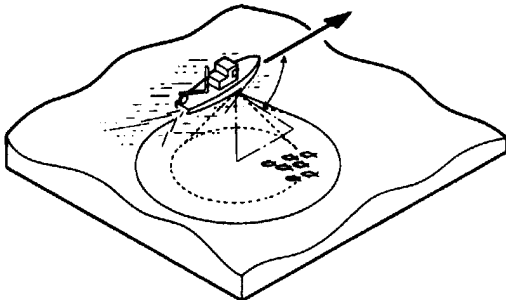

Fish school
Large midwater fish school is present.

Tilt angle: 0° to 20°
Fish echo which appears together with or after bottom can be detected.

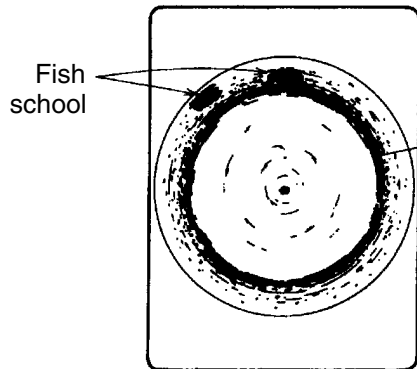
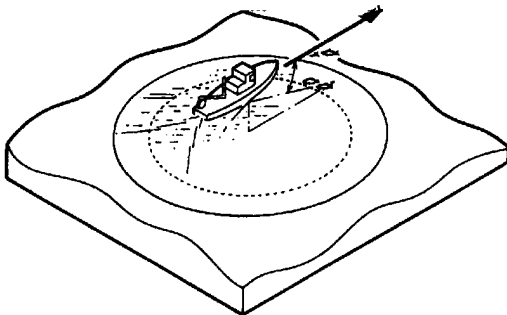

When the tilt angle is shallow, the reflection echo from bottom is weak and the fish echo which appears from bottom is easy to find.

Fish schools

2. HORIZONTAL MODE

Sea surface reflections

To reduce sea surface reflections, set the tilt angle to 5° or lower, so the upper edge of the sonar beam does not hit the sea surface, or adjust TVG. When a decreased tilt angle is used, sea surface reflections cover a large area as illustrated below.

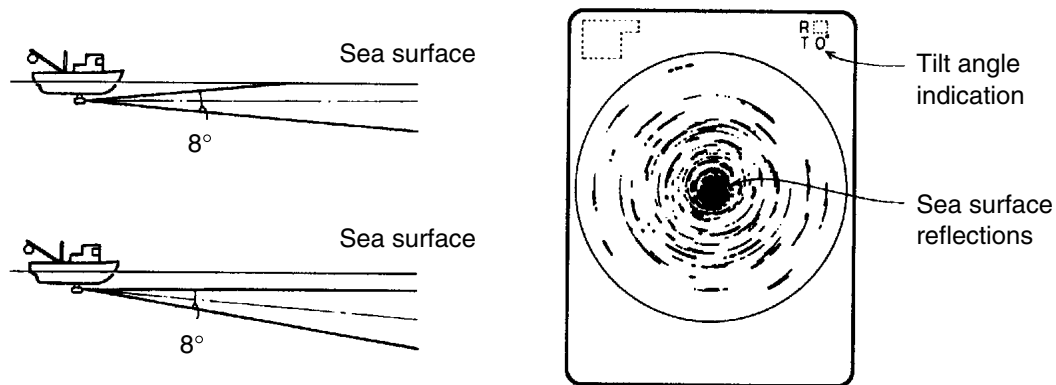

Sea surface reflections

Wake

A wake produced by own ship or another ship can be a strong reflecting object when a decreased tilt angle is used. As the wake appears as a thick continuous line, it can be easily distinguished from a fish school. A wake contains many air bubbles which attenuate ultrasonic energy, making it difficult to sound beyond the wake.

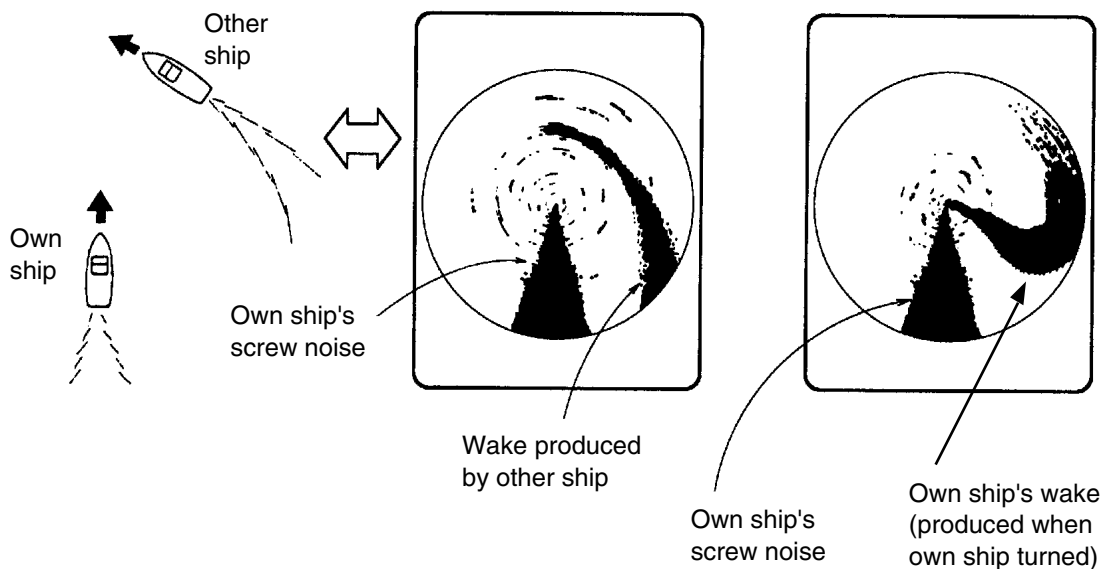

Wake

Sidelobe echo (false echo)

An ultrasonic wave is emitted in the direction set by the [TILT] control (main beam), however there are some emissions outside the main beam. These are called sidelobes. The energy of the sidelobe is fairly weak but when the water is comparatively shallow and the bottom is rocky and hard, strong signals are detected by the sidelobe. These are represented on the display as a false echo as shown below.

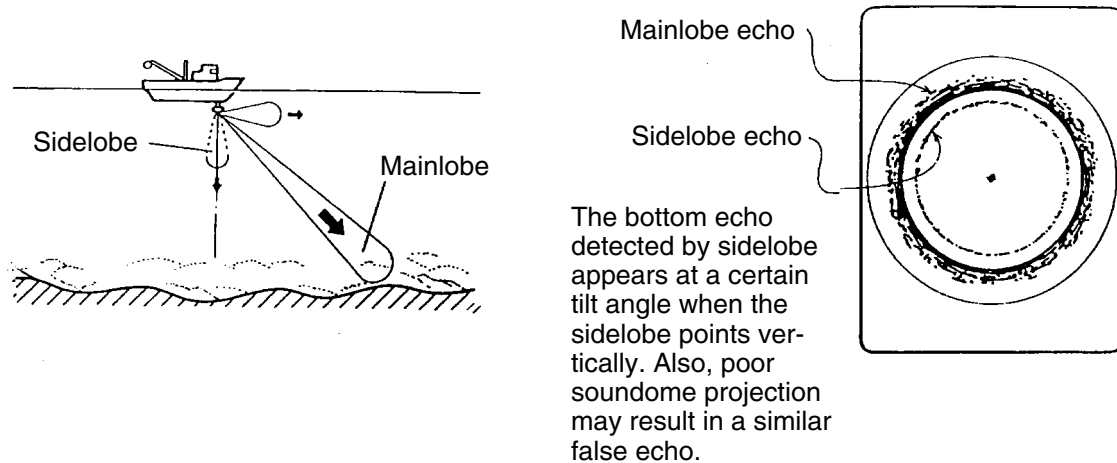

Sidelobe echoes

Noise and interference

When the fishing ground is crowded with many fishing boats, the sonar is subject to interference from ultrasonic equipment (echo sounder or sonar) on other boats as well as those on own ship.

For instance, interference from the sonar on other boats will show itself on the display as in (A) in the figure below. This interference can be suppressed by changing the Tx rate on the COM1 menu. Noise from marine life shows itself on the displays as in (B) in the figure below. This type of noise can be suppressed with the interference rejector on the COM1 menu.

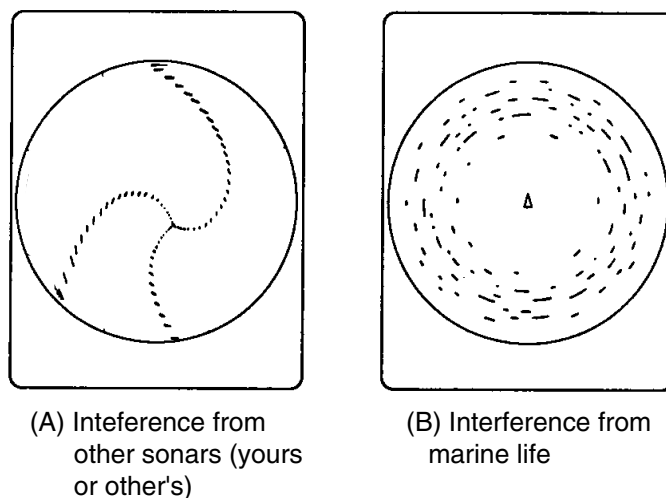

Noise and interference

2.14.3 Combination display examples

Horizontal/history display

Press the  key to display the horizontal/history display.

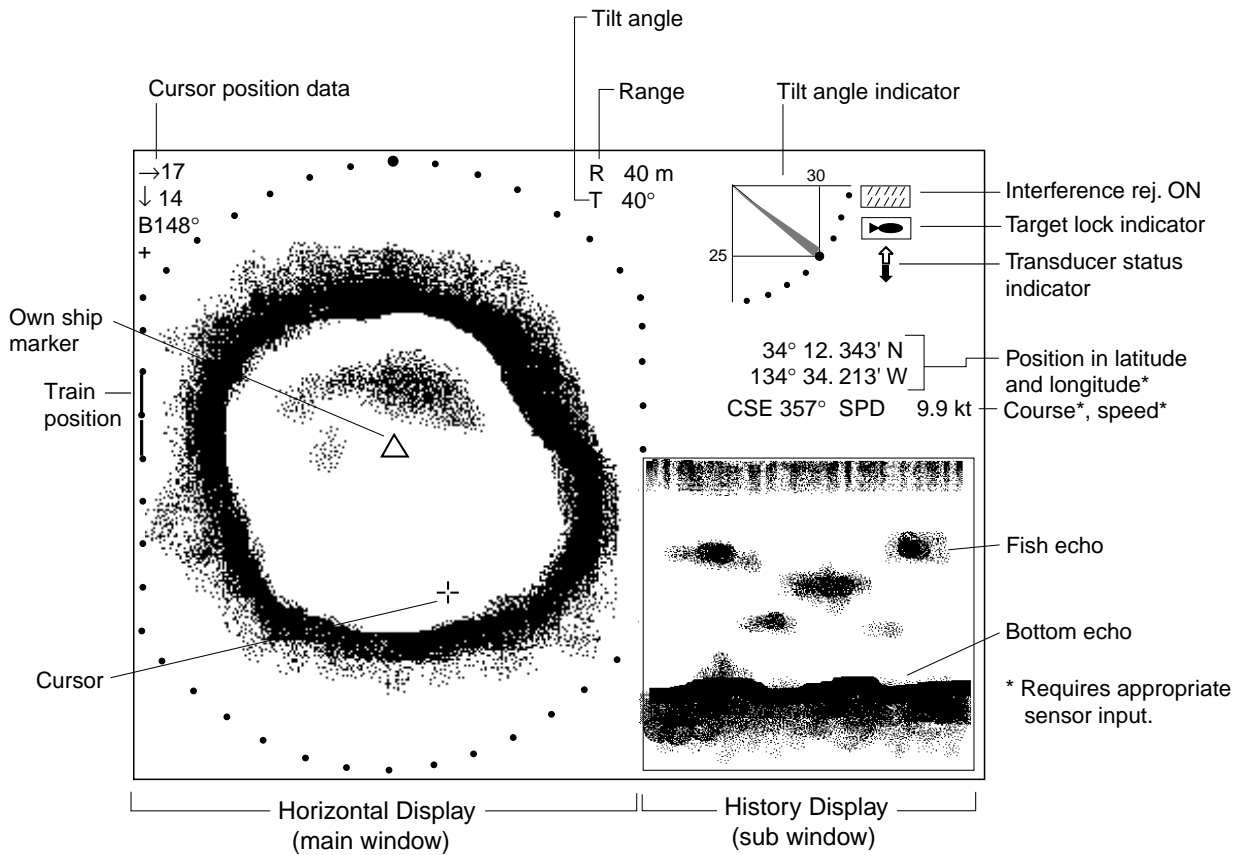

Horizontal/history display

The horizontal display appears in the main window; the history display in the sub window. The length of the picture displayed in the history display is equal to about four full-circle pictures. Thus the history display lets you observe the history of fish movement and distribution. It is also useful for detecting bottom fish, reefs and sunken vessels. Note that the history display cannot be adjusted.

Horizontal/video plotter display

Press the  key to display the horizontal/video plotter display.

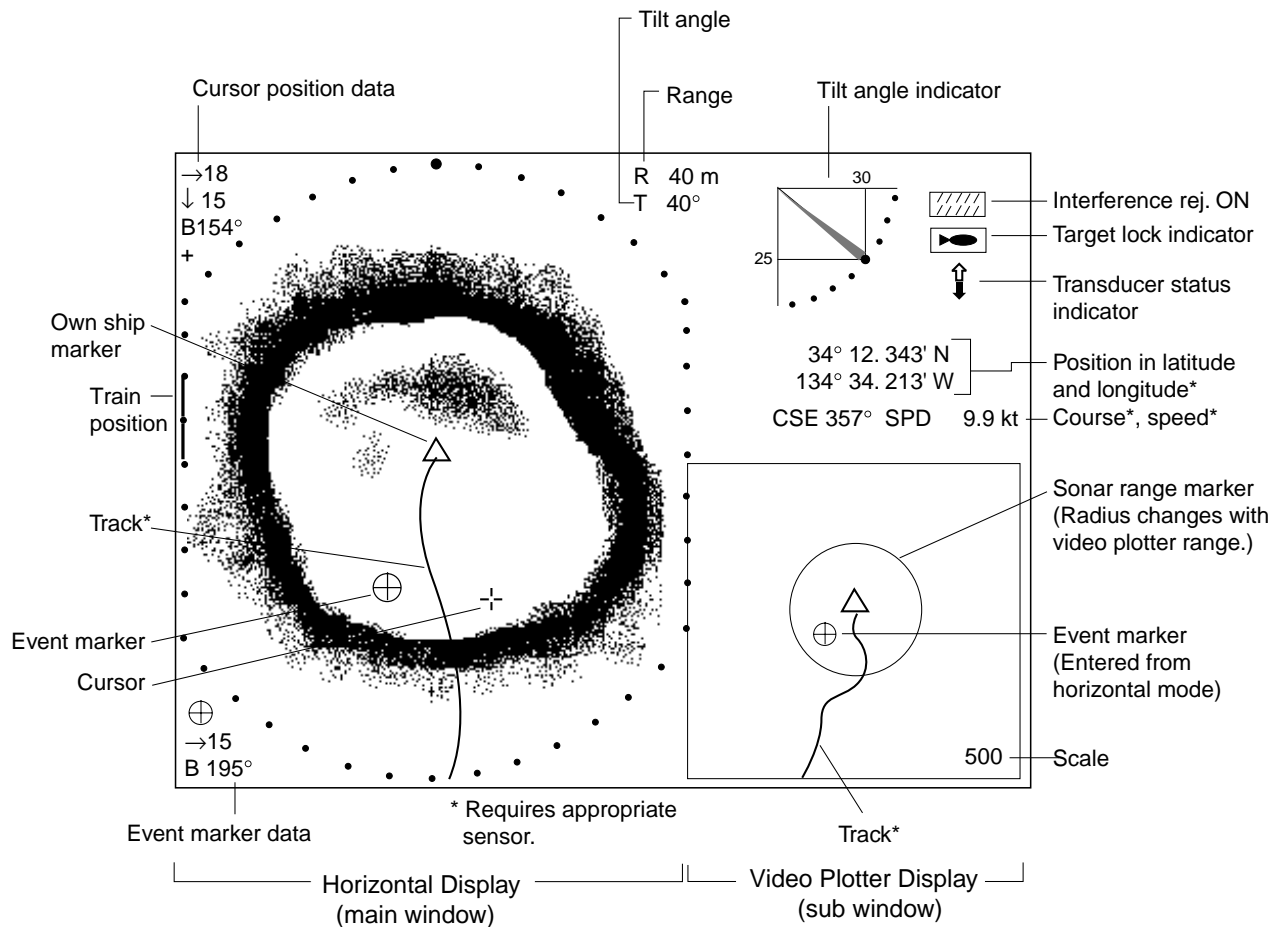
***Horizontal/Video Plotter display***

The horizontal display appears in the main window; the video plotter display, which mainly traces ship's track, in the sub window. Compared to the horizontal display the video plotter's range is much longer. For example, an event marker entered on the horizontal display disappears from that display when it goes out of the current range. However, it remains on the video plotter display for a much longer time when a long range scale is used. This can be useful when you want to return to the location marked with an event marker. To show track on the horizontal display the tilt angle must be less than 75 degrees.

You may switch control between the horizontal display and the video plotter display with the [MAIN/SUB] key. The message MAIN WINDOW CONTROLLABLE or SUB WINDOW CONTROLLABLE appears with each pressing of the key. A red rectangle circumscribes the sub window when it is selected. With the video plotter display selected you may change its range with the [RANGE] control.

Note: Controls other than RANGE may only be operated from the main window. When you attempt to operate them when the sub window is selected the message SELECT MAIN WINDOW appears.

2. HORIZONTAL MODE

Horizontal/strata display

Press the  key to display the horizontal/strata display.

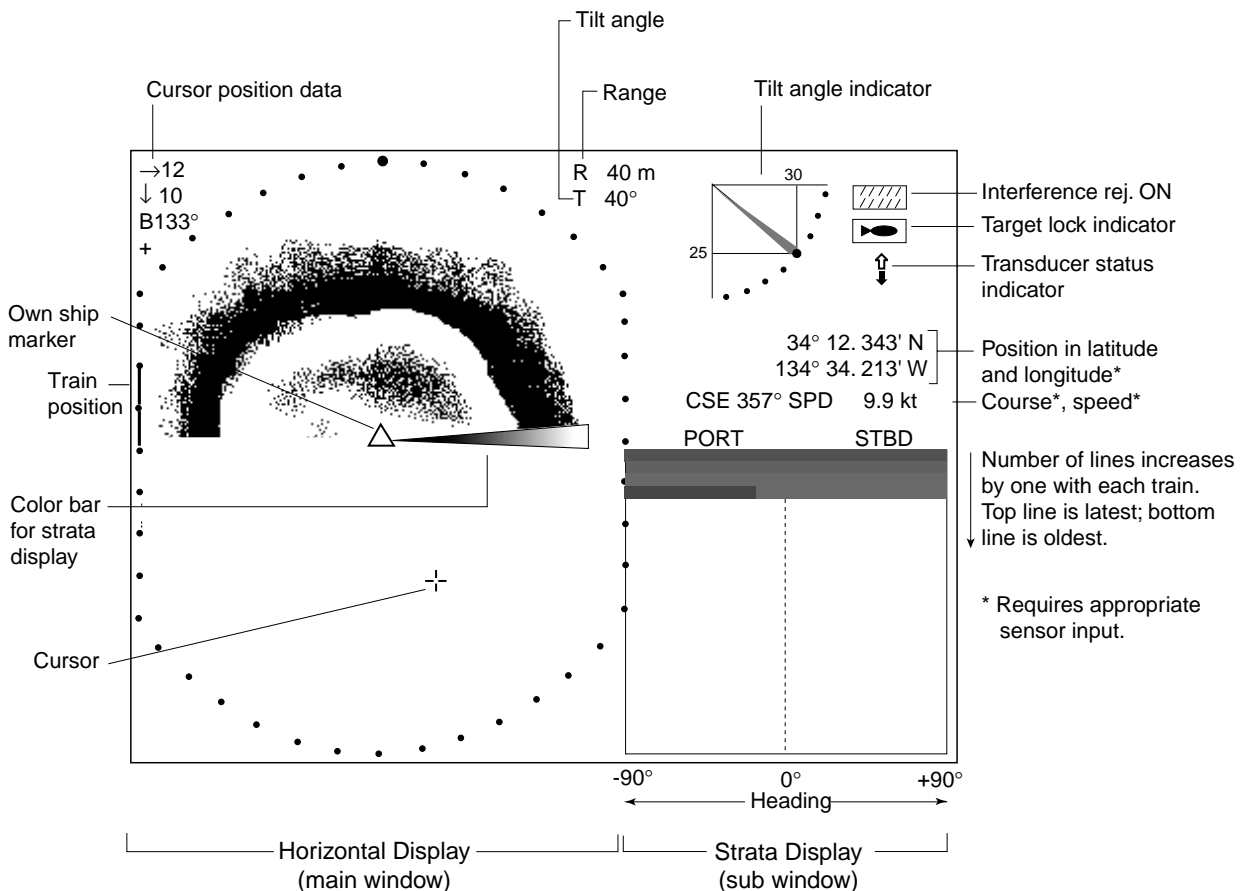

Horizontal/Strata display

The horizontal display appears in the main window; the strata display in the sub window. The strata picture shows bottom undulations in different colors. This is useful in bottom trawling for avoiding obstructions which may damage the net.

Coverage for the horizontal mode is 360° picture, and for the strata display it is maximum 90° from port to 90° starboard.

The strata display may be adjusted with the [RANGE] and [SECTOR] controls. Press the [MAIN/SUB] key to choose the main or sub window. The message MAIN WINDOW CONTROLLABLE or SUB WINDOW CONTROLLABLE appears with each pressing of the key. A red rectangle circumscribes the sub window when it can be controlled.

Color bar for the strata display

The depth of the bottom each in all directions is displayed in the sub window, in the colors set by the color bar for the strata display. The color bar for the strata display shows search angle range below 336 degrees.

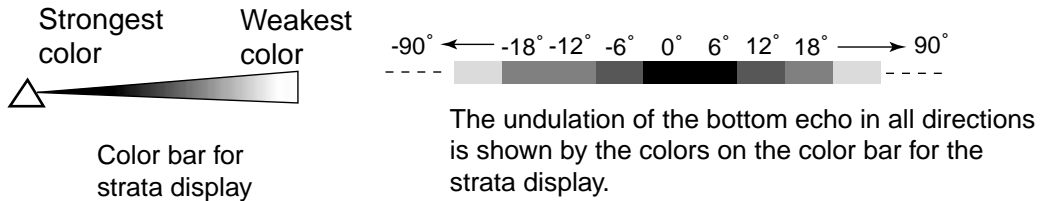

The position of the weakest echo can be changed with the [RANGE] control, and the width of each color on the color bar for the strata display with the [SECTOR] control. 25 and 13 steps are available, respectively.

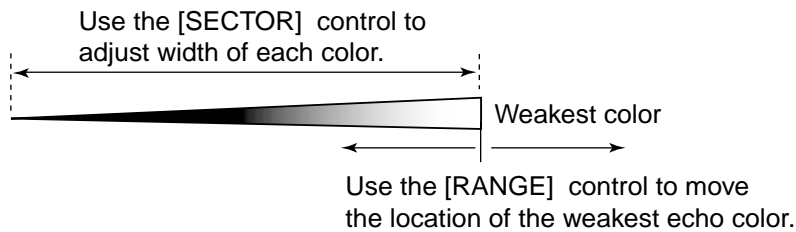

Note: TILT, TRAIN, FULL/HALF, FAST SCAN, R/B, EVENT, TARGET, CUSTOM MODE controls may only be operated from the main window. When you attempt to operate them from the sub window the message "SELECT MAIN WINDOW." appears for about four seconds.

Flat bottom and strata display

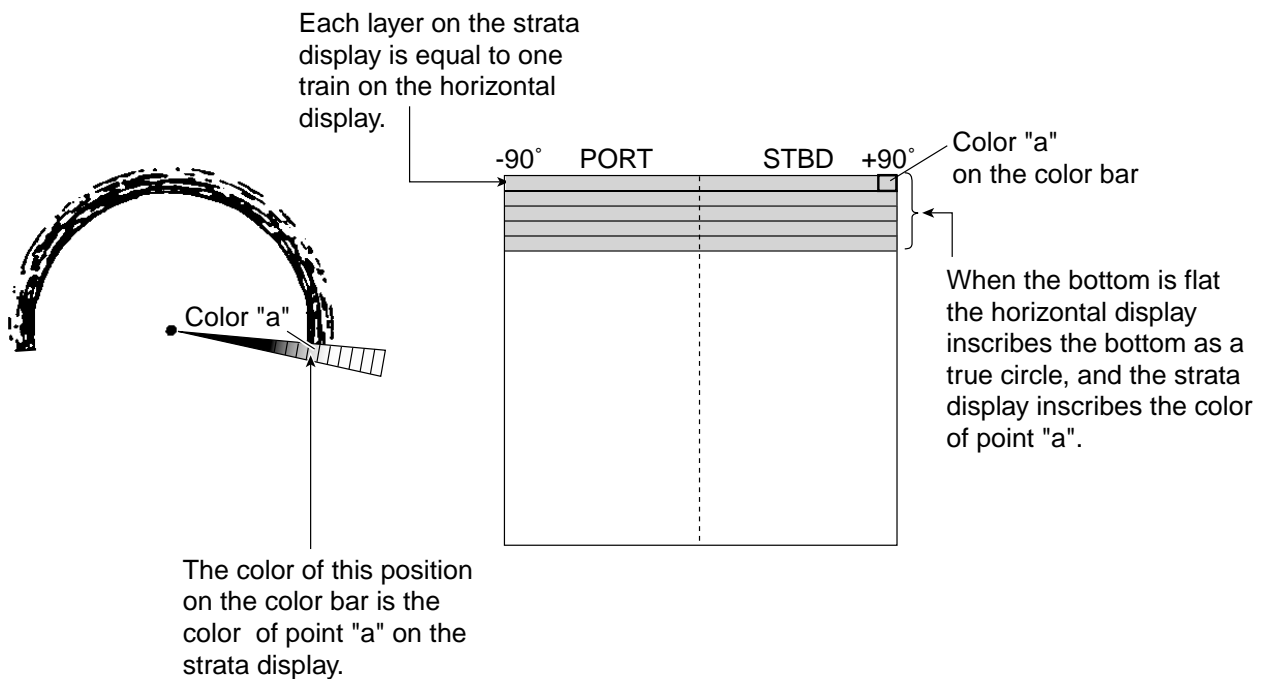

Flat bottom and strata display

2. HORIZONTAL MODE

Projection in fore direction and strata display

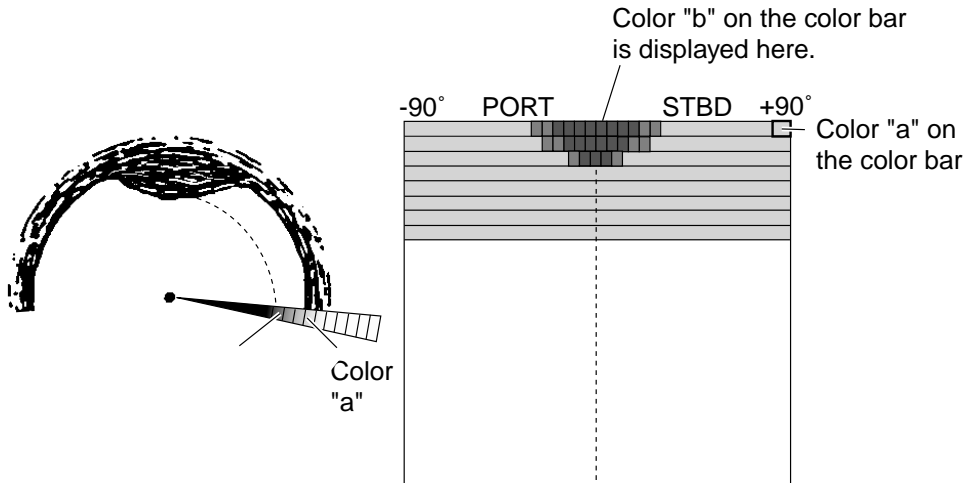

Projection in fore direction and strata display

Depth gradually becoming shallower in fore direction and strata display

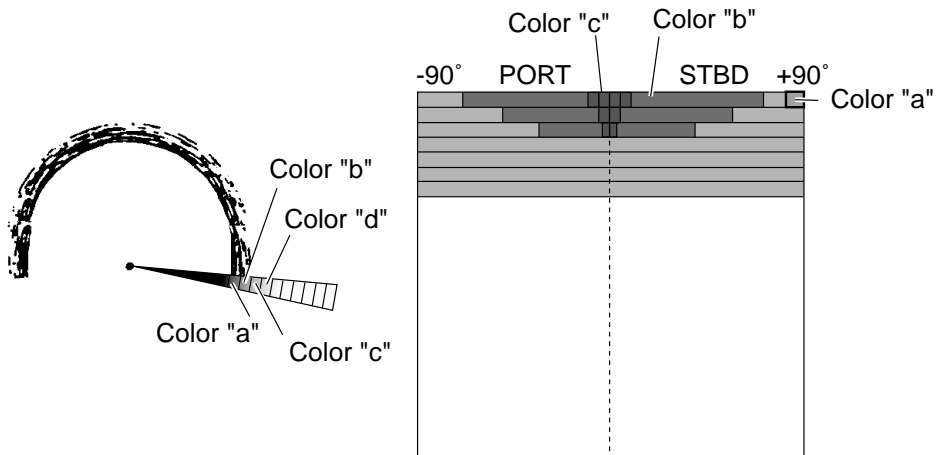

Depth gradually becoming shallower in fore direction and strata display

Depth gradually becoming deeper in fore direction and strata display

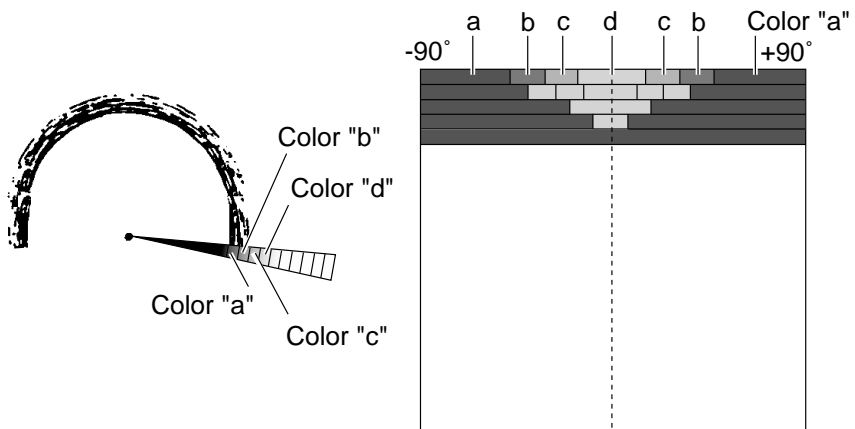

Depth gradually becoming deeper in fore direction and strata display

3. VERTICAL SCAN MODE

3.1 Operational Overview

The figure below shows the typical vertical scan mode operating sequence.

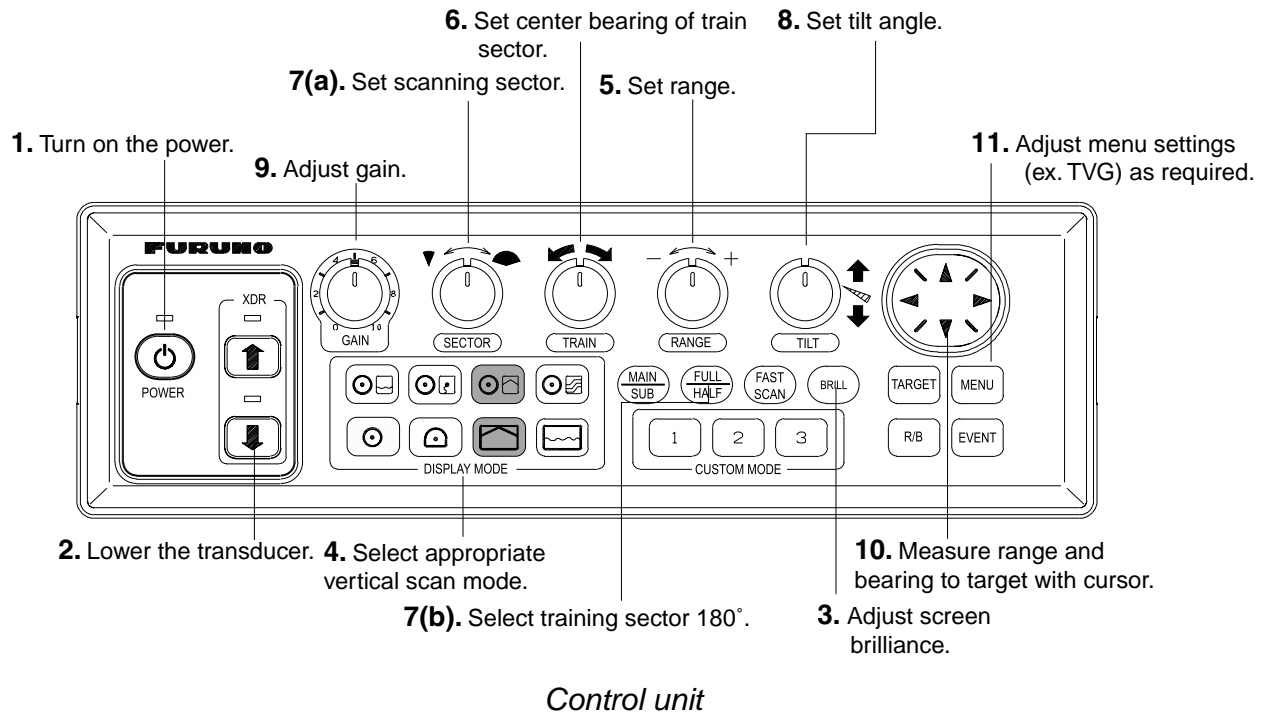

3.2 Displaying Vertical Scan Mode Display

3.2.1 Typical vertical scan mode display

Press the  key to show the vertical scan mode display.

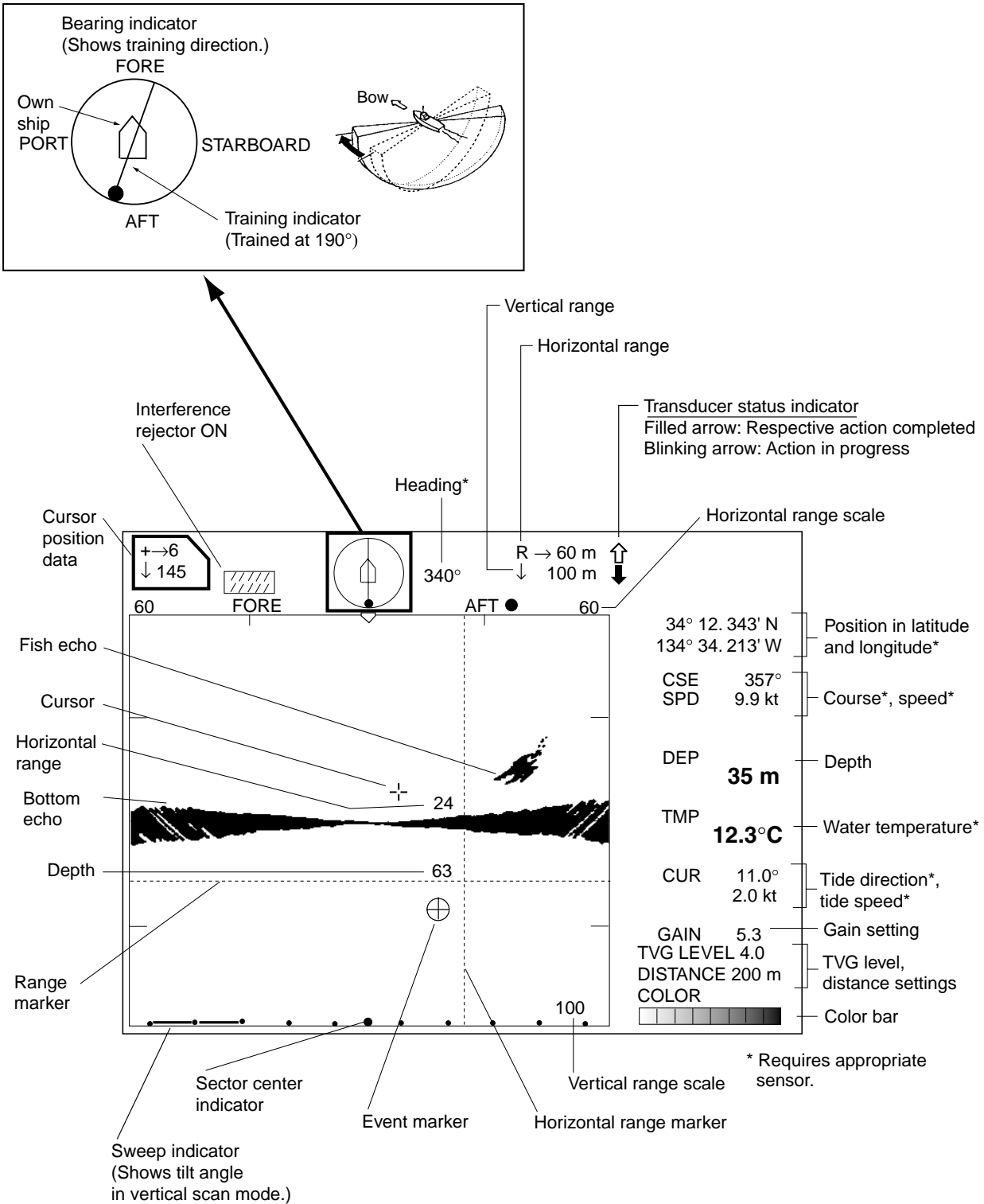

Typical vertical scan mode display

3.2.2 How the vertical scan picture is painted

The sounding beam is emitted and the information (target echoes) obtained by the reflected echo appears in the corresponding sector as it appears on the horizontal mode. The difference is that the training is performed only in vertical direction. It forms a sounding area of a half-circle (like a slice of watermelon) to observe a vertical section of underwater conditions.

Note: The tilt mechanism has a 90° range of movement. To paint the full 180° area, therefore, the transducer is first trained through the left half (90-180°) of the area followed by the right half (0-90°). Approximately two seconds are required to rotate the transducer in the opposite direction before it begins training through the right or left half.

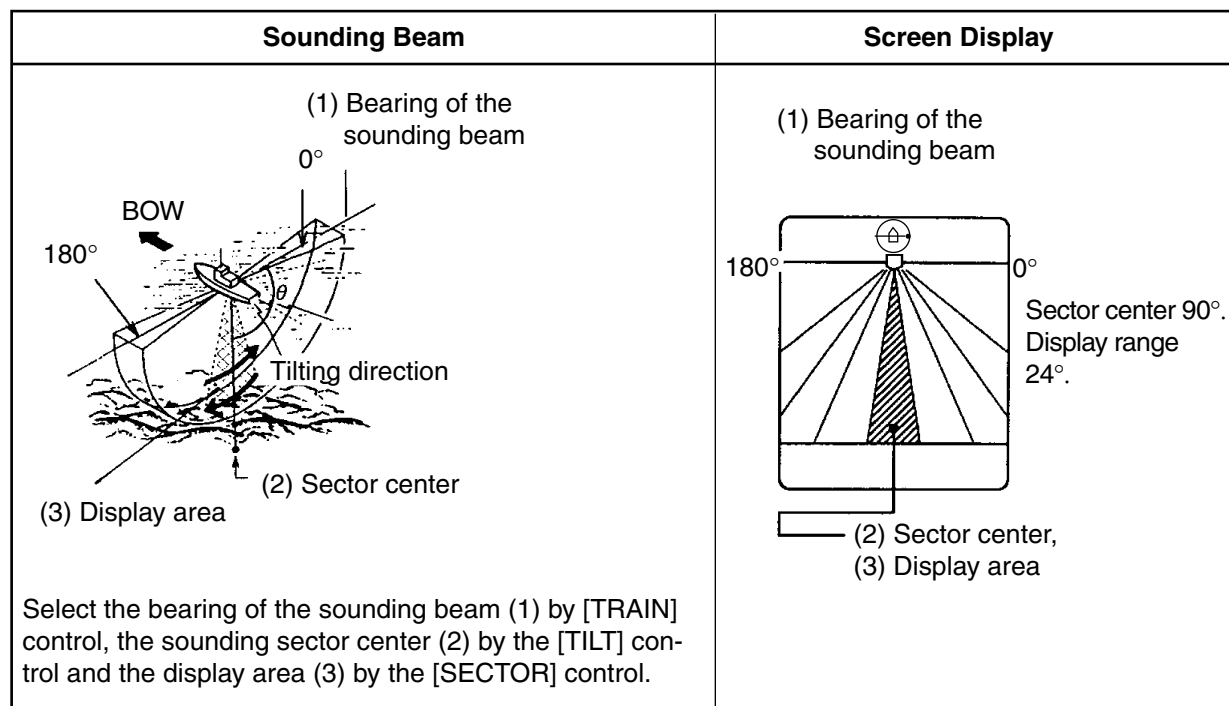

How the vertical scan mode picture is painted

3. VERTICAL SCAN MODE

3.2.3 Horizontal/vertical scan display

Press the  key to display the horizontal/vertical scan display.

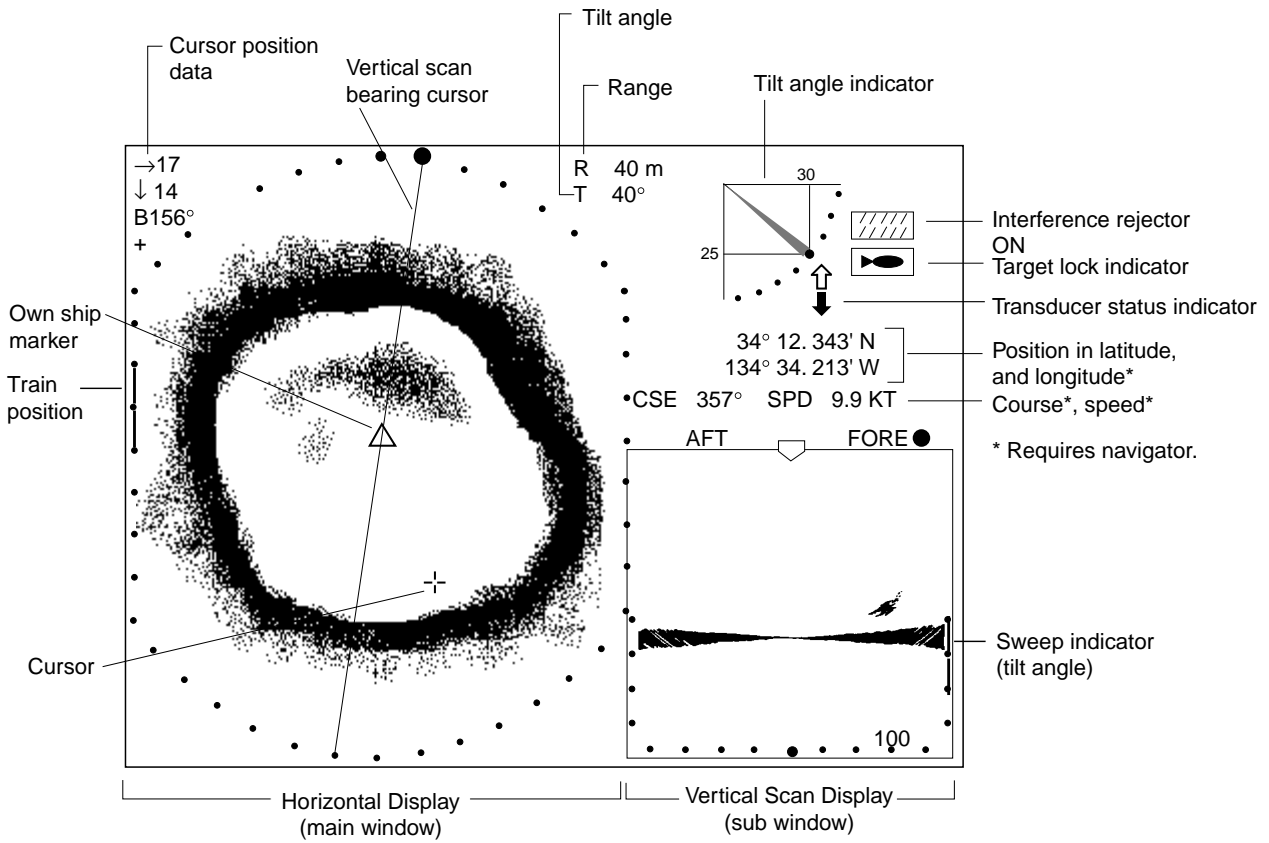

Horizontal/vertical scan display

The size of the vertical scan and horizontal displays and the location of the vertical scan display may be changed as desired. Press the  key to change the arrangement as in the figure below.

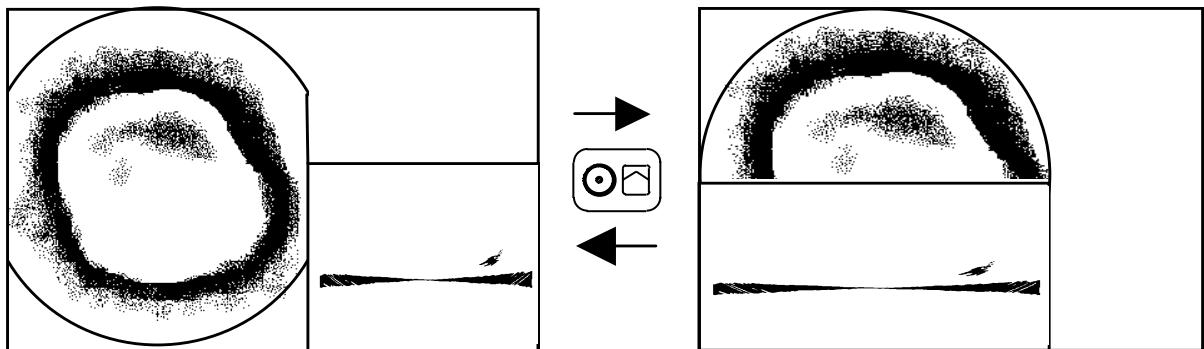

The displays are independent of each other so you can adjust them as desired. Press the [MAIN/SUB] key to choose the window to adjust. Each press of the key momentarily displays MAIN WINDOW CONTROLLABLE or SUB WINDOW CONTROLLABLE at the top of the screen to let you know which window may be adjusted. A red rectangle circumscribes the sub window when it is selected. The following controls are operative from either window: SECTOR, TRAIN, RANGE, TILT, FAST SCAN, FULL/HALF and CUSTOM MODE.

Note: R/B, EVENT or TARGET controls may only be operated from the main window. When you attempt to operate them when the sub window is selected the message SELECT MAIN WINDOW appears.

TRAIN control

For horizontal display: Sets training center direction.

For vertical scan display: Sets direction of bearing cursor shown on the horizontal mode display.

SECTOR control

For the vertical scan display: When the display sector is 6° (minimum), the tilt angle of the horizontal and vertical scan modes are interlocked and each transmission on the horizontal display is reflected on the vertical scan display. The message TILT ANGLE MONITOR WINDOW momentarily appears on the screen and the vertical bearing cursor disappears.

Note: Only the [SECTOR] control may be operated in this condition.

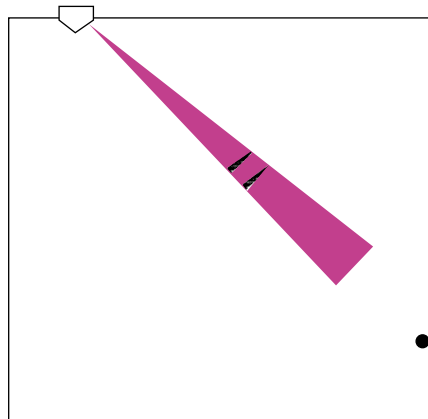

3.3 Choosing the Range

The [RANGE] control chooses the detection (display) range, in 15 settings. Choose the range according to either the fish species being searched or the depth desired. Each time the control is operated the newly chosen range briefly appears in large characters at the screen top. Range is permanently displayed at the top right-hand corner of the screen.

Default vertical scan mode range settings

Unit	1	2	3	4	5	6	7	8	9	10	11	12	13	14	15
Meters	10	20	30	40	60	80	100	120	160	200	250	300	400	500	600
Feet	30	60	90	120	150	200	250	300	400	500	600	800	1000	1500	2000

Note 1: Unit of range measurement may be chosen from among meters, feet, fathoms, passi/braza and Hiro (Japanese) with UNIT on the SYSTEM SETTING 1 menu. For further details, see UNIT in paragraph 5.4.2.

Note 2: Ranges may be freely preset as desired. For further details, see paragraph 5.4.5.

3.4 Choosing Train Center

The [TRAIN] control determines the bearing of the vertical scan beam, from 0° to 180°. Bearing of beam position can be found by observing the train indicator.

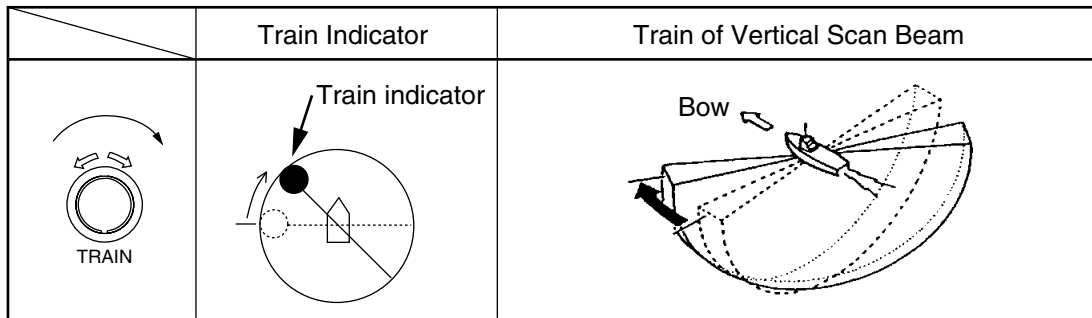
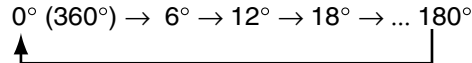

Train indicator

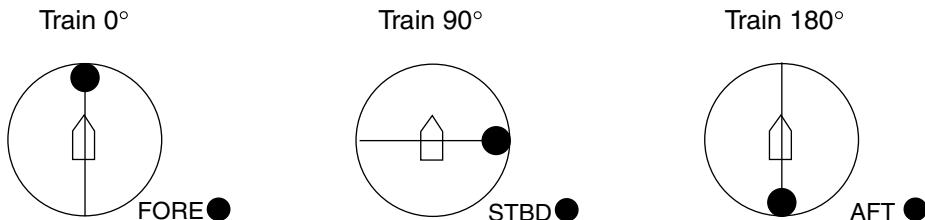

Train indicator and display

3.5 Choosing Display Sector

Sector means the width of the transducer training, from 6° to 180°.

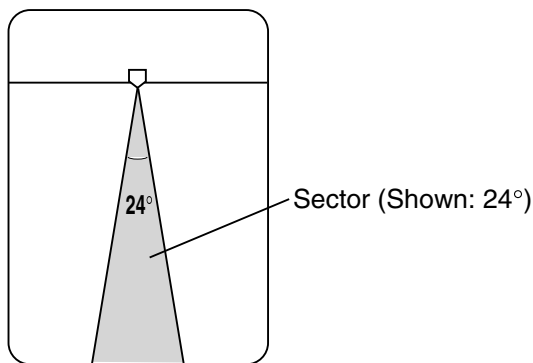

Sector

The [SECTOR] control chooses the training area among the sixteen positions shown in the table below. Clockwise rotation of the control increases the sector width; counterclockwise rotation decreases it.

	1	2	3	4	5	6	7	8	9	10	11	12	13	14	15	16
Sector width (°)	6	12	24	36	48	60	72	84	96	108	120	132	144	156	168	180

One-touch selection of 180° sector

1. Press the [FULL/HALF] key. A half-circle display of 180° is presented, and “FULL” momentarily appears at the top of the display.
2. Press the [FULL/HALF] key again, and a 120°-sector display is presented, and 120° momentarily appears at the top of the display.

Note: Operating the [SECTOR] control after step 1 in the procedure above will display the 180° sector at the next pressing of the [FULL/HALF] key.

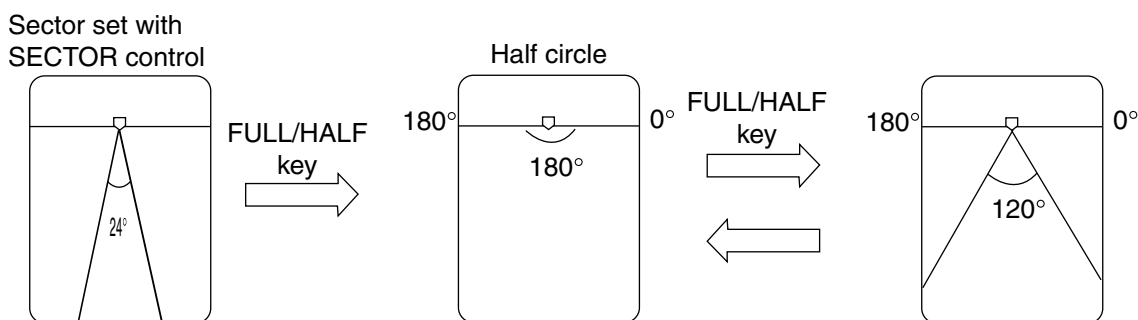

How the FULL/HALF key works

3.6 Choosing Sector Center

The center direction of the sounding beam in the vertical direction can be changed with the [TILT] control. The setting range is 0° to 180° in increments of 6°. Choose the setting which places the sector center in the middle of the detection range.

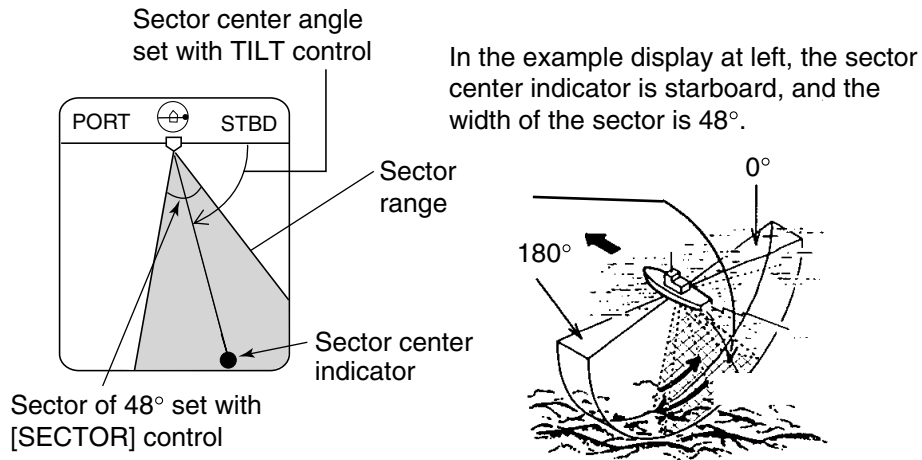

Sector center

Automatic shifting of own ship position

Own ship position on the screen is automatically shifted either rightward or leftward according to the direction of the sector center and display sector width.

The figure below shows the own ship position has been shifted rightward on the screen to provide the wider view at the port side.

- Sector center 0° to 60°: Own ship position shifted to port side
- Sector center 66° to 114°: Own ship position shifted to center
- Sector center 120° to 180°: Own ship position shifted starboard

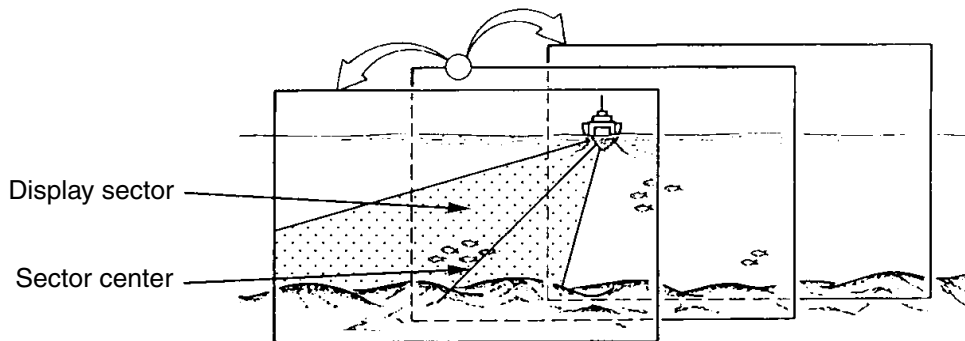

How automatic shifting works

3.7 Choosing the Tilt Speed

The [FAST SCAN] key chooses the tilt speed; that is, the stepping angle at which the transducer scans. Two choices are available, 3° (normal speed) and 6° (high speed). Each time the key is pressed the display momentarily shows “NORM” (normal speed) or “FAST” (high speed).

Normal: 60 transmissions to complete a half circle, in increments of 3°.

High: 30 transmissions to complete a half circle, in increments of 6°.

The time required to scan one full area of 180° depends on range used and other factors. The table below shows the time required to complete one full area on each range.

Ranges		1	2	3	4	5	6	7	8	9	10	11	12	13	14	15
Unit	ft	30	60	90	120	150	200	250	300	400	500	600	800	1000	1500	2000
Time required (sec) for one full 180° area	Norm	13	13	13	13	13	13	13	13	15	17	20	26	31	46	60
	Fast	9	9	9	9	9	9	9	9	9	10	11	14	17	24	31
Unit	m	10	20	30	40	60	80	100	120	160	200	250	300	400	500	600
Time required (sec) for one full 180° area	Norm	13	13	13	13	13	13	13	14	18	22	27	31	41	50	59
	Fast	9	9	9	9	9	9	9	9	10	12	15	17	22	27	31

Note: Values shown are for reference purposes. Actual values may vary.

3.8 Finding Echo Position with the Cursor

The cursor measures horizontal range and depth. Operate the Omnipad to place the cursor where desired. Cursor data appears at the top left-hand corner on the screen.

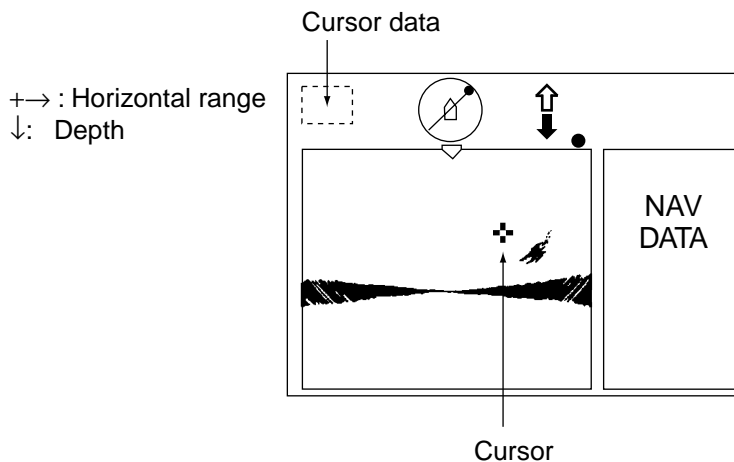

Location of cursor position data

3.9 Event Marker

3.9.1 Entering an event marker

The event marker functions to mark important locations on the screen, and five may be inscribed. Each time the [EVENT] key is pressed the “latest event marker” (⊕) is inscribed at the cursor location and all previously entered event markers are shown by the “previous event marker” (+). When the capacity for event markers is reached, the eldest event marker is erased from the screen to make room for the latest.

Note 1: The latitude and longitude position of the event marker can be output to a video plotter and that position inscribed on the plotter’s screen with the external waypoint mark (X). Each press of the [EVENT] key outputs event marker position. For further details, see TARGET L/L in paragraph 5.4.2.

Note 2: Event markers cannot be inscribed in the vertical scan display when it is in the sub window (Horizontal/vertical scan display). Inscribe the marker on the horizontal display to show it in the vertical scan display.

1. Operate the Omnipad to place the cursor on the location desired for an event marker.
2. Press the [EVENT] key to inscribe the event marker. The event marker is inscribed on the vertical scan display, as well as the horizontal and video plotter displays.

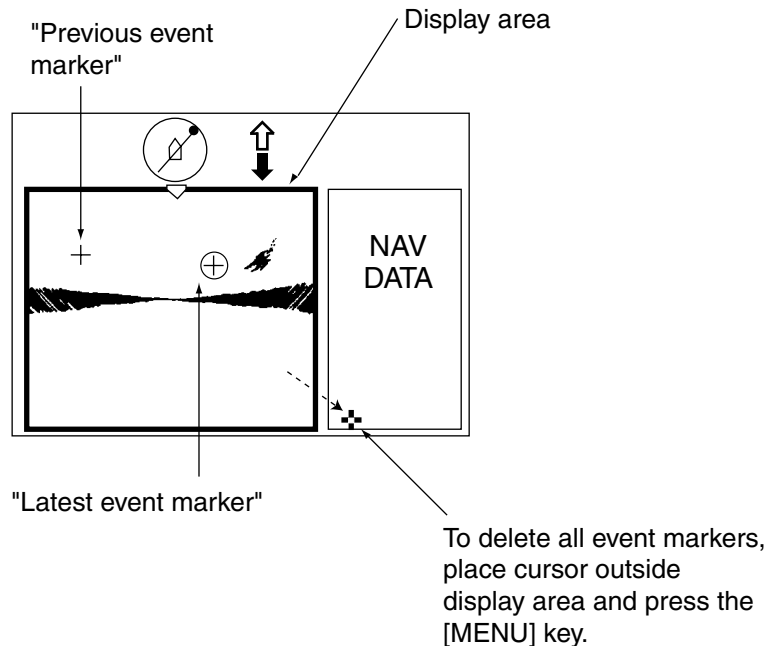

How to inscribe and delete the event markers

3.9.2 Deleting all event markers

All event markers can be erased from the screen as follows:

1. Operate the Omnipad to place the cursor outside the display area.
2. Press the [EVENT] key to show the following dialog box. Do the next step within four seconds; otherwise the dialog box will be erased.

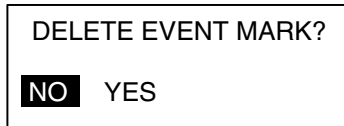

3. Press ► to choose YES and then press the [MENU] key. All event markers are erased from the screen.

3.10 Depth and Horizontal Range Markers

The depth and horizontal range markers function to measure the horizontal range and depth to a desired echo.

Note: Depth and horizontal range markers cannot be inscribed on the vertical scan display when it is in the sub window (Horizontal/vertical scan display). Inscribe the markers on the horizontal display to show them in the vertical scan display.

1. Operate the Omnipad to place the cursor on the location desired.
2. Press the [R/B] key to display the depth and horizontal range markers. Horizontal range and depth appear on the screen.
3. To erase the depth and horizontal range markers, place the cursor on the intersecting point of the depth and horizontal range markers or outside the display and then press the [R/B] key.

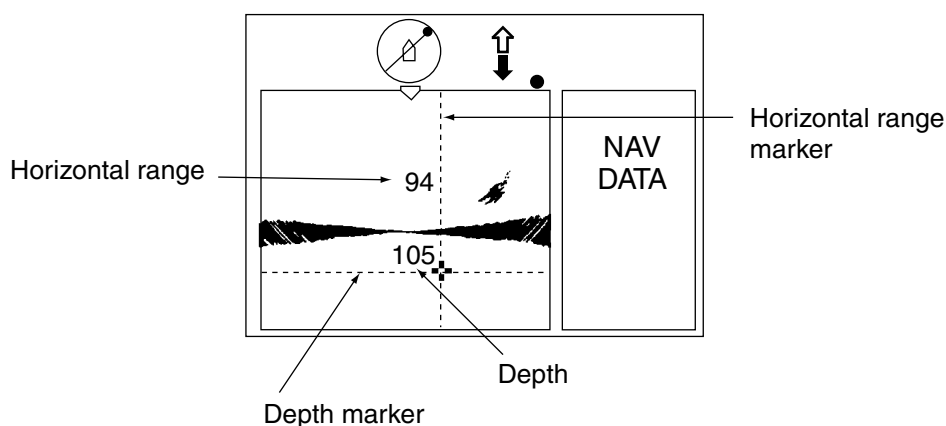

Depth and horizontal range markers

3.11 Adjusting the Picture

3.11.1 Displaying weak echoes clearly

Echoes from targets (such as the bottom or a fish) return to the transducer in order of the distance to them, and when their intensities are compared at the transducer face, those from nearer targets are generally stronger when their reflecting properties are nearly equal. The sonar operator will be quite inconvenienced if these echoes are directly displayed on the screen, since he won't be able to judge the actual size of the target from the size of echoes displayed on the screen. To overcome this inconvenience, use the TVG function. It compensates for propagation loss of sound in water: amplification of echoes on short range is suppressed and gradually increased as range increases, so that similar targets are displayed in similar intensities irrespective of the ranges to them.

The TVG also functions to suppress unwanted echoes and noise which appear in a certain range area on the screen.

To adjust TVG:

1. Press the [MENU] key to open the menu.
2. Press ▲ to choose MENU and then press ◀ or ▶ to choose the VERT menu.

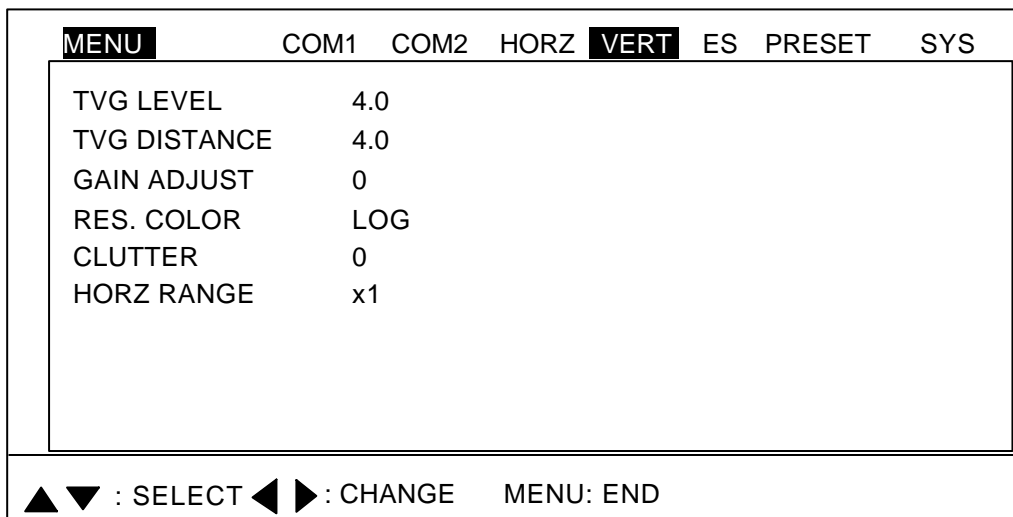

VERT menu

3. Press ▲ or ▼ to choose TVG DISTANCE and then press ▶ to show the following dialog box.

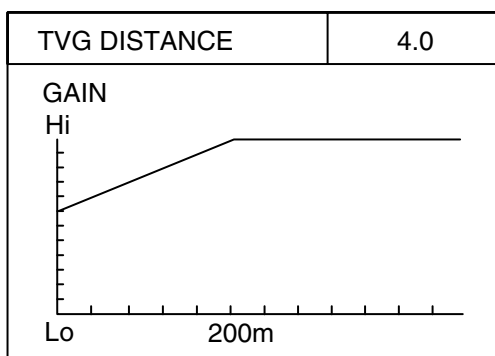

4. Press ◀ or ▶ to adjust TVG distance, considering sea conditions. The larger the figure the greater the distance at which the TVG works.

TVG Distance Setting	0	0.5	1.0	1.5	2.0	2.5	3.0	3.5	4.0	4.5	5.0	10.0
Meters	3	8	20	40	60	100	130	160	200	250	320	1000
Feet	10	30	70	130	210	330	410	520	660	820	1040		3280
Passi/braza	2	5	10	20	40	60	80	100	120	150	180		600
Fathoms	2	5	10	20	40	60	80	100	110	140	170		550

5. Press ▲ or ▼ to close the dialog box and return to the VERT menu.
6. To suppress reflections from the sea surface or plankton, choose TVG LEVEL and then press ▶.
7. Press ◀ or ▶ to adjust TVG LEVEL, considering sea conditions. The larger the figure the less the gain over distance.
8. Press the [MENU] key to register your selection and close the menu.

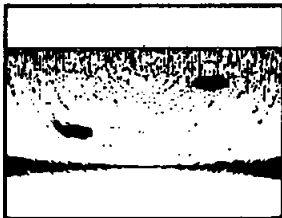

Wrong

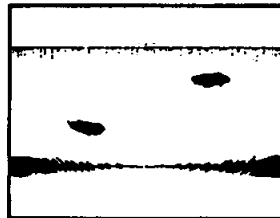

Correct

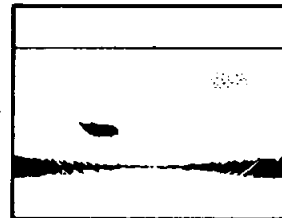

Level too high

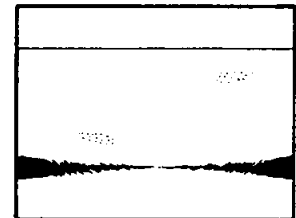

Distance too high

Examples of proper and improper TVG

3.11.2 Suppressing noise and interference

You may encounter occasional or intermittent noise and interference as shown below. This is mostly caused by electrical equipment, engine, propeller noise from own ship, or noise from other sonars being operated nearby. If interference appears, turn on the interference rejector as below to suppress it.

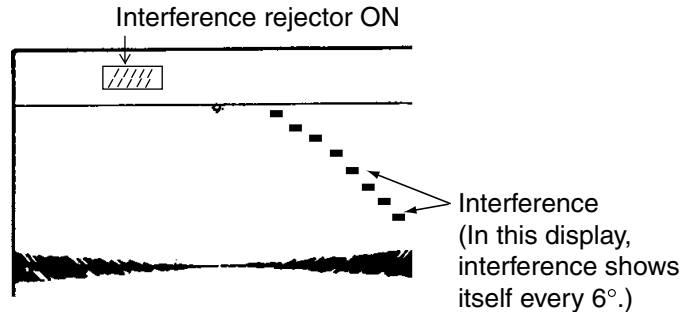

Appearance of interference

1. Press the [MENU] key to open the menu.
2. Press ▲ to choose MENU at the top of the screen.
3. Press ◀ or ▶ to choose the COM1 menu.
4. Press ▲ or ▼ to choose INT REJECT.
5. Press ▶ to open the dialog box.
6. Press ◀ or ▶ to choose OFF or ON as appropriate.
7. Press the [MENU] key to register your selection and close the menu.

3.11.3 Gain adjustment

Adjust the gain here when there is disparity in gain level between the main and sub windows.

1. Press the [MENU] key to open the menu.
2. Press ▲ to choose MENU at the top of the screen.
3. Press ◀ or ▶ to choose the VERT menu.
4. Press ▲ or ▼ to choose GAIN ADJUST.
5. Press ▶ to open the dialog box.
6. Press ◀ or ▶ to adjust.
7. Press the [MENU] key to register your selection and close the menu.

3.11.4 Resolution color

RES. COLOR sets transfer characteristics of input signal level versus display echo level. Echo strength is emphasized in order of CUBE, SQUARE, LINEAR, LOG. You can see the characteristics of each by watching the color bar as you change the setting.

1. Press the [MENU] key to open the menu.
2. Press ▲ to choose MENU at the top of the screen.
3. Press ◀ or ▶ to choose the VERT menu.
4. Press ▲ or ▼ to choose RES. COLOR.
5. Press ▶ to open the dialog box.
6. Press ◀ or ▶ to choose appropriate option, referring to the description below.
 - LOG: Displays weak to strong echoes in their respective levels. This setting is suitable for general use.
 - LINEAR: Downplays the weak echoes when compared with LOG. Effective for suppressing weak echoes such as plankton.
 - SQUARE: Strong echoes are emphasized more than in LINEAR.
 - CUBE: Strong echoes are emphasized even more than in SQUARE.
7. Press the [MENU] key to register your selection and close the menu.

3.11.5 Suppressing clutter

Low intensity echoes, often caused by sediments in water, are painted on the screen as a large number or random dots. This noise can be suppressed.

1. Press the [MENU] key to open the menu.
2. Press ▲ to choose MENU at the top of the screen.
3. Press ◀ or ▶ to choose the VERT menu.
4. Press ▲ or ▼ to choose CLUTTER.
5. Press ▶ to open the dialog box.
6. Press ◀ or ▶ to choose 0, 1, 2 or 3 as appropriate. The higher the number (setting) the weaker the echoes which are erased.
7. Press the [MENU] key to register your selection and close the menu.

3.11.6 Choosing horizontal range expansion factor

You may choose the horizontal range expansion factor for the vertical scan picture, from x1 or x2. Note that this feature cannot be adjusted when the vertical search mode, activated by a function key, is turned on.

1. Press the [MENU] key to open the menu.
2. Press ▲ to choose MENU at the top of the screen.
3. Press ◀ or ▶ to choose the VERT menu.
4. Press ▲ or ▼ to choose HORZ RANGE.
5. Press ▶ to open the dialog box.
6. Press ◀ or ▶ to choose x1 or x2 as appropriate.
7. Press the [MENU] key to register your selection and close the menu.

3.12 Interpreting the Vertical Scan Display

This section provides information necessary for interpreting the vertical scan display.

3.12.1 Sample echo displays

Port-starboard picture

You can see fish echoes at the center-right of the screen. The bottom is displayed wider as the distance from the ship's position increases. Therefore, it may be difficult to discriminate bottom fish.

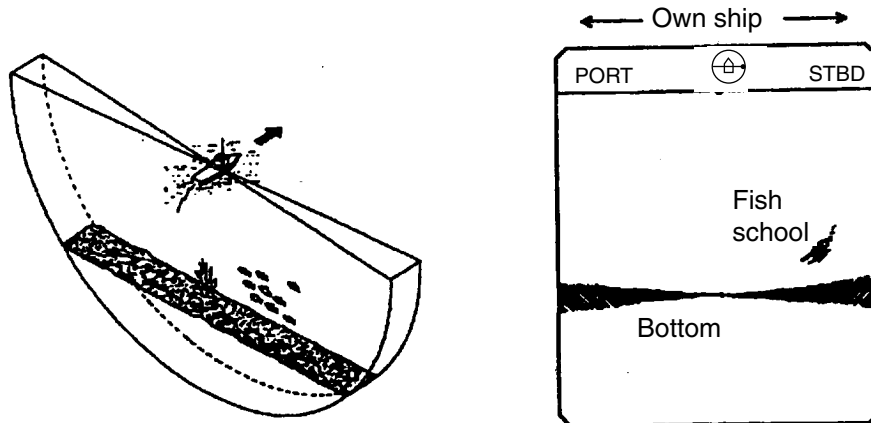

Port-starboard picture

When ship passes over fish schools

The sounding beam is directed fore-aft and the display is off-centered* to present a wider view of the area forward of the ship. You can clearly see fish schools approaching from the bow of the ship.

*: Automatically off-centered.

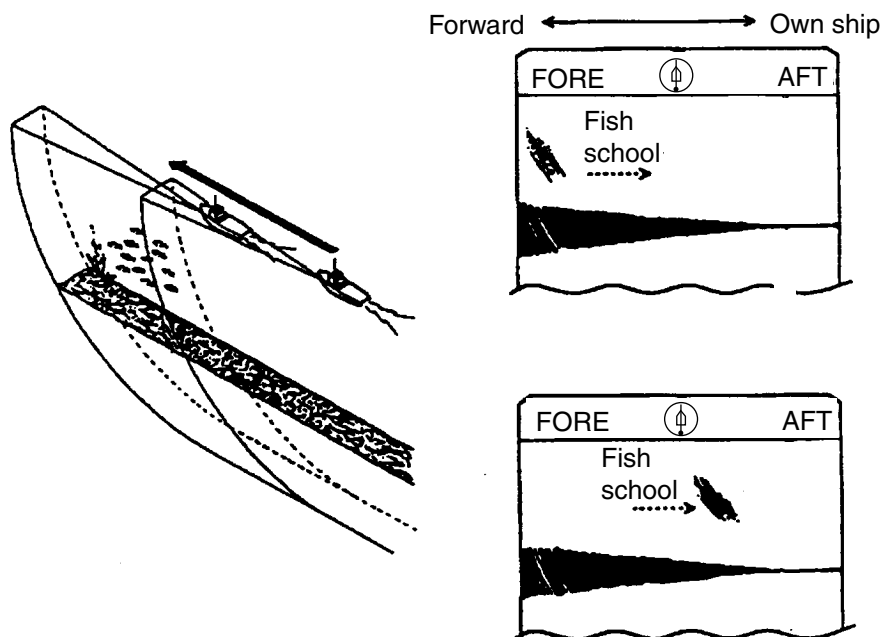

Picture appearance when passing over fish schools

3. VERTICAL SCAN MODE

Display of net hauling

This is an example of net hauling display. The location of the net is indicated clearly.

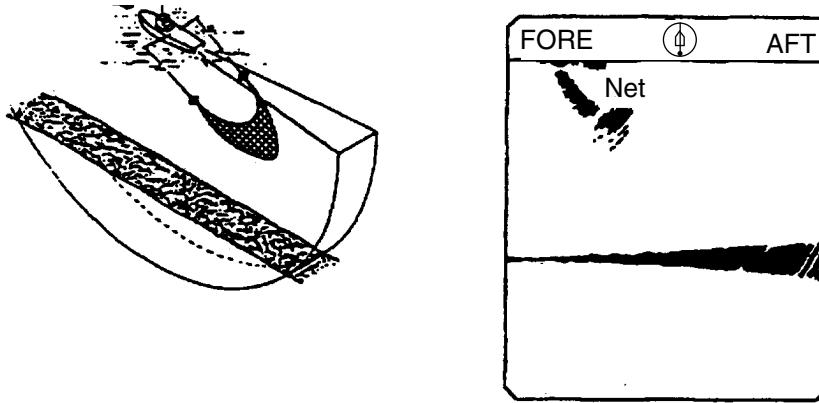

Net hauling and sonar picture

False echo

In shallow water (depth less than 100 m) detection, unwanted echoes as shown in the figure below may appear. This phenomenon is caused by the false echo from the previous transmission. Reducing the Tx rate on the COM1 menu may lessen this effect.

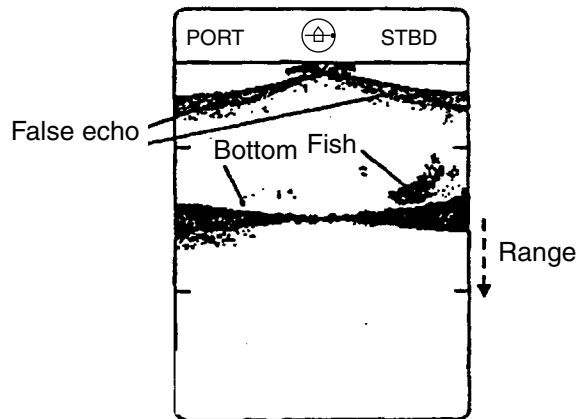

False echoes

4. ECHO SOUNDER MODE

4.1 Operational Overview

The figure below shows the typical echo sounder mode operating sequence.

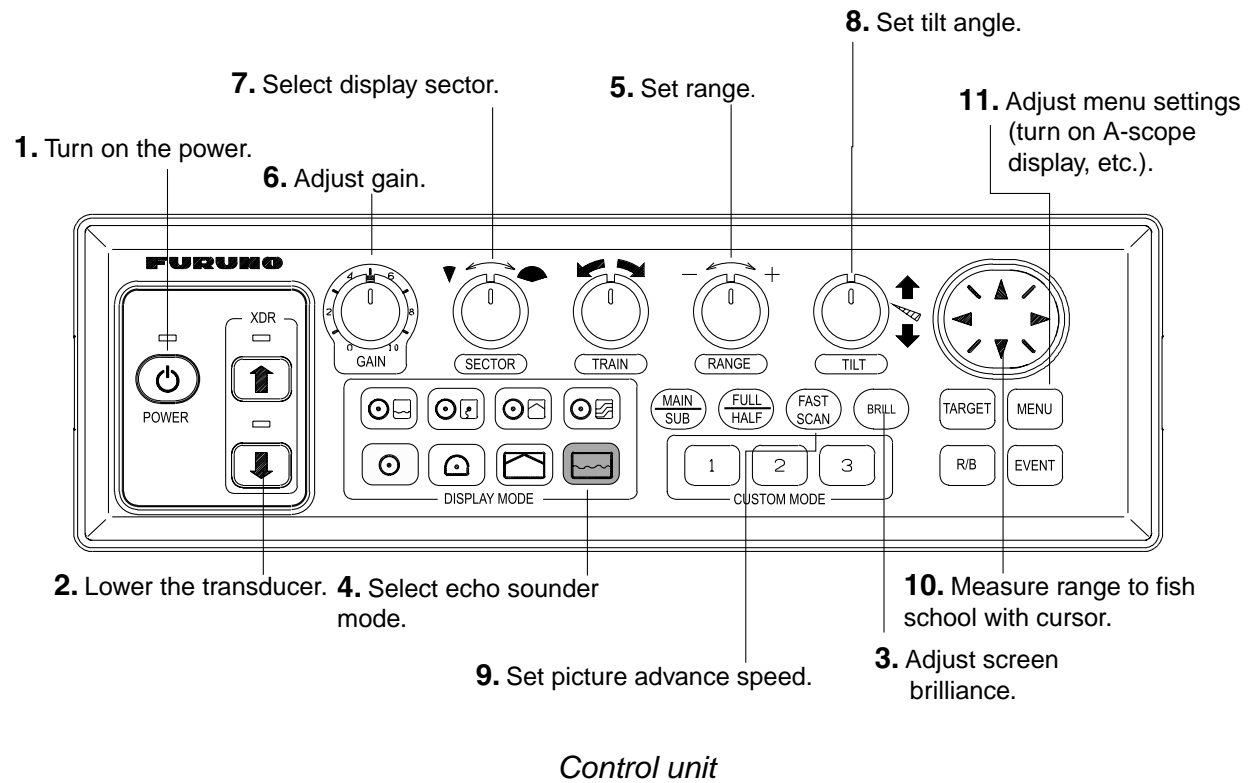

4.2 Typical Echo Sounder Display

Press the  key to display the echo sounder picture.

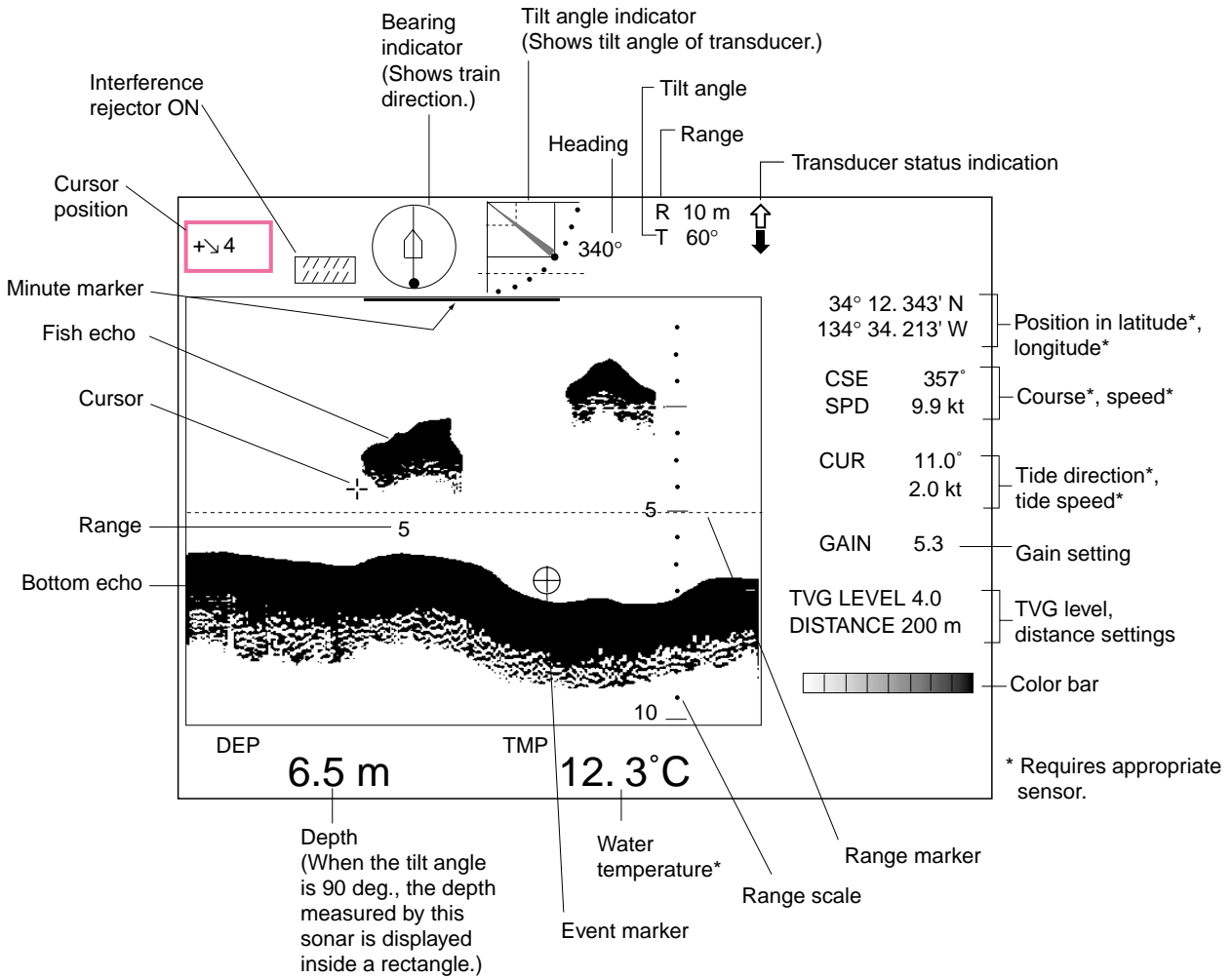

Typical echo sounder display

4.3 Choosing the Range

The [RANGE] control chooses the detection (display) range, in 15 settings. Choose the range according to either the fish species being searched or the depth desired. Each time the control is operated the newly chosen range briefly appears in large characters at the screen top. Range is permanently displayed at the top right-hand corner.

Normally the range is set so that the bottom is traced at the lower part of the screen.

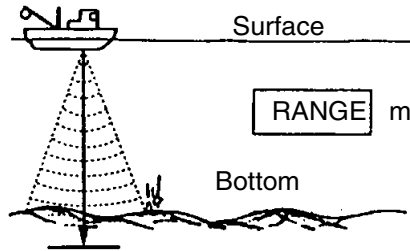

Range concept

Default echo sounder mode range settings

Unit	1	2	3	4	5	6	7	8	9	10	11	12	13	14	15
Meters	10	20	30	40	60	80	100	120	160	200	250	300	400	500	600
Feet	30	60	90	120	150	200	250	300	400	500	600	800	1000	1500	2000

Note 1: Unit of range measurement may be chosen from among meters, feet, fathoms, passi/braza and Hiro (Japanese). For further details, see UNIT in paragraph 5.4.2.

Note 2: Ranges may be freely preset as desired. For further details, see paragraph 5.4.6.

4.4 Train Direction

The sounding beam may be directed 360° in any direction. Operate the [TRAIN] control to choose sounding beam direction. Each setting on the control is an increment of 6°. The train indicator at the top of the screen shows training direction: 0°, fore direction; 90°, starboard direction; 180°, aft direction, and 270°, port direction.

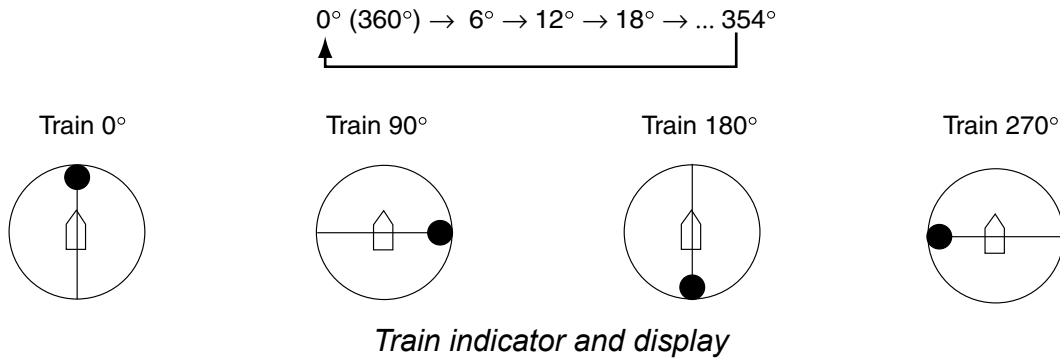

4.5 Choosing Tilt Angle

The transducer can be pointed directly toward the bottom or forward of the ship. Operate the [TILT] control to choose an appropriate tilt angle. The available tilt angle is 0° (horizontal direction) to 90° (vertical), in increments of 1°. Chosen tilt angle appears at the top of the display to the right of “T”.

4.6 Choosing Picture Advance Speed

The picture advance speed determines how quickly the vertical scan lines run across the screen, from right to left. When choosing a picture speed, keep in mind that a fast advance speed will expand a fish school horizontally on the screen and a slow one will contract it.

1. Press the [FAST SCAN] key. The following dialog box appears. Do the next step within four seconds; otherwise the dialog box will be erased.

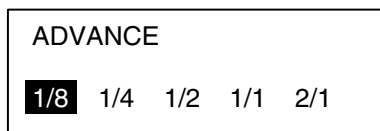

2. Press ◀ or ▶ ([FAST SCAN] key may also be used) to choose a speed. The fractions in the dialog box correspond to the number of scan lines produced per transmission. For example, “2/1” means two scan lines are produced per transmission.
3. Press the [MENU] key to close the dialog box. Note that the dialog box is automatically closed if there is no control operation for about four seconds.

4.7 Measuring Range by Cursor

Use the cursor to display the range from own ship to the cursor location. Use the Omnipad to place the cursor where desired. The range to the cursor appears at the upper left-hand corner of the screen.

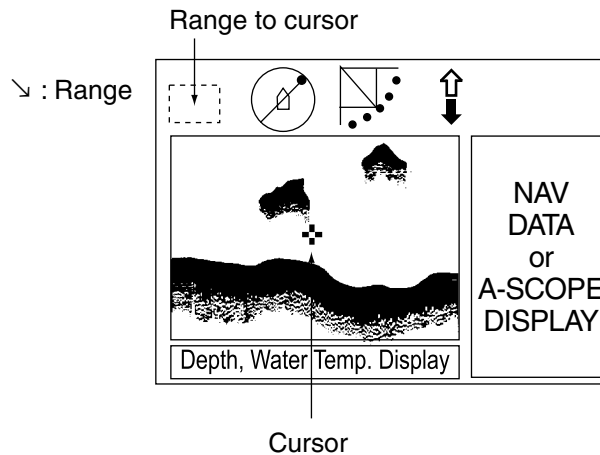

How to measure range with the cursor

4.8 Event Marker

The event marker functions to mark important locations on the screen, and five may be inscribed. Each time the [EVENT] key is pressed the “latest event marker” (⊕) is inscribed at the cursor location and all previously entered event markers are shown by the “previous event marker” (+). When the capacity for event markers is reached, the eldest event marker is erased from the screen to make room for the latest.

Note 1: The event marker inscribed on the echo sounder display will also be inscribed on the horizontal and video plotter displays. However, the marker is always inscribed at own ship position on the horizontal and video plotter displays regardless of the location of the marker on the echo sounder display.

Note 2: The latitude and longitude position of the event marker can be output to a video plotter and that position inscribed on the plotter’s screen with the external waypoint mark (X). Each press of the [EVENT] key outputs event marker position. For further details, see TARGET L/L in paragraph 5.4.2.

Note 3: Event markers are automatically erased as they move off the screen with picture advancement. However, event marks entered from the echo sounder remain on the horizontal and video plotter displays, until they are erased.

4.8.1 Inscribing the event marker

1. Operate the Omnipad to place the cursor on the location desired for an event marker.
2. Press the [EVENT] key to inscribe the event marker.

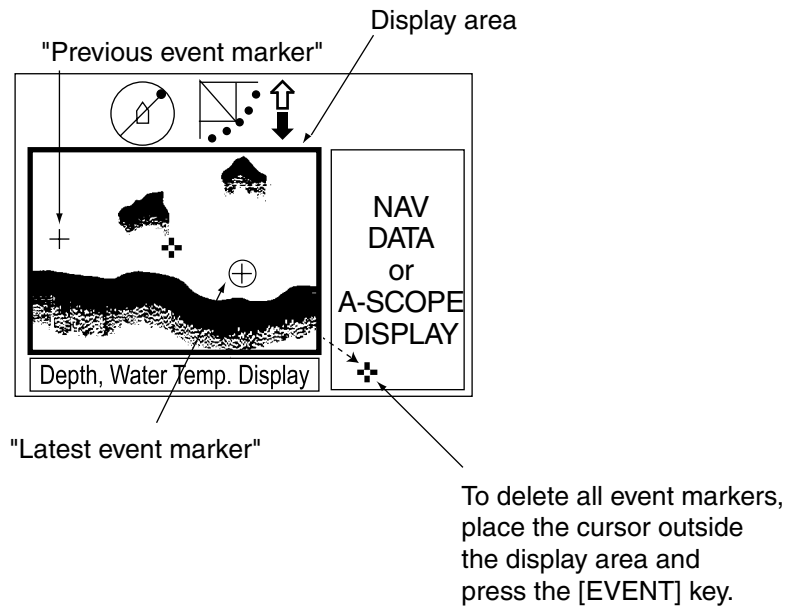

How to inscribe and delete the event markers

4.8.2 Deleting all event markers

All event markers can be erased from the screen as follows:

1. Operate the Omnipad to place the cursor outside the display area.
2. Press the [EVENT] key to show the following dialog box. Do the next step within four seconds; otherwise the dialog box will be erased.

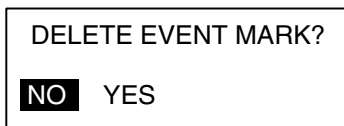

3. Press ► to choose YES and then press the [MENU] key. All event markers are erased from the screen.

4.9 Range Marker

The range marker functions to measure the range to a target echo (fish school, bottom, etc.)

1. Operate the Omnipad to place the cursor on the location desired.
2. Press the [R/B] key to display the range marker. The range marker appears along with range indication.
3. To erase the range marker, place the cursor on the marker or outside the display area and then press the [R/B] key.

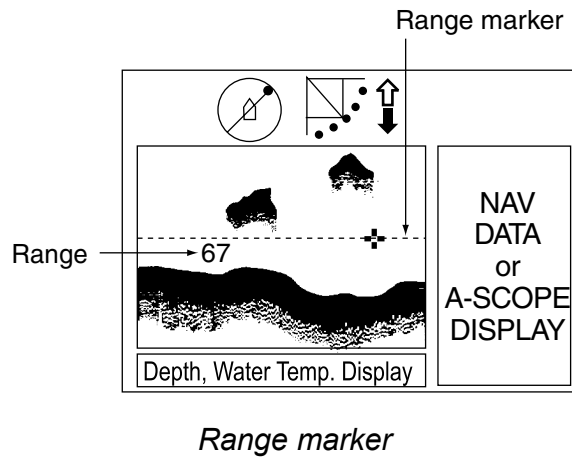

4.10 Adjusting the Picture

4.10.1 Displaying weak echoes clearly

Echoes from targets (such as the bottom or a fish) return to the transducer in order of the distance to them, and when their intensities are compared at the transducer face, those from nearer targets are generally stronger when their reflecting properties are nearly equal. The sonar operator will be quite inconvenienced if these echoes are directly displayed on the screen, since he won't be able to judge the actual size of the target from the size of echoes displayed on the screen. To overcome this inconvenience, use the TVG function. It compensates for propagation loss of sound in water: amplification of echoes on short range is suppressed and gradually increased as range increases, so that similar targets are displayed in similar intensities irrespective of the ranges to them.

The TVG also functions to suppress unwanted echoes and noise which appear in a certain range area on the screen.

To adjust TVG:

1. Press the [MENU] key to open the menu.
2. Press ▲ to choose MENU and then press ◀ or ▶ to choose the ES menu.

MENU	COM1	COM2	HORZ	VERT	ES	PRESET	SYS
TVG LEVEL		4.0					
TVG DISTANCE		4.0					
GAIN ADJUST		0					
RES. COLOR		LOG					
CLUTTER		0					
A-SCOPE		OFF					

▲▼ : SELECT ◀▶ : CHANGE MENU: END

ES menu

3. Press ▲ or ▼ to choose TVG DISTANCE and then press ►. The following dialog box appears.

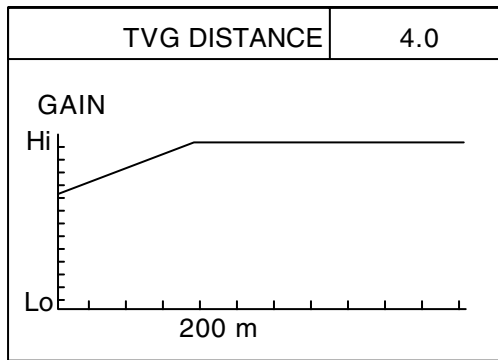

4. Press ◀ or ▶ to adjust TVG distance.

TVG Distance Setting	0	0.5	1.0	1.5	2.0	2.5	3.0	3.5	4.0	4.5	5.0	10.0
Meters	3	8	20	40	60	100	130	160	200	250	320	1000
Feet	10	30	70	130	210	330	410	520	660	820	1040		3280
Passi/braza	2	5	10	20	40	60	80	100	120	150	180		600
Fathoms	2	5	10	20	40	60	80	100	110	140	170		550

5. Press ▲ or ▼ to close the dialog box and return to the ES menu.
6. To suppress reflections from the sea surface or plankton, choose TVG LEVEL and then press ►.
7. Press ◀ or ▶ to adjust TVG LEVEL.
8. Press the [MENU] key to register your selection and close the menu.

4. ECHO SOUNDER MODE

4.10.2 Finding echo strength (A-scope display)

The A-scope display shows echoes at each transmission with amplitudes and tone proportional to their intensities, on the right 1/4 of the screen. It is useful for estimating the kind of fish school and bottom composition.

1. Press the [MENU] key.
2. Press ▲ to choose MENU.
3. Press ◀ or ▶ to choose ES.
4. Press ▼ to choose A-SCOPE.
5. Press ◀ or ▶ to open the dialog box.

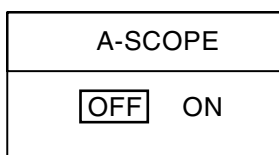

6. Press ▶ to choose ON.
7. Press the [MENU] key to close the dialog box.

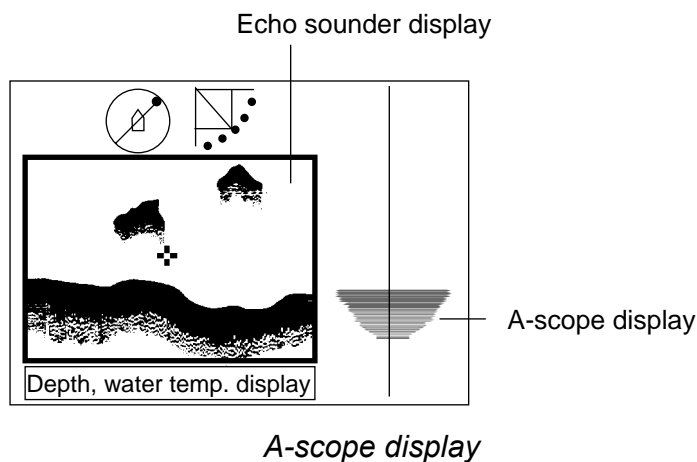

4.10.3 Gain adjustment

Adjust the gain here when there is disparity in gain level between the main and sub windows.

1. Press the [MENU] key to open the menu.
2. Press ▲ to choose MENU at the top of the screen.
3. Press ◀ or ▶ to choose the ES menu.
4. Press ▲ or ▼ to choose GAIN ADJUST.
5. Press ▶ to open the dialog box.
6. Press ◀ or ▶ to adjust.
7. Press the [MENU] key to register your selection and close the menu.

4.10.4 Resolution color

RES. COLOR sets transfer characteristics of input signal level versus display echo level. Echo strength is emphasized in order of CUBE, SQUARE, LINEAR, LOG. You can see the characteristics of each by watching the color bar as you change the setting.

1. Press the [MENU] key to open the menu.
2. Press ▲ to choose MENU at the top of the screen.
3. Press ◀ or ▶ to choose the ES menu.
4. Press ▲ or ▼ to choose RES. COLOR.
5. Press ▶ to open the dialog box.
6. Press ◀ or ▶ to choose appropriate option, referring to the description below.
 - LOG: Displays weak to strong echoes in their respective levels. This setting is suitable for general use.
 - LINEAR: Downplays the weak echoes when compared with LOG. Effective for suppressing weak echoes such as plankton.
 - SQUARE: Strong echoes are emphasized more than in LINEAR.
 - CUBE: Strong echoes are emphasized even more than in SQUARE.
7. Press the [MENU] key to register your selection and close the menu.

4.10.5 Suppressing clutter

Low intensity echoes, often caused by sediments in water, are painted on the screen as a large number or random dots. This noise can be suppressed.

1. Press the [MENU] key to open the menu.
2. Press ▲ to choose MENU at the top of the screen.
3. Press ◀ or ▶ to choose the ES menu.
4. Press ▲ or ▼ to choose CLUTTER.
5. Press ▶ to open the dialog box.
6. Press ◀ or ▶ to choose 0, 1, 2 or 3 as appropriate. The higher the number (setting) the weaker the echoes which are erased.
7. Press the [MENU] key to register your selection and close the menu.

5. MENU OPERATION

5.1 COM1 Menu

5.1.1 Displaying the COM1 menu

1. Press the [MENU] key to open the menu.
2. Press ▲ to choose MENU, and then press ◀ to choose COM1.

MENU	COM1	COM2	HORZ	VERT	ES	PRESET	SYS
TX POWER	MAX						
PULSELENGTH	LONG						
TX RATE	10						
INT REJECT	OFF						
AGC	OFF						
AUDIO LEVEL	0						

▲ ▼ : SELECT ◀ ▶ : CHANGE MENU: END

COM1 menu

5.1.2 COM1 menu description

TX POWER: Chooses transmitter output power to maximum or minimum. For further details, see paragraph 2.11.1.

PULSELENGTH: Chooses pulselength to short or long. For further details, see paragraph 2.11.2.

TX RATE: The Tx rate may be set between 1-10 in the case of the internal transmitter, or an external synchronous signal may be used. The higher the number the greater the number of transmissions. For operation in shallow waters, choose the Tx rate which displays the second reflection from the bottom between the sea surface and bottom. For use of an external video sounder or sonar, choose EXT.

INT REJECT: Turns the interference rejector on or off. For further details, see paragraph 3.11.2.

AGC: Automatically lowers sensitivity against strong echoes (such as those from the bottom and large fish schools) to emphasize weak echoes such as those from fish close to the bottom.

AUDIO LEVEL: Adjust the volume of the optional speaker.

5.2 COM2 Menu

5.2.1 Displaying the COM2 menu

1. Press the [MENU] key to open the menu.
2. Press ▲ to choose MENU, and then press ◀ or ▶ to choose COM2.

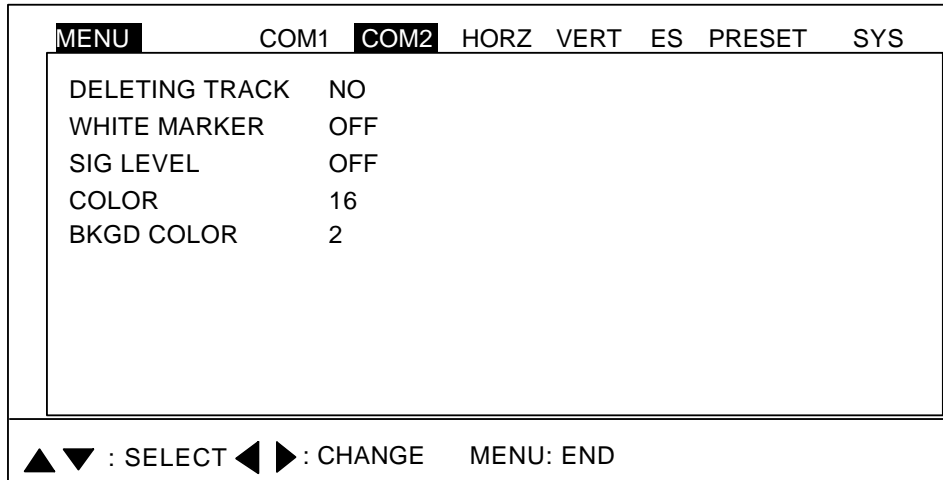

COM2 menu

5.2.2 COM2 menu description

DELETING TRACK: Choose ON to delete all ship's track (from horizontal and horizontal/video plotter displays).

WHITE MARKER: Displays desired echo in white. It is useful for discriminating bottom fish from the bottom echo. The setting range for the 8-color display is OFF, 1-7, and for the 16-color display, OFF, 1-15.

SIG LEVEL: Refer to page 2-17.

COLOR: Chooses 8- or 16-color display.

BKGD COLOR: Chooses color of background, text and menu. Three choices are available and these are shown in the table below.

BKGD COLOR	Background	Text	Menu
1	Black	Gray	Dark-blue
2	Dark-blue	White	Medium blue
3	White	Black	Gray

5.3 Short-cut Menu, Preset Menu

These menus program the CUSTOM MODE keys [1], [2] and [3]. The menu to use may be chosen with CUSTOM KEY on the SYSTEM SETTING 1 menu.

Short-cut key: One-touch activation of the operator-selected dialog box.

Preset key: One-touch setup of mode, sector, train, range, tilt and scan speed. Below are the default settings for PRESET.

Custom mode key default settings for PRESET

CUSTOM MODE key	Display Mode	Sector	Train	Range (m)	Tilt	Speed
Key 1	Horizontal Expansion	240°	0°	160	30°	Fast
Key 2	Horizontal	360°	0°	160	30°	Fast
Key 3	Vertical Scan	180°	90°	120	90°	Fast

5.3.1 Choosing short-cut or preset

1. Press the [MENU] key to open the menu.
2. Press ▲ to choose MENU, and then press ► to choose SYS.

MENU	COM1	COM2	HORZ	VERT	ES	PRESET	SYS
GO TO SYS MENU YES <input type="text" value="NO"/>							
▲ ▼ : SELECT ◀ ▶ : CHANGE MENU: END							

Display for opening system menu

3. Press ▼ to choose GO TO SYS MENU.
4. Press ◀ to choose YES.

5. MENU OPERATION

```

** SYSTEM MENU **
SYSTEM SETTING ►
RANGE-SONAR MODE
RANGE-VERTICAL MODE
RANGE-E/S MODE
RANGE-TRACK MODE
COLOR PALETTE
LANGUAGE
SYSTEM BACKUP
LOAD BACKUP DATA
HEADING OFFSET, DRAFT OFFSET
ADJ MOTION SENSOR
TX FREQ ADJUST
TEST
TEST PATTERN
DEMO MODE
DEFAULT

▲▼ : SELECT ► : MENU DISPLAY MENU: END

```

System menu

5. SYSTEM SETTING is highlighted; press ► to open the SYSTEM SETTING menu.

```

** SYSTEM SETTING 1 **
MENU 1 2
POSITION : SHIP'S L/L SHIP'S LOP CURSOR L/L
TRACK : OFF ON
CURRENT DATA : OFF FLOW FROM FLOW TO
HEADING INDICATION : TRUE AZ
NORTH MARK : OFF ON
CSE DATA : NAV GYRO
NAV DATA : GPS LoranC LoranA DR DECCA OTHERS
TVG CORRECTION : OFF 1/2 1/1
UNIT : m ft fa HIRO P/B
TEMP : °C °F
TARGET L/L : OFF ON
CUSTOM KEY : PRESET KEY SHORT-CUT KEY
EMPHASIS MODE : OFF NORMAL RED
ETA MARK : OFF 10sec 30sec 1min 3min 6min

▲▼ : SELECT ◀▶ : CHANGE MENU: END





```

System setting 1 menu

6. Press ▲ or ▼ to choose CUSTOM KEY.
7. Press ◀ or ▶ to choose PRESET KEY or SHORT-CUT KEY as desired.
8. Press the [MENU] key twice to register your selection and close the menu.

5.3.2 Changing setting of preset key

1. Choose PRESET KEY following the procedure in paragraph 5.3.1.
2. Press the [MENU] key to open the menu.
3. Press ▲ to choose MENU, and then press ◀ or ▶ to choose PRESET.

MENU		COM1	COM2	HORZ	VERT	ES	PRESET	SYS
	MODE	SECTOR	TRAIN	RANGE	TILT	SPEED		
PRESENT		360°	0°	160	30°	NORM		
CUSTOM1		240°	0°	160	30°	FAST		
CUSTOM2		360°	0°	160	30°	FAST		
CUSTOM3		180°	90°	120	90°	FAST		

ADJUST THE KNOBS AND FUNCTION KEYS TO THE DESIRED SETTING,
THEN PRESS A CUSTOM MODE KEY TO SAVE THE SETTING.

FUNCTION KEY: ENTRY MENU: END

PRESET menu

4. Set the [MODE], [SECTOR], [TRAIN], [RANGE], [TILT] and [FAST SCAN] controls according to target fish or fishing area. Current setting is shown in the "PRESENT" section.
5. Press the CUSTOM MODE keys [1], [2] or [3] as appropriate to program. You are asked if you want to save the settings to the custom key pressed. (In the example below the custom key [1] was pressed.)

SAVE THE SETTINGS TO CUSTOM1 KEY?	
<input type="checkbox"/> NO	<input type="checkbox"/> YES
◀▶ : CHANGE MENU: END	

6. Press ▶ to choose YES.
7. Press the [MENU] key. The message "PRGM SET" appears at the screen top.
8. Press the [MENU] key to finish.

Activating a custom mode key

1. Press appropriate CUSTOM MODE key. The indication CUSTOM1, CUSTOM2 or CUSTOM3 appears at the top of the screen depending on key pressed.
2. To escape from the custom mode operation, operate any of the following controls: [MODE], [SECTOR], [TRAIN], [RANGE], [TILT] or [FAST SCAN].

5.3.3 Changing setting of short-cut key

The default settings are key [1], vertical search; key [2], volume, and key [3], delete track. The operator may change their functions as desired.

Note: In the combination modes the short-cut key may only be activated from the main window.

1. Choose SHORT-CUT following the procedure in paragraph 5.3.1.
2. Press the [MENU] key to open the menu.
3. Press ▲ to choose MENU, and then press ◀ or ▶ to choose SHORT-CUT.

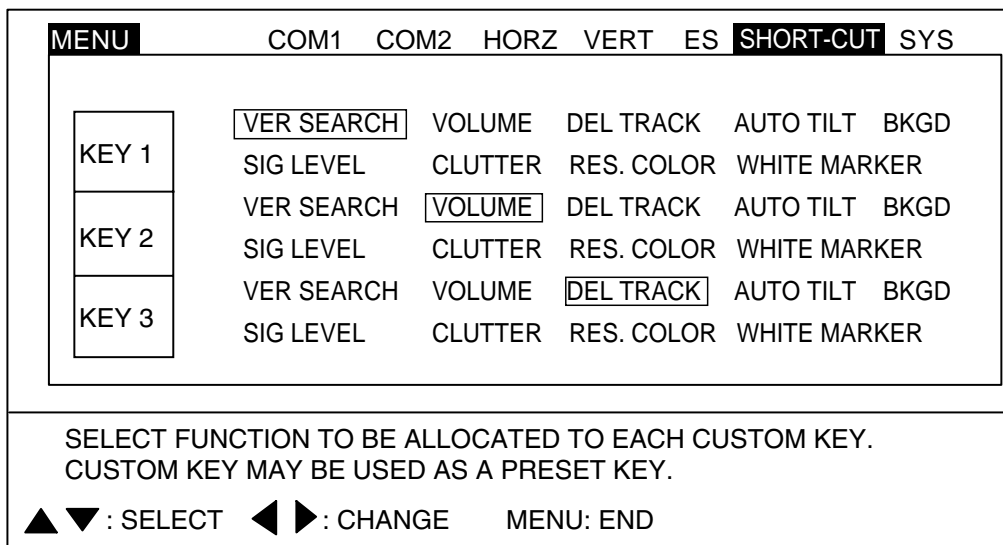

SHORT-CUT menu

4. Press ▲ or ▼ to choose key to preset. For example, choose KEY 1.
5. Press ◀ or ▶ to choose item.

Item	Description	Ref. Paragraph
VER. SEARCH	See description on the next page. Note: HORZ RANGE on the VERT MENU cannot be adjusted when vertical search is active. Beeps sounds if you attempt to adjust the setting.	
VOLUME	Adjust audio level of optional speaker.	5.1.1
DEL. TRACK	Delete track from the horizontal and horizontal/video plotter displays.	5.2.1
AUTO TILT	Turn automatic tilt on or off.	2.13.1
BKGD	Choose background color.	5.2.1
SIG LEVEL	Erase weak echoes from the screen.	2.11.4
CLUTTER	Suppress low intensity echoes.	2.13.1, 3.11.5, 4.11.1
RES. COLOR	Set transfer characteristics of input signal level versus display echo level.	2.13.1, 3.11.4, 4.11.1
WHITE MARKER	Displays selected echo color in white.	5.2.1

6. Press the [MENU] key to finish.

Activating a short-cut key

1. Press a CUSTOM MODE key, and the dialog box programmed for the custom key pressed appears. (No dialog box appears for VER. SEARCH.) The dialog box below is for "CLUTTER".

CLUTTER (HORZ): **0** 1 2 3

Note: Vertical search can only be activated when the horizontal mode or a combination mode is active.

2. Press ◀ or ▶ to choose option desired.
3. Press the [MENU] key to close the dialog box.

VERTICAL SEARCH FUNCTION

When you find a target of interest on the horizontal display, simply press the function key programmed for VER. SEARCH to get a cross-sectional view of the vertical plane. This mode is useful for evaluating fish school concentration and location of the targeted fish school or for navigation purposes.

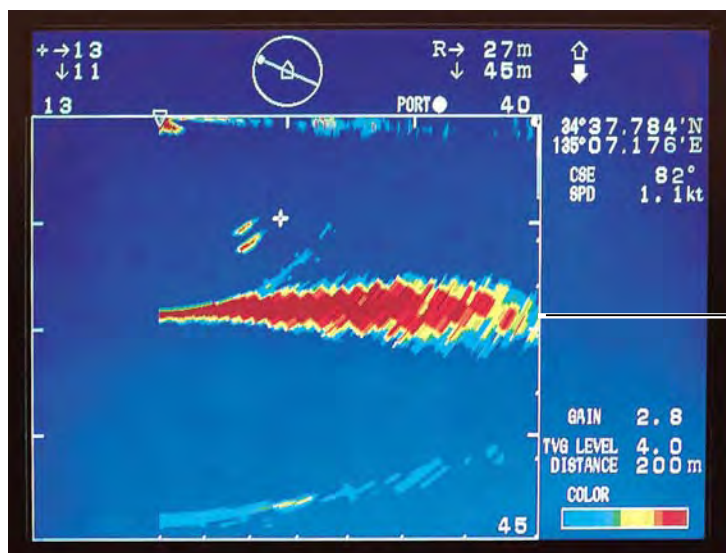

The vertical search picture is drawn using the following specifications:

- Horizontal range: Same as set on horizontal mode
- Vertical range: Same as set on horizontal mode
- Train marker: Train angle at the moment function key is turned on
- Vertical scan display range: 0-90 degrees (own ship position shifted leftward)

5.4 SYSTEM Menu

This menu provides items which may be set according to operator's preference.

5.4.1 Displaying the SYSTEM menu

1. Press the [MENU] key to open the menu.
2. Press ▲ to choose MENU, and then press ► to choose SYS.
3. Press ▼ to choose GO TO SYS MENU.
4. Press ◀ to choose YES.

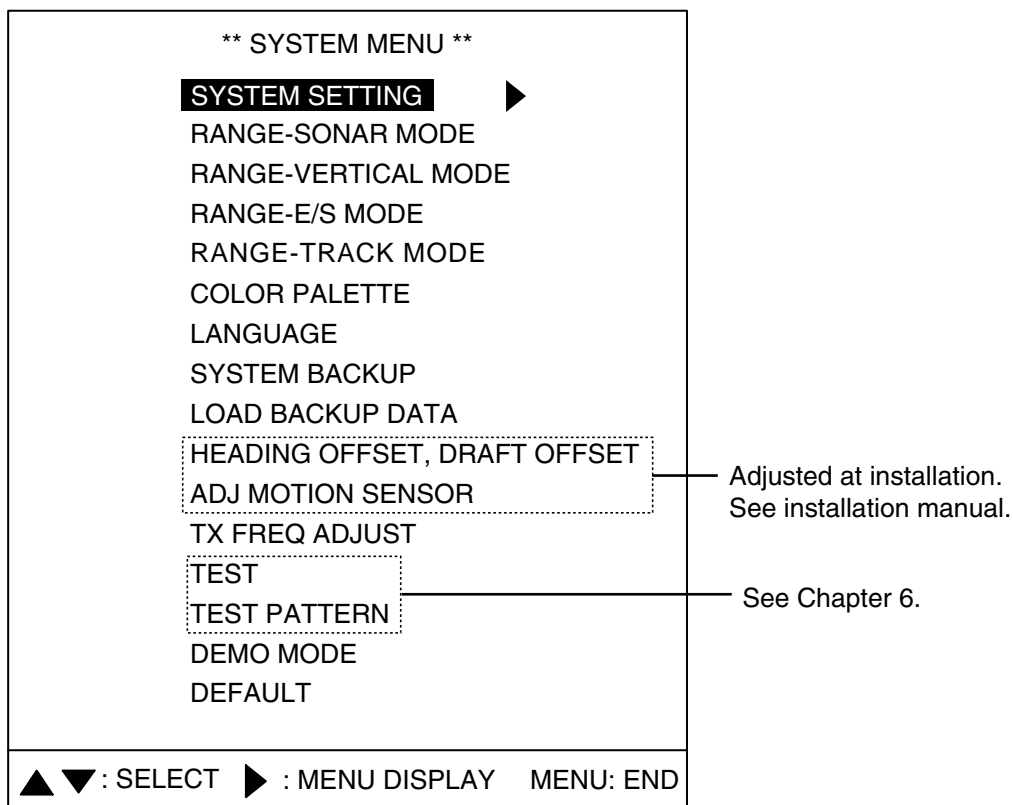

System menu

5.4.2 SYSTEM SETTING 1 menu description

1. Display the SYSTEM menu and then press ▲ or ▼ to choose SYSTEM SETTING.
2. Press ► to open the SYSTEM SETTING menu.
3. Press ▲ to MENU.
4. Press ◀ to choose "1."

** SYSTEM SETTING 1 **	
MENU	1 2
POSITION	: SHIP'S L/L SHIP'S LOP CURSOR L/L
TRACK	: OFF ON
CURRENT DATA	: OFF FLOW FROM FLOW TO
HEADING INDICATION	: TRUE AZ
NORTH MARK	: OFF ON
CSE DATA	: NAV GYRO
NAV DATA	: GPS LoranC LoranA DR DECCA OTHERS
TVG CORRECTION	: OFF 1/2 1/1
UNIT	: m ft fa HIRO P/B
TEMP	: °C °F
TARGET L/L	: OFF ON
CUSTOM KEY	: PRESET KEY SHORT-CUT KEY
EMPHASIS MODE	: OFF NORMAL RED
ETA MARK	: OFF 10sec 30sec 1min 3min 6min

▲▼ : SELECT ◀▶ : CHANGE MENU: END

System setting 1 menu

SYSTEM SETTING 1 menu description

POSITION: Chooses how to display position data. The choices are latitude and longitude, LOP (Decca or Loran, whichever navigator is connected) or cursor latitude and longitude. (The connected navigator must be capable of displaying L/L or LOP.) Position data required.

TRACK: Turns the track display on or off on the horizontal display. The track is always shown on the video plotter display regardless of this setting.

CURRENT DATA: Turns current data (tide) on or off. FLOW FROM shows from what direction the current is flowing; FLOW TO shows the direction the current is heading. Requires connection a current indicator.

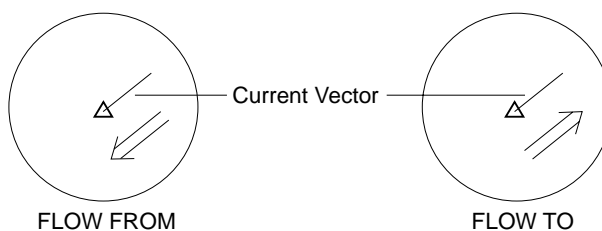

Current vector

5. MENU OPERATION

HEADING INDICATION: Chooses heading indication format, true (figures) or azimuth (compass points, for example, N, S, etc.), for the echo sounder and vertical scan modes. Requires heading data.

NORTH MARK: Turns the north marker on or off. Requires heading data.

CSE DATA: Chooses heading data source, navigator or gyrocompass, with which to draw ship's track. For heading sensor or gyrocompass, choose "GYRO".

NAV DATA: Chooses source of position data, GPS, Loran C, Loran A, DR (Dead Reckoning), Decca or Others (for equipment not shown, receives talker only).

TVG CORRECTION: Changes TVG curve to compensate for attenuation absorption of ultrasonic wave in water. OFF, standard TVG curve; 1/2, 1/2 of the theoretical absorption value added to TVG curve, and 1/1, full theoretical absorption value added to TVG curve.

UNIT: Chooses unit of depth measurement: meters, feet, fathoms, passi/braza or Hiro.

TEMP: Chooses unit of water temperature measurement: °C or °F.

TARGET L/L: Turn on to output event marker position to a video plotter. Requires heading and latitude and longitude data from external equipment.

CUSTOM KEY: Chooses function of custom mode keys: preset or short-cut. For further details, see paragraph 5.3.

EMPHASIS MODE: Chooses method of picture interpolation processing.

OFF: Interpolation close to raw signal.

NORMAL: Clarifies picture.

RED: Emphasizes strong signals.

ETA MARK: A vector line extends from the own ship marker on the horizontal mode display, in the direction of ship's bow. The tip of the line shows the estimated time of arrival after the chosen ETA time elapses, using the current ship's speed. ETA is calculated every second considering tilt and detection range. This function requires speed input.

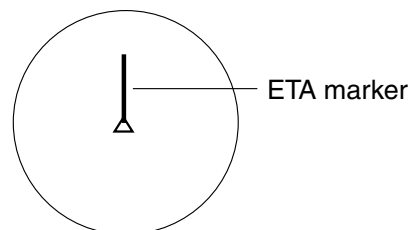

ETA marker

5.4.3 SYSTEM SETTING 2 menu description

** SYSTEM SETTING 2 **		
MENU	1	2
STABILIZER	: OFF	<input type="checkbox"/> ON
AUTO RETRACTION	: <input type="checkbox"/> OFF	(OFF, 5-15kt)
SPEED ALARM/MESSAGE	: OFF	15 kt <input type="checkbox"/> 20kt
SWEEP INDICATOR	: DOT	<input type="checkbox"/> LINE
DEFAULT SETTING	: <input type="checkbox"/> NO	YES
<p>MAXIMUM ALLOWABLE SPEED IS 15 KNOTS WHILE SOUNDOME IS BEING RETRACTED. IF VESSEL HAS RAPID ACCELERATION CAPABILITIES, AUTO RETRACTION SETTINGS OF 10-12 KNOTS ARE MANDATORY TO AVOID CATASTROPHIC DAMAGE TO SOUNDOME ASSY. ANY PHYSICAL DAMAGE TO THE SOUNDOME ASSY. IS CONSIDERED ABUSE AND IS NOT A WARRANTY ISSUE.</p>		
<p>▲ ▼ : SELECT ◀ ▶ : CHANGE MENU: END</p>		

System setting 2 menu

SYSTEM SETTING 2 menu description

STABILIZER: Choose ON to compensate for effects of ship's pitching and rolling. Requires Motion Sensor MS-100 or Clinometer BS-704.

AUTO RETRACTION: Set the speed at which automatic retraction of the transducer is to occur. Requires speed input.

Note: The transducer may be retracted at a speed other than the intended one when ship's speed data is erroneous. Therefore, set the speed considering the accuracy of speed data.

5. MENU OPERATION

SPEED ALARM MESSAGE: Choose the speed at which the speed alarm message is displayed and the aural alarm released when the speed goes higher than that set here. The audio alarm can be silenced with the [R/B] key.

[↓] pressed to lower transducer	
Speed above 15 kts	Message 1 appears. Reduce speed below 15 kts to restore normal operation.
Transducer being lowered	
Speed over 15 kts	Message 1 appears and lowering continues.
Transducer lowered	
Speed above 20 kts or 15 knots depending on this menu setting	Message 2 appears, accompanied by the audio alarm. Reduce the speed below 20 kts (or 15 kts) to restore normal operation.
[↑] pressed to raise transducer	
Speed above 15 kts	Message 1 appears, accompanied by the audio alarm. The transducer is not raised. Reduce the speed below 15 kts to erase the message and restore normal operation. Then, press [↑] again to raise the transducer.
Transducer being raised	
Speed above 15 kts	Message 1 appears and raising continues. Reduce the speed below 15 kts to erase the message.

SHIPS SPEED
EXCEEDS 15 kt.
(SLOW DOWN UNDER 15 kt WHEN
MOVING TRANSDUCER UNIT.)

PRESS R/B KEY TO SILENCE ALARM.

Message 1

TRANSDUCER REMAINS
LOWERED.
(REDUCE SHIP'S SPEED AND PRESS
↑ KEY TO RETRACT IT.)

PRESS R/B KEY TO SILENCE ALARM.

Message 2

SWEEP INDICATOR: Shows train position in the horizontal mode and tilt angle in the vertical scan mode, with a line or a dot. (See the illustration on page 2-2 and 3-2.)

DEFAULT SETTING: Choose YES and then press the [MENU] key to restore all default system menu settings. Several beeps sound while default settings are being restored and then normal operation is restored.

** FACTORY SETTING **	
ARE YOU SURE? :	<input type="checkbox"/> NO <input type="checkbox"/> YES
NOTE! ALL THE SYSTEM SETTING WILL BE CHANGED TO FACTORY SETTING.	
◀▶ : CHANGE MENU: END	

FACTORY SETTING display

5.4.4 Sonar (horizontal) mode range settings

The user may preset horizontal mode ranges as desired.

1. Choose RANGE-SONAR MODE at the SYS menu and then press ►.

** RANGE-SONAR MODE **		
1	:	<input type="text" value="10"/> (10-1600m)
2	:	<input type="text" value="20"/>
3	:	<input type="text" value="40"/>
4	:	<input type="text" value="60"/>
5	:	<input type="text" value="80"/>
6	:	<input type="text" value="100"/>
7	:	<input type="text" value="120"/>
8	:	<input type="text" value="160"/>
9	:	<input type="text" value="200"/>
10	:	<input type="text" value="250"/>
11	:	<input type="text" value="300"/>
12	:	<input type="text" value="400"/>
13	:	<input type="text" value="500"/>
14	:	<input type="text" value="600"/>
15	:	<input type="text" value="800"/>
DEFAULT SETTING :		<input type="text" value="NO"/> YES
▲ ▼ : SELECT ◀ ▶ : CHANGE MENU: END		

Range-sonar mode menu

2. Press ▲ or ▼ to choose range number desired.
3. Press ◀ or ▶ to set range.
4. Press the [MENU] key to register settings and close the menu.

To restore default horizontal mode range settings, choose DEFAULT SETTING, press ► to choose YES and then press the [MENU] key.

5.4.5 Vertical scan mode range settings

As with the horizontal mode, the user may preset the vertical scan mode's ranges.

1. Choose RANGE-VER MODE at the SYS menu and then press ►.

** RANGE-VER MODE **		
1	:	<input type="text" value="10"/> (10-600m)
2	:	<input type="text" value="20"/>
3	:	<input type="text" value="30"/>
4	:	<input type="text" value="40"/>
5	:	<input type="text" value="60"/>
6	:	<input type="text" value="80"/>
7	:	<input type="text" value="100"/>
8	:	<input type="text" value="120"/>
9	:	<input type="text" value="160"/>
10	:	<input type="text" value="200"/>
11	:	<input type="text" value="250"/>
12	:	<input type="text" value="300"/>
13	:	<input type="text" value="400"/>
14	:	<input type="text" value="500"/>
15	:	<input type="text" value="600"/>
DEFAULT SETTING :		<input type="text" value="NO"/> YES

▲ ▼ : SELECT ◀ ▶ : CHANGE MENU: END

Range-ver mode menu

2. Press ▲ or ▼ to choose range number desired.
3. Press ◀ or ▶ to set range.
4. Press the [MENU] key to register settings and close the menu.

To restore default vertical scan mode range settings, choose DEFAULT SETTING, press ► to choose YES and then press the [MENU] key.

5.4.6 Echo sounder mode range settings

As with the horizontal and vertical scan modes, the user may preset the echo sounder mode's ranges.

1. Choose RANGE-E/S MODE at the SYS menu and then press ►.

** RANGE-E/S MODE **		
1	:	<input type="text" value="10"/> (10-600m)
2	:	<input type="text" value="20"/>
3	:	<input type="text" value="30"/>
4	:	<input type="text" value="40"/>
5	:	<input type="text" value="60"/>
6	:	<input type="text" value="80"/>
7	:	<input type="text" value="100"/>
8	:	<input type="text" value="120"/>
9	:	<input type="text" value="160"/>
10	:	<input type="text" value="200"/>
11	:	<input type="text" value="250"/>
12	:	<input type="text" value="300"/>
13	:	<input type="text" value="400"/>
14	:	<input type="text" value="500"/>
15	:	<input type="text" value="600"/>
DEFAULT SETTING :		<input type="text" value="NO"/> YES
▲ ▼ : SELECT ◀ ▶ : CHANGE MENU: END		

Range-E/S mode menu

2. Press ▲ or ▼ to choose range number desired.
3. Press ◀ or ▶ to set range.
4. Press the [MENU] key to register settings and close the menu.

To restore default echo sounder mode range settings, choose DEFAULT SETTING, press ► to choose YES and then press the [MENU] key.

5. MENU OPERATION

5.4.7 Track range settings

You may choose the video plotter display scale range as follows.

1. Choose RANGE-TRACK at the SYS menu and then press ►.

** RANGE-TRACK MODE **		
1	:	<input type="text" value="500"/> (100-10000m)
2	:	<input type="text" value="1000"/>
3	:	<input type="text" value="2000"/>
4	:	<input type="text" value="4000"/>
5	:	<input type="text" value="8000"/>
DEFAULT SETTING :		<input type="text" value="NO"/> YES
▲ ▼ : SELECT ◀ ▶ : CHANGE MENU: END		

Range-track mode menu

2. Press ▲ or ▼ to choose range number desired.
3. Press ◀ or ▶ to set.
4. Press the [MENU] key to register settings and close the menu.

To restore default track range settings, choose DEFAULT SETTING, press ► to choose YES and then press the [MENU] key.

5.4.8 Color palette

The color palette lets the user change the color of echoes, background, text and menu as desired.

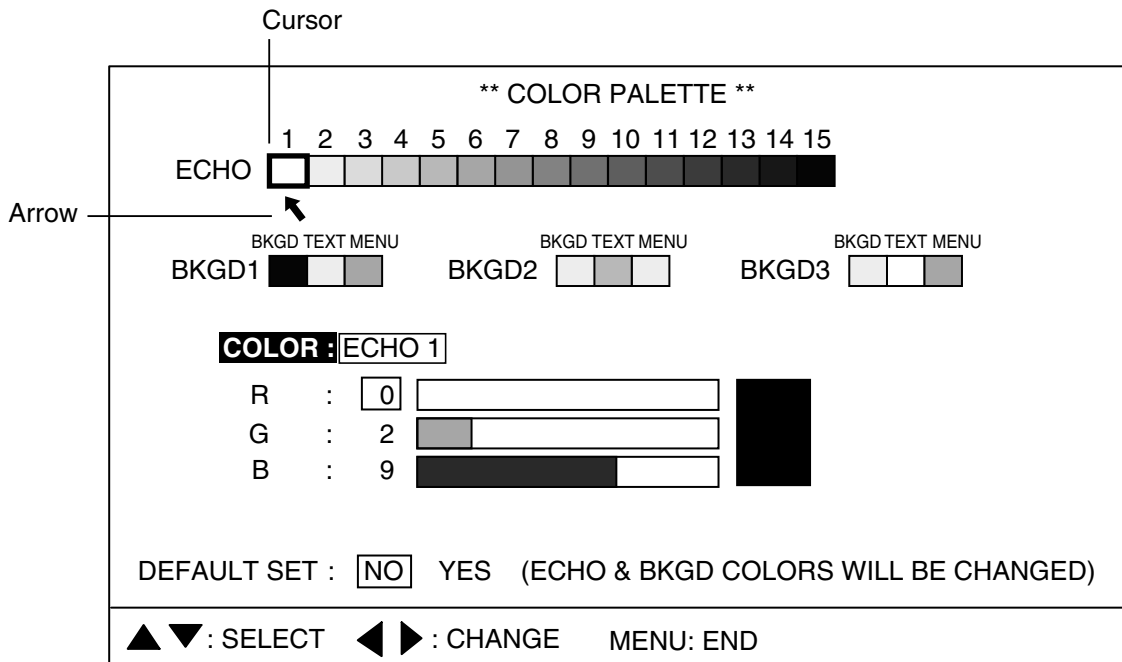

Color palette

1. Press ◀ or ▶ to place the cursor and arrow on the item to change. Pressing ▶ shifts the arrow and cursor from left to right.
2. Press ▲ or ▼ to choose R(red), G(green) or B(blue) as appropriate.
3. Press ◀ or ▶ to adjust color.
4. Press the [MENU] key to register your settings and close the menu.

To restore default color settings, choose DEFAULT SET, press ▶ to choose YES, and then press the [MENU] key. A few beeps sound while the default colors are being restored and then normal operation is restored.

5. MENU OPERATION

5.4.9 Language

Menu language can be chosen from among the languages shown in the Language menu.

** LANGUAGE **				
LANGUAGE:	JAPANESE	<input type="text" value="ENGLISH"/>	FRANCAIS	ESPAÑOL
	ITALIANO	PORTUGUES	DANSK	NORSK
	SVENSK	THAI	CHINESE	VIETNAM
◀▶ : CHANGE MENU: END				

Language menu

5.4.10 System backup

System settings can be saved to the internal memory with the menu item SYSTEM BACKUP.

** SYSTEM BACKUP **	
ARE YOU SURE?	: <input type="text" value="NO"/> YES
NOTE: OVERWRITES PREVIOUS BACKUP DATA.	
◀▶ : CHANGE MENU: END	

System backup menu

5.4.11 Loading backup data

System data may be loaded from the LOAD BACKUP DATA menu.

** LOAD BACKUP DATA **	
ARE YOU SURE?	: <input type="text" value="NO"/> YES
NOTE: OVERWRITES CURRENT SETTINGS.	
◀▶ : CHANGE MENU: END	

Load backup data menu

5.4.12 Transducer frequency adjustment

If the CH-270 is receiving interference from a video sounder or other sonar on board your ship, adjust the frequency of the CH-270's transducer to reduce the interference.

** TX FREQ ADJUST **	
FREQ SHIFT :	180.0 kHz (171-189 kHz)
◀ ▶ : CHANGE MENU: END	

TX frequency adjustment menu

5.4.13 Demonstration mode

The demonstration mode provides a simulated sonar picture to help you become acquainted with how your sonar works. Connection of the transducer is not required. All controls are operational.

1. Display the SYS menu.
2. Choose DEMO MODE.
3. Press ▶ to open the menu.

** DEMO MODE **	
DEMO MODE :	OFF ON
◀ ▶ : CHANGE MENU: END	

Demo mode menu

4. Choose OFF or ON as appropriate and then press the [MENU] key. (DEMO) appears at the top of the screen when the demonstration mode is active.

5.4.14 Restoring all default settings

All default menu settings may be restored. Choose YES and then press the [MENU] key to restore all default settings. Note that the settings stored in SYSTEM BACKUP are not disturbed.

** DEFAULT **	
ARE YOU SURE? :	<input type="checkbox"/> NO YES
NOTE: RESET ALL THE SETTINGS INCLUDED IN SYSTEM MENU TO DEFAULT.	
◀▶ : CHANGE MENU: END	

Note: All default settings will be restored. If necessary jot down settings which must be restored.

Default menu

6. MAINTENANCE, TROUBLESHOOTING

This chapter provides the information necessary for keeping the equipment in good working order.

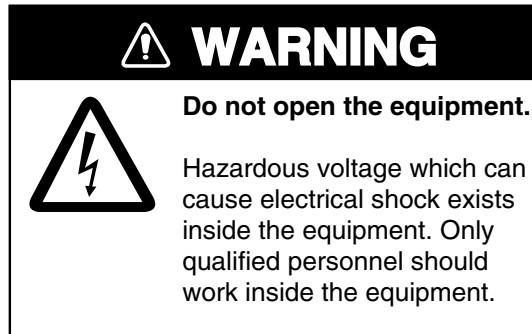

6.1 Preventive Maintenance

Check the following points monthly.

- Check all cables. If damaged, replace.
- Check connectors at rear of each unit. Clean if necessary.
- Check earth of each unit. Clean if necessary.
- Check voltage of ship's mains to be sure it is within the equipment's power rating.

6.2 Cleaning the Equipment

Dust or dirt can be removed from the exterior of equipment with a soft, dry cloth. Do not use chemical-based cleaners to clean the equipment – they can remove paint and markings.

Cleaning the LCD

Wipe the LCD carefully to prevent scratching, using tissue paper and an LCD cleaner. To remove stubborn dirt, use an LCD cleaner, wiping slowly with tissue paper so as to dissolve the dirt. Change paper frequently so the dirt will not scratch the LCD.

6.3 Hull Unit Maintenance

6.3.1 Lubrication

Coat the raise/lower screw shaft once a year with Molytone grease. Also, grease the raise/lower main shaft (upper part of the grease cotton retainer) twice a year.

6.3.2 Manually raising, lowering transducer

⚠ WARNING

Turn off the power at the ship's mains switchboard before conducting the procedure below.

Moving parts can cause bodily injury.

Hull unit CH-181

1. Turn off the breaker on the hull unit and unplug the connector on the motor lead wires in the hull unit. (This will make raising and lowering of the soundome easier, because the motor which works as a generator will be isolated from the load.)
2. Remove the top cover of the raise/lower drive assy. and attach the hand crank as shown below.

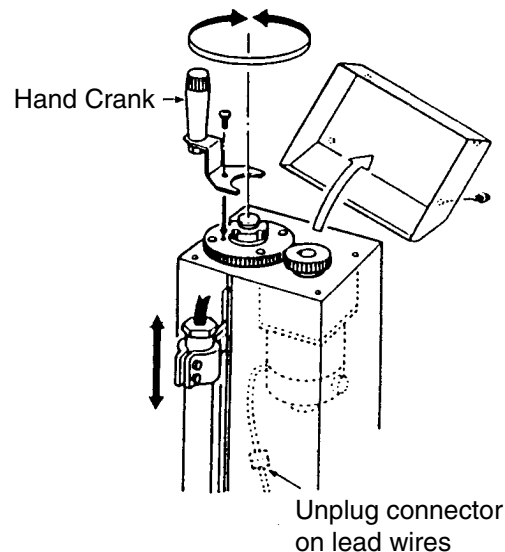

Hull unit, top cover of raise/lower assy. opened

3. Turn the hand crank to check that the transducer rises and lowers smoothly, from the upper to the lower limit positions. If the transducer cannot be raised smoothly, do not use force; the shaft may bend.

Hull unit CH-184

1. Turn off the breaker switch on the hull unit.
2. Slightly loosen the bolts fastening the shaft retainer.
3. Raise and lower the shaft by hand to confirm that it raises and lowers smoothly. If it does not rise or lower smoothly, do not use force; the shaft may bend.
4. Tighten bolts on shaft retainer. (Torque: 20-25 Nm)
5. Turn on the breaker switch.

6.4 Transducer Maintenance

When the ship is dry-docked, remove marine growth from the transducer with fine sandpaper or a piece of wood.

 CAUTION
Do not paint the transducer face. Loss of sensitivity will result.
Do not use chemical-based cleaners to clean the transducer. They can damage the transducer.

6.5 Fuse Replacement

The fuses in the hull and transceiver units protect them from overcurrent, equipment fault and reverse polarity of the ship's mains. If the power cannot be applied the fuse in the transceiver unit may have blown. Have a suitably qualified technician check the fuse.

 CAUTION
Use the proper fuse. Use of a wrong fuse can cause fire or damage the equipment.

6.6 Troubleshooting

The table below provides common symptoms of equipment troubles and the means to rectify them.

Symptom	Check, Remedy
Cannot turn on the power.	<ul style="list-style-type: none"> • Check ship's mains. • Have a suitably qualified technician check the fuse in the transceiver unit.
Bottom echo becomes irregular.	<ul style="list-style-type: none"> • Rough seas. Distance to the bottom changes due to rolling and pitching. • Long range chosen. Transmission period is longer so ship's pitching and rolling are apt to affect detection of echo.
Weak echo	<ul style="list-style-type: none"> • Output power set to minimum. Set to maximum, on the COM1 menu. • Excessive TVG. Readjust TVG on the appropriate menu (HORZ, VERT, ES). Note that readjustment of TVG is necessary whenever the gain is adjusted.
Somewhat strange picture color	<ul style="list-style-type: none"> • [BRILL] key setting too low. Increase brightness with [BRILL] key.
Picture contains noise.	<ul style="list-style-type: none"> • Equipment not grounded properly. Check equipment ground. • Power cable is too close to the signal cable. Relocate power cable or signal cable. • Debris may be on sea surface. Reject unwanted noise with the interference rejector on the COM1 menu.
Picture does not change when tilt angle is changed. (Bottom is not displayed in vertical scan picture when bottom is flat.)	<ul style="list-style-type: none"> • Problem in tilt mechanism or control line. Contact a FURUNO agent or dealer for advice.

6.7 Error Messages

The table below shows the error messages which may appear on the display. All error messages are accompanied by the audio alarm, which you may silence with the [R/B] key.

Message	Meaning, Remedy
Raise/Lower Error	
RAISE/LOWER FUNCTION HAS NOT BEEN COMPLETED. MAXIMUM ALLOWABLE SPEED IS 15 KNOTS WHILE SOUNDOME IS BEING RETRACTED. PRESS R/B KEY TO SILENCE ALARM.	Raising or lowering of transducer was not completed within 50 seconds. Silence the audio alarm with the [R/B] key and then reduce speed below 15 kt.
Train Error	
TRAINING ERROR (CHECK HULL UNIT.) PRESS R/B KEY TO SILENCE ALARM.	CPU is not receiving the heading signal. Check source of heading signal.
Tilt Error	
TILT ERROR. (CHECK HULL UNIT.) PRESS R/B KEY TO SILENCE ALARM.	CPU cannot recognize tilt position signal.
Excessive Speed	
SHIPS SPEED EXCEEDS 15 kt. (SLOW DOWN UNDER 15 kt WHEN MOVING TRANSDUCER UNIT.) PRESS R/B KEY TO SILENCE ALARM.	See SPEED ALARM MESSAGE in paragraph 5.4.3.
TRANSDUCER REMAINS LOWERED. (REDUCE SHIP'S SPEED AND PRESS ↑ KEY TO RETRACT IT.) PRESS R/B KEY TO SILENCE ALARM.	

6.8 Diagnostics

1. Press the [MENU] key to open the menu.
2. Press ▲ to choose MENU, and then press ► to choose SYS.
3. Press ▼ to choose GO TO SYS MENU.
4. Press ◀ to choose YES.
5. Choose TEST and then press ► to start the test. The lamps above the XDR switches light alternately every second while the test display is shown. In a few moments after pressing ► the results of the test appear.

```

MAIN PROGRAM NO. 0650109-**.**.
PANEL PROGRAM NO. 0650104-0**.
ROM           : OK           TX FREQUENCY      : 180kHz
RAM           : OK           ROLL           : 10
VRAM          : OK           PITCH          : 10
NMEA          : OK#

TRAIN/TILT    MOTOR TEST    COUNT: 1
  TRAIN        PULSES        NG           * TILT      PULSES      NG
                1080         0           30 > +8     319         0
                1080         0           +8 > 30     313         0
                1080         0           30 > 93     454         0
                1080         0           93 > 30     449         0

PANEL                                REMOTE CONTROL
┌──────────────────────────────────┬──────────┐
│ 127                                0 0 0      │ 0 0      │
│ (LED)                              0 0      │ 0 0      │
│ 0 ┌──────────────────┐             0 0 0      │ 0        │
│   │ 0 0 0 0          │ 0 0 0 0      │ 0 EXIT   │
│   │ 0 0 0 0          │ 0 0 0 0      │ 0 0      │
└──────────────────────────────────┴──────────┘
    
```

* = Item currently being tested.

= Requires special plug to test. Nothing displayed when plug is not connected.

** = Program Version No.

Test results

To quit the test, press the [MENU] key three times.

Interpreting the test results display

MAIN PROGRAM NO., PANEL PROGRAM NO.: The program numbers of the MAIN and PANEL programs appear at the top of the display.

ROM, RAM, VRAM, NMEA: Checked for proper operation and the results displayed as OK or NG (No Good). For NG contact a FURUNO agent or dealer for advice.

TX FREQUENCY: Shows frequency of the transducer.

ROLL and PITCH: These values change with ship's pitching and rolling (range: -30° to +30°).

TRAIN/TILT: Train/tilt test conducted maximum 1999 times, with the number of errors shown below "NG".

COUNT: Shows the number of times the test has been consecutively executed.

At the bottom of the screen there are two major groups of zeroes (0), and they represent the keys and controls on the control unit and remote controller. Press a key and its on-screen location shows "1" while the key is pressed and "0" when it is released. Operate a control and its on-screen location changes as below. When the [GAIN] control is operated the panel dimmer increases or decreases with adjustment of the control.

GAIN control: Shows 0-127.

Other controls: Shows 0-19.

6.9 Test Pattern

A test pattern can be displayed to check for proper display of colors.

1. Press the [MENU] key to open the menu.
2. Press ▲ to choose MENU, and then press ► to choose SYS.
3. Press ▼ to choose GO TO SYS MENU.
4. Press ► to choose YES.
5. Choose TEST PATTERN and then press ► to display the test pattern. Press ► again to change the test pattern. The pattern changes in the sequence shown below with each press of ►.

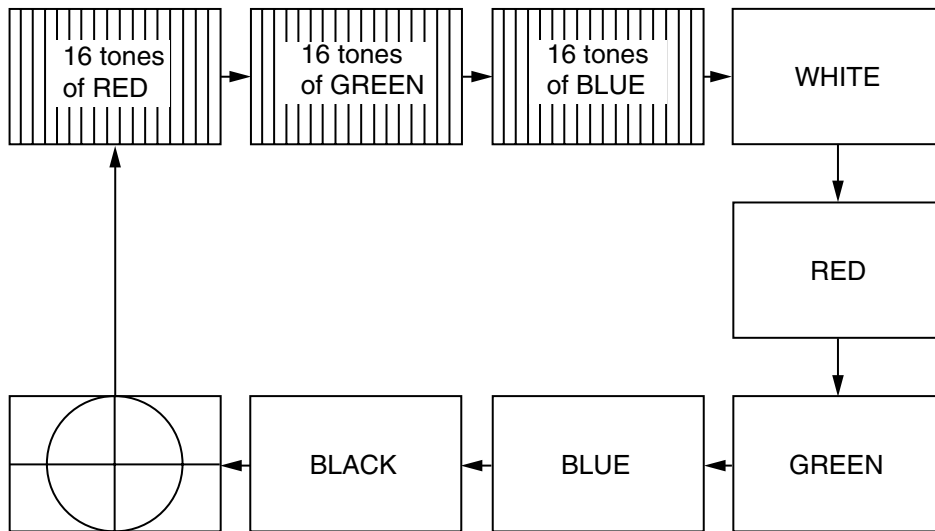

Test pattern

To quit the test pattern, press the [MENU] key three times.

MENU TREE

[MENU] key

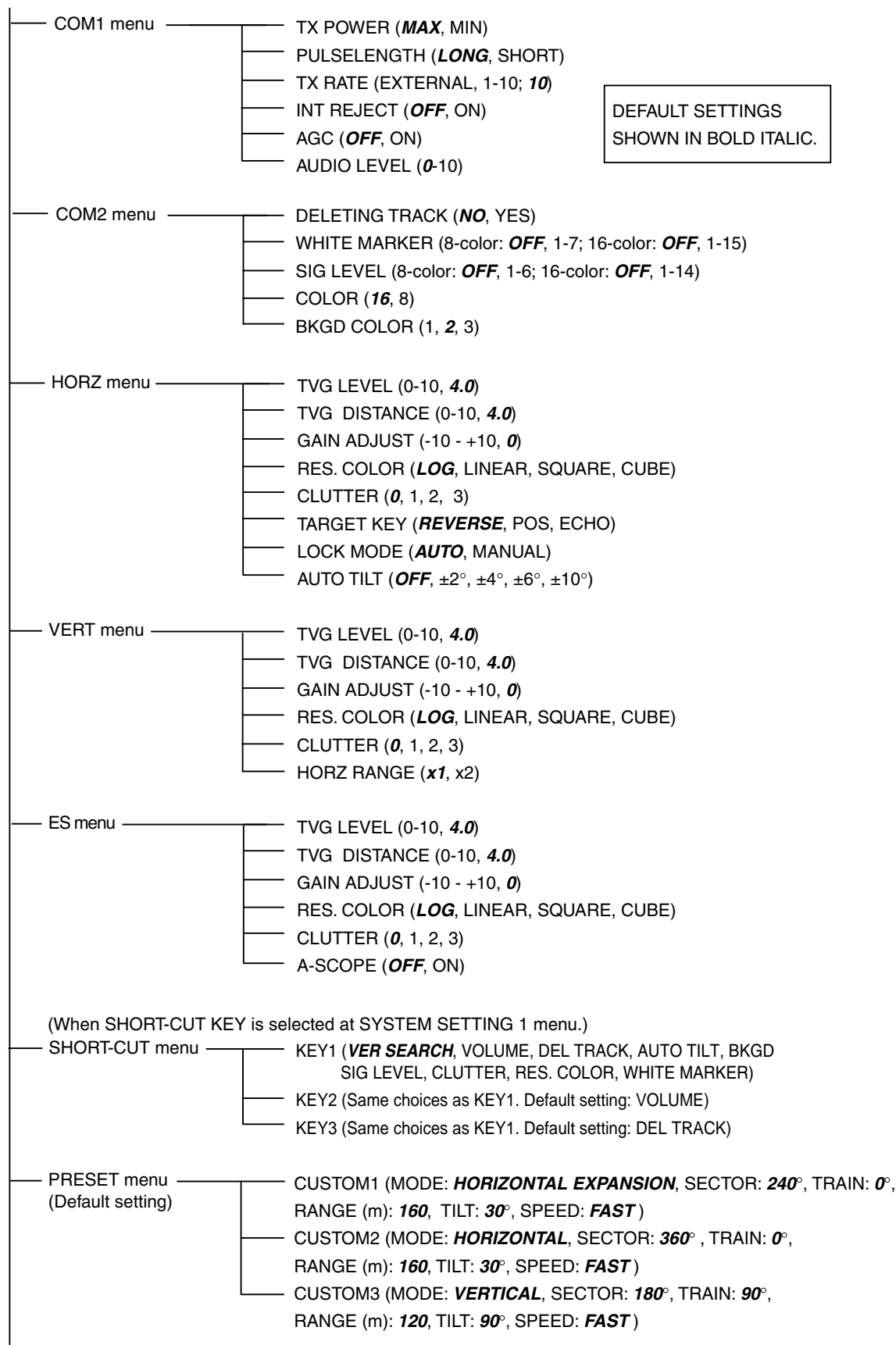

(CONTINUED ON NEXT PAGE)

MENU TREE

(CONTINUED FROM PREVIOUS PAGE)

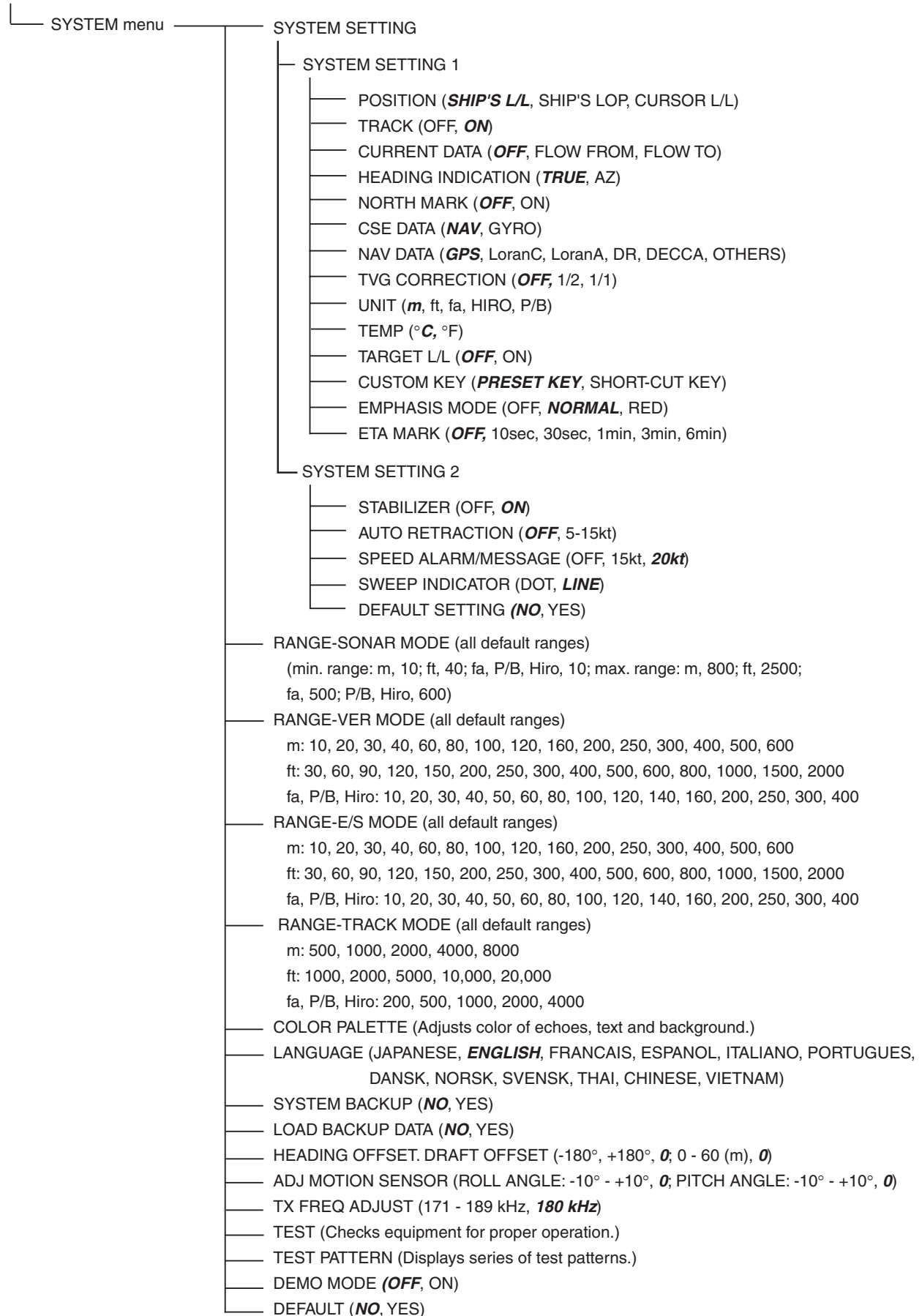

SPECIFICATIONS

1. GENERAL

- 1.1 Display System 10.4-inch color LCD (640 x 480 dots), or locally supplied monitor
- 1.2 Transmit Frequency 180 kHz
- 1.3 Output Power 0.8 kW, power reduction available
- 1.4 Range (factory settings)

Range (m)	1	2	3	4	5	6	7	8	9	10	11	12	13	14	15
Horizontal Mode															
	10	20	40	60	80	100	120	160	200	250	300	400	500	600	800
Vertical Scan Mode															
	10	20	30	40	60	80	100	120	160	200	250	300	400	500	600

- 1.5 Output Pulse Length 0.24 to 20.0 ms, according to range
- 1.6 TVG Level: 90 dB max., Distance: 0-1000 m

2. DISPLAY UNIT/ CONTROL UNIT

- 2.1 Picture Color Echo: 16 or 8 colors (echo)
Background: 3 colors selected (user setting available)
- 2.2 Display Mode Horizontal (Normal/Expanded), Vertical Scan, Echo Sounder, Vertical Search
- 2.3 Combination Display Plotter, Vertical Scan, Strata, History
- 2.4 External Data Indication L/L, Depth, Course, Ship's speed, Water current vector, Track, Water temperature (External IEC 61162 data required)
- 2.5 Audio Monitor 2 W output (4 ohms), Freq. 1.0 kHz (external speaker required)
- 2.6 Event Mark 5 points
- 2.7 Target Lock (three functions, selected on menu)
 - Scanning Reverse Scanning orientation changed by pressing key
 - Position Search Auto-search for marker setting position
 - Echo Search Auto-search for signal level in a search zone, or manual search

3. HULL UNIT

- 3.1 Transducer Travel 350 mm or 250 mm
- 3.2 Raise/lower Time 30 s at 350 mm travel, 4 s at 250 travel
- 3.3 Allowable Ship's Speed 20 knot or less (15 knot during raise/lower operation)
- 3.4 Stabilizer Within 30°, optional motion sensor or clinometer required

SPECIFICATIONS

3.5 Horizontal Mode Control

Scanning Angle: 6° to 360°, 24° step
Scanning Center: 6° steps, 360° setting available
Scanning Step Angle: Normal: 6°, High speed: 12°
Elevation Angle: +5° to 90°, 1° step
Time to Train Full Circle:

Range (m)		10	20	40	60	80	100	120	160	200	250	300	400	500	600	800
Time (sec)	Norm	11	11	11	11	11	11	11	14	17	21	25	33	41	49	65
	Fast	11	11	11	11	11	11	11	13	14	16	18	22	26	30	38

3.6 Vertical Scan Mode Control

Scanning Angle: 6° to 180°, 12° step
Scanning Center: 0° to 180°, 6° step
Scanning Step Angle: Normal: 3°, High speed: 6°
Time to Train: 360°, 6° step
Transceiver Beam Width: 8° (at 3dB/full circle).
10° (at 6dB/full circle)

4. I/O INTERFACE

- 4.1 Data Format IEC 61162-1 (NMEA 0183 Ver 1.5/2.0)
4.2 Input DBS, DBT, DPT, GGA, GLL, HDG, HDM, HDT, MDA, MTW, RMA, RMC, VDR, VHW, VTG
4.3 Output TLL

5. POWER SUPPLY

- 5.1 Transceiver Unit 12-32 VDC: 4.7-1.8 A
5.2 Hull Unit 12/24 VDC: 4.0/2.5 A
Max. 10/6 A
5.3 Rectifier 100-115/220-230 VAC, 1 phase, 50/60 Hz

6. ENVIRONMENTAL CONDITIONS

- 6.1 Ambient Temperature Transceiver unit: -15°C to +55°C
Soundome: 0°C to +35°C
Hull unit: 0°C to 45°C
6.2 Relative Humidity 95%
6.3 Waterproofing Display/ Control unit: IPX5 (IEC 60529)
Hull unit: IPX2
Transceiver unit: IPX0

7. COATING COLOR

- 7.1 Display Unit/ Control Unit Panel: N3.0, Chassis: 2.5GY5/1.5
7.2 Transceiver Unit 2.5GY5/1.5

INDEX

A

- AGC5-1
- A-scope display4-10
- Auto retraction5-11
- Auto tilt.....2-24

B

- Backup data.....5-18
- BRILL key1-7
- Brilliance1-7

C

- Clutter
 - echo sounder mode.....4-12
 - horizontal mode2-24
 - vertical scan mode.....3-15
- Color palette5-17
- Colors
 - background.....5-2
 - display.....5-2
- COM1 menu5-1
- COM2 menu5-2
- Control description.....1-1
- Current data.....5-9
- Custom key
 - choosing function.....5-4
 - preset.....5-5
 - short-cut.....5-6

D

- Default settings.....5-20
- Demonstration mode5-19
- Diagnostics6-6
- Display modes1-7

E

- Emphasis mode.....5-10
- Error messages6-5
- ETA marker5-10
- EVENT key
 - echo sounder mode.....4-5
 - horizontal mode2-11
 - vertical scan mode.....3-10
- Event marker
 - deleting from echo sounder mode.....4-6
 - deleting from horizontal mode2-12
 - deleting from vertical scan mode3-11

- inscribing in echo sounder mode4-6
- inscribing in horizontal mode2-11
- inscribing in vertical scan mode3-10

F

- FACTORY SETTING display5-12
- FAST SCAN key
 - echo sounder mode4-4
 - horizontal mode.....2-10
 - vertical scan mode3-9
- FULL/HALF control
 - horizontal mode.....2-4
 - vertical scan mode3-7
- Fuse replacement6-3

G

- GAIN control.....1-7
- Gain offset
 - echo sounder mode4-11
 - horizontal mode.....2-23
 - vertical scan mode3-14

H

- Heading data
 - indication format.....5-10
 - source5-10
- Horizontal expansion display2-18
- Horizontal/history display2-30, 2-31
- Horizontal/strata display.....2-32
- Horizontal/vertical scan display3-4
- HORZ menu2-23
- Hull unit maintenance6-2

I

- Interference rejection3-14

L

- Language5-18

M

- MAIN/SUB key2-31, 2-32
- Maintenance
 - cleaning6-1
 - fuse replacement6-3
 - hull unit.....6-2
 - preventive.....6-1
 - transducer6-3
- MENU key1-8

INDEX

- Menu tree AP-1
- N**
- North mark 5-10
- P**
- Panel dimmer 1-7
- Picture advance speed
(echo sounder mode) 4-4
- Position data
 - format 5-9
 - source 5-10
- POWER switch 1-3
- Pulselength 2-14
- R**
- R/B key
 - echo sounder mode 4-7
 - horizontal mode 2-12
 - vertical scan mode 3-11
- Range
 - echo sounder mode 4-3
 - echo sounder mode preset 5-15
 - horizontal mode 2-3
 - horizontal mode preset 5-13
 - track range preset 5-16
 - vertical scan mode 3-6
 - vertical scan mode preset 5-14
- RANGE control
 - echo sounder mode 4-3
 - horizontal mode 2-3
 - vertical scan mode 3-6
- Remote controller 1-2
- Resolution color
 - echo sounder mode 4-11
 - horizontal mode 2-23
 - vertical scan mode 3-15
- S**
- SECTOR control
 - horizontal mode 2-4
 - vertical scan mode 3-7
- Signal level 2-17
- Speed alarm message 5-12
- Stabilizer 5-11
- Sweep indicator 5-12
- SYS menu 5-8
- System configuration vii
- SYSTEM SETTING 1 menu 5-9
- SYSTEM SETTING 2 menu 5-11
- T**
- Target data output 5-10
- TARGET key 2-19, 2-20, 2-21
- Target lock
 - choosing mode 2-19
 - echo mode 2-21
 - position mode 2-20
 - reverse mode 2-19
- Test pattern 6-8
- TILT control
 - echo sounder mode 4-4
 - horizontal mode 2-6
 - vertical scan mode 3-8
- Track
 - deleting 5-2
 - on/off 5-9
 - range preset 5-16
- TRAIN control
 - echo sounder mode 4-4
 - horizontal mode 2-5
 - vertical scan mode 3-6
- Transducer
 - frequency adjustment 5-19
 - maintenance 6-3
- Transmitter output power 2-13
- Troubleshooting 6-4
- TVG
 - curve correction 5-10
 - echo sounder mode 4-8
 - horizontal mode 2-14
 - vertical scan mode 3-12
- Tx rate 5-1
- U**
- Unit
 - depth measurement 5-10
 - temperature measurement 5-10
- W**
- White marker 5-2
- X**
- XDR switch (↑) 1-4, 1-5