

# FURUNO

## OPERATOR'S MANUAL

COLOR LCD SEARCHLIGHT SONAR

MODEL CH-250



**FURUNO ELECTRIC CO., LTD.**  
NISHINOMIYA, JAPAN

© **FURUNO ELECTRIC CO., LTD.**

9-52 Ashihara-cho,  
Nishinomiya, Japan

Telephone : 0798-65-2111  
fax : 0798-65-4200

Your Local Agent/Dealer

All rights reserved.

Printed in Japan

PUB.No. OME-13160

( DAMI ) CH-250

FIRST EDITION : MAR. 2000

L : NOV. 20,2003



\* 0 0 0 8 0 8 9 4 8 0 2 \*



\* O M E 1 3 1 6 0 L 0 0 \*



# SAFETY INSTRUCTIONS



## WARNING



**ELECTRICAL SHOCK HAZARD**  
**Do not open the equipment.**

Only qualified personnel should work inside the equipment.

**Immediately turn off the power at the switchboard if water leaks into the equipment or something is dropped in the equipment.**

Continued use of the equipment can cause fire or electrical shock. Contact a FURUNO agent for service.

**Do not disassemble or modify the equipment.**

Fire, electrical shock or serious injury can result.

**Immediately turn off the power at the switchboard if the equipment is emitting smoke or fire.**

Continued use of the equipment can cause fire or electrical shock. Contact a FURUNO agent for service.

**Make sure no rain or water splash leaks into the equipment.**

Fire or electrical shock can result if water leaks in the equipment.



## WARNING

**Keep heater away from equipment.**

A heater can melt the equipment's power cord, which can cause fire or electrical shock.

**Use the proper fuse.**

The fuse in the hull and transceiver units protect them from overvoltage, equipment fault and reverse polarity of the ship's mains. If a fuse blows replace it with fuse of the same amperage. Use of a wrong fuse can result in equipment damage.

**Retract the transducer before turning off the power.**

Damage to the equipment may result. Wait until the transducer switch [↑] lights steadily and then turn off the power.

## CAUTION

Do not exceed 20 knots when operating the equipment and do not exceed 15 knots when lowering or raising the transducer.

The transducer may become damaged.

**Do not use the equipment for other than its intended purpose.**

Use of the equipment as a stepping stool, for example, may result in personal injury or damage to the equipment.

**Warning labels are attached to the display, transceiver and hull units. Do not remove the labels. If a label is missing or illegible, contact a FURUNO agent or dealer.**

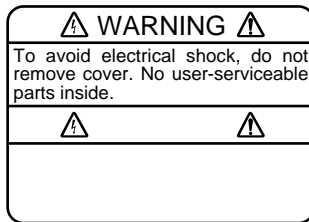

TRANSCIVER UNIT  
Name: Warning Label (1)  
Type: 86-003-1011-1  
Code No.: 100-236-231

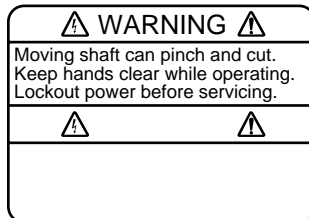

HULL UNIT  
Name: "Finger Catch"  
Warning Label  
Type: 06-021-4015-0  
Code No.: 100-281-590

## CAUTION

### WORKING WITH THE SONAR OIL

#### Precautions

- Keep oil away from eyes. Wear protective gloves when working with the oil. The oil can cause inflammation of the eyes.
- Do not touch the oil. Wear protective gloves when working with the oil. The oil can cause inflammation of the skin.
- Do not ingest the oil. Diarrhea and vomiting may result.
- Keep the oil out of reach of children.

#### Emergency procedures

- If the oil enters eyes, flush with clean water about 15 minutes. Consult a physician.
- If the oil is ingested, see a physician immediately.

#### Disposal of oil and its container

Dispose of oil and its container in accordance with local regulations. For further details, contact place of purchase.

#### Storage

Seal container to keep out foreign material. Store in dark, cool place.

## TFT LCD

The high quality TFT (Thin Film Transistor) LCD displays 99.999% of its picture elements. The remaining 0.01% may drop out or light, however this is an inherent property of the LCD; it is not a sign of malfunction.

# TABLE OF CONTENTS

---

<b>FOREWORD .....</b>	<b>v</b>
<b>SYSTEM CONFIGURATION .....</b>	<b>vii</b>
<b>1. OPERATIONAL OVERVIEW .....</b>	<b>1-1</b>
1.1 Control Description.....	1-1
1.2 Remote Controller.....	1-2
1.3 Turning the Power On/Off.....	1-3
1.4 Raising, Lowering the Transducer.....	1-4
1.5 Adjusting Screen Brilliance, Panel Dimmer .....	1-5
1.6 Selecting a Display.....	1-6
1.7 Adjusting the Gain.....	1-7
1.8 Basic Menu Operation.....	1-7
<b>2. HORIZONTAL MODE .....</b>	<b>2-1</b>
2.1 Operational Overview.....	2-1
2.2 Typical Horizontal Mode Display.....	2-2
2.3 Selecting the Range.....	2-3
2.4 Selecting Sector Width.....	2-4
2.5 Selecting Train Center.....	2-5
2.6 Selecting the Tilt Angle.....	2-5
2.7 Selecting the Training Speed.....	2-10
2.8 Finding Echo Position with the Cursor.....	2-10
2.9 Event Marker.....	2-11
2.10 Depth and Horizontal Range Markers .....	2-12
2.11 Adjusting the Picture .....	2-13
2.12 Vertical Menu Overview.....	2-18
2.13 Horizontal Menu Overview .....	2-22
2.14 Interpreting the Horizontal Display.....	2-24
<b>3. VERTICAL FAN MODE.....</b>	<b>3-1</b>
3.1 Operational Overview.....	3-1
3.2 Typical Vertical Fan Mode Display.....	3-2
3.3 Selecting the Range.....	3-3
3.4 Selecting Train Center.....	3-4
3.5 Selecting Display Sector .....	3-5
3.6 Selecting Sector Center .....	3-6
3.7 Selecting the Training Speed.....	3-7
3.8 Finding Echo Position with the Cursor.....	3-7
3.9 Event Marker.....	3-8
3.10 Depth and Horizontal Range Markers .....	3-9
3.11 Adjusting the Picture .....	3-10
3.12 Vertical Menu Overview.....	3-12
3.13 Interpreting the Vertical Fan Display.....	3-13

<b>4. ECHO SOUNDER MODE .....</b>	<b>4-1</b>
4.1 Operational Overview.....	4-1
4.2 Typical Echo Sounder Display.....	4-2
4.3 Selecting the Range.....	4-3
4.4 Train Direction.....	4-4
4.5 Selecting Tilt Angle.....	4-4
4.6 Selecting Picture Advance Speed.....	4-4
4.7 Measuring Range by Cursor.....	4-5
4.8 Event Marker.....	4-5
4.9 Range Marker .....	4-7
4.10 Adjusting the Picture .....	4-7
4.11 Echo Sounder Menu Overview.....	4-10
<b>5. MENU OPERATION.....</b>	<b>5-1</b>
5.1 COM1 Menu.....	5-1
5.2 COM2 menu.....	5-3
5.3 Short-cut Menu, Preset Menu.....	5-4
5.4 SYS Menu.....	5-9
<b>6. MAINTENANCE, TROUBLESHOOTING .....</b>	<b>6-1</b>
6.1 Preventive Maintenance.....	6-1
6.2 Cleaning the Equipment.....	6-1
6.3 Hull Unit Maintenance .....	6-2
6.4 Transducer Maintenance.....	6-3
6.5 Fuse Replacement.....	6-3
6.6 Troubleshooting .....	6-4
6.7 Error Messages.....	6-5
6.8 Diagnostics .....	6-6
6.9 Test Pattern.....	6-8
<b>MENU TREE .....</b>	<b>M-1</b>
<b>SPECIFICATIONS.....</b>	<b>SP-1</b>
<b>INDEX .....</b>	<b>IN-1</b>

# FOREWORD

---

Thank you for purchasing the CH-250 Color LCD Searchlight Sonar. We are confident you will discover why FURUNO has become synonymous with quality and reliability.

Dedicated in the design and manufacture of marine electronics equipment for half a century, FURUNO Electric Company has gained an unrivaled reputation as a world leader in the industry. This is the result of our technical excellence as well as our worldwide distribution and service network.

Please carefully read and follow the safety information and operating and maintenance instructions set forth in this manual before attempting to operate the equipment and conduct any maintenance. Your sonar will perform to the utmost of its ability only if it is operated and maintained in accordance with the correct procedures.

## Features

The CH-250 displays underwater objects on a bright 10.4" color LCD display, in 8 or 16 colors according to received echo strengths. Operating frequency is selectable among 60, 88 and 150 kHz. Eight operating modes provide information for virtually any fishing application.

The main features of the CH-250 are

- High definition active matrix color LCD.
- Target lock on a fish school or stationary position (reef, etc.).
- Audible detection of echoes frees the operator from continuous watch of the display.
- Compact display and hull units permit installation where space is limited.
- Interface IF-8000 permits use of a commercial monitor instead of standard display unit.
- Automatic pulselength switching for optimum performance in short and long ranges.
- Eight operational modes: Horizontal, Expanded Horizontal, Vertical Fan, Echo Sounder, Horizontal/Vertical Fan, History, Video Plotter and Strata.
- Automatic retraction of transducer at operator-selected ship's speed between 5 and 15 knots.
- CUSTOM MODE keys provide one-touch setup of the equipment or short-cut key function.
- Tracing of ship's track with connection of position-fixing equipment (GPS, etc.).
- One of the echo strengths may be displayed in white to enhance the specific echo level.
- The "Vertical Search" feature provides a cross-sectional view of the vertical plane, which is useful for evaluating fish school concentration.

## Usage Precautions

- The Motion Sensor MS-100 compensates for ship's pitching and rolling. However, it does not compensate for load unbalance.
- If the equipment will not be used for a long time shut off the power to it at the mains switchboard to prevent battery discharge.
- If the soundome is to be operated while the ship is dry-docked set the transmitter output power to "minimum" on the COM1 menu. Damage to the train-tilt section may result if it is operated with maximum transmitter power.
- When the ship is dry-docked check for signs of corrosion on the soundome. Find the reason for the corrosion and attach a zinc plate to the hull unit as an anticorrosion measure if necessary.



# SYSTEM CONFIGURATION

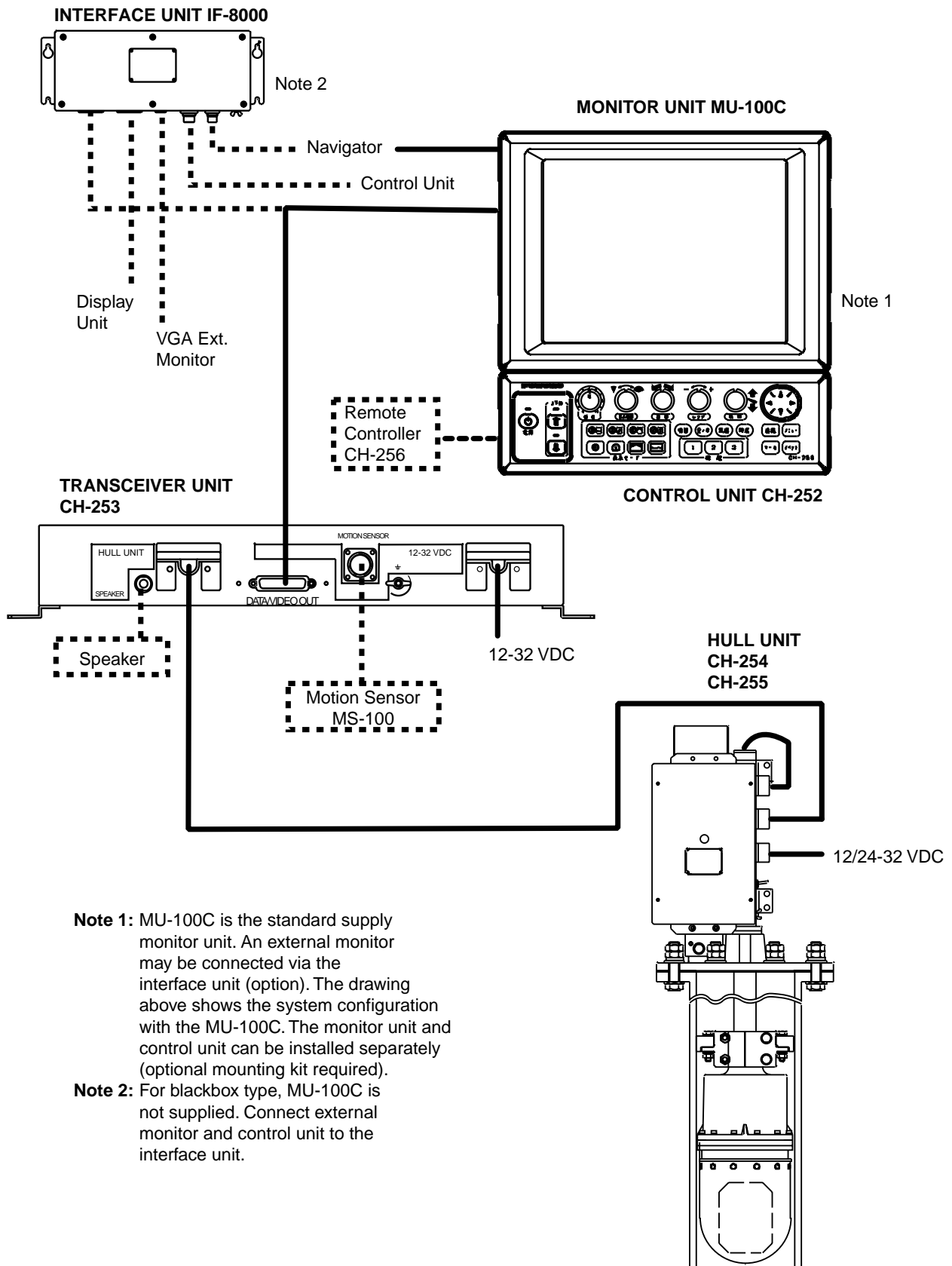

*(This page intentionally left blank.)*

# 1. OPERATIONAL OVERVIEW

## 1.1 Control Description

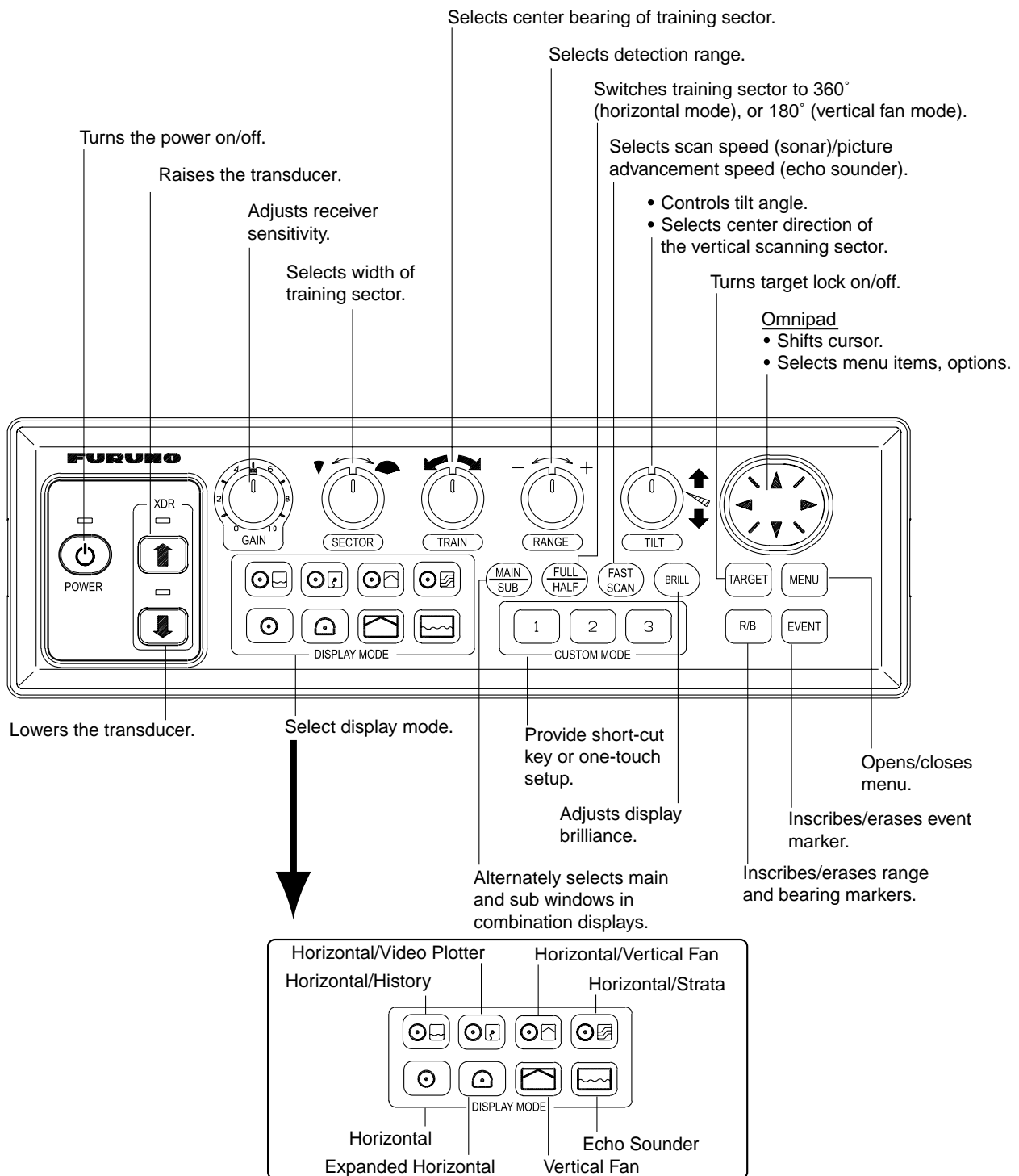

Figure 1-1 Control unit

## 1.2 Remote Controller

The Remote Controller CH-256 (option) provides armchair control over range, tilt, target lock and range of sounding.

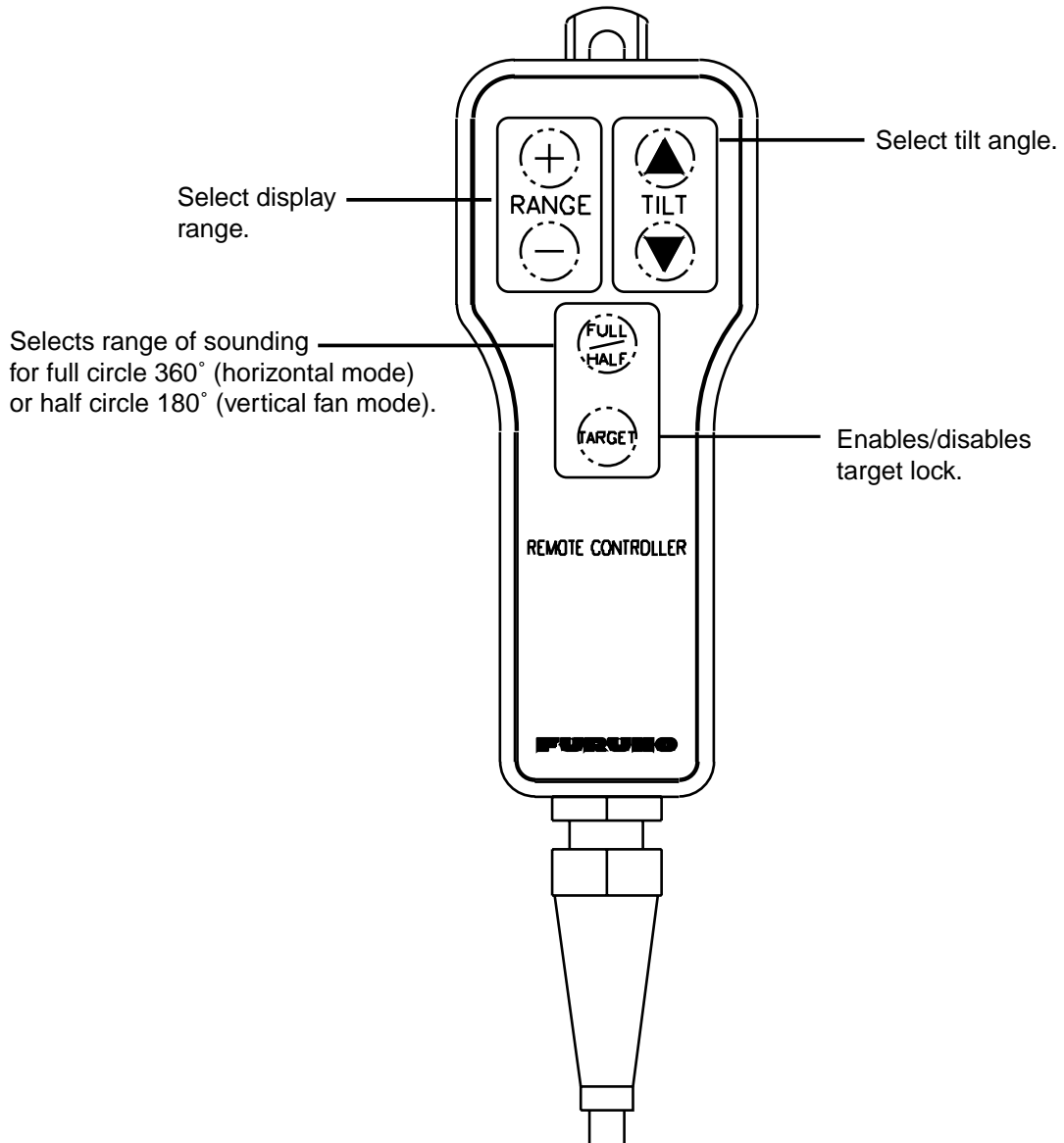

Figure 1-2 Remote controller

**Note:** The remote controller can also be used with a commercial monitor.

## 1.3 Turning the Power On/Off

### 1.3.1 Power on

This sonar has a demonstration mode which lets the operator become acquainted with the features of the sonar. For further details see page 5-18.

Press the [POWER] switch on the control unit till hear “click.” A beep sounds, the lamp above the switch lights and the last-used display appears.

**Note:** Wait at least five seconds before reapplying the power.

### 1.3.2 Power off

1. Press the [↑] switch on the control panel. The lamp above the switch blinks while the transducer is being raised and lights steadily when it is fully raised.

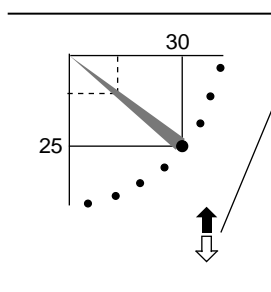

#### Transducer status indicator

- Up arrow is filled when transducer has been retracted into the tank.
- Down arrow is filled when transducer has been fully lowered.
- Appropriate arrow flashes during raising/lowering of transducer.

**NOTE:** When the transducer is being raised automatically (auto raise feature), the arrows are filled and the up arrow flashes. When the transducer has been fully retracted, the up arrow lights and the down arrow becomes hollow.

2. Press the [POWER] switch after the [↑] switch lights steadily.

**Note 1:** The transducer is automatically retracted into the tank if the [POWER] switch is pressed before retracting the transducer. However, for safety purposes, make it a habit to retract the transducer before turning off the power.

**Note 2:** After changing settings, wait at least one minute before turning off the equipment to allow the equipment to memorize settings, and start up with them at the next powering of the equipment. No harm will result to the equipment if this not done.

## 1.4 Raising, Lowering the Transducer

### 1.4.1 Lowering the transducer

With the boat at the fishing ground, press the [↓] switch to lower the transducer. The lamp above the switch blinks while the transducer is being lowered and lights when it is completely lowered. The down arrow of the transducer status indicator at the top right corner of the display is filled when the transducer is completely lowered.

 <b>CAUTION</b>
<b>Do not exceed 20 knots when operating the equipment and do not exceed 15 knots when lowering or raising the transducer.</b>
The transducer may become damaged.

### 1.4.2 Raising the transducer

Press the [↑] switch to raise the transducer. The lamp above the switch blinks while the transducer is being raised and lights steadily when it is fully raised. The up arrow of the transducer status indicator at the top right corner of the display is filled when the transducer is fully retracted.

**Note 1:** With speed input, the transducer can be raised automatically when the ship's speed exceeds a preset speed between 5 and 15 knots. If speed data is erroneous the transducer may be raised at a speed different from the preset speed. For further details about the automatic retraction feature, see AUTO RETRACTION on page 5-12.

**Note 2:** An alarm may sound depending on ship's speed. For details see page 5-13.

## 1.5 Adjusting Screen Brilliance, Panel Dimmer

Screen brilliance can be adjusted in nine steps and panel dimmer (backlighting) in four.

1. Press the [BRILL] key to open the dialog box for screen brilliance and panel dimmer. Do the next step within four seconds, otherwise the dialog box will be erased.

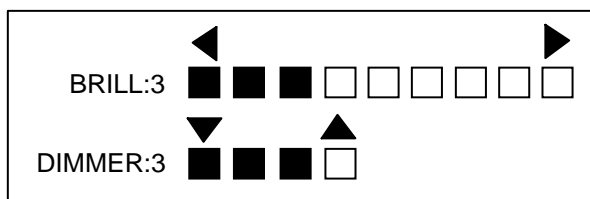

*Figure 1-3 Brilliance, panel dimmer dialog box*

2. Operate ◀ or ▶ to adjust screen brilliance (0 is the lowest brilliance; 9 the highest). Note that continuous pressing of the [BRILL] key also changes the brilliance level.
3. Operate ▲ or ▼ to adjust the panel dimmer (0 is the lowest level; 4 is the highest).
4. Press the [MENU] key to register settings and close the dialog box. Note that the dialog box is automatically erased if there is no control operation within about four seconds.

**Note 1:** The brilliance of a commercial monitor cannot be adjusted with the [BRILL] key. Use the associated control on the monitor.

**Note 2:** For the supplied monitor unit, if you turn off the power with the brilliance set at minimum the screen will show nothing at next power-up. In this case press the [BRILL] key several times.

# 1.6 Selecting a Display

This sonar has eight display modes and you may select one with one of the DISPLAY MODE keys. Refer to the chapter shown in the illustration for more information about each mode.

Key	Picture	Key	Picture
	<p><b>HORIZONTAL</b></p> <p>This mode provides 360 degree coverage. Useful for general search. (Chapter 2)</p>		<p><b>EXPANDED HORIZONTAL</b></p> <p>Zoomed horizontal picture appears over the entire screen. (Chapter 2)</p>
	<p><b>VERTICAL FAN</b></p> <p>Vertical section of underwater conditions appears on the entire screen. (Chapter 3)</p>		<p><b>ECHO SOUNDER</b></p> <p>Using a fixed spot beam this display shows fish echoes below or around the vessel. (Chapter 4)</p>
	<p><b>HORIZONTAL/HISTORY</b></p> <p>The horizontal picture appears in the main window; the history picture in the sub window. Useful for showing history of fish movement, distribution. (Chapter 2)</p>		<p><b>HORIZONTAL/VIDEO PLOTTER</b></p> <p>The horizontal picture appears in the main window and the video plotter picture, which traces ship's track, in the sub window. (Chapter 2)</p>
	<p><b>HORIZONTAL/VERTICAL FAN</b></p> <p>The horizontal picture appears in the main window; the vertical fan picture in the sub window. (Chapter 3)</p>		<p><b>HORIZONTAL/STRATA</b></p> <p>The horizontal picture appears in the main window; the strata picture in the sub window. The strata picture shows bottom undulations in different colors. It is useful in bottom trawling to avoid projections. (Chapter 2)</p>

Figure 1-4  
Display modes



## 1.7 Adjusting the Gain

The [GAIN] control adjusts the sensitivity of the receiver. Normally, the control is adjusted so that the bottom echo is displayed in reddish-brown mixed with red. Initially set the gain between "4" and "6" and then fine tune depending on fishing ground, etc.

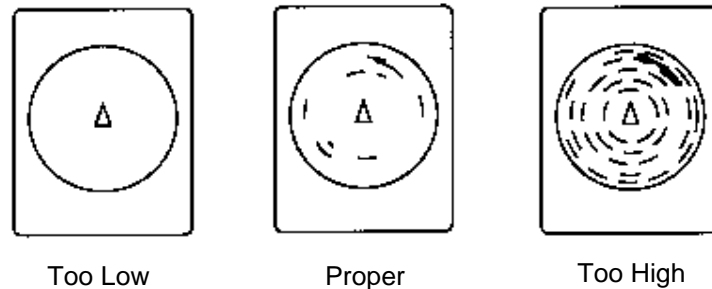

Figure 1-5 How to adjust the gain

## 1.8 Basic Menu Operation

The menu, consisting of six menus, mostly contains items which once preset do not require frequent adjustment. Below is the procedure for basic menu operation.

1. Press the [MENU] key to open the menu.

**Note:** Either PRESET (default setting) or SHORT-CUT appears between ES and SYS at the top of the screen depending on the setting of CUSTOM KEY on the SYSTEM SETTING 1 menu, and they set the function of the custom keys [1], [2], [3]. For further details see pages 5-3 through 5-7.)

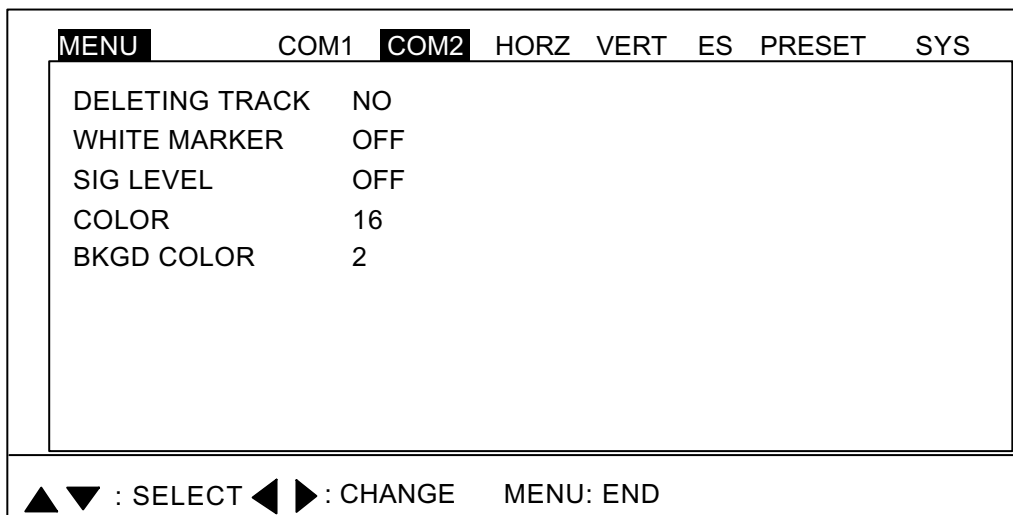
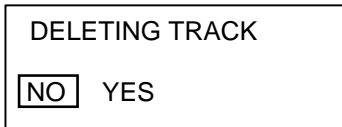

Figure 1-6 COM2 menu

2. The last-used menu is displayed. (In Figure 1-6 the COM2 menu is selected.) To select a different menu, press ▲ to select MENU at the top of the screen and then press ◀ or ▶ to select menu desired.
3. Press ▲ or ▼ to select menu item desired. At the bottom of the screen menu help is provided.
4. Press ▶ to open the corresponding dialog box. The example below shows the dialog box for DELETING TRACK in the COM2 menu.



*Figure 1-7 Dialog box for deleting track*

5. Press ◀ or ▶ to select option desired. If the option requires selection of numeric data, use ◀ or ▶ to lower or raise the figure, respectively.
6. Press ▲ or ▼ to return to the menu, or press the [MENU] key to register your selection and close the menu.

# 2. HORIZONTAL MODE

## 2.1 Operational Overview

The figure below shows the typical horizontal mode operating sequence.

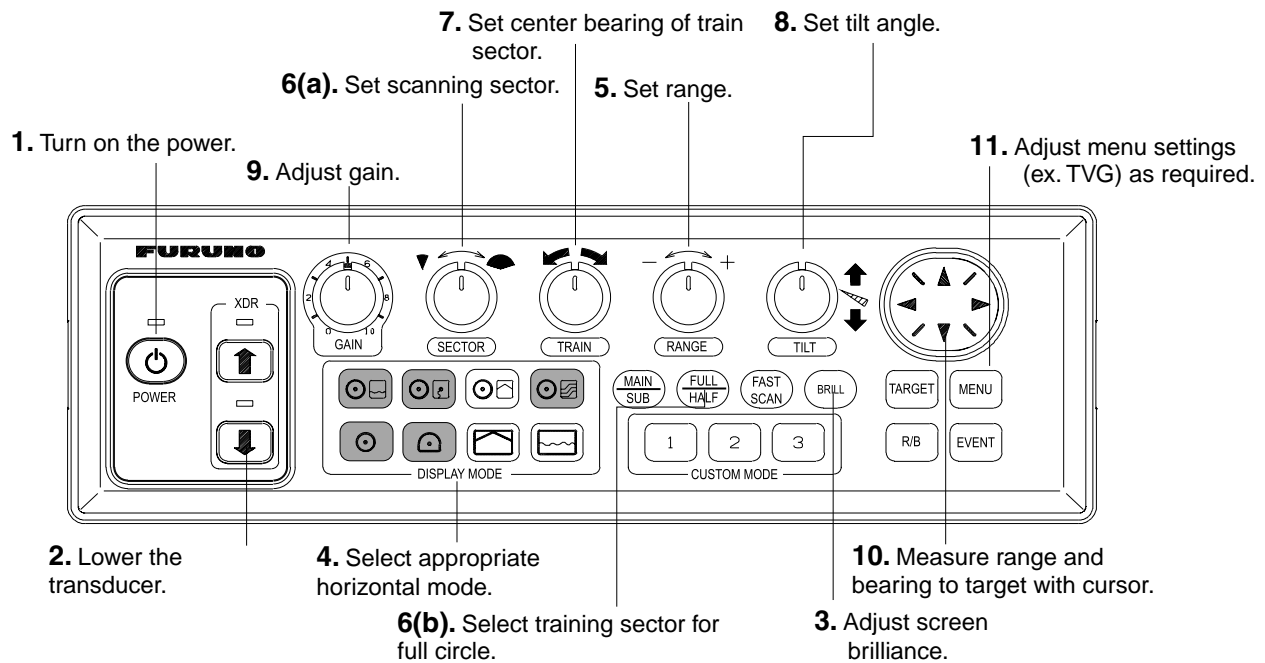

Figure 2-1 Control panel

## 2.2 Typical Horizontal Mode Display

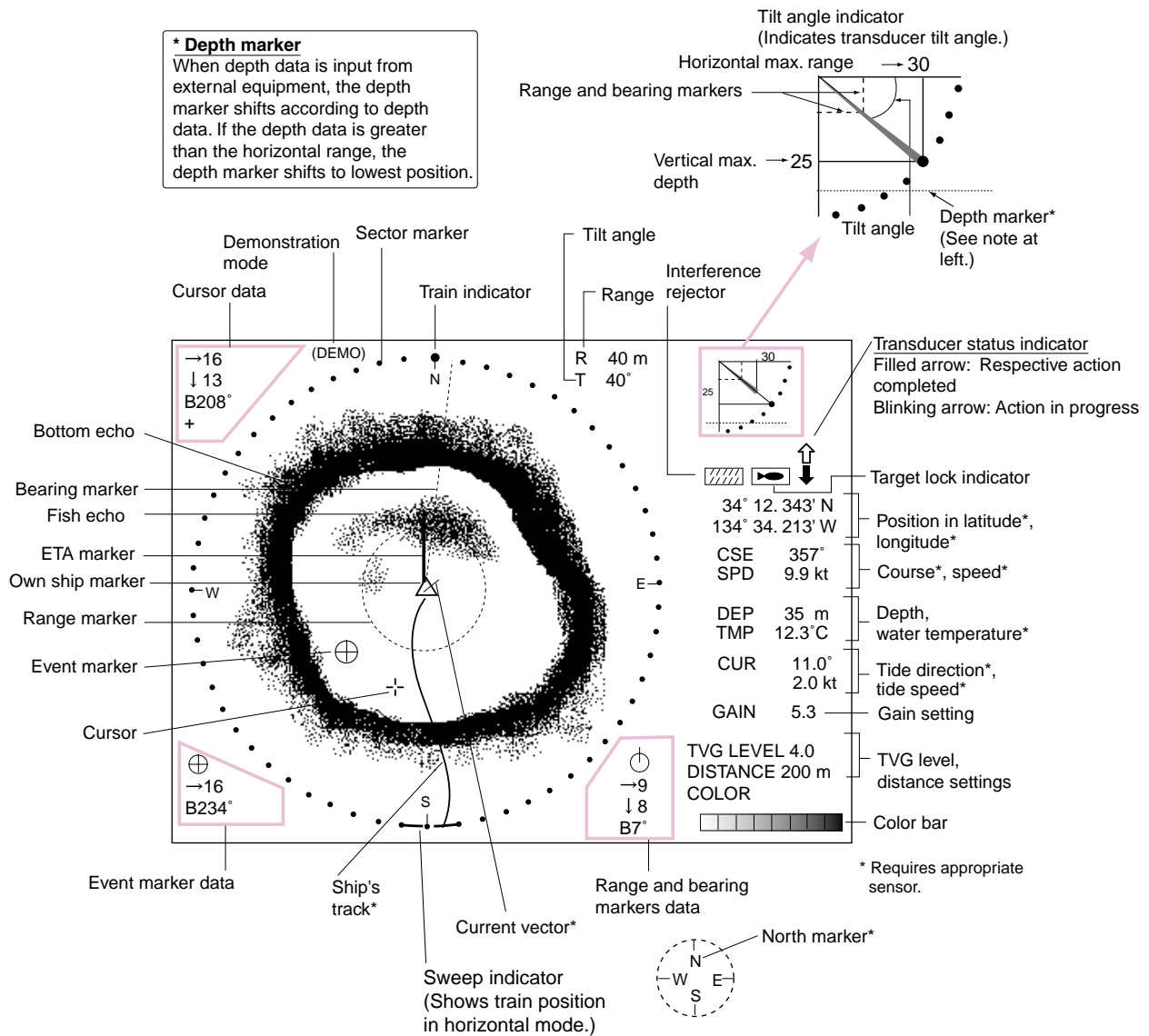

Figure 2-2 Typical horizontal mode display

With the tilt angle lowered, your ship is at the center, the bottom, which appears in reddish-brown color, is displayed as a circle and fish echoes appear within the circle.

## 2.3 Selecting the Range

The [RANGE] control selects the detection (display) range. Select the range according to either the fish species being searched or the depth desired. 15 ranges are available and minimum and maximum ranges depend on the transducer used.

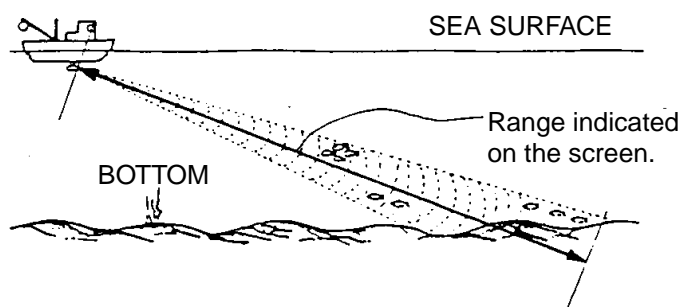

Figure 2-3 How to select the range

### Default horizontal mode range settings

Range	60 kHz		88 kHz		150 kHz	
	m	ft	m	ft	m	ft
No.1	10	40	10	40	10	40
No.2	20	80	20	80	20	80
No.3	40	120	40	120	40	120
No.4	80	200	80	200	60	200
No.5	120	300	120	300	80	300
No.6	160	400	160	400	120	400
No.7	200	500	200	500	160	500
No.8	250	600	250	600	200	600
No.9	300	800	300	800	250	700
No.10	400	1000	400	1000	300	800
No.11	500	1500	500	1500	400	1000
No.12	600	2000	600	2000	500	1500
No.13	800	3000	800	2500	600	2000
No.14	1200	4000	1000	3500	800	2500
No.15	1600	5000	1200	4000	1000	3500

Normally the range is set so that the bottom is traced at the lower part of the screen (like an echo sounder). Each time the [Range] control is operated the newly selected range briefly appears in large characters at the screen top. Range is always displayed at the right-hand corner of the screen.

**Note 1:** Unit of range measurement may be selected for meters, feet, fathoms, passi/braza or Hiro (Japanese) with UNIT on the SYSTEM SETTING 1 menu. For details see page 5-10.

**Note 2:** Ranges may be freely preset as desired. For details see page 5-14.

## 2.4 Selecting Sector Width

Sector means the width of the transducer training.

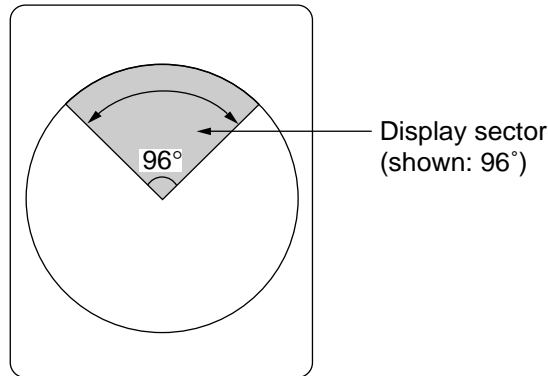

Figure 2-4 Display sector

The [SECTOR] control selects the training (display) area among the sixteen positions shown in the table below. Clockwise rotation of the control increases the sector width; counterclockwise rotation decreases it.

	1	2	3	4	5	6	7	8	9	10	11	12	13	14	15	16
Sector width (°)	6	24	48	72	96	120	144	168	192	216	240	264	288	312	336	360

In the full-circle mode (360°) the direction of training is clockwise; in the half-circle mode the direction is clockwise to counterclockwise alternately.

### One-touch selection of 360° sector

Each pressing of the [FULL/HALF] key alternately selects 360° sector (full circle) or 168° sector (half circle). If the [SECTOR] control is operated following the selection of the full-circle display, the next pressing of the [FULL/HALF] key presents the full-circle display.

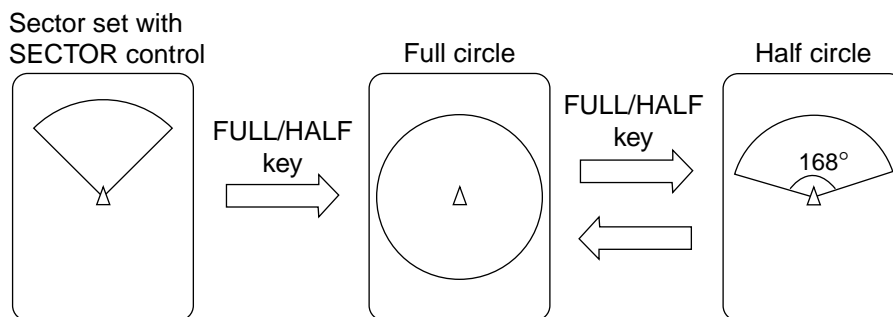

Figure 2-5 How the FULL/HALF key works

## 2.5 Selecting Train Center

The [TRAIN] control selects the center direction of the detection range. The range of adjustment is  $0^{\circ}$  to  $354^{\circ}$  in increments of  $6^{\circ}$ . The selected bearing is shown with a filled circle, the train indicator, on the bearing scale.

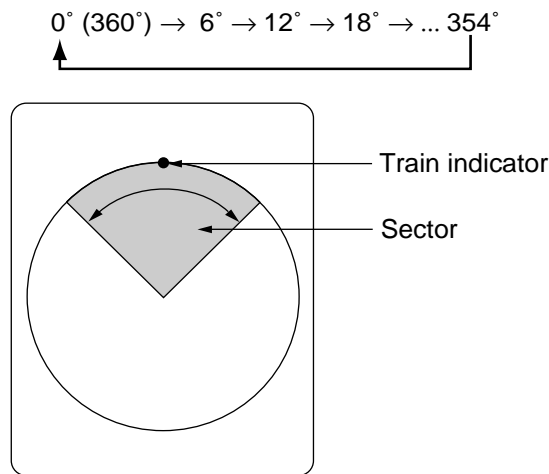

Figure 2-6 Train center

## 2.6 Selecting the Tilt Angle

The tilt angle shown the direction to which the sound wave is emitted. When the sound wave is emitted horizontally, the tilt angle is said to be  $0^{\circ}$  and when emitted vertically,  $90^{\circ}$ .

To set a tilt angle, operate the [TILT] control. Watch the tilt angle indication and tilt angle indicator at the top right corner of the screen. The tilt angle can be set in increments of  $1^{\circ}$  from  $0^{\circ}$  to  $+5^{\circ}$  (upward) to  $0^{\circ}$  to  $90^{\circ}$  (downward).

Select tilt angle depending on target fish. For surface fish select a narrow angle (about  $5^{\circ}$ ) and for bottom fish, a wide angle (about  $40^{\circ}$ ).

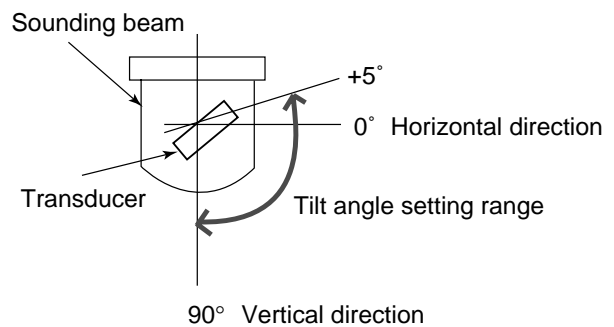

## 2.6.1 Bottom echo and tilt angle

Refer to the illustration below.

### Case1: Tilt angle 30° to 40°

This tilt angle will display the entire bottom since it is captured by the full width of the beam.

### Case2: Tilt angle 10° to 20°

This tilt angle will only display half the bottom since it is only captured by the lower half of the beam.

### Case3: Tilt angle 0° to 5°

This tilt angle may or may not capture the bottom since the returning echo is weak.

## 2.6.2 How to discriminate fish echoes from the bottom

The figure at the bottom of the page illustrates how two fish schools "a" and "b" are displayed on the screen using three different tilt angles.

**Case 1(Tilt angle 30° to 40°):** Fish school is obscured by the bottom.

**Case 2(Tilt angle 10° to 20°):** Fish school is located above the bottom (midwater).

**Case 3(Tilt angle 0° to 5°):** Fish school is located close to the bottom.

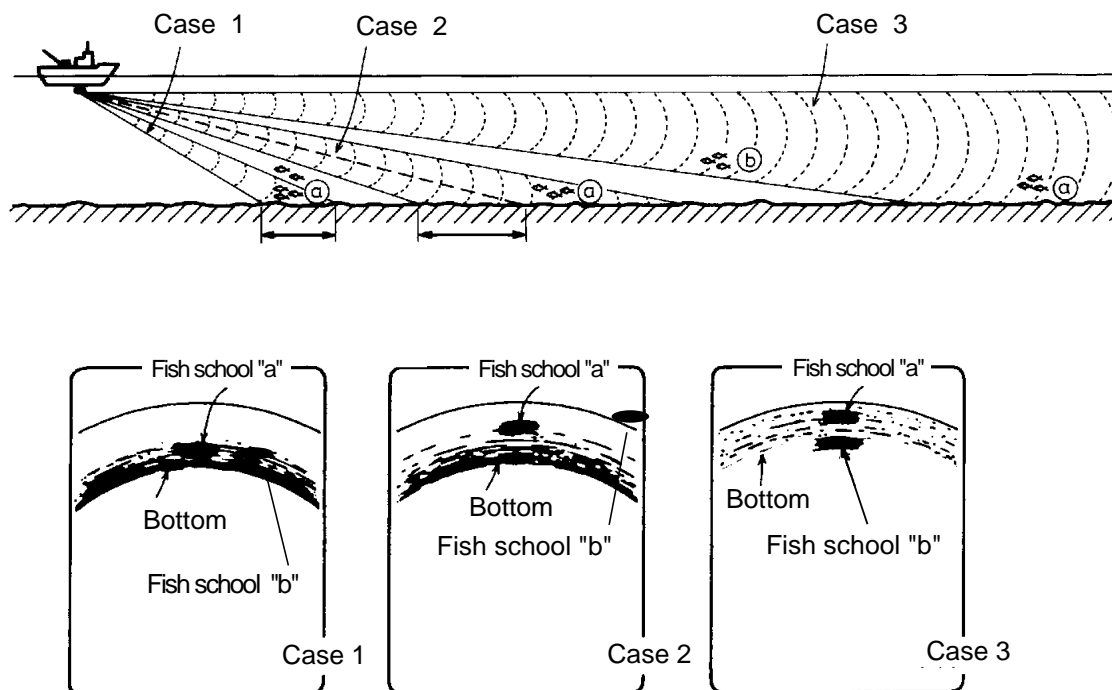

Figure 2-7 Fish echo and tilt angle



## **Points to consider**

Normally, a vertically distributed fish school is a better sonar target than the bottom, because it reflects the transmitted pulse back toward the transducer.

In case 3, both fish schools “a” and “b” are presented. Generally speaking, however, midwater fish schools tend to be larger than bottom fish schools and they are often displayed near the bottom on the display.

It is difficult to detect bottom fish when they are not distributed vertically.

### **2.6.3 Tilt angle for surface fish**

Sound emitted from the sonar transducer forms an oval-shaped beam with a width of approximately  $12^\circ$  (for 60 kHz transducer at  $-3$  dB) in the vertical direction (vertical beam width). The tilt angle is indicated by the angle between the center line is parallel with the sea surface and one half of the emitted sound goes upward, toward the sea surface.

This causes one half of the emitted sound to be reflected toward the transducer and displayed on the screen as sea surface reflections. When the sea is calm, since the sound is reflected just like reflections become negligible.

However if the sea is not calm enough, they will become dominant and interfere with observation of wanted echoes. To minimize these sea surface reflections and to search fish schools effectively, the tilt angle is usually set between  $5^\circ$  and  $6^\circ$  so the upper portion of the beam becomes almost parallel with the sea surface. When the sea is rough, the tilt angle is slightly increased to lessen the affect of sea surface reflections.

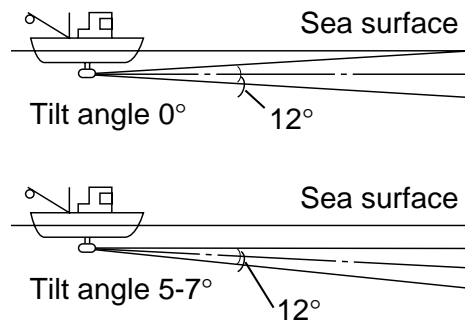

*Figure 2-8 Tilt angle*

## 2.6.4 Suitable tilt angle

The figure below illustrates the relationship among tilt angle, depth and detection range. Refer to it to find out the suitable tilt angle for a given depth/detection range.

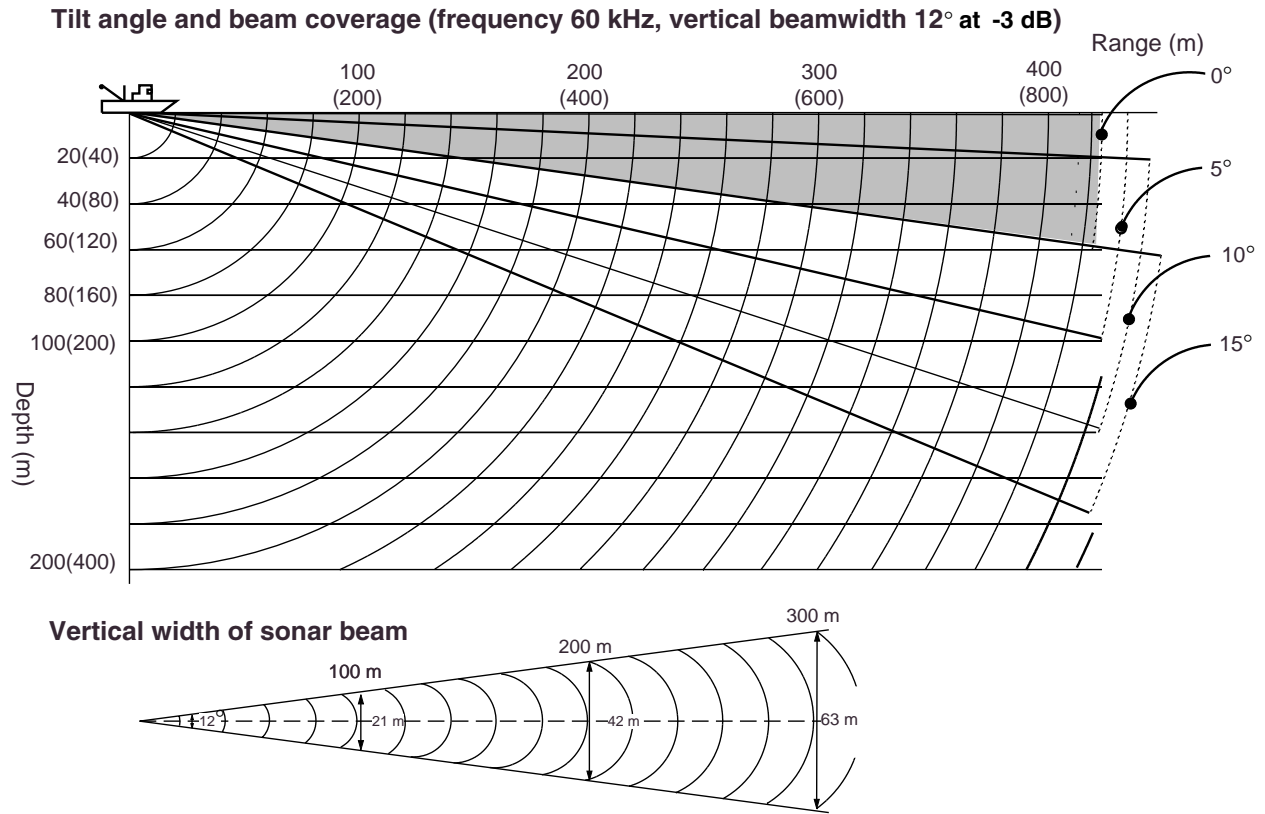

Figure 2-9 Tilt angle and beam coverage

## 2.7 Selecting the Training Speed

The training speed selects how fast the transducer scans the sounding sector. Two choices are available, normal speed (default setting) and high speed, and one may be selected with the [FAST SCAN] key. Each time the key is pressed “NORM” (normal speed) or “FAST” (high speed) momentarily appears at the screen top.

Normal (6°) : 60 transmissions required to complete full 360° picture (default setting).

High (12°) : 30 transmissions required to complete the full 360° picture.

The time necessary to train a full circle depends on range and transducer used. The table below shows the time required to complete one full circle in the horizontal mode using the 150 kHz transducer.

Ranges		1	2	3	4	5	6	7	8	9	10	11	12	13	14	15
Unit	m	10	20	40	60	80	120	160	200	250	300	400	500	600	800	1000
	ft	40	80	120	200	300	400	500	600	700	800	1000	1500	2000	2500	3500
Time required (sec) for one full circle	Norm	7	7	7	7	7	10	13	16	20	24	32	40	48	64	81
	Fast	7	7	7	7	7	9	11	13	15	17	21	25	28	36	45

**Note1:** Above data for soundome having serial no. 1000 and higher.

**Note2:** The range setting must be at least 160 m to active high speed training, using the 150 kHz transducer. The [FAST SCAN] key is inoperative when the range setting is less than 160 meters.

## 2.8 Finding Echo Position with the Cursor

The cursor measures horizontal range, depth and bearing. Operate the Omnipad to place the cursor where desired. Cursor position data appears at the top left-hand corner on the screen.

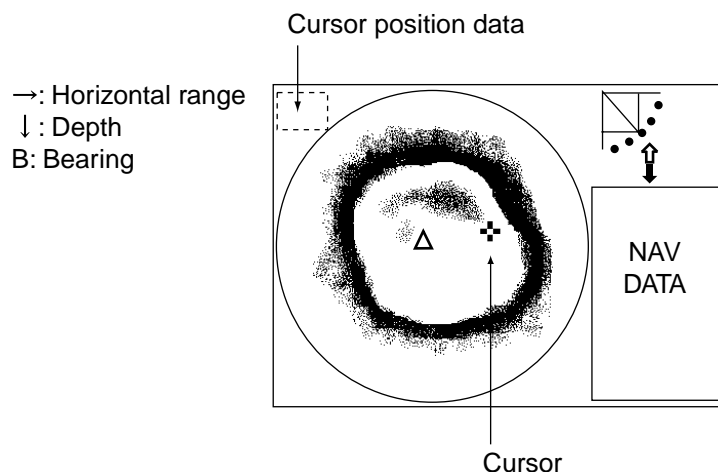

Figure 2-10 Location of cursor position data

## 2.9 Event Marker

The event marker functions to mark important locations on the screen, and five event markers may be inscribed. Each time the [EVENT] key is pressed the "latest event marker" (⊕) is inscribed at the cursor location and all previously entered event markers are shown by the "previous event marker" (+). When the capacity for event markers is reached the eldest event marker is erased from the screen to make room for the latest.

**Note 1:** With position data the event marker moves with ship's movement. The event marker can be inscribed without position data, however it will be stationary.

**Note 2:** The event marker cannot be inscribed from the sub window (strata, history and video plotter displays). It can only be inscribed from the main window.

**Note 3:** Event marker position can be output to external equipment and marked on the display of the external equipment. Each press of the [EVENT] key outputs event marker position. For details see TARGET L/L on page 5-11.

**Note 4:** The tilt angle must be less than 75 degrees to use this feature.

### 2.9.1 Inscribing the event marker

1. Operate the Omnipad to place the cursor on the location desired for an event marker.
2. Press the [EVENT] key to inscribe the event marker. Event marker data appears at the bottom left-hand corner.

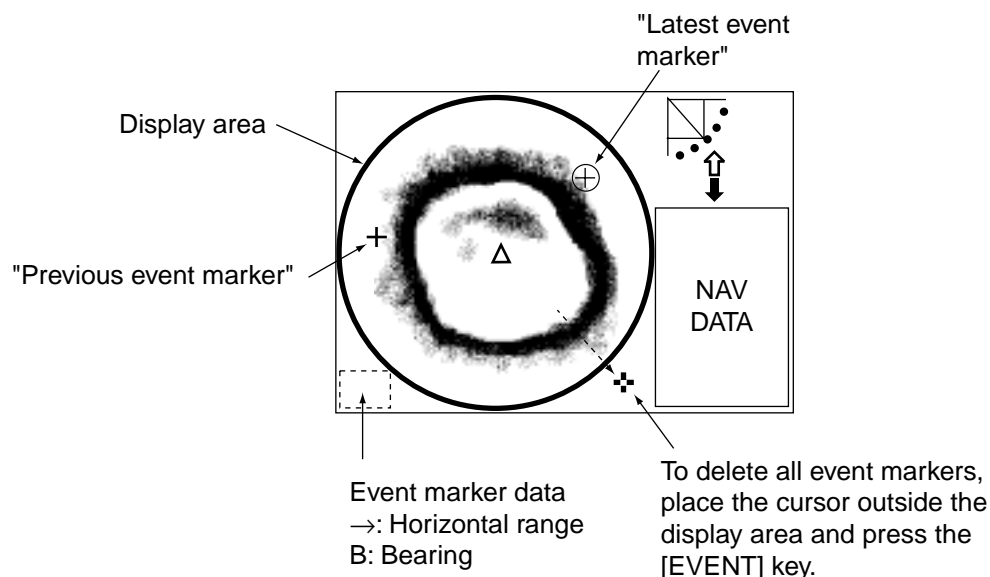

Figure 2-11 How to use the event marker

## 2.9.2 Deleting all event markers

All event markers can be erased from the screen as follows:

1. Operate the Omnipad to place the cursor outside the display area.
2. Press the [EVENT] key to show the following dialog box. Do the next step within four seconds, otherwise the dialog box will be erased.

DELETE EVENT MARK?	
<input type="checkbox"/> NO	<input type="checkbox"/> YES

3. Press **▶** to select YES and press the [MENU] key. All event markers are erased from the screen.

## 2.10 Depth and Horizontal Range Markers

The horizontal range, depth and bearing to a fish school can be measured by using the range and bearing markers.

1. Operate the Omnipad to place the cursor on the location desired.
2. Press the [R/B] key to display the range and bearing markers. Horizontal range, depth and bearing to the cursor location are shown at the bottom right-hand corner of the screen..
3. To erase the range and bearing markers, place the cursor outside the display area and press the [R/B] key, or place the cursor on the range or bearing marker and press the [R/B] key.

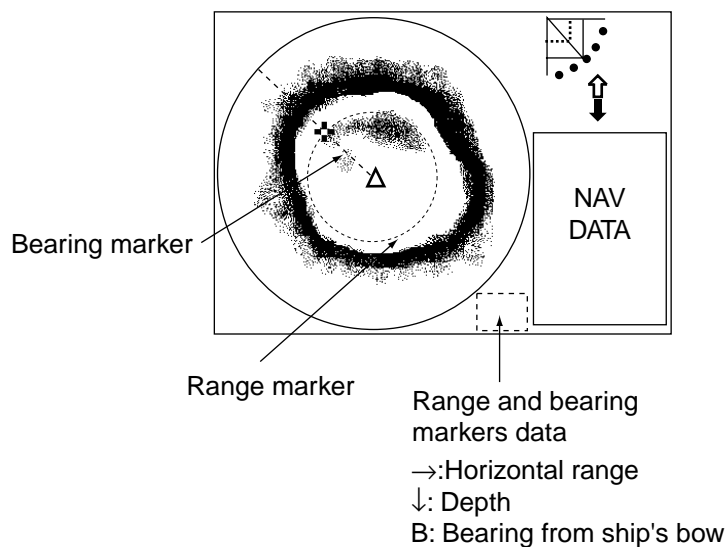

Figure 2-12 Range and bearing markers

## 2.11 Adjusting the Picture

### 2.11.1 Suppressing bottom and surface reflections

In shallow fishing grounds, excessive sea surface and bottom reflections often interfere with wanted fish echoes and they cannot be eliminated sufficiently with the TVG controls. In such cases, try to reduce the output power, without turning down the gain. The picture becomes clearer when output power is reduced rather than when the gain is decreased.

1. Press the [MENU] key to open the menu.
2. Press ▲ to select MENU and then press ◀ to select the COM1 menu.

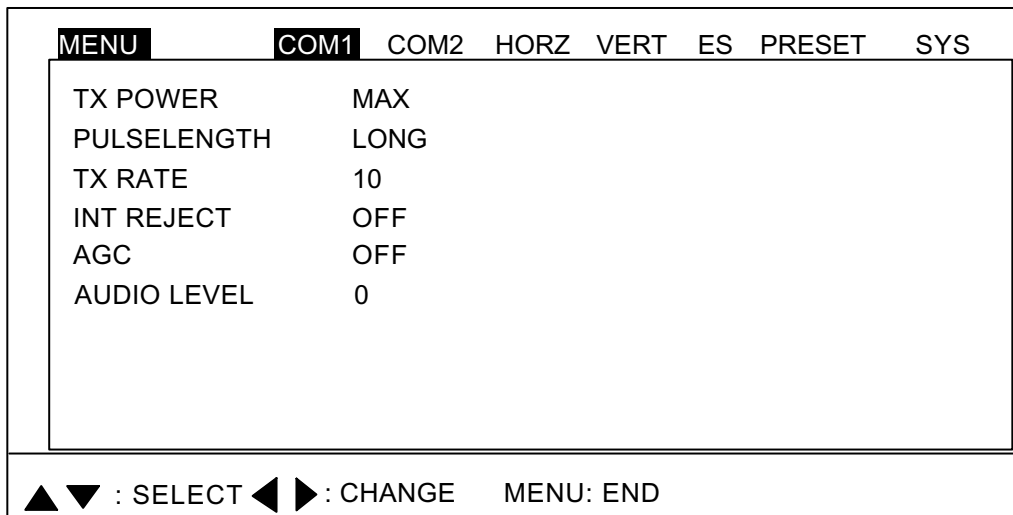
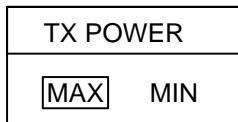

Figure 2-13 COM1 menu

3. Press ▲ or ▼ to select TX POWER and press ▶. The following dialog box appears.



4. Press ▶ to select MIN. (For long range detection be sure to return the setting to MAX.)
5. Press the [MENU] key to register your selection and close the menu.

## 2.11.2 Suppressing bottom tail

As described earlier, fish schools near the bottom are sometimes difficult to detect because you have to discriminate fish echoes from the bottom reflections. To discriminate fish echoes near the bottom, select the short Tx pulselength on the COM1 menu to decrease the tail of bottom reflections.

1. Press the [MENU] key to open the menu.
2. Press ▲ to select MENU and then press ◀ to select the COM1 menu.
3. Press ▲ or ▼ to select PULSELENGTH and press ▶. The following dialog box appears.

PULSELENGTH	
LONG	SHORT

4. Press ▶ to select SHORT.
5. Press the [MENU] key to register your selection and close the menu.

## 2.11.3 Displaying weak echoes clearly

Echoes from targets (such as the bottom or a fish) return to the transducer in order of the distance to them, and when their intensities are compared at the transducer face, those from nearer targets are generally stronger when their reflecting properties are nearly equal. The sonar operator will be quite inconvenienced if these echoes are directly displayed on the screen, since he won't be able to judge the actual size of the target from the size of echoes displayed on the screen. To overcome this inconvenience, use the TVG function. It compensates for propagation loss of sound in water: amplification of echoes on short range is suppressed and gradually increased as range increases, so that similar targets are displayed in similar intensities irrespective of the ranges to them.

The TVG also functions to suppress unwanted echoes and noise which appears in a certain range area on the screen.

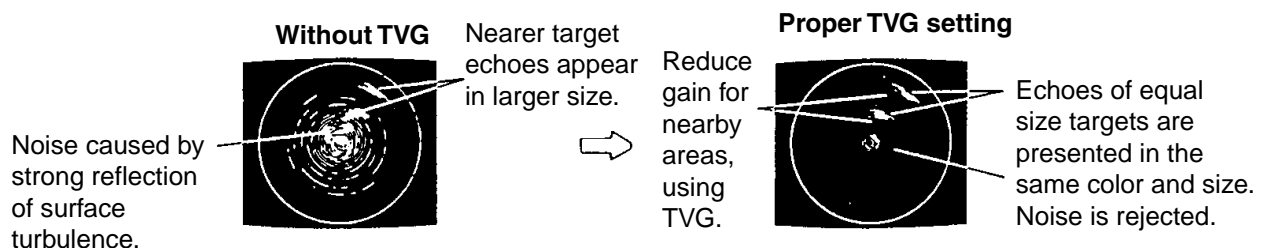

Figure 2-14 How TVG works

**Note:** Excessive TVG may eliminate short-range echoes.

**To adjust TVG:**

1. Press the [MENU] key to open the menu.
2. Press ▲ to select MENU and then press ◀ to select HORZ.

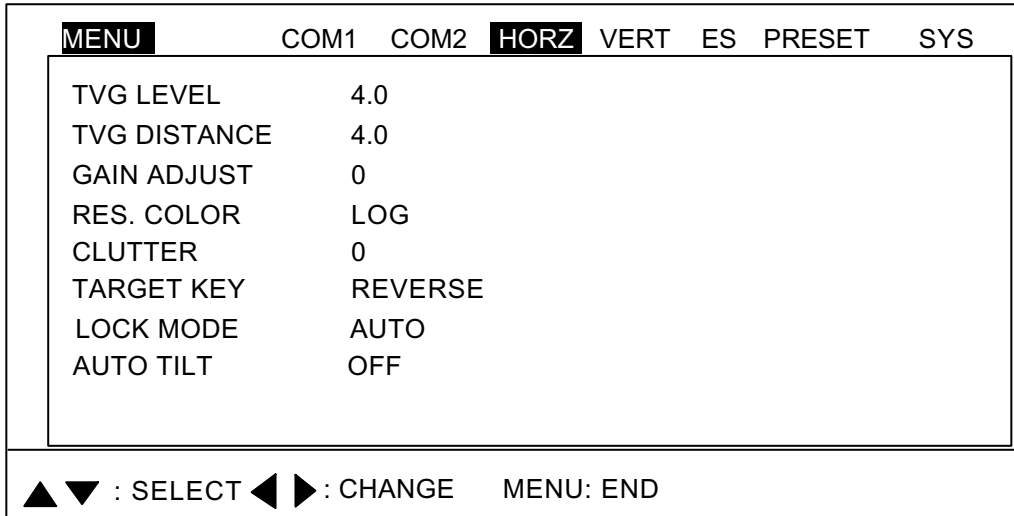
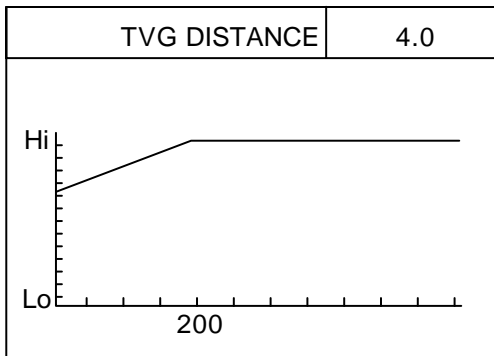

Figure 2-15 HORZ menu

3. Press ▲ or ▼ to select TVG DISTANCE and press ▶. The following dialog box appears.



4. Press ◀ or ▶ to adjust TVG distance between 3.0 and 5.0 (130-320 m). As a general rule, use a higher setting for low frequency transducer; a lower setting for high frequency transducer. The larger the figure the greater the distance at which TVG works. When you open the TVG dialog box the TVG line changes from solid to dashed and a solid line denotes current TVG setting.

TVG Distance Setting	0	0.5	1.0	1.5	2.0	2.5	3.0	3.5	4.0	4.5	5.0	....	10.0
Meters	3	8	20	40	60	100	130	160	200	250	320	....	1000
Feet	10	30	70	130	210	330	410	520	660	820	1040		3280
Passi/braza	2	5	10	20	40	60	80	100	120	150	180		600
Hiro	2	5	10	20	40	60	80	100	130	170	210	....	660



5. Press the [MENU] key to register your selection and close the menu.
6. To suppress reflections by the sea surface or plankton, select TVG LEVEL and press ►.
7. Press ◀ or ► to adjust TVG LEVEL, considering sea conditions. A setting between 2.0 and 5.0 should provide satisfactory results. The higher the figure the less the gain over distance.
8. Press the [MENU] key to register your selection and close the menu.
9. Watch a distant fish echo which is approaching own ship. Adjusting the tilt angle so the fish echo is within the sounding beam. Observe color of fish echo. If the color and size of the echo stay the same as the echo approaches own ship, the TVG setting is proper. If the echo suddenly becomes smaller, the TVG level may be too high.

## 2.11.4 Erasing weak echoes

Weak echoes such as interfere can be erased from the screen. This is useful when you want to observe a fish school echo.

1. Press the [MENU] key to open the menu.
2. Press ▲ to select MENU.
3. Press ◀ to select COM2.
4. Press ▲ or ▼ to select SIG LEVEL.
5. Press ► to open the dialog box.



6. Press ◀ or ► to select echo color to erase. Pressing ► erases echoes from weak to strong in ascending order of strength. You can also see which echo color is erased by watching the color bar.
7. Press the [MENU] key to register your selection and close the menu.

## 2.11.5 Enlarging fish echoes (expand horizontal display)

Fish echoes may be enlarged 1.5 times by using the expanded horizontal display. Press the key to show the expanded horizontal display. The direction of expansion depends on the train direction as below.

Train center direction	Position after expansion	Remarks
318° -42°	Moves to screen bottom	For viewing forward
48° -123°	Moves to left side of screen	For viewing starboard side
138° -222°	Moves to screen top	For viewing aft
228° -312°	Moves to right side of screen	For viewing port side

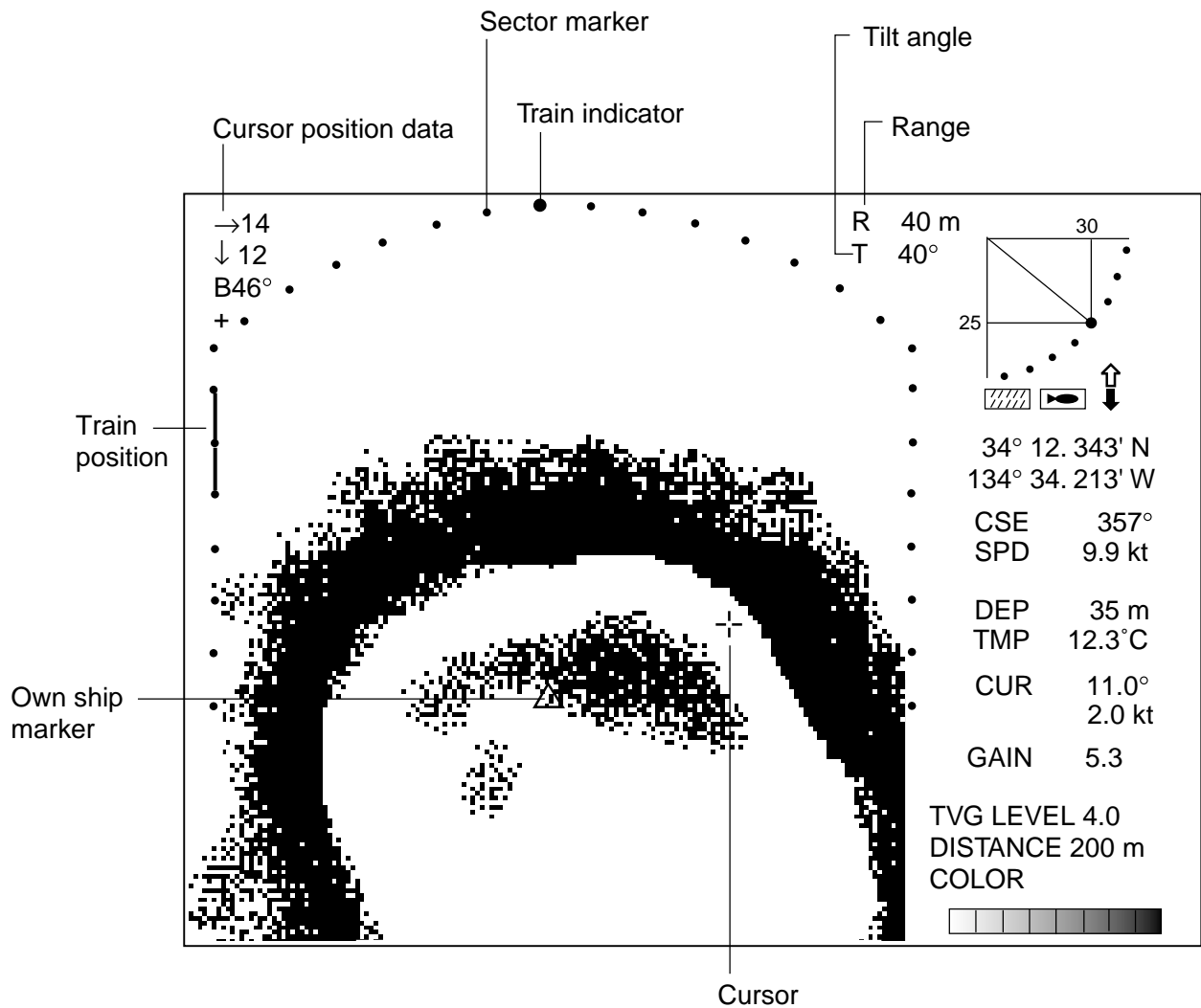

Figure 2-16 Expanded horizontal display

## 2.12 Target Lock

Three types of target lock modes are available.

- Manual reverse:** The transducer train direction is reserves manually. This is the default setting, and is available in the horizontal and vertical fan modes.
- Position:** Tracks stationary position (such as a reef) using position data from a navigator. Available in the horizontal mode only.
- Echo:** Tracks fish echo either manually or automatically. Available in the horizontal mode only.

### 2.12.1 Setting target lock mode

1. Press the [MENU] key to open the menu.
2. Press ▲ to select MENU and then press ◀ or ▶ to select the HORZ menu.
3. Press ▲ or ▼ to select TARGET KEY.
4. Press ▶ to show following dialog box.

TARGET KEY		
REVERSE	POS	ECHO

5. Press ◀ or ▶ to select option desired.
6. Press the [MENU] key to register your selection and close the menu.

### 2.12.2 Manual reserve mode

The transducer train direction is reversed manually, thereby emphasizing possible fish echoes.

**Note:** This function is inoperative in the echo sounder mode. In the vertical fan mode the manual reverse mode is automatically selected regardless of the setting in paragraph 2.12.1.

#### To activate the manual reserve mode:

1. Select REVERSE following the procedure in paragraph 2.12.1.
2. Press the [TARGET] key to reverse the transducer train direction when a fish school appears. "REVERSE" momentarily appears at the screen top when the key is pressed and then the transducer train direction is reversed.

### 2.12.3 Position mode

This mode tracks a stationary position (such as a reef) using position data fed from a navigator.

**Note1:** This function is inoperative in the echo sounder mode. In the vertical fan mode the reverse mode is automatically selected regardless of the setting in paragraph 2.12.1.

**Note2:** This mode requires position data. When there is no position data the message “NO POSITION DATA.” appears for five seconds and tracking is automatically cancelled. Check the navigator.

**Note3:** The tilt angle must be less than 75 degrees to use this feature.

#### To use the position mode:

1. Select POS following the procedure in paragraph 2.12.1.
2. Use the Omnipad to select the location to track.
3. Press the [TARGET] key.

The message “POS LOCK” appears momentarily at the screen top, the target lock marker is displayed at the cursor position and the target lock indicator appears at the top right-hand corner of the screen while tracking (with position data from external equipment) is occurring. If the position goes out of the display area target lock is automatically cancelled and the target lock indicator and target lock marker disappear. The SECTOR, TILT and TRAIN controls are inoperative since they are automatically adjusted.

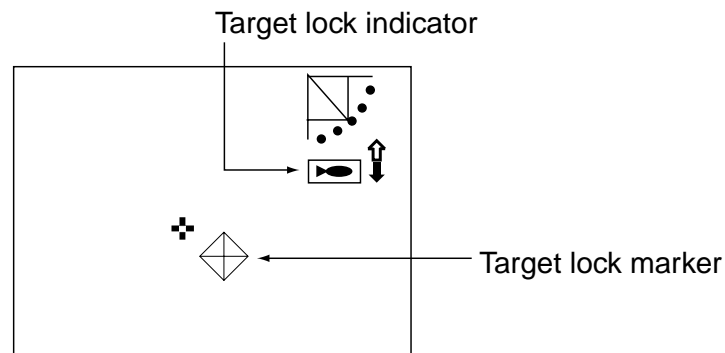

*Figure 2-17 Target lock indicator*

4. To turn off the target lock, press the [TARGET] key again. The message “LOCK END” momentarily appears, the target lock marker and the target lock indicator disappear and previously used sector, train and tilt settings are restored. Also, latitude and longitude indication returns to normal.

## 2.12.4 Echo mode

The echo mode tracks a fish school either automatically or manually. The default setting is automatic, and you can select automatic or manual with “LOCK MODE” in the HORZ menu.

### Automatic echo tracking mode

The automatic echo target lock function automatically tracks a fish school appearing in the operator-selected target lock zone. If the tracked fish school goes out of the zone in the range direction, tracking is suspended until it or a new fish school comes into the zone.

#### To use the automatic echo tracking mode:

1. Select ECHO following the procedure in paragraph 2.12.1.
2. If necessary select LOCK MODE to AUTO (default setting ) on the HORZ menu.
3. Press the [TARGET] key. The dialog box below appears at the screen center, the message “ECHO LOCK” appears for three seconds at the top of the screen, the target lock area appears in the current train area and the target lock indicator appears at the right-hand side of the screen.

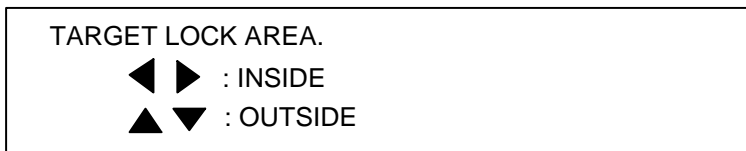

4. Use the [SECTOR] and [TRAIN] controls and the Omnipad to set the detection area. Do not include bottom echoes in the zone, so that target lock will not be activated by bottom echoes.

When a target of red or reddish-brown color is detected in the zone, the target lock indicator blinks and a buzzer sounds to call the operator’s attention. The [SECTOR], [TILT] and [TRAIN] controls are inoperative since they are automatically adjusted. When you attempt to operate shoes controls the message “TARGET LOCKING NOW.” appears.

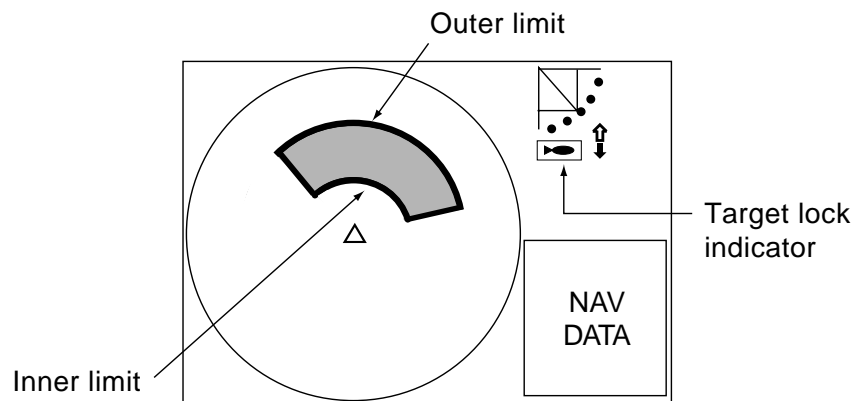
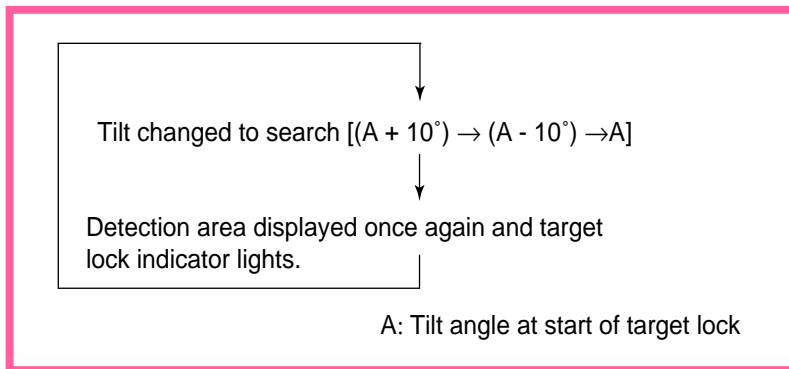

Figure 2-18 Target lock area

When the fish echo is lost the tilt angle is automatically changed as below to continue tracking the echo:



5. To turn off the target lock, press the [TARGET] key again. The message "LOCK END" appears for three seconds at the screen top, the target lock indicator disappears and operation continues with current train and tilt settings.

### **Manual echo tracking mode**

1. Select ECHO following the procedure in paragraph 2.12.1.
2. Select LOCK MODE to MANUAL on the HORZ menu.
3. Press the [TARGET] key when a wanted target echo appears.

The message "ECHO LOCK" appears along with the target lock indicator. Then, the transducer train direction is reversed and searching starts with the current tilt angle. When a target echo appears the transducer train direction is again reversed automatically, the buzzer sounds and the target lock indicator blinks.

If the fish echo is lost the tilt angle is automatically changed to continue tracking as below.

1. Tilt angle is changed by +10° (A+10°).  
(A is the tilt angle used when tracking began.)
2. Tilt angle is changed by -10° (A-10°).
3. If the echo could not be found, tracking is cancelled and tilt angle A is restored.

4. To quit the target lock, press the [TARGET] key again. The message "LOCK END" appears momentarily.

## 2.13 Horizontal Menu Overview

This section presents an overview of the items on the HORZ menu.

1. Press the [MENU] key to open the menu.
2. Press ▲ to select MENU and then press ◀ or ▶ to select the HORZ menu.

MENU	COM1	COM2	HORZ	VERT	ES	PRESET	SYS
TVG LEVEL		4.0					
TVG DISTANCE		4.0					
GAIN ADJUST		0					
RES. COLOR		LOG					
CLUTTER		0					
TARGET KEY		REVERSE					
LOCK MODE		AUTO					
AUTO TILT		OFF					

▲ ▼ : SELECT ◀ ▶ : CHANGE MENU: END

Figure 2-19 HORZ menu

3. Press ▲ or ▼ to select item desired.
4. Press ▶ to show corresponding dialog box.
5. Press ◀ or ▶ to select option desired.
6. Press the [MENU] key to register your selection and close the menu.

### 2.13.1 Horizontal menu description

**TVG LEVEL:** Compensates for propagation loss of sound in water. Default setting is 4.0. For further details, see paragraph 2.11.3 on page 2-13.

**TVG DISTANCE:** As above. Default setting is 4.0.

**GAIN ADJUST:** Compensates for too weak or too strong echo level. Adjust it when the gain on the horizontal mode when it is not the same as that on the vertical fan and echosounder modes.

**Setting range:** -10 to +10. Default setting is 0.

**CLUTTER:** Low intensity echoes, often caused by sediments in water, are painted on the screen as a large number or random dots. This noise can be suppressed. The higher the number (setting) the weaker the echoes which are erased.

**RES. COLOR:** Sets transfer characteristics of input signal level versus display echo level. Echo strength is emphasized in order of CUBE, SQUARE, LINEAR, LOG, and you can observe the characteristics of each by watching the color bar as you change the setting.

**LOG:** Displays weak to strong echoes in their respective levels. This is the default setting, and is suitable for general use.

**LINEAR:** Downplays the weak echoes when compared with LOG. Effective for suppressing weak echoes such as plankton.

**SQUARE:** Strong echoes are emphasized more than in LINEAR.

**CUBE:** Strong echoes are emphasized even more than in SQUARE.

**TARGET KEY:** Selects target lock function among reverse, position and echo. Default setting is REVERSE. For further details see paragraph 2.12 on page 2-17.

**LOCK MODE:** Selects how to track fish echo in "echo" target lock; automatically or manually. Default setting is AUTO. For further details see paragraph 2.12 on page 2-17.

**AUTO TILT:** Turns automatic tilt on or off, and the default setting is OFF. The choices are  $\pm 2^\circ$ ,  $\pm 4^\circ$ ,  $\pm 6^\circ$ , and  $\pm 10^\circ$ . Automatic tilt adjusts the tilt angle in the following sequence:

$B \rightarrow (B-A) \rightarrow B \rightarrow (B+A) \rightarrow B \rightarrow (B-A) \rightarrow B \rightarrow (B+A) \dots$

B: Current tilt angle

A: Auto tilt setting

For example, the tilt angle is  $30^\circ$  and the automatic tilt setting is  $4^\circ$ . Then, the tilt angle is changed in the following sequence:  $30^\circ \rightarrow 26^\circ \rightarrow 30^\circ \rightarrow 34^\circ \rightarrow 30^\circ \rightarrow 26^\circ \rightarrow 30^\circ \rightarrow 34^\circ \dots$

**Note:** The [TILT] control is inoperative when automatic tilt is active.



## 2.14 Interpreting the Horizontal Display

This section provides information necessary for interpreting the horizontal display.

### 2.14.1 How the horizontal mode picture is painted

The wide sounding beam is emitted from the soundome at a certain tilt angle (see hatched area in the figure below). The information (target echoes) obtained by this beam is displayed in sectors of increments of  $12^\circ$  of the screen. Thus, all directions around the boat are sounded in 30 times of transmissions.

**Note:** When the "FAST SCAN" is switched off, the equipment operates in a narrow sounding beam. Then, the echoes appear on a  $6^\circ$  sector in each transmission, so 60 transmissions are required to complete the full  $360^\circ$  picture ( $6^\circ \times 60 = 360^\circ$ ). This means that training speed is slower. However, since transmission power is concentrated into the narrow sounding beam, a superior detection range is obtained. Furthermore, since the bottom contour is painted distinctly, bottom fish may be more easily detected.

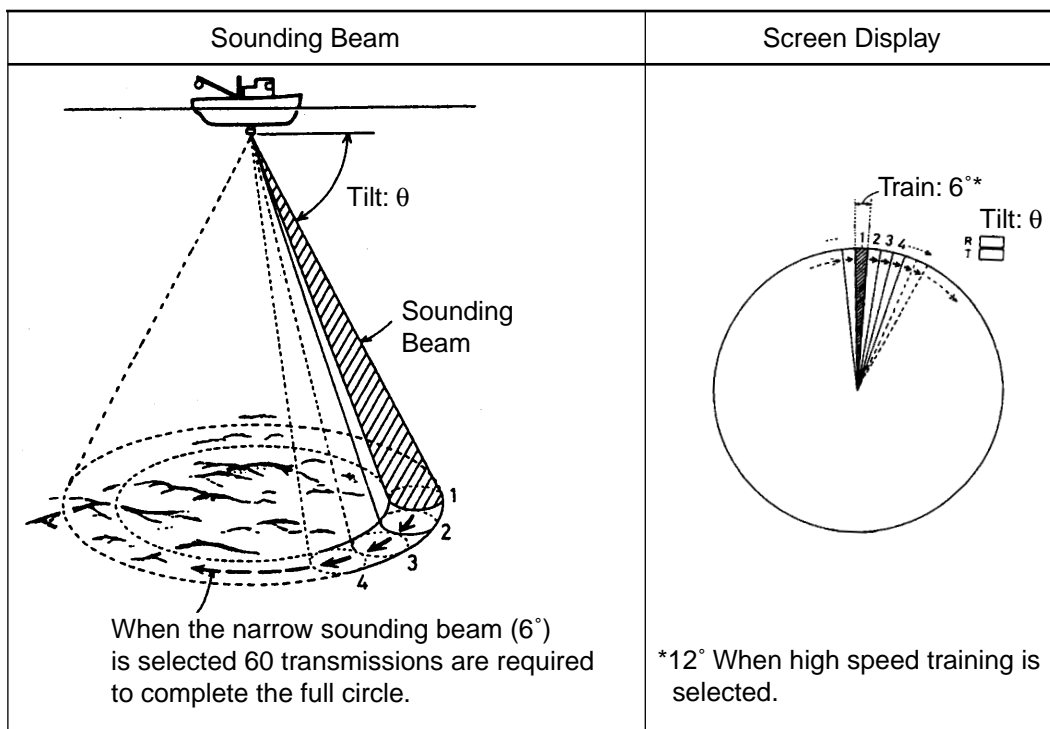

Figure 2-20 How the horizontal mode picture is painted

## 2.14.2 Sample echo displays

### Bottom echoes

When the tilt angle is changed, the bottom echo illustrated below will appear on the display. When the tilt is decrease (toward  $0^\circ$ ), the bottom trace becomes wider and weaker. By observing the bottom condition on the display, the skipper can prevent net damage.

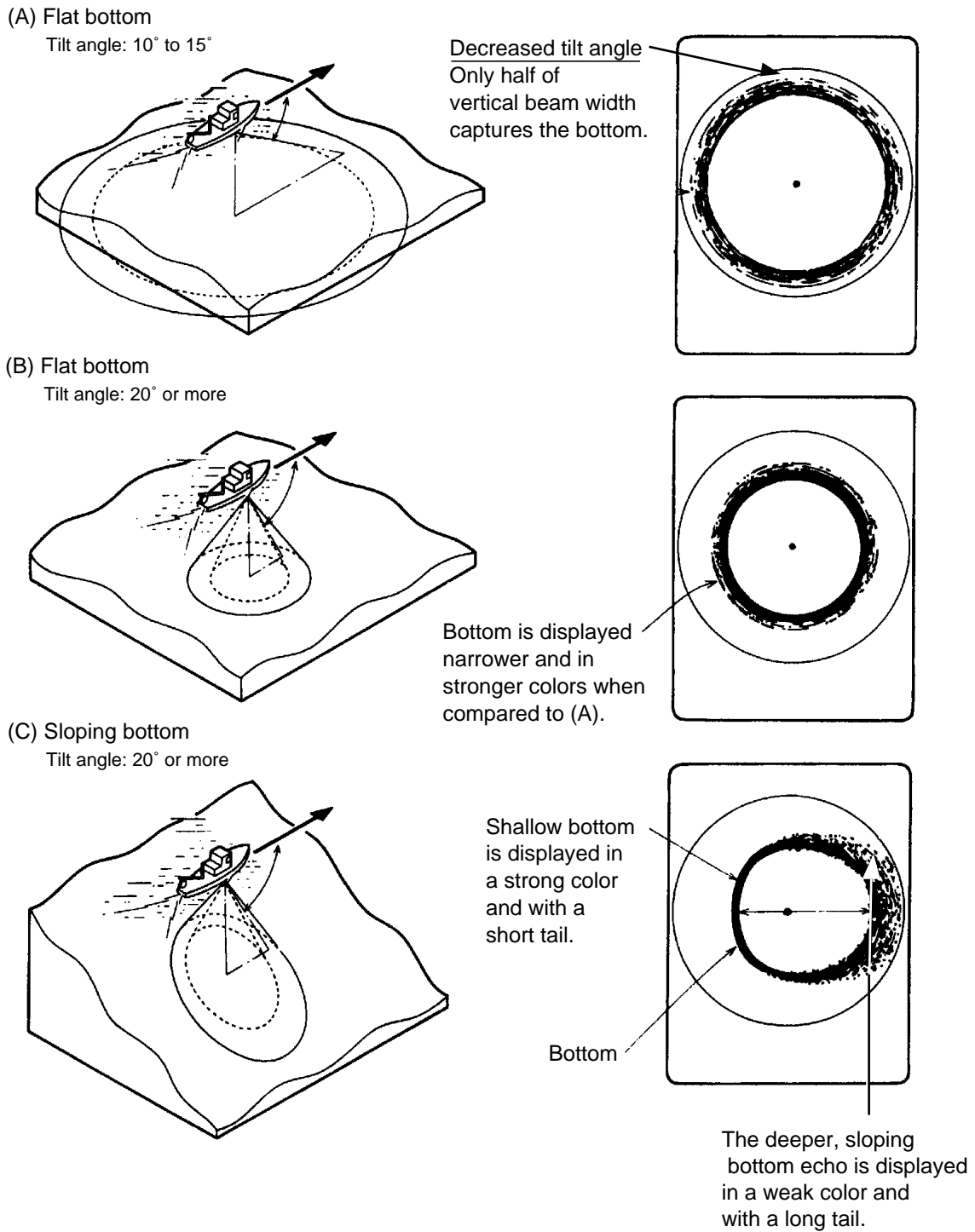
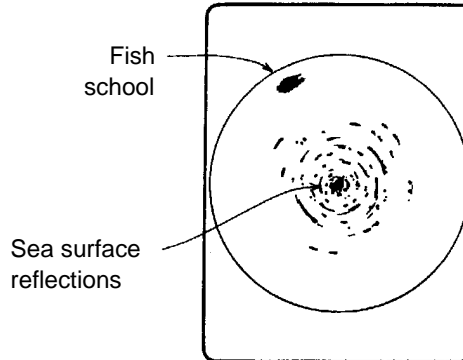
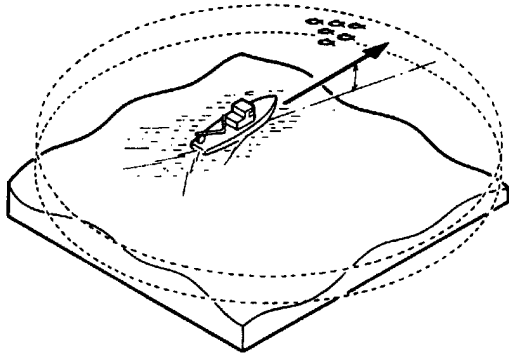

Figure 2-21 Bottom echoes

## Fish schools

A fish school appears as a mass of echoes on the screen. The color of the mass shows the density of fish schools on the sonar beam. To find distribution and center point of a fish school, try several different tilt angles.

(A) Sea surface fish  
Tilt angle: 0° to 10°



Bottom echo not displayed because of decreased tilt angle. Sea surface reflections are present.

(B) Midwater, bottom fish Tilt angle: 30° or more  
Fish echo which appears before bottom can be detected.

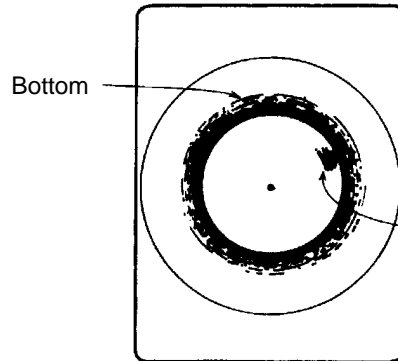
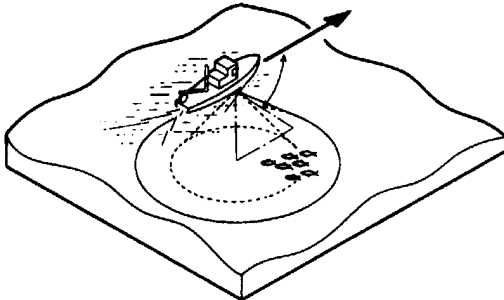

Large midwater fish school is present.

Tilt angle: 0° to 20°  
Fish echo which appears together with or after bottom can be detected.

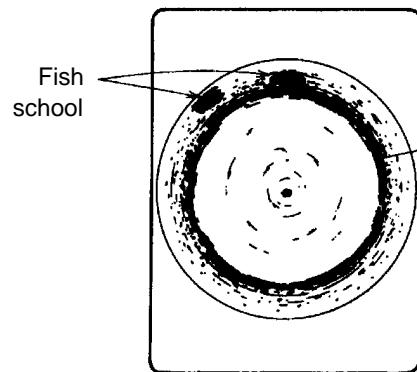
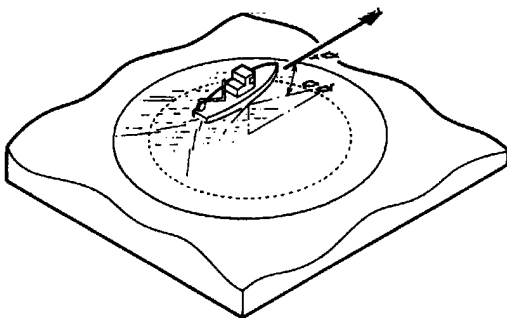

When the tilt angle is shallow, the reflection echo from bottom is weak and the fish echo which appears from bottom is easy to find.

Figure 2-22 Fish schools

## Sea surface reflections

To reduce sea surface reflections, set the tilt angle to 5° or higher, so the upper edge of the sonar beam does not hit the sea surface, or adjust TVG. When a decreased tilt angle is used, sea surface reflections cover a large area as illustrated below.

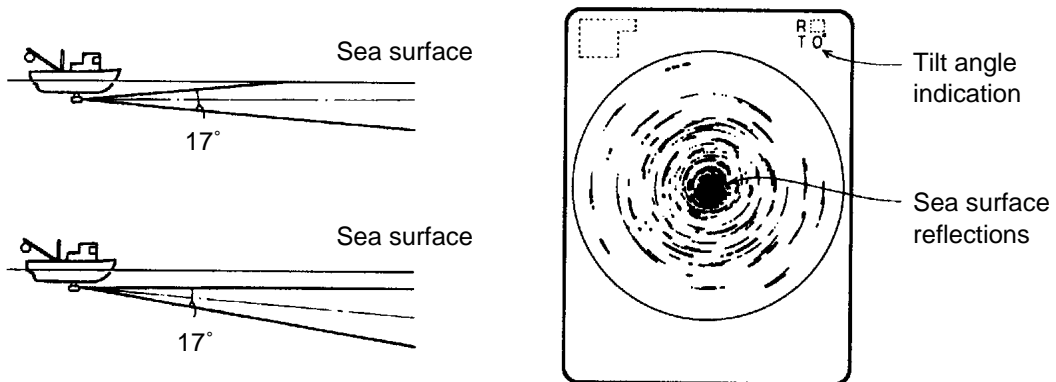

Figure 2-23 Sea surface reflections

## Wake

A wake produced by own ship or another ship can be a strong reflecting object when a decreased tilt angle is used. As the wake appears as a thick continuous line, it can be easily distinguished from a fish school. A wake contains many air bubbles which attenuate ultrasonic energy, making it difficult to sound beyond the wake.

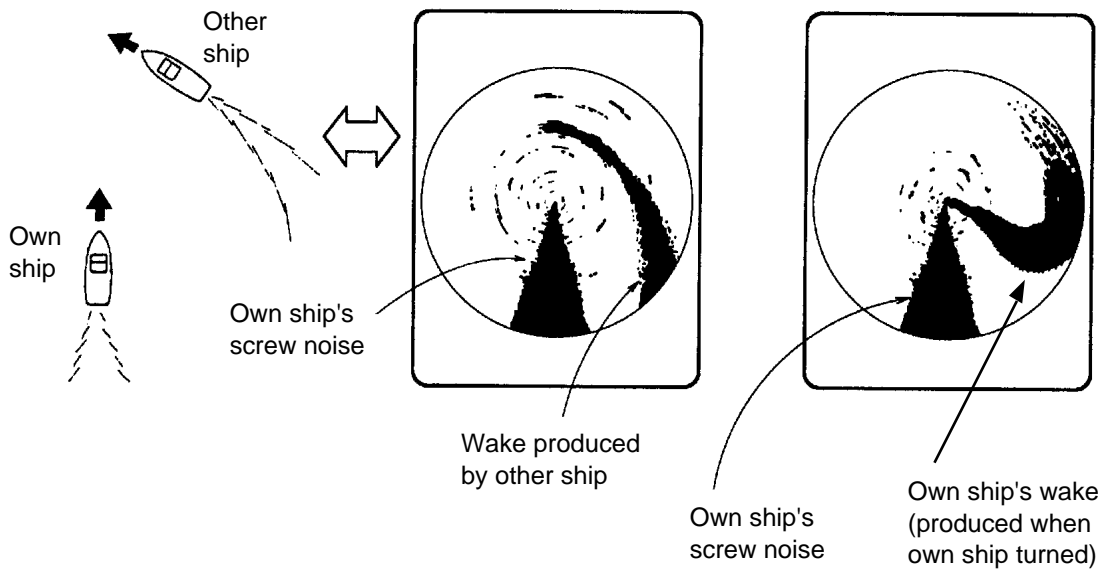
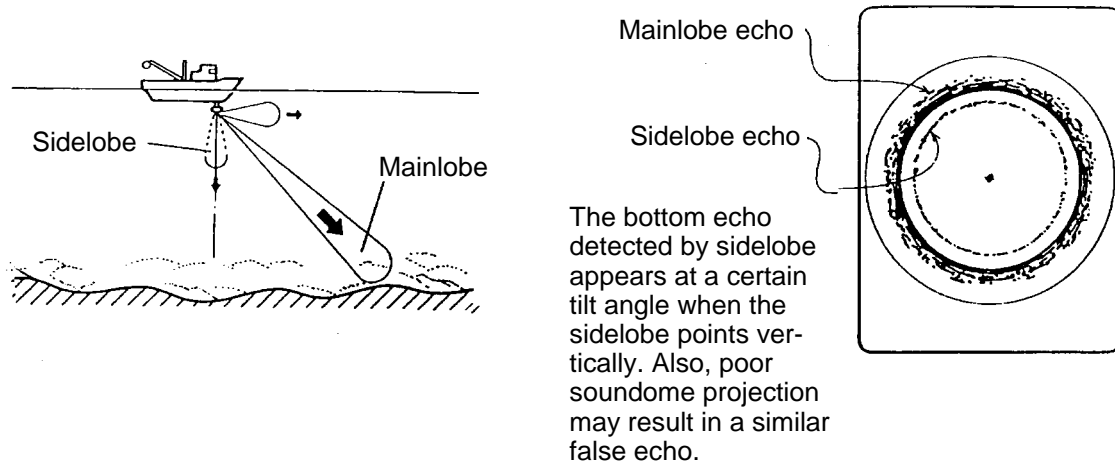

Figure 2-24 Wake

## **Sidelobe echo (false echo)**

An ultrasonic wave is emitted only in the direction set by the [TILT] control, however there are some emissions outside the main beam. These are called sidelobes. The energy of the sidelobe is fairly weak but when the water is comparatively shallow and the bottom is rocky and hard, strong signals are detected by the sidelobe. These are represented on the display as a false echo as shown below.

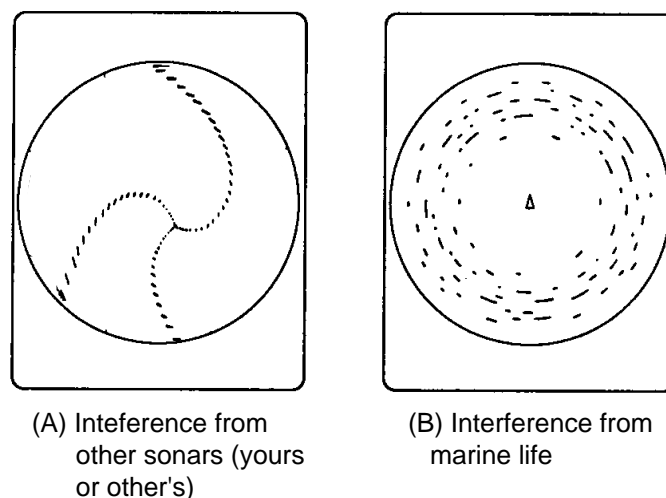

*Figure 2-25 Sidelobe echoes*

## **Noise and interference**

When the fishing ground is crowded with many fishing boats, the sonar is subject to interference from ultrasonic equipment (echo sounder or sonar) on other boats as well as those on own ship.

For instance, interference from the sonar operated on other boats will show itself on the display as in (A) in the figure below. This interference can be suppressed by changing the Tx rate on the COM1 menu. Noise from marine life shows itself on the displays as in (B) in the figure below. This type of noise can be suppressed with the interference rejector on the COM1 menu.



*Figure 2-26 Noise and interference*

## 2.14.3 Combination display examples

### Horizontal/history display

Press the  key to display the horizontal/history display.

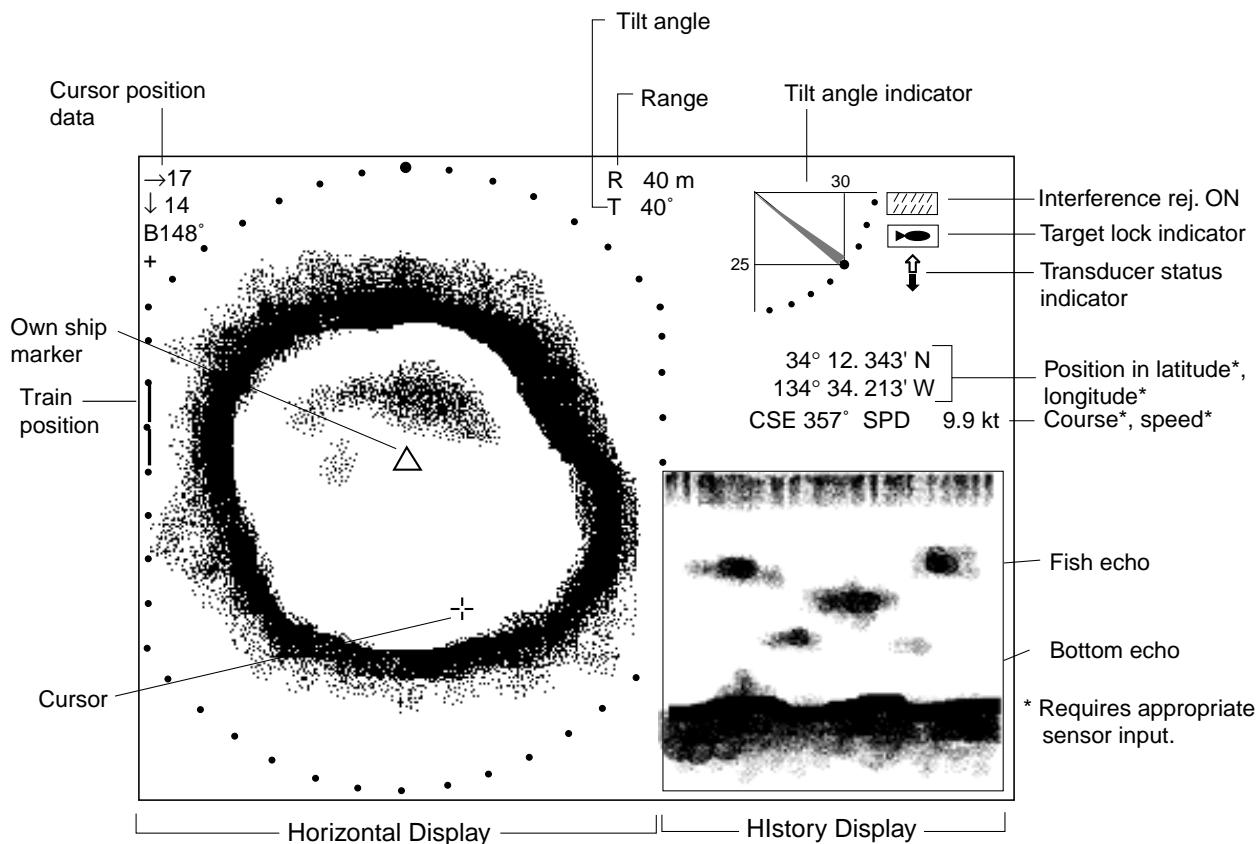



Figure 2-27 Horizontal/history display

The horizontal display appears in the main window; the history display in the sub window. The length of the picture displayed in the history display is equal to about four full circle pictures. Thus the history display enables you to observe the history of fish movement and distribution. It is also useful for detecting bottom fish, reefs and sunken vessels.

The history display cannot be adjusted.

## Horizontal/video plotter display

Press the  key to display the horizontal/video plotter display.

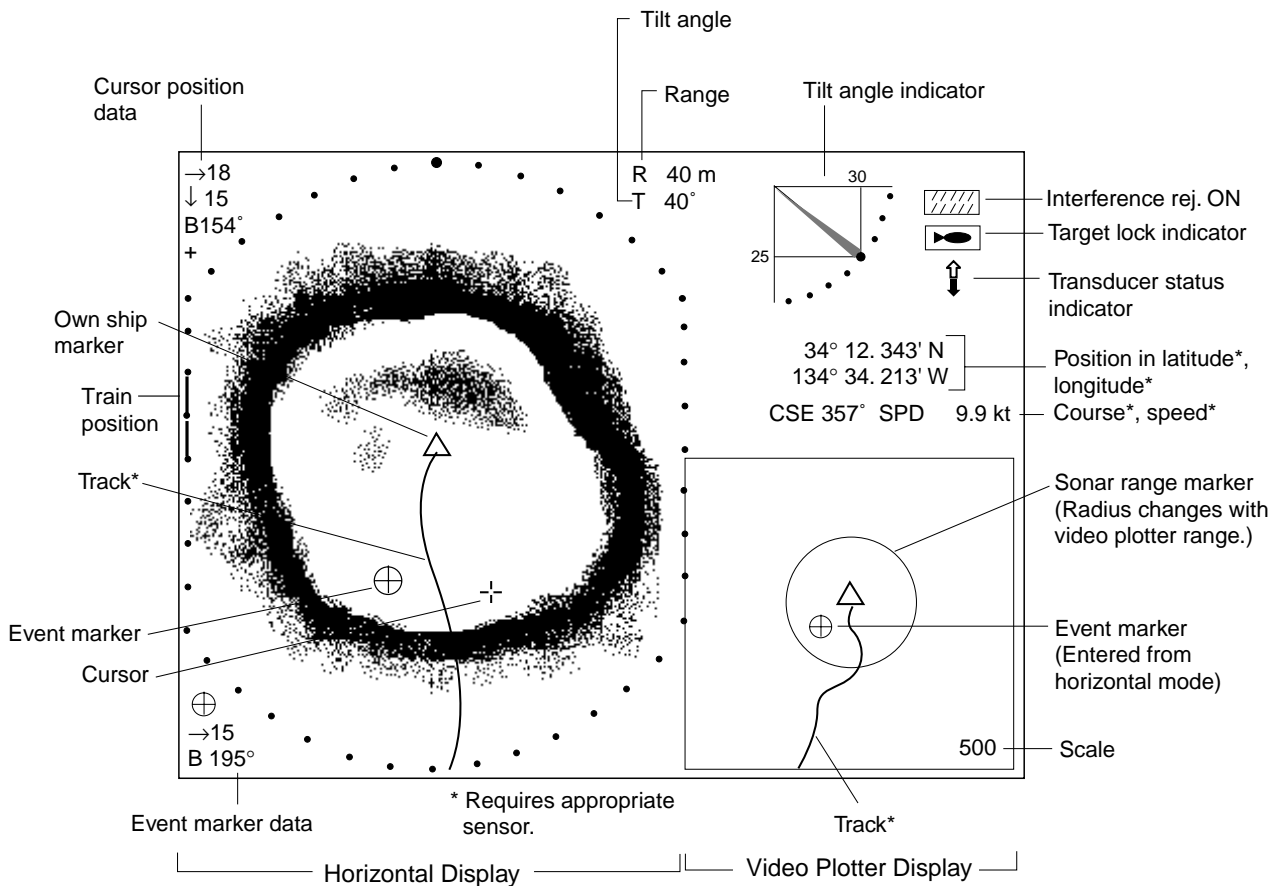

Figure 2-28 Horizontal/Video Plotter display

The horizontal display appears in the main window; the video plotter display, which traces ship's track on the display, in the sub window. Compared to the horizontal display the video plotter's range is much longer. For example, an event marker entered on the horizontal display disappears from that display when it goes out of the current range. However, it remains on the video plotter display for a much longer time when a long range scale is used. This can be useful when you want to return to the location denoted with an event marker. To display track on the horizontal display, the tilt angle must be less than 75 degrees.

You may switch control between the horizontal display and the video plotter display with the [MAIN/SUB] key. The message MAIN WINDOW CONTROLLABLE or SUB WINDOW CONTROLLABLE appears with each pressing of the key. A red rectangle circumscribes the sub window when it is selected. With the video plotter display selected you may change its range with the [RANGE] control.

**Note:** Controls other than RANGE may only be operated from the main window. When you attempt to operate them when the sub window is selected the message SELECT MAIN WINDOW appears.

The video plotter display cannot be adjusted.

## Horizontal/strata display

Press the  key to display the horizontal/strata display.

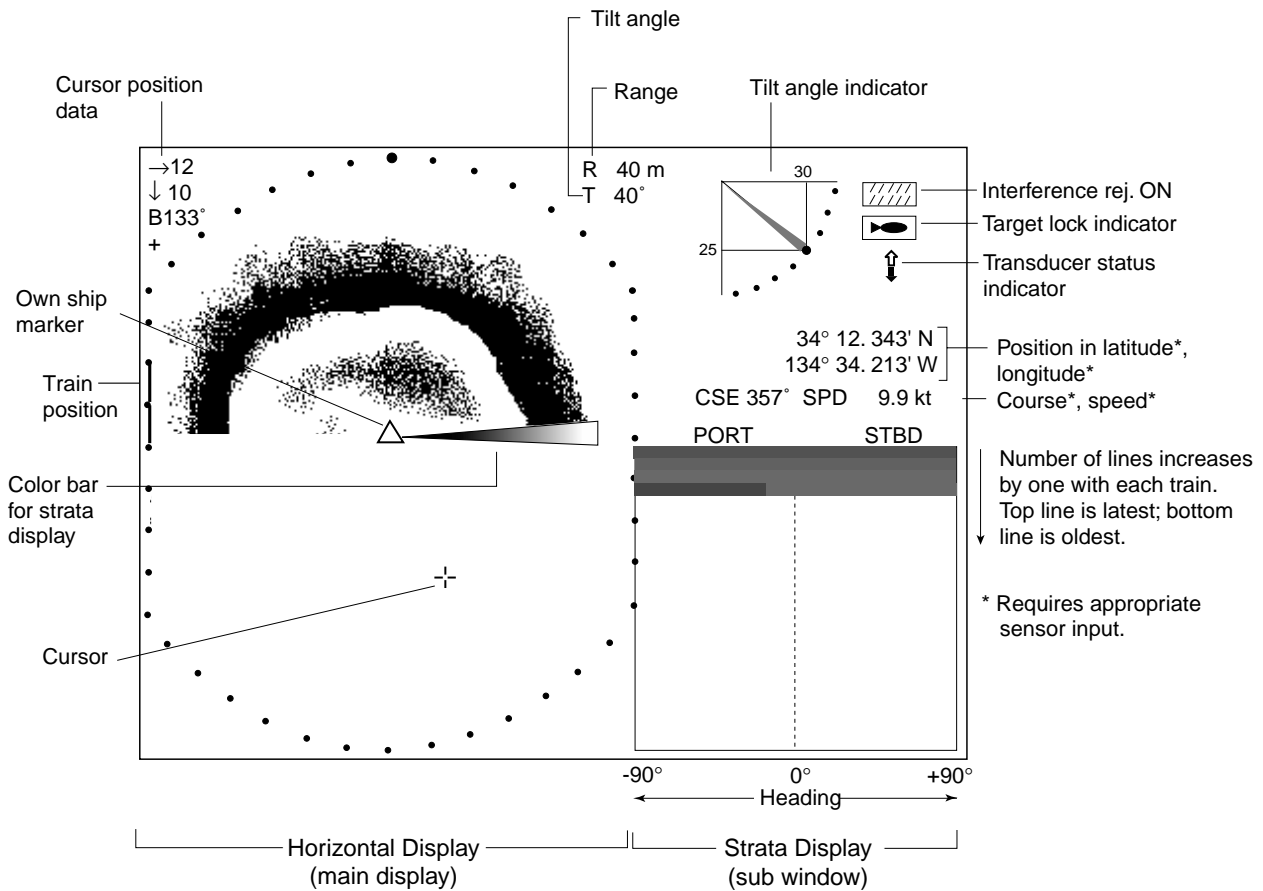

Figure 2-29 Horizontal/strata display

The horizontal display appears in the main window; the strata display in the sub window. The strata picture shows bottom undulations in different colors. This is useful in bottom trawling to avoid projections which may damage the net.

Coverage for the horizontal mode is 360° picture, and for the strata display it is maximum 90 from port to 90° starboard.

The strata display may be adjusted with the [RANGE] and [SECTOR] controls. Press the [MAIN/SUB] key to select the main or sub window. The message MAIN WINDOW CONTROLLABLE or SUB WINDOW CONTROLLABLE appears with each pressing of the key. A red cursor appears in the sub window when it can be controlled.



**Color bar for the strata display**

The depth of the bottom each in all directions is displayed in the sub window, in the colors set by the color bar for the strata display. The color bar for the strata display shows search angle range below 336 degrees.

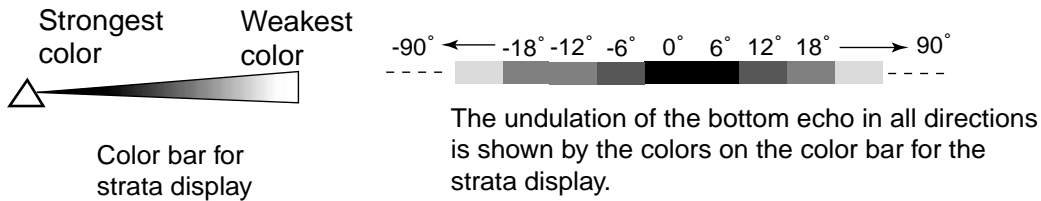

The position of the weakest echo can be changed with the [RANGE] control, and the width of each color on the color bar for the strata display with the [SECTOR] control.

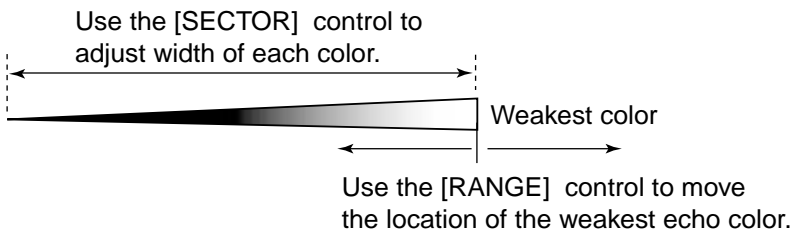

**Note:** TILT, TRAIN, FULL/HALF, FAST SCAN, R/B, EVENT, TARGET, CUSTOM MODE controls may only be operated from the main window. When you attempt to operate them from the sub window the message "SELECT MAIN WINDOW." appears for about four seconds.

**Flat bottom and strata display**

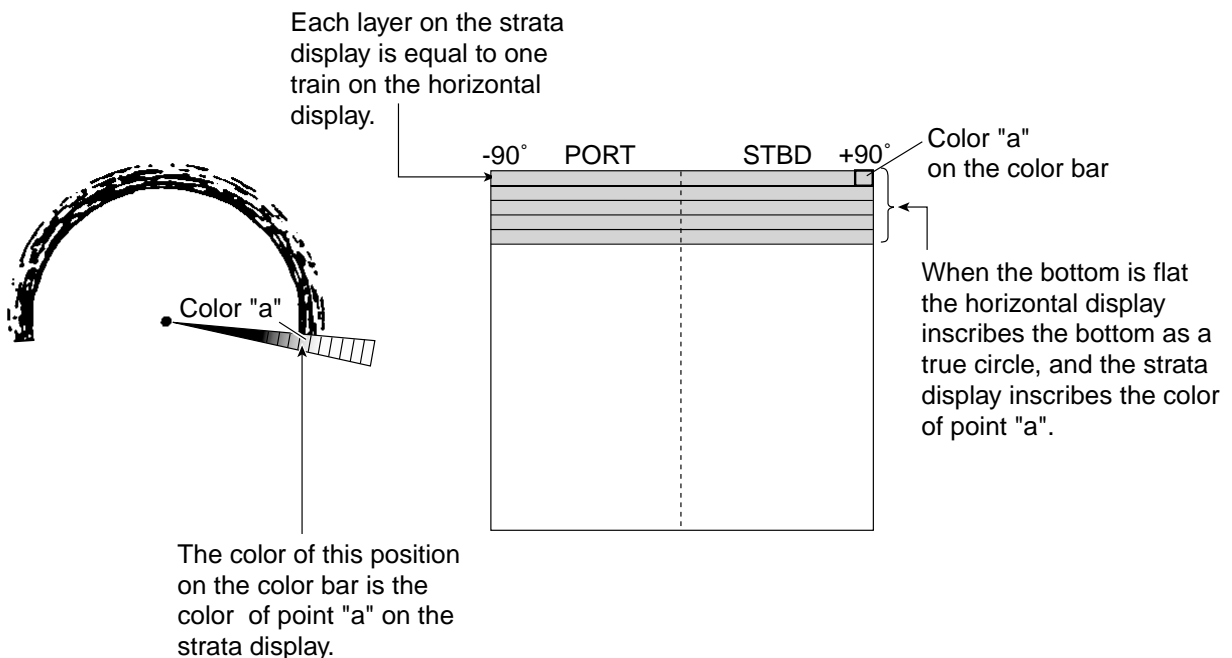

*Figure 2-30 Flat bottom and strata display*

**Projection in fore direction and strata display**

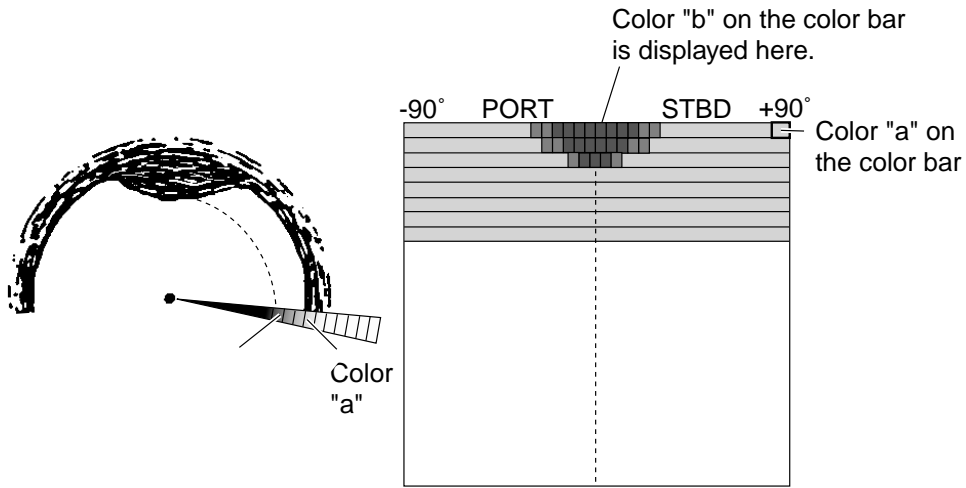

*Figure 2-31 Projection in fore direction and strata display*

**Depth becoming shallower gradually in fore direction and strata display**

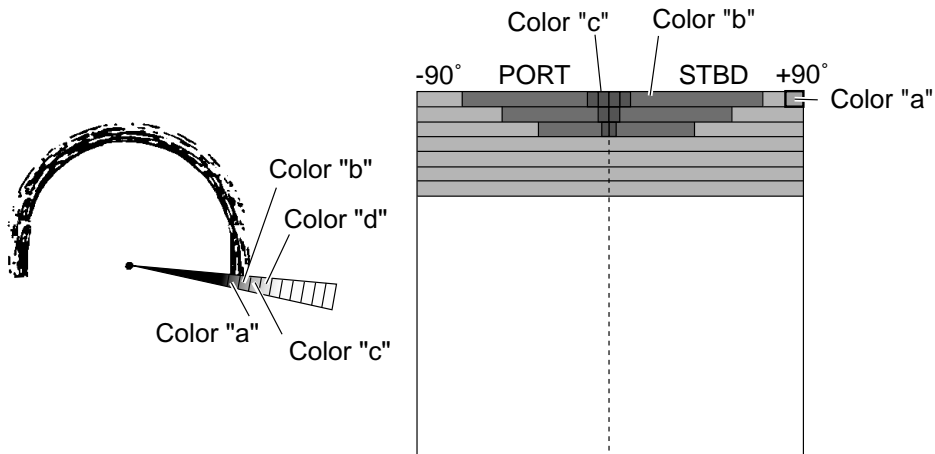

*Figure 2-32 Depth becoming shallower gradually in fore direction and strata display*

**Depth becoming deeper gradually in fore direction and strata display**

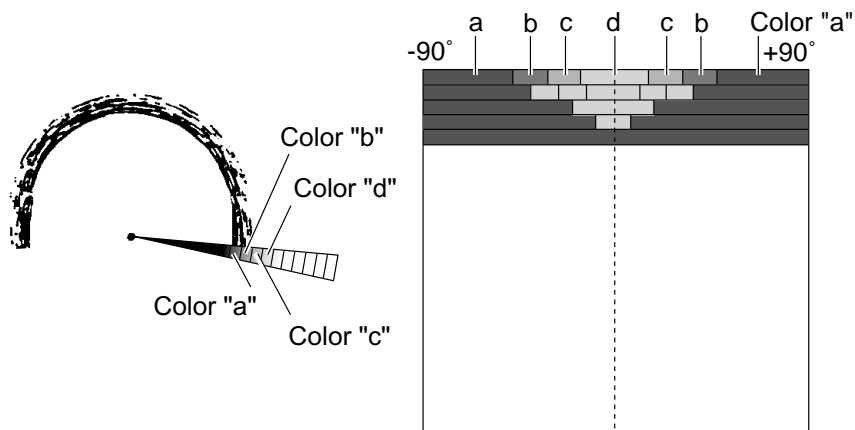

*Figure 2-33 Depth becoming deeper gradually in fore direction*

# 3. VERTICAL FAN MODE

## 3.1 Operational Overview

The figure below shows the typical vertical fan mode operating sequence.

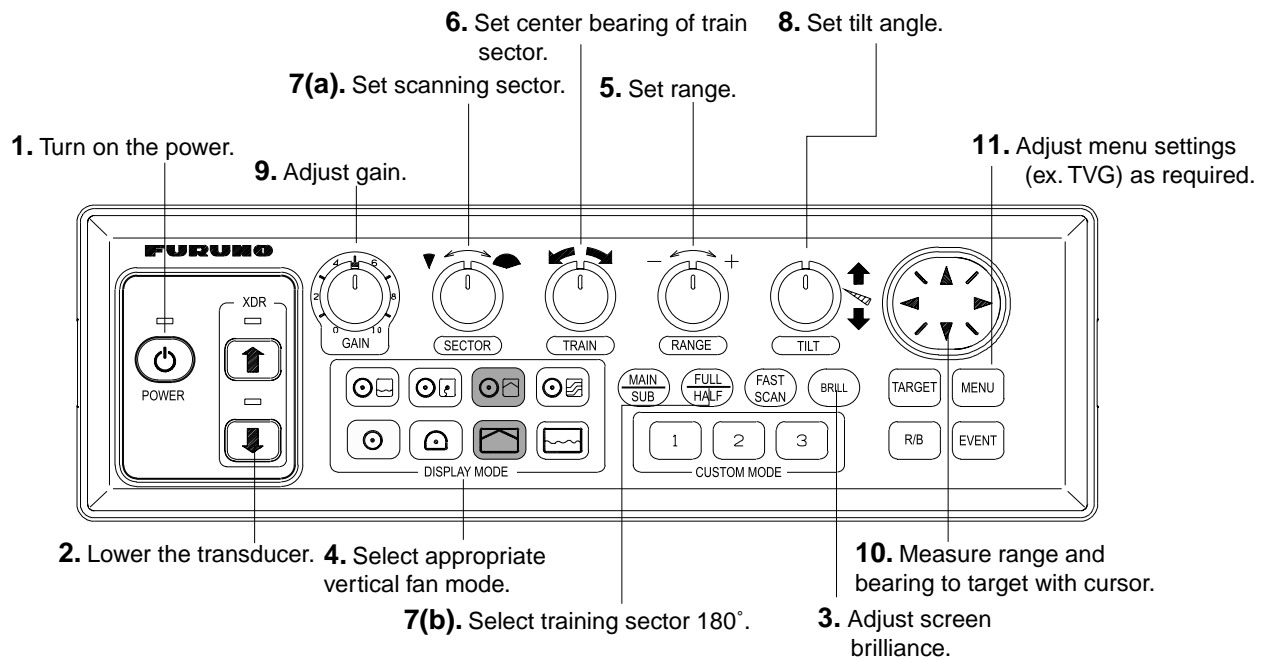

Figure 3-1 Control panel

### 3.2 Typical Vertical Fan Mode Display

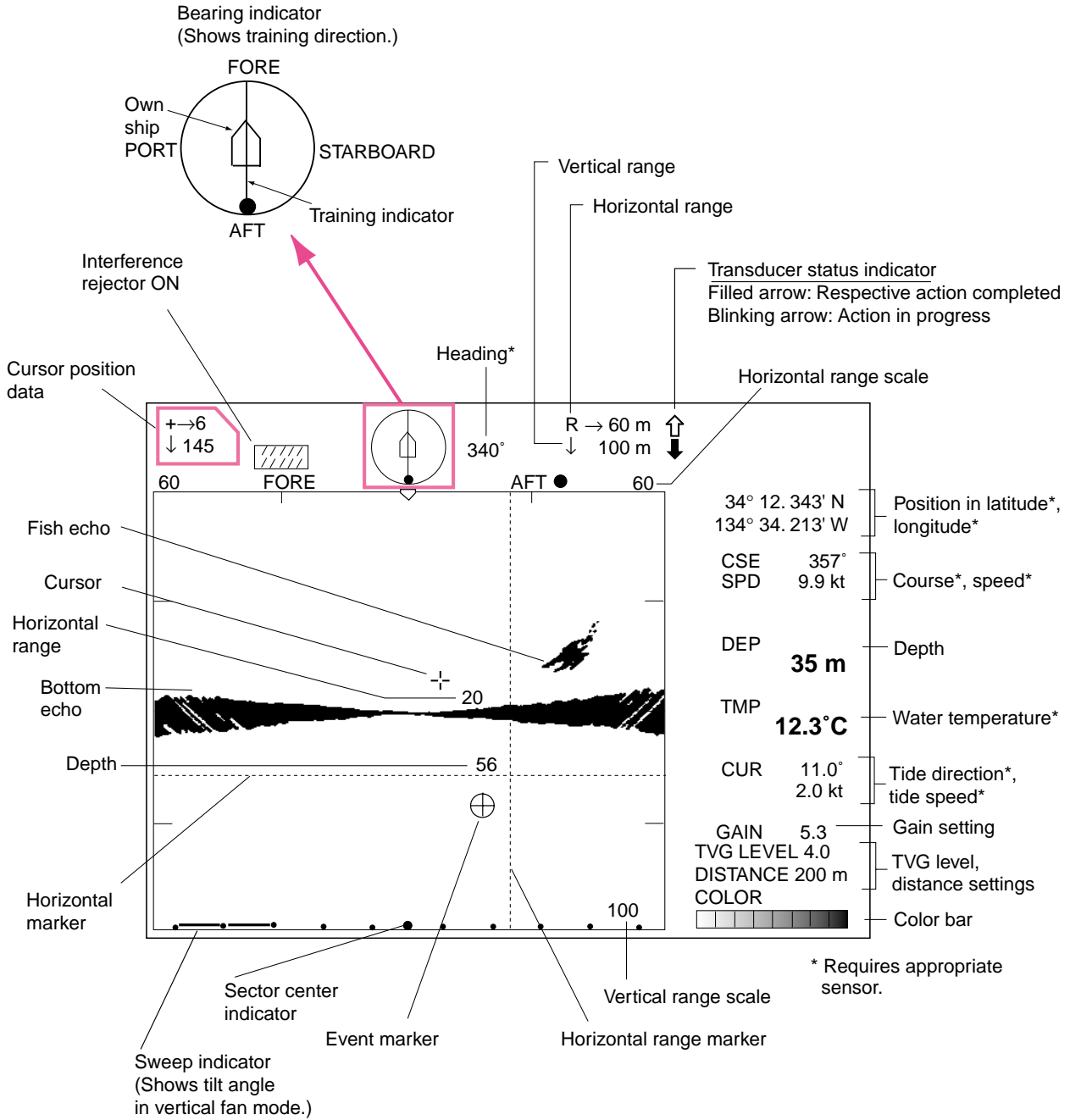

Figure 3-2 Typical vertical fan mode display

### 3.3 Selecting the Range

The [RANGE] control selects the detection (display) range, in 15 settings. Select the range according to either the fish species being searched or the depth desired. Each time the control is operated the newly selected range briefly appears in large characters at the screen top. Range is permanently displayed at the top right-hand corner of the screen.

Normally the range is set so that the bottom is traced at the lower part of the screen (like an echo sounder).

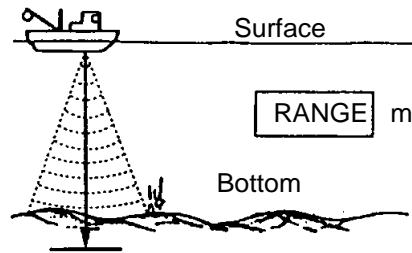

Figure 3-3 Range concept

#### Default vertical fan mode range settings

Unit	1	2	3	4	5	6	7	8	9	10	11	12	13	14	15
Meters	10	20	30	40	60	80	100	120	160	200	250	300	400	500	600
Feet	30	60	90	120	150	200	250	300	400	500	600	800	1000	1500	2000

**Note 1:** Unit of range measurement may be selected for meters, feet, fathoms, passi/braza or Hiro (Japanese) with UNIT on the SYSTEM SETTING 1 menu. For details see page 5-10.

**Note 2:** Ranges may be freely preset as desired. For details see page 5-16.

### 3.4 Selecting Train Center

The [TRAIN] control determines the bearing of the vertical fan beam, from 0° to 180°. Bearing of beam position can be found with the train indicator.

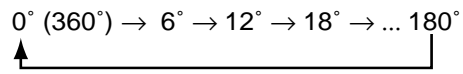

	Train Indicator	Train of Vertical Fan Beam

Figure 3-4 Train indicator

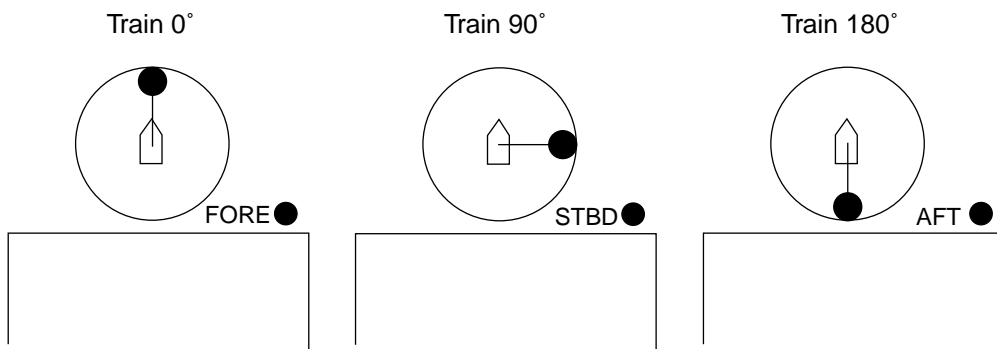

Figure 3-5 Train indicator and display

### 3.5 Selecting Display Sector

Sector means the width of the transducer training, from 6° to 180°.

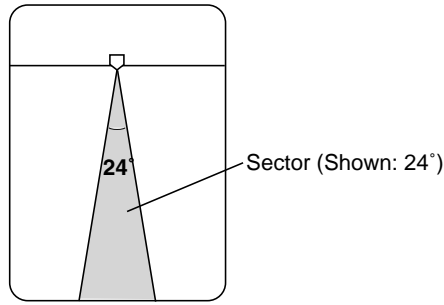

Figure 3-6 Sector

The [SECTOR] control selects the training area among the sixteen positions shown in the table below. Clockwise rotation of the control increases the sector width; counterclockwise rotation decreases it.

	1	2	3	4	5	6	7	8	9	10	11	12	13	14	15	16
Sector width (°)	6	12	24	36	48	60	72	84	96	108	120	132	144	156	168	180

#### One-touch selection of 180° sector

1. Press the [FULL/HALF] key. A half-circle display of 180° is presented.
2. Press the [FULL/HALF] key again, and a 120°-sector display is presented.

**Note:** Operating the [SECTOR] control between steps 1 and 2 in the procedure above displays the 180° sector at the next pressing of the [FULL/HALF] key.

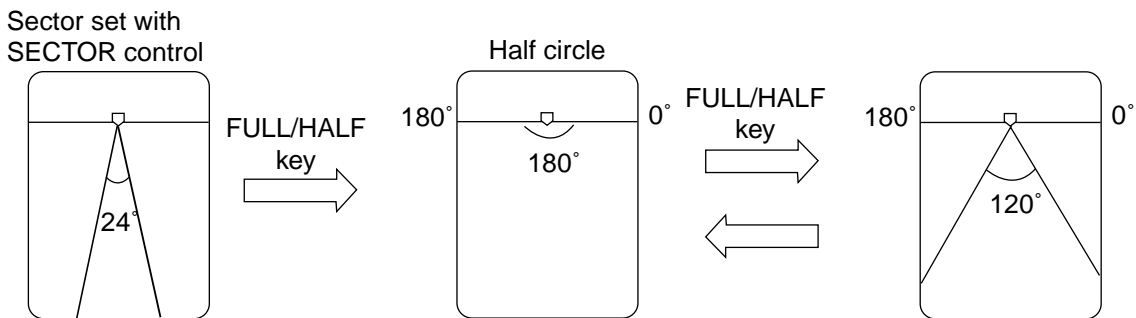

Figure 3-7 How the FULL/HALF key works

## 3.6 Selecting Sector Center

The center direction of the sounding beam in the vertical direction can be changed with the [TILT] control. The setting range is  $0^{\circ}$  to  $180^{\circ}$  in increments of  $6^{\circ}$ . Select the setting which places the sector center in the middle of the detection range.

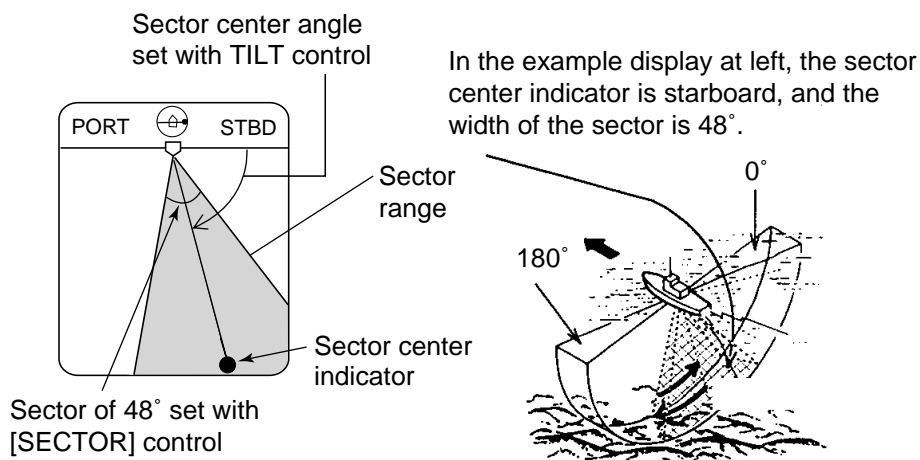

Figure 3-8 Sector center

### Automatic shifting of own ship position

Own ship position on the screen is automatically shifted either rightward or leftward according to the direction of the sector center and display sector width.

The figure below shows the own ship position has been shifted rightward on the screen to provide the wider view at the port side.

Sector center  $0^{\circ}$  to  $60^{\circ}$ : Own ship position shifted to port side

Sector center  $66^{\circ}$  to  $114^{\circ}$ : Own ship position shifted to center

Sector center  $120^{\circ}$  to  $180^{\circ}$ : Own ship position shifted starboard

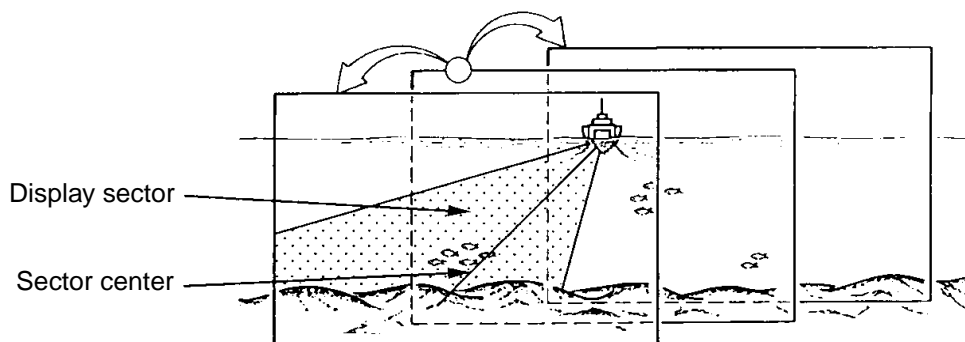

Figure 3-9 How automatic shifting works



### 3.7 Selecting the Training Speed

The training speed selects how fast the transducer scans the display sector. Two choices are available, 3° (normal speed, default setting) and 6° (high speed), and one may be selected with the [FAST SCAN] key. Each time the key is pressed the display momentarily shows “NORM” (normal speed) or “FAST” (high speed).

Normal: 60 transmissions for half circle in increments of 3°.

High: 30 transmissions for half circle in increments of 6°.

### 3.8 Finding Echo Position with the Cursor

The cursor measures horizontal range and depth. Operate the Omnipad to place the cursor where desired. Cursor data appears at the top left-hand corner on the screen.

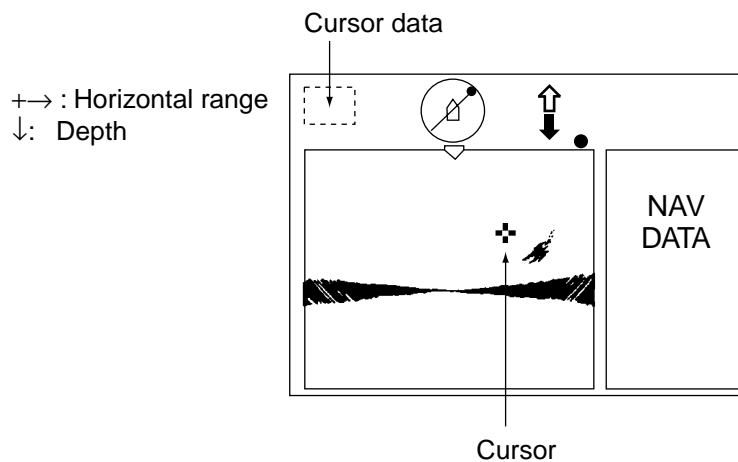

Figure 3-10 Location of cursor position data

## 3.9 Event Marker

The event marker functions to mark important locations on the screen, and five event markers may be inscribed. Each time the [EVENT] key is pressed the "latest event marker" (⊕) is inscribed at the cursor location and all previously entered event markers are shown by the "previous event marker" (+). When the capacity for event markers is reached the eldest event marker is erased from the screen to make room for the latest.

**Note 1:** Event marker position can be output to external equipment and marked on the display of the external equipment. Each press of the [EVENT] key outputs event marker position. For details see TARGET L/L on page 5-11.

**Note 2:** Event markers cannot be inscribed from the vertical fan display when it is in the sub window (Horizontal/vertical fan display). Inscribe the marker from the horizontal display to show it in the vertical fan display.

3. Operate the Omnipad to place the cursor on the location desired for an event marker.
4. Press the [EVENT] key to inscribe the event marker. The event marker is inscribed on the vertical fan display, as well as the horizontal and video plotter displays.

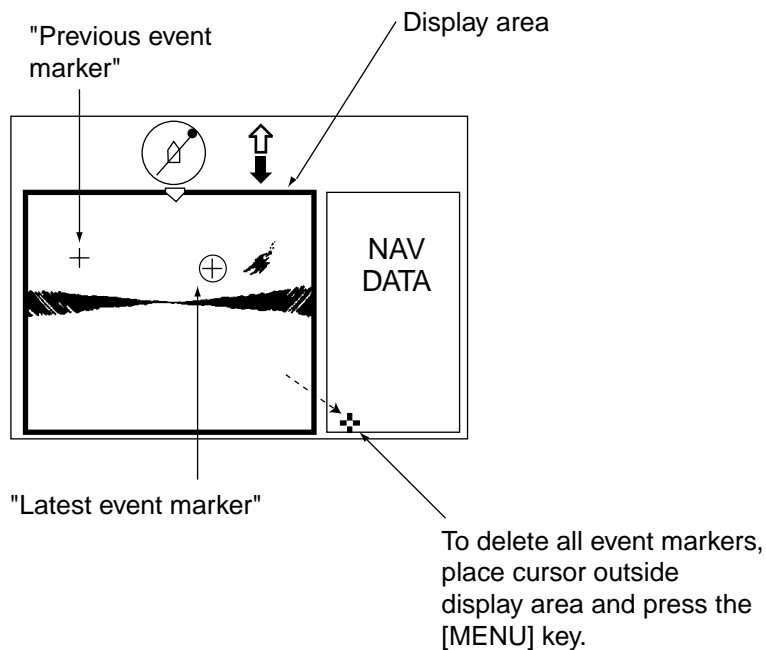
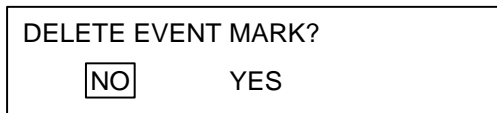

Figure 3-11 How to inscribe, delete the event markers

### 3.9.1 Deleting all event markers

All event markers can be erased from the screen as follows:

4. Operate the Omnipad to place the cursor outside the display area.
5. Press the [EVENT] key to show the following dialog box. Do the next step within four seconds, otherwise the dialog box will be erased.



6. Press **▶** to select YES and press the [MENU] key. All event markers are erased from the screen.

### 3.10 Depth and Horizontal Range Markers

The depth and horizontal range markers function to measure the horizontal range and depth to a desired echo.

**Note:** Depth and horizontal range markers cannot be inscribed from the vertical fan display when it is in the sub window (Horizontal/vertical fan display). Inscribe the markers from the horizontal display to show it in the vertical fan display.

1. Operate the Omnipad to place the cursor on the location desired.
2. Press the [R/B] key to display the depth and horizontal range markers. Horizontal range and depth appear on the screen.
3. To erase the depth and horizontal range markers, press the [R/B] key again, or place the cursor on the depth or horizontal range marker and press the [R/B] key.

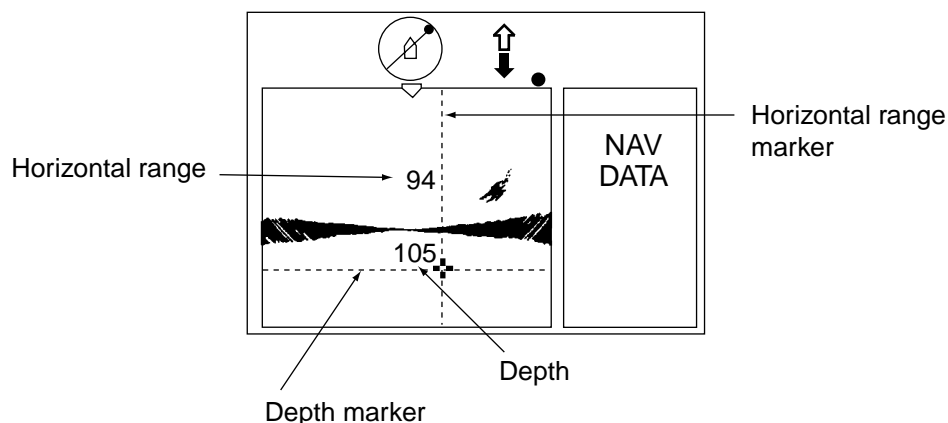

Figure 3-12 Depth and horizontal range markers

## 3.11 Adjusting the Picture

### 3.11.1 Displaying weak echoes clearly

Echoes from targets (such as the bottom or a fish) return to the transducer in order of the distance to them, and when their intensities are compared at the transducer face, those from nearer targets are generally stronger when their reflecting properties are nearly equal. The sonar operator will be quite inconvenienced if these echoes are directly displayed on the screen, since he won't be able to judge the actual size of the target from the size of echoes displayed on the screen. To overcome this inconvenience, use the TVG function. It compensates for propagation loss of sound in water: amplification of echoes on short range is suppressed and gradually increased as range increases, so that similar targets are displayed in similar intensities irrespective of the ranges to them.

The TVG also functions to suppress unwanted echoes and noise which appears in a certain range area on the screen.

#### To adjust TVG:

1. Press the [MENU] key to open the menu.
2. Press ▲ to select MENU and then press ◀ or ▶ to select the VERT menu.

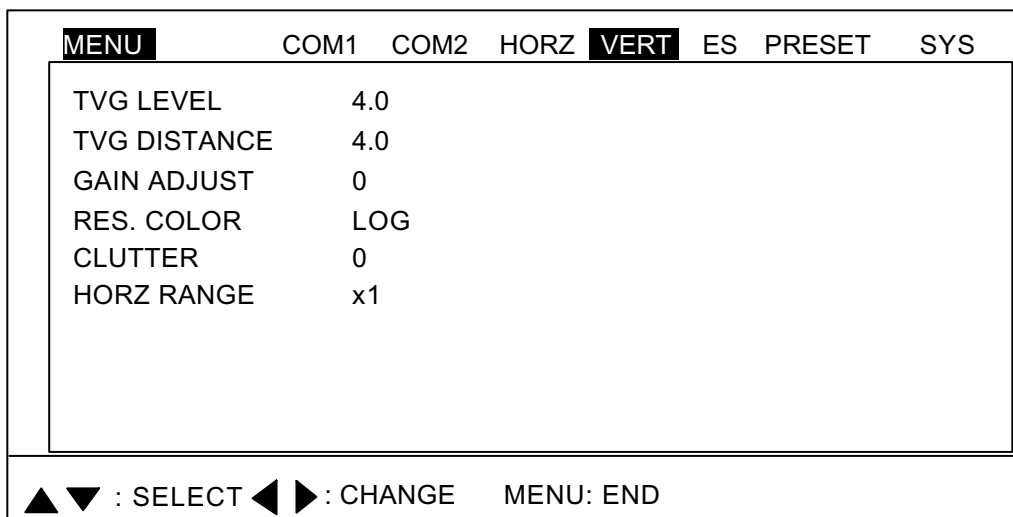
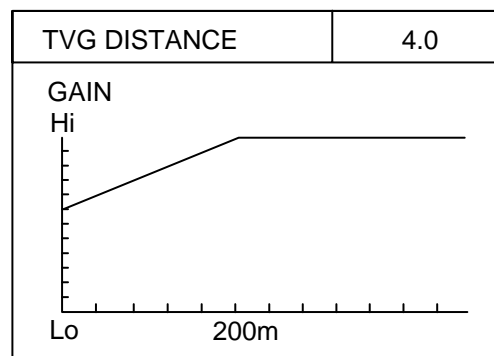

Figure 3-13 VERT menu

3. Press ▲ or ▼ to select TVG DISTANCE and press ▶ to show the following dialog box.



- Press ◀ or ▶ to adjust TVG distance, considering sea conditions. The larger the figure the greater the distance at which the TVG works.

TVG Distance Setting	0	0.5	1.0	1.5	2.0	2.5	3.0	3.5	4.0	4.5	5.0	....	10.0
Meters	3	8	20	40	60	100	130	160	200	250	320	....	1000
Feet	10	30	70	130	210	330	410	520	660	820	1040		3280
Passi/braza	2	5	10	20	40	60	80	100	120	150	180		600
Hiro	2	5	10	20	40	60	80	100	130	170	210	....	660

- Press ▲ or ▼ to close the dialog box and return to the VERT menu.
- To suppress reflections by the sea surface or plankton, select TVG LEVEL and press ▶.
- Press ◀ or ▶ to adjust TVG LEVEL, considering sea conditions. The larger the figure the less the gain over distance.
- Press the [MENU] key to register your selection and close the menu.

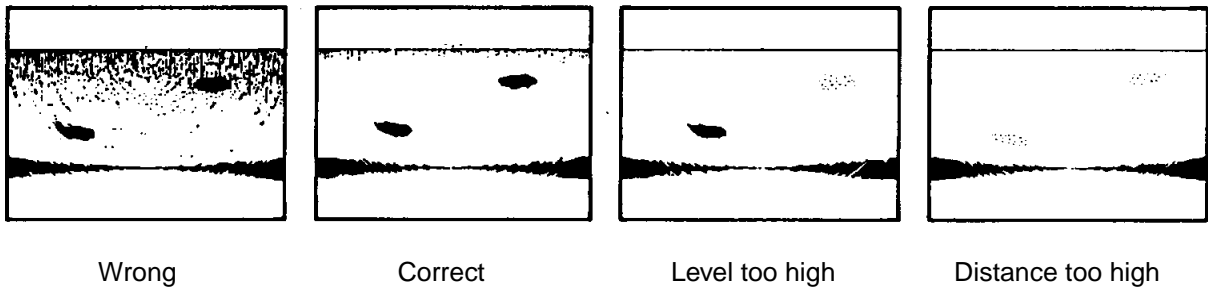

Figure 3-14 Examples of proper and improper TVG

### 3.11.2 Suppressing noise and interference

You may encounter occasional or intermittent noise and interference as shown below. This is mostly caused by electrical equipment, engine, propeller noise from own ship, or noise from other sonars being operated nearby. If interference appears, turn on the interference rejector in the COM1 menu to suppress it.

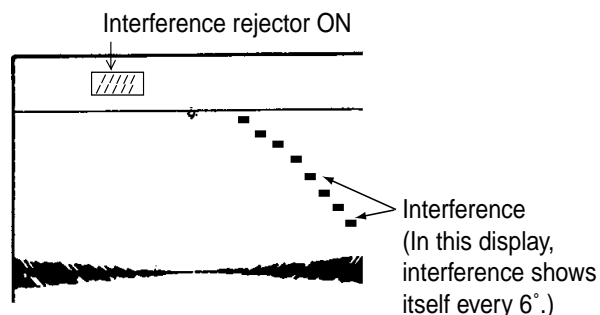

Figure 3-15 Appearance of interference

## 3.12 Vertical Menu Overview

This section presents an overview of the items on the VERT menu.

1. Press the [MENU] key to open the menu.
7. Press ▲ to select MENU and then press ◀ or ▶ to select the VERT menu.

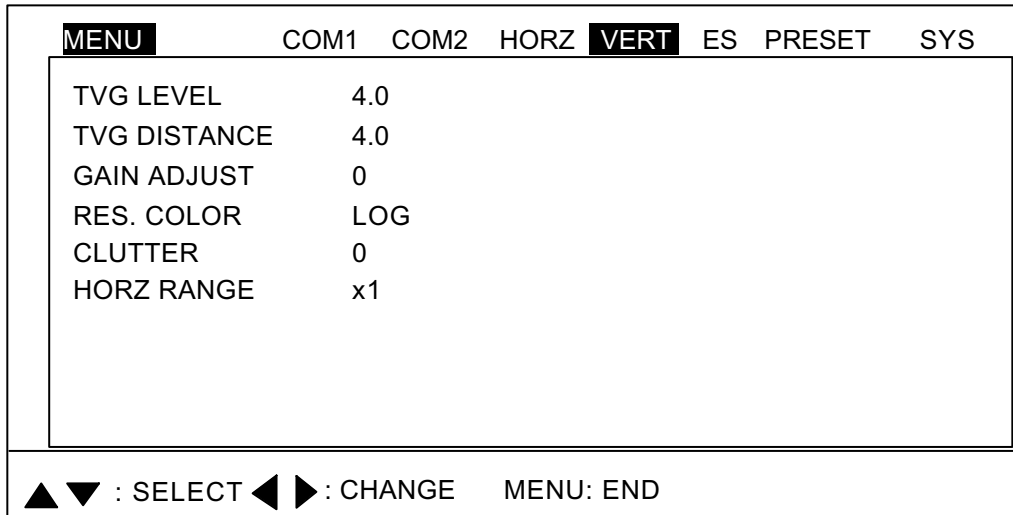

Figure 3-16 VERT menu

8. Press ▲ or ▼ to select item desired.
9. Press ▶ to show corresponding dialog box.
10. Press ◀ or ▶ to select option desired.
11. Press the [MENU] key to register your selection and close the menu.

### 3.12.1 Vertical menu description

**TVG LEVEL:** Compensates for propagation loss of sound in water. The default setting is 4.0.

**TVG DISTANCE:** As above. Default setting is 4.0.

**GAIN ADJUST:** Compensates for too weak or too strong echo level. Adjust it when the gain on the vertical fan mode is not the same as that on the horizontal and echo sounder modes. Setting range: -10 to +10. Default setting is 0.

**RES. COLOR:** Sets transfer characteristics of input signal level versus display echo level. Echo strength is emphasized in order of CUBE, SQUARE, LINEAR, LOG. You can see the characteristics of each by watching the color bar as you change the setting. Default setting is LOG.

LOG: Displays weak to strong echoes in their respective levels. This setting is suitable for general use.

LINEAR: Downplays the weak echoes when compared with LOG. Effective for suppressing weak echoes such as plankton.

SQUARE: Strong echoes are emphasized more than in LINEAR.

CUBE: Strong echoes are emphasized even more than in SQUARE.

**CLUTTER:** Low intensity echoes, often caused by sediments in water, are painted on the screen as a large number of random dots. The higher the number (setting) the weaker the echoes which are erased.

**HORZ RANGE:** You may choose the horizontal range expansion factor for the vertical scan picture, from x1 or x2. Note that this feature cannot be adjusted when the vertical search mode, activated by a function key, is turned on.

### 3.13 Interpreting the Vertical Fan Display

This section provides information necessary for interpreting the vertical fan display.

#### 3.13.1 How the vertical fan mode picture is painted

The sounding beam is emitted and the information (target echoes) obtained by the beam appears in the corresponding sector as it appears on the sonar mode. The difference is that the training is performed only in vertical direction. It forms a sounding area of a half-circle (like a slice of watermelon) to observe a vertical section of underwater conditions.

The bearing of the vertical sounding beam can be selected manually or automatically.

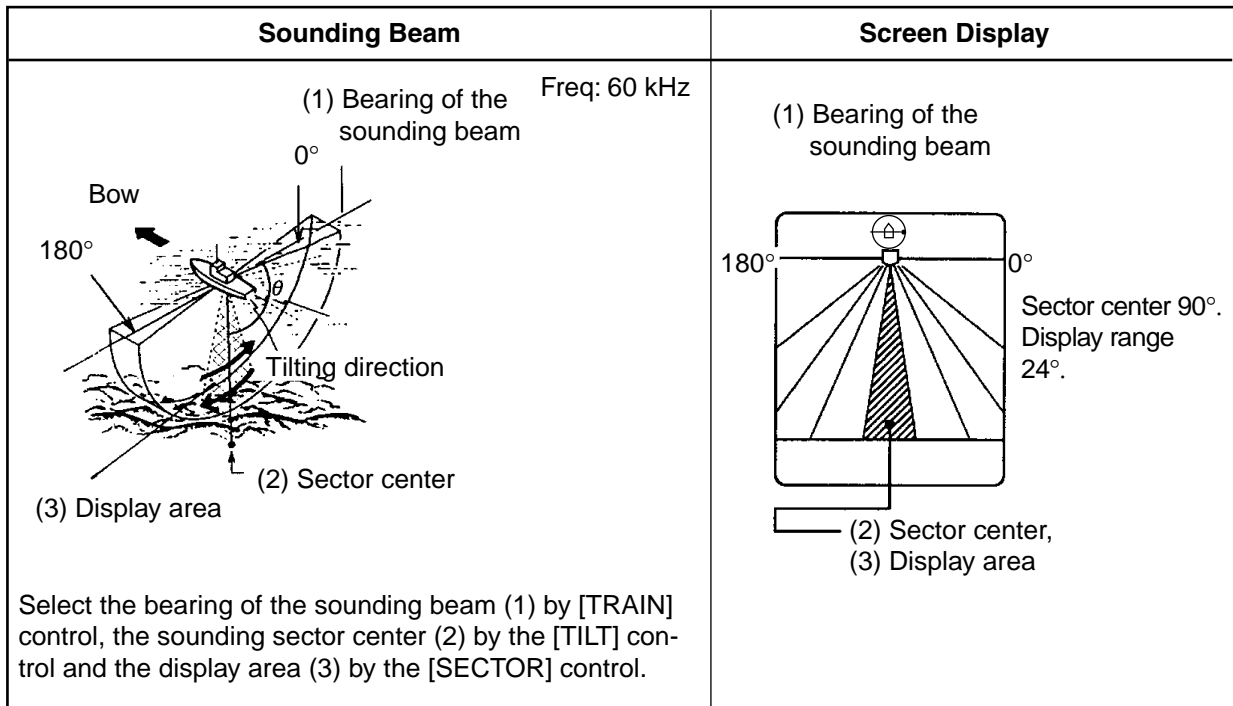

Figure 3-17 How the vertical fan mode picture is painted

### 3.13.2 Sample echo displays

#### Port-starboard picture (bottom)

You can see fish echoes at the center-right of the screen. The bottom is displayed wider as the distance from the ship's position increases. Therefore, it may be difficult to discriminate bottom fish.

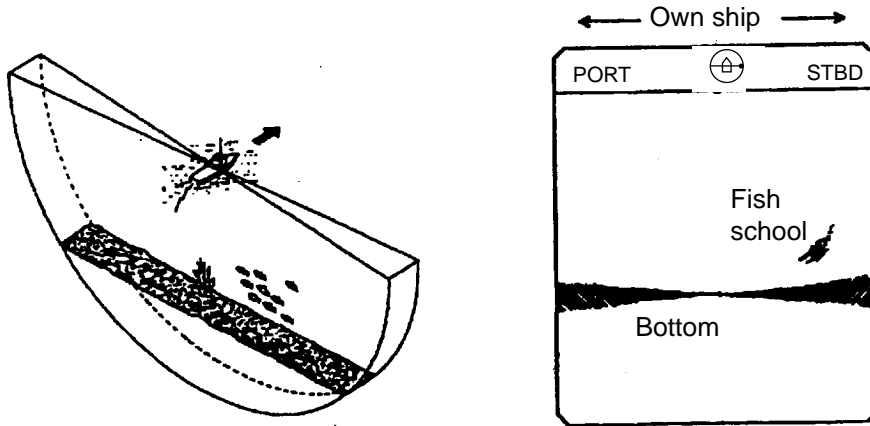

Figure 3-18 Port-starboard picture

#### When ship passes over fish schools

The sounding beam is directed fore-aft and the display is off-centered\* to present a wider view of the area forward of the ship. You can clearly see fish schools approaching from the bow of the ship.

\*: Automatically shifted.

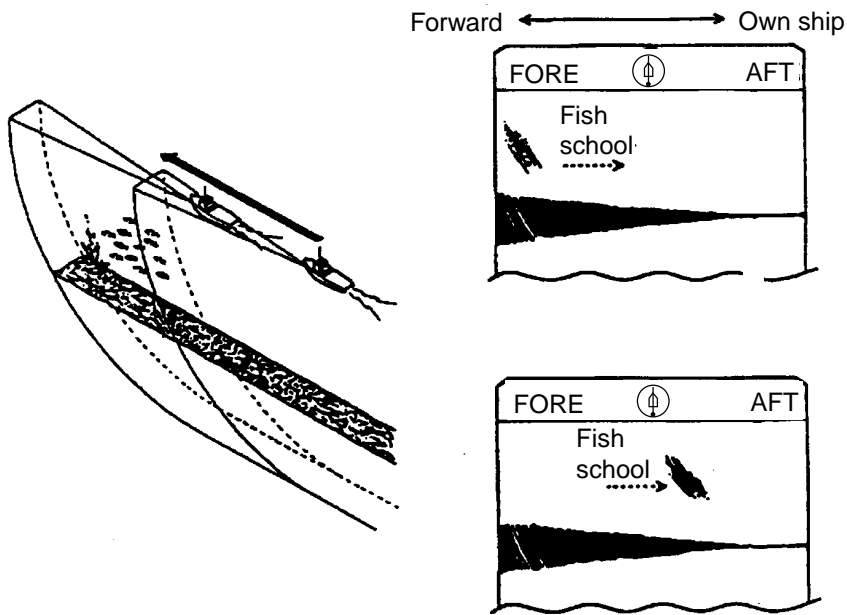
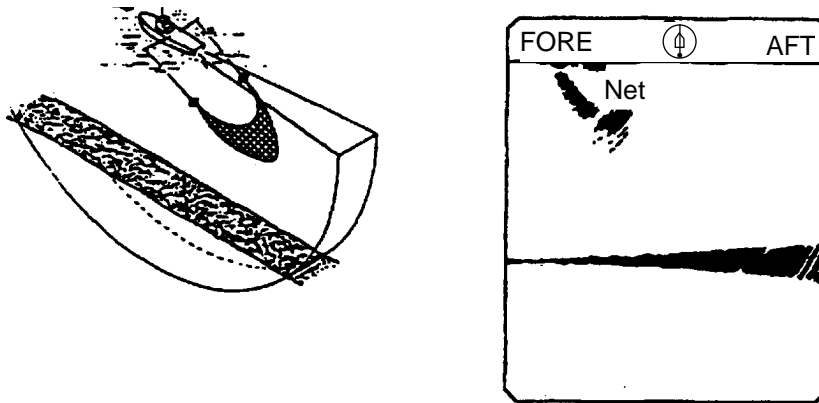

Figure 3-19 Picture appearance when passing over fish schools



## Display of net hauling

This is an example of net hauling display. The location of the net is indicated clearly.



*Figure 3-20 Net hauling and sonar picture*

## False echo

In shallow water (depth less than 100 m) detection, unwanted echoes shown in the figure may appear. This phenomenon is caused by the false echo from the previous transmission. Reducing the Tx rate on the COM1 menu may lessen this effect.

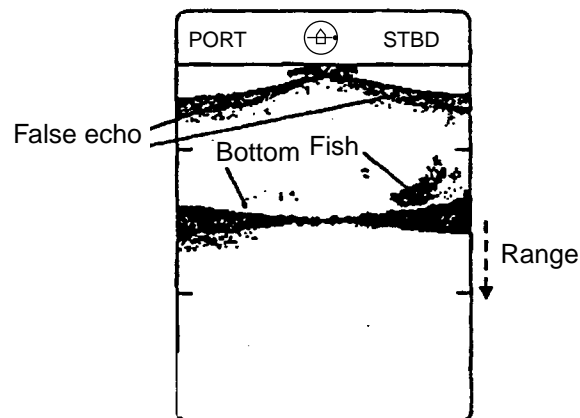

*Figure 3-21 False echoes*

### 3.13.3 Horizontal/vertical fan display

Press the  key to display the horizontal/vertical fan display.

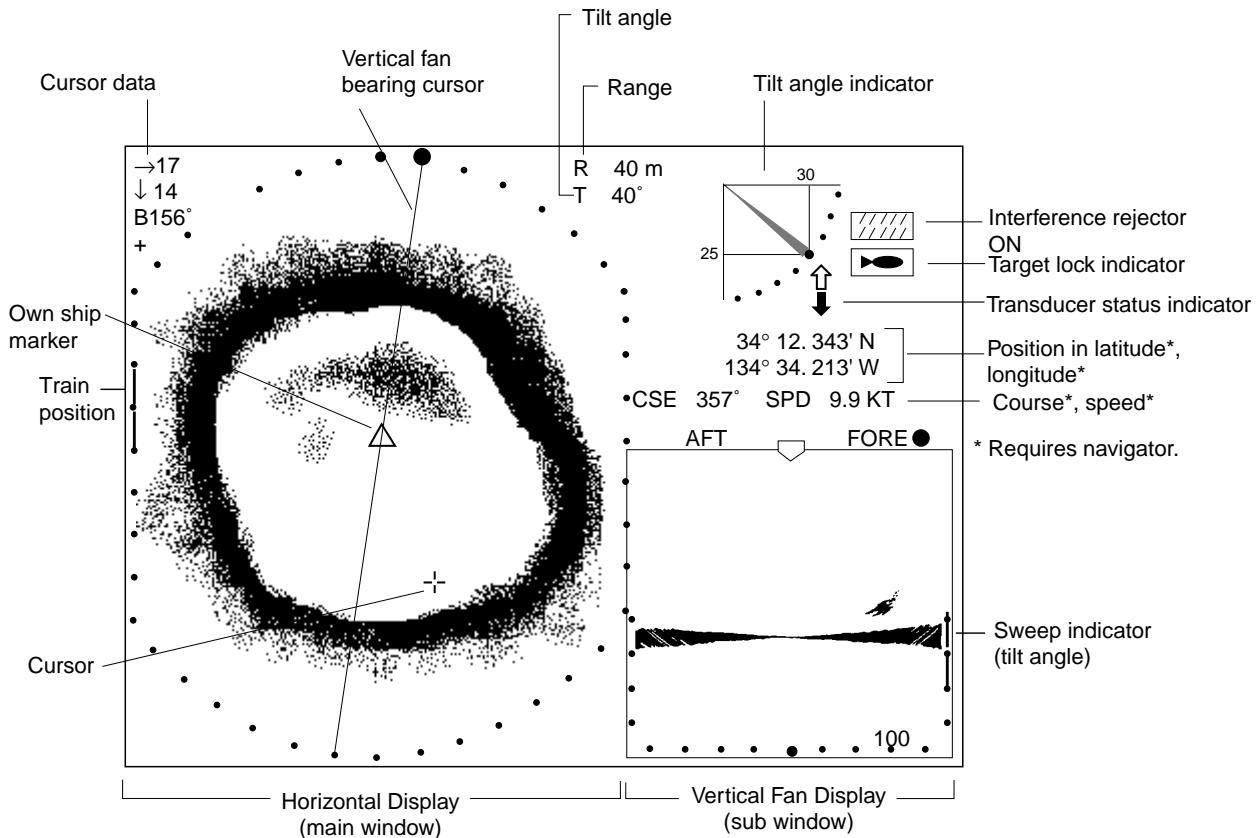

Figure 3-22 Horizontal/vertical fan display

The horizontal display appears in the main window; the vertical fan display in the sub window.

The displays are independent of each other so you can adjust them as desired. Press the [MAIN/SUB] key to select the window to adjust. Each pressing of the key momentarily displays MAIN WINDOW CONTROLLABLE or SUB WINDOW CONTROLLABLE at the top of the screen. A red cursor appears in the sub window when it can be controlled. The following controls are operative on either window: SECTOR, TRAIN, RANGE, TILT, FAST SCAN, FULL/HALF and CUSTOM MODE.

**Note:** R/B, EVENT or TARGET controls may only be operated from the main window. When you attempt to operate them from the sub window the message SELECT MAIN WINDOW appears.

#### TRAIN control

For horizontal display: Sets training center direction.

For vertical fan display: Sets direction of bearing cursor shown on the horizontal mode display.

## **SECTOR control**

For the vertical fan display: When the display sector is 6° (minimum) the tilt angle of the horizontal and vertical fan modes are interlocked and each transmission on the horizontal display is reflected on the vertical fan display. The message TILT ANGLE MONITOR WINDOW momentarily appears on the screen and the vertical bearing cursor disappears.

**Note:** Only the [SECTOR] control may be operated in this condition.

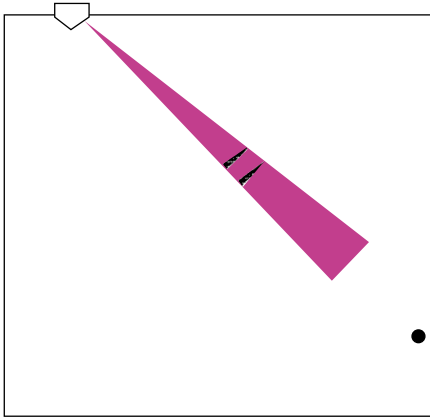

The size of the vertical scan and horizontal displays and the location of the vertical scan display may be changed as desired. Press the  key to change the arrangement as in the figure below.

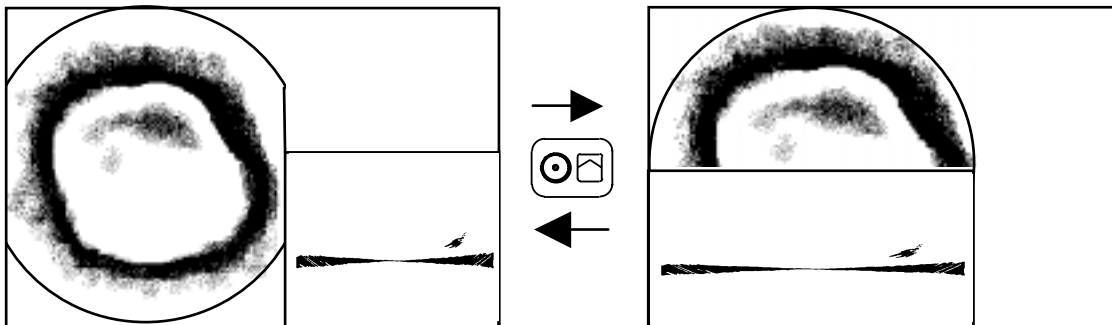

*(This page intentionally left blank.)*

# 4. ECHO SOUNDER MODE

## 4.1 Operational Overview

The figure below shows the typical echo sounder mode operating sequence.

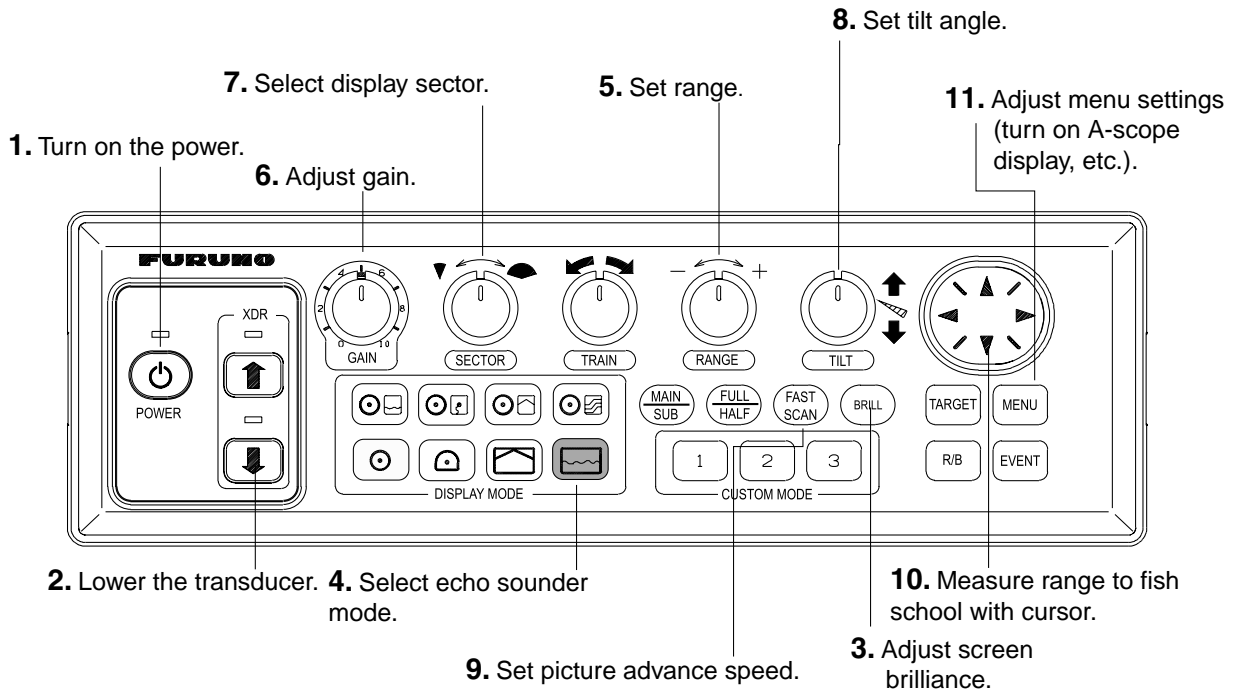

Figure 4-1 Control panel

## 4.2 Typical Echo Sounder Display

Press the  key to display the echo sounder picture.

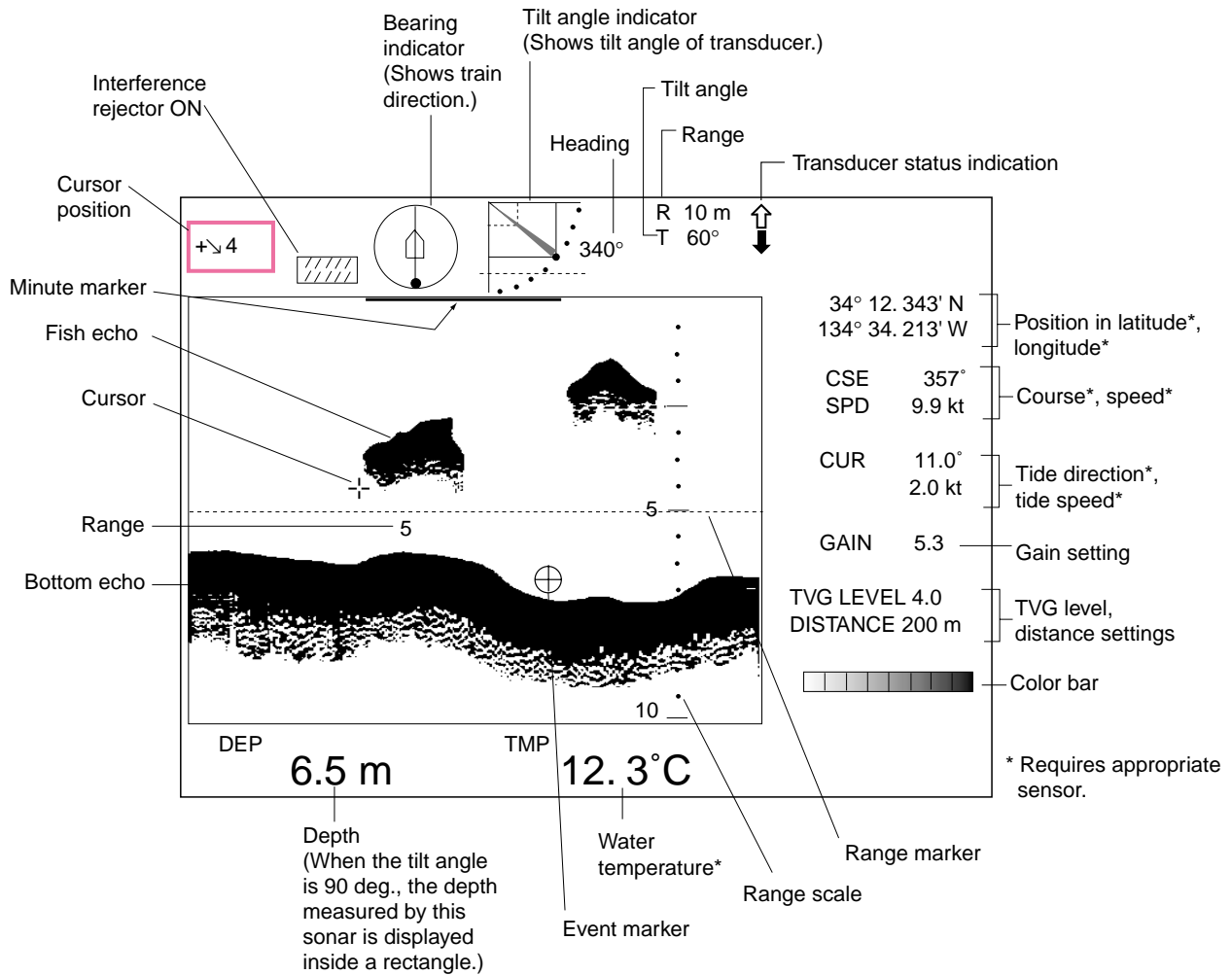

Figure 4-2 Typical echo sounder display

## 4.3 Selecting the Range

The [RANGE] control selects the detection (display) range, in 15 settings. Select the range according to either the fish species being searched or the depth desired. Each time the control is operated the newly selected range briefly appears in large characters at the screen top. Range is permanently displayed at the top right-hand corner.

Normally the range is set so that the bottom is traced at the lower part of the screen.

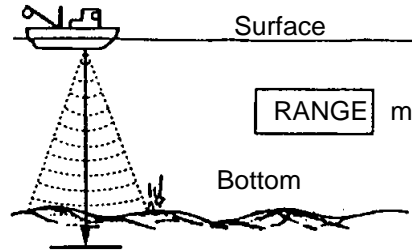

Figure 4-3 Range concept

### *Default echo sounder mode range settings*

Unit	1	2	3	4	5	6	7	8	9	10	11	12	13	14	15
Meters	10	20	30	40	60	80	100	120	160	200	250	300	400	500	600
Feet	30	60	90	120	150	200	250	300	400	500	600	800	1000	1500	2000

**Note 1:** Unit of range measurement may be selected for meters, feet, fathoms, passi/braza or Hiro (Japanese). For details see page 5-11.

**Note 2:** Ranges may be freely preset as desired. For details see page 5-17.

## 4.4 Train Direction

The sounding beam may be directed toward fore, aft, port or starboard. Operate the [TRAIN] control to select sounding beam direction. Each setting on the control is an increment of 6°. The train indicator at the top of the screen shows training direction: 0°, fore direction; 90°, starboard direction; 180°, aft direction, and 270°, port direction.

0° (360°) → 6° → 12° → 18° → ... 354°

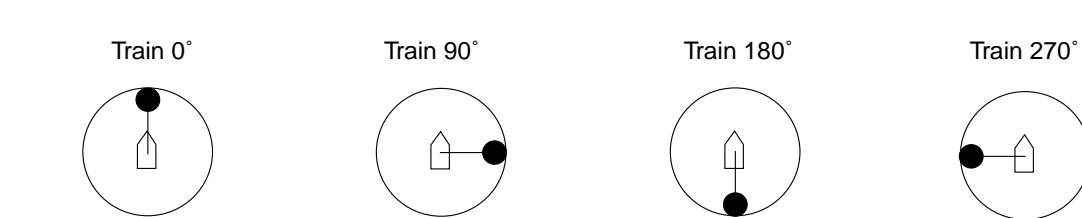

Figure 4-4 Train indicator and display

## 4.5 Selecting Tilt Angle

The transducer can be pointed directly toward the bottom or forward of the ship. Operate the [TILT] control to select an appropriate tilt angle. The available tilt angle is 0° (horizontal direction) to 90° (vertical) in increments of 1°. Selected tilt angle appears at the top of the display to the right of “T”.

## 4.6 Selecting Picture Advance Speed

The picture advance speed determines how quickly the vertical scan lines run across the screen, from right to left. When selecting a picture speed, keep in mind that a fast advance speed will expand a fish school horizontally on the screen and a slow one will contract it.

1. Press the [FAST SCAN] key. The following dialog box appears. Do the next step within four seconds otherwise the dialog box will be erased.

ADVANCE				
1/8	1/4	1/2	1/1	2/1

2. Press ◀ or ▶ ([FAST SCAN] key may also be used) to select a speed. The fractions in dialog box correspond to the number of scan lines produced per transmission. For example, “2/1” means two scan lines are produced per transmission.
3. Press the [MENU] key to close the dialog box. Note that the dialog box is automatically closed if there is no control operation for about four seconds.



## 4.7 Measuring Range by Cursor

Use the cursor to display the range from own ship to the cursor location. Use the Omnipad to place the cursor where desired. The range to the cursor appears at the upper left-hand corner of the screen.

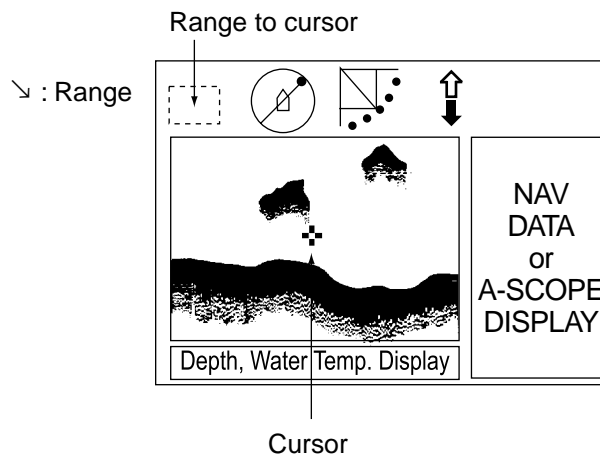

Figure 4-4 How to measure range with the cursor

## 4.8 Event Marker

The event marker functions to mark important locations on the screen, and five event markers may be inscribed. Each time the [EVENT] key is pressed the "latest event marker" (⊕) is inscribed at the cursor location and all previously entered event markers are shown by the "previous event marker" (+). When the capacity for event markers is reached the eldest event marker is erased from the screen to make room for the latest.

**Note 1:** The event marker inscribed on the echo sounder display will also be inscribed on the horizontal and video plotter displays. However, the mark is always inscribed at own ship position on the horizontal and video plotter displays regardless of the location of the mark on the echo sounder display.

**Note 2:** Event marker position can be output to external equipment and marked on the display of the external equipment. Each press of the [EVENT] key outputs event marker position. For details see TARGET L/L on page 5-11.

**Note 3:** Event markers are automatically erased as they move off the screen with picture advancement.

## 4.8.1 Inscribing the event marker

1. Operate the Omnipad to place the cursor on the location desired for an event marker.
2. Press the [EVENT] key to inscribe the event marker.

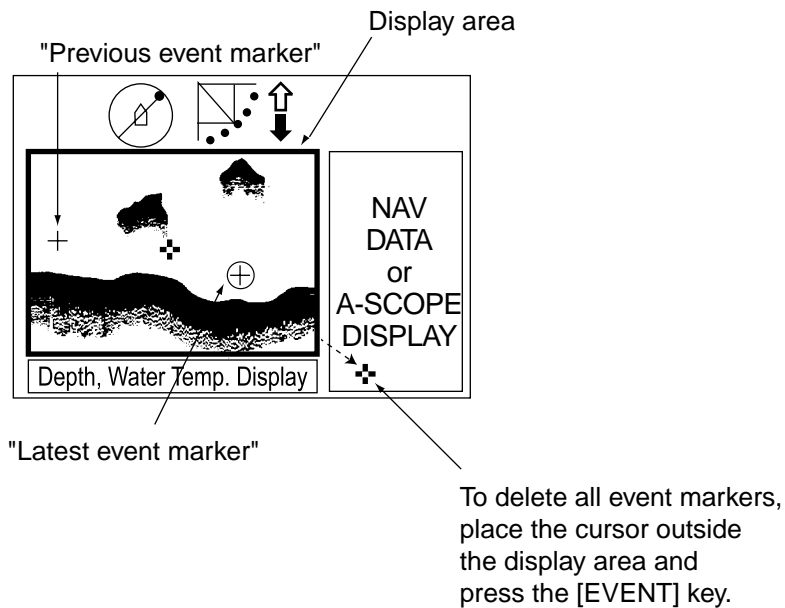

Figure 4-5 How to inscribe, delete the event markers

## 4.8.2 Deleting all event markers

All event markers can be erased from the screen as follows:

1. Operate the Omnipad to place the cursor outside the display area.
2. Press the [EVENT] key to show the following dialog box. Do the next step within four seconds, otherwise the dialog box will be erased.

DELETE EVENT MARK?	
<input type="checkbox"/> NO	<input type="checkbox"/> YES

3. Press **▶** to select YES and press the [MENU] key. All event markers are erased from the screen.

## 4.9 Range Marker

The range marker functions to measure the range to a target echo (fish school, bottom, etc.)

1. Operate the Omnipad to place the cursor on the location desired.
2. Press the [R/B] key to display the range marker. The range marker appears along with range indication.
3. To erase the range marker, press the [R/B] key again, or place the cursor on the range marker and press the [R/B] key.

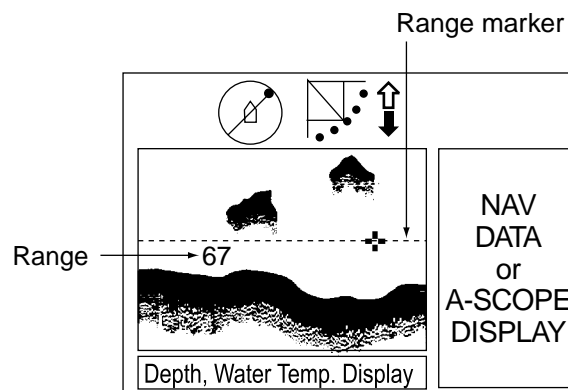

Figure 4-6 Range marker

## 4.10 Adjusting the Picture

### 4.10.1 Displaying weak echoes clearly

Echoes from targets (such as the bottom or a fish) return to the transducer in order of the distance to them, and when their intensities are compared at the transducer face, those from nearer targets are generally stronger when their reflecting properties are nearly equal. The sonar operator will be quite inconvenienced if these echoes are directly displayed on the screen, since he won't be able to judge the actual size of the target from the size of echoes displayed on the screen. To overcome this inconvenience, use the TVG function. It compensates for propagation loss of sound in water: amplification of echoes on short range is suppressed and gradually increased as range increases, so that similar targets are displayed in similar intensities irrespective of the ranges to them.

The TVG also functions to suppress unwanted echoes and noise which appears in a certain range area on the screen.

#### To adjust TVG:

1. Press the [MENU] key to open the menu.
2. Press ▲ to select MENU and then press ◀ or ▶ to select the ES menu.

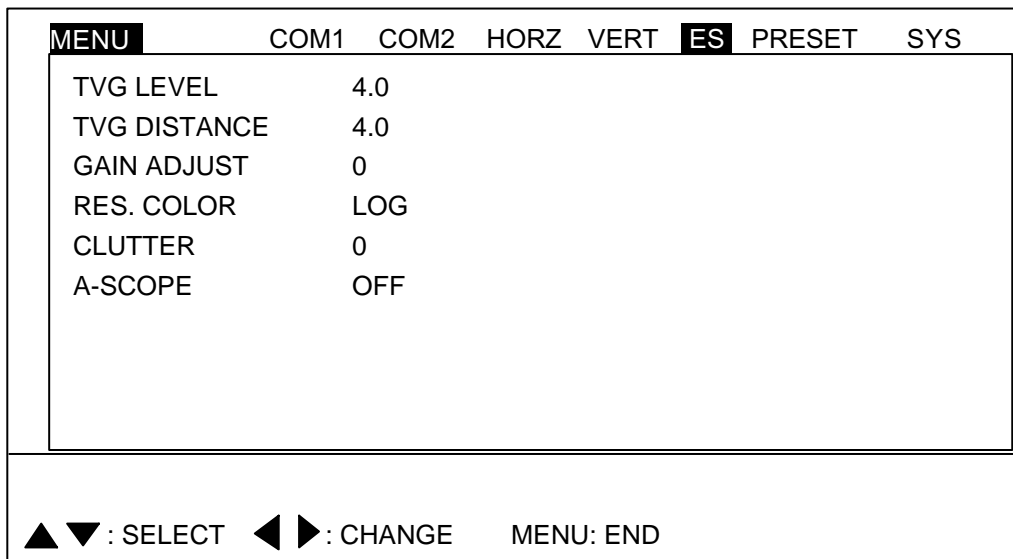
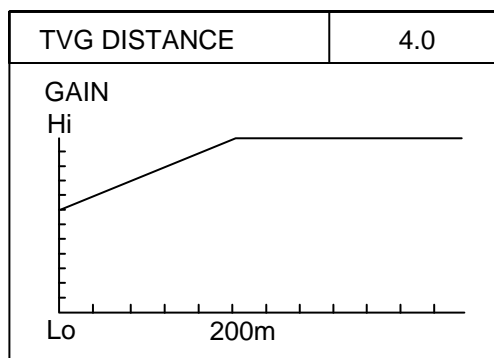

Figure 4-7 ES menu

- Press ▲ or ▼ to select TVG DISTANCE and press ▶. The following dialog box appears.



- Press ◀ or ▶ to adjust TVG distance.

TVG Distance Setting	0	0.5	1.0	1.5	2.0	2.5	3.0	3.5	4.0	4.5	5.0	....	10.0
Meters	3	8	20	40	60	100	130	160	200	250	320	....	1000
Feet	10	30	70	130	210	330	410	520	660	820	1040		3280
Passi/braza	2	5	10	20	40	60	80	100	120	150	180		600
Hiro	2	5	10	20	40	60	80	100	130	170	210	....	660

- Press ▲ or ▼ to close the dialog box and return the ES menu.
- To suppress reflections by the sea surface or plankton, select TVG LEVEL and press ▶.
- Press ◀ or ▶ to adjust TVG LEVEL.
- Press the [MENU] key to register your selection and close the menu.

## 4.10.2 Finding echo strength (A-scope display)

The A-scope display shows echoes at each transmission with amplitudes and tone proportional to their intensities on the right 1/4 of the screen. It is useful for estimating the kind of fish school and bottom composition.

1. Press the [MENU] key.
2. Press ▲ to select MENU.
3. Press ◀ or ▶ to select ES.
4. Press ▼ to select A-SCOPE.
5. Press ◀ or ▶ to open the dialog box.

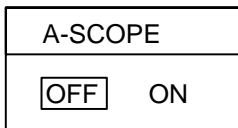

6. Press ▶ to select ON.
7. Press the [MENU] key to close the dialog box.

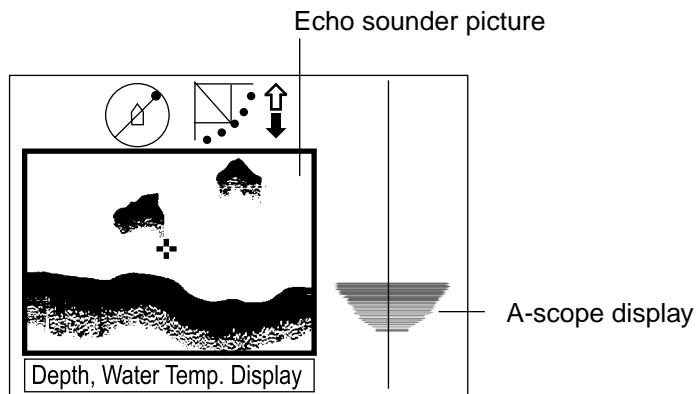

Figure 4-8 A-scope display

## 4.11 Echo Sounder Menu Overview

This section presents an overview of the items on the ES menu.

1. Press the [MENU] key to open the menu.
2. Press ▲ to select MENU and then press ◀ or ▶ to select the ES menu.

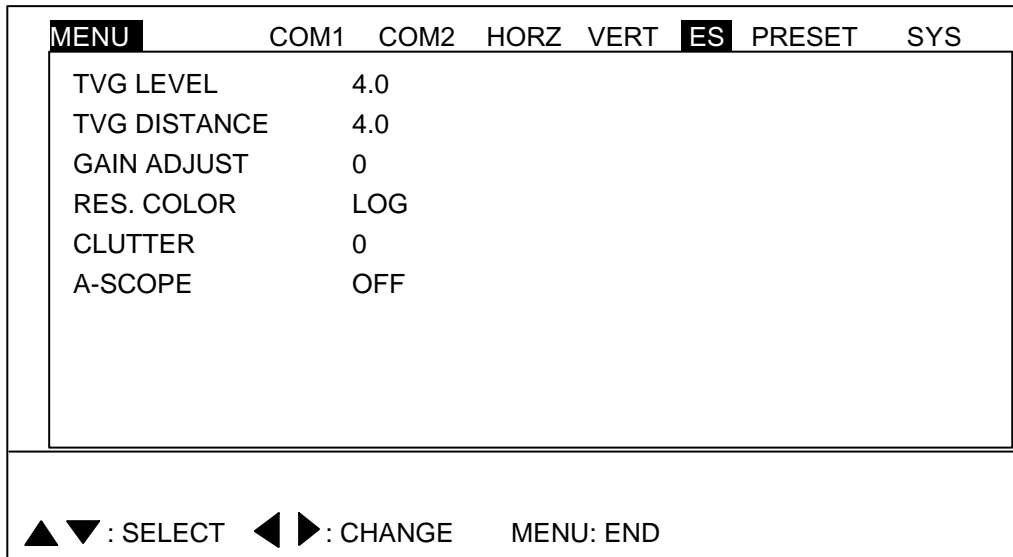

Figure 4-9 ES menu

3. Press ▲ or ▼ to select item desired.
4. Press ▶ to show corresponding dialog box.
5. Press ◀ or ▶ to select option desired.
6. Press the [MENU] key to register your selection and close the menu.

### 4.11.1 Echo sounder menu description

**TVG LEVEL:** Compensates for propagation loss of sound in water. See paragraph 4.10.1 on page 4-7. Default setting is 4.0.

**TVG DISTANCE:** As above. Default setting is 4.0.

**GAIN ADJUST:** Compensates for too weak or too strong echo level. Adjust the gain on the echo sounder mode when it is not the same as that on the horizontal and vertical fan modes. Setting range: -10 to +10. Default setting is 0.

**RES. COLOR:** Sets transfer characteristics of input signal level versus display echo level. Echo strength is emphasized in order of CUBE, SQUARE, LINEAR, LOG. You can see the characteristics of each by watching the color bar as you change the setting. The default setting is LOG.

**LOG:** Displays weak to strong echoes in their respective levels. This setting is suitable for general use.

**LINEAR:** Downplays the weak echoes when compared with LOG. Effective for suppressing weak echoes such as plankton.

**SQUARE:** Strong echoes are emphasized more than in LINEAR.

**CUBE:** Strong echoes are emphasized even more than in SQUARE.

**CLUTTER:** Low intensity echoes, often caused by sediments in water, are painted on the screen as a large number of random dots. The higher the number (setting) the weaker the echoes which are erased.

**A-SCOPE:** Turns the A-scope display on/off. Default setting is OFF. See paragraph 4.10.2 on page 4-9.

*(This page intentionally left blank.)*



# 5. MENU OPERATION

---

This chapter provides menu operating information on menus not previously discussed: COM1, COM2, PRESET (or SHORT-CUT, depending on the setting of CUSTOM KEY on the SYSTEM SETTING 1 menu) and SYS (System) menu.

## 5.1 COM1 Menu

1. Press the [MENU] key to open the menu.
2. Press ▲ to select MENU, and then press ◀ to select COM1.

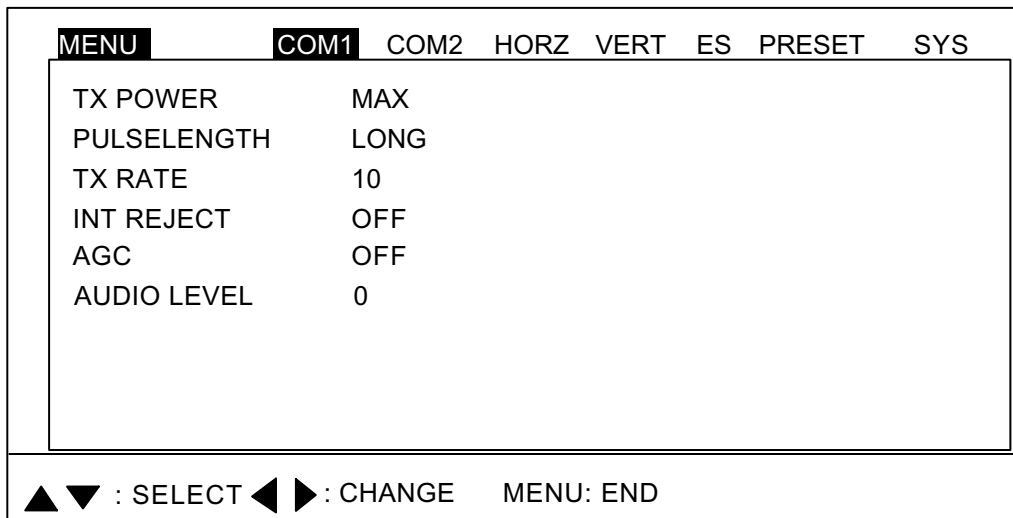

*Figure 5-1 COM1 menu*

3. Press ▲ or ▼ to select item; ◀ or ▶ to open associated dialog box.
4. Press ◀ or ▶ to select option desired.
5. Press ▲ or ▼ to return to the COM1 menu, or press the [MENU] key to register your selection and close the menu.

## 5.1.1 COM1 menu description

**TX POWER:** Selects transmitter output power to maximum or minimum. The default setting is "maximum." For further details see page 2-12.

**PULSELENGTH:** Selects pulselength to short or long (default setting). For details see paragraph 2.11.2 on page 2-13.

**TX RATE:** The Tx rate may be set between 1-10 (default setting: 10) in the case of the internal transmitter, or an external synchronous signal may be used. The higher the number the greater the number of transmissions. For operation in shallow waters, select the Tx rate which displays the second reflection from the bottom between the sea surface and bottom. For use of an external video sounder or sonar, select EXT.

**INT REJECT:** Turns the interference rejector on or off (default setting). For details, see paragraph 3.11.2 on page 3-11.

**AGC:** Automatically lowers sensitivity against strong echoes such as those from the bottom and large fish schools to emphasize weak echoes such as those from fish close to the bottom. The default setting is OFF.

**AUDIO LEVEL:** Adjusts the audio level of the external loudspeaker (option).

## 5.2 COM2 Menu

### 5.2.1 Displaying the COM2 menu

1. Press the [MENU] key to open the menu.
2. Press ▲ to choose MENU, and then press ◀ or ▶ to choose COM2.

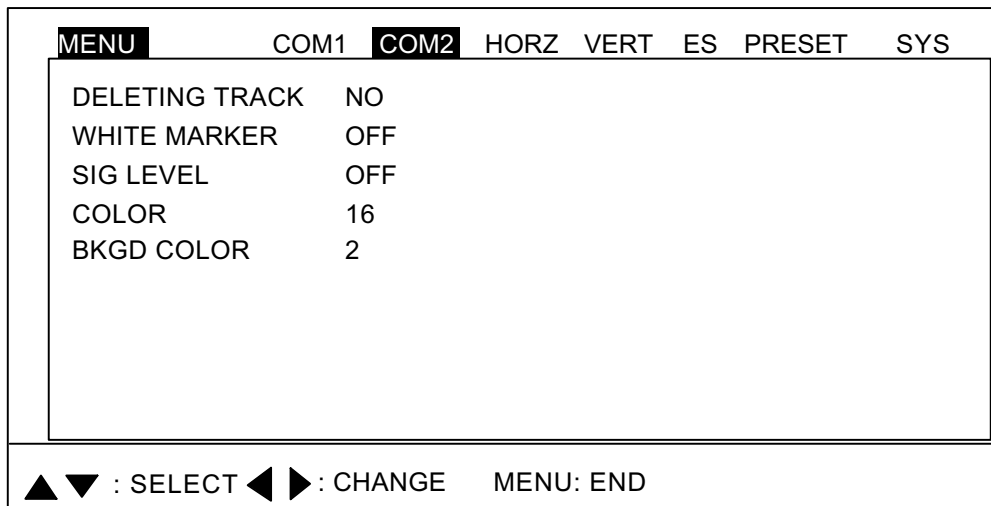

COM2 menu

### 5.2.2 COM2 menu description

**DELETING TRACK:** Choose ON to delete all ship's track (from horizontal and horizontal/video plotter displays).

**WHITE MARKER:** Displays desired echo in white. It is useful for discriminating bottom fish from the bottom echo. The setting range for the 8-color display is OFF, 1-7, and for the 16-color display, OFF, 1-15.

**SIG LEVEL:** Refer to page 2-17.

**COLOR:** Chooses 8- or 16-color display.

**BKGD COLOR:** Chooses color of background, text and menu. Three choices are available and these are shown in the table below.

BKGD COLOR	Background	Text	Menu
1	Black	Gray	Dark-blue
2	Dark-blue	White	Medium blue
3	White	Black	Gray

## 5.3 Short-cut Menu, Preset Menu

These menus program the CUSTOM MODE keys [1], [2] and [3], and one of the menus appears according to the setting of CUSTOM KEY on the SYSTEM SETTING 1 menu.

**Short-cut key:** One-touch activation of corresponding dialog box. This is the default setting.

**Preset key:** One-touch setup of mode, sector, train, range, tilt and speed controls. Below are the default settings for PRESET.

CUSTOM MODE key	Display Mode	Sector	Train	Range (m)*	Tilt	Speed
Key 1	Expanded Horizontal	240°	0°	250	30°	Fast
Key 2	Horizontal	360°	0°	250	30°	Fast
Key 3	Vertical Fan	180°	90°	120	90°	Fast

\* - Default range for 60 kHz transducer. Default range changes with transducer.

### 5.3.1 Selecting short-cut or preset

1. Press the [MENU] key to open the menu.
2. Press ▲ to select MENU, and then press ► to select SYS.

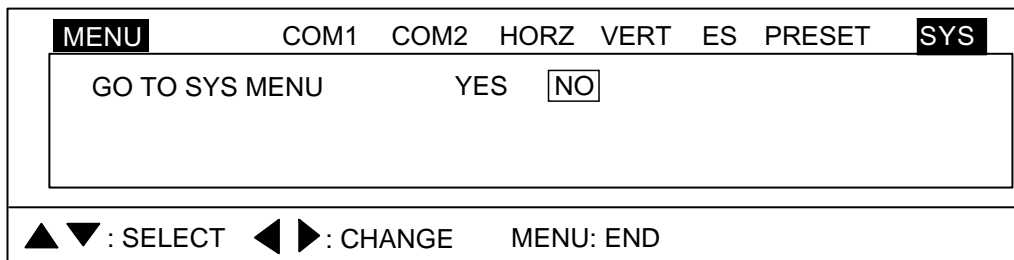

Figure 5-2 Display for opening system menu

3. Press ▼ to select GO TO SYS MENU.
4. Press ◀ to select YES.

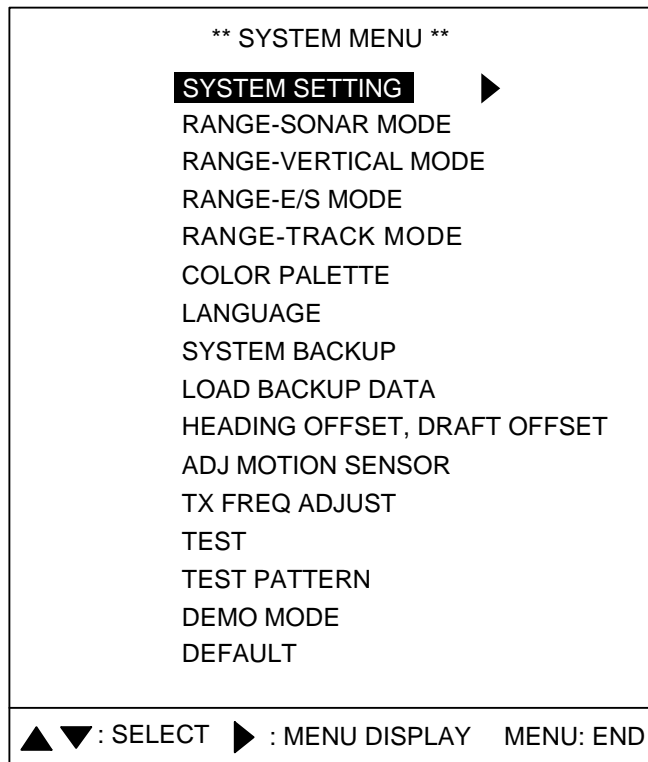

Figure 5-3 System menu

5. Press ► to open the SYSTEM SETTING menu.

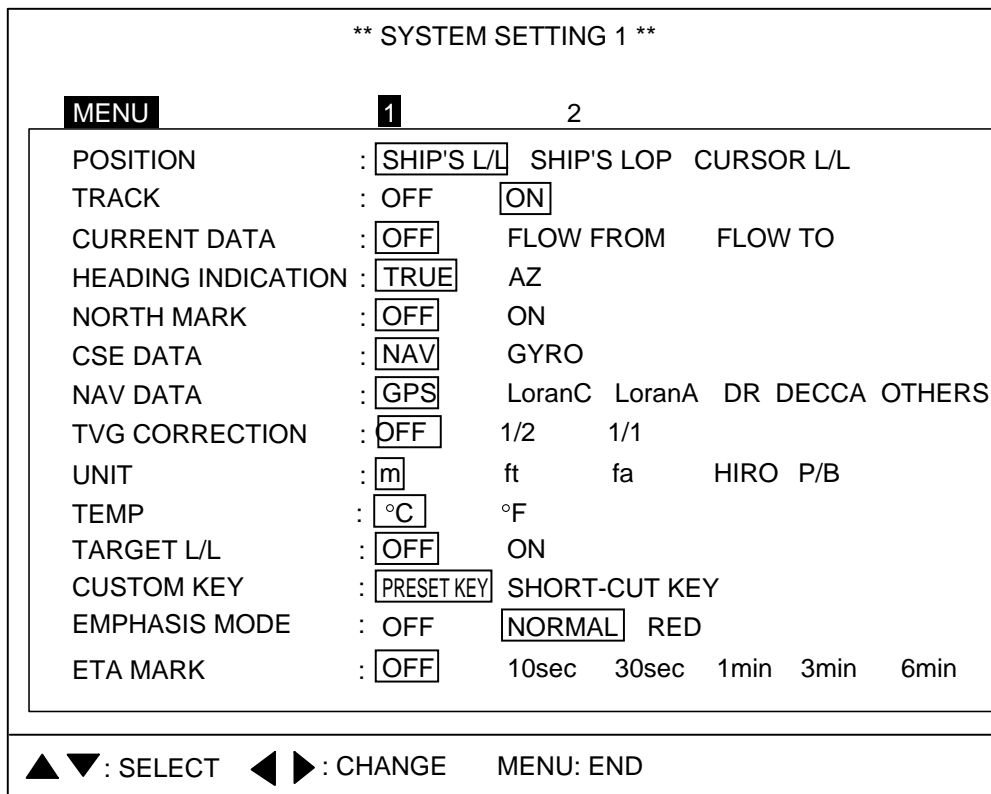





Figure 5-4 System setting 1 menu

6. Press ▲ or ▼ to select CUSTOM KEY.

7. Press ◀ or ▶ to select PRESET KEY or SHORT-CUT KEY as desired.
8. Press the [MENU] key twice to register your selection and close the menu.

### 5.3.2 Preset key

1. Select PRESET KEY following the procedure in paragraph 5.2.1 on page 5-3.
2. Press the [MENU] key to open the menu.
3. Press ▲ to select MENU, and then press ◀ or ▶ to select PRESET.

MENU		COM1	COM2	HORZ	VERT	ES	PRESET	SYS
	MODE	SECTOR	TRAIN	RANGE	TILT	SPEED		
PRESENT		360°	0°	160	30°	NORM		
CUSTOM1		240°	0°	160	30°	FAST		
CUSTOM2		360°	0°	160	30°	FAST		
CUSTOM3		180°	90°	120	90°	FAST		

ADJUST THE KNOBS AND FUNCTION KEYS TO THE DESIRED SETTING,  
THEN PRESS A CUSTOM MODE KEY TO SAVE THE SETTING.  
FUNCTION KEY: ENTRY MENU: END

Figure 5-5 PRESET menu

4. Set the [MODE], [SECTOR], [TRAIN], [RANGE], [TILT] and [FAST SCAN] controls according to target fish or fishing area.
5. Press the CUSTOM MODE keys [1], [2] or [3] to program. You are asked if you want to save the settings to the custom key pressed. (In the example, the custom key [1] was pressed.)

SAVE THE SETTING TO CUSTOM1 KEY?	
<input type="checkbox"/> NO	<input type="checkbox"/> YES
◀▶ : CHANGE MENU: END	

6. Press ▶ to select YES.
7. Press the [MENU] key. The message "PRGM SET" appears at the screen top.
8. Press the [MENU] key to finish.

### Activating custom mode

1. Press appropriate CUSTOM MODE key. The indication CUSTOM1, CUSTOM2 or CUSTOM3 appears at the top of the screen depending on key pressed.
2. To escape from the custom mode operation, operate any of the controls among [MODE], [SECTOR], [TRAIN], [RANGE], [TILT] and [FAST SCAN].

### 5.3.3 Short-cut key

The default settings are key [1], interference rejector; key [2], signal level, and key [3], background color. The operator may change their functions as desired.

**Note:** In the combination modes the short-cut key operation is only possible from the main window.

1. Select SHORT-CUT following the procedure in paragraph 5.2.1 on page 5-3.
2. Press the [MENU] key to open the menu.
3. Press ▲ to select MENU, and then press ◀ or ▶ to select SHORT-CUT.

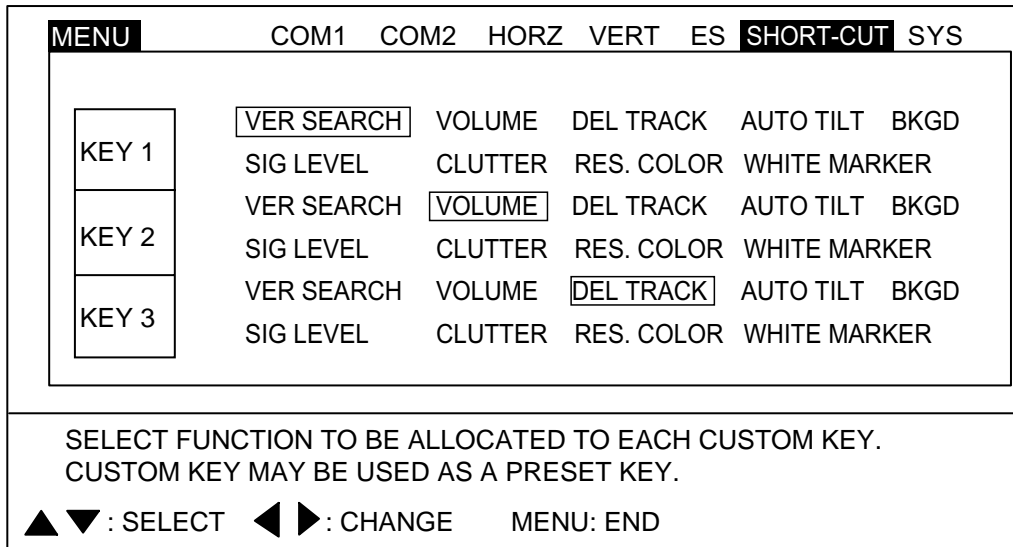

Figure 5-6 SHORT-CUT menu

4. Press ▲ or ▼ to select key to preset. For example select KEY 1.
5. Press ◀ or ▶ to select item.
6. Press the [MENU] key to finish.

#### Activating a short-cut key

1. Press a CUSTOM MODE key, and the dialog box programmed for the custom key pressed appears. The dialog box below is for CLUTTER (HORZ).



2. Press ◀ or ▶ to select option desired
3. Press the [MENU] key to close the dialog box.

## VERTICAL SEARCH FUNCTION

When you find a target of interest on the horizontal display, simply press the function key programmed for VER. SEARCH to get a cross-sectional view of the vertical plane. This mode is useful for evaluating fish school concentration and location of the targeted fish school or for navigation purposes.

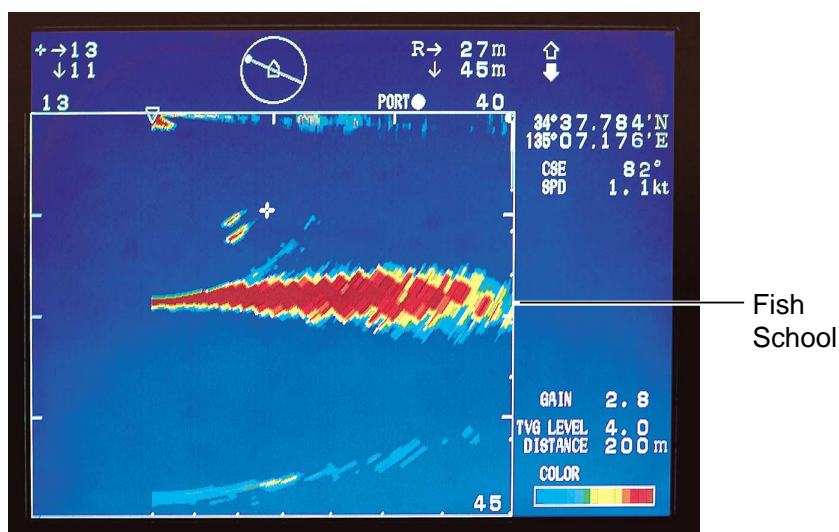

The vertical search picture is drawn using the following specifications:

- Horizontal range: Same as set on horizontal mode
- Vertical range: Same as set on horizontal mode
- Train marker: Train angle at the moment function key is turned on
- Vertical scan display range: 0-90 degrees (own ship position shifted leftward)



## 5.4 SYS Menu

This menu provides items which may be set according to operator's preference. A demonstration mode is provided to acquaint you with the many functions of this equipment, and it may be used without connection of the transducer.

1. Press the [MENU] key to open the menu.
2. Press ▲ to select MENU, and then press ► to select SYS.
3. Press ▼ to select GO TO SYS MENU.
4. Press ◀ to select YES.

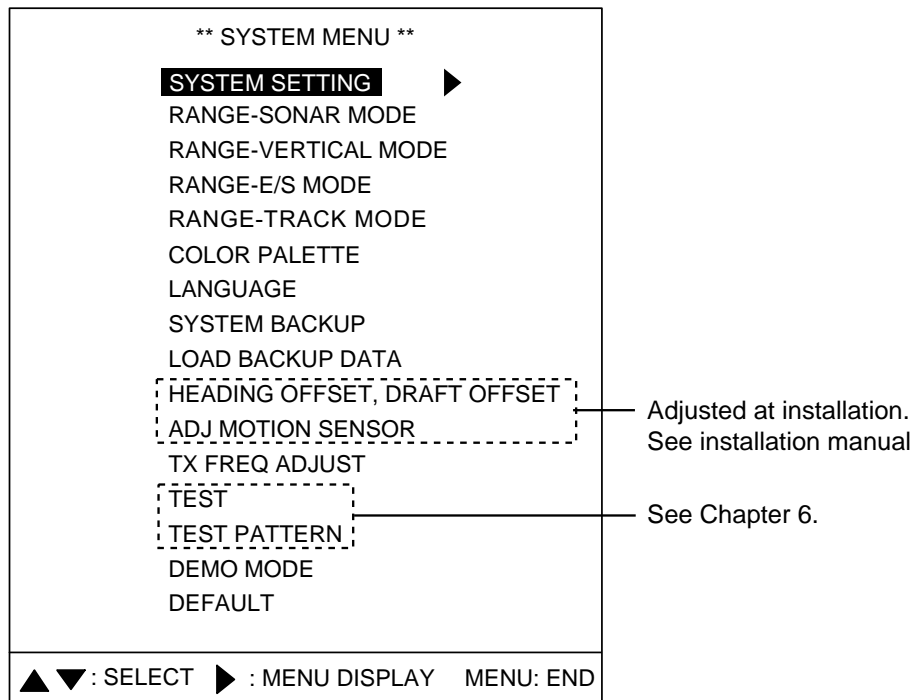

*Figure 5-7 System menu*

5. Press ▲ or ▼ to select item desired.
6. Press ◀ or ► to open corresponding dialog box.
7. Press ◀ or ► to select option.
8. Press the [MENU] key twice to register your selection and close the menu.

## SYSTEM SETTING 1 menu

1. Display the SYSTEM menu and press ▲ or ▼ to select SYSTEM SETTING.
2. Press ►.
3. Press ▲ to MENU.
4. Press ◀ to select "1."

** SYSTEM SETTING 1 **	
MENU	1 2
POSITION	: SHIP'S L/L SHIP'S LOP CURSOR L/L
TRACK	: OFF ON
CURRENT DATA	: OFF FLOW FROM FLOW TO
HEADING INDICATION	: TRUE AZ
NORTH MARK	: OFF ON
CSE DATA	: NAV GYRO
NAV DATA	: GPS LoranC LoranA DR DECCA OTHERS
TVG CORRECTION	: OFF 1/2 1/1
UNIT	: m ft fa HIRO P/B
TEMP	: °C °F
TARGET L/L	: OFF ON
CUSTOM KEY	: PRESET KEY SHORT-CUT KEY
EMPHASIS MODE	: OFF NORMAL RED
ETA MARK	: OFF 10sec 30sec 1min 3min 6min

▲▼ : SELECT ◀▶ : CHANGE MENU: END

Figure 5-8 System setting 1 menu

## SYSTEM SETTING 1 menu description

**POSITION:** Chooses how to displays ship's position; latitude and longitude, Decca/Loran LOP or Cursor L/L. (The connected navigator must be capable of displaying L/L or LOP.) The default setting is latitude and longitude. Position data required.

**TRACK:** Turns the track display on or off on the horizontal display. The track is always shown on the video plotter display regardless of this setting.

**CURRENT DATA:** Turns current data (tide) on or off. FLOW FROM shows from what direction the current is flowing; FLOW TO shows the direction the current is heading. The default setting is OFF. Requires connection of a current indicator.

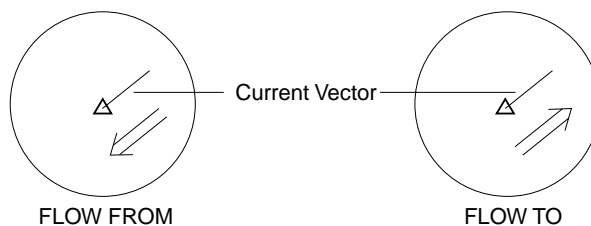

Figure 5-9 Current vector

**HEADING INDICATION:** Selects heading indication format, true (default setting) or azimuth, for the echo sounder and vertical fan modes. The default setting is TRUE. Requires heading data.

**NORTH MARK:** Turns the north marker on or off (default setting). Requires heading data.

**CSE DATA:** Selects heading data source, navigator or gyrocompass, to draw ship's track. The default setting is navigator. For heading sensor or gyrocompass connection, choose gyrocompass.

**NAV DATA:** Selects source of position data, GPS, Loran C, Loran A, DR (Dead Reckoning), Decca or Others (for equipment not shown, receives talker only). Default setting is GPS.

**TVG CORRECTION:** Changes TVG curve to compensate for attenuation absorption of ultrasonic wave in water. OFF (default setting), standard TVG curve; 1/2, 1/2 of the theoretical absorption value added to TVG curve, and 1/1, full theoretical absorption value added to TVG curve.

**UNIT:** Selects unit of depth measurement: meters (default setting), feet, fathoms, passi/braza, Hiro.

**TEMP:** Selects unit of water temperature measurement: °C (default setting), °F.

**TARGET L/L:** Turn on to output event marker position to external equipment. Requires heading and latitude and longitude data from external equipment. Default setting is OFF.

**CUSTOM KEY:** Selects function of custom mode keys: preset (default setting) or short-cut. For details see paragraph 5.2 on page 5.3.

**EMPHASIS MODE:** Turn on to stretch strongest strength echo in range direction. Default setting is OFF.

**ETA MARK:** A vector line extends from the own ship marker in direction of ship's bow on the horizontal mode display. The tip of the line shows the estimated time of arrival after the selected ETA time elapses, using the current ship's speed. ETA is calculated every second considering tilt and detection range. This function requires speed input.

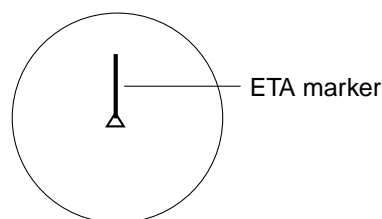

*Figure 5-10 ETA marker*

**SYSTEM SETTING 2 menu description**

** SYSTEM SETTING 2 **		
MENU	1	2
STABILIZER	: OFF	<input type="checkbox"/> ON
AUTO RETRACTION	: <input type="checkbox"/> OFF	(OFF, 5-15kt)
SPEED ALARM/MESSAGE	: <input type="checkbox"/> OFF	ON
SWEEP INDICATOR	: DOT	<input type="checkbox"/> LINE
SOUNDOME SERIAL NO	: <input type="text" value="999"/>	1000-
DEFAULT SETTING	: <input type="checkbox"/> NO	YES
<p>MAXIMUM ALLOWABLE SPEED IS 15 KNOTS WHILE SOUNDOME IS BEING RETRACTED. IF VESSEL HAS RAPID ACCELERATION CAPABILITIES, AUTO RETRACTION SETTINGS OF 10-12 KNOTS ARE MANDATORY TO AVOID CATASTROPHIC DAMAGE TO SOUNDOME ASSY. ANY PHYSICAL DAMAGE TO THE SOUNDOME ASSY. IS CONSIDERED ABUSE AND IS NOT A WARRANTY ISSUE.</p>		
<p>▲▼ : SELECT   ◀▶ : CHANGE   MENU: END</p>		

*Figure 5-11 System setting 2 menu*

**STABILIZER:** Choose ON to compensate for effects of ship’s pitching and rolling. Requires Motion Sensor MS-100 or Clinometer BS-704.

**AUTO RETRACTION:** Turn on to automatically retract the transducer when ship’s speed exceeds the speed set here. The ship’s speed range for automatic retraction is from 5 to 15 knots. The default setting is OFF (no automatic retraction). Requires speed input.

**Note:** The transducer may be retracted at a speed other than the intended one when ship’s speed data is erroneous.

**SPEED ALARM MESSAGE:** Turn on (default setting) to display speed alarm message and sound the audio alarm when ship's speed exceeds allowable speed for a given transducer operation. The audio alarm can be silenced with the [R/B] key.

<b>[↓] pressed to lower transducer</b>	
Speed above 15 kts	Message 1 appears. Reduce speed below 15 kts to restore normal operation.
<b>Transducer being lowered</b>	
Speed over 15 kts	Message 1 appears and lowering continues.
<b>Transducer lowered</b>	
Speed above 20 kts	Message 2 appears accompanied with the aural alarm. Reduce the speed below 20 kts to restore normal operation.
<b>[↑] pressed to raise transducer</b>	
Speed above 15 kts	Message 1 appears accompanied with the aural alarm. Transducer is not raised. Reduce the speed below 15 kts to erase the message and restore normal operation. Then, press [↑] again to raise the transducer.
<b>Transducer being raised</b>	
Speed above 15 kts	Message 1 appears and raising continues. Reduce the speed below 15 kts to erase the message and restore normal operation.

SHIPS SPEED EXCEEDS 15 kt. (SLOW DOWN UNDER 15 kt WHEN MOVING TRANSDUCER UNIT.)  PRESS R/B KEY TO SILENCE ALARM.
---

Message 1

TRANSDUCER REMAINS LOWERED. (REDUCE SHIP'S SPEED AND PRESS ↑ TO RETRACT IT.)  PRESS R/B KEY TO SILENCE ALARM.
--

Message 2

**SWEEP INDICATOR:** Shows train position in the horizontal mode and tilt angle in the vertical fan mode, with a line or a dot. (See the illustration on page 2-2 and 3-2.)

**SOUNDOME SER. NO.:** Set according to serial no. of soundome. Note that the setting is not cleared when default settings are restored.

**DEFAULT SETTING:** Select YES and press the [MENU] key to restore all default system menu settings. Several beeps sound while default settings are being restored and then normal operation is restored.

** FACTORY SETTING **	
ARE YOU SURE? :	<input type="checkbox"/> NO      YES
NOTE: ALL THE SYSTEM SETTING WILL BE CHANGED TO FACTORY SETTING.	
◀▶ : CHANGE      MENU: END	

*Figure 5-12 FACTORY SETTING menu*

## 5.4.2 Sonar (horizontal) mode range settings

The user may preset horizontal mode ranges as desired.

1. Select RANGE-SONAR MODE at the SYS menu and then press ►.

** RANGE-SONAR MODE **		
1	:	<input type="text" value="10"/> (10-1600m)
2	:	<input type="text" value="20"/>
3	:	<input type="text" value="40"/>
4	:	<input type="text" value="60"/>
5	:	<input type="text" value="80"/>
6	:	<input type="text" value="120"/>
7	:	<input type="text" value="160"/>
8	:	<input type="text" value="200"/>
9	:	<input type="text" value="250"/>
10	:	<input type="text" value="300"/>
11	:	<input type="text" value="400"/>
12	:	<input type="text" value="500"/>
13	:	<input type="text" value="600"/>
14	:	<input type="text" value="800"/>
15	:	<input type="text" value="1000"/>
TRACK DISP	:	<input type="text" value="500"/> (500-5000m)
DEFAULT SETTING :		<input type="text" value="NO"/> YES
▲ ▼ : SELECT   ◀ ▶ : CHANGE   MENU: END		

Figure 5-13 Range-sonar mode menu

2. Press ▲ or ▼ to select range number desired.
3. Press ◀ or ▶ to set range. The setting range depends on the transducer used. The figure above shows the default settings for the 60 kHz transducer.
4. To set the range of the video plotter display, press ▼ to select TRACK DISP and set range with ◀ or ▶.
5. To restore default horizontal mode range settings, select DEFAULT SETTING, press ► to select YES and press the [MENU] key.
6. Press the [MENU] key to register settings and close the menu.

### 5.4.3 Vertical fan mode range settings

As with the horizontal mode, the user may preset the vertical fan mode's ranges.

1. Select RANGE-VER MODE at the SYS menu and then press ►.

** RANGE-VER MODE **		
1	:	<input type="text" value="10"/> (10-600m)
2	:	<input type="text" value="20"/>
3	:	<input type="text" value="30"/>
4	:	<input type="text" value="40"/>
5	:	<input type="text" value="60"/>
6	:	<input type="text" value="80"/>
7	:	<input type="text" value="100"/>
8	:	<input type="text" value="120"/>
9	:	<input type="text" value="160"/>
10	:	<input type="text" value="200"/>
11	:	<input type="text" value="250"/>
12	:	<input type="text" value="300"/>
13	:	<input type="text" value="400"/>
14	:	<input type="text" value="500"/>
15	:	<input type="text" value="600"/>
DEFAULT SETTING :		<input type="text" value="NO"/> YES
▲ ▼ : SELECT   ◀ ▶ : CHANGE   MENU: END		

Figure 5-14 Range-ver mode menu

2. Press ▲ or ▼ to select range number desired.
3. Press ◀ or ▶ to set range.
4. To restore default vertical fan mode range settings, select DEFAULT SETTING, press ► to select YES and press the [MENU] key.
5. Press the [MENU] key to register settings and close the menu.



## 5.4.4 Echo sounder mode range settings

As with the horizontal and vertical fan modes, the user may preset the echo sounder mode's ranges.

1. Select RANGE-E/S MODE at the SYS menu and then press ►.

** RANGE-E/S MODE **		
1	:	<input type="text" value="10"/> (10-600m)
2	:	<input type="text" value="20"/>
3	:	<input type="text" value="30"/>
4	:	<input type="text" value="40"/>
5	:	<input type="text" value="60"/>
6	:	<input type="text" value="80"/>
7	:	<input type="text" value="100"/>
8	:	<input type="text" value="120"/>
9	:	<input type="text" value="160"/>
10	:	<input type="text" value="200"/>
11	:	<input type="text" value="250"/>
12	:	<input type="text" value="300"/>
13	:	<input type="text" value="400"/>
14	:	<input type="text" value="500"/>
15	:	<input type="text" value="600"/>
DEFAULT SETTING :		<input type="text" value="NO"/> YES
▲ ▼ : SELECT   ◀ ▶ : CHANGE   MENU: END		

Figure 5-15 Range-E/S mode menu

2. Press ▲ or ▼ to select range number desired.
3. Press ◀ or ▶ to set range. The setting range depends on the transducer used.
4. To restore default echo sounder mode range settings, select DEFAULT SETTING, press ► to select YES and press the [MENU] key.
5. Press the [MENU] key to register settings and close the menu.

## 5.4.5 Track range settings

You may choose the video plotter display scale range as follows.

1. Choose RANGE-TRACK at the SYS menu and then press ►.

** RANGE-TRACK MODE **		
1	:	<input type="text" value="500"/> (100-10000m)
2	:	<input type="text" value="1000"/>
3	:	<input type="text" value="2000"/>
4	:	<input type="text" value="4000"/>
5	:	<input type="text" value="8000"/>
DEFAULT SETTING :		<input type="text" value="NO"/> YES
▲ ▼ : SELECT   ◀ ▶ : CHANGE   MENU: END		

*Figure 5-16 Range-track mode menu*

2. Press ▲ or ▼ to choose range number desired.
3. Press ◀ or ▶ to set.
4. Press the [MENU] key to register settings and close the menu.

## 5.4.6 Color palette

The color palette lets the user change the color of echoes, background, text and menu as desired.

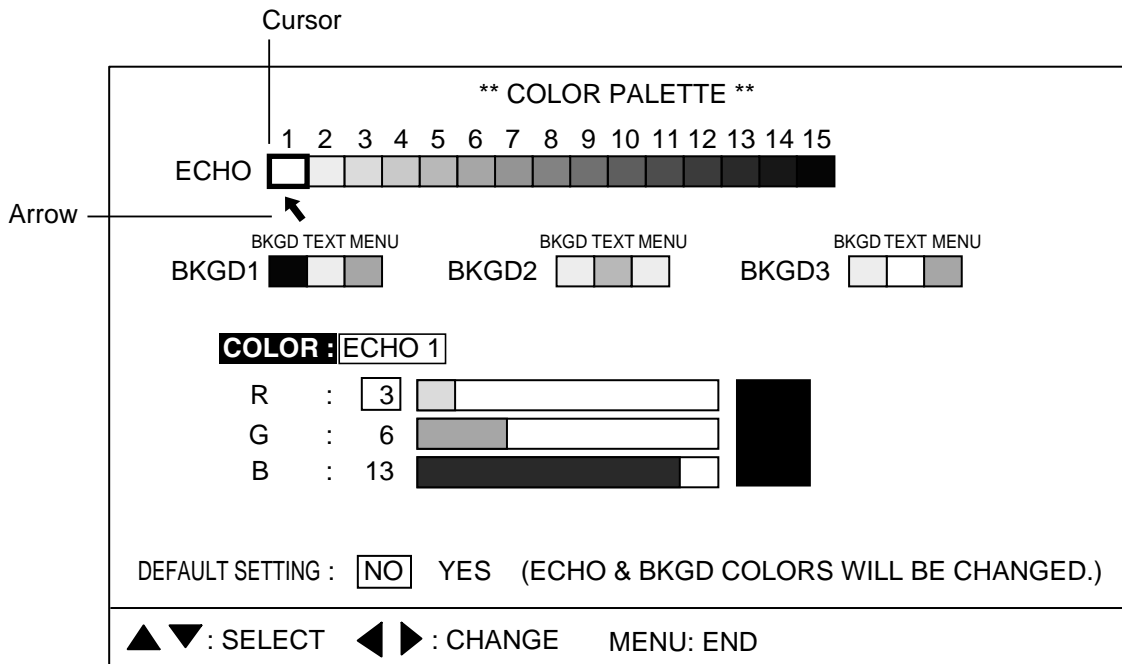

Figure 5-17 Color palette

1. Press ◀ or ▶ to place the cursor and arrow on the item to change. Pressing ▶ shifts the arrow and cursor from left to right and top to bottom.
2. Press ▲ or ▼ to select R(red), G(green) or B(blue) as appropriate.
3. Press ◀ or ▶ to adjust color.
4. Press the [MENU] key to register your settings and close the menu.

**Note:** To restore default color settings, select DEFAULT SETTING, press ▶ to select YES, and press the [MENU] key. A few beeps sound while the default colors are being restored and then normal operation is restored.

## 5.4.7 Language

Menu language can be selected from among the languages shown in the Language menu and the default language is English.

** LANGUAGE **				
<b>LANGUAGE:</b>	JAPANESE	<input type="text" value="ENGLISH"/>	FRANCAIS	ESPAÑOL
	ITALIANO	PORTUGUES	DANSK	NORSK
	SVENSK	THAI		
◀▶ : CHANGE    MENU: END				

Figure 5-18 Language menu

## 5.4.8 System backup

User settings can be backed up with the menu item SYSTEM BACKUP.

** SYSTEM BACKUP **	
<b>ARE YOU SURE?</b>	: <input type="text" value="NO"/> YES
NOTE: OVERWRITE PREVIOUS BACKUP DATA.	
◀▶ : CHANGE    MENU: END	

Figure 5-19 System backup menu

## 5.4.9 Loading backup data

System data may be loaded from the LOAD BACKUP DATA menu.

** LOAD BACKUP DATA **	
<b>ARE YOU SURE?</b>	: <input type="text" value="NO"/> YES
NOTE: OVERWRITE CURRENT SETTINGS.	
◀▶ : CHANGE    MENU: END	

Figure 5-20 Load backup data menu

## 5.4.10 Transducer frequency adjustment

If the CH-250 is receiving interference from a video sounder or other sonar on board your ship, adjust the frequency of the CH-250's transducer to reduce the interference.

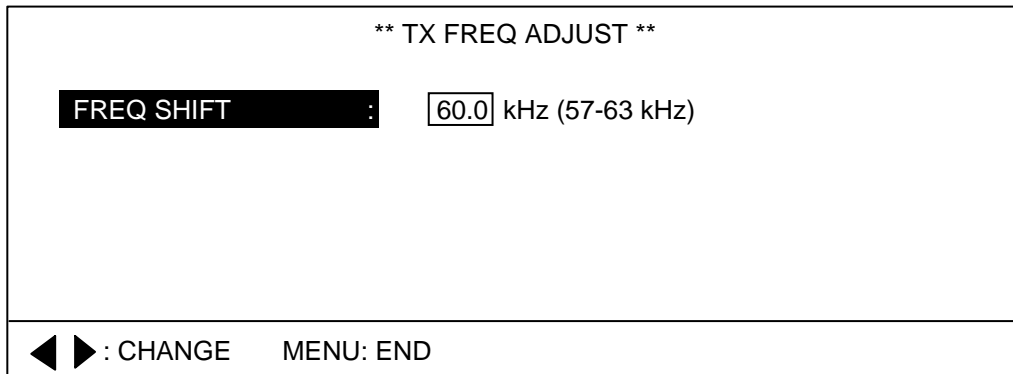

Figure 5-21 TX frequency adjustment menu

## 5.4.11 Demonstration mode

The demonstration mode provides a simulated sonar picture which helps you become acquainted with how your sonar works. Connection of the transducer is not required. All controls are operational.

1. Display the SYS menu.
2. Select DEMO MODE.
3. Press ► to open the menu.

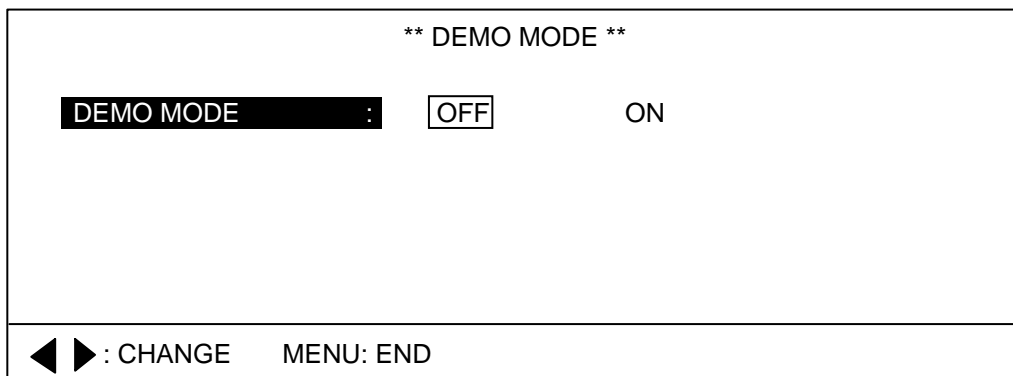

Figure 5-22 Demo mode menu

4. Select OFF or ON as appropriate and press the [MENU] key. (DEMO) appears at the top of the screen when the demonstration mode is active.

## 5.4.12 Restoring all default settings

The item DEFAULT lets you restore all default menu settings. Select YES and press the [MENU] key to restore all default settings. Note that settings stored in SYSTEM BACKUP are not disturbed.

** DEFAULT **	
ARE YOU SURE? :	<input type="checkbox"/> NO      YES
NOTE: RESET ALL THE SETTINGS INCLUDED IN SYSTEM MENU TO DEFAULT.	
◀▶ : CHANGE      MENU: END	

*Figure 5-23 Default menu*

 <b>CAUTION</b>
All default settings will be restored. If necessary jot down settings which must be restored.

# 6. MAINTENANCE, TROUBLESHOOTING

---

This chapter provides information necessary for keeping the equipment in good working order.

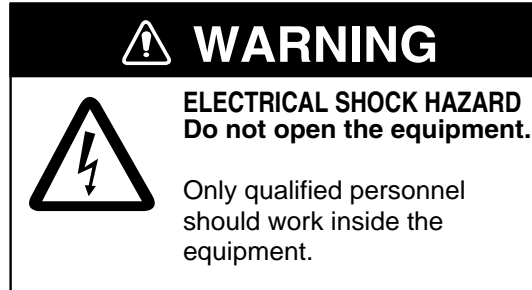

## 6.1 Preventive Maintenance

Check the following points monthly.

- Check all cables. If damaged, replace.
- Check connectors at rear of each unit. Clean if necessary.
- Check earth of each unit. Clean if necessary.
- Check voltage of ship's mains to be sure it is within the equipment's power rating.

## 6.2 Cleaning the Equipment

Dust or dirt can be removed from the equipment with a soft, dry cloth. Do not use chemical cleaners to clean the equipment – they can remove paint and markings. Wipe the LCD carefully to prevent scratching, using tissue paper and an LCD cleaner. To remove stubborn dirt, use an LCD cleaner, wiping slowly with tissue paper so as to dissolve the dirt. Change paper frequently so the dirt will not scratch the LCD.

## 6.3 Hull Unit Maintenance

### 6.3.1 Lubrication

Grease the raise/lower screw shaft once a year. Also, grease the raise/lower main shaft (upper part of the grease cotton retainer) twice a year. These parts can be accessed by removing the raise/lower drive assembly cover.

### 6.3.2 Manually raising, lowering transducer

**⚠ WARNING**

**Turn off the power at the ship's mains switchboard before conducting the procedure below.**

Rotating motor can cause bodily injury.

1. Turn off the breaker on the hull unit.
2. Set 19 mm ratchet wrench to nut and turn.
3. Check that the transducer raises and lowers smoothly, from the upper to the lower limit positions. If the transducer cannot be raised smoothly, do not use excessive force; the shaft may bend, causing damage to other components.
4. Check soundome and tank. Remove marine life with fine sandpaper or piece of wood.

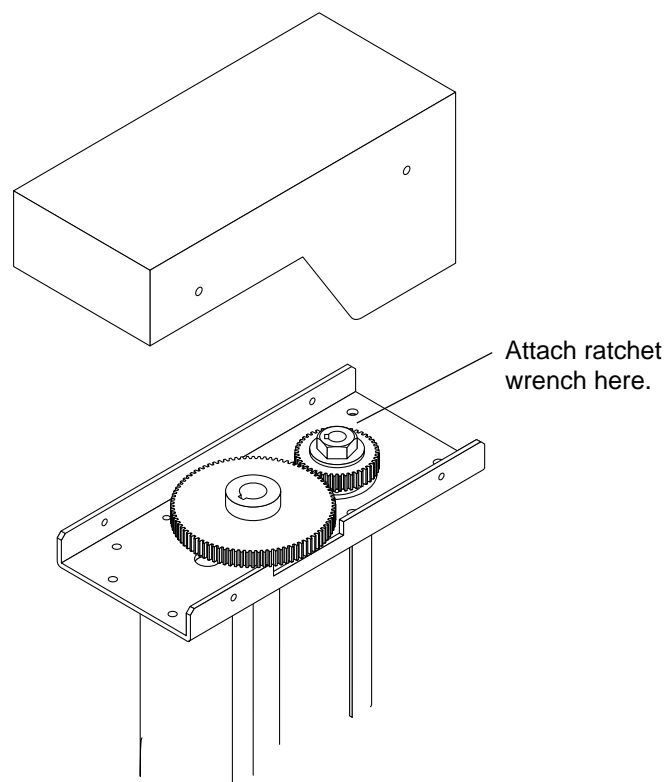



Figure 6-1 Hull unit



## 6.4 Transducer Maintenance

When the ship is dry-docked remove marine growth from the transducer with fine sandpaper or a piece of wood.

 <b>CAUTION</b>
<b>Do not paint the transducer face.</b> Loss of sensitivity will result.
<b>Do not use plastic solvents to clean the transducer.</b> They can damage the transducer.

## 6.5 Fuse Replacement

The fuse in the hull and transceiver units protect them from overvoltage, equipment fault and reverse polarity of the ship's mains. If the power cannot be applied first check the power cable between the transceiver unit and the display unit. If the power still cannot be applied, the fuse in the transceiver unit may have blown. Have a suitably qualified technician check the fuse.

 <b>CAUTION</b>
<b>Use the proper fuse.</b> Use of a wrong fuse can cause fire or equipment damage.

## 6.6 Troubleshooting

The table below provides common symptoms of equipment troubles and the means to rectify them.

Symptom	Check, Remedy
Cannot turn on the power.	<ul style="list-style-type: none"> <li>• Check cable between transceiver unit and display unit.</li> <li>• Check ship's mains.</li> <li>• Have a suitably qualified technician check the fuse in the transceiver unit.</li> </ul>
Bottom echo becomes irregular.	<ul style="list-style-type: none"> <li>• Rough seas. Distance to the bottom changes due to rolling and pitching.</li> <li>• Long range selected. Transmission period is longer so ship's pitching and rolling are apt to affect detection of echo.</li> </ul>
Weak echo	<ul style="list-style-type: none"> <li>• Output power set to minimum. Set to maximum, on the COM1 menu.</li> <li>• Excessive TVG. Readjust TVG on the appropriate menu (HORZ, VERT, ES). Note that readjustment of TVG is necessary when gain is adjusted.</li> </ul>
Somewhat strange color	<ul style="list-style-type: none"> <li>• [BRILL] key setting too low. Increase brightness with [BRILL] key.</li> </ul>
Picture contains noise.	<ul style="list-style-type: none"> <li>• Equipment not grounded properly. Check equipment ground.</li> <li>• Power cable is too close to the signal cable. Relocate power cable or signal cable.</li> <li>• Debris may be on sea surface. Reject unwanted noise with the interference rejector on the COM1 menu.</li> </ul>
Picture does not change when tilt angle is changed. (Bottom is not displayed in vertical fan picture when bottom is flat.)	<ul style="list-style-type: none"> <li>• Problem in tilt mechanism or control line. Contact a FURUNO agent or dealer for advice.</li> </ul>

## 6.7 Error Messages

The table below shows the error messages which may appear on the display. All error messages are accompanied by an audio alarm, which you may silence with the [R/B] key.

Message	Meaning, Remedy
<b>Hull Unit</b>	
HULL UNIT POWER OFF (CHECK BREAKER AND FUSE.) PRESS R/B KEY TO SILENCE ALARM.	Hull unit is not powered. Silence the audio alarm with the [R/B] key, and then turn on the hull unit to erase the message and restore normal operation.
RAISE/LOWER FUNCTION HAS NOT BEEN COMPLETED. CHECK IF THE BREAKER AT THE HULL UNIT HAS BEEN ACTIVATED. MAXIMUM ALLOWABLE SPEED IS 15 KNOTS WHILE SOUNDOME IS BEING RETRACTED. PRESS R/B KEY TO SILENCE ALARM.	You attempted to raise or lower the transducer when the ship's speed is above 15 knots or the breaker on the hull unit tripped. Check the breaker and lower the ship's speed below 15 knots to execute function desired.
<b>Frequency Code Error</b>	
FREQUENCY CODE ERROR (CHECK TRANSCIVER UNIT.) PRESS R/B KEY TO SILENCE ALARM.	CPU does not receive frequency flag from transducer. Silence the audio alarm with the [R/B] key, and then check the transceiver unit.
<b>Train Error</b>	
TRAIN NG	CPU does not receive heading signal. Check source of heading signal.
<b>Excessive Speed</b>	
SHIPS SPEED EXCEEDS 15 kt. (SLOW DOWN UNDER 15 kt WHEN MOVING TRANSDUCER.) PRESS R/B KEY TO SILENCE ALARM.	See page 5-11 for details.
TRANSDUCER REMAINS LOWERED. (REDUCE SHIP'S SPEED AND PRESS ↑ TO RETRACT IT.) PRESS R/B KEY TO SILENCE ALARM.	

## 6.8 Diagnostics

1. Press the [MENU] key to open the menu.
2. Press ▲ to select MENU, and then press ► to select SYS.
3. Press ▼ to select GO TO SYS MENU.
4. Press ◀ to select YES.
5. Select TEST and press ► to start the test. The lamps above the XDR switches light alternately for one second while the test is being conducted. In a few moments the results of the test appear.

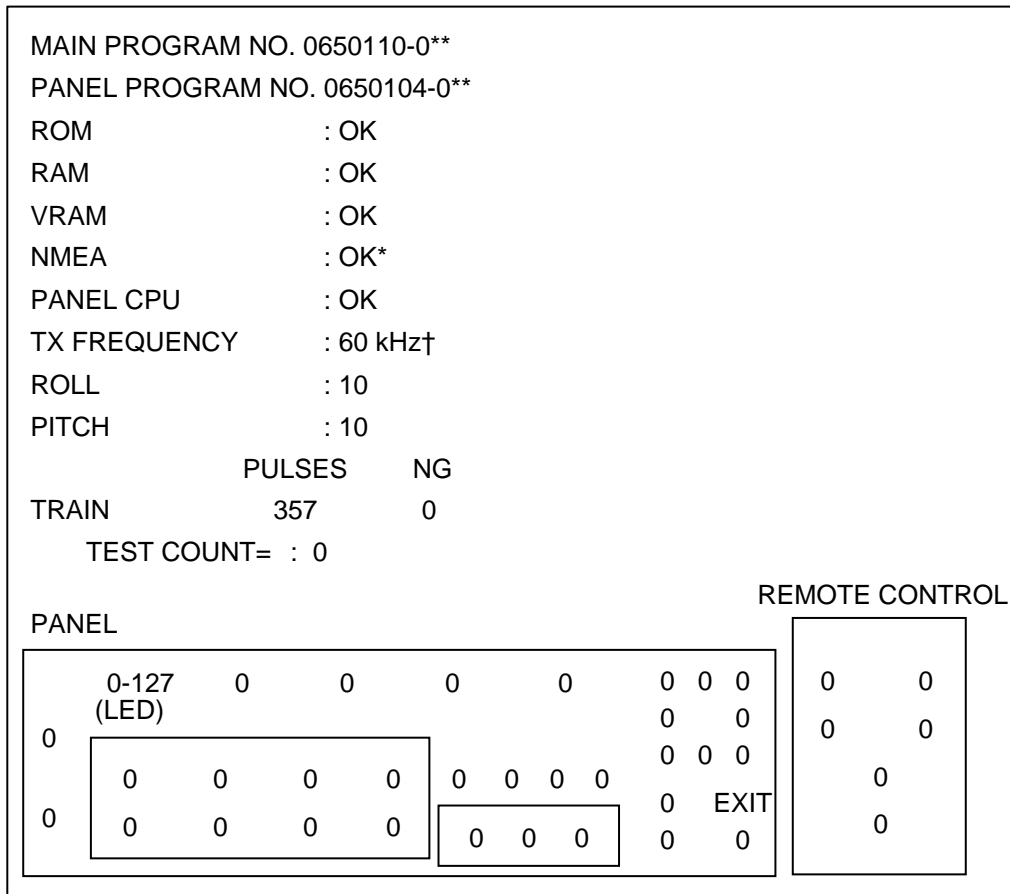

\* = Requires special plug to test. Nothing displayed when plug is not connected.

\*\* = Program Version No.

† = Frequency depends on transducer used.

Figure 6-2 Test results

### Interpreting the test results display

- The program numbers of the MAIN and PANEL programs appear at the top of the display.
- The ROM, RAM, VRM, NMEA and PANEL CPU are checked for proper operation and the results displayed as OK or NG (No Good). For NG contact a FURUNO agent or dealer for advice.
- The TX FREQUENCY of the transducer is measured and displayed.

- TRAIN shows a figure between 355-359 if normal. NG appears in case of train error.
- TEST COUNT shows the number of times the test has been consecutively executed.
- At the bottom of the screen there are two major groups of zeroes (0), and they represent the keys and controls on the control panel and remote controller. Press a key and its on-screen location shows "1" while the key is pressed and "0" when it is released. Operate a control and its on-screen location changes as below. When the [GAIN] control is operated the panel dimmer increases or decreases with adjustment of the control.

GAIN control: Shows 0-127.

Other controls: Shows 0-19.

To quit the test, press the [MENU] key three times.

## 6.9 Test Pattern

A test pattern can be displayed to check for proper display of colors.

1. Press the [MENU] key to open the menu.
2. Press ▲ to select MENU, and then press ► to select SYS.
3. Press ▼ to select GO TO SYS MENU.
4. Press ◀ to select YES.
5. Select TEST PATTERN and press ► to display the test pattern. Press ► again to change the test pattern. The pattern changes in the sequence shown below with each press of ►.

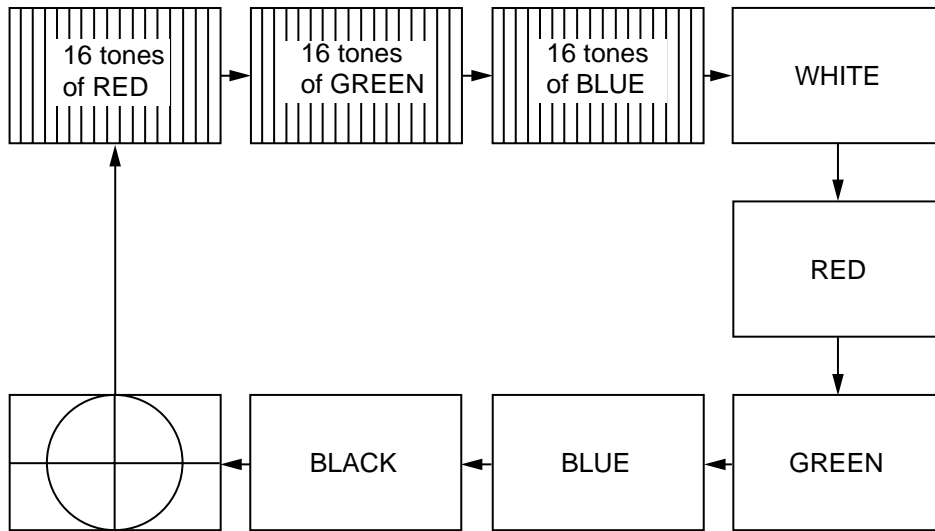
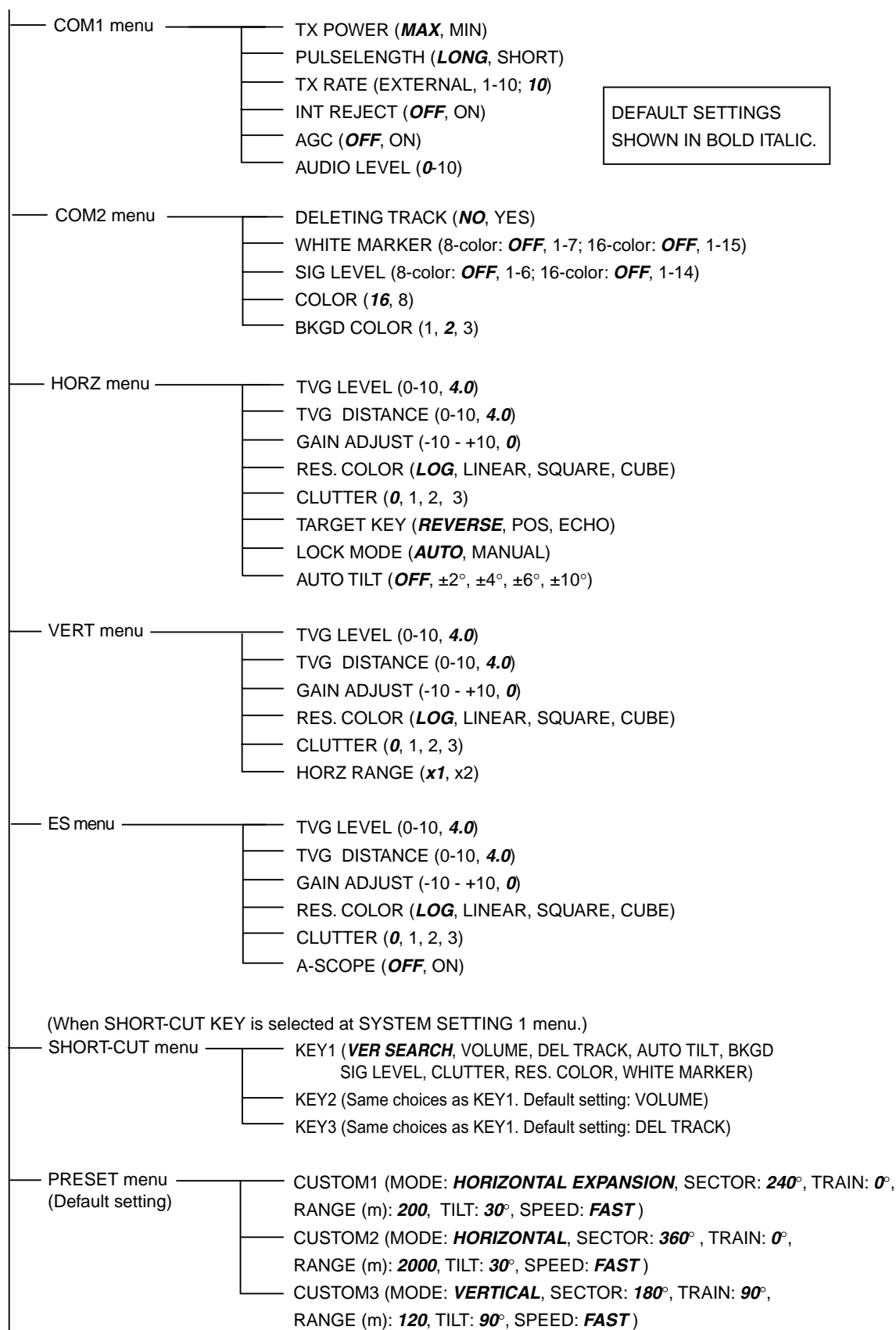

Figure 6-3 Test pattern

To quit the test pattern, press the [MENU] key three times.

# MENU TREE

[MENU] key



DEFAULT SETTINGS  
SHOWN IN BOLD ITALIC.

(CONTINUED ON NEXT PAGE)

(CONTINUED FROM PREVIOUS PAGE)

- SYSTEM menu
  - SYSTEM SETTING
    - SYSTEM SETTING 1
      - POSITION (**SHIP'S L/L**, SHIP'S LOP, CURSOR L/L)
      - TRACK (OFF, **ON**)
      - CURRENT DATA (**OFF**, FLOW FROM, FLOW TO)
      - HEADING INDICATION (**TRUE**, AZ)
      - NORTH MARK (**OFF**, ON)
      - CSE DATA (**NAV**, GYRO)
      - NAV DATA (**GPS**, LoranC, LoranA, DR, DECCA, OTHERS)
      - TVG CORRECTION (**OFF**, 1/2, 1/1)
      - UNIT (**m**, ft, fa, HIRO, P/B)
      - TEMP (**°C**, °F)
      - TARGET L/L (**OFF**, ON)
      - CUSTOM KEY (**PRESET KEY**, SHORT-CUT KEY)
      - EMPHASIS MODE (OFF, **NORMAL**, RED)
      - ETA MARK (**OFF**, 10sec, 30sec, 1min, 3min, 6min)
    - SYSTEM SETTING 2
      - STABILIZER (OFF, **ON**)
      - AUTO RETRACTION (**OFF**, 5-15kt)
      - SPEED ALARM/MESSAGE (OFF, 15kt, **20kt**)
      - SWEEP INDICATOR (DOT, **LINE**)
      - SOUNDOME SERIAL NO. (**-999**, 1000-)
      - DEFAULT SETTING (**NO**, YES)
  - RANGE-SONAR MODE (all default ranges)
    - 60 kHz (min. range: m, 10: ft, 40; fa, p/b, hiro, 5. max. range: m, 1600; ft, 5000, fa, 800; P/B, Hiro, 1000)
    - 88 KHz (min. range: m, 10: ft, 40 ; fa, P/B, Hiro, 5; max. range: m, 1200; ft, 4000; fa, 700; P/B, Hiro, 800)
    - 150 KHz (min. range: m, 10: ft, 40 ; fa, P/B, Hiro, 5; max. range: m, 1000; ft, 3500; fa, 700; P/B, Hiro, 700)
    - 180 KHz (min. range: m, 10: ft, 40 ; fa, P/B, Hiro, 5; max. range: m, 800; ft, 2500; fa, 500; P/B, 600, Hiro, 700)
    - 240 KHz (min. range: m, 10: ft, 30 ; fa, P/B, Hiro, 5; max. range: m, 600; ft, 2000; fa, P/B, Hiro, 400)
  - RANGE-VER MODE (all default ranges)
    - m: 10, 20, 30, 40, 60, 80, 100, 120, 160, 200, 250, 300, 400, 500, 600
    - ft: 30, 60, 90, 120, 150, 200, 250, 300, 400, 500, 600, 800, 1000, 1500, 2000
    - fa, P/B, Hiro: 10, 20, 30, 40, 50, 60, 80, 100, 120, 140, 160, 200, 250, 300, 400
  - RANGE-E/S MODE (all default ranges)
    - m: 10, 20, 30, 40, 60, 80, 100, 120, 160, 200, 250, 300, 400, 500, 600
    - ft: 30, 60, 90, 120, 150, 200, 250, 300, 400, 500, 600, 800, 1000, 1500, 2000
    - fa, P/B, Hiro: 10, 20, 30, 40, 50, 60, 80, 100, 120, 140, 160, 200, 250, 300, 400
  - RANGE-TRACK MODE (all default ranges)
    - m: 500, 1000, 2000, 4000, 8000
    - ft: 1000, 2000, 5000, 10,000, 20,000
    - fa, P/B, Hiro: 200, 500, 1000, 2000, 4000
  - COLOR PALETTE (Adjusts color of echoes, text and background.)
  - LANGUAGE (JAPANESE, **ENGLISH**, FRANCAIS, ESPANOL, ITALIANO, PORTUGUES, DANSK, NORSK, SVENSK, THAI)
  - SYSTEM BACKUP (**NO**, YES)
  - LOAD BACKUP DATA (**NO**, YES)
  - HEADING OFFSET. DRAFT OFFSET (-180°, +180°, **0**; 0 - 60 (m), **0**)
  - ADJ MOTION SENSOR (ROLL ANGLE: -10° - +10°, **0**; PITCH ANGLE: -10° - +10°, **0**)
  - TX FREQ ADJUST (171 - 189 kHz, **180 kHz**)
  - TEST (Checks equipment for proper operation.)
  - TEST PATTERN (Displays series of test patterns.)
  - DEMO MODE (**OFF**, ON)
  - DEFAULT (**NO**, YES)



# SPECIFICATIONS OF 10.4 INCH COLOR LCD SEARCHLIGHT SONAR CH-250

## 1 GENERAL

- 1.1 Display System                      10.4 inch Color LCD
- 1.2 Transmit Frequency                60, 88 or 150 kHz selected
- 1.3 Output Power                        0.8 kW (60 kHz) to 1.2 kW (150 kHz)
- 1.4 Range (factory setting)

Range	Detection Range (m) [H: horizontal mode, V: vertical fan mode]					
	60 kHz		88 kHz		150 kHz	
	H	V	H	V	H	V
1	10	10	10	10	10	10
2	20	20	20	20	20	20
3	40	30	40	30	40	30
4	80	40	80	40	60	40
5	120	60	120	60	80	60
6	160	80	160	80	120	80
7	200	100	200	100	160	100
8	250	120	250	120	200	120
9	300	160	300	160	250	160
10	400	200	400	200	300	200
11	500	250	500	250	400	250
12	600	300	600	300	500	300
13	800	400	800	400	600	400
14	1200	500	1000	500	800	500
15	1600	600	1200	600	1000	600

## 2 DISPLAY/ CONTROL UNIT

- 2.1 Display                                10.4 inch color LCD, 640 x 480 dots
- 2.2 Picture Color                        Echo: 16 or 8 colors (echo)  
Back-ground: 3 colors selected (user setting available)
- 2.3 Display Mode                        Horizontal (Normal/Expanded), Vertical fan  
(Left-right or top-bottom position), Echo sounder
- 2.4 Combination Display                Plotter, Vertical fan, Strata, History
- 2.5 Alphanumerical Indication        Range, Sensitivity, TVG, Tilt angle, Interference rejection
- 2.6 Data Indication                     L/L (Own ship or cursor), Depth, Bearing,  
Ship's speed/Water current vector, Track,  
Water temperature (External IEC-61162 data required)

- 2.7 Marker Range and Bearing to Waypoint
- 2.8 Indication Unit Meter, feet, fathom, P/B
- 2.9 Audio Monitor 2 W output (4 ohms), Freq. 1.0 kHz (external speaker required)
- 2.10 Event Mark 5 points
- 2.11 Hue Low level enhanced echo disappeared
- 2.12 Red Color Enhancement Strong echo indicated as expanded to range direction
- 2.13 Arrival Mark Vector estimated point after 10 seconds to 6 min. (menu setting)
- 2.14 Target Lock (three function selected on menu)
  - Scanning Reverse Scanning orientation changed by pressing key
  - Location Search Auto-search for marker setting location
  - Echo Search Auto-search for signal level in a search zone, or manual search
- 2.15 Clatter Suppresses low intensity echoes.

### 3 TRANSCEIVER UNIT

- 3.1 Frequency 60/ 88/ 150 kHz, Auto-setting according to Hull Unit Specs.
- 3.2 Output Power 0.8-1.2 kW (due to frequency), power reduction function available
- 3.3 Output Pulse Length 0.2 to 20.0 ms, according to range
- 3.4 TVG Level: 100 dB max. , Distance: 1000 m

### 4 HULL UNIT

- 4.1 Transducer Travel 400 mm or 250 mm
- 4.2 Raise/lower Time 30 s at 400 mm travel
- 4.3 Ship's Bow Setting Setting offset on menu at installation within  $\pm 30^\circ$
- 4.4 Horizontal Mode Control
  - Scanning Angle  $6^\circ$  to  $360^\circ$ ,  $24^\circ$  step
  - Scanning Center  $6^\circ$  steps,  $360^\circ$  setting available
  - Scanning Step Angle Normal:  $6^\circ$ , High speed:  $12^\circ$
  - Elevation Angle  $+5^\circ$  to  $90^\circ$ ,  $1^\circ$  step
  - Auto Tilt setting  $\pm 2^\circ$  to  $\pm 10^\circ$

#### 4.5 Time to Train Full Circle

60 kHz:

Range (m)	10	20	40	80	120	160	200	250	300	400	500	600	800	1200	1600	
Time (sec)	Norm	9	9	9	9	10	13	16	20	24	32	40	48	64	97	128
	Fast	9	9	9	9	10	12	14	16	18	22	26	30	37	54	70

150 kHz:

Range (m)	10	20	40	60	80	120	160	200	250	300	400	500	600	800	1000	
Time (sec)	Norm	7	7	7	7	7	10	13	16	20	24	32	40	48	64	81
	Fast	7	7	7	7	7	9	11	13	15	17	21	25	28	36	45

4.6	Vertical Fan Mode Control			
	Scanning Angle	6° to 180°, 12° step		
	Scanning Center	0° to 180°, 6° step		
	Scanning Step Angle	Normal: 3°, High speed: 6°		
	Time to Train	360°, 6° step		
4.7	Transceiver Beam Width	Frequency	Vertical	Horizontal
	(-3 dB)	60 kHz:	12°	15°
		88 kHz:	9.5°	11.5°
		150 kHz:	6.5°	6.5°
4.8	Allowable Ship's Speed	20 knot or less (15 knot during raise/lower operation)		
4.9	Stabilizer	Within 30°, optional motion sensor or clinometers required		

## 5 I/O INTERFACE

5.1	Data format	IEC61162-1 (NMEA0183 Ver 1.5/2.0)
5.2	Input	DBS, DBT, DPT, GGA, GLL, HDG, HDM, HDT, MDA, MTW, RMA, RMC, VDR, VHW, VTG
5.3	Output	SSTLL

## 6 POWER SUPPLY

6.1	Display Unit/ Control Unit/ Transceiver Unit	12-32 VDC: 4.7-1.8 A, within 58 VA
6.2	Hull Unit	12/24-32 VDC: 4.7/2.3-1.8 A, within 58 VA Max. 16.7/8.2-7.7 A, within 200-246 VA
6.3	Rectifier (option)	110/220 VAC, 13 A, 1 phase, 50/60 Hz

## 7 ENVIRONMENTAL CONDITION

7.1	Ambient Temperature	-15°C to +55°C (Soundome: 0°C to +35°C)
7.2	Relative Humidity	95%
7.3	Water proofing	Display/ Control unit: IPX5
	(IEC 60529)	Transceiver unit/ Hull unit: IPX2

## 8 COATING COLOR

8.1	Display Unit/ Control Unit	Panel: N3.0, Chassis: 2.5GY5/1.5
8.2	Transceiver Unit	N3.0

This page is intentionally left blank.

# INDEX

---

## A

- AGC ..... 5-2
- A-scope display ..... 4-9
- Automatic tilt ..... 2-18

## B

- Background color ..... 5-2
- Backup data
  - loading ..... 5-20
  - saving ..... 5-20
- BRILL control ..... 1-5

## C

- Clutter
  - echosounder mode ..... 4-11
  - horizontal mode ..... 2-18
  - vertical fan mode ..... 3-13
- Color palette ..... 5-19
- Colors
  - background ..... 5-3
  - display ..... 5-3
- COM1 menu ..... 5-1
- COM21 menu ..... 5-3
- Control description ..... 1-1
- Course data ..... 5-11
- Current (tide) data ..... 5-10
- Cursor data
  - echo sounder mode ..... 4-5
  - horizontal mode ..... 2-5
  - vertical fan mode ..... 3-7
- Custom key ..... 5-11
- CUSTOM MODE keys
  - preset function ..... 5-6
  - selection of function ..... 5-4
  - short-cut function ..... 5-7

## D

- Default settings ..... 5-22
- Demonstration mode ..... 5-21
- Depth marker (horizontal mode) ..... 2-7
- Depth marker (vertical fan mode) ..... 3-9
- Diagnostics ..... 6-6
- Display modes ..... 1-6

## E

- Emphasis mode ..... 5-11
- Error messages ..... 6-5
- ES menu ..... 4-10
- ETA marker ..... 5-11

## EVENT key

- echo sounder mode ..... 4-5
- horizontal mode ..... 2-6
- vertical fan mode ..... 3-8

## Event marker

- deleting from echo sounder mode ..... 4-6
- deleting from horizontal mode ..... 2-7
- deleting from vertical fan mode ..... 3-9
- inscribing from echo sounder mode ..... 4-6
- inscribing from horizontal mode ..... 2-6
- inscribing from vertical fan mode ..... 3-8
- output on/off ..... 5-11

## F

### FAST SCAN key

- echo sounder mode ..... 4-4
- horizontal mode ..... 2-5
- vertical fan mode ..... 3-7

### FULL/HALF key

- horizontal mode ..... 2-4
- vertical fan mode ..... 3-5

### Fuse replacement ..... 6-3

## G

### Gain adjustment

- echo sounder mode ..... 4-10
- horizontal mode ..... 2-17
- vertical fan mode ..... 3-12

### GAIN control ..... 1-7

## H

- Heading indication ..... 5-11
- Horizontal range (vertical fan mode) ..... 3-13
- Horizontal range marker
  - (vertical fan mode) ..... 3-9
- Horizontal/history display ..... 2-25
- HORZ menu ..... 2-17
- Hull unit maintenance ..... 6-2

## I

### Interference rejector ..... 3-11

## L

### Language ..... 5-20

## M

### MAIN/SUB key ..... 2-25, 3-16

### Maintenance

- hull unit ..... 6-2
- preventive ..... 6-1

replacement of fuse.....	6-3
transducer.....	6-3
MENU key.....	1-7
Menu tree.....	M-1
<b>N</b>	
Navigation data.....	5-11
North marker.....	5-11
<b>P</b>	
Position display format.....	5-10
POWER switch.....	1-3
PRESET menu.....	5-6
Pulselength.....	2-9
<b>R</b>	
R/B key	
echo sounder mode.....	4-7
horizontal mode.....	2-7
vertical fan mode.....	3-9
Range	
echo sounder mode.....	4-3
horizontal mode.....	2-3
presetting for echo sounder mode.....	5-17
presetting for horizontal mode.....	5-15
presetting for vertical fan mode.....	5-16
track range preset.....	5-18
vertical fan mode.....	3-3
RANGE control	
echo sounder mode.....	4-3
horizontal mode.....	2-3
vertical fan mode.....	3-3
Range marker	
echo sounder mode.....	4-7
Remote controller.....	1-2
Resolution color	
echosounder mode.....	4-11
horizontal mode.....	2-18
vertical fan mode.....	3-12
<b>S</b>	
SECTOR control	
horizontal mode.....	2-4
vertical fan mode.....	3-5
SHORT-CUT menu.....	5-7
Signal level.....	5-3
Signal level.....	2-11
Speed alarm.....	5-13

Stabilizer.....	5-12
Sweep indicator.....	5-13
SYS menu.....	5-9
System configuration.....	vii
SYSTEM SETTING 1 menu.....	5-10
SYSTEM SETTING 2 menu.....	5-12
<b>T</b>	
Target lock	
echo mode.....	2-15
manual position mode.....	2-14
manual reverse mode.....	2-13
selection of mode.....	2-13
Test pattern.....	6-8
TILT control	
echo sounder mode.....	4-4
horizontal mode.....	2-5
vertical fan mode.....	3-6
Track	
deleting.....	5-3
on/off.....	5-10
range preset.....	5-18
TRAIN control	
echo sounder mode.....	4-4
horizontal mode.....	2-5
vertical fan mode.....	3-4
Transducer	
automatic retraction.....	5-12
maintenance.....	6-3
Transducer (XDR) switches.....	1-3
Transmitter output power.....	2-8
Troubleshooting.....	6-4
TVG	
echo sounder mode.....	4-7
horizontal mode.....	2-9
vertical fan mode.....	3-10
TVG curve.....	5-11
<b>U</b>	
Unit of measurement	
depth.....	5-11
water temperature.....	5-11
<b>V</b>	
VERT menu.....	3-12
<b>W</b>	
White marker.....	5-3