

EN

User manual

Condenser dryer

USER MANUAL

ZDC 37201W

ZANUSSI

Contents

Important safety information _____	2	Sorting and preparing laundry _____	8
Environment _____	4	Daily use _____	9
Installation _____	4	Cleaning and maintenance _____	10
Product description _____	7	What to do if ... _____	11
Control panel _____	7	Technical data _____	12
Before first use _____	7	Machine settings _____	13
Programme chart _____	7		

Subject to change without notice.

Important safety information

Important! In the interest of your safety and to ensure the correct use, before installing and first using the appliance, read this user manual carefully, including its hints and warnings. To avoid unnecessary mistakes and accidents, it is important to ensure that all people using the appliance are thoroughly familiar with its operation and safety features. Save these instructions and make sure that they remain with the appliance if it is moved or sold, so that everyone using it through its life will be properly informed on appliance use and safety.



- Please read the instruction book before using this appliance.

General safety

- It is dangerous to alter the specifications or attempt to modify this product in any way.
- This appliance is not intended for use by persons (including children) with reduced physical and sensory conditions or lack of experience and knowledge, unless they have been given supervision or instruction concerning use of the appliance by a person responsible for their safety.
- Make sure that small children and pets do not climb inside the drum. To avoid this, please check into the drum before using.
- Any objects such as coins, safety pins, nails, screws, stones or any other hard, sharp material can cause extensive damage and must not be placed into the machine.

- In order to avoid danger of fires caused by excessive drying, do not use appliance to dry the following items: Cushions, quilts and the like (these items accumulate heat).
- Items such as foam rubber (latex foam), shower caps, waterproof textiles, rubber backed articles and clothes or pillows fitted with foam rubber pads should not be dried in the tumble dryer.
- Always unplug the appliance after use, cleaning and maintenance.
- Under no circumstances should you attempt to repair the machine yourself. Repairs carried out by inexperienced persons may cause injury or serious malfunctioning. Contact your local Service Centre. Always insist on genuine spare parts.
- Items that have been soiled with substances such as cooking oil acetone, petrol, kerosene, spot removers, turpentine, waxes and wax removers should be washed in hot water with an extra amount of detergent before being dried in the tumble dryer.
- **Danger of explosion:** Never tumble dry items that have been in contact with inflammable solvents (petrol, methylated spirits, dry cleaning fluid and the like). As these substances are volatile, they could cause an explosion. Only tumble dry items washed with water.
- **Risk of fire:** items that have been spotted or soaked with vegetable or cooking oil constitute a fire hazard and should not be placed in the tumble dryer.

- If you have washed your laundry with stain remover you must execute an extra rinse cycle before loading your tumble dryer.
- Please make sure that no gas lighters or matches have accidentally been left in pockets of garments in case they are loaded into appliance

 **Warning!**

- **Risk of fire! Never stop a tumble dry before the end of the drying cycle unless all items are quickly removed and spread out so that the heat is dissipated.**
- **Lint must not be allowed to accumulate around the tumble dryer.**
- **Risk of electric shock!** Do not spray down the appliance with jets of water.
- The final part of a tumble dryer cycle occurs without heat (cool down cycle) to ensure that the items are left at a temperature that ensures that items will not be damaged.
- The tumble dryer is not to be used if industrial chemicals have been used for cleaning.
- Ensure you have good ventilation in the installation room to avoid the back flow of gases into the room from appliances burning other fuels, including open fires.

Installation

- This appliance is heavy. Care should be taken when moving it.
- When unpacking the appliance, check that it is not damaged. If in doubt, do not use it and contact the Service Centre.
- All packaging must be removed before use. Serious damage can occur to the product and to property if this is not adhered to. See relevant section in the user manual.
- Any electrical work required to install this appliance should be carried out by a qualified electrician or competent person.
- If the machine is situated on a carpeted floor, please adjust the feet in order to allow air to circulate freely under the appliance.

- After having installed the appliance, check that it is not pressing or standing on its electrical supply cable.
- If the tumble dryer is placed on top of a washing machine, it is compulsory to use the stacking kit (optional accessory).

Use

- This appliance is designed for domestic use. It must not be used for purposes other than those for which it was designed.
- Only wash fabrics which are designed to be machine dried. Follow the instructions on each garment label.
- Do not dry unwashed items in the tumble dryer.
- Do not overload the appliance. See the relevant section in the user manual.
- Clothes which are dripping wet should not be placed in the dryer.
- Garments which have been in contact with volatile petroleum products should not be machine dried. If volatile cleaning fluids are used, care should be taken to ensure that the fluid is removed from the garment before placing in the machine.
- Never pull the power supply cable to remove the plug from the socket; always take hold of the plug itself.
- Never use the tumble dryer if the power supply cable, the control panel, the working surface or the base are damaged so that the inside of the tumble dryer is accessible.
- Fabric softeners, or similar products should be used as specified by the fabric softener instructions.
- **Caution - hot surface** : Do not touch the door light cover surface when the light is switched on.
(Only dryers equipped with internal drum light)

Child safety

- This machine is not intended for use by young children or infirm persons without supervision.
- Children often do not recognise the hazards associated with electrical appliances. Chil-

dren should be supervised to ensure that they do not play with the appliance.



Warning!

- Danger of suffocation! The packaging components (e.g. plastic film, polystyr-

ene) can be dangerous to children - Keep them out of children's reach.

- Keep all detergents in a safe place out of children's reach.
- Make sure that children or pets do not climb inside the drum.

Environment

Recycle the materials with the symbol . Put the packaging in applicable containers to recycle it.

Help protect the environment and human health and to recycle waste of electrical and electronic appliances. Do not dispose appliances marked with the symbol  with the household waste. Return the product to your local recycling facility or contact your municipal office.

Environmental tips

- In the dryer, laundry becomes fluffy and soft. Fabric softeners are not therefore needed when washing.
- Your dryer will function most economically if you:
 - Always keep the ventilation slots on the base of the dryer unobstructed;
 - Use the loading volumes specified in the programme overview;
 - Ensure you have good ventilation in the installation room;

- Clean the micro-fine filter and fine strainer after each drying cycle;
- Spin the laundry well before drying.



Energy consumption depends on spinning speed set in washing machine. Higher spinning speed - lower energy consumption.

Environmental information

The packaging materials are environmentally friendly and can be recycled. The plastic components are identified by markings, e.g. >PE<, >PS<, etc. Please dispose of the packaging materials in the appropriate container at the community waste disposal facilities.



Warning! When the unit is no longer being used:

- Pull the plug out of the socket.
- Cut off the cable and plug and dispose of them.
- Dispose of the door catch. This prevents children from trapping themselves inside and endangering their lives.

Installation

Important! The appliance must be moved in vertical position for transport.

Appliance positioning

- It is recommended that, for your convenience, the machine is positioned close to your washing machine.
- The tumble dryer must be installed in a clean place, where dirt does not build up.
- Air must be able to circulate freely all round the appliance. Do not obstruct the front ven-

tilation grille or the air intake grilles at the back of the machine.

- To keep vibration and noise to a minimum when the dryer is in use, it should be placed on a firm, level surface.
- Once in its permanent operating position, check that the dryer is absolutely level with the aid of a spirit level. If it is not, raise or lower the feet until it is.
- The feet must never be removed. Do not restrict the floor clearance by using deep pile carpets, strips of wood or similar. This might

cause heat built-up which would interfere with the operation of the appliance.

Important!

- The hot air emitted by the tumble dryer can reach temperatures of up to 60°C. The appliance must therefore not be installed on floors which are not resistant to high temperatures.
- When operating the tumble dryer, the room temperature must not be lower than +5°C and higher than +35°C, as it may affect the performance of the appliance.
- Should the appliance be moved, it must be transported vertically.
- The appliance must not be installed behind the lockable door, a sliding door or a door with a hinge on the opposite side to that of the appliance in such a way that a full opening of the dryer is restricted.

Ensure min. 5cm free space around the appliance.

Removing transport safety packaging

Caution! Before use all parts of the transport packaging must be removed.

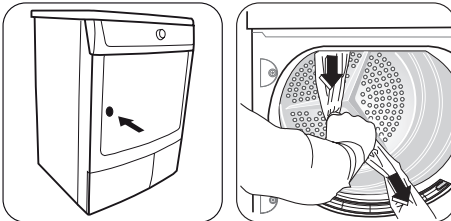

1. Open loading door
2. Pull off adhesive strips from inside machine on top of drum.

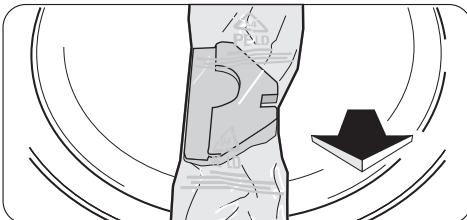

3. Remove foil hose and polystyrene padding from the machine.

Electrical connection

Details on mains voltage, type of current and the fuses required should be taken from the rating plate. The rating plate is fitted near the loading aperture (see "Product description" chapter).

Connect the machine to an earthed socket, in accordance with current wiring regulations.

Warning! The manufacturer declines any responsibility for damage or injury through failure to comply with the above safety precautions.

Should the appliance power supply cable need to be replaced, this must be carried out by an authorised service engineer or a qualified electrician. .

The appliance is supplied with a 13 amp plug fitted. In the event of having to change the fuse in the plug supplied, a 13 amp ASTA approved BS 1363/A fuse must be used.

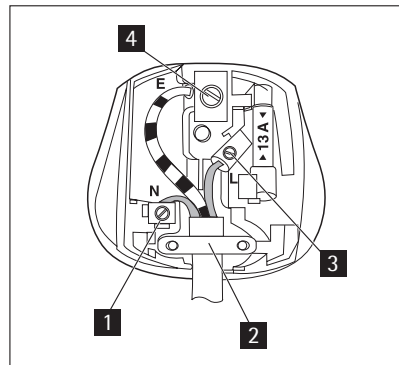

The wires in the mains lead are coloured in accordance with the following code:

- 1 Blue - Neutral
- 2 cord clamp
- 3 Brown - Live
- 4 Green and Yellow - Earth

The wire coloured green and yellow must be connected to the terminal marked with the let-

ter «E» or by the earth symbol \perp or coloured green and yellow.

The wire coloured blue must be connected to the terminal «N» or coloured black.

The wire coloured brown must be connected to the terminal marked «L» or coloured red.

Upon completion there must be no cut, or stray strands of wire present and the cord clamp must be secure over the outer sheath.

Warning! A cut off plug inserted into a 13 amp socket is a serious safety (shock) hazard.

Ensure that the cut off plug is disposed of safely.

Warning! The plug must be accessible after installing the machine.

Permanent connection

In the case of permanent connection it is necessary that you install a double pole switch between the appliance and the electricity supply (mains), with a minimum gap of 3 mm between the switch contacts and of a type suitable for the required load in compliance with the current electrical regulations.

The switch must not break the yellow and green earth cable at any point.

Door reversal

To make it easier to load or unload the laundry, the door can be reversed.

Warning! The door must only be reversed by an authorised service engineer.

Please contact your local Service Force Centre. The engineer will carry out the door reversal at your cost.

Special accessories

▪ stack kit

i Available from your Service Force Centre or your specialist dealer

These intermediate installation kits can be used to arrange the dryer and an washing machine (60 cm wide, front loaded) as a space-saving washer/dryer stack. The washing machine is at the bottom and the dryer is at the top.

Read carefully the instructions supplied with the kit.

▪ drain kit

i Available from your Service Force Centre or your specialist dealer

Installation kit for direct draining of condensate into a basin, siphon, gully, etc. The condensate tank then no longer has to be drained, it must however remain in its intended position in the machine.

Read carefully the instructions supplied with the kit.

▪ pedestal with the drawer

i Available from your Service Force Centre or your specialist dealer

To situate the dryer in optimal high and have some additional space to store (e.g. laundry).

Read carefully the instructions supplied with the kit.

Product description

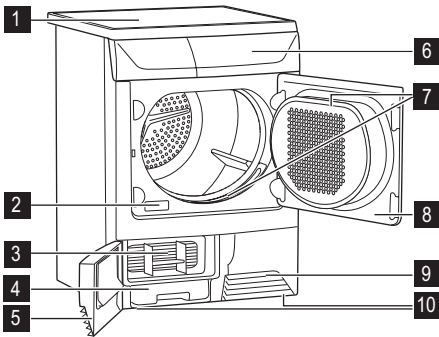

- 1 Worktop
- 2 Rating Plate
- 3 Heat exchanger
- 4 Water reservoir
- 5 Heat exchanger door
- 6 Control panel
- 7 Fluff filters
- 8 Loading door
- 9 Ventilation grille
- 10 Adjustable feet

Control panel

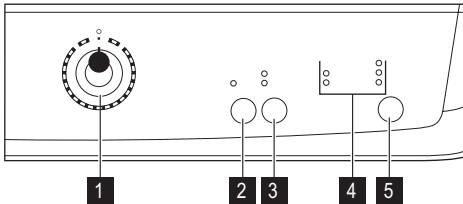



- 1 Programme knob and OFF switch
- 2 **Delicate** button
- 3 **Cotton / Synthetic** selection button
- 4 Function status led: **Drying** , **Anti-crease/End** , **Condenser** , **Filter** , **Tank** lights
- 5 **Start/Pause** button



















Before first use

In order to remove any residues which may have been produced during production, wipe the dryer drum with a damp cloth or carry out a

brief drying cycle (ca. 30 min.) with damp cloths in the machine.

Programme chart

Programmes	Time in minutes (about)	max. load (weight when dry)	Application/properties	Care mark
COTTON EXTRA DRY	140	7 kg	Thorough drying of thick or multi-layered fabrics, e.g. terry towelling items, bathrobes.	 

Programmes	Time in minutes (about)	max. load (weight when dry)	Application/properties	Care mark
COTTON STRONG DRY	130	7 kg	Thorough drying of thick or multi-layered fabrics, e.g. terry towelling items, bathrobes.	 
COTTON STORAGE DRY ¹⁾	125	7 kg	Thorough drying of fabrics of even thicknesses, e.g. terry towelling items, knitwear, towels.	 
COTTON DAMP ¹⁾	110	7 kg	For thin textiles which are still to be ironed, e.g. knitted items, cotton shirts.	 
COTTON IRON DRY ¹⁾	85	7 kg	For thin fabrics which are also to be ironed, e.g. knitwear, cotton shirts.	 
SYNTHETICS EXTRA DRY	50	3 kg	Thorough drying of thick or multi-layered fabrics, e.g. pullovers, bedding, table linen.	 
SYNTHETICS STORAGE DRY ¹⁾	40	3 kg	For thin fabrics which are not ironed, e.g. easy care shirts, table linen, baby clothes, socks, lingerie with bones or wires.	  
SYNTHETICS IRON DRY	30	3 kg	For thin fabrics which are also to be ironed, e.g. knitwear, cotton shirts.	  
JEANS	125	7 kg	For leisure clothing, such as jeans, sweat-shirts, etc., of different material thicknesses (e.g. at the neck, cuffs and seams).	  

¹⁾ In accordance with IEC61121

Programme chart in accordance with IEC61121

The appliance should be tested based on time controlled programmes.

Sorting and preparing laundry

Sorting laundry

- Sort by fabric type:
 - Cotton/linen for programmes in COTTONS programme group.
 - Mixtures and synthetics for programmes in SYNTHETICS programme group.



- Sort by care label: The care labels mean:



Drying in the tumble dryer possible in principle



Drying at normal temperature

	Drying at reduced temperature
	Drying in the tumble dryer not possible

Important! Do not place in the appliance any wet laundry which is not specified on the care label as being suitable for tumble-drying. This appliance can be used for all wet laundry items which are labelled as suitable for tumble-drying.

- Do not dry new, coloured textiles together with light-coloured laundry items. Textile colours may bleed.
- Do not dry cotton jersey and knitwear with the EXTRA DRY programme. Items may shrink!

Preparing laundry

- To avoid laundry becoming tangled: close zips, button up duvet covers and tie loose ties or ribbons (e.g. of aprons).
- Empty pockets. Remove metal items (paper clips, safety pins, etc).
- Turn items with double-layered fabrics inside out (e.g. with cotton-lined anoraks, the cotton layer should be outermost). These fabrics will then dry better.

Daily use

Switching machine on

Turn the programme selector to any programme. The machine switches on.

Operating

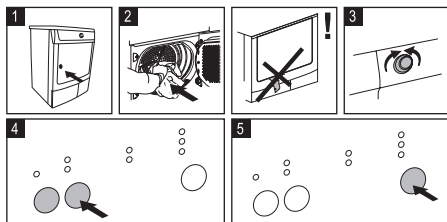

Drying options

DELICATE

Important! Do not overload the appliance. Observe max. loading volume.

Laundry weights

Type of laundry	Weight
Bathrobe	1200 g
Napkin	100 g
Quilt cover	700 g
Sheet	500 g
Pillow case	200 g
Tablecloth	250 g
Towelling towel	200 g
Tea cloth	100 g
Night dress	200 g
Ladies' briefs	100 g
Man's work shirt	600 g
Man's work shirt	200 g
Man's pyjamas	500 g
Blouse	100 g
Men's underpants	100 g

gentle drying with reduced heat of sensitive fabrics and temperature-sensitive textiles (e.g. acrylic, viscose) marked on care label with: 

COTTONS SYNTHETICS

type of laundry - selection for time controlled programmes

Starting the programme

Press the Start/Pause button.

Changing programme

To change a programme which has been selected by mistake once the programme has started, first turn the programme selector to  and then set the programme again.

Drying cycle complete / removing laundry

Once the drying cycle is complete, the LED **Anti-crease/End** is on as well as warning LED's: **Filter** and **Tank**. If the Buzzer button has been pressed, an acoustic signal sounds intermittently for about one minute. Remove the laundry:

1. Open door.
2. Remove visible fluff from the fluff filters. It is best to use a damp hand for this purpose. (see chapter: *Maintenance and cleaning*)
3. Remove laundry.

4. Turn the programme selector to **Off**.

Important! after each drying cycle:

- clean the fluff filters
 - drain the water reservoir
- (see chapter: *Maintenance and cleaning*)

5. Close the door.

i The drying cycles are automatically followed by an anti-crease phase which lasts around 30 minutes. The drum rotates at intervals during this phase to protect the laundry from creases. The laundry can be removed at any time during the anti-crease phase.

Cleaning and maintenance

Cleaning fluff filters

The filters collect all the fluff which accumulates during drying. To ensure that the dryer works perfectly, the fluff filters (fine filters and fluff filters) must be cleaned after each drying cycle.

Caution! Never operate the dryer without fluff filters or with damaged or blocked fluff filters.

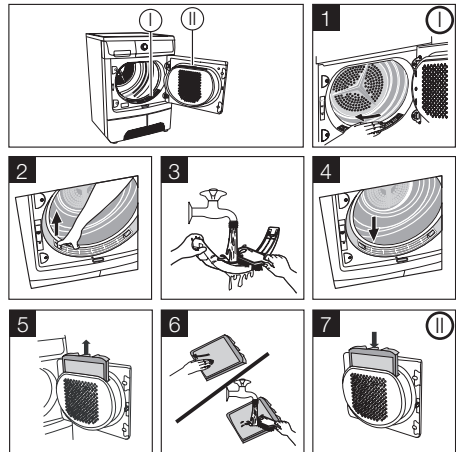
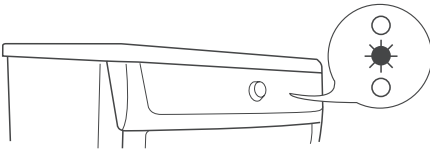

Clean the door seal

Wipe the door seal with a damp cloth immediately after the drying cycle has finished.

Emptying the water reservoir

Empty the water reservoir after every drying cycle.

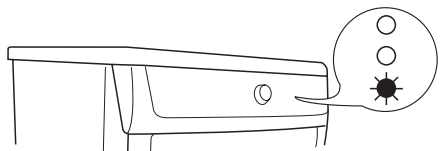

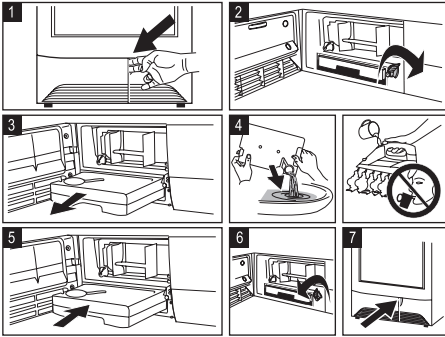

! **Caution!** The condensed water is not suitable for drinking or for preparing foodstuffs.

i If the programme has been interrupted as a result of the water reservoir being full: Press the Start/Pause button to continue the drying cycle.

Cleaning condenser

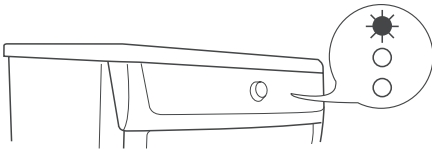

Important!

- Never operate the dryer without condenser.
- Clogged condenser cause higher energy consumption (drying cycle elongation) and dryer damage.

What to do if ...

Troubleshooting by yourself

Problem ¹⁾	Possible cause	Remedy
Dryer does not work.	Dryer not connected to mains supply.	Plug in at mains socket. Check fuse in fuse box (domestic installation).
	Loading door opened.	Close loading door
	The START PAUSE button not pressed.	Press the START PAUSE button.
Unsatisfactory drying results.	Incorrect programme set.	Set suitable programme. ²⁾
	Fluff filters clogged.	Clean fluff filters. ³⁾
	Heat exchanger clogged.	Clean heat exchanger. ³⁾

- Do not use sharp objects to clean.

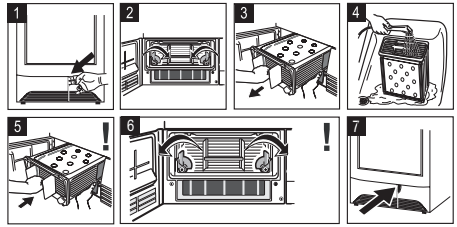

Cleaning the drum

! **Caution!** Do not use abrasives or steel wool to clean the drum.

i Lime in the water or cleaning agents may form a barely visible lining on the inside of the drum. The degree to which the laundry has been dried is then no longer detected reliably. The laundry is damper than expected when removed from the appliance.

Use a standard domestic cleaner (e.g. vinegar-based cleaner) to wipe down the inside of the drum and drum ribs.

Clean control panel and housing

! **Caution!** Do not use furniture cleaners or aggressive cleaning agents to clean the machine.

Use a damp cloth to wipe down the control panel and housing.

	Max. loading exceeded.	Respect max. loading volume.
	Covered ventilation grill.	Uncover ventilation grill in base area.
	Residue inside the drum.	Clean the drum inside.
	To little free space around the appliance	Ensure min. 5cm free space around the appliance
Loading door does not close	Filters not locked in place.	Install fine filter and/or snap course filter into place.
Programme inactive	Full water reservoir.	Empty water reservoir ³⁾ , press START PAUSE button.
Drying cycle too short	Small laundry volume./Too dry laundry for selected programme.	Select time programme or higher drying level (e.g. EXTRA DRY).
Drying cycle too long ⁴⁾	Fluff filters clogged.	Clean fluff filters.
	To high loading volume.	Respect max. loading volume.
	Laundry insufficiently spun.	Spun adequately the laundry.
	Particularly high room temperature - no machine fault.	Lower the room temperature if possible.

1) Switch the dryer off. Set programme/time. Press the START PAUSE button.

2) follow program recommendation - see *Programme overview* chapter

3) see *Care and cleaning* chapter

4) Note: After around 5 hours the drying cycle ends automatically (see *Drying cycle complete* section).

Technical data

Dimensions (mm)	Width / Height / Depth	85 x 60 x 58 cm
Max. depth (with the appliance door open)		1090 mm
Max. width (with the appliance door open)		950 mm
Electrical connection	Voltage	230-240 V
	Frequency	50 Hz
	Fuse	13 A
	Total power	2350 W
Drum volume		108 l
Weight of the appliance		37 kg
Laundry: max. weight		7 kg
Type of use		Household
Ambient temperature	Min.	5 °C
	Max.	35 °C
Energy consumption ¹⁾	kWh/cycle	4,70 kWh
Annual energy consumption ²⁾		552 kWh
Energy efficiency class		C

Power consumption	Left-on mode	0 W
	Off-mode	0 W

- 1) With reference to EN 61121. 7 kg of cotton and a spin speed at 1000 rpm.
- 2) Energy consumption per year in kWh, based on 160 drying cycles of the standard cotton programme at full and partial load, and the consumption of the low-power modes. Actual energy consumption per cycle will depend on how the appliance is used (REGULATION (EU) No 392/2012).

Machine settings

BUZZER permanent off

1. Turn the programme selector to any programme.
2. Press simultaneously the **Delicate** and **Cotton / Synthetic** buttons and hold down for approx. 5 seconds.
3. The buzzer is by default always off.



www.zanussi.com/shop



136926400-B-092013