

Installation in concrete ceiling

CAUTION:

1. For concrete mounting, the drilled hole must be recommended by the manufacturer of the anchor (this is usually marked on the anchor) and must be drilled at least 1/2" deeper than the length of the anchor.
2. The holes must be made with a suitable carbide-tipped masonry drill bit.
3. The anchors must be new and unused.
4. The concrete ceiling must be sound and free of cracks or voids in the vicinity of the mounting holes.
5. The anchors must be set in flush with the surface of the concrete.
6. The bracket screws must never be backed out. If the bracket screws can be turned easily (by hand), do not hang fan.

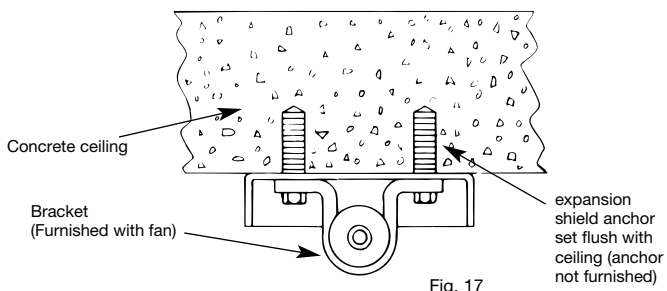

Fig. 17

Installation

- A. Drill holes 2" deep in concrete ceiling to receive 1/4" x 1 1/2" expansion shield anchor, "Rawl No. 1055" or equal. (Not furnished.) Install shield in holes, observing all cautions above.
- B. Proceed with the installation of the fan per the basic installation instructions.

The Inside Story

Oil is constantly pumped up the spiral groove to lubricate the rotor and shaft. The oil is returned to the reservoir where the bearings are submerged in a bath of oil.

This unique lubrication system is built into all Original Hunter Ceiling Fans. That's one reason Hunters last so long. And why we can offer a Limited Lifetime Warranty.

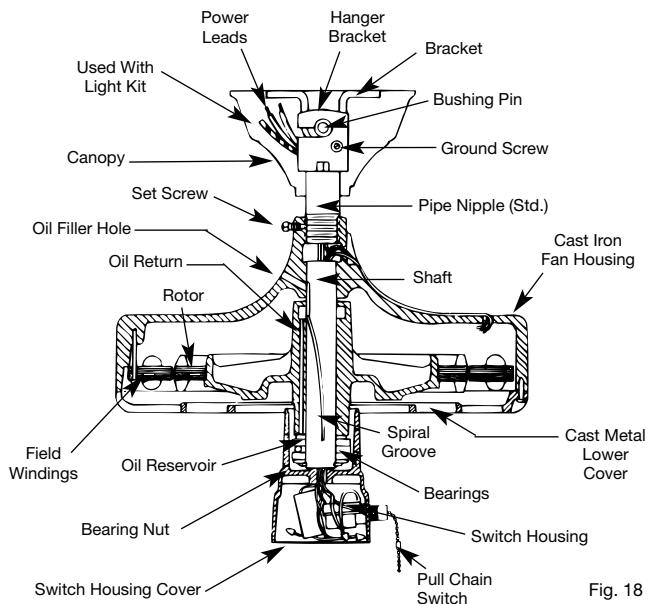

Fig. 18

Trouble shooting guide

Problem	Probable Cause	Solution
1. Nothing happens; blades do not rotate.*	1. Power turned off or fuse blown. 2. Loose wire connections or wrong connections. 3. Pull chain switch not "on". 4. Reversing switch in center.	1. Turn power on or replace fuse. 2. Loosen canopy. Check all connections (turn power off while checking). 3. Pull switch cord. 4. Slide reversing switch either up or down.

* Note: If blades will not turn by hand, contact your nearest service representative or dealer.

1. Noisy operation.	1. Blade irons loosely screwed to rotor. 2. Blade screwed loosely to blade iron. 3. Blade cracked. 4. Canopy contacting ceiling. 5. No oil or low oil level.	1. Tighten screws until snug. 2. Tighten. 3. Replace all 4 blades. Contact dealer. 4. Lower canopy. 5. Check oil level.
1. Excessive wobbling	1. Unbalanced blades. 2. Inadequate blade clearance. 3. Loose blades or blade irons. 4. Fan not secure on hanger assembly.	1. Rebalance (See Step 7D). 2. Relocate fan. 3. Tighten all screws. 4. Turn power off. Support fan very carefully. Loosen canopy and hang correctly.

Fill in the blanks below for your record.

Serial number _____

Model number _____

Date purchased _____ Date installed _____

Dealer/store name where purchased _____



SINCE

1 8 8 6

INSTALLATION INSTRUCTIONS FOR HUNTER ORIGINAL CEILING FANS

CAUTION:

1. Read this entire instruction manual thoroughly before beginning installation and SAVE THESE INSTRUCTIONS.
2. To avoid possible shock, BE CERTAIN ELECTRICITY IS SHUT OFF AT MAIN PANEL BEFORE WIRING. Always turn power off at main panel before servicing your fan or installing accessories.
All wiring must be in accordance with national and local electrical codes. If you are unfamiliar with wiring, you should use a qualified electrician.
3. To reduce the risk of personal injury, install the fan only to the building structure according to these instructions, and use only the hardware supplied.
4. NEVER REST THE FAN ON THE SWITCH HOUSING. As you prepare the fan for installation, let the motor rest in the liner in which it was packed.
5. Be sure to put full contents of oil tube in fan according to instructions.
6. If this fan is used as a replacement for an Original Old-Tyme non-reversible fan, it must be installed per instructions included with this fan. DO NOT HANG ON SINGLE "J" HOOK. Failure to follow these instructions could result in fan falling.
7. To reduce the risk of noise do not use a solid-state speed control with this fan. Use Hunter controls only.
8. Do not use an abrasive cleaner on the fan. A mild detergent will clean and restore most units to their original beauty.

The installation of your Hunter Ceiling Fan

NOTE TO INSTALLERS: Please leave this manual with the owner.

Tools needed:

- Pliers
- Flat blade screwdriver
- Phillips screwdriver
- Electric drill
- 3/8" Socket wrench
- 11/64" bit
- 3 wire connectors
- 4" x 1 1/2" standard octagon electrical outlet box

Step 1: Pre-installation

- A. Select installation site: Normally this is near the center of the room, often replacing a light fixture. Make certain that ample clearance is left for the rotating fan blades. For maximum efficiency, no obstruction (walls, posts, etc.) should be within 24" of the tips of the blades (see Fig. 1). Mounting site should also meet the precautions listed in Step 3.

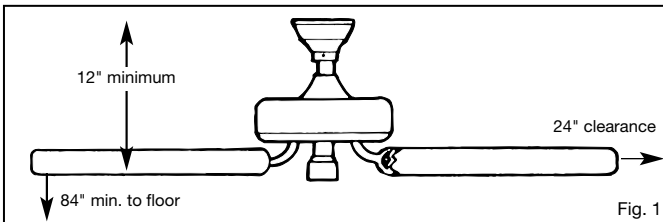

- B. Fan mounting height: Your Hunter fan comes with the proper hardware to hang the fan from a standard 8 foot ceiling so the fan blades will be 12" from the ceiling and approximately 7 feet from the floor (see Fig. 1).

NOTE: On vaulted ceilings, up to 45° pitch, you may want to use the Hunter Vaulted Ceiling Mounting Kit.

Step 2: Inspect fan

- A. Unpack the fan carefully to avoid any damage to components.
CAUTION: NEVER LIFT THE MOTOR BY THE WIRES. LET MOTOR REST IN THE CARTON LINER FOR PROTECTION.
- B. Check the sack parts.

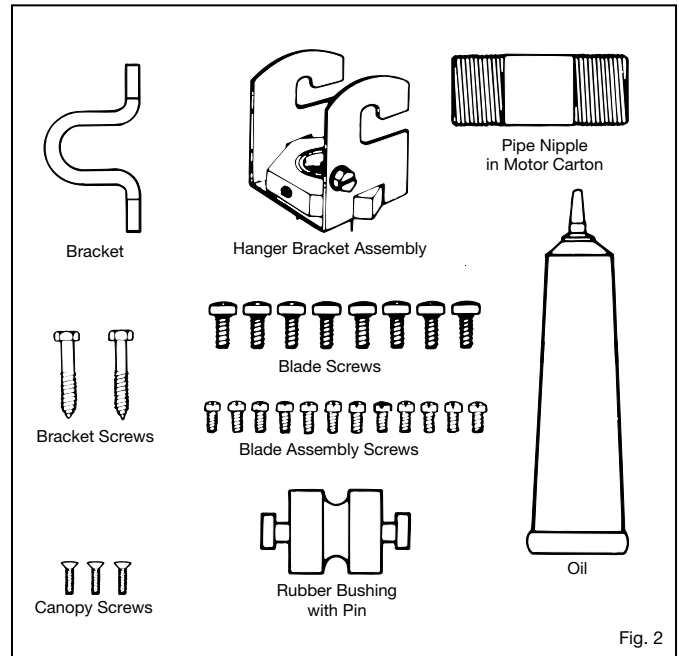

Step 3: Installation of ceiling mounting hardware

CAUTION: YOUR HUNTER CEILING FAN WEIGHS UP TO 50 LBS. THE FOLLOWING PRECAUTIONS MUST BE TAKEN FOR SAFETY AND TO ENSURE THAT YOUR FAN IS SECURELY MOUNTED TO THE CEILING.

- When inspecting or preparing installation site where wiring is available, make sure electricity is "off" at fuse box or circuit breaker panel.
 - All wiring must meet local and national codes.
 - Do not mount directly to an unsupported ceiling or to an electrical outlet box.
 - The wood joist chosen for mounting the fan must be sound and of sufficient size. In no case, should it be smaller than standard 2" x 4" lumber.
- A. Secure a metallic outlet box 4" x 1 1/2" or 4" x 1/2" deep to 2 x 4 cross brace between two ceiling joists as shown in Figure 3. The outlet box must be recessed in the ceiling by 1/16" minimum. Secure the outlet box to the cross brace by drilling (2) pilot holes no larger than the minor diameter of the woodscrews (5/64") and use two #8 x 1 1/2" woodscrews and washers. Use the innermost holes for securing the box. Orient the box so the outermost holes are aligned with the 2 x 4 brace. The outermost holes will be used in Step 3B.

CAUTION: Do not use a lubricant on screws.

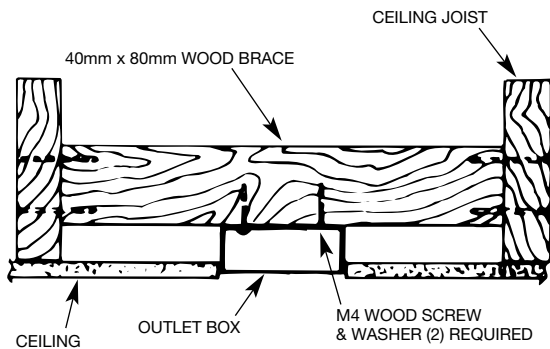

Fig. 3

- B.** Drill (2) $\frac{11}{64}$ " diameter holes through the outermost holes in the box 2" deep into the cross brace. These holes are for the bracket screws.
- C.** Use the (2) bracket screws to secure the hanger bracket to the joist as shown in Figure 4. Install rubber bushing in hanger bracket before assembling the parts to the ceiling joist. Do not use lubricant on the screw threads. For an alternate bracket that fits inside a surface-mounted box, cut 1" off each end of the bracket supplied.

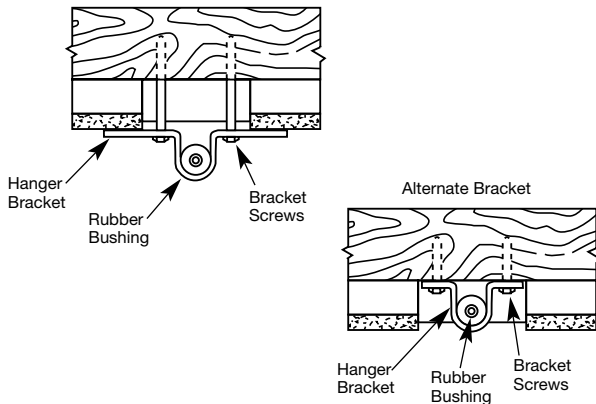

Fig. 4

Step 4: Hanging your fan

CAUTION: BE SURE TO TIGHTEN THE PIPE NIPPLE INTO THE FAN, AND THE HANGER BRACKET ONTO THE PIPE, AND TIGHTEN THE 2 SET SCREWS, AS DESCRIBED IN STEP B, TO PREVENT THE FAN FROM FALLING.

CAUTION: YOUR FAN MAY WEIGHT UP TO 50 LBS. ALL OF THE FOLLOWING STEPS MUST BE FOLLOWED IN ORDER TO ENSURE A SECURE MOUNTING. PERFORM STEPS A THROUGH D WITH MOTOR RESTING IN LINER FOR PROTECTION.

- A.** Take hanger bracket from sack parts and pipe nipple. Feed wires from the top of your motor through pipe.
- B.** Back out set screw in neck of fan motor housing and hanger bracket so pipe can be screwed in. Screw the pipe into the fan until tight (at least $4\frac{1}{2}$ turns). Feed wire through hanger bracket and screw hanger bracket onto pipe until tight (at least 3 turns). Then use pliers to tighten both hanger bracket and pipe together. Tighten the set screw in the motor housing with pliers. Securely tighten the set screw in the hanger bracket. See Figure 5.
- C.** Be sure the pin is centered in the rubber bushing. See Figures 6 and 7.

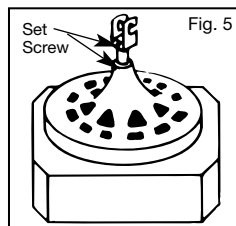

Fig. 5

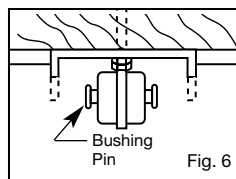

Fig. 6

- D.** Lift the fan by the motor housing, hook the hanger bracket onto the pin in the rubber bushing. **Make sure both ends of the pin are outside the hanger bracket.** See Figure 9. **FAILURE TO PERFORM THESE STEPS IN CORRECT ORDER MAY RESULT IN FAN FALLING.**

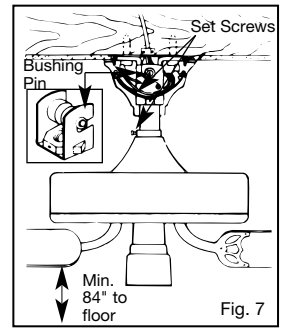

Fig. 7

Step 5: Wiring instructions and canopy installation

CAUTION: BE CERTAIN THAT ELECTRICITY IS TURNED OFF AT THE MAIN PANEL BEFORE ANY WIRING IS DONE.

Before you do the final wiring, you should decide how you want to control your fan—with pull cord, a wall switch or a speed control. At this point, you should also decide if you want to add a light adaptor kit. **Separate wiring instructions for Hunter accessories are included in accessory packages.**

All wiring must conform to national and local codes which may vary by locale.

- A.** Connect black electrical supply lead to the black motor lead and the black with white stripe motor lead (See note). Connect the white electrical supply lead to the white motor lead. Connect ground wire to green screw on side of hanger bracket. See Figure 8.

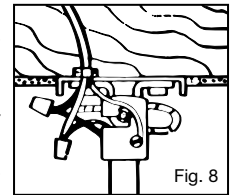

Fig. 8

NOTE: If a separate wall switch will be used to control a lighting accessory, connect the black wire with a white stripe to the wall switch lead, following wiring instructions included with the accessory. The wall switch must be a listed general-use switch.

CAUTION: NO BARE WIRE OR WIRE STRANDS SHOULD BE VISIBLE AFTER MAKING CONNECTIONS.

After making the wire connections, the wires should be spread apart with the white and the green wires on one side of the outlet box, and the black and black & white wires on the other side of the box.

The splices should be turned upward and pushed carefully up into the outlet box.

Canopy installation

Assemble canopy halves around pipe. Screw together loosely using two screws provided in parts bag. (Brass and antique brass canopies are shipped assembled.) Position canopy close to ceiling. Tighten both assembly screws and SCREW IN the canopy set screw. See Figure 9. **NOTE:** If a Vaulted Ceiling Mounting Kit is used, follow the canopy instructions provided with the kit.

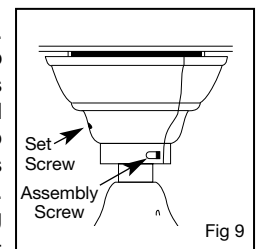

Fig. 9

Step 6: Lubrication

Adding oil

Your fan has been shipped without oil in the motor. A 1-ounce tube of high grade SAE 10 non-detergent oil is packaged in the sack parts. All the oil in the tube must be put into the fan. Cut the tip off the tube and place the tube into the oil hole. **To avoid overflowing during filling, allow oil to gravity flow about one minute to fill the oil reservoir.** (It may be necessary to puncture the tube to allow air in.) See Figure 10.

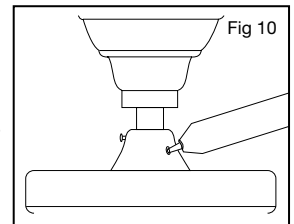
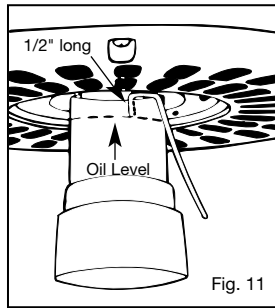

Fig. 10

Checking Oil

Check oil level immediately after filling the reservoir. To check oil, bend an ordinary pipe cleaner into a 1/2" long hook and dip it into the oil reservoir. See Figure 11. If oil touches the end of the pipe cleaner, the fan has ample oil. If it does not touch, add SAE 10 non-detergent oil slowly until it touches the pipe cleaner.



Your Original Hunter's unique lubricating system

The bearings are submerged in a bath of oil. The oil moves up a spiral groove in the shaft, lubricating all bearing surfaces as the fan operates. This Lubrication System does not normally "use up" or require the addition of extra oil once the oil reservoir has been filled to the correct level. This unique lubrication system is one reason your Original Hunter Ceiling Fan will last a lifetime. It is highly unlikely that you will ever need to add oil to your Original fan once it is installed. Should you move your fan to another location, it is a good idea to check the oil reservoir. Hunter has developed an accessory 'Original Relocation Kit' that includes all mounting hardware and a fresh tube of oil for this reason. The model number is 22360.

CAUTION: DO NOT TURN FAN ON UNTIL LUBRICATION HAS BEEN ADDED. TO OPERATE THE FAN WITHOUT OIL OR WITH LOW OIL WILL VOID YOUR WARRANTY.

Step 7: Fan blade assembly, installation and balancing

WARNING: TO REDUCE THE RISK OF PERSONAL INJURY, DO NOT BEND THE BLADE BRACKETS WHEN INSTALLING THE BRACKETS, BALANCING THE BLADES, OR CLEANING THE FAN. DO NOT INSERT FOREIGN OBJECTS IN BETWEEN ROTATING FAN BLADES.

- A.** Attach wood blades to blade brackets using three screws for each blade. (See Figure 12.) If your blades have large holes, you must first insert the rubber grommets into the holes. (See Figure 12A.) Make sure all screws are tight to prevent vibration or wobbling. A cavity in the styrofoam packaging has been provided to nest the parts in during assembly to assure correct alignment of parts.

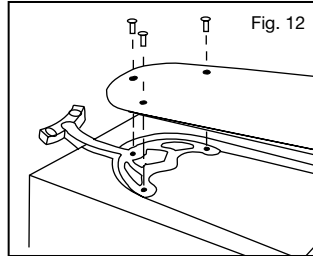

NOTE: Grommets are usually assembled by hand. If you use a tool, make certain you do not damage the grommet or blade when inserting the grommets.

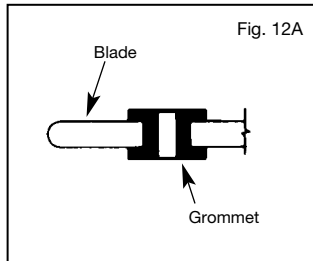

- B.** With some fans you have an option to install four or five blades. For five blades, mount to the outer row of holes on the motor. For four blades, use the inner row. (See Figure 12C.)

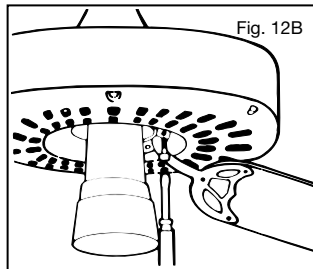

- C.** To install the blades to the motor, insert blade iron screw through hole in the blade iron. Use screwdriver to hold in place. Fasten screw onto motor, but do not tighten. (See Figure 12B.)

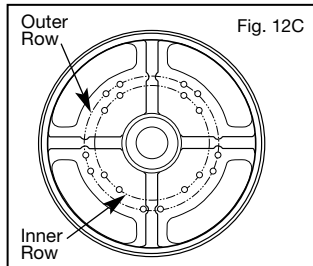

Line up other hole on motor and fasten the second screw. Before tightening screws, make sure they are not cross-threaded in the mounting holes. Tighten both screws securely. Repeat for remaining blades.

CAUTION: DO NOT ATTEMPT TO RUN FAN UNTIL ALL SCREWS HAVE BEEN TIGHTENED SECURELY.

- D.** A blade balancing kit has been provided with your fan. Should the fan wobble in operation, you may use this kit to correct the balance per the instructions supplied with the kit.

Step 8: Operation of your Hunter Fan

- A.** The operation of your fan is controlled with a pull-chain switch which has 4 positions: off—high—medium—low. Pull the chain gently to obtain the speed you desire.

- B.** The Break-A-Way Connector is designed to separate from the chain at a predetermined force. If this separation occurs, simply reinsert connector. It can be reused again and again. (Figure 13.)

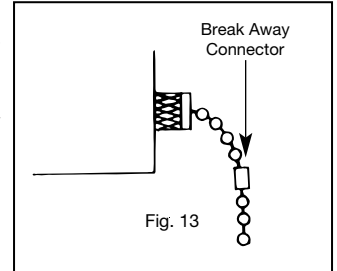

- C.** Reversing your fan is controlled by a small switch located on the switch housing. (Figure 14.)

Ceiling fans are usually adjusted once in the fall and again in the spring to blow upward in the winter and downward in the summer. You may run them in either direction at anytime, however, as you prefer. Experiment as you like to obtain maximum comfort from your fan.

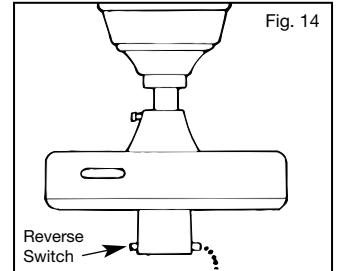

Care and Maintenance

Once properly installed, your fan needs very little attention, beyond checking the oil level. Oil is checked with a pipe cleaner used as a dipstick. (See Step 6.)

Take care when cleaning your fan. Never use an abrasive cleanser or brass polish. Use a damp cloth or sponge. Do not drip water or soap into the motor.

Blades should be wiped clean periodically to prevent dust buildup. Be careful not to bend the blade irons.

If blades are cracked, or blade irons bent, do not attempt to repair them. Order replacement parts from your Hunter dealer.

Installation on pitched or beam ceilings

Choose the specific figure below showing the mounting appropriate to your ceiling. Use the figure as a guide in conjunction with the basic mounting instructions.

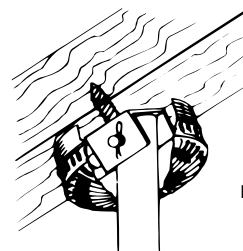

Mounting on pitched ceiling with vaulted ceiling mount.

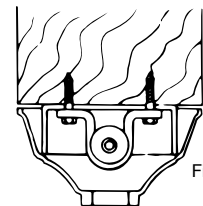

Horizontal beam mount

For mounting on a pitched ceiling, you should use a Hunter Vaulted Ceiling Mounting Kit and hanger pipe, which are available from your Hunter dealer.