

# Gigaset

## N720 DECT IP

### Multicell System

Installation, configuration and operation

**Gigaset**pro

INSPIRING CONVERSATION.



# Gigaset N720 DECT IP Multicell System ...

---

... the DECT IP multicell system for Internet telephony and unrestricted mobility when making calls in small and medium-sized companies.

## **Enable Internet telephony for up to 100 subscribers**

Enable your company's employees to make calls via the Internet and, at the same time, benefit from DECT telephony:

Available throughout the DECT network, freedom of movement when making calls.

## **Manage the phone functions centrally at a management station**

Manage your Gigaset telephone system via your PC's Web browser. Save your telephone system's configuration on your PC after you have set it up.

## **Organise and synchronise your base stations**

Register the base stations belonging to your DECT network and define a synchronisation hierarchy. If your base stations are a long way apart, create independent DECT clusters and manage them from a central point.

## **Manage handsets**

Register the handsets on the DECT network. Configure VoIP connections and set up network and individual mailboxes for your company's employees.

## **Make important functions available centrally**

Make public and corporate directories available to employees.

## **Go online with your Gigaset**

Use your phone's Info Centre and have information specifically provided for the phone from the Internet shown on the display of the registered handsets.

## **Practical functions**

Use the programmable display keys on the registered handsets to quickly access important phone functions, or read your eMail messages on your phone (without a PC).

You can find additional information about your phone at [www.gigaset.com/pro/gigasetn720](http://www.gigaset.com/pro/gigasetn720)

**Have fun using your new telephone system!**

# Table of Contents

- Gigaset N720 DECT IP Multicell System ...** ..... 3
- Introduction** ..... 6
- Safety precautions** ..... 9
- First steps** ..... 10
  - Checking the package contents ..... 10
  - Installing base stations and DECT Manager – procedure ..... 11
  - Connecting base stations and DECT Manager ..... 12
  - Connecting devices to the local network and to the Internet ..... 14
  - Mounting devices on the wall ..... 16
  - Preparing to use the telephone system ..... 17
  - How to proceed ..... 21
- Operating information** ..... 22
  - Light emitting diodes (LED) ..... 22
  - Resetting the device settings ..... 24
  - Menu tree (handsets) ..... 26
  - Understanding the operating steps ..... 27
- Making calls** ..... 29
  - Calling ..... 29
  - Ending a call ..... 30
  - Accepting a call ..... 31
  - Calling Line Identification ..... 31
  - Call waiting during a call ..... 33
  - Initiating ringback ..... 33
  - Initiating a consultation call ..... 34
  - Call swapping ..... 34
  - Transferring a call to another subscriber ..... 35
  - "Anonymous calling" ..... 35
  - Gigaset HDSP – telephony with brilliant sound quality ..... 36
- Setting phone functions** ..... 37
  - Activating/deactivating call waiting for calls ..... 37
  - Using call forwarding (CF) ..... 37
  - Do not disturb ..... 38
- Using directories** ..... 39
  - Using corporate directories ..... 40
  - Using online directories ..... 41
- Using the call lists** ..... 44
  - Viewing entries ..... 44
  - Dialling a number from a list ..... 45
  - Copying an entry from the call list to the local directory..... 45
  - Deleting an entry/list ..... 45

|   |            |
|---|------------|
| <b>Displaying messages</b> .....  | <b>46</b>  |
| Using the network mailbox .....   | 46         |
| eMail notifications .....   | 48         |
| <b>Info centre – continuous Internet access from your phone</b> .....   | <b>52</b>  |
| Starting the info centre, selecting info services .....   | 52         |
| Login for personalised info services .....  | 53         |
| Operating the info centre .....   | 54         |
| <b>System settings and settings on the handset</b> .....  | <b>56</b>  |
| Date and time .....   | 56         |
| Quickly accessing functions .....   | 56         |
| <b>Configuring the system on the DECT Manager</b> .....   | <b>58</b>  |
| Using the Web configurator .....  | 58         |
| Web configurator menu .....   | 63         |
| Connecting the DECT Manager to the local network (LAN/router) .....   | 64         |
| Configuring and synchronising base stations .....   | 67         |
| Security settings .....   | 71         |
| Configuring VoIP providers .....  | 73         |
| Configuring handsets .....  | 75         |
| Additional settings for making a call .....   | 82         |
| Info services .....   | 88         |
| Online directories .....  | 89         |
| Device management .....   | 92         |
| DECT Manager and base station status .....  | 98         |
| <b>Customer care</b> .....  | <b>99</b>  |
| Questions and answers .....   | 99         |
| Information on operating Gigaset VoIP telephones with routers with<br>Network Address Translation (NAT) ..... | 101        |
| Checking service information .....  | 103        |
| <b>Environment</b> .....  | <b>104</b> |
| Our environmental mission statement .....   | 104        |
| Environmental management system .....   | 104        |
| Disposal .....  | 104        |
| <b>Appendix</b> .....   | <b>105</b> |
| Care .....  | 105        |
| Contact with liquid .....   | 105        |
| Authorisation Gigaset N720 IP PRO .....   | 105        |
| Authorisation Gigaset N720 DM PRO .....   | 105        |
| Specifications .....  | 106        |
| <b>Glossary</b> .....   | <b>107</b> |
| <b>Accessories</b> .....  | <b>120</b> |
| <b>Index</b> .....  | <b>124</b> |

# Introduction

Gigaset N720 DECT IP Multicell System is a DECT multicell system for connecting DECT base stations to a VoIP PABX. It combines the options of IP telephony with the use of DECT telephones.

The following illustration shows the components of the Gigaset N720 DECT IP Multicell System and the way the system is embedded in the IP telephone environment:

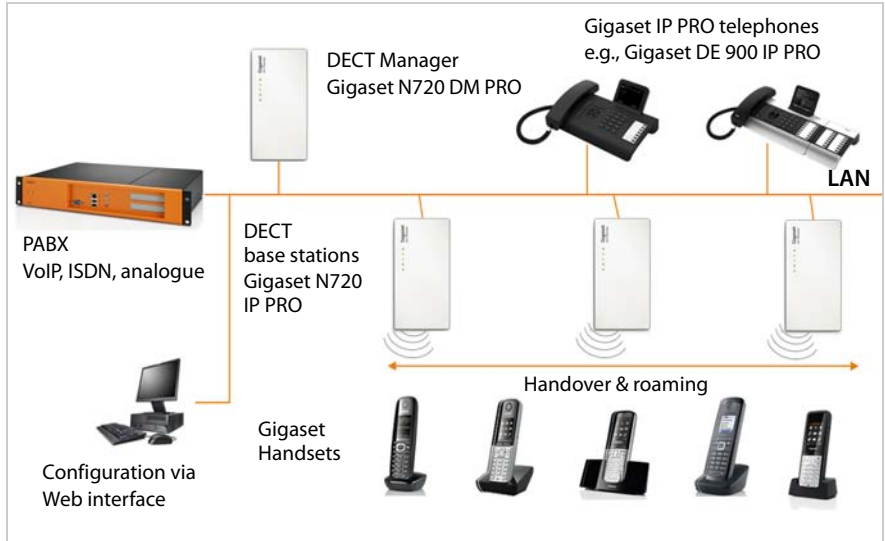

◆ **DECT Manager Gigaset N720 DM PRO**

Central management station for managing the DECT network. One DECT Manager must be used for each installation. The DECT Manager

- Manages up to 20 DECT base stations
- Manages up to 100 handsets on multicell systems
- Enables division into subnets (**Cluster** formation)
- Represents the interface to an IP PABX (e.g., Gigaset T500 PRO/T300 PRO)

The DECT Manager offers a Web user interface for the configuration and administration of the DECT network.

Getting started with the DECT Manager → [page 11](#)

Configuring the DECT network using the Web user interface → [page 58](#)

◆ **Gigaset N720 IP PRO DECT base stations**

- These are the cells of the DECT telephone network.
- Each base station can manage up to eight calls simultaneously.

Getting started with the base stations → [page 11](#)

Configuring the base stations → [page 67](#)

### ◆ Gigaset handsets

- Up to 100 handsets can be connected and 30 DECT connections can be made simultaneously (calls, eMail checks, connections to online directories and the Info Centre).

The following handsets are recommended: Gigaset SL610H PRO, SL400H, S810H, E49H.

Further information relating to the functions of the handsets in connection with the Gigaset base stations can be found in the **Accessories** section (→ **page 123**) and on the **Service** page at [www.gigaset.com/pro/gigasetn720](http://www.gigaset.com/pro/gigasetn720) on the Internet.

- Subscribers can accept or initiate calls in all DECT cells with their handset (**Roaming**), and can also switch between the DECT cells during a call (**Handover**). A handover is only possible within the same cluster.

Configuring handsets → **page 75**

The functions of a handset on a Gigaset N720 DECT IP Multicell System are described in this document using the example of the Gigaset SL610H PRO handset. Detailed information about this handset and other approved Gigaset handsets can be found in the relevant user guide. These are provided on the product CD or on the Internet at [www.gigaset.com](http://www.gigaset.com).

### ◆ PABX

You can connect your DECT telephone system to a PABX for VoIP, ISDN or analogue telephony, e.g.,

- A Gigaset T500 PRO or T300 PRO
- A PABX from another manufacturer
- A PABX over the Internet (hosted PBX)

The PABX

- Establishes the connection to a public telephone network
- Enables central management of telephone connections, directories, network mailboxes

### ◆ Forming clusters with the Gigaset N720 DECT IP Multicell System

You can divide DECT base stations that you have installed at your location into several independent groups, i.e., clusters, and manage them using one Gigaset N720 DM PRO DECT Manager (→ **page 70**).

This means DECT domains that are a long way apart can be managed from a central point. The DECT Manager is connected to the base stations and the PABX via the local network and is therefore not dependent on DECT ranges. It guarantees access to the centrally configured IP connections, directories etc. However, a handover of handsets between clusters is not possible.

### **Planning your DECT wireless network**

Careful planning of your DECT wireless network is the prerequisite for successful operation of the Gigaset N720 DECT IP Multicell System with good call quality and adequate call options for all subscribers in all the buildings and areas belonging to the PABX. When deciding how many base stations are needed, and where these should be positioned, both the requirements for the capacity of the PABX and its wireless coverage, as well as many ambient conditions, must be taken into consideration.

The "Gigaset N720 DECT IP Multicell System - Site Planning and Measurement Guide" provided on the enclosed product CD will make it easier for you to plan your multicell DECT network, explain the necessary preparatory work for the installation and describe how to carry out measurements in order to find the best positions for your base stations. Please read these instructions before starting installation.

Gigaset also offers the Gigaset N720 SPK PRO (Site Planning Kit) to help you measure the wireless coverage and signal quality on your DECT network. Information about setting up and using the Gigaset measuring equipment can also be found in the "Gigaset N720 DECT IP Multicell System - Site Planning and Measurement Guide".



# Safety precautions

---

## Warning

Read the safety precautions and the user guide before use.



Use only the power adapter supplied, as indicated on the devices.



Using your telephone may affect nearby medical equipment. Be aware of the technical conditions in your specific location e.g., doctor's surgery. If you use a medical device (e.g., a pacemaker), please contact the device manufacturer. They will be able to advise you regarding the susceptibility of the device to external sources of high frequency energy. Please refer to the **Appendix** chapter for the specifications of this Gigaset product.



The devices are not splashproof. For this reason do not install them in a damp environment such as bathrooms or shower rooms.



Do not use the devices in environments with a potential explosion hazard (e.g., paint shops).



If you give your Gigaset to a third party, make sure you also give them the user guide.



Remove faulty devices from use or have them repaired by our Service team, as these could interfere with other wireless services.

## Please note

- ◆ Not all of the functions described in this user guide are available in all countries.
- ◆ The devices cannot be used in the event of a power failure. It is also **not** possible to transmit **emergency calls**.

# First steps

---

## Checking the package contents

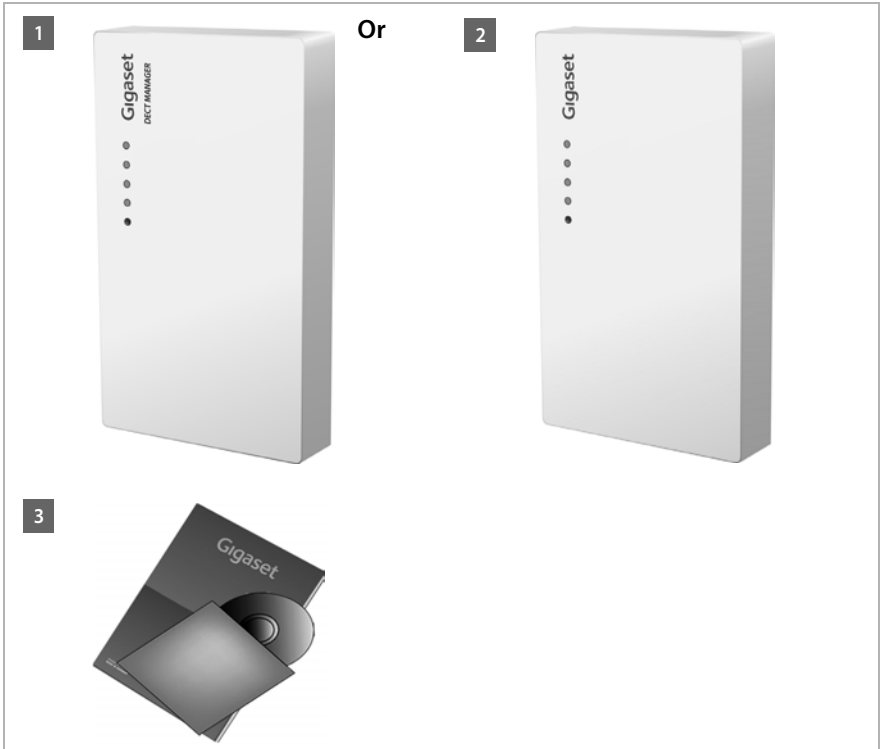

- 1 One Gigaset N720 DM PRO DECT Manager or
- 2 One Gigaset N720 IP PRO base station
- 3 One CD with user guide (Gigaset N720 DM PRO only)

This includes, for example, the "Gigaset N720 DECT IP Multicell System - Site Planning and Measurement Guide", → [page 8](#)

**Please note**

The Gigaset N720 DECT IP Multicell System devices are powered by Power over Ethernet (PoE). If you do not use an Ethernet switch with PoE functionality and require a power adapter to connect to the mains power supply, you can order this as an accessory (→ [page 120](#)).

### Firmware updates

Whenever there are new or improved functions for your Gigaset, firmware updates are made available for you to download to your DECT Manager and your base station (→ [page 97](#)). If this results in operational changes when using your phone, a new version of this user guide or the necessary amendments will be published on the Internet at

[www.gigaset.com/pro](http://www.gigaset.com/pro)

Select the product to open the relevant product page for your base, where you will find a link to the user guides.

To find out which version of the DECT Manager firmware is currently loaded, see → [page 97](#) and [page 103](#).

## Installing base stations and DECT Manager – procedure

### Caution

Read the "Gigaset N720 DECT IP Multicell System - Site Planning and Measurement Guide" before you start installing the devices.

- ▶ When installing the base stations, please take into account the technical conditions for positioning and the installation guidelines, which are described in the "Gigaset N720 DECT IP Multicell System -Site Planning and Measurement Guide".
- ▶ Install the base stations at the positions you determined when planning or measuring your DECT wireless network.
- ▶ The Gigaset N720 DM PRO (DECT Manager) can be installed anywhere within the range of the local network. It does not need to be installed in the coverage area of the DECT wireless network.
- ▶ The Gigaset N720 IP PRO base stations and the Gigaset N720 DM PRO DECT Manager are intended for wall mounting (→ [page 16](#)).

### Caution

- ◆ The devices are designed for use in dry rooms with a temperature range of +5°C to +45°C.
- ◆ Never expose the devices to heat sources, direct sunlight or other electrical appliances.
- ◆ Protect your Gigaset from moisture, dust, corrosive liquids and fumes.

## Connecting base stations and DECT Manager

To be able to make calls with your Gigaset N720 DECT IP Multicell System via VoIP, the following conditions must be fulfilled:

- ◆ The DECT Manager is installed
- ◆ Your DECT Manager and base station are connected to the local network ( → [page 14](#))
- ◆ At least one base station is registered ( → [page 17](#))
- ◆ At least one handset is registered to the telephone system ( → [page 18](#))

Perform the following steps in the specified sequence, first for the DECT Manager and then for all the base stations to be installed:

- 1** Connect the power cable to the device and connect to the mains power supply, if necessary.
- 2** Connect the base to the router/switch to access the local network and configure via the Web configurator.
- 3** Fix the device to the planned position on the wall.

### Please note

Your Gigaset N720 DECT IP Multicell System is supplied with sufficient power via PoE (Power over Ethernet) if the device is connected to an Ethernet switch with PoE functionality (PoE class IEEE802.3af). In this case, you do **not** need to connect the device to the mains power supply and step **1** can be omitted.

## Connecting the power cable

### Please note

This connection is only required if the device is not powered via PoE.

If you do not use PoE, the power adapter must be **plugged in at all times** for operation, as the device will not work without a power supply.



- 1 Insert the power cable of the power adapter into the connection socket at the rear of the device.
- 2 Insert the cable into the cable recess provided.
- 3 Insert the power adapter into the mains socket.

### Caution

Use only the power adapter recommended in the **Accessories** section (→ **page 120**).

## Connecting devices to the local network and to the Internet

### Data protection notice

When the device is connected to the Internet, it automatically contacts the Gigaset support server to make it easier for you to configure the devices and to enable communication with Internet services.

For this purpose, the DECT Manager sends the following information when the system is started and then every five hours:

- ◆ Serial number/item number
- ◆ MAC address
- ◆ IP address for the Gigaset on the LAN/its port numbers
- ◆ Device name
- ◆ Software version

The following data is transmitted once every day.

- ◆ Number of registered handsets
- ◆ Information for each handset: DECT identifier (IPUI), device type, user name and display name

On the support server, this information is linked to the existing device-specific information:

- ◆ System-related/device-specific passwords

The base stations and DECT Manager have a LAN connection, which you use to connect the device to your local network via a switch/hub or directly with a router. A VoIP PABX is required for Internet telephony. This must be accessible via the local network and must have network access (to the Internet and/or the analogue or ISDN telephone network). Otherwise it will only be possible to make calls within the LAN.

You also need a PC connected to the local network, so that you can configure your telephone system via the Web configurator.

### Caution

Each base station contains two DECT modules with their own MAC address, which are connected to a LAN port via an integral Ethernet switch.

To prevent security warnings, you will need to allow MAC address cascading on your corporate network.

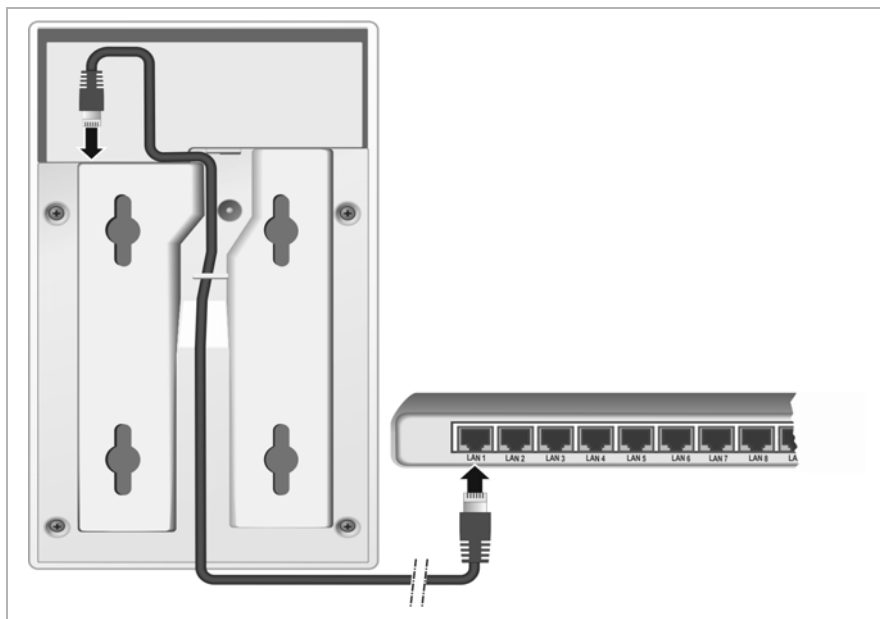

- 1** Insert a plug from the Ethernet cable supplied (Cat 5 with 2 RJ45 modular jacks) into the LAN connection socket at the rear of the device.
- 2** Insert the second Ethernet cable plug into a LAN socket for your local network or on the router.
- 3** Insert the cable into the cable recess provided.

## Mounting devices on the wall

Gigaset N720 IP PRO base stations and Gigaset N720 DM PRO DECT Manager are intended for wall mounting.

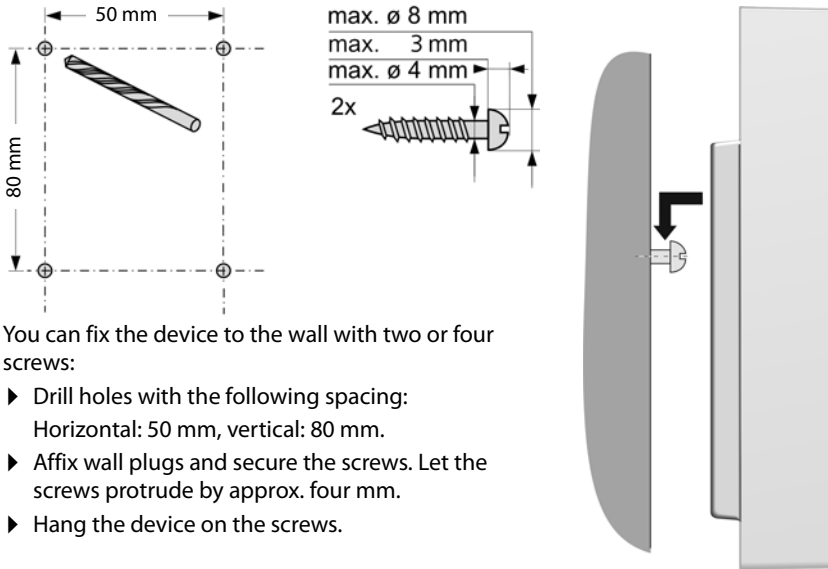

You can fix the device to the wall with two or four screws:

- ▶ Drill holes with the following spacing:  
Horizontal: 50 mm, vertical: 80 mm.
- ▶ Affix wall plugs and secure the screws. Let the screws protrude by approx. four mm.
- ▶ Hang the device on the screws.



## Preparing to use the telephone system

To start using your Gigaset N720 DECT IP Multicell System, you must now perform the following steps:

- ◆ Register base stations to the telephone system and synchronise them
- ◆ Register handsets to the telephone system, configure and assign VoIP accounts

### Registering base stations to the DECT Manager

Before starting to register the base stations, please ensure that you have the installation plans available, which you created during the planning phase of your DECT network.

You need the **MAC address** of the installed base stations and the following planning data:

- ◆ Name, location

You can select any name for the base station. This should contain its location, to enable the relevant Gigaset N720 IP PRO to be found quickly for maintenance purposes.

- ◆ Synchronisation level

Base stations that combine to form a DECT wireless network must synchronise with one another to ensure a smooth transition of the handsets from cell to cell (handover).

As a base station in a multicell DECT network often has an inadequate connection to some of the other base stations, you must set up a synchronisation hierarchy.

Detailed information about synchronisation planning can be found in "Gigaset N720 DECT IP Multicell System - Site Planning and Measurement Guide".

- ◆ Cluster structure

Groups of base stations that are a long way apart must be assigned to different clusters.

#### Please note

Synchronisation always refers to a cluster. You can set up several clusters that are not synchronised with one another, so there is no possibility of a handover between clusters.

To register the base stations, set up clusters and define the synchronisation hierarchy, please use the Web configurator on the DECT Manager. This is described in Section **Configuring the system on the DECT Manager** (→ [page 58](#)).

### Registering base stations

- ▶ Open the Web configurator and log in ( → [page 59](#)).
- ▶ Open the **Preferences** → **Network and connectors** → **Base station registration** page ( → [page 67](#)).

The window shows a list of all DECT base stations connected to the local network which have not yet been registered. The base stations are identified by their MAC address and by the date and time of their initial contact with the system.

- ▶ Register all the base stations that are to belong to your telephone system, as described in section "[Registering base stations](#)".

### Synchronising base stations and forming clusters

- ▶ Open the **Preferences** → **Network and connectors** → **Base station synchronisation** page ( → [page 70](#)).

The registered base stations are displayed.

- ▶ Assign each base station to a cluster.  
If you only want to manage one cluster, assign all the base stations to the same cluster number.
- ▶ Assign the planned synchronisation level to each base station.  
Be aware that synchronisation level one can only be assigned once.
- ▶ Save your settings.

Synchronisation starts automatically. If synchronisation is successful, this is indicated by the **DECT 1 / DECT 2** LEDs on the Gigaset N720 IP PRO base stations ( → [page 23](#)).

### Registering handsets and assigning VoIP accounts

All the handsets to be used for making calls on the Gigaset N720 DECT IP Multicell System must be registered on the DECT Manager. When registering, the handset is permanently assigned a VoIP connection as the receive and send connection.

Up to 100 handsets can be connected.

The following handsets are recommended: Gigaset SL610H PRO, SL400H, S810H, E49H.

Further information relating to the functions of the handsets in connection with the Gigaset base stations can be found in the [Accessories](#) section ( → [page 123](#)) and on the [Service](#) page at [www.gigaset.com/pro/gigasetn720](http://www.gigaset.com/pro/gigasetn720) on the Internet.

## Setting up VoIP connections

Before you start registering the handsets, please make sure that there are sufficient accounts available from your local VoIP PABX or from a VoIP provider, and that you have the login data to hand. You can set up accounts from a maximum of ten different providers.

First configure the VoIP connections.

- ▶ Log in to the Web configurator (→ [page 59](#)).
- ▶ Open the **Settings** → **VoIP providers** page and create an entry for each provider (→ [page 73](#)).

## Registering the handset

Handset registration must be initiated in parallel on the DECT Manager (a) and on the handset (b). To do so, the handset must be located in at least one cell of the DECT network, i.e., close to a base station which is registered on the DECT Manager.

### a) On the DECT Manager

- ▶ Open the Web configurator and log in (→ [page 59](#)).
- ▶ Open the **Settings** → **Handsets** (→ [page 75](#)) page and press the **Add** button. You can decide whether you want to set up a handset with new data, or transfer the data from a handset that has already been set up.
- ▶ Select the VoIP provider from the list and enter the login data for the account the handset is to use to make calls.
- ▶ Start registering the handset for this account.

The DECT Manager is now ready for registering. A registration PIN is generated and displayed.

### b) On the handset

- ▶ Start the registration procedure on the handset in accordance with the handset's user guide.

A message appears on the display stating that the handset is searching for a base that is ready for registration.

If the handset has found a base, you will be asked to enter the registration PIN.

- ▶ Enter the four-digit registration PIN, produced on the DECT Manager, on the handset.

### c) On the DECT Manager

- ▶ Confirm the message **Registration successful**. by clicking **OK**.

Once registration is complete, the handset returns to idle status. The handset name is shown in the display. If not, repeat the procedure.

#### Please note



The handset name is either the **Username** or **Display name** for the VoIP account to which the handset is assigned. You can set this in the Web configurator (→ [page 75](#)).

Immediately after registration, the handset is assigned the VoIP connection as the receive and send connection (incoming calls are signalled on the handset and can be answered).



You can now make calls with the handset.

## First steps

### Displays

- ◆ Reception between the base station and the handset:
  - Good to poor: 
  - No reception:  (red)

If several base stations are within range, the connection quality to the base station with the best reception is displayed.

- ◆ Battery charge status:
  -  (Empty to full)
  -  Flashes red: batteries almost empty
  -  (Charging)
- ◆ Name of the handset

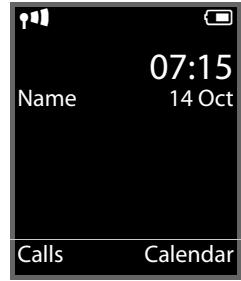

#### Please note

Depending on the device type, you can register your handset on other individual base stations or on a Gigaset N720 DECT IP Multicell System (up to four). Information about this can be found in the user guides for the relevant handsets and base stations.

## How to proceed

Now you have successfully set up your phone, you will want to adapt it to your personal requirements. Use the following guide to quickly locate the most important subjects.

| Information on ...   | ... is located here.      |
|--|---------------------------|
| Making and accepting calls   | ▶ <a href="#">page 29</a> |
| Using the network directories  | ▶ <a href="#">page 39</a> |
| Reading eMails and using info services and network mailboxes   | ▶ <a href="#">page 46</a> |
| Changing the display keys used for quick access to functions   | ▶ <a href="#">page 56</a> |
| Changing settings for phone operation: local area code, external line prefix, dialling plans, voice quality etc. | ▶ <a href="#">page 82</a> |
| Providing directories  | ▶ <a href="#">page 89</a> |
| Providing info services  | ▶ <a href="#">page 88</a> |
| Backing up configuration   | ▶ <a href="#">page 94</a> |

If you have any questions about using your phone, please read the tips on troubleshooting (→ [page 99](#)) or contact our Customer Care team (→ [page 99](#)).

# Operating information

## Light emitting diodes (LED)

### LEDs on the DECT Manager

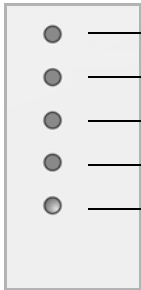

DECT

Power/LAN

VoIP

CALL

RESET

#### From top to bottom

Connection status to the base stations

Power supply status If the power supply is OK, the LED indicates the LAN connection status.

VoIP connections status (activation and registration)

Active call display

Reset button ( → [page 24](#))

| Power/LAN                   | VoIP                         | DECT                         | CALL | Description  |
|-----------------------------|------------------------------|------------------------------|------|--|
| Off                         | Off                          | Off                          | Off  | No power supply / No supply voltage  |
| Flashes (every two seconds) | Off                          | Off                          | Off  | No LAN connection or waiting for address to be assigned by the DHCP server |
| On                          | Off                          | Off                          | Off  | IP address assigned by DHCP, VoIP service not (yet) available              |
| On                          | Flashes (every four seconds) | Off                          | Off  | At least one VoIP service activated, waiting for SIP registration          |
| On                          | On                           | Off                          | Off  | All activated VoIP services successfully registered                        |
| On                          | On                           | Flashes (every four seconds) | Off  | At least one base station connected  |
| On                          | On                           | On                           | Off  | All registered base stations connected                                     |
| On                          | On                           | On                           | On   | At least one active call   |
| Flashes (every two seconds) | Flashes (every two seconds)  | Off                          | Off  | Firmware is being updated  |

#### Other displays:

- ◆ The second LED from the top (**Power/LAN**) flickers when you are restoring the factory settings to indicate that the resetting process will begin as soon as you release the reset button ( → [page 24](#)).
- ◆ All LEDs light up for one second when the device has been successfully reset to static IP addresses ( → [page 25](#)) or to DHCP ( → [page 25](#)).

## LEDs on the base stations

The Gigaset N720 IP PRO base stations contain two DECT modules with separate status displays.



DECT 1

Power/LAN

Power/LAN

DECT 2

RESET

### From top to bottom

Status of DECT module 1

Power supply status. If the power supply is OK, the LED indicates the LAN connection status.

Status of DECT module 2

Reset button ( → [page 24](#))

| Power/LAN 1/2                | DECT 1/2                     | Description  |
|------------------------------|------------------------------|--|
| Off                          | Off                          | No power supply / No supply voltage  |
| Flashes (once a second)      | Off                          | The base station is looking for the DECT Manager                           |
| On                           | Off                          | Connection established to DECT Manager, base station service not yet ready |
| Flashes (every two seconds)  | Off                          | Firmware is being updated, base station service not active                 |
| On                           | On                           | Base station DECT module ready, DECT synchronised                          |
| On                           | Flashes (every four seconds) | Base station DECT module ready, DECT not synchronised                      |
| Flashes (every four seconds) | On                           | Base station DECT module overloaded, DECT synchronised                     |
| Flashes (every four seconds) | Flashes (every four seconds) | Base station DECT module overloaded, DECT not synchronised                 |

### Other displays:

- ◆ The second LED from the top (**Power/LAN**) flickers when you are restoring the factory settings to indicate that the resetting process will begin as soon as you release the reset button ( → [page 24](#)).

### Please note

You can deactivate the base station LED displays using the Web configurator on the DECT Manager ( → [page 93](#)).

## Resetting the device settings

The devices have a reset button that you can use to restore the default device settings.

This button is below the LEDs on the front of the device.



## Resetting the device to factory settings

### Caution

This function resets all the settings you have made. The procedure deletes the saved data from the base stations and handsets. The base station's assignment to the DECT Manager is cancelled.

This operation is available on the DECT Manager and on the base stations.

- ▶ Disconnect the power supply.
- ▶ Press and hold the reset button.
- ▶ Reconnect the device to the mains power supply while the reset button is depressed.
- ▶ Release the reset button again when the second LED from the top (**Power/LAN**) starts flickering.

The device is reset to the factory settings.

### Please note

If the device is powered via PoE, you must remove the LAN cable to interrupt the power supply.

## Resetting the IP configuration and password

The two procedures described below reset the DECT Manager's IP configuration settings and the password for registering on the DECT Manager.

You will need to use this function if you can no longer access the system, e.g., because you have forgotten the password for the Web configurator or you are experiencing problems accessing the LAN.

You can reset the IP configuration either to specific static IP addresses or to dynamic addressing (DHCP). You will then be able to access the DECT Manager again and you can change the password or LAN configuration if required ( → [page 59](#)).

All the LEDs on the DECT Manager light up for one second to confirm that the two resetting processes have been activated successfully.



### Resetting to static IP addresses

- ▶ Press the reset button and hold it for **four** seconds.
- ▶ Release the reset button.
- ▶ Press the reset button again for **four** seconds.
- ▶ Release it again.

The reset is carried out. The IP configuration is now set as follows:

| Parameter                                   | Value for the reset |
|---|---------------------|
| IP address type                             | Static              |
| IP Address DECT Manager                     | 192.168.143.1       |
| Subnet mask                                 | 255.255.0.0         |
| Default Gateway                             | 192.168.1.1         |
| Preferred DNS server, Alternate DNS server  | 192.168.1.1         |
| Password for access to the Web configurator | admin               |
| VLAN Tagging                                | Off                 |

### Resetting to dynamic addressing (DHCP)

This allows you to specify that the DECT Manager will automatically receive an IP address from a DHCP server in the local network.

- ▶ Press the reset button and hold it for **four** seconds.
- ▶ Release the reset button.
- ▶ Press the reset button for **one** second.
- ▶ Release it again.
- ▶ Press the reset button again for **four** seconds.
- ▶ Release it again.

The reset is carried out. The IP configuration is set as follows.

| Parameter                                   | Value for the reset    |
|---|------------------------|
| IP address type                             | Obtained automatically |
| Password for access to the Web configurator | admin                  |
| VLAN Tagging                                | Off                    |

## Menu tree (handsets)

You use the functions of your Gigaset N720 DECT IP Multicell System via a registered handset. The functions of the telephone system are added to the handset menu, as shown below. Handset-specific functions, e.g., local directory or organiser, are not described here. Information about this will be found in the relevant handset user guide. The availability of functions or their designations may differ on individual handsets.

On some Gigaset handsets, you can choose between **Simplified** (standard mode) and **Complete** (expert mode) menu views. Menu options that are only available in expert mode are marked with the  icon.

To open the main menu: press  when the handset is in **idle status**:

|   |                        |                        |                           |   |
|---|------------------------|------------------------|---------------------------|---|
|  | <b>Select Services</b> | <b>Next Call Anon.</b> | → <a href="#">page 35</a> | Only functions supported by the PABX are available. |
|   |                        | <b>Call Divert</b>     | → <a href="#">page 37</a> |   |
|   |                        | <b>Call Waiting</b>    | → <a href="#">page 37</a> |   |
|   |                        | <b>Do Not Disturb</b>  | → <a href="#">page 38</a> |   |
|   |                        | <b>Ringback Off</b>    | → <a href="#">page 33</a> |   |

Depending on the PABX, additional services may be offered.

|   |                    |   |
|---|--------------------|---|
|  | <b>Info Centre</b> | List of available info services → <a href="#">page 52</a> |
|---|--------------------|---|

**Please note:** The Info Centre on the Gigaset C610H handset can be found in the **Additional Features** menu.

  

|   |                            |                                  |
|---|----------------------------|----------------------------------|
|  | <b>Additional Features</b> | See user guide for your handset. |
|---|----------------------------|----------------------------------|

  

|   |                   |                       |                           |
|---|-------------------|-----------------------|---------------------------|
|  | <b>Call Lists</b> | <b>All Calls</b>      | → <a href="#">page 44</a> |
|   |                   | <b>Outgoing calls</b> | → <a href="#">page 44</a> |
|   |                   | <b>Accepted calls</b> | → <a href="#">page 44</a> |
|   |                   | <b>Missed calls</b>   | → <a href="#">page 44</a> |

  

|   |                  |              |                           |
|---|------------------|--------------|---------------------------|
|  | <b>Messaging</b> | <b>eMail</b> | → <a href="#">page 48</a> |
|---|------------------|--------------|---------------------------|

  

|   |                   |                      |                           |
|---|-------------------|----------------------|---------------------------|
|  | <b>Voice Mail</b> | <b>Play Messages</b> | → <a href="#">page 47</a> |
|---|-------------------|----------------------|---------------------------|

  

|   |                  |                                  |
|---|------------------|----------------------------------|
|  | <b>Organiser</b> | See user guide for your handset. |
|---|------------------|----------------------------------|

|   |                 |                        |  |
|---|-----------------|------------------------|--|
|  | <b>Contacts</b> | <b>Directory</b>       | Information on local directory: see user guide for your handset.             |
|   |                 | <b>Net Directories</b> | List of available public and corporate directories → <a href="#">page 39</a> |

|   |                 |  |
|---|-----------------|--|
|  | <b>Settings</b> | → <a href="#">page 56</a> Default settings: see user guide for your handset. |
|---|-----------------|--|

## Understanding the operating steps

The operating steps have been shortened and are based on a Gigaset SL610H PRO handset.

### Example:

The display:

 →  **Select Services** → **Do Not Disturb** (☑ = on)

means:

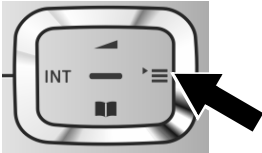

- ▶ Press **right** on the control key  to open the main menu.



- ▶ Press right, left, down and up on the control key  to navigate to the **Select Services** submenu.

- ▶ Press the display key **OK** to confirm your selection.



- ▶ Press down on the control key  until the **Do Not Disturb** menu option is highlighted.

- ▶ Press the display key **Change** to activate/deactivate the function.

## Operating information



The change is effective immediately and does not need to be confirmed.

- ▶ Press the key below **Back** to skip back to the previous menu level.
- Or**
- ▶ Press and **hold** the end call key  to return to idle status.

# Making calls

You can make calls using any handset registered to your Gigaset N720 DECT IP Multicell System. **Prerequisite:** You are located in the cell of at least one of the base stations registered to the telephone system.

The cells of the base stations together form the DECT wireless network of the telephone system. You can initiate or answer calls on a handset across the whole wireless network and change cells during a call (handover). **Prerequisite for handover:** The base stations involved must be assigned to the same cluster and must be synchronised ( → [page 67](#)).

Each handset is assigned a send and receive connection ( → [page 76](#)).

If your Gigaset N720 DECT IP Multicell System is connected to a PABX that permits the formation of groups, VoIP connections can also be assigned to groups. In this case, you will also receive calls on your handset that have been sent to your group number.

The Gigaset N720 DECT IP Multicell System uses a VoIP PABX or the services of a VoIP provider for Internet telephony. The availability of some phone functions depends on whether they are supported by the PABX/provider and whether they have been enabled. If necessary, you can obtain a description of the services from the operator of your PABX.

## Please note

Depending on the specifications of your PABX, you may need to dial an access code for calls outside the area covered by your VoIP PABX ( → [page 82](#)).

## Calling





Enter the number and press the talk key. The number is dialled.

Or:



Press and **hold** the talk key  and then enter the number.

Instead of the talk key , you can also press the speaker key  on the handset to make a call in speaker mode.

In this user guide, each of these variants is indicated by "Press the talk key ".

The dialled number is shown on the display.

## Please note

If you use VoIP to make a call to the fixed line network, you may also have to dial the area code for local calls (depending on the PABX/provider). This is not necessary if the area code is entered in the configuration on the DECT Manager and the **Activating the area code for local calls using VoIP** option is enabled (see Web configurator → [page 83](#)).

### Please note

- ◆ You can cancel the dialling process with the end call key .
- ◆ You can see the duration of the call while the call is in progress.
- ◆ Dialling using the directories (→ [page 39](#)) or the call and redial lists (→ [page 44](#)) saves you entering numbers repeatedly.
- ◆ If all the Gigaset N720 DECT IP Multicell System connections are busy, the error message **Operation failed!** is displayed.
- ◆ If all connections to the base station connected to your handset are busy, ". . ." is shown on the display. The idle display then appears again.

## Displaying the phone number you are calling (COLP)

### Prerequisites:

- ◆ Your PABX/provider supports COLP (**C**onnect**L**ine **I**dentification **P**resentation). You may need to activate COLP.
- ◆ The called party has not activated COLR (**C**onnect**L**ine **I**dentification **R**estriction).

For outgoing calls, the phone number of the connection on which the call is received is displayed on the handset.

The displayed number may differ from the number you have dialled. Examples:

- ◆ The called party has activated call divert.
- ◆ The call is answered by another connection within a PABX system.

If there is an entry in the directory for this phone number, the corresponding name is displayed.

### Please note



- ◆ The actual number of the connection you have reached (or the assigned name) is displayed instead of the called number during call swapping and consultation calls.
- ◆ When the phone number is copied to the directory and the redial list, the dialled number (not the displayed number) is copied.

## Ending a call





Press the end call key.

## Accepting a call

An incoming call on a Gigaset handset is indicated in three ways: by ringing, by a display on the screen and by the flashing  and  keys.

You can accept the call on the handset in the following ways:

- ▶ Press the talk key  to make the call via the receiver.
- ▶ Press the speaker key  to make the call via the loudspeaker.
- ▶ To deactivate the ringtone, press the **Silence** display key. You can accept the call as long as it is displayed on the screen.

Press the display key **Reject** or the end call key  to reject a call.

## Calling Line Identification

When you receive a call, the caller's number or name is displayed if the following prerequisites are met.

- ◆ Your PABX/provider supports CLIP, CLI and CNIP.
  - CLI (Calling Line Identification): the caller's number is transmitted.
  - CLIP (Calling Line Identification Presentation): the caller's number is displayed.
  - CNIP (Calling Name Identification Presentation): the caller's name is displayed.
- ◆ You have requested CLIP or CNIP from your provider.
- ◆ The caller has requested CLI from the provider.

## Call display

Example of display:

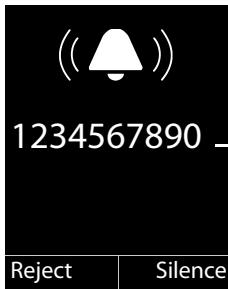

Gigaset SL610H PRO handset  
on Gigaset N720 DECT IP Multicell System

Caller's number or name (via CLIP)  
If no number is transmitted, **External** is displayed.

If the caller's number is in the handset's directory, the caller's name will be shown. If an image has been stored, this will also be displayed.

## Display with CNIP

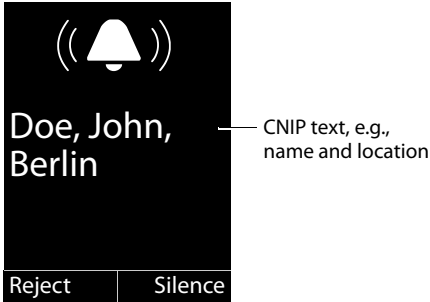

If you have CNIP, the CNIP information registered with your provider for the caller's number will be displayed, e.g., the name and, if applicable, the location.

## Display with CNIP and CLIP

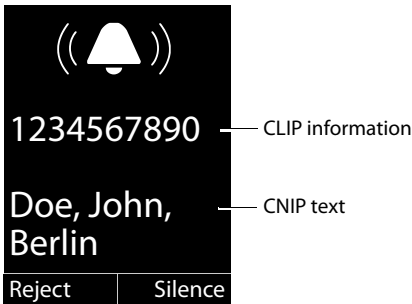

If CLIP and CNIP are activated, the respective details are displayed one below the other.

If the number of the caller is stored in your directory, the CLIP display is replaced by the corresponding directory entry.

## Notes on phone number display (CLIP)

By default, the number of the caller is shown on the handset of your Gigaset telephone. You do not have to make any other settings on your Gigaset telephone.

**However, if the caller's number is not displayed, this can be due to the following:**

- ◆ You have not requested CLIP from your provider
- ◆ The PABX connected to the Gigaset N720 DECT IP Multicell System is not forwarding all the information.
- ▶ Check the CLIP (phone number display) settings of your PABX and activate this function if necessary. In the user manual for the device, search for the term "CLIP" (or an alternative term such as "calling line identification", "phone number identification", "caller ID" etc.). If necessary, contact the device manufacturer/supplier.
- ▶ Check whether your provider supports phone number display (CLIP) and that the function has been activated for you. If necessary, contact your provider.



## Call waiting during a call

If you get another call while conducting a call, you will hear the call waiting tone (short tone). If you have calling line identification (CLIP), the number of the waiting caller or the corresponding directory entry is displayed. The caller will hear the ringing tone.

You have the following options:

### Rejecting a call

**Reject** Press the display key.

The call waiting tone is turned off. You remain connected to the first participant. The other caller will hear the busy tone.

### Accepting the call/putting the first party on hold

**Accept** Press the display key.

You are connected to the caller. The first call is placed on **hold**.

► Use  to switch between the participants (call swapping → [page 34](#)).

### Accept the call/end the first call

 Press the end call key.

The call is signalled as an incoming call. You can accept the call ( → [page 31](#)).

#### Please note

You can deactivate call waiting while a call is in progress ( → [page 37](#)).

## Initiating ringback

If the number you have called is engaged, you can arrange a ringback if your PABX/provider supports this function.

**Ringback** Press the display key to arrange for a ringback.

Ringback is initiated as soon as the line is free again.

### Switching off ringback

If you decide you do not want a ringback, you can switch the function off again.

 →  **Select Services** → **Ringback Off**

### Initiating a consultation call

You are talking to one participant and can call a second participant at the same time for consultation.

You are conducting a call:



Press the Recall key. This is only possible if the Recall key is enabled for call transfer (→ [page 85](#)).

Or:



Press the display key.

The previous call is placed on hold. The participant hears an announcement or on-hold music, if this is set up on the VoIP PABX.



Enter the second participant's telephone number.

The phone number is dialled. You are connected to the second participant.

If the participant does not answer, select the display key **End** to return to the first participant.

#### Please note

You can also select the second participant's phone number from a directory, the redial list or a call list on the handset.

### Ending a consultation call

**Options** → **End active call**

You are reconnected to the first call participant.

You can also end a consultation call by pressing the end call key . The connection is briefly interrupted and you will receive a recall. As soon as you answer the call, you are reconnected to the first call participant.

**Prerequisite:** Transfer Call by On-Hook is not activated ("Transfer Call by On-Hook" → [page 85](#)).

### Call swapping

You can speak to two callers one at a time (call swap).

**Prerequisite:** You are conducting a call and have called a second participant (consultation call) or have accepted a waiting call.

► Use  to swap between the participants.

The caller you are currently speaking to is marked with the  icon.

### Ending a currently active call

**Options** → **End active call**

You are reconnected to the waiting caller.

## Transferring a call to another subscriber

You can transfer (connect) a call to another subscriber if your PABX/provider supports this function.

You are conducting a call:

- ▶ Set up a consultation call (→ [page 34](#)).

When the participant answers:

- ▶ Announce the call, if necessary.



Press the end call key.

The call on hold is transferred to the other participant's number.

**Prerequisite:** Transfer Call by On-Hook is activated ("**Transfer Call by On-Hook**" → [page 85](#)).

If the internal participant does **not** answer or the line is busy, press the **End** display key to return to the first call.

You can also press the end call key  when forwarding a call before the second participant picks up the call.

## "Anonymous calling"

You can withhold your phone number for the next call (CLIR = Calling Line Identification Restriction).

In idle status:



→ **Select Services → Next Call Anon.**

Select and press **OK**.



Enter the number or copy from the directory.

**Dial Number** /



Press the display or talk key. The number is dialled.

## Gigaset HDSP – telephony with brilliant sound quality



Your Gigaset telephone supports the G.722 wideband codec so you can use it to make calls with brilliant sound quality (High Definition Sound Performance).

The following are prerequisites for wideband connections on your telephone:

- You make the call from a wideband-capable handset.
- The G.722 codec is enabled for the phone system and selected for the handset (→ [page 78](#)).
- Your PABX/VoIP provider supports wideband connections.
- The recipient's phone supports codec G.722 and accepts the establishment of a wideband connection.

### **Please note**

Wideband telephony using the G.722 codec must be enabled in the DECT Manager Web configurator → [page 84](#). This setting applies to the entire Gigaset N720 DECT IP Multicell System. If wideband telephony is enabled, a maximum of four calls can be conducted simultaneously per base station (eight in narrowband mode).

# Setting phone functions

---

## Activating/deactivating call waiting for calls

If the function is activated during a call, you will hear a call waiting tone to signal that another caller is trying to get through (→ [page 33](#)).

When call waiting is deactivated, the caller will hear the busy tone if you are already making a call.

### Activating/deactivating call waiting

 →  **Select Services**

 Press the control key to select **Call Waiting**.

**Change** Press the display key to activate/deactivate the function ( = on).

## Using call forwarding (CF)

When forwarding a call, the call is diverted to another connection. You can use call forwarding as a Gigaset N720 DECT IP Multicell System function or as a service offered by the VoIP PABX/provider.

 →  **Select Services** → **Call Divert**

▶ You can enter data as follows:

### Status

Select **On/Off** to activate/deactivate **Call Divert**.

### Phone Number

Enter the number to which the call is to be diverted. You can enter a fixed line, VoIP or mobile number.

### When

Select **All Calls/When Busy/No Answer**.

**All Calls:** Calls are diverted immediately i.e., no more calls are signalled on your phone.

**No Answer:** Calls are diverted if no one accepts the call within several rings.

**When Busy:** Calls are diverted when your line is busy.

If the service is provided via the DECT Manager:

**OK** Press the display key to activate the call forwarding function.

If you are using the service offered by the VoIP PABX or a provider:

**Send** Press the display key.

### Please note

- ◆ Any call for the handset that has been diverted is entered in the call lists.
- ◆ If a call is forwarded to a participant who is not available (e.g., because their handset is switched off), the call is rejected after a short time.

## Do not disturb

You can activate the Do Not Disturb (DND) function if you do not want to receive any calls and you do not want the phone to ring, if your PABX/provider supports this function. You can still make calls when this function is activated.

 →  **Select Services** → **Do Not Disturb**

**Status**      Select **On/Off** to activate/deactivate this function.

▶ Press the display key **Send**.

# Using directories

The options are:

- ◆ The (local) directory for your handset (see handset user guide)
- ◆ Public online and classified directories ( → [page 41](#))
- ◆ Online directories, provided by a PABX, e.g., a corporate directory and/or a private directory ( → [page 40](#))

The directories available are defined by the Web configurator of the DECT Manager ( → [page 89](#)).

## Opening directories using the directory key

The directory key  (press down on the control key) for the handset is normally set as follows:

- ◆ Press **briefly** to open the local directory
- ◆ Press and **hold** to open the selection of available online directories.

This assignment can be changed for each handset via the Web configurator on the DECT Manager ( → [page 77](#)). The action "Press directory key briefly" can be assigned to a specific online directory. In this case, open the local directory by pressing and holding the directory key.





The description below assumes the default assignment.

## Opening the corporate directory using the INT key

The INT key  (press left on control key) on the handsets opens a corporate directory, provided that this is set up via the Web configurator and can be accessed by the DECT Manager. The directory to be opened can be set for each handset on the DECT Manager ( → [page 77](#)).

## Opening directories via the menu

You can access all available directories via the handset's menu:

- |   |   |                 |                          |   |
|---|---|-----------------|--------------------------|---|
|   | →   | <b>Contacts</b> | → <b>Directory</b>       | Local directory   |
|  | →  | <b>Contacts</b> | → <b>Net Directories</b> | List of all online directories set up on the DECT Manager |

The directories are displayed with the names specified in the Web configurator.

### Please note

If handsets are connected to a Gigaset N720 DECT IP Multicell System, it is not possible to transfer entries from the local directory to another handset.

The administrator can use the Web configurator on the DECT Manager to transfer a handset's local directory to a PC and to load the directory to other handsets from there ( → [page 79](#)).

### Using corporate directories

You can use directories made available by a server in the corporate network on your handset. The following formats are possible:

- ◆ Directory in LDAP format (LDAP = Lightweight Directory Access Protocol)
- ◆ Directory in XML format
- ◆ Personal directory in XML format

**Prerequisite:**

- ◆ The directories are available in the valid XML or LDAP format.
- ◆ They are configured and enabled on the DECT Manager ( → [page 91](#)).



### Opening the directory

**Prerequisite:** The handset is in idle status.

 Press the control key (INT).

The directory opened is the one set to be opened via the INT key in the DECT Manager for your handset ( → [page 77](#)).

Or:

 →  **Contacts** → **Network Directory**

All available online directories are displayed.

 Select a directory and press **OK**.

### Searching for and displaying an entry

 Scroll to the required entry.

Or:



Enter the name (or first few letters).

As soon as you press a key on the keypad, the phone goes into search mode. You can enter up to eight characters. The first entry in the list which matches your entry is displayed.

 If there are several matching entries, scroll to the desired entry.

▶ Press the display key **View** or  to display the entry.

### Dialling a number from a corporate directory

The corporate directory is opened using the INT key  (press left on control key).

 Open a corporate directory.

 Select an entry.

 Press the talk key. The number is dialled.

You hear the busy tone if:

- ◆ The phone being called is not available (handset switched off, out of range).
- ◆ The call is not answered within a certain time (specified on the PABX).



## Using online directories

You can use public online directories (online directories and classified directories, e.g., "Yellow Pages"). **Prerequisite:** The online directories are enabled on the DECT Manager (→ [page 89](#)) and the DECT Manager can access the Internet via its LAN connection.

### Exclusion of liability



This service is country-specific. Gigaset Communications GmbH assumes no guarantee or liability for the availability of this service.  
The service may be discontinued at any time.

### Opening an online directory/Yellow Pages

**Prerequisite:** The handset is in idle status.

 Press and **hold**.

Or:

 →  **Contacts** → **Network Directory**

This opens the list of online directories.

 Select a directory (online directory or Yellow Pages) from the list and press **OK**.

This establishes a connection to the online directory or the Yellow Pages.

If there is only online net directory available, a connection is immediately established if you press and **hold** down the control key .

### Searching for an entry

**Prerequisite:** You have opened the online directory/Yellow Pages.

► You can enter data in the following fields:

**Surname:** (Online directory) or

**Category/Name:** (Yellow Pages)

Enter the name, part of a name or the category (max. 30 characters).

**City:** Enter the name of the city/location in which the party you are searching for lives (max. 30 characters).

If you have already completed a search, the names of the cities you last entered are displayed (maximum of five).

You can enter a new name or select one of the city names displayed using  and confirm with **OK**.

Or:

**Number:** Enter the number (max. 30 characters).

► Press the display key **Search** or  to start the search.

You must make an entry in either **Surname** or **Category/Name**: and in **City**, or in **Number**. Searching by number is only possible if supported by the net directory you have selected.

### Please note

Instructions for entering text on your handset are set out in the handset user guide.

## Using directories

A list of the cities/locations found is displayed if the search returns more than one result:



Select city.

If the name of a city/location is longer than one line, it is abbreviated. Select **View** to view the complete name.

If no matching city is found: press **Change** to change the search criteria. The entries for **Category/Name** and **City** are copied and you can change them.

**Search**

Press the display key to continue the search.

A corresponding message will appear on the display if no party is found to match the search criteria. You have the following options:

▶ Press the display key **New** to start a new search.

Or

▶ Press the display key **Change** to change the search criteria. The name and city/location are copied over and you can change them.

No hits are displayed if the list of hits is too large. A message to this effect is displayed.

▶ Press the display key **Refine** to start a refined search (→ [page 43](#)).

Or

▶ Depending on the provider, you can view the list if the number of hits is displayed. Press the display key **View**.



## Search result (hit list)

The search result is shown as a list on the display. Example:



1. 1/50: Consecutive number/total number of hits (only the consecutive number is displayed if the total number of hits >99).
2. Four lines including party's name, category, telephone number and address (possibly abbreviated). If a fixed line number is not available, the mobile number (if available) is displayed.

You have the following options:

- ▶ You can scroll through the list with .
- ▶ Press the display key **View**. This displays the full details of the entry (name, category where applicable, address, telephone numbers). You can scroll through the entry with .

Use **Options** to access the following options:

#### Refine Search

Refine search criteria and restrict hit list (→ [page 43](#)).

#### New Search

Start a new search.

#### Copy to Directory

Copy an entry to the local directory. If an entry contains several numbers, they are displayed in a selection list. A new entry is created for the selected number. The surname is transferred to the **Surname** field of the local directory.

## Calling subscribers

**Prerequisite:** A hit list is displayed.

- ▶ Select the entry and press the talk key .

If the entry only contains one phone number, this is the one that is dialled.

A list of numbers appears if there is more than one number.

- ▶ Using , select a number and press the display key **Dial**.

## Starting a refined search

You can use the search options available in the refined search (first name and/or street) to limit the number of hits returned by a previous search.

**Prerequisite:** A search result is displayed (hit list with multiple entries or a message indicating too many hits).

**Refine** Press the display key.

Or

**Options** → **Refine Search**  
Select and press **OK**.

The search criteria from the previous search are copied and entered in the corresponding fields.

**Surname:** (Online directory) or

**Category/Name:** (Yellow Pages)

If necessary, change the name/business type or enter additional details.

**City:** Name of the city from the previous search is shown (cannot be changed).

**Street:** If necessary, change the name of the street (max. 30 characters).

**First Name:** (only in the online directory)



If necessary, enter the first name (max. 30 characters).

**Search** Start refined search.

# Using the call lists

The following call lists are available:

- All Calls** All outgoing, accepted and missed calls.
- Outgoing calls** The last 20 numbers dialled (redial list).
- Accepted calls** Calls that were answered (max. 15).
- Missed calls** Calls that were not answered (max. 15).

If the list contains entries that you have not yet viewed, the display shows the  icon and the number of new entries. The list can also be accessed via the message key  (→ [page 46](#)).

Calls are stored in the lists in chronological order. When the maximum number is reached, the next entry overwrites the oldest one. Incoming calls can only be stored if the CLIP information is provided (→ [page 31](#)).

## Viewing entries

You can open the call lists in idle status:



 Press the display key

Or via the menu:



 Select the required list and press **OK**.



### Please note

You can also open the redial list (outgoing calls) by pressing the talk key . The list of missed calls can also be opened by pressing the message key .

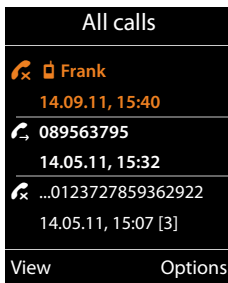
## List entry



The calls are displayed in chronological order, from the most recent through to the oldest.

An icon is shown in front of each entry to indicate whether it is an outgoing () , accepted () or missed () call.

### Information on the entry:

- ◆ List type (in header)
- ◆ Status of entry, **bold**: new entry
- ◆ Number or name of caller
- ◆ Date and time of call (if set).

- ◆ Phone number of the caller/called party. If the number is saved in the local directory, the name is displayed. If the number is not in the local directory, the corporate directories are searched.
- ◆ Date and time of the call. For missed calls, the number of attempts is also indicated.

The information displayed is determined by the information transferred by the caller and whether or not the caller appears in the directory.

If the caller has activated CLIP (= Calling Line Identification Presentation), the caller's phone number is identified. The caller can then be identified by this number if he or she is saved in a directory.

### Displaying detailed information

 Press the display key. The information available is displayed, with the phone number as a minimum.

## Dialling a number from a list

You have the following options for dialling a phone number from a list:

 Scroll through the list to the required name.

 Press the talk key. The number is dialled.

Or:

 Press the display key to show the entry.

 Press the talk key. The number is dialled.

## Copying an entry from the call list to the local directory.

 Scroll through the list to the required entry.

 Press the display key.

 Select **Copy to Directory** and press  to confirm.

The directory opens. You can create a new entry in the directory or edit an existing one.

## Deleting an entry/list

 If you want to delete a particular entry, scroll through the list to the relevant entry.

 Press the display key.

 Select **Delete entry** or **Delete All** and press  to confirm.

You must confirm the action again.

## Displaying messages

---

The following types of messages are displayed:

- ◆ Voice mails on network mailboxes (see below)
- ◆ Missed calls ( → [page 44](#))
- ◆ eMails ( → [page 48](#))
- ◆ Missed appointments (see user guide for your handset)

The message key  provides access to all your messages.

Receipt of a new message is indicated as follows:

- ◆ By the message key  flashing
- ◆ By an icon on the idle display:

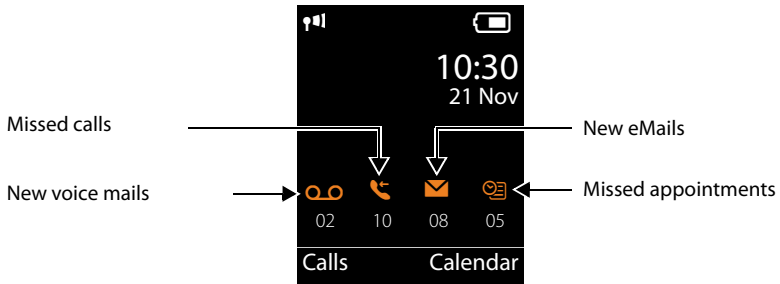



## Using the network mailbox

Your VoIP PABX/provider offers answering machines on the network, known as network mailboxes.

Each network mailbox accepts incoming calls made via the corresponding line (VoIP phone number). To record all calls, a network mailbox must be set up for each VoIP connection.

The network mailbox is configured for each handset using the Web configurator on the DECT Manager and can also only be activated or deactivated there ( → [page 77](#)).

## Displaying new messages in the handset's idle display

If a new message is present on the network mailbox assigned to the handset, the  icon and the number of new messages are shown on the idle display. The  message key flashes.

## Playing back a message

### Calling the network mailbox via fast access

 Press and **hold**.

You are connected straight to the network mailbox.

 If necessary, press the speaker key.

You will hear the network mailbox announcement.

### Calling the network mailbox via the menu

 →  Voice Mail → Play Messages

You are connected straight to the network mailbox.

### Calling the network mailbox using the message key

Under the message key  you will find a list of the different types of message, e.g., missed calls, eMail or network mailbox.

The following is displayed (Gigaset SL610H PRO as an example):

| Messages & Calls       |            |
|------------------------|------------|
| ...                    | (4)        |
| <b>Network Mailbox</b> | <b>(2)</b> |
| ...                    | (3)        |
| Back                   | OK         |

If there are new messages in the network mailbox, the list entry is shown in bold. The number of new messages is shown in brackets following the list entry.

If there are no new messages, no number is shown after the list entry for the network mailbox. The number of messages stored in the network mailbox is not displayed.

 Press the message key.

 Select the network mailbox entry and press **OK**.

You are connected directly to the network mailbox and can hear its announcement.

Messages can generally be played back using your handset keypad (digit codes). Listen to the announcement.



#### Please note

- ◆ The network mailbox is automatically called via the corresponding connection. An automatic area code specific to your phone is **not** prefixed.
- ◆ Network mailbox messages can generally be played back using your phone's keypad (digit codes). For VoIP, you need to define how the digit codes should be converted to DTMF signals and transmitted ( → [page 84](#)).

# eMail notifications

You can receive eMail-messages on your handset if the name of the incoming eMail server and your personal access data (account name, password) have been stored on the DECT Manager using the Web configurator and you have specified that you want to be notified when a new eMail arrives ( → [page 81](#)).

**Prerequisite:** The telephone system connects to the incoming eMail servers regularly and checks for new messages. This connection is made every 15 minutes by default, although the administrator can change this default setting ( → [page 75](#)).

Your handset display will show when a new eMail message has been received. On the Gigaset SL610 PRO, for example, an advisory tone sounds, the message key  flashes and the  symbol is displayed in the idle display.

### Please note

If new eMail messages have been received, pressing the message key  will display them in the eMail list.

Using the handset, you can display the sender, date/time of receipt, the subject and the message text (abbreviated if necessary) for each eMail in the incoming eMail list ( → [page 48](#)).

### Please note

If you have also activated the authentication of the phone with the incoming eMail server via a secure connection in the Web configurator (TLS authentication) and this fails, the eMail messages are not downloaded to your phone.

In this case, pressing the flashing message key  will display the message **Certificate error** -.

- ▶ Press the display key **OK** to confirm the message.
- ▶ The **Security Settings** Web page on the DECT Manager ( → [page 71](#)) tells you why the secure connection could not be established and what you can do.

## Opening the incoming eMail list

### Prerequisites:

- ◆ You have set up an eMail account with a provider.
- ◆ The incoming eMail server uses the POP3 protocol.
- ◆ The name of the incoming eMail server and your personal access data (account name, password) are stored in the DECT Manager for your handset ( → [page 81](#)).

On the handset:

 →  **Messaging** → **eMail**

Or, if new eMail messages have been received (message key  flashes):

 → **eMail**

The phone establishes a connection to the incoming eMail server. A list of eMail messages that are stored there is displayed.



New unread messages appear above old read messages. The most recent entry appears at the head of the list.

The following details are displayed for each eMail: name or eMail address of the sender (one line, abbreviated if necessary) and date and time (date and time will only display correct values if sender and recipient are located in the same time zone).

Example display on the Gigaset SL610H PRO handset:

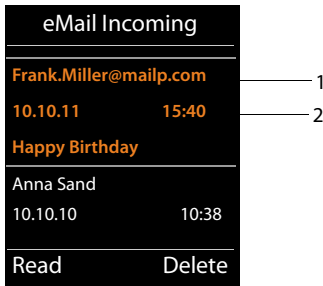

1 eMail address or name transmitted by the sender (abbreviated if necessary)

**Bold:** new message.

All eMail messages that were not on the incoming eMail server when the inbox was last opened are identified as "new". All other eMails are not marked, regardless of whether or not they have been read.

2 Date and time of receipt of eMail message

If the inbox on the incoming eMail server is empty, **No entries** will appear in the display.

### Please note

Many eMail providers activate spam protection measures by default. eMail messages classified as spam are stored in a separate folder and are therefore not shown in the incoming eMail list.

Some eMail providers allow you to deactivate spam protection or show spam eMails in the incoming mail list.

Other eMail providers may send a message to the inbox when a new spam eMail is received. This is to inform you that a suspected spam eMail has been received.

The date and sender of this mail are repeatedly updated, so that it is always displayed as a new message.

## Messages when establishing a connection

The following problems may occur when connecting to the incoming eMail server. The messages are displayed in the display for a few seconds.

### Server not accessible

The connection to the incoming eMail server could not be established. This may have the following causes:

- Incorrect entry for the name of the incoming eMail server ( → Web configurator, → **page 81**).

## Displaying messages

- Temporary problems with the incoming eMail server (server is down or is not connected to the Internet).
  - ▶ Check settings in the Web configurator.
  - ▶ Try again later.

### Currently not possible

The resources required by your phone to make the connection are busy, e.g., because the maximum permitted number of DECT connections has already been reached.

- ▶ Try again later.

### Login failed

Error when logging in to the incoming eMail server. This may have the following cause:

- Incorrect entries for name of incoming eMail server, user name and/or password.
  - ▶ Check settings ( → Web configurator, → **page 81**).
- The eMail provider may only permit POP3 access at certain intervals.
  - ▶ Try again a few moments later.

### Mailbox settings incomplete

Incomplete entries for name of incoming eMail server, user name and/or password.

- ▶ Check/add to settings ( → Web configurator).

## Viewing the message header and text of an eMail

**Prerequisite:** You have opened the incoming mail list ( → **page 48**).

 Select an eMail entry.

**Read**  Press the display key.

The subject of the eMail (maximum 120 characters) and the first few characters of the text are displayed.

Example display on the Gigaset SL610H PRO handset:

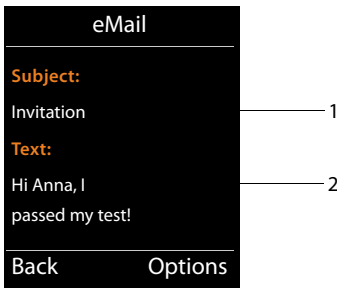

- 1 **Subject** of the eMail message. A maximum of 120 characters are displayed.
- 2 **Text** of the eMail message (abbreviated if necessary).

 Press the end call key to return to the incoming message list.

### Please note

If the eMail contains anything other than text, the message **eMail can't be displayed** will briefly appear.

## Viewing eMail sender's address

**Prerequisite:** You have opened the eMail notification to read it ( → [page 50](#)).

**Options** → **From**

Select and press **OK**.

The sender's eMail address is displayed, over several lines if necessary (maximum 60 lines).

**Back**

Press the display key to return to the incoming message list.

Example display on the Gigaset SL610H PRO handset:

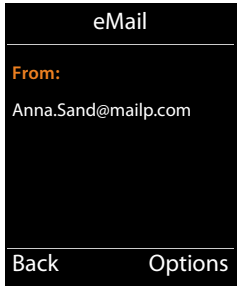

## Deleting eMail messages

**Prerequisite:** You have opened the incoming eMail list ( → [page 48](#)) or the header or sender's address for an eMail is displayed ( → [page 50](#)):

**Options** → **Delete**

Select and press **OK**.

**Yes**

Press the display key to confirm the security prompt.

The eMail is deleted from the incoming eMail server.

## Info centre – continuous Internet access from your phone

---

You can use your phone to request info services provided specifically for the phone. The services available are set via the Web configurator on the DECT Manager ( → [page 88](#)).

Info services can be:

- ◆ Online content from the Internet
- ◆ Information provided about the PABX.

### — Please note —

You can launch the info centre and display info services with any registered Gigaset SL610H PRO, C610H, SL400H, S810H and E49H handset.

With some of these handsets, you can launch the info centre directly from the main menu. For others (e.g., Gigaset C610H), you will find the info centre in the submenu

★ **Additional Features.**

## Starting the info centre, selecting info services

You can select info services (applications, apps) made available by the server.

Examples:

On the Gigaset SL610H PRO, S810H and SL400H handsets:

 →  **Info Centre**

On the Gigaset C610H handset:

 → ★ **Additional Features** → **Info Centre**

Your info centre menu i.e., a list of available info services is displayed. You can navigate between the info services.

 Select the info service and press **OK**.

To access certain info services (personalised services), you have to log in with a user name and password. In this case, enter your access data as described in the "[Login for personalised info services](#)" section on [page 53](#).

## Messages when loading requested information

The information is loaded from the Internet. Wait a few seconds until the information is displayed. The display shows **Please wait....**

If the information for an info service cannot be displayed, one of the following messages appears:

### Requested page can't be reached.

Possible causes of this are:

- ◆ Time limit exceeded (timeout) when loading the information
- ◆ The Internet server for the info services cannot be accessed.
- ▶ Check your Internet connection and repeat the request at a later date.

### Coding error on requested page

The content of the requested info service is coded in a format that the handset cannot display.

### Can't display requested page

General error when loading the info service.

### Login failed.

Login has failed. Possible causes of this are:

- ◆ You have not entered your login data correctly.
  - ▶ Reselect the info service and repeat the login process. Please remember that data is case sensitive.
- ◆ You are not entitled to access this info service.

## Login for personalised info services

If a special login process with user name and password is required to access an info service, the following is displayed after the service has been called up:

### Authent. Name

Enter the username supplied by the provider of the info service.

**Save**

Press the display key.

### Password

Enter the password associated with this username.

**Save**

Press the display key.

If login was successful, the requested info service is displayed.

If login failed, a message to this effect appears on the display → **Messages when loading requested information, page 53.**



### Please note

Please remember that login data is case sensitive. General instructions on entering text can be found in the handset user guide.

## Operating the info centre

Depending on the type of info service requested, you can perform the following operations:

### Scrolling within an info service

- ▶ You can use  to scroll downwards within an info service, and  to scroll up (back).

### Skipping back to the previous page

- ▶ Press the left display key.

### Skipping back to the info centre menu

- ▶ Briefly press the end call key .

You want to go offline:



Press and hold the end call key ; the handset returns to idle status.

## Selecting a hyperlink

### Hyperlink to further information:



If the page contains a hyperlink to further information, this is indicated by the  icon.

If a page with hyperlinks is opened, the first hyperlink is highlighted.

- ▶ Using the control keys ( and/or ) as required, you can navigate to the hyperlink that you would like to select. The hyperlink is then highlighted by bars.
- ▶ Press the right display key **Link** to open the relevant page.

### Hyperlink to a phone number:

If a hyperlink contains a phone number, you can copy the number to the local directory or call the number directly (Click-2-Call functionality).

- ▶ Select the hyperlink using the  and/or  keys, as required.
- ▶ You can identify a hyperlink of this type by the fact that **call** is shown above the right display key.
- ▶ Press the display key  to copy the phone number to the local directory on your handset.

Or:

- ▶ Press **call** to call the stored number.

Depending on the provider, if you press **call**,

- ◆ The number is dialled directly
- ◆ The number appears first in the display, in which case you must first confirm the number before it is dialled.
  - ▶ If you press **Yes**, the number is dialled.



Or:

- ▶ If you press **No**, the page is displayed again with the hyperlink. The number will **not** be dialled.



### Entering text

- ▶ If necessary, use  to navigate to the line containing the field into which you want to enter text. The cursor flashes in the text field.
- ▶ Enter the text using the keys on your handset.
- ▶ If necessary, navigate to other text fields to complete them or make a selection (see below).
- ▶ Press the right display key to complete the entry and send the data.

### Making selections

- ▶ If necessary, use  to navigate to the line in which you would like to make a selection.
- ▶ Press left or right on the control key several times to make the required selection.
- ▶ Use  to navigate to other selection fields and make your selection as described above.
- ▶ Press the left display key to complete the selection and send the data.

### Setting options

- ▶ Use  to navigate to the line containing the option. The line is highlighted.
- ▶ Activate or deactivate the option via the control key  (press right) or the left display key (e.g., **OK**).
- ▶ If necessary, navigate to other options or text fields to set or complete them.
- ▶ Press the left display key (e.g., **Send**) to complete the entry and send the data.

## System settings and settings on the handset

---

System settings are made via the Web configurator on the DECT Manager ( → [page 58](#)) and cannot be changed using the handsets.

This applies in particular for:

- ◆ Registering and de-registering the handset to the telephone system, handset name.
- ◆ All settings for the VoIP account used by a handset for calls.
- ◆ Settings for the network mailbox and the eMail account.
- ◆ Configuration of online directories.

Handset-specific settings are preset on your Gigaset. You can change these settings.

This applies, for example, for

- ◆ Display settings, such as language, colour, backlight etc.
- ◆ Settings relating to ringtones, volume, speaker profiles etc.

Information about this can be found in the user guide for the relevant handset.

## Date and time

Date and time are set in the Web configurator of the DECT Manager ( → [page 92](#)) and are synchronised system-wide on all base stations and Gigaset handsets.

Synchronisation is carried out in the following cases:

- ◆ If the date or time has been changed on the DECT Manager.
- ◆ If a handset is registered to the telephone system.
- ◆ If a handset is switched off and switched back on again, or is outside the wireless range of the telephone system for more than 45 seconds and then comes back into range.
- ◆ Automatically every night at 4.00 am.

You can change the date and time on the handset. This setting only applies for that handset and will be overwritten when the next synchronisation takes place.

The date and time are displayed in the format set for that handset.

### Please note

The date and time can only be set locally on handsets which only support the simple GAP standard. No synchronisation is carried out.

## Quickly accessing functions

You can select the assignment of the display keys in idle status from a range of telephone system functions for your handset.

**Prerequisite:** The handset used supports the individual assignment of display keys in idle status.

- ▶ Press and **hold** the left or right the display key. The list of possible key assignments is opened.
- ▶ Select a function and press **OK**.



The following basic functions can also be selected in addition to the functions provided by the handset for assigning display keys:

#### eMail

Opens the eMail submenu for receiving and reading eMail notifications ( → [page 48](#)):



 →  **Messaging** → **eMail**

#### More Functions...

Select and press **OK**; you can then also select from the following additional functions:

#### Call Lists

Assign the call lists menu to a key.

 →  **Call Lists**

#### Withhold Number

Restrict Calling Line Identification for the next call ( → [page 35](#)).

#### Call Divert

Assign the menu for setting and activating/deactivating call forwarding to a key ( → [page 37](#)):

 →  **Select Services** → **Call Divert**

#### PBX Control

Access to PABX services.

 →  **Select Services** → **PBX Control**

This function is only available if your Gigaset N720 DECT IP Multicell System PRO is connected to a Gigaset T500 PRO or T300 PRO PABX and services are provided via a RAP server ( → [page 88](#)).

#### eMail

Opening the eMail submenu for receiving and reading eMail notifications ( → [page 48](#)):

 →  **Messaging** → **eMail**



#### Info Centre

Start the info centre and open the list of available information services – go online ( → [page 52](#)).

 → **Additional Features** → **Info Centre**

#### Net Directories

Displaying the list of all network directories and providers of network directories ( → [page 39](#))

 →  **Contacts** → **Net Directories**

#### Central Net Dir.

Opening a corporate directory ( → [page 40](#)). If there is more than one, the list of corporate directories is opened.

#### Public Net Dir.

Opening the public directory ( → [page 41](#)). If there is more than one, the list of public directories is opened. If there are directories from several providers, the list of providers is opened.

## Starting a function

The function is displayed in the bottom display line above the display key (abbreviated, if necessary). To start the function, you then simply need to press the button.

When the handset is in idle status:

- ▶ Press the display key **briefly**.

The submenu opens and the function is performed.

## Configuring the system on the DECT Manager

---

Use the Web configurator to set up your Gigaset N720 DECT IP Multicell System and configure your DECT network.

- ◆ Set up the **DECT** network, register and synchronise the base stations.
- ◆ Make basic settings for the VoIP connections and register and configure the handsets you wish to use in the DECT network.
- ◆ You can make additional settings, e.g., meet particular prerequisites for connecting the handsets to a corporate network or adjust the voice quality on VoIP connections.
- ◆ Use the DECT Manager to save data required to access specific services on the Internet. These services include access to public online directories and to the incoming eMail server for eMail accounts, as well as synchronising the date/time with a time server.
- ◆ You can save your DECT Manager's configuration data as files on your PC and reload these onto your DECT Manager in the event of an error. You can arrange firmware updates for the DECT Manager.
- ◆ Manage the directories on registered Gigaset handsets (save to PC, compare them with one another or against a directory on your PC).

### Using the Web configurator

#### Connecting the PC to the Web configurator on the DECT Manager

##### Prerequisites:

- ◆ A standard Web browser is installed on the PC, e.g., Internet Explorer version 8.0 or higher, or Firefox version 4.x or higher.
- ◆ The DECT Manager and PC are directly connected to one another in a local network. The settings of any existing firewall installed on your PC allow the PC and DECT Manager to communicate with each other.

##### Please note

- ◆ Depending on your VoIP PABX/VoIP provider, it is possible that you will be unable to change individual settings in the Web configurator.
- ◆ While you are connected to the Web configurator, it is blocked to other users. Simultaneous access is not possible.

- ▶ Launch the Web browser on your PC.
  - ▶ Enter **www.gigaset-config.com** in the address field of the Web browser. The known devices with this name are displayed. If several devices are found, select your DECT Manager using the MAC address.
- A connection is established to the Web configurator for the DECT Manager.

### If connecting to [www.gigaset-config.com](http://www.gigaset-config.com) does not produce any results:

- ▶ Establish the DECT Manager's current IP address.
- ▶ Enter **http://** and the current IP address for the DECT Manager in the address field of the Web browser (for example: <http://192.168.2.10>).

#### Please note

The IP address is assigned dynamically via your local network's DHCP server. You can find the DECT Manager's current IP address on the DHCP server in the list of registered DHCP clients. The computer name for the DECT Manager is **N720-DM-PRO**. The MAC address can be found on the rear of the device. If necessary, contact the network administrator for your local network.

Once a handset is registered on the system, you can also find the IP address via the Info menu on the handset (→ [page 103](#)).

Your DECT Manager's IP address may change occasionally depending on the DHCP server settings (→ [page 64](#)).

## Logging into/off the Web configurator

Once you have successfully established the connection, the login screen is displayed in the Web browser.

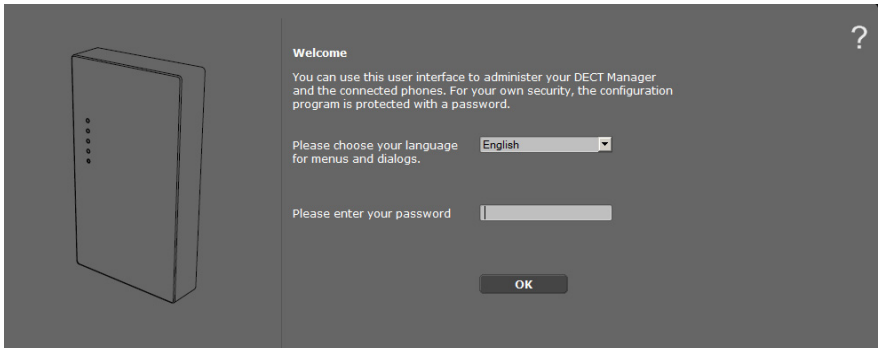

You can select the language in which you want the menus and Web configurator dialogues to be displayed.

- ▶ If necessary, click  to open the list of available languages.
- ▶ Select the language.

The Web page is reloaded in the selected language. Reloading may take some time.

- ▶ Enter the password in the bottom field of the Web page (default setting: **admin**) to access the Web configurator functions.
- ▶ Click **OK**.

### Please note

- ◆ You should change the password for security reasons ( → [page 71](#)).
- ◆ If you do not make any entries for a lengthy period (approx. 10 minutes), you are automatically logged off. The next time you try to make an entry or open a Web page, the login screen is displayed again. Enter the password again to log back in.
- ◆ Any entries that you did not save on the DECT Manager before automatic logoff will be lost.

## Understanding the structure of the Web configurator pages

The Web configurator pages contain the following UI elements (example):

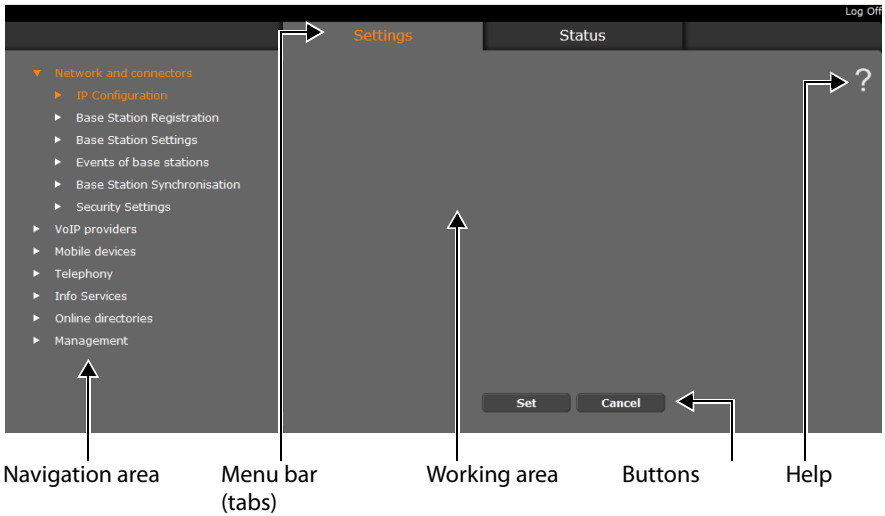

### Please note

The Help function includes a link to a website where you can obtain further information.

## Menu bar

The Web configurator menus are displayed as tab pages in the menu bar. You will find an overview of the Web configurator menu on → [page 63](#).

The following menus are available:

### Settings

The menu allows you to make **Settings** on the DECT Manager.

If you select the **Settings** menu, a list of this menu's functions is displayed in the navigation area.

### Status

The menu supplies information about the configuration and status of the DECT Manager and base stations.

### Log Off

You will find the **Log Off** function at the top right of each Web page, above the menu bar.

### Caution

Always use the **Log Off** function to end the connection to the Web configurator. If, for example, you close the Web browser without logging off beforehand, access to the Web configurator may be blocked for a few minutes.

## Navigation area

The functions of the menu (→ [page 61](#)) selected in the menu bar are listed in the navigation area.

If you select a function, the associated page containing information and/or input fields opens in the working area. The selected function is highlighted in orange.

If a function is assigned subfunctions, these are listed below the function as soon as you select the function (in the example **Network and connectors**).

The relevant page for the first subfunction (highlighted in orange) is displayed in the working area.

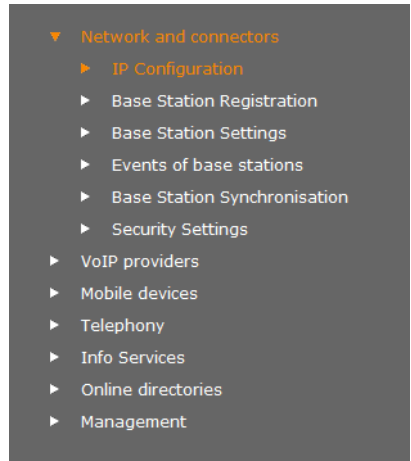

### Working area

Depending on the function selected in the navigation area, information or dialogue boxes are displayed in the working area that allow you to make or change your DECT network settings.

### Making changes

You can make settings via input fields, lists or options.

- ◆ There may be restrictions regarding the possible values for a field e.g., the maximum number of characters, entering special characters or certain value ranges.
- ◆ To open a list, click  . You can choose between default values.
- ◆ There are two kinds of options:
  - Checkboxes: You can activate one or more options from a list. Active options are indicated by , non-active options by  . You can activate an option by clicking  . The status of the other options in the list does not change. You can deactivate an option by clicking .
  - Alternative options (radio buttons): The active option in the list is indicated by  , and the non-active by  . You can activate an option by clicking  . The previously activated option is deactivated. You can only deactivate an option by activating another option.

### Applying changes

As soon as you have made your change on a page, save and activate the new setting on the DECT Manager by selecting **Set**.

If your entry does not comply with the rules for this field, an appropriate error message is displayed. You can then repeat the input.

#### Caution

Changes that have not been saved on the DECT Manager are lost if you move to another Web page or the connection to the Web configurator is lost, e.g., due to exceeding the time limit ( → [page 60](#)).

### Buttons

Buttons are displayed in the bottom section of the working area. Depending on the current function of a Web page, various buttons are displayed. The functions of these buttons are described in the respective function below.

**The most important buttons are:**

#### Cancel

Reject changes made on the Web page and reload the settings that are currently saved in the DECT Manager to the Web page.

#### Set

Store changes made on a Web page in the DECT Manager.

## Opening Web pages

A brief outline of how to navigate to the individual Web configurator functions is given below.

### Example

Defining dialling plans:

Settings → Telephony → Dialling Plans

To open the Web page, proceed as follows after login:

- ▶ Select the **Settings** menu in the menu bar.
- ▶ Click the **Telephony** function in the navigation area.  
The **Telephony** subfunctions are displayed in the navigation tree.
- ▶ Select the **Dialling Plans** subfunction.

## Web configurator menu

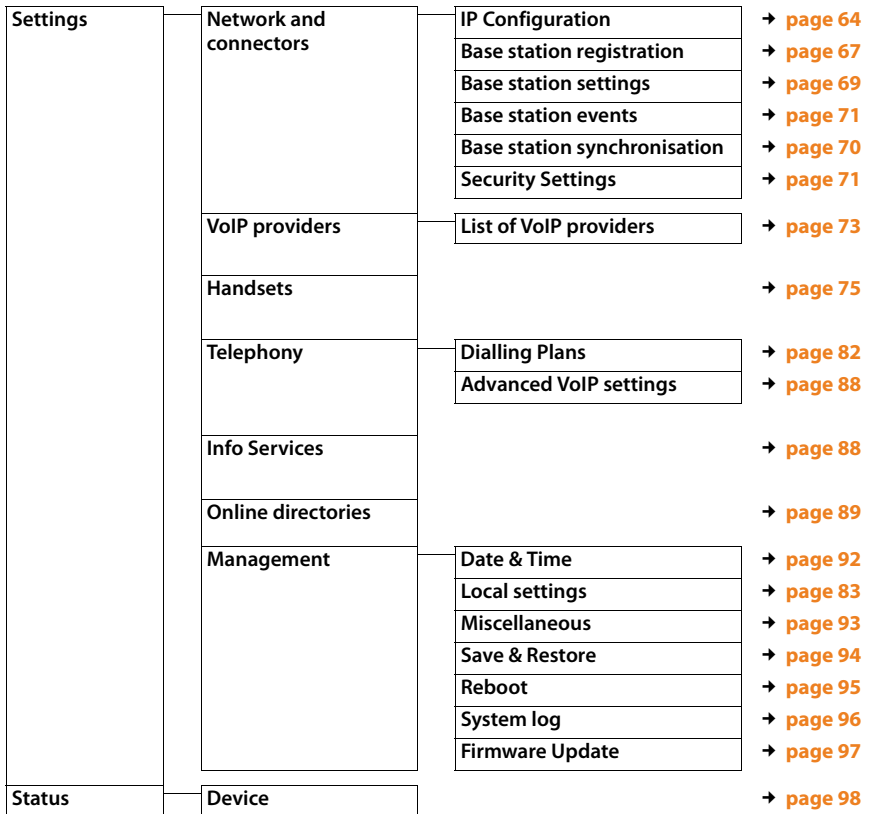

## Connecting the DECT Manager to the local network (LAN/router)

You can find the functions for connecting to the **LAN** on the Web page:

**Settings** → **Network and connectors** → **IP Configuration**

In most cases, special settings are not required to connect the DECT Manager to the local network. Your DECT Manager is preconfigured for dynamic assignment of the IP address by default ( → **IP address**). A DHCP server that assigns the IP address dynamically must be activated in the local network in order for the DECT Manager to be "recognised".

If the local network DHCP server cannot or should not be activated, you must assign a fixed/static IP address to the DECT Manager.

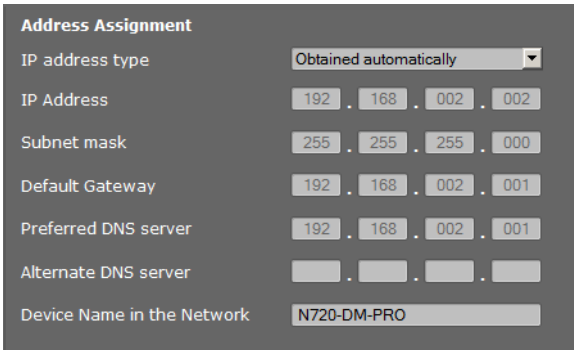

The screenshot shows the 'Address Assignment' configuration page. It includes a dropdown menu for 'IP address type' set to 'Obtained automatically'. Below are input fields for 'IP Address' (192.168.002.002), 'Subnet mask' (255.255.255.000), 'Default Gateway' (192.168.002.001), 'Preferred DNS server' (192.168.002.001), and 'Alternate DNS server' (empty). The 'Device Name in the Network' is set to 'N720-DM-PRO'.

### IP address type

- ▶ Select **Obtained automatically** if your device receives the IP address via a DHCP server (default setting).
- ▶ Select **Static** if your device receives a fixed IP address.

If the **Obtained automatically** setting is selected, all further settings are automatically configured. They are displayed and cannot be changed.

If you have selected **Static** as the address type, you must create the following settings:

### IP Address

Enter an **IP address** for your DECT Manager. This IP address allows your DECT Manager to be reached by other subscribers in your local network (e.g., PC).

The IP address comprises four individual groups of numbers with decimal values from 0 to 255 that are separated by a dot, e.g., 192.168.2.1.



Please note:

- The IP address must be included in the address block used by the router/gateway for the local network. The valid address block is defined by the IP address for the router/gateway and the subnet mask (see example).
- The IP address must be unique across the network, which means that it must not be used by another device connected to the router/gateway.
- The fixed IP address must not belong to the address block that is reserved for the DHCP server for the router/gateway.

Check the settings on the router or ask your network administrator.

### Example:

|  |                               |
|--|-------------------------------|
| Router IP address:                         | 192.168.2.1                   |
| Network subnet mask                        | 255.255.255.0                 |
| DHCP server address block                  | 192.168.2.101 – 192.168.2.254 |
| Possible IP addresses for the DECT Manager | 192.168.2.2 – 192.168.2.100   |

### Subnet mask

The **Subnet mask** specifies how many parts of an IP address the network prefix must comprise.

For example, 255.255.255.0 means that the first three parts of an IP address must be the same for all devices in the network, while the last part is specific to each device. In subnet mask 255.255.0.0, only the first two parts are reserved for the network prefix. Enter the subnet mask that is used by your network.

### Default Gateway

Enter the IP address for the standard gateway through which the local network is connected to the Internet. This is generally the local (private) IP address for your router/gateway (e.g., 192.168.2.1). Your DECT Manager requires this information to be able to access the Internet.

### Preferred DNS server

Enter the IP address for the preferred DNS server. **DNS** (Domain Name System) allows you to assign public IP addresses to symbolic names. The DNS server is required to convert the DNS name into the IP address when a connection is being established to a server.

You can specify the IP address for your router/gateway here. This forwards address requests from the DECT Manager to its DNS server.

There is no default setting for a DNS server.

### Alternate DNS server

Enter the IP address for the alternate DNS server that should be used in situations where the preferred DNS server cannot be reached.

### Device Name in the Network

The product name of the DECT Manager is displayed in this field. You can change this name to identify the device in the network.

### Configuring a HTTP proxy



**HTTP proxy**

Enable proxy server  Yes  No

Proxy server address

Proxy server port

- ▶ Select whether you want to release a separate proxy server in the network for your DECT Manager.
- ▶ If **Yes**, enter the IP address for the proxy server in the **Proxy server address** field.
- ▶ The default setting for the **Proxy server port** is 80. Change this if your server uses another port.

### VLAN Tagging

A local network can be divided into logical subnetworks known as VLANs (VLAN = Virtual Local Area Network, Standard IEEE 802.1Q). Multiple VLANs share a physical network and its components, e.g., switches. Data packets from a VLAN are not forwarded to another VLAN. VLANs are often used to separate the data traffic of different services (Internet telephony, Internet TV etc.) and to define different priorities for the data traffic.

You can run your DECT Manager and a PC used to configure the DECT Manager on a separate VLAN. In this case, you enter the VLAN identifiers (VLAN tags) for your VLAN. Your network operator will supply you with this data.

#### Caution

If you operate the PC in a different VLAN from the DECT Manager, you will no longer have direct access to the Web configurator of the DECT Manager from the PC.

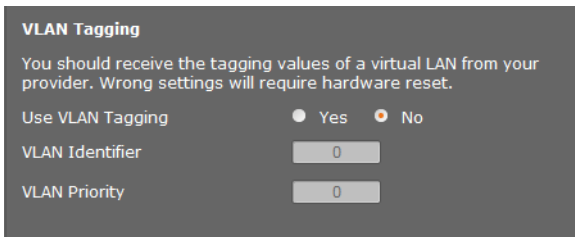

**VLAN Tagging**

You should receive the tagging values of a virtual LAN from your provider. Wrong settings will require hardware reset.

Use VLAN Tagging  Yes  No

VLAN Identifier

VLAN Priority

- ▶ Select **Yes** if you do not want to use a VLAN (default setting **No**).
- ▶ Enter the VLAN identifier for your virtual network in the **VLAN Identifier** field.

#### Caution

If you enter an incorrect value for **VLAN Identifier** and save the settings, you will no longer be able to access the DECT Manager from the PC used for configuration. If you then reset the DECT Manager to a static or dynamic IP address, this will also disable the VLAN tagging (see **Resetting the IP configuration and password, page 24**). You will then need to reinstate the DECT Manager's access to the local network ( → **page 64**).

- ▶ Select **VLAN Priority** to transfer the PC data.

### Prioritising VLANs

Data packets from VLANs can be prioritised. The priority determines whether the data traffic from a VLAN is given preferential treatment by the network components. You can define the priority for voice and data separately. In the case of a local network with a lot of data traffic, you can achieve better quality phone connections by giving a high priority to voice data.

Range of values and assignment of values to service classes (according to IEEE 802.1p):

- 0 No priority (Best Effort)
- 1 Background services, e.g., news ticker (Background)
- 2 Not defined
- 3 General data services (Excellent Effort)
- 4 Control services, e.g., routing (Controlled Load)
- 5 Video
- 6 Voice data (Voice)
- 7 Top priority for network control software (Network Control)

### Saving settings

- ▶ Click on **Set** to save your settings on the **IP Configuration** page.

## Configuring and synchronising base stations

The Gigaset N720 DECT IP Multicell System automatically recognises the base stations, but they need to be confirmed, activated and synchronised.

To do this you will need a list of all base stations, each with the MAC address of a DECT module and the location in the building or a unique name for the cell. You will find the MAC addresses for the DECT modules on the sticker attached to each respective Gigaset N720 IP PRO base station.

### Registering base stations

**Settings** → **Network and connectors** → **Base station registration**

The window shows a list of all DECT base stations connected to the network which have not yet been registered. The base stations are identified by their MAC address and by the date and time of their initial contact with the system.

If there are no base stations on the local network that have not yet been registered, a message to this effect will be displayed.



- ▶ Select **Confirm** if this base station is to be registered to the system.

## Configuring the system on the DECT Manager

The **Own base station data** window opens to configure this base station.

**Own data of the base station**

Name / Location: Cell 1

Cluster: 1

Synchronisation level: 1

Status: Offline

IP address type: Obtained automatically

**DECT Module 1**

MAC Address: 7C:2F:80:2B:05:06

IP Address: [ ] . [ ] . [ ] . [ ]

RFPi = PARI + RPN (hex): 10 24 46 E2 02

Current firmware version: 71.023.00.000.00

**DECT Module 2**

MAC Address: 7C:2F:80:2B:05:07

IP Address: [ ] . [ ] . [ ] . [ ]

RFPi = PARI + RPN (hex): 10 24 46 E2 03

Current firmware version: 71.023.00.000.00

Activate Base Station:  Yes  No

Set Cancel

- ▶ Enter a unique identifier for the base station in the **Name / location** field (e.g., Ground Floor West). This name should make it easier to assign the base station within the logical and spatial structure of the DECT network.
- ▶ **DECT-Cluster** and **Synchronisation level** can be specified later on the **Synchronising base stations** page.

The base station status is displayed:

- **Offline:** The base station is not connected to the telephone system via LAN.
- **Deactivated**
- **Active**
- **Active and Synced**

The IP address type is copied from the setting for the DECT Manager on the **IP Configuration** page (→ [page 64](#)). You can change the IP address type. The settings for the DECT Manager and the base stations do not have to match. For example, the DECT Manager could receive a fixed IP address so that it will always be able to access the Web configurator with the same address, while the base stations receive their IP addresses dynamically.

If you select the **Obtained automatically** option for the IP address, you will not need to enter any further details.

If you are using static IP addresses on your local network, you will also need to enter an IP address for each base station ( → [page 64](#)).

The MAC addresses, the **RFPI** identifier (Radio Fixed Part Identity) and the RTP port range calculated by the system are displayed for both the base station's DECT modules.

▶ Select **Activate base station**.

If you do not activate the base station, the data remains stored in the DECT Manager.

▶ Click **Set** to save the settings.

The **Base station registration** window now opens again to allow you to register and configure the remaining base stations. When you have registered and configured all the required base stations, the window shows that there are no more unregistered base stations visible in the system.

You must now synchronise the base stations.

## Displaying base stations, changing settings

**Settings** → **Network and connectors** → **Base station settings**

| Connected cells   |     |         |              |                   |                                     |                |
|---|-----|---------|--------------|-------------------|-------------------------------------|----------------|
| List of connected cells with Radio Fixed Part Number (RPN), synchronisation level and status. |     |         |              |                   |                                     |                |
| Cell  | RPN | Cluster | Synch. level | Status            | Activate                            |                |
| Workshop West   | 2   | 1       | 2            | Active and Synced | <input checked="" type="checkbox"/> | <b>Details</b> |
| Workshop Central  | 4   | 1       | 1            | Active and Synced | <input checked="" type="checkbox"/> | <b>Details</b> |
| Workshop East   | 6   | 1       | 2            | Active and Synced | <input checked="" type="checkbox"/> | <b>Details</b> |
| Admin First Floor   | 8   | 2       | 3            | Active and Synced | <input checked="" type="checkbox"/> | <b>Details</b> |
| Admin Second Floor  | 10  | 2       | 2            | Active and Synced | <input checked="" type="checkbox"/> | <b>Details</b> |
| Stairwell   | 12  | 2       | 1            | Active and Synced | <input checked="" type="checkbox"/> | <b>Details</b> |
| Admin Ground Floor  | 14  | 2       | 2            | Active and Synced | <input checked="" type="checkbox"/> | <b>Details</b> |

The **Base station settings** page shows a table of all connected base stations with the name, RPN (Radio Part Number, number of the cell on the DECT network), cluster number, synchronisation level and status.

▶ Click the **Details** button to display the settings for a base station. This opens the **Own base station data** screen ( → [page 68](#)). This shows the base station's current status and IP addresses. You can modify the IP addressing settings if required.

## Configuring the system on the DECT Manager

- ▶ If you wish to remove the base station from the network, click on **Delete base station**. If you delete the base station, all data for this base station will be deleted from the DECT Manager.
- ▶ Click on **Set** to apply the changes on this page.

## Synchronising base stations

Synchronisation and the logical structuring of the base stations in clusters are prerequisites for the functioning of the PABX, the radio connection between base stations and mobile phones and the handover.

To carry out the synchronisation you will need the plan of the clusters with the synchronisation level for each base station.

- ▶ View the list of installed base stations and check that all base stations have been registered and configured ( → [page 67](#)). They will then appear in the list in the following window:

**Settings → Network and connectors → Base station synchronisation**

| Cell               | Cluster | Synchronisation level |
|--------------------|---------|-----------------------|
| Workshop West      | 1       | 2                     |
| Workshop Central   | 1       | 1                     |
| Workshop East      | 1       | 2                     |
| Admin First Floor  | 2       | 3                     |
| Admin Second Floor | 2       | 2                     |
| Stairwell          | 2       | 1                     |
| Admin Ground Floor | 2       | 2                     |

Storing the changed settings will automatically start synchronisation. Connections to the handset will be aborted.

**Set** **Cancel**

- ▶ Now assign the cluster number and synchronisation level to each base station as given in the plan.
- ▶ Select **Set**.

Synchronisation starts automatically and contact with handsets that have already been registered is interrupted.

## Base stations – displaying events

This page displays counters for diagnostic purposes relating to various events that affect the base stations, e.g., active radio connections, handovers, unexpectedly terminated connections to a handset etc.

**Settings** → **Network and connectors** → **Base station events**

- ▶ Click on **OK** to delete all displayed events.

## Security settings

The DECT Manager supports the establishment of secure data connections on the Internet with the **TLS** security protocol (Transport Layer Security). With TLS, the client (the phone) uses certificates to identify the server. These certificates must be stored on the base.

You can also set the **Remote Management** function on this page.

**Settings** → **Network and connectors** → **Security Settings**

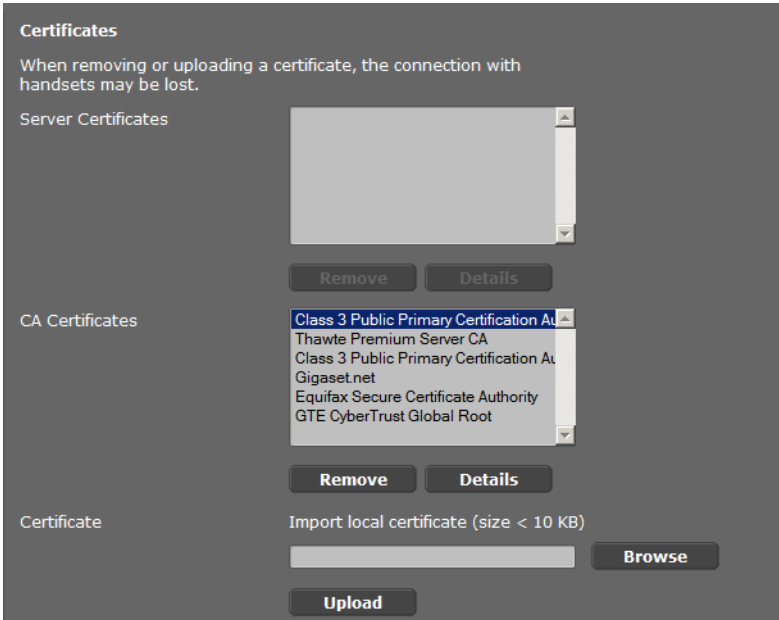

This page contains the **Server Certificates** and **CA Certificates** lists. These show the certificates stored in the DECT Manager. The certificates have either already been saved by default or you have downloaded them to the DECT Manager via the **Upload** button.

## Configuring the system on the DECT Manager

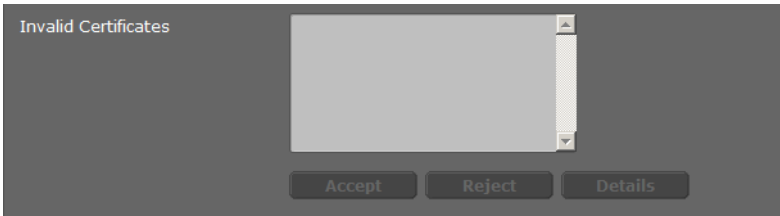

The **Invalid Certificates** list contains the certificates received from servers that have not passed the certificate check when establishing a connection, and certificates from the **Server Certificates/CA Certificates** lists that have become invalid (e.g., because they have expired).

You can remove certificates and download new certificates to the DECT Manager and you can also accept or reject invalid certificates.

If the connection to a data server on the Internet is not made because the phone does not accept the certificate received from the server (e.g., when downloading your eMail messages from the POP3 server), you will be prompted to open the **security settings** Web page.

The **Invalid Certificates** list contains the certificate used to make the connection. You can display information on the certificate by highlighting it and clicking on the **Details** button. This information includes who issued the certificate (certification authority) and for whom, as well as its validity period.

You must use the information to decide whether to accept or reject the certificate.

If you accept the certificate, depending on its type, it is transferred to one of the **Server Certificates/CA Certificates** lists (even if it has already expired). If a server responds again with this certificate, this connection is accepted immediately.

If you decline the certificate, it is transferred to the **Server Certificates** list with the label **Reject**. If a server responds again with this certificate, this connection is rejected immediately.

### Remote Management

If you permit remote management, you can also access the DECT Manager Web configurator from other networks.

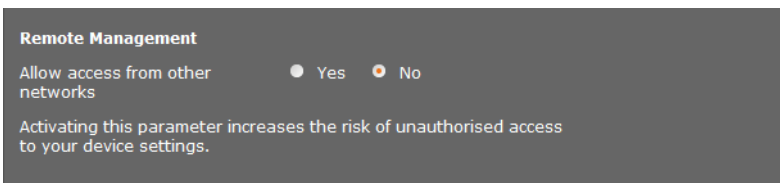

► Select **Yes** if you wish to **Allow access from other networks** or **No** if not.

If you allow **Remote Management**, this increases the risk of unauthorised access to your device settings.



## Configuring VoIP providers

This page allows you to create a list of systems providing VoIP connections and other services for your phones. You can enter the following:

- ◆ Your company's VoIP PABX(s)
  - ◆ Public providers from which you have requested VoIP services
- You can configure up to ten different VoIP PABXs or VoIP providers.

**Settings → VoIP providers**

| List of VoIP providers |                |             |
|------------------------|----------------|-------------|
| Name                   | Domain         |             |
| 1. IP1                 | Not configured | <b>Edit</b> |
| 2. IP2                 | Not configured | <b>Edit</b> |
| 3. IP3                 | Not configured | <b>Edit</b> |

- ▶ Click on the **Edit** button next to the list entry for the VoIP connection.

A page opens for you to establish a new connection or change the data for an existing connection.

You enter the details for a PABX manually. When configuring a VoIP provider, you can use a wizard to select a provider profile.

### Wizard for selecting provider profiles

Gigaset offers a range of provider profiles that you can use for configuration. The Gigaset N720 DM PRO searches for a provisioning file on the network and downloads a provider's configuration data and default settings from this file. You will use this data later to assign VoIP accounts to the handsets (→ [page 76](#)).

**VoIP Provider 2**

**Profile Download**

Provider

Profile Version

**Select VoIP Provider**

- ▶ Click on **Select VoIP provider** to load a new VoIP profile.

This launches a wizard to guide you through the process. Select the country first and then the required provider from the list. The data for the selected profile is then loaded and displayed in the window.

If necessary, you can modify the general provider data in the **General data for your service provider** and **Network data for your service provider** sections.

### Entering provider data

Enter data manually here for a VoIP PABX or a provider for which there is no existing profile. You can obtain the data from the PABX administrator or your VoIP provider.

- ▶ Enter the IP address for the VoIP PABX in the **Proxy server address** field.

The screenshot shows a configuration window titled "General data of your service provider" and "Network data for your service provider".

**General data of your service provider**

- Domain: [Text input field]
- Proxy server address: [Text input field]
- Proxy server port: [5060]
- Registration server: [Text input field]
- Registration server port: [5060]
- Registration refresh time: [180] sec

**Network data for your service provider**

- STUN enabled:  Yes  No
- STUN server address: [Text input field]
- STUN server port: [3478]
- STUN refresh time: [240] sec
- NAT refresh time: [20] sec
- Outbound proxy mode:  Always  Automatic  Never
- Outbound server address: [Text input field]
- Outbound proxy port: [5060]

Buttons: Set, Cancel, Delete

Occasionally you will need to adjust the following settings to correspond to your router settings:

- If you cannot hear the caller on an outgoing call, you may have to switch between outbound proxy server mode and STUN use. The STUN or outbound server replaces the private IP address of your DECT Manager with its public IP address in the sent data packets. If you operate your DECT Manager behind a router with symmetric NAT, STUN cannot be used.
- If you are sometimes unavailable for incoming calls, you may have to adjust the value in **NAT refresh time**:  
If you have not activated port forwarding or set up a DMZ on the router for the DECT Manager, an entry in the routing table for the NAT (in the router) is required to make the phone available. The DECT Manager must confirm this entry in the routing table at certain intervals (**NAT refresh time**) so that the entry stays in the routing table.

For further information on this, please refer to the section **Customer care** on → [page 101](#).

## Configuring handsets

You can use the Web configurator to register all handsets on the DECT network and for a VoIP connection. You can edit the settings for handsets that are already registered, deactivate or delete them and make further settings e.g., for using directories and network services.

### Settings → Handsets

List of registered mobile devices / subscribers

|    | Username<br>Display name | SIP connection  | Handset<br>registered | E-mail<br>account | Net AM |             |
|----|--------------------------|-----------------|-----------------------|-------------------|--------|-------------|
| 1. | 08941616315<br>Peter     | 10.15.31.8<br>✓ | ✓                     | —                 | —      | <b>Edit</b> |

The provider account data should already exist before a mobile device is configured.

New mobile device with own provider data **Add**

New mobile device with own data:  **Add**

Displayed name on idle display  Username  Display name

The DECT Manager starts the check for all mobile devices for which the e-mail check is activated.

Check for new e-mail  **Set** **Cancel**

Handsets that are already registered are displayed in the list.

- ▶ Click on **Edit** to change the settings for this handset.
- ▶ To start registering and configuring a new handset, click the **Add** button.
 

Each handset is assigned its own VoIP account. However, you can copy the provider and the "Advanced settings" ([page 77](#)) from a handset that has already been registered. To do this, select the listed handset from which you want to copy the data and then click on **Add** next to **New mobile device with own data**.
- ▶ Specify whether you want to use the **Username** or **Display name** for the VoIP account as the name for the handsets. The name you choose here will be displayed on the handsets when they are in idle status. Both names are specified when registering the handset (→ [page 76](#)).
- ▶ Specify how often the DECT Manager should check for new eMails (for all handsets on which this function is activated).

## Registering a handset

Please note:

- ◆ Each handset is assigned a VoIP account.
- ◆ Registration in the DECT network and for the VoIP connection is started at the same time.
- ◆ If you assign a different VoIP account to a handset that is already registered, the connection already configured will be overwritten.

**Mobile device 1**

**Personal Provider Data**

Authentication name

Authentication password

Username

Display name

Select VoIP provider

Register a mobile device for this SIP connection

- ▶ Check that the handset you wish to register is within the wireless range of your DECT network.
- ▶ Choose a configured VoIP PABX/provider from the **Select VoIP provider** list.
- ▶ Enter the access data for the VoIP account in the relevant fields. These fields may vary depending on the PABX/provider profile.

### Please note

Use the **Displayed name on idle display** option on the **Handsets** page to specify whether **Username** or **Display name** should be used as the handset name on the idle display (→ [page 75](#)).

- ▶ Click the **Start Registration** button to start registering the handset. The PIN is displayed in a window. You must now enter that PIN on the handset to carry out the registration (→ [page 19](#)).

## Extended settings for handsets

The page offers the following additional setting options for handsets:

- ▶ Online directories and network mailboxes
- ▶ Settings for audio codecs
- ▶ Exporting or importing the local directory
- ▶ Configuring the call manager and eMail reception
- ▶ Deregistering and deleting handsets

Open the window via:

**Settings → Handsets → Edit**

- ▶ Click on the **Show Advanced Settings** button.

### Online directories and network mailboxes

**Online directories**

You can decide which directory will be opened by pressing the directory key and the INT key on your handset. One online directory can be selected for an automatic name search.

Directory for direct access

Corporate directory for INT key

Automatic look-up

**Network Mailbox Configuration**

Call number or SIP name (URI)

Activate network mailbox  Yes  No

Apply changes for all SIP connections

The user can call up various directories using the handset control key:

- ▶ Choose which directory is called up with the directory key (bottom of the control key). You can select the local directory or one of the online directories from the list. Depending on this choice, the user can press and hold the directory key to open either the list of online directories or the local directory.
- ▶ Choose from the list which corporate directory is opened with the INT key (left on the control key).
- ▶ Select an online directory from the list for **Automatic look-up** or deactivate this option. When there is an incoming call, the caller's name is read from this directory and shown in the display (the availability of this function depends on the online directory provider).

Set which online directories are to be made available on the **Online directories** page,

→ [page 89](#).

## Configuring the system on the DECT Manager

### Network Mailbox Configuration:

- ▶ Enter the **Call number or SIP name (URI)** for the network mailbox and activate the network mailbox.
- ▶ If these settings are to apply to all configured handsets, click on **OK**.

### Settings for codecs

The voice quality of VoIP calls is determined by the **Codec** used for the transmission. To increase the quality, more data must be transmitted. Depending on the bandwidth of the DSL connection, this can then lead to problems with the volume of data – especially if several VoIP calls are made simultaneously – so that the transmission no longer takes place smoothly.

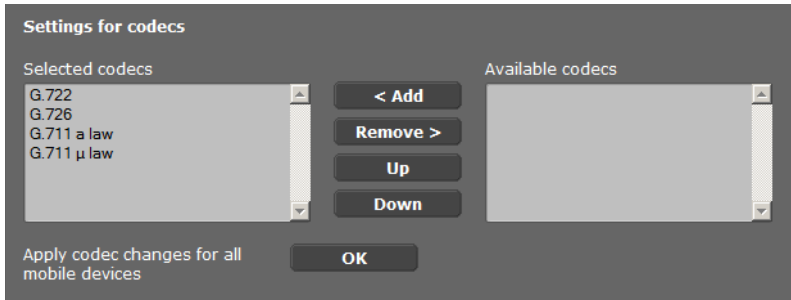

Both parties involved in a phone connection (caller/sender and recipient) must use the same voice codec. The voice codec is negotiated between the sender and the recipient when establishing a connection. You can select the voice codecs to be used for this VoIP account and specify the order in which the codecs are to be suggested when a VoIP connection is established.

- ▶ Select the required codecs and define the sequence in which they should be used.  
The following voice codecs are supported:

**G.722** Outstanding voice quality. The G.722 wideband voice codec works at the same bit rate as G.711 (64 kbit/s per voice connection) but at a higher sampling rate (16 kHz).

#### **G.711 a law/G.711 μ law**

Excellent voice quality (comparable with ISDN). The required bandwidth is 64 kbit/s per voice connection.

**G.726** Good voice quality (inferior to G.711 but better than G.729). Your phone supports G.726 with a transmission rate of 32 kbit/s per voice connection.

**G.729A** Average voice quality. The necessary bandwidth is less than or equal to 8 kbit/s per voice connection.

You need a licence to use the G.729 codec. You can activate this on the **Advanced VoIP settings** page ( → [page 84](#)).

- ▶ If these settings are to apply to all configured handsets, click on **OK**.

## Export and import local directory

**Export and import local directory**

Transfer directory from PC to mobile device.

Name of directory file  **Browse**

**Transfer**

Save mobile device directory to PC **Save**

Delete mobile device directory **Delete**

The Web configurator has the following options for editing and coordinating the directories of the registered handsets.

- ◆ Save the local directory to a PC. Entries are stored in vCard format in a vcf file on the PC. You can download these files onto every registered handset. You can also copy directory entries to your PC address book.
- ◆ Transfer contacts from a PC address book. Export the contacts in vcf files (vCards) and transfer them to the directory on the handset using the Web configurator.
- ◆ Delete the local directory from the handset.  
If you have edited the directory file (vcf file) on the PC and would like to load this modified directory to the handset, you can delete the current directory on the handset before the transfer.

**Tip:** Back up the current directory on your PC before deleting it. You can then reload it if the modified directory is affected by formatting errors and some, or all, of it cannot be loaded onto the handset.

### Please note

- ◆ You can find information on vCard format (vcf) on the Internet, e.g., at: [www.en.wikipedia.org/wiki/VCard](http://www.en.wikipedia.org/wiki/VCard) (English) or [www.de.wikipedia.org/wiki/VCard](http://www.de.wikipedia.org/wiki/VCard) (German)  
(You can set the display language at the bottom left-hand side in the navigation area of the Web page.)
- ◆ If you want to copy a directory (vcf file) stored on the PC and containing several entries to the Microsoft Outlook™ address book, please note that Microsoft Outlook™ only ever copies the first (directory) entry from the vcf file to its address book.

### Transfer rules

The directory entries from a vcf file that are loaded onto the handset will be added to the directory. If an entry already exists for a name, it will either be supplemented or a new entry for the name will be created. The process will not overwrite or delete any phone numbers.

#### Please note

Depending on your device type, up to three entries with the same name are created in the directory for each vCard – one entry per entered number.

### Directory file content (vcf file)

The following data (if available) is written into the vcf file for entry into the directory or transferred from a vcf file into the handset directory:

- ◆ Name
- ◆ First name
- ◆ Number
- ◆ Number (office)
- ◆ Number (mobile)
- ◆ eMail address
- ◆ Birthday (YYYY-MM-DD) and time of the reminder call (HH:MM) separated by a "T" (example: 2011-12-24T11:00).

Other information that a vCard may contain is not entered into the handset directory.

#### Example of an entry in vCard format:

```
BEGIN:VCARD
VERSION:2.1
N:Smith;Anna
TEL;HOME:1234567890
TEL;WORK:0299123456
TEL;CELL:0175987654321
eMail:anna@smith.com
BDAY:2008-12-24T11:00
END:VCARD
```

### Call Manager

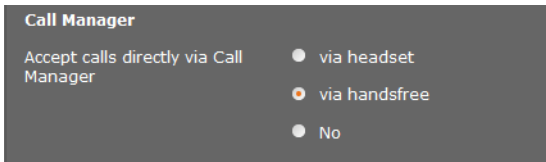

- ▶ Select whether calls that are transferred via the PABX call manager are to be accepted directly **via headset**, **via handsfree** or not at all (**No**).



## Receiving eMail

- ▶ If the DECT Manager is to check the receipt of eMails for the handset, enter the data for the eMail account here.
- ▶ Activate the option **Yes** for **Check for new eMail**.
- ▶ Select whether the notification should be transmitted via a secure connection.
- ▶ If these settings are to apply to all configured handsets, click on **OK**.

## Deregistering and deleting handsets

If the handset for which you are currently editing the settings is registered with the DECT Manager, you can:

- Deregister** Deregister the handset for this SIP connection.  
The connection is interrupted but all data is retained.
- Delete** Delete the entire account for the handset on the DECT Manager.  
This affects all settings on this page, the DECT registration and the VoIP account.

## Saving settings

- ▶ Click on **Set** to save your settings on the page.

### Please note

If you have registered or deregistered all handsets, you should back up the DECT Manager settings on the PC (→ [page 94](#)). This ensures that the handsets and VoIP accounts will still be assigned consistently if you need to restore the data at a later date.

## Additional settings for making a call

The following settings are available for telephony on all handsets.

- ◆ Call barring and access codes (see below, **Dialling plans**)
- ◆ Activating the area code for local calls → **page 83**
- ◆ Additional VoIP settings → **page 88**
  - Audio setting
  - Configuring call transfer
  - R key (hook flash)
  - Setting up local communication ports

## Dialling plans

Settings → Telephony → Dialling Plans

### Call Barring

| Phone Number         | Comment              | Blocked                             |        |
|----------------------|----------------------|-------------------------------------|--------|
| 123                  |                      | <input checked="" type="checkbox"/> | Delete |
| New Rule             |                      |                                     |        |
| <input type="text"/> | <input type="text"/> | <input type="checkbox"/>            | Add    |

On this page, you can enter the phone numbers you wish to block for calls, e.g., chargeable dialling codes.

- ▶ Enter the phone number for which you want to block calls in **New Rule**.
- ▶ Entering information in the **Comment** field makes it easier to distinguish between different blocked phone numbers.
- ▶ Click on **Add** to create the new rule.
- ▶ To enable a rule, select the **Blocked** checkbox.
- ▶ Click on the **Delete** button to remove a plan from the list.

### Access code

The access code is automatically prefixed to the numbers before dialling.

Code

is added to numbers

Depending on your PABX settings, you may need to insert an access code before the phone number for calls outside the area covered by your VoIP PABX (external line prefix, e.g., "0").

- ▶ Save an access code and specify when the phone numbers should be automatically prefixed with the digits. You can choose between **All**, **Never** and **from Call Lists** (only when dialling from the call list or an answering machine list).
- ▶ Click on **Set** to save your settings on the page.

## Activating the area code for local calls using VoIP

On this page, you provide details about the location of your phone. These are used to determine the international and local area dialling codes as well as country-specific tones (e.g., dialling tone or ring tone).

**Settings → Management → Local settings**

**Area Codes**

With the selection of the country, the international country code will be initialized.

Country Germany ▼

International

Prefix 00

Code Number 49

Local

Prefix 0

Code Number [input field]

Use Area Codes for VoIP

for local calls

for local and national calls

No

**Tone Selection**

Tone Pattern United States of America ▼

### Area Codes

If you use VoIP to make a call to the fixed line, you may also have to dial the area code for local calls (depending on the provider).

You can set your phone so that the access code is automatically predialled when any VoIP call is made in the same local area, and also for national long-distance calls. This means that the access code is set before all phone numbers that do not start with 0 – even when dialling numbers from the directory and other lists. The exceptions are numbers for which a dialling rule has been defined.

- ▶ Select your country. The international and national prefix is then entered in the **Prefix** and **Code Number** fields. You can change these settings if required.
- ▶ Specify the type of calls (local and national calls) to which the settings are to apply.

### Tone selection

Tones (e.g., dialling tone, ring tone, busy tone or call waiting tone) vary from one country or region to another. You can choose from various tone groups for your phone system.

- ▶ From the **Tone Selection** list, select the country or region whose ring tones are to be used for your phone.
- ▶ Click on **Set** to save your settings on the page.

## Additional VoIP settings

On this page you can make settings for sending DTMF signals and for voice quality, set up call transfer and ringback, and configure settings for the ports for establishing VoIP connections.

**Settings → Telephony → Advanced VoIP settings**

### DTMF in VoIP connections

To send DTMF signals via VoIP, you must first define how key codes should be converted into and sent as DTMF signals: as audible information via the speech channel or as a "SIP Info" message.

Ask your provider which type of DTMF transmission is supported.

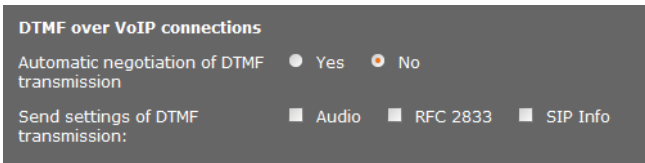

You have the following options:

- ▶ If you activate the option **Yes**, the phone automatically attempts to set the suitable DTMF signalling type for the current codec for each call.
- ▶ If you disable the **No** option, you can use the other options to specify the DTMF signalling type.
  - ▶ Enable **Audio** or **RFC 2833** if DTMF signals are to be transmitted acoustically (in voice packets).
  - ▶ Enable **SIP Info** if DTMF signals are to be transmitted as code.

### Enabling the G.722 wideband telephony codec on the DECT network

Both parties involved in a phone connection (caller/sender and recipient) must use the same voice codec. The voice codec is negotiated between the sender and the recipient when establishing a connection.

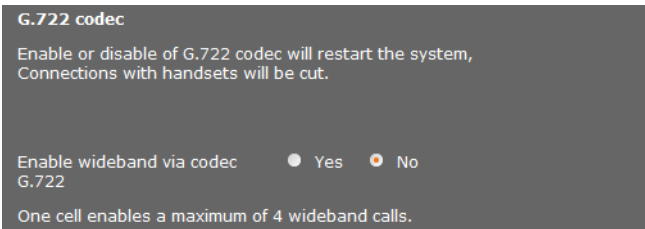

The G.722 codec (wideband connection) enables high voice quality, but only a maximum of four simultaneous connections per base station.

- ▶ Enable the G.722 codec to permit wideband transmission for all handsets on the DECT network.

## Enabling the G.729 codec

The G.729 codec allows telephony with very low bandwidth requirements and is recommended if minimal network capacity is to be used. You select the codecs for the VoIP connections in the "Advanced settings" for each handset (→ [page 78](#)).

You need a licence to use the G.729 codec. A maximum of ten licences is available; these must be activated. The DECT Manager needs to connect to the Internet for this.

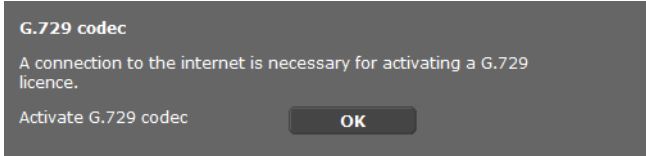

When using G.729 you can also save bandwidth and transmission capacity by suppressing the transmission of voice packets during pauses (default: **No**).

- ▶ Activate the **Yes** option for **Enable Annex B for codec G.729** to enable the transmission of data packets during pauses. The participants will then hear background noise during pauses, similar to the sound heard during a "traditional" phone call.

## Configuring call transfer

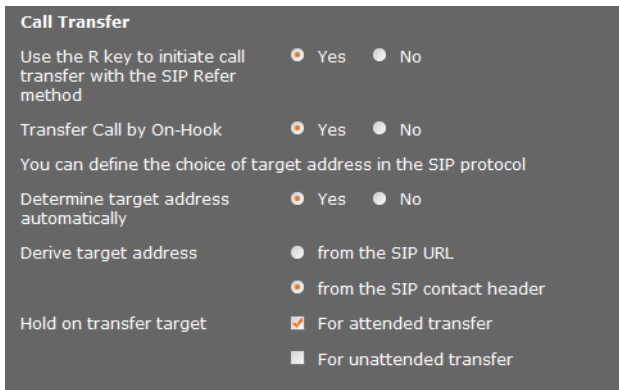

Participants can transfer a call to another participant as long as the PABX/provider supports this function. The call is transferred using the handset menu (via the display key) or using the R key (→ [page 37](#)).

## Configuring the system on the DECT Manager

You can expand or change the settings for call transfer as follows:

- ◆ **Transfer Call by On-Hook:** The two participants are connected with one another when you press the end call key. The intermediary's connections with the participants are terminated.
- ◆ **Use the R key to initiate call transfer with the SIP Refer method:** Deactivate call transfer with the R key if you want to assign a different feature to the R key (see below "**Defining R key functions for VoIP (hook flash)**")
- ◆ Specify how target addresses are selected in the SIP protocol:
  - ▶ **Determine target address automatically**  
The participant is automatically determined by the number entered and the SIP information.
  - ▶ **Derive target address**  
You specify how the target address is to be determined:
    - **from the SIP URL**
    - **from the SIP contact header**

### Please note

For IP telephony, the call is transferred via the SIP protocol.

The unique address is derived from the SIP-URL (SIP-URI). As well as the SIP-URL, the SIP contact header contains additional information for transferring data between the sender and recipient.

- ◆ Specify whether the first call is to continue while the second participant is being called, when a call is forwarded. There are two ways of doing this:
  - **For attended transfer:** This procedure ensures that the call actually takes place.
  - **For unattended transfer:** The first connection to the participant is ended after the call is transferred.

## Defining R key functions for VoIP (hook flash)

**Hook Flash (R-key)**

Please enter the hook flash date, which your service provider has given to you.

Application Type

Application signal

Your PABX/VoIP provider may support special performance features. To make use of these features, your phone needs to send a specific signal (datapacket) to the SIP server. You can assign this "signal" as the R function to the R key on the handsets.

- ▶ Enter the data received from your provider in the **Application Type** and **Application signal** fields.

If the user presses this key during a VoIP call, the signal is sent.

**Please note**

Settings for the R key are only possible if

- The R key has not been activated for call transfer ( → [page 86](#)) and
- SIP Info has been activated ( → [page 84](#)).

**Defining local communication ports (listen ports) for VoIP**

This setting only has to be changed if the port numbers are already being used by other subscribers on the LAN. You can then specify other fixed port numbers for the SIP and RTP port or ranges of numbers for the SIP port.

**Listen ports for VoIP connections**

Use random ports for SIP  Yes  No

SIP port  -

RTP port

The following communication ports are used for VoIP telephony:

**◆ SIP port**

The communication port via which the phone receives (SIP) signalling data. The default standard port number is set to 5060 for SIP signalling. You can use values between 5060 and 6000.

If several VoIP phones are operated on the same router with NAT, it makes sense to use randomly selected ports. The phones must then use different ports so that the router's NAT is only able to forward incoming calls and voice data to one (the intended) phone.

- ▶ Activate **Use random ports** and specify a number range for **SIP port** from which the ports are to be chosen.

**◆ RTP port**

Two consecutive RTP ports (consecutive port numbers) are required for each VoIP connection. Voice data is received via one port and control data via the other. The system uses additional ports for the base station connections (32 ports per DECT module), based on a specified base port. Default setting for the base port: 5004.

The RTP port range calculated for the DECT modules is displayed on the **Own base station data** page ( → [page 68](#)).

**Saving settings**

- ▶ Click on **Set** to save your settings on the page.

## Info services

You can set up various info services provided via the PABX, Gigaset.net or a different server. The info services can be opened via the menu on the handsets (→ [page 52](#)).

The VoIP account's SIP ID and the handset's DECT ID are transferred when requesting info services. This allows the info service server to offer individual settings for each handset.

### Settings → Info Services

**Info Services**

The handset can display info received from a server.

Choose Info Services

- customised Info Service
- via Gigaset.Net
- via PBX Manager

**Settings for the customised RAP Info Service**

Server address for online services

Username

Password

**Settings for PBX Manager**

Server address for PBX Manager menu

Username

Password

**Set** **Cancel**

▶ Select the server for the info services and enter the access data in the relevant fields. Click on **Set** to save your settings on the page.

#### Please note

If the PABX provides a RAP server, additional services may be available in the **Info Centre** and in the **Select Services** menu on the handsets (→ [page 26](#)).



## Online directories

You can make various online directories available so that they can be used and displayed on the handsets:

### ◆ Public Online Directories

A number of well-known providers are available here. Each provider can provide a telephone directory and a classified directory. You can also enter an additional provider.

### ◆ Corporate directories (corporate directories)

You can enter three directories here:

- One directory in LDAP format,
- One general directory in XML format
- One private directory in XML format

Use the handset settings (→ [page 77](#)) to specify which keys are to call up the directories.

## Public Online Directories

Settings → Online directories

| Provider                            | Enable phone book                  |
|-------------------------------------|------------------------------------|
| KT Phonebook                        | <input type="checkbox"/>           |
| Telefoongids                        | <input type="checkbox"/>           |
| Telefonkat.                         | <input type="checkbox"/>           |
| DGS Navne                           | <input type="checkbox"/>           |
| [tel.search.ch]                     | <input type="checkbox"/>           |
| Settings for an additional provider | <input type="button" value="Add"/> |

You can select the online directories from several providers to be displayed on the handset.

- ▶ Tick the required directory providers.
- ▶ Click on the **Add** button to set up an additional provider. You can change the entries for a provider by clicking on the **Edit** button.

## Configuring the system on the DECT Manager

**Settings for an additional provider**

Provider name

Server address

Authentication name

Authentication password

| Type         | Name                 | Activate                 |
|--------------|----------------------|--------------------------|
| White Pages  | <input type="text"/> | <input type="checkbox"/> |
| Yellow Pages | <input type="text"/> | <input type="checkbox"/> |

**Delete settings**

**Set** **Cancel**

- ▶ Enter the provider's details and a name for the provider and the directories. You can choose between the White and Yellow Pages.
- ▶ Click on **Set** to save your settings on the page.

The online directories page is displayed again. The new provider has now been entered in the list.

- ▶ Activate this provider.
- ▶ Click on **Set** to save your settings on this page.

## Corporate directories

You can make online corporate directories for the registered handsets available on a server in LDAP or XML format.

**Settings** → **Online directories**

**Corporate directories**

**Directory via Lightweight Directory Access Protocol (LDAP)**

Directory name

Server address

Server port

Base Distinguished Name

Username

Password

Enable phone book

**Directory via XML protocol**

Directory name

Server address

Username

Password

Enable phone book

Enable a private online directory  Yes  No

### Directory via Lightweight Directory Access Protocol (LDAP)

If your corporate network provides a directory via an LDAP server, set up the function on this page. You will need information about the configuration of the LDAP server to do this.

- ▶ Enter a name in the **Directory name** field. This is the name under which the directory will be displayed on the handsets.

## Configuring the system on the DECT Manager

- ▶ Enter all the data for your LDAP server:

|                                |  |
|--------------------------------|--|
| <b>Server address</b>          | IP address for the LDAP server in your network.                                  |
| <b>Server port</b>             | Port number that is used to provide the LDAP service. The default setting is 389 |
| <b>Base Distinguished Name</b> | Entry at which the directory display/search is to begin.                         |
| <b>Username</b>                | Access ID for the LDAP server.   |
| <b>Password</b>                | Password for the access ID to the LDAP server.                                   |

### Directory via XML protocol

If a corporate directory is provided via an XML server, you will need the access data to set it up.

- ▶ Enter a name in the **Directory name** field. This is the name under which the directory will be displayed on the handsets.
- ▶ Enter the XML server details.

|                       |  |
|-----------------------|--|
| <b>Server address</b> | IP address for the directory.                |
| <b>Username</b>       | Access ID for the directory.                 |
| <b>Password</b>       | Password for the access ID to the directory. |

### Enable a private online directory

- ▶ If a private directory is available on the server in XML format, activate it and enter a name for the directory. The private directory must be provided via the same server as the XML directory.

### Saving settings

- ▶ Click on **Set** to save your settings on the page.

## Device management

### Date and time

By default, the DECT Manager is configured so that the date and time are transferred from a time server on the Internet.

Changes to the settings for the time server and activating/deactivating the synchronisation are done via the Web page:

**Settings → Management → Date & Time**

**Time**

Automatic adjustment of System Time with Time Server  Yes  No

Last synchronisation with time server 18.11.2011 07:14

Time Server

Time Zone

Automatically adjust clock to summer-time changes  Yes  No

You can make the following changes:

- ◆ Enter another time server
- ◆ Deactivate the time server and enter the date and time manually
- ◆ Select the time zone for your location
- ◆ Activate/deactivate automatic adjustment of the clock to summer time

## Additional device settings

This page

**Settings → Management → Miscellaneous**

allows you to configure additional device settings.

### Changing the password for the Web configurator

You should change the password for registering with the WEB configurator for security reasons (up to 20 digits; the default setting is **admin**).

#### Please note

If you have forgotten the password, you will have to reset the device to the factory settings. Further information on this can be found in the **Resetting the device settings** section (→ **page 24**).

### Deactivating LEDs on the base stations

The LEDs on the base stations can be deactivated. Please note that faults in synchronisation and in the DECT network cannot then be localised immediately.

### Starting auto-configuration

The **Auto Configuration** is used to update system settings. It can be started if the manufacturer, operator or supplier of the PABX provides a corresponding file and a code.

### Provider and PABX profiles

A profile contains important settings for services and functions on your telephone system. A profile may be made available by a provider or the operator of the PABX. You can specify on this page whether the device should check for an updated profile regularly and load it onto your system.

## Saving and restoring settings

You can save and restore the system settings via the Web page:

**Settings → Management → Save & Restore**

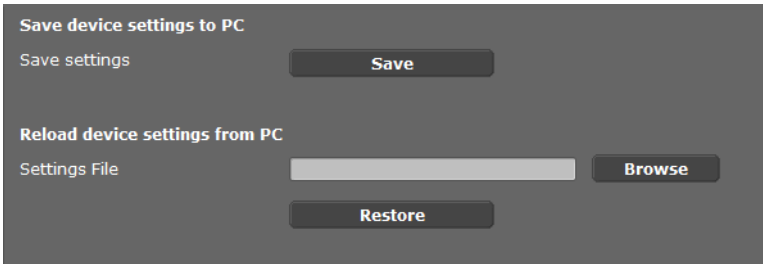

The screenshot shows a web interface with two main sections. The first section, titled 'Save device settings to PC', contains a 'Save settings' label and a 'Save' button. The second section, titled 'Reload device settings from PC', contains a 'Settings File' label, a text input field, a 'Browse' button, and a 'Restore' button.

Once you have configured the DECT Manager and after making any changes to the configuration, particularly registering or deregistering handsets, you should save the latest settings in a file on the PC so that the current system can be restored quickly if problems occur. The file is stored with the suffix .cfg (default: Gigaset-yyyy-mm-dd.cfg).

If you change the settings accidentally or you need to reset the DECT Manager due to a fault, you can reload the saved settings from the file on your PC to your phone. These settings can be restored via the reset button on the device (→ [page 24](#)) or by restoring the firmware's default settings (→ [page 98](#)).

The .cfg file contains all system data with the following exceptions:

- ◆ Handsets' DECT registration data
- ◆ Handsets' call lists

## Rebooting the system

Your Gigaset N720 DECT IP Multicell System can be set to automatically reboot regularly at a convenient time if required as a result of a system check. This does not normally cause the system to become unstable, but if an unforeseeable system error should occur, you can reboot the system manually.

**Settings → Management → Reboot**

### Caution

Only perform this function if the following message is displayed:

**Reboot and system synchronisation are recommended.**

No calls can be made while the phone system is rebooting. Rebooting can take up to a few minutes.

**System Check and Exception Reset**

Reboot and system synchronisation are not necessary at this time.

A reboot can take up to 10 min. During this time calls are not possible.

Reboot system OK

Reboot and synchronisation  daily  optional

The system check determines if a reset is necessary. The check takes place on the selected days at the given time, minimum once per week. If calls are being made, the required reboot is delayed for up to 120 min.

System check every

- Monday
- Tuesday
- Wednesday
- Thursday
- Friday
- Saturday
- Sunday

Start time for system check / Reboot  h  min

### Immediate reboot

▶ Click on **OK** next to **Reboot system**.

The reboot begins immediately. All existing connections are terminated.

### Regular system check

The system regularly checks whether a reboot is necessary. If it determines that a reboot is required, this operation is performed. If a phone call is in progress, the reboot will be postponed by up to two hours.

The check will be performed at the specified time on the selected days, at least once per week.

- ▶ Select a day (or **Daily**) and enter a time for the check. The default setting, controlled by a random generator, is between 12.30 a.m. and 3.30 a.m. on a **Sunday**.
- ▶ Click on **Set** to save your settings on the page.

## System log (SysLog)

The system report (SysLog) gathers information about selected processes performed by the DECT Manager and base stations during operation and sends this to the configured SysLog server.

**Settings → Management → System log**

The screenshot shows the 'System log' configuration page. At the top, it states 'The system log is stored on an external syslog file server.' Below this, there are input fields for 'IP Address' (empty) and 'Server port' (containing '514'). A 'Default' button is positioned below the server port field. An 'Activate Syslog' checkbox is currently unchecked. The page is divided into two sections: 'Set filter for system log' and 'Events from cells'. Each section contains a list of event categories with checkboxes, all of which are currently unchecked.

**System log**

The system log is stored on an external syslog file server.

IP Address

Server port

**Default**

Activate Syslog

**Set filter for system log**

New filter settings are valid for future events.

- System events
- Fault in DECT operating system
- Socket layer events
- SIP events
- DECT events
- E-mail events
- RAP events

**Events from cells**

- System events
- Fault in DECT operating system
- Socket layer events
- DECT events
- Media stream events

- ▶ Enter the **IP Address** and **Server port** for storing the system log on a server (default setting for the server port: 514).
- ▶ Activate the **System log**.
- ▶ Select the DECT Manager and base station data to be sent to the SysLog server.
- ▶ Click on **Set** to save your settings on the page.

The changes take effect with the next system event.



## Updating firmware for the base/downgrading firmware updates

Regular updates to the firmware for the DECT Manager and base stations are provided by the operator or supplier on a configuration server. You can download these updates onto the DECT Manager or base stations as required.

**Settings → Management → Firmware Update**

**Settings for firmware update and downgrade**

Current firmware version of DECT Manager 70.026.00.000.00

The firmware status of cells is shown on the status page.

Data server

Update strategy  simultaneous  sequential

**Set** **Cancel**

Updating the DECT Manager firmware automatically initiates a base station update.

- ▶ Enter the address of the server on which the update is provided in the **Data server** field. You can obtain information on this from the supplier or operator of your system.
- ▶ Specify whether the firmware update for the base stations is to be **simultaneous** or **sequential**. A sequential update uses fewer network resources.

**Start firmware update or downgrade**

Available firmware version of DECT Manager \*\*.026.\*\*\*

Update time  directly  later

Time  h  min

Date  y  m  d

On starting the firmware update, the device checks if the requirements of a successful firmware download are fulfilled. The firmware is then downloaded without additional feedback. During the download and update, the handset / base connection is lost. A successful update results in the handset re-establishing the base connection.

**Update firmware**

You can downgrade the firmware to the former version.

Former version of DECT Manager \*\*.024.\*\*\*

**Start downgrade**

You can downgrade the firmware to the delivery version. All your personal settings will be deleted.

**Start downgrade**

You can load new firmware (update) or restore the firmware to an earlier version (downgrade).

## Configuring the system on the DECT Manager

- ▶ Specify when an update or downgrade should be performed.

**immediately** The update/downgrade is performed when you click the **Update firmware** or **Start downgrade** button.

**later** The update/downgrade is performed at the time you indicate in the lines underneath.

When the download is started, the device first checks whether the prerequisites are in place for successfully downloading the firmware. The handsets lose their connection to the base during the download and updating process. You can tell that the update has been successful when the handsets re-establish the connection to the base.

### Please note

The DECT Manager firmware update can take up to ten minutes. Updating the individual base stations takes approx. 2–3 minutes. Do not disconnect the devices from the local network (or the power supply) during this time.

## Firmware downgrade

You have the following options:

- ◆ You can reload the firmware version that was loaded before the last update on the DECT Manager.
- ◆ You can reload the firmware version that was loaded by default onto the DECT Manager.

The selected firmware is reloaded and the current firmware is overwritten.

### Please note

If you reload the default firmware version, you will lose all the settings you have made in the WEB configurator. You should therefore make a point of saving the configuration data first (→ [page 94](#)).

## DECT Manager and base station status

The **Status** tab displays the following information about the telephone system:

### Status → Device

- ◆ IP and MAC address of the DECT Manager
- ◆ Device Name in the Network
- ◆ Operating days since the system was started
- ◆ Version of the firmware currently loaded for the DECT Manager
- ◆ Version of the firmware available for the DECT Manager
- ◆ Preferred firmware version for the base stations
- ◆ List of base stations with names, firmware version currently loaded, time in days and download status, for DECT modules 1 and 2 respectively
- ◆ Registered base stations and clusters
- ◆ Current date and time, and the time of the last synchronisation with the time server, if time server synchronisation is enabled (→ [page 92](#)).

## Customer care

Questions? For rapid assistance, refer to this user guide or visit [www.gigaset.com/pro](http://www.gigaset.com/pro). The trade outlet where you bought your PABX will be happy to help with further questions relating to your Gigaset Professional PABX.

## Questions and answers

If you have any questions when using your phone, please contact us at <http://wiki.gigaset.com>.

The table below contains a list of common problems and possible solutions.

|  |
|--|
| <p><b>The display is blank.</b></p> <p>Handset is switched off or battery is flat.</p> <ul style="list-style-type: none"> <li>▶ Place the handset in the charger.</li> </ul>   |
| <p><b>You cannot make calls or use other services provided by the phone system (checking eMail, accessing the call list, online directories, info service).</b></p> <ol style="list-style-type: none"> <li>1. Handset is not registered on the phone system.           <ul style="list-style-type: none"> <li>▶ Register the handset ( → <a href="#">page 18</a>).</li> </ul> </li> <li>2. Handset is outside the range of the wireless network.           <ul style="list-style-type: none"> <li>▶ Reduce the distance from the handset to a base station belonging to the wireless network.</li> </ul> </li> <li>3. The firmware is currently being updated.           <ul style="list-style-type: none"> <li>▶ Please wait until the update is complete.</li> </ul> </li> <li>4. Base station is without power.           <ul style="list-style-type: none"> <li>▶ Check the power supply to the base stations and the DECT Manager ( → <a href="#">page 13</a>).</li> <li>▶ If the base is powered by PoE, check the switch's power supply.</li> </ul> </li> <li>5. No resources available from the nearest base station (all connections are busy).           <ul style="list-style-type: none"> <li>▶ Short-term solution: Move to a different location to check whether connections are available at another base station.</li> <li>▶ Long-term solution: Check the plan of the base stations and set up an additional base station at the location with poor wireless coverage.</li> </ul> </li> <li>6. Base stations not synchronised or incorrect synchronisation settings used.           <ul style="list-style-type: none"> <li>▶ Synchronise the base stations.</li> <li>▶ Check that there is a base station assigned synchronisation level 1 in the cluster.</li> <li>▶ Check that each base station can access its superordinate base station wirelessly ( → <a href="#">page 70</a>). If this is not the case, set up additional clusters as required.</li> </ul> </li> </ol> |
| <p><b>Some of the network services do not work as specified.</b></p> <p>Features are not activated.</p> <ul style="list-style-type: none"> <li>▶ Query with the PABX administrator or network provider.</li> </ul>   |
| <p><b>The other party cannot hear you.</b></p> <p>The handset may be muted.</p> <ul style="list-style-type: none"> <li>▶ Unmute the microphone on the handset.</li> </ul>  |
| <p><b>The number of the caller is not displayed despite CLIP/CLI being activated.</b></p> <p>Calling Line Identification is not enabled.</p> <ul style="list-style-type: none"> <li>▶ The <b>caller</b> should ask the network provider to enable Calling Line Identification.</li> </ul>  |

**The connection to a participant on hold is automatically terminated after a short time.**

The session timer on the VoIP PABX is set for an insufficient time.

- ▶ Check the timer setting and increase it if necessary.

**You hear an error tone (descending tone sequence) when keying an input.**

Action has failed/invalid input.

- ▶ Repeat the process.  
Read the display and refer to the user guide if necessary.

**No time is specified for a message in the call list.**

Date/time is not synchronised.

- ▶ Set the date/time on the DECT Manager or
- ▶ Activate synchronisation with a time server on the Internet via the Web configurator.

**You cannot establish a connection to the DECT Manager with your PC's Web browser.**

- ▶ When establishing a connection, check the DECT Manager's local IP address that has been entered. You can check this via the Service menu on a handset (**page 103**).  
If no handset is registered, establish the DECT Manager's IP address when using a dynamic IP address via the DHCP server. You can find the DECT Manager's MAC address on the rear of the housing. If necessary, contact the network administrator for your local network.
- ▶ Check the connections between the PC and the DECT Manager. Transmit a ping command to your base, e.g., from your PC (**ping <DECT Manager's local IP address>**).
- ▶ You have tried to reach the phone via a secure http (<https://...>). Try again with <http://...>

### **Exclusion of liability**

Some displays may contain pixels (picture elements) which remain activated or deactivated. As a pixel is made up of three sub-pixels (red, green, blue); it is possible that pixel colours may vary.

This is completely normal and does not indicate a fault.

## Information on operating Gigaset VoIP telephones with routers with Network Address Translation (NAT)

Generally speaking, no special telephone or router configuration is required when operating a Gigaset VoIP phone with NAT router. The configuration settings described in this section are only necessary if you encounter one of the following problems.

### Typical problems caused by NAT

- ◆ No incoming calls are possible via VoIP. Calls to your VoIP phone number are not put through.
- ◆ Outgoing calls via VoIP are not connected.
- ◆ A connection is established with the other party, but you cannot hear them and/or they cannot hear you.

### Possible solution

- 1 Change the port numbers of the communication ports (SIP and RTP ports) on your phone ( → **"1. Changing the port numbers for SIP and RTP on your VoIP phone"**).
- 2 In some cases, you must also define port forwarding for the phone's communication ports on the router ( → **"2. Setting port forwarding on the router"**).

## 1. Changing the port numbers for SIP and RTP on your VoIP phone

On your VoIP phone system, define different (local) port numbers for the SIP and RTP ports (between 1024 and 49152).

- ◆ These numbers must not be used by any other application or host in the LAN and
- ◆ Must be considerably higher or lower than the SIP and RTP port numbers that you usually use (and are preset on the phone).

This procedure is particularly useful if additional VoIP phones are connected to the router.

**To change the SIP and RTP port numbers on your VoIP phone system, proceed as follows:**

- ▶ Connect your PC's browser to the Web configurator of the DECT Manager and log in.
- ▶ Open the Web page **Settings → Telephony → Advanced VoIP settings** and change the settings for the SIP and RTP ports ( → **page 87**).

To help you remember the new port numbers (e.g., for router configuration), you can choose port numbers that are very similar to the standard settings, e.g.:

|                 |       |            |      |
|-----------------|-------|------------|------|
| <b>SIP port</b> | 49060 | instead of | 5060 |
| <b>RTP port</b> | 49004 | instead of | 5004 |

- ▶ Save the changes on your phone.
- ▶ Wait for the active VoIP connections to be re-registered. To do so, switch to the Web page **Settings → VoIP providers** to see the Status of your VoIP connections.
- ▶ Check to see whether the problem persists. If it does, perform step 2.

## 2. Setting port forwarding on the router

To ensure that your specified SIP and RTP port numbers are used on the WAN interface with the public IP address, you must define port forwarding rules for the SIP and RTP ports on the router.

**To define port forwarding on the router, proceed as follows:**

The terms used below may vary from router to router.

To release a port, you must enter the following details (example):

| Protocol | Public port | Local port | Local host (IP) |         |
|----------|-------------|------------|-----------------|---------|
| UDP      | 49060       | 49060      | 192.168.2.10    | for SIP |
| UDP      | 49004       | 49004      | 192.168.2.10    | for RTP |

### Protocol

Enter **UDP** as the protocol to be used.

### Public port

Port number/port number range on the WAN interface.

### Local port

The SIP and RTP port numbers set on the phone.

You can set an RTP base port for the Gigaset N720 DECT IP Multicell System base stations, from which the system automatically determines the ports required (32 per DECT module) ( → [page 87](#)). You must then also define corresponding port forwarding for this range.

### Local host (IP)

Local IP address of your phone in the LAN. The phone's current IP address is displayed on the router.

To enable the router to perform this port forwarding, the DHCP settings of the router must ensure that the phone is always assigned the same local IP address, i.e., the DHCP does not change the IP address assigned to the phone during operation. Alternatively, you can assign a fixed (static) IP address to the phone. However, you must ensure that this IP address is not within the address range reserved for DHCP and is not assigned to any other LAN subscriber.

## Checking service information

If you contact Customer Care, you may need the base's service information.

**Prerequisite:** You have assigned a line (try to establish a call, make a call).

### Please note

You may need to wait a few seconds before **Options** appears on the display

### **Options** → Service Info

Confirm selection with **OK**.

You can select the following information/functions with :

- 1: Serial number of the DECT Manager (PARI)
- 2: Serial number of the handset (IPUI)
- 3: No information stored; only '---' displayed
- 4: DECT Manager variant (digits 1 and 2)  
Version of the DECT Manager firmware (digits 3 to 5)  
Revision of the DECT Manager firmware (digits 6 and 7)
- 5: No information stored; only '---' displayed
- 6: DECT Manager's device item number
- 7: DECT Manager's IP address

### RFP-Scan

This function can be used during or after installation and enables you to identify the DECT base stations (Gigaset N720 IP PRO) from which a handset receives radio waves at a particular location.

# Environment

---

## Our environmental mission statement

We, Gigaset Communications GmbH, bear social responsibility and are actively committed to a better world. Our ideas, technologies and actions serve people, society and the environment. The aim of our global activity is to secure sustainable life resources for humanity. We are committed to a responsibility for our products that comprises their entire life cycle. The environmental impact of products, including their manufacture, procurement, distribution, utilisation, service and disposal, are already evaluated during product and process design.

Further information on environmentally friendly products and processes is available on the Internet at [www.gigaset.com](http://www.gigaset.com).

## Environmental management system



Gigaset Communications GmbH is certified in accordance with the international standards ISO 14001 and ISO 9001.

**ISO 14001 (Environment):** Certified since September 2007 by TÜV SÜD Management Service GmbH.

**ISO 9001 (Quality):** Certified since 17/02/1994 by TÜV SÜD Management Service GmbH.

## Disposal

Batteries should not be disposed of in general household waste. Observe the local waste disposal regulations, details of which can be obtained from your local authority.

All electrical and electronic products should be disposed of separately from the municipal waste stream via designated collection facilities appointed by the government or the local authorities.



This crossed-out wheeled bin symbol on the product means the product is covered by the European Directive 2002/96/EC.

The correct disposal and separate collection of your old appliance will help prevent potential negative consequences for the environment and human health. It is a precondition for reuse and recycling of used electrical and electronic equipment.

For more detailed information about disposal of your old appliance, please contact your local council refuse centre or the original supplier of the product.



## Appendix

---

### Care

Wipe the unit with a **damp** cloth (do not use solvent) or an antistatic cloth. **Never** use a dry cloth. This can cause static.

Impairments in high-gloss finishes can be carefully removed using display polishes for mobile phones.

### Contact with liquid

If the device has come into contact with liquid:

- 1 Disconnect the power adapter.**
- 2 Allow the liquid to drain from the device.**
- 3 Pat all parts dry. Then leave the device in a warm, dry location for at least 72 hours (not in a microwave, oven or similar).**
- 4 Do not switch on the device again until it is completely dry.**

When it has fully dried out, you will usually be able to use it again.

In rare cases, contact with chemical substances can cause changes to the telephone's exterior. Due to the wide variety of chemical products available on the market, it was not possible to test all substances.

### Authorisation Gigaset N720 IP PRO

Voice over IP telephony is possible via the LAN interface (IEEE 802.3). Depending on your telecommunication network interface, an additional modem could be necessary. For further information please contact your Internet provider.

This device is intended for use within the European Economic Area and Switzerland. If used in other countries, it must first be approved nationally in the country in question. Country-specific requirements have been taken into consideration.

We, Gigaset Communications GmbH, declare that this device meets the essential requirements and other relevant regulations laid down in Directive 1999/5/EC.

A copy of the Declaration of Conformity is available at this Internet address:

[www.gigaset.com/docs](http://www.gigaset.com/docs)

 **0682**

### Authorisation Gigaset N720 DM PRO

We, Gigaset Communications GmbH, declare that this device meets the essential requirements and other relevant regulations laid down in Directives 2004/108/EC and 2006/95/EC. A copy of the Declaration of Conformity is available at this Internet address:

[www.gigaset.com/docs](http://www.gigaset.com/docs)



# Specifications

## Power consumption

|                                       |          |   |
|---------------------------------------|----------|---|
| Gigaset N720 DM PRO<br>(DECT Manager) |          | 2.3 W                                     |
| Gigaset N720 IP PRO<br>(Base station) | Standby: | 3.0 W                                     |
|                                       | Call:    | 3.1 W for one DECT connection             |
|                                       |          | 3.3 W for 8 DECT connections (narrowband) |

## General specifications

| DECT Manager and base stations   |  |
|----------------------------------|--|
| Power over Ethernet              | Gigaset N720 DM PRO: PoE IEEE 802.3af < 3.8 W (Class 1)<br>Gigaset N720 IP PRO: PoE IEEE 802.3af < 6.4 W (Class 2)       |
| LAN interface                    | RJ45 Ethernet, 10/100 Mbps<br>Protection class IP20  |
| Ambient conditions for operation | +5°C to +45°C;<br>20% to 75% relative humidity   |
| Protocols                        | IPv4, SNTP, DHCP, DNS, TCP, UDP, VLAN, HTTP, TLS, SIP, STUN, RTP, MWI, SDP   |
| Base stations                    |  |
| DECT standard                    | DECT EN 300 175-x  |
| Standards                        | GAP / PN-CAP/ CAT-iq 1.0   |
| Radio frequency range            | 1880 – 1900 MHz  |
| No. of channels                  | 120 channels   |
| Number of connections            | 8 simultaneous connections per base station (G.726, G711, G.729ab codec),<br>4 connections in wideband operation (G.722) |
| Range                            | Up to 300 m outdoors, up to 50 m indoors   |
| Codec                            | G.711, G.722, G.726, G.729ab (10 licences)   |
| Quality of Service               | TOS, DiffServ  |

# Glossary

---

## A

### ADSL

Asymmetric Digital Subscriber Line  
Special form of **DSL**.

### ALG

Application Layer Gateway  
NAT control mechanism for a router.

Many routers with integrated NAT use ALG. ALG lets the data packets in a VoIP connection pass and adds the public IP address of the secure private network.

The router's ALG should be deactivated if the VoIP provider offers a STUN server or an outbound proxy.

See also: **Firewall**, **NAT**, **Outbound proxy**, **STUN**.

### Authentication

Restriction of access to a network/service by using an ID and password to log in.

### Automatic ringback

See **Ringback when the number is busy**.

## B

### Block dialling

Enter the complete phone number, and correct it if necessary. Then pick up the earpiece or press the talk/speaker key to dial the phone number.

### Broadband Internet access

See **DSL**.

## C

### Call Forwarding

CF

Automatic forwarding of a call to a different telephone number. There are three kinds of call forwarding:

- CFU, Call Forwarding Unconditional
- CFB, Call Forwarding Busy
- CFNR, Call Forwarding No Reply

### Call swapping

Call swapping allows you to switch between two callers or between a conference and an individual caller without allowing the waiting caller to listen to the call.

### Call waiting

= CW.

Network provider feature. A beep during a call indicates that another caller is waiting. You can accept or reject the second call. You can activate/deactivate the feature.

### CF

Call Forwarding

See **Call Forwarding**.

## Glossary

### Client

Application that requests a service from a server.

### Cluster

Subdivision of a DECT network into groups (subnets) by a central management station (DECT Manager). All telephones in the network use the central functions of the PABX (VoIP configuration, directories, etc.). However, the base stations only synchronise within a cluster, meaning that a handover of a handset from one cluster to a neighbouring cluster is not possible.

If cells cannot synchronise wirelessly, they must be assigned to different clusters so that synchronisation can take place within these clusters. This is required for problem-free use of the DECT system.

### Codec

Coder/decoder

Codec is a procedure that digitises and compresses analogue voice before it is sent via the Internet, and decodes – i.e., translates into analogue voice – digital data when voice packets are received. There are different codecs with differing degrees of compression, for instance.

Both parties involved in the telephone connection (caller/sender and recipient) must use the same codec. This is negotiated between the sender and the recipient when establishing a connection.

The choice of codec is a compromise between voice quality, transmission speed and the necessary bandwidth. A high level of compression, for example, means that the bandwidth required for each voice connection is low. However, it also means that the time needed to compress/decompress the data is greater, which increases execution time for data in the network and thus impairs voice quality. The time required increases the delay between the sender speaking and the recipient hearing what has been said.

### COLP/COLR

Connected Line Identification Presentation/Restriction

Feature provided by a VoIP/ISDN connection for outgoing calls.

COLP displays the phone number accepting the call on the calling party's display unit.

The number of the party accepting the call is different to the dialled number, e.g., if the call is diverted or transferred.

The called party can use COLR (Connected Line Identification Restriction) to prevent the number from appearing on the calling party's display.

### Consultation call

You are on a call. With a consultation call, you interrupt the conversation briefly to establish a second connection to another participant. If you end the connection to this participant immediately, then this was a consultation call. If you switch between the first and second participant, it is called **Call swapping**.

### CW

Call Waiting

See **Call waiting**.

## D

### DECT

Digital Enhanced Cordless Telecommunications  
Global standard for wireless connection of mobile end devices (handsets) to telephone base stations.

### DHCP

Dynamic Host Configuration Protocol  
Internet protocol that handles the automatic assignment of **IP addresses** to **Network subscriber**. The protocol is made available in the network by a server. A DHCP server can, for example, be a router.

The phone contains a DHCP client. A router that contains a DHCP server can assign the IP addresses for the phone automatically from a defined address block. The dynamic assignment means that several **Network subscribers** can share one IP address, although they can only use it alternately and not simultaneously.

With some routers you can specify that the IP address for the phone is never changed.

### Display name

PABX feature. You can specify any name that is to be shown to the other party during a call instead of your phone number.

### DMZ (Demilitarised Zone)

DMZ describes a part of a network that is outside the firewall.

A DMZ is set up, as it were, between a network you want to protect (e.g., a LAN) and a non-secure network (e.g., the Internet). A DMZ permits unrestricted access from the Internet to only one or a few network components, while the other network components remain secure behind the firewall.

### DNS

Domain Name System  
Hierarchical system that permits the assignment of **IP addresses** to **Domain names** that are easier to memorise. This assignment has to be managed by a local DNS server in each (W)LAN. The local DNS server determines the IP address, if necessary by enquiring about superordinate DNS servers and other local DNS servers on the Internet.

You can specify the IP address of the primary/secondary DNS server.

See also: **DynDNS**.

### Domain name

Name of one (of several) Web server(s) on the Internet (e.g., gigaset.com). The domain name is assigned to the relevant IP address by DNS.

### DSCP

Differentiated Service Code Point  
See **Quality of Service (QoS)**.

### DSL

Digital Subscriber Line  
Data transfer technology that allows Internet access with e.g., **1.5 Mbps** over a conventional telephone line. Prerequisites: DSL modem and the appropriate service offered by the Internet provider.

## Glossary

### DSLAM

Digital Subscriber Line Access Multiplexer

The DSLAM is a switch cabinet in an exchange where all subscriber connectors converge.

### DTMF

Dual Tone Multi-Frequency

Dual tone multi-frequency dialling (DTMF).

### Dynamic IP address

A dynamic IP address is assigned to a network component automatically via **DECT**. The dynamic IP address for a network component can change every time it registers or at certain time intervals.

See also: **Static IP address**.

### DynDNS

Dynamic DNS

Domain names and IP addresses are assigned via **DNS**. For **Dynamic IP addresses** this service is enhanced with "Dynamic DNS". This permits the use of a network component with a dynamic IP address as a **Server** on the **Internet**. DynDNS ensures that a service can always be addressed on the Internet under the same **Domain name**, regardless of the current IP address.

## E

### ECT

Explicit Call Transfer

Participant A calls participant B. The participant puts the connection on hold and calls participant C. Rather than connect everyone in a three-party conference, A now transfers participant B to C and hangs up.

### EEPROM

Electrically Erasable Programmable Read Only Memory

Memory building block in your phone with fixed data (e.g., default and customised settings) and data saved automatically (e.g., call list entries).

### Ethernet network

Wired **LAN**.

## F

### Firewall

You can use a firewall to protect your network against unauthorised external access. This involves combining various measures and technologies (hardware and/or software) to control the flow of data between a private network you wish to protect and an unprotected network (e.g., the Internet).

See also: **NAT**.

### Firmware

Device software in which basic information is saved for the functioning of a device. To correct errors or update the device software, a new version of the firmware can be loaded into the device's memory (firmware update).

### Flat rate

Billing system for an **Internet** connection. The Internet provider charges a set monthly fee. There are no additional charges for the duration of the connection or number of connections.

**Fragmentation**

Data packets that are too big are split into smaller packets (fragments) before they are transferred. They are put together again when they reach the recipient (defragmented).

**Full duplex**

Data transmission mode in which data can be sent and received at the same time.

**G****G.711 a law, G.711  $\mu$  law**

Standard for a **Codec**.

G.711 delivers very good voice quality that corresponds to that in the ISDN network.

As there is little compression, the necessary bandwidth is around 64 kbit/s per voice connection, but the delay caused by coding/decoding is only approx. 0.125 ms.

"a law" describes the European standard and " $\mu$  law" describes the North American/ Japanese equivalent.

**G.722**

Standard for a **Codec**.

G.722 is a **wideband** language codec with a bandwidth of 50 Hz to 7 kHz, a net transmission rate of 64 kbit/s per voice connection and integrated speech pause recognition and comfort noise generation (silence suppression).

G.722 delivers very good voice quality. A higher sampling rate provides clearer and better voice quality than other codecs and enables a speech tone in High Definition Sound Performance (HDSP).

**G.726**

Standard for a **Codec**.

G.726 delivers good voice quality. It is inferior to the quality with codec **G.711** but better than with **G.729**.

**G.729A/B**

Standard for a **Codec**.

The voice quality is more likely to be lower with G.729A/B. As a result of the high level of compression, the necessary bandwidth is only around 8 kbit/s per voice connection, but the delay is around 15 ms.

**Gateway**

Connects two different **Networks**, e.g., a router as an Internet gateway.

For phone calls from **VoIP** to the telephone network, a gateway has to be connected to the IP network and the telephone network (gateway/VoIP provider). It forwards calls from VoIP to the telephone network as required.

**Gateway provider**

See **SIP provider**.

**Global IP address**

See **IP address**.

## Glossary

### GSM

Global System for Mobile Communication  
Originally a European standard for mobile networks. GSM can now be described as a worldwide standard. However, in the USA and Japan, national standards were previously more frequently supported.

### H

#### Handover

Possibility for a subscriber with a DECT handset to change from one cell to another during a call or a data connection without interrupting this connection.

#### Headset

Combination of microphone and headphone. A headset enables a comfortable hands free mode. Headsets that can be connected to the base via a cable (wire-bound) or via Bluetooth (wireless) are available.

#### HTTP Proxy

Server via which the **Network subscribers** can process their Internet traffic.

#### Hub

Uses one **Infrastructure network** to connect several **Network subscribers**. All data sent to the hub by one network subscriber is forwarded to all network subscribers.  
See also: **Gateway, Router**.

### I

#### IEEE

Institute of Electrical and Electronics Engineers  
International body that defines standards in electronics and electrical engineering, concerned in particular with the standardisation of LAN technology, transmission protocols, data transfer rate and wiring.

#### Infrastructure network

Network with central structure: All **Network subscribers** communicate via a central **Router**.

#### Internet

Global **WAN**. A series of protocols known as TCP/IP have been defined for exchanging data.

Every **Network subscriber** is identifiable via their **IP address**. **DNS** assigns a **Domain name** to the **IP address**.

Important services on the Internet include the World Wide Web (WWW), eMail, file transfer and discussion forums.

#### Internet Service Provider

Enables access to the Internet for a fee.

#### IP (Internet Protocol)

TCP/IP protocol on the **Internet**. IP is responsible for addressing subscribers in a **Network** using **IP addresses** and routes data from the sender to the recipient. IP determines the paths (routing) along which the data packets travel.



**IP address**

A unique address for a network component within a network based on the TCP/IP protocols (e.g., LAN, Internet). On the **Internet**, domain names are usually assigned instead of IP addresses. **DNS** assigns the corresponding IP address to the domain name. The IP address has four parts (decimal numbers between 0 and 255) separated by full stops (e.g., 230.94.233.2).

The IP address is made up of the network number and the number of the **Network subscriber** (e.g., phone). Depending on the **Subnet mask**, the first one, two or three parts make up the network number and the rest of the IP address addresses the network component. The network number of all the components in any one network must be identical.

IP addresses can be assigned automatically with DHCP (dynamic IP addresses) or manually (fixed IP addresses).

See also: **DECT**.

**IP pool range**

Range of IP addresses that the DHCP server can use to assign dynamic IP addresses.

**L****LAN**

Local Area Network

Network with a restricted physical range. A LAN can be wireless (WLAN) and/or wired.

**Local IP address**

The local or private IP address is the address for a network component in the local network (LAN). The network operator can assign any address they want. Devices that act as a link from a local network to the Internet (gateway or router) have a public and a private IP address.

See also **IP address**.

**Local SIP port**

See **SIP port/Local SIP port**.

**M****MAC address**

Media Access Control address

Hardware address by means of which each network device (e.g., network card, switch, phone) can be uniquely identified worldwide. It consists of six parts (hexadecimal numbers) separated by "-" (e.g., 00-90-65-44-00-3A).

The MAC address is assigned by the manufacturer and cannot be changed.

**Mbps**

Million bits per second

Unit of the transmission speed in a network.

**MRU**

Maximum Receive Unit

Defines the maximum user data volume within a data packet.

**MTU**

Maximum Transmission Unit

Defines the maximum length of a data packet that can be carried over the network at a time.

## Glossary

### Music on hold

Music on hold

Music that is played while you are on a **Consultation call** or during **Call swapping**.  
The waiting participant hears music while on hold.

## N

### NAT

Network Address Translation

Method for converting (private) **IP addresses** to one or more (public) IP addresses. NAT enables the IP addresses of **Network subscribers** (e.g., VoIP telephones) in a **LAN** to be concealed behind a shared IP address for the **Router** on the **Internet**.

VoIP telephones behind a NAT router cannot be reached by VoIP servers (on account of the private IP address). To "get around" NAT, it is possible to use either **ALG** in the router, **STUN** in the VoIP telephone, or for the VoIP provider to use an **Outbound proxy**.

If an outbound proxy is made available, you must allow for this in the VoIP settings for your phone.

### Network

Group of devices. Devices can be connected in either wired or wireless mode.

Networks can also differ in range and structure:

- Range: local networks (**LAN**) or wide-area networks (**WAN**)
- Structure: **Infrastructure network** or ad-hoc network

### Network subscriber

Devices and PCs that are connected to each other in a network e.g., servers, PCs and phones.

## O

### Outbound proxy

Alternative NAT control mechanism to STUN and ALG.

Outbound proxies are implemented by the VoIP provider in firewall/NAT environments as an alternative to **SIP proxy servers**. They control data traffic through the firewall.

Outbound proxy and STUN servers should not be used simultaneously.

See also: **STUN** and **NAT**.

## P

### Paging (handset search)

Base function for locating the registered handsets. The base establishes a connection to every registered handset. The handsets start to ring.

### PIN

Personal Identification Number

Protects against unauthorised use. When the PIN is activated, a number combination has to be entered to access a protected area.

You can protect your base configuration data with a system PIN (4-digit number combination).

**Port**

Data is exchanged between two applications in a **Network** via a port.

**Port forwarding**

The Internet gateway (e.g., your router) forwards data packets from the **Internet** that are directed to a certain **Port** to the port concerned. This allows servers in the **LAN** to offer services on the Internet without you needing a public IP address.

**Port number**

Indicates a specific application of a **Network subscriber**. Depending on the setting in the **LAN**, the port number is permanently assigned or it is assigned with each access.

The combination of **IP address/Port** number uniquely identifies the recipient or sender of a data packet within a network.

**Prepare dialling**

See **Block dialling**.

**Private IP address**

See **Public IP address**.

**Protocol**

Describes the agreements for communicating within a **Network**. It contains rules for opening, administering and closing a connection, about data formats, time frames and possible error handling.

**Proxy/proxy server**

Computer program that controls the exchange of data between **Client** and **Server** in computer networks. If the phone sends a query to the VoIP server, the proxy acts as a server towards the phone and as a client towards the server. A proxy is addressed via **IP address/Domain name** and **Port**.

**Public IP address**

The public IP address is the address for a network component on the Internet. It is assigned by the Internet service provider. Devices that act as a link from a local network to the Internet (gateway, router) have a public and a local IP address.

See also: **IP address, NAT**.

**Q****Quality of Service (QoS)**

Describes the quality of service in communication networks. Differentiations are made between various quality of service classes.

QoS influences the flow of data packets on the Internet e.g., by prioritising data packets, reserving bandwidth and optimising data packets.

In VoIP networks, QoS influences the voice quality. If the whole infrastructure (router, network server etc.) has QoS, the voice quality is better, i.e., fewer delays, less echoing, less crackling.

**R****Registrar**

The registrar manages the current IP addresses of the **Network subscriber**. When you register with your VoIP provider, your current IP address is saved on the registrar. This means you can also be reached when on the move.

### RFP

Radio Fixed Part  
Base stations in a multicell DECT network.

### RFPI

Radio Fixed Part Identity  
ID for a base station in a multicell DECT network. It includes the number (RPN) and an ID for the DECT Manager. A handset uses it to recognise the base stations it is connected to and the DECT network to which it belongs.

### Ringback when the call is not answered

= CCNR (Completion of calls on no reply). If a party does not reply when called, a caller can arrange an automatic ringback. As soon as the destination phone has completed a call and is free again, the caller is called back. This feature must be supported by the exchange. The ringback request is automatically cancelled after about two hours (depending on the network provider).

### Ringback when the number is busy

= CCBS (Completion of calls to busy subscriber). If a caller hears the busy tone, he or she can activate the ringback function. As soon as the connection is free, the caller is called back. As soon as the caller lifts the earpiece, the connection is made automatically.

### Roaming

Possibility for a subscriber with a DECT handset to accept or make calls in all cells of a DECT network.

### ROM

Read Only Memory  
A type of memory that can only be read.

### Router

Routes data packets within a network and between different networks via the quickest route. Can connect **Ethernet networks** and WLAN. Can be a **Gateway** to the Internet.

### Routing

Routing is the transfer of data packets to another subscriber in your network. On their way to the recipient, the data packets are sent from one router to the next until they reach their destination.

If data packets were not forwarded in this way, a network like the Internet would not be possible. Routing connects the individual networks to this global system.

A router is a part of this system; it transfers data packets both within a local network and from one network to the next. Data is transferred from one network to another on the basis of a common protocol.

### RPN

Radio Fixed Part Number  
Number for the base station in a multicell DECT network.

### RTP

Real-Time Transport Protocol  
Global standard for transferring audio and video data. Often used in conjunction with UDP. In this case, RTP packets are embedded in UDP packets.

### RTP port

(Local) **Port** that is used to send and receive voice data packets for VoIP.

## S

### Server

Provides a service to other **Network subscribers (Clients)**. The term can indicate a computer/PC or an application. A server is addressed via **IP address/Domain name** and **Port**.

### SIP (Session Initiation Protocol)

Signalling protocol independent of voice communication. Used for establishing and ending a call. It is also possible to define parameters for voice transmission.

### SIP address

See **URI**.

### SIP port/Local SIP port

(Local) **Port** that is used to send and receive SIP signalling data for VoIP.

### SIP provider

See **VoIP provider**.

### SIP proxy server

IP address of your VoIP provider's gateway server.

### Static IP address

A fixed IP address is assigned to a network component manually during network configuration. Unlike the **Dynamic IP address**, a fixed IP address does not change.

### STUN

Simple Transversal of UDP over NAT  
NAT control mechanism.

STUN is a data protocol for VoIP telephones. STUN replaces the private IP address in the VoIP telephone data packets with the public address of the secure private network. To control data transfer, a STUN server is also required on the Internet. STUN cannot be implemented with symmetric NATs.

See also: **ALG, Firewall, NAT, Outbound proxy**.

### Subnet

Segment of a **Network**.

### Subnet mask

**IP addresses** consist of a fixed line number and a variable subscriber number. The network number is identical for all **Network subscribers**. The size of the network number part is determined in the subnet mask. In the subnet mask 255.255.255.0, for example, the first three parts of the IP address are the network number and the last part is the subscriber number.

### Symmetric NAT

A symmetric NAT assigns different external IP addresses and port numbers to the same internal IP addresses and port numbers – depending on the external target address.

## T

### TCP

Transmission Control Protocol

**Transport protocol**. Session-based transmission protocol: it sets up, monitors and terminates a connection between sender and recipient for transporting data.

## Glossary

### TLS

Transport Layer Security  
Protocol for encrypting data transmissions on the Internet. TLS is a superordinate **Transport protocol**.

### Transmission rate

Speed at which data is transmitted in the **WAN** or **LAN**. The transmission rate is measured in data units per unit of time (Mbit/s).

### Transport protocol

Controls data transport between two communication partners (applications).

See also: **UDP**, **TCP**, **TLS**.

## U

### UDP

User Datagram Protocol

**Transport protocol**. Unlike **TCP**, **UDP** is a non session-based protocol. UDP does not establish a fixed connection. The data packets ("datagrams") are sent as a broadcast. The recipient is solely responsible for making sure the data is received. The sender is not notified about whether it is received or not.

### URI

Uniform Resource Identifier

Character string for identifying resources (e.g., eMail recipient, <http://gigaset.com>, files).

On the **Internet**, URIs are used as a uniform identification for resources. URIs are also described as SIP addresses.

URIs can be entered in the phone as a number. By dialling a URI, you can call an Internet subscriber with VoIP equipment.

### URL

Universal Resource Locator

Globally unique address of a domain on the **Internet**.

A URL is a subtype of the **URI**. URLs identify a resource by its location on the **Internet**. For historical reasons, the term is often used as a synonym for URI.

### User ID

See **User name**.

### User name

Name/number combination for access, e.g., to your VoIP account or your private address directory on the Internet.

## V

### Voice codec

See **Codec**.

### VoIP

Voice over Internet Protocol

Telephone calls are no longer placed and transmitted over the telephone network but over the **Internet** (or other IP networks).

**VoIP provider**

A VoIP, SIP or **Gateway provider** is an Internet service provider that provides a **Gateway** for Internet telephony. As the phone works with the SIP standard, your provider must support the SIP standard.

The provider routes calls from VoIP to the telephone network (analogue, ISDN and mobile) and vice versa.

**W**

**WAN**

Wide Area Network

Wide-area network that is unrestricted in terms of area (e.g., **Internet**).

## Accessories

---

### Power adapter

You only need a power adapter if your devices are not powered by PoE (Power over Ethernet).

EU: Item number: C39280-Z4-C706

UK: Item number: C39280-Z4-C745

### Gigaset N720 SPK PRO (Site Planning Kit)

Equipment for planning and analysing your DECT multicell system. The case contains two calibrated Gigaset S810H handsets and one Gigaset N510 IP PRO base station, plus other useful accessories for measuring the signal quality and wireless coverage on your DECT network.

Item number: S30852-H2316-R101

### Gigaset handsets

Upgrade your telephone system with extra handsets.

Compatibility information → [page 123](#)

#### Gigaset SL610H PRO handset

- ◆ 1.8" TFT colour display
- ◆ Ergonomic keyboard with adjustable backlight and keypad lock
- ◆ Headset connection via Bluetooth® or 2.5 mm jack
- ◆ Bluetooth® and mini USB
- ◆ Directory for 500 vCards
- ◆ Call lists for incoming, outgoing and missed calls
- ◆ Redial list, automatic ringback
- ◆ Talk/standby time of up to 13 h/180 h
- ◆ Large font for call lists and directory
- ◆ Nine programmable keys
- ◆ Brilliant sound quality in handsfree mode with 4 adjustable handsfree profiles
- ◆ Caller pictures and screensaver (analogue and digital clock)
- ◆ Silent alert, 23 ringtones, individual ringtones for VIP contacts and internal calls
- ◆ Calendar with appointment scheduler
- ◆ No interruptions from anonymous calls

[www.gigaset.com/pro/gigaset-sl610hpro](http://www.gigaset.com/pro/gigaset-sl610hpro)





### Gigaset SL400 handset

- ◆ Genuine metal frame and keypad
- ◆ High-quality keypad backlight
- ◆ 1.8" TFT colour display
- ◆ Bluetooth® and mini USB
- ◆ Directory for 500 vCards
- ◆ Talk/standby time of up to 14 hours/230 hours
- ◆ Large font for call lists and directory
- ◆ Brilliant sound quality in speaker mode: 4 adjustable handsfree profiles
- ◆ Caller pictures, slideshow and screensaver (analogue and digital clock)
- ◆ Silent alert, download ring tone melodies
- ◆ Calendar with appointment scheduler
- ◆ Night mode with time-controlled ringtone deactivation
- ◆ No interruptions from anonymous calls
- ◆ Room monitor

[www.gigaset.com/gigasetsl400](http://www.gigaset.com/gigasetsl400)



### Gigaset S810H handset

- ◆ Illuminated graphic colour display (65k colours)
- ◆ Illuminated keypad
- ◆ Speaker
- ◆ Polyphonic ringtone melodies
- ◆ Directory for approx. 500 entries
- ◆ Picture: caller
- ◆ PC interface e.g., for managing directory entries, ringtones and screensavers
- ◆ Bluetooth
- ◆ Headset socket
- ◆ Room monitor

[www.gigaset.com/gigaset810h](http://www.gigaset.com/gigaset810h)



## Accessories

### Gigaset E49H handset

- ◆ Resistant to shocks, dust and water splashes
- ◆ Tough keypad with backlight
- ◆ Colour display
- ◆ Directory for 150 entries
- ◆ Talk/standby time of up to 12 h/250 h, standard batteries
- ◆ Brilliant sound quality in speaker mode
- ◆ Screensaver
- ◆ Alarm clock
- ◆ Room monitor

[www.gigaset.com/gigasete49h](http://www.gigaset.com/gigasete49h)



All accessories and batteries are available from your phone retailer.



Use only original accessories. This will avoid possible health risks and personal injury, and also ensure that all the relevant regulations are complied with.

## Compatibility

The Gigaset N720 DECT IP Multicell System functions described in this user guide are available for the aforementioned handsets provided you have the following version or later:

| Handset            | Version |
|--------------------|---------|
| Gigaset SL610H PRO | 053.01  |
| Gigaset SL400H     | 053.01  |
| Gigaset S810H      | 053.01  |
| Gigaset C610H      | 053.01  |
| Gigaset E49H       | 008     |

### Handset software version

You can find out which software version is loaded on your handset as follows:

 \* Δ # → 0 ▾ 6 MNO # → Open the menu and enter the key sequence \*#06#.

The third line of the display contains a 10-digit number.

Example for a Gigaset SL610H PRO: 8105301000

| Line | Device | Software | Release | Build |                           |
|------|--------|----------|---------|-------|---------------------------|
| 3:   | 81     | 053      | 01      | 000   | = software version 053.01 |

### Updating software

Unless you are using the C610H handset, you can update the software yourself. To do this, you will need:

- ◆ A USB data cable. Use this to connect the Mini USB connection on your phone to your PC.
- ◆ The "Gigaset Quick Sync" program. You can obtain this free of charge on the Internet by visiting the Downloads page for your handset at [www.gigaset.com](http://www.gigaset.com).

You will find a detailed description of the software update process in the user guide for your handset.

### Compatibility with other handsets

The following functions are available on other GAP-compatible handsets:

- ◆ Registering on the Gigaset N720 DECT IP Multicell System → **page 18**
- ◆ Assigning a line (pressing the talk key)
- ◆ Releasing a line (ending the call)
- ◆ Initiating a call by:
  - Entering a number, pressing the talk key or
  - Pressing the talk key, entering the number → **page 29**.
- ◆ Accepting a call → **page 31**
- ◆ Sending DTMF signals → **page 84**
- ◆ Transferring calls using the R key → **page 85**

Further information relating to the functions of the handsets in connection with the Gigaset base stations can be found on the **Service** page at [www.gigaset.com/pro/gigasetn720](http://www.gigaset.com/pro/gigasetn720) on the Internet.

# Index

---

## A

|  |        |
|--|--------|
| Access code .....                        | 82     |
| Accessories .....                        | 120    |
| ADSL .....                               | 107    |
| ALG .....                                | 107    |
| Alternative options, Web configurator .. | 62     |
| Application Layer Gateway (ALG) .....    | 107    |
| Approval                                 |        |
| Gigaset N720 IP PRO .....                | 105    |
| Area code .....                          | 29, 83 |
| Asymmetric Digital Subscriber Line ....  | 107    |
| Authentication .....                     | 107    |
| Authorisation .....                      | 105    |

## B

|                                   |        |
|-----------------------------------|--------|
| Base station. ....                | 6      |
| activating .....                  | 69     |
| configuring .....                 | 68     |
| connection to DECT Manager,       |        |
| LED display .....                 | 23     |
| displaying list .....             | 69     |
| events .....                      | 71     |
| installing .....                  | 11     |
| LEDs .....                        | 23     |
| organising clusters .....         | 70     |
| overloaded, display via LED ..... | 23     |
| registering .....                 | 17, 67 |
| removing from DECT network .....  | 70     |
| resetting .....                   | 24     |
| status .....                      | 68     |
| synchronisation status .....      | 23     |
| synchronising .....               | 17     |
| Base stations                     |        |
| synchronising .....               | 70     |
| Block dialling .....              | 107    |
| Broadband connections .....       | 36     |
| Broadband Internet access .....   | 107    |
| Broadband voice codec .....       | 111    |
| Busy .....                        | 30     |
| Buttons, Web configurator .....   | 62     |

## C

|                      |    |
|----------------------|----|
| Call                 |    |
| accepted .....       | 44 |
| accepting .....      | 31 |
| display on LED ..... | 22 |
| ending .....         | 30 |

|  |         |
|--|---------|
| in call list .....                     | 44      |
| missed .....                           | 44      |
| outgoing .....                         | 44      |
| transferring (connecting) .....        | 35      |
| Call divert .....                      | 107     |
| Call divert, see                       |         |
| Call transfer                          |         |
| Call duration .....                    | 30      |
| Call Forwarding .....                  | 107     |
| Call forwarding                        |         |
| activating/deactivating .....          | 37      |
| Call list .....                        | 44      |
| accepted calls .....                   | 44      |
| all calls .....                        | 44      |
| deleting .....                         | 45      |
| deleting an entry .....                | 45      |
| dialling a number .....                | 45      |
| missed calls .....                     | 44      |
| opening .....                          | 44      |
| outgoing calls .....                   | 44      |
| saved information .....                | 44      |
| transferring entry to directory .....  | 45      |
| Call manager .....                     | 80      |
| Call restrictions .....                | 82      |
| Call swapping .....                    | 34, 107 |
| Call transfer                          |         |
| configuring .....                      | 85      |
| Call Waiting .....                     | 108     |
| Call waiting .....                     | 33, 107 |
| activating/deactivating .....          | 37      |
| Calling .....                          | 29      |
| anonymous .....                        | 35      |
| from online directory .....            | 43      |
| from Yellow Pages .....                | 43      |
| Calling Line Identification .....      | 31, 45  |
| Care of the telephone .....            | 105     |
| Certificate .....                      | 71      |
| Certificate error .....                | 48      |
| CF .....                               | 107     |
| Checkboxes, Web configurator .....     | 62      |
| Checking service information .....     | 103     |
| CLI, CLIP (Calling Line Identification |         |
| Presentation) .....                    | 31      |
| Client .....                           | 108     |
| CLIP picture .....                     | 31      |
| CLIP, call lists .....                 | 45      |

- Cluster ..... 7, 108
  - configuring..... 70
- CNIP ..... 31
- Codec
  - G.711  $\mu$  law..... 78
  - G.711 a law ..... 78
  - G.722 ..... 78
  - G.726 ..... 78
  - G.729 ..... 78
  - selecting for handset ..... 78
- Codecs ..... 108
- COLP..... 30, 108
- COLR..... 30, 108
- Communication port ..... 87
- Configuring call transfer ..... 35
- Connected Line Identification
  - Presentation/Restriction..... 30, 108
- Connecting the PC to the Web configurator
  - 58
- Connections, busy..... 30
- Consultation call ..... 108
- Consumption of electricity, see Power
  - consumption
- Contact with liquid ..... 105
- Corporate directory
  - configuring..... 91
  - dialling number..... 40
  - opening..... 40
  - personal..... 40
  - searching for entry..... 40
- Customer care ..... 99
- CW..... 108
- D**
- Data packets, fragmentation ..... 111
- Data protection notice..... 14
- Date ..... 92
  - synchronisation..... 56
- Deactivating the ringtone..... 38
- DECT Manager..... 6
  - connecting to LAN ..... 58
  - device name..... 65
  - installing ..... 11
  - LAN configuration ..... 64
  - LEDs ..... 22
  - resetting ..... 24
  - status ..... 98
  - status of connection to
    - base stations, LED display ..... 22
- Deleting
  - base station ..... 70
- Deletion
  - handset ..... 81
- Demilitarised Zone ..... 109
- De-registering
  - handset ..... 81
- Device name in network ..... 65
- DHCP ..... 25, 109, 110
- Diagnostics, base stations..... 71
- Dialling plans
  - access codes..... 82
  - call barring ..... 82
- Differentiated Service Code Point..... 109
- Digital Subscriber Line..... 109
  - Access Multiplexer ..... 110
- Directory
  - accessing..... 39
  - company..... 40, 91
  - configuring..... 89
  - LDAP format..... 91
  - online..... 89
  - private..... 92
  - public..... 41
  - using ..... 39
  - XML format..... 92
- Directory file
  - content (vCard format) ..... 80
- Directory, local
  - exporting ..... 79
  - importing ..... 79
  - transferring to/from PC..... 79
- Display
  - caller's number (CLI/CLIP)..... 31
  - name (CNIP) ..... 31
  - number called (COLP) ..... 30
- Display keys, assigning ..... 56
- Display name (VoIP account) ..... 109
- Disposal..... 104
- DMZ ..... 109
- DND (Do Not Disturb) see Do
  - Not Disturb
- DNS..... 109
- DNS server
  - alternate ..... 65
  - preferred ..... 65
- Do not disturb ..... 38
- Domain name ..... 109
- Domain Name System ..... 109

## Index

|  |        |
|--|--------|
| Downgrade, firmware .....                          | 97     |
| DSCP .....   | 109    |
| DSL .....  | 109    |
| DSLAM .....  | 110    |
| DTMF .....   | 84     |
| Dynamic DNS .....                                  | 110    |
| Dynamic Host Configuration<br>Protocol .....       | 109    |
| Dynamic IP address .....                           | 110    |
| base station .....                                 | 68     |
| DECT Manager .....                                 | 64     |
| DynDNS .....                                       | 110    |
| <b>E</b>   |        |
| eMail .....  | 48     |
| deleting .....                                     | 51     |
| messages while connecting .....                    | 49     |
| notification .....                                 | 48     |
| viewing the sender's address .....                 | 51     |
| eMail account<br>configuring for handset .....     | 81     |
| Ending<br>call .....                               | 30     |
| Ethernet network .....                             | 110    |
| Explicit Call Transfer .....                       | 110    |
| <b>F</b>   |        |
| Factory settings .....                             | 24     |
| Firewall .....                                     | 110    |
| Firmware .....                                     | 110    |
| downgrading .....                                  | 98     |
| updates .....                                      | 11     |
| updating .....                                     | 97     |
| Firmware update, base station<br>LED display ..... | 23     |
| Firmware update, DECT Manager<br>LED display ..... | 22     |
| Flat rate .....                                    | 110    |
| Fragmentation of data packets .....                | 111    |
| Full duplex .....                                  | 111    |
| <b>G</b>   |        |
| G.711 .....  | 78     |
| G.722 .....  | 36, 78 |
| enabling .....                                     | 84     |
| G.726 .....  | 78     |
| G.729 .....  | 78     |
| activating .....                                   | 85     |
| Gateway .....                                      | 111    |
| Gateway provider .....                             | 111    |

|   |     |
|---|-----|
| Gigaset HDSP, see HDSP                          |     |
| Gigaset N720 DECT IP Multicell System .....     | 6   |
| Gigaset N720 DM PRO .....                       | 6   |
| Gigaset N720 IP PRO .....                       | 6   |
| Gigaset N720 SPK PRO (Site Planning Kit) .....  | 8   |
| item number .....                               | 120 |
| Gigaset.net .....                               | 88  |
| gigaset-config.com .....                        | 58  |
| Global IP address .....                         | 111 |
| Global System for<br>Mobile Communication ..... | 112 |
| GSM .....                                       | 112 |

## H

|                                    |         |
|------------------------------------|---------|
| Handover .....                     | 7       |
| Handset .....                      | 7, 123  |
| advanced settings .....            | 77      |
| assigning display keys .....       | 56      |
| assigning network mailbox .....    | 78      |
| assigning online directories ..... | 77      |
| compatibility .....                | 123     |
| configuring .....                  | 75      |
| deleting .....                     | 81      |
| de-registering .....               | 81      |
| menu .....                         | 26      |
| registering .....                  | 75      |
| setting .....                      | 56      |
| software version .....             | 123     |
| updating software .....            | 123     |
| voice quality .....                | 78      |
| Handsets, recommended .....        | 120     |
| HDSP .....                         | 36      |
| Headset .....                      | 112     |
| Help .....                         | 99      |
| HTTP Proxy .....                   | 66, 112 |
| Hub .....                          | 112     |

## I

|                                      |     |
|--------------------------------------|-----|
| IEEE .....                           | 112 |
| Info Center .....                    | 52  |
| operating .....                      | 54  |
| Info centre<br>starting .....        | 52  |
| Info service .....                   | 52  |
| configuring .....                    | 88  |
| personalised .....                   | 53  |
| Infrastructure network .....         | 112 |
| Input fields, Web configurator ..... | 62  |

- Installation
  - base station ..... 11
  - DECT Manager..... 11
- Institute of Electrical and Electronics Engineers..... 112
- INT key ..... 39
- Internet ..... 112
- Internet access (broadband) ..... 107
- Internet protocol..... 112
- Internet Service Provider..... 112
- IP ..... 112
- IP address ..... 113
  - dynamic..... 64, 110
  - establishing DECT Manager's ..... 59
  - global..... 111
  - local ..... 113
  - private ..... 115
  - public..... 115
  - reset via hardware reset ..... 24, 25
  - static..... 64, 117
  - static, base station ..... 69
- IP address type
  - base station ..... 68
  - DECT Manager..... 64
- IP pool range ..... 113
- K**
- Key, assigning..... 56
- L**
- LAN ..... 113
- LAN configuration..... 64
- LAN connection, status display via LED.. 22
- LAN port ..... 14
- Language ..... 59
- LDAP
  - displaying contacts on screen ..... 40
  - format, directory ..... 89
  - server..... 91
  - server address ..... 91
  - server port ..... 91
- LDAP (Lightweight Directory Access Protocol) ..... 40
- LED
  - active calls..... 22
  - base station ..... 23
  - base station overload..... 23
  - base station, connection to
    - DECT Manager ..... 23
    - DECT Manager..... 22
  - DECT Manager, connection to
    - base station ..... 22
    - firmware update ..... 22
- Light emitting diodes see LED
- List
  - eMail notifications ..... 48
  - network mailbox..... 47
- Listen port, see Communication port
- Lists, Web configurator ..... 62
- Local Area Network..... 113
- Local IP address ..... 113
- Local SIP port ..... 117
- M**
- MAC address..... 113
- MAC address cascading..... 14
- Making calls
  - accepting a call ..... 31
  - calling ..... 29
- Maximum Receive Unit ..... 113
- Maximum Transmission Unit ..... 113
- Mbps ..... 113
- Media Access Control..... 113
- Medical equipment .....9
- Menu bar, Web configurator ..... 61
- Menu overview
  - handsets ..... 26
  - Web configurator ..... 63
- Message
  - deleting (eMail) ..... 51
  - playing back (network mailbox) ..... 47
- Message key..... 46, 48
- Message list
  - eMail..... 48
  - network mailboxes..... 47
- Messages..... 46
- Million bits per second ..... 113
- Missed call
  - in call list ..... 44
- MRU ..... 113
- MTU ..... 113
- Multicell system.....6
- Music on hold..... 114
- N**
- Name
  - display name (VoIP) ..... 109
  - displaying caller's name (CNIP) ..... 31
- NAT ..... 114
- symmetric..... 117

## Index

|                                       |     |
|---------------------------------------|-----|
| Navigation area, Web configurator     | 61  |
| Network                               | 114 |
| Ethernet                              | 110 |
| Network Address Translation           | 114 |
| Network mailbox                       | 46  |
| assigning                             | 78  |
| calling, fast access                  | 47  |
| calling, message key                  | 47  |
| calling, via menu                     | 47  |
| list                                  | 47  |
| Network services                      | 37  |
| Notification                          |     |
| incoming eMail                        | 48  |
| Number                                |     |
| dialling from call list               | 45  |
| dialling from corporate directory     | 40  |
| dialling from online directory        | 43  |
| displaying caller's (CLIP)            | 31  |
| <b>O</b>                              |     |
| Online directory                      | 41  |
| assigning                             | 77  |
| configuring                           | 89  |
| dialling number                       | 43  |
| opening                               | 41  |
| public                                | 89  |
| searching for entry                   | 41  |
| Opening incoming message list (eMail) | 48  |
| Opening the incoming eMail list       | 48  |
| Options, Web configurator             | 62  |
| Outbound proxy                        | 114 |
| <b>P</b>                              |     |
| PABX (VoIP)                           | 7   |
| Package contents                      | 10  |
| Paging                                | 114 |
| Password                              | 59  |
| changing                              | 93  |
| resetting                             | 24  |
| PC address book entries,              |     |
| transferring to directory             | 79  |
| Personal Identification Number        | 114 |
| Phone number                          |     |
| displaying number called (COLP)       | 30  |
| Phone number display, notes           | 32  |
| PIN                                   | 114 |
| PoE (Power over Ethernet)             | 12  |
| Port                                  | 115 |
| Port forwarding                       | 115 |
| Port number                           | 115 |

|                        |     |
|------------------------|-----|
| Power adapter          | 9   |
| connecting             | 13  |
| item number            | 120 |
| safety                 | 9   |
| Power consumption      | 106 |
| Prepare dialling       | 115 |
| Priority of voice data | 67  |
| Private IP address     | 115 |
| Protocol               | 115 |
| Proxy                  | 115 |
| Proxy-Server           | 115 |
| Public IP address      | 115 |

## Q

|                       |     |
|-----------------------|-----|
| Quality of Service    | 115 |
| Questions and answers | 99  |

## R

|                                    |         |
|------------------------------------|---------|
| R key, function for VoIP           | 86      |
| Read Only Memory                   | 116     |
| Reboot, system                     | 95      |
| Registering, with Web configurator | 59      |
| Registrar                          | 115     |
| Registration, handset              | 75      |
| Remote management                  | 72      |
| Reset                              | 24      |
| dynamic IP configuration           | 25      |
| static IP configuration            | 24      |
| to factory settings                | 24      |
| reset                              | 24      |
| Reset button                       | 24      |
| Restore, see Reset                 |         |
| RFC 2833 (DTMF signalling)         | 84      |
| RFP (Radio Fixed Part)             | 116     |
| RFPI (Radio Fixed Part Identity)   | 116     |
| RFPN (Radio Fixed Part Number)     | 116     |
| Ringback                           |         |
| switching function off if busy     | 33      |
| when the call is not answered      | 116     |
| when the number is busy            | 33, 116 |
| Roaming                            | 7, 116  |
| ROM                                | 116     |
| Router                             | 116     |
| Routing                            | 116     |
| RTP                                | 116     |
| RTP port                           | 116     |
| <b>S</b>                           |         |
| Safety precautions                 | 9       |
| Scope of delivery                  | 10      |
| Secure data connections            | 71      |



|  |         |  |        |
|--|---------|--|--------|
| Security warning .....                 | 14      | Transmission rate .....                      | 118    |
| Sender's address (eMail) .....         | 51      | Transport Layer Security .....               | 118    |
| Server .....                           | 117     | Transport protocol .....                     | 118    |
| Setting the date .....                 | 56      | Troubleshooting .....                        | 99     |
| Setting the time .....                 | 56      | eMail .....                                  | 49     |
| Shared directories, see                |         | general .....                                | 99     |
| Corporate directory                    |         | <b>U</b>                                     |        |
| Silence, suppressing .....             | 85      | UDP .....                                    | 118    |
| Simple Transversal of UDP over NAT ... | 117     | Uniform Resource Identifier .....            | 118    |
| SIP .....                              | 117     | Universal Resource Locator .....             | 118    |
| SIP address .....                      | 117     | Update, firmware .....                       | 97     |
| SIP port .....                         | 117     | Updating software .....                      | 123    |
| SIP provider .....                     | 117     | URI .....                                    | 118    |
| SIP proxy server .....                 | 117     | URL .....                                    | 118    |
| Software version, handset .....        | 123     | User Datagram Protocol .....                 | 118    |
| Speaker key .....                      | 29      | User ID .....                                | 118    |
| Specifications .....                   | 106     | User name .....                              | 118    |
| Speech pauses, suppressing .....       | 85      | Using a corporate directory .....            | 40, 91 |
| Standard gateway .....                 | 65      | Using the redial list .....                  | 44     |
| Static IP address .....                | 117     | <b>V</b>                                     |        |
| base station .....                     | 69      | vCard format .....                           | 80     |
| DECT Manager .....                     | 64      | vcf file .....                               | 79     |
| Structure of IP address .....          | 113     | VLAN (Virtual Local Area Network) .....      | 66     |
| Structure of Web pages .....           | 60      | VLAN tagging .....                           | 66     |
| STUN .....                             | 117     | Voice over Internet Protocol .....           | 118    |
| Subject (eMail), reading .....         | 50, 51  | Voice quality .....                          | 78     |
| Subnet .....                           | 117     | VoIP .....                                   | 118    |
| Subnet mask .....                      | 65, 117 | communication port .....                     | 87     |
| Symmetric NAT .....                    | 117     | indication of service availability via LED22 |        |
| Synchronisation .....                  | 17, 70  | VoIP call                                    |        |
| display via LED .....                  | 23      | local area code .....                        | 83     |
| Synchronisation hierarchy .....        | 17      | VoIP PABX .....                              | 6      |
| SysLog .....                           | 96      | entering on DECT Manager .....               | 73     |
| System .....                           | 56      | VoIP provider .....                          | 119    |
| System report (SysLog) .....           | 96      | configuring .....                            | 73     |
| System, reboot .....                   | 95      | loading profile .....                        | 73     |
| <b>T</b>                               |         | <b>W</b>                                     |        |
| Talk key .....                         | 29      | Wall mounting .....                          | 16     |
| TCP .....                              | 117     | WAN .....                                    | 119    |
| Telephone system                       |         | Web configurator                             |        |
| overview .....                         | 6       | buttons .....                                | 62     |
| setting up .....                       | 17      | connecting with PC .....                     | 58     |
| status .....                           | 98      | logging in .....                             | 59     |
| Time .....                             | 92      | menu .....                                   | 63     |
| synchronisation .....                  | 56      | password .....                               | 59     |
| Time server .....                      | 92      | selecting language .....                     | 59     |
| TLS .....                              | 118     | setup and UI elements .....                  | 60     |
| Tone selection .....                   | 83      |  |        |
| Transmission Control Protocol .....    | 117     |  |        |

## Index

|                                      |     |
|--------------------------------------|-----|
| Web page                             |     |
| structure .....                      | 60  |
| Wide Area Network.....               | 119 |
| Withholding number .....             | 35  |
| Working area, Web configurator ..... | 62  |

## X

|                             |    |
|-----------------------------|----|
| XML format, directory ..... | 89 |
| XML, server address .....   | 92 |

## Y

|                   |    |
|-------------------|----|
| Yellow Pages..... | 41 |
|-------------------|----|

## Z

|                 |     |
|-----------------|-----|
| Zulassung ..... | 105 |
|-----------------|-----|

**Issued by**

Gigaset Communications GmbH  
Frankenstraße 2a, D-46395 Bocholt

© Gigaset Communications GmbH 2012

All rights reserved. Subject to availability.  
Rights of modification reserved.

[www.gigaset.com](http://www.gigaset.com)

A31008-M2314-L101-2-7619