

NEC

Window (Room) Air Conditioner User Manual



RWC-3217
RWC-4717







Thank you very much for purchasing **NEC** Air Conditioner.
Before installing and using this appliance, please read this User
Manual carefully, and keep it for future reference.



CONTENTS

Safety Precautions	2
Parts Name	3
Operating Instructions	5
Care and Maintenance	8
Operation Tips	9
Trouble Shooting	10
Installation Instructions	11

Safety Precautions

Symbols in this User's Manual are interpreted as shown below:

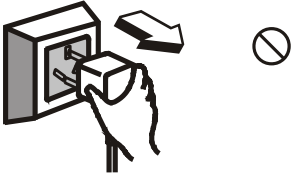
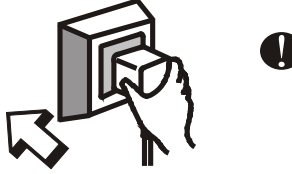
-  Be sure not to do.
-  Be sure to follow the instruction.
-  The feature of the appliance, instead of a fault.
-  Grounding is necessary.
-  Pay attention to such a situation.
-  Warning: Incorrect handling could cause a serious hazard, such as death, serious injury, etc.

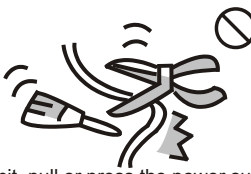
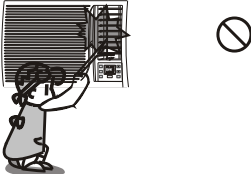
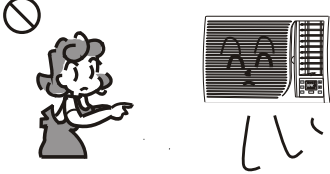
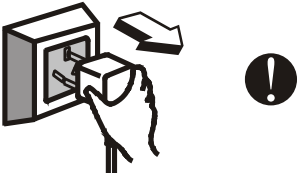
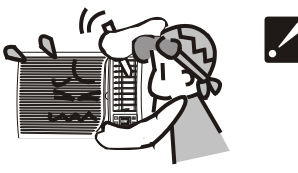
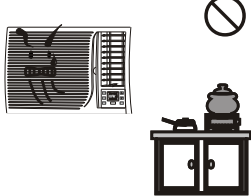
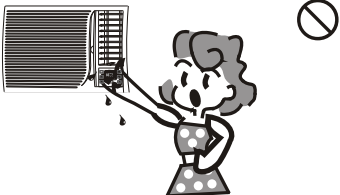
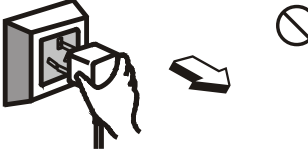
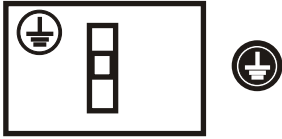
 <p>Do not use the power supply circuit breaker or pull off the plug to turn it off during operation. This may cause a fire due to spark, etc.</p>	 <p>Keep the power supply circuit breaker or plug from dirt. Connect the power supply cord to it firmly and correctly, lest an electric shock or a fire break out due to insufficient contact.</p>	 <p>Use correct power supply according to the rating plate. Otherwise, serious faults may occur or a fire may break out.</p>
 <p>Do not knit, pull or press the power supply cord, lest the power supply cord be broken. An electric shock or fire is probably caused by a broken power supply cord.</p>	 <p>Never insert a stick or similar to the unit. Since the fan rotates at high speed, this may cause an injury.</p>	 <p>It is harmful to your health if the cool air reaches you for a long time. It is advisable to let the air flow be deflected to all the room.</p>
 <p>Turn off the appliance first before cutting off power supply when malfunction occurs.</p>	 <p>Do not repair the appliance by yourself. If this is done incorrectly, it may cause an electric shock, etc.</p>	 <p>Prevent the air flow from reaching the gas burners and stove.</p>
 <p>Do not touch the operation buttons when your hands are wet.</p>	 <p>Pull off the plug to stop it when the operation is abnormal (a peculiar odor is smelled, etc.), or it may cause an electric shock, etc.</p>	 <p>It is the user's responsibility to make the appliance be grounded according to local codes or ordinances by a licenced person.</p>

Parts Name

Front view

► For remote control model

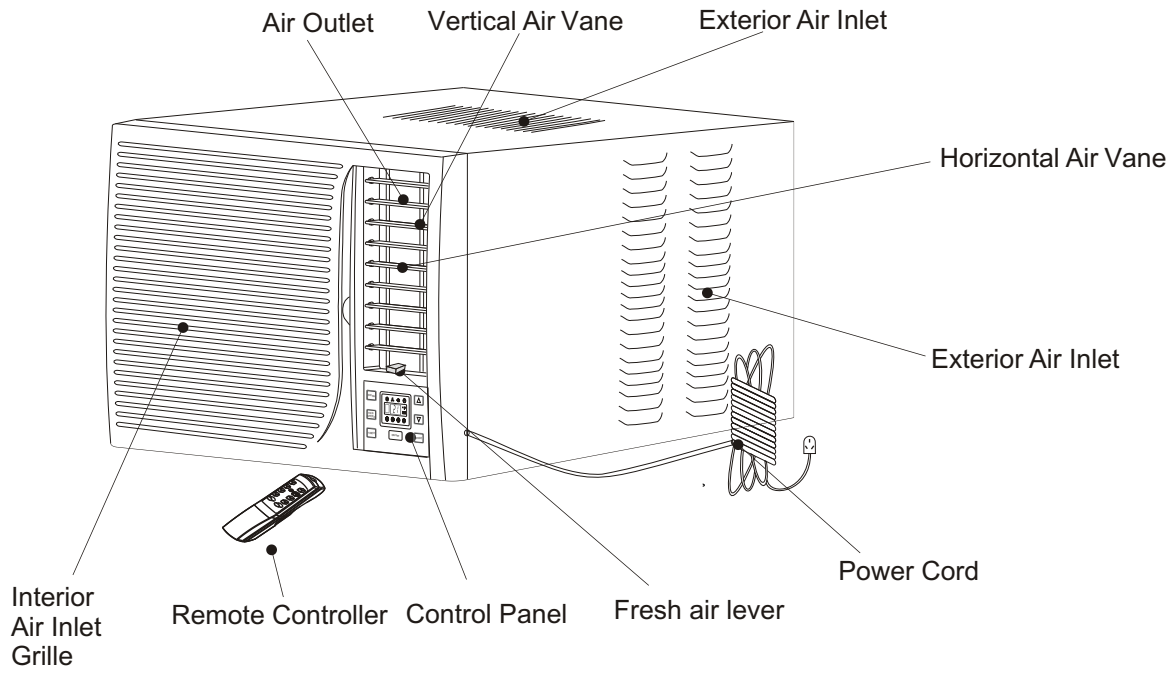
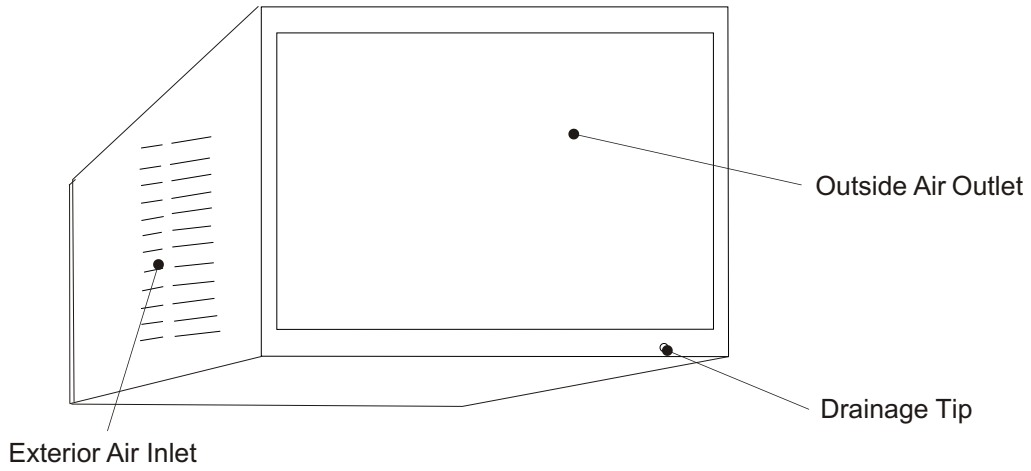

Fig. 1

Note: The figure in this manual are based on the external view of a standard model. Consequently, the shape may differ from that of the air conditioner you have selected.

Parts Name

Back view



Fresh air lever

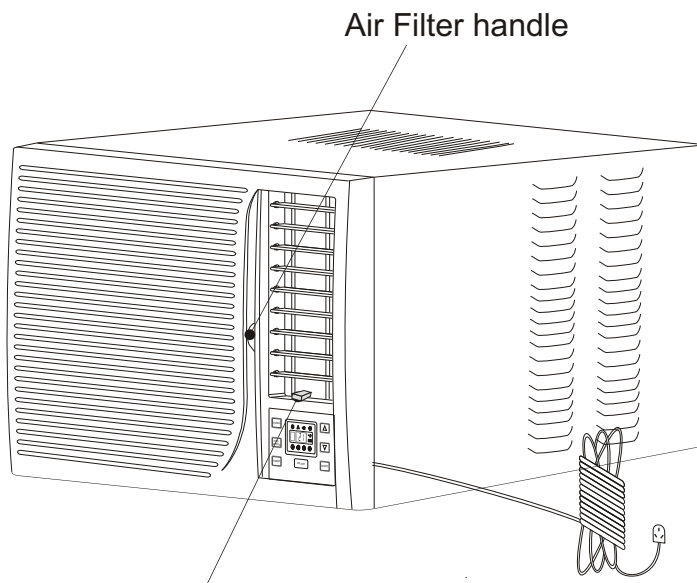

Fresh air lever

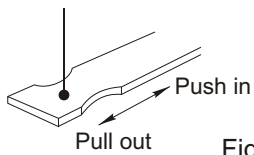

Fresh air lever

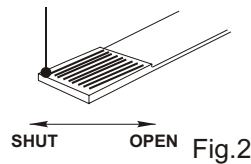

Shut the fresh air door to achieve the best cooling effect and open it to introduce fresh air into the room if the air is foul inside .

Operating Instructions

► Remote Control Model

You can easily operate this air conditioner by pressing relevant button on the control panel as well as the remote controller.

ON/OFF button

The air conditioner will be started when it is energized or will be stopped when it is in operation, if you press this button.

MODE button

Each time MODE button is pressed, the operation mode is changed in sequence:

COOLING→FAN ONLY→ENERGY SAVING→COOLING

NOTE: After setting the mode, allow 3 minutes before switching to another mode.

FAN SPEED button

Used to select fan speed in sequence auto, low, medium and high.

TIMER button

Used to set or cancel timer operation.

When the unit is in operation, you can set OFF TIMER. When the unit is off, you can set ON TIMER. Timer setting range is 0 to 24 hours.

If the OFF TIMER is set, the timer LED displays the remaining time to turn off the unit for only 12 seconds, then LED shifts to display set temperature.

If the ON TIMER is set, the timer LED displays the remaining time to turn on the unit.

If you want to cancel ON TIMER, press TIMER button again.

▲ ▼ Button

Used to set room temperature in COOLING mode or used to set time in TIME R mode.

If the two keys are pressed at the same time, the temperature LED display will alternate between °C and °F.

But the mark of "°C" or "°F" you can not change. Usually, those models used 220V~/50Hz marked with "°C", others models marked with "°F".

NOTE: Temperature setting range is from 19°C(66°F) to 31°C(88°F).

SWING button

Used to select start or stop vertical air vanes swinging.

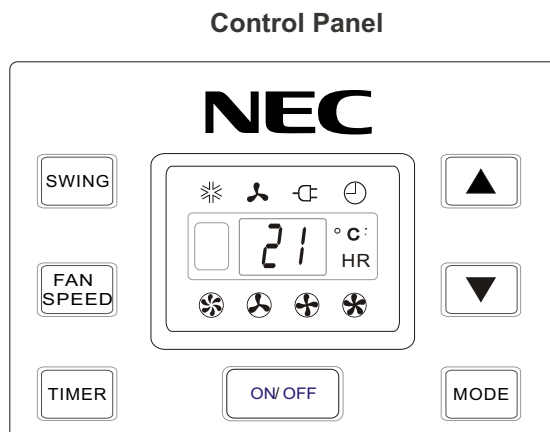

Indication symbols of LED on control panel:

- | | | |
|------------------|---------------|---------------------------------------|
| Auto fan speed | Cooling | Display set temp
Display set timer |
| Low fan speed | Fan only | |
| Medium fan speed | Timer | |
| High fan speed | Energy-saving | |

Above LED lights on when the relevant mode is in used.

Operating Instructions

► Remote Controller

The remote controller transmits signals to the system.

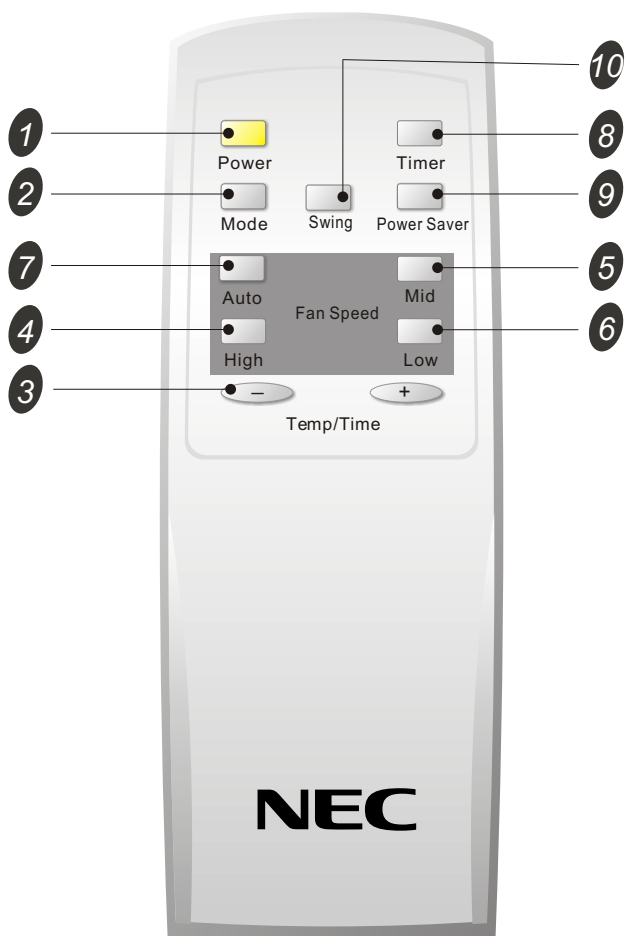

- 1 POWER Button**
The appliance will start when it is energized or will stop when it is in operation, if you press this button.
- 2 MODE Button**
Used to select the operation mode.
- 3 + - Buttons**
Used to set room temperature in COOLING mode or used to set time in TI MER mode.
- 4 HIGH Button**
Used to select the high fan speed mode.
- 5 MID Button**
Used to select the Mid fan speed mode.
- 6 LOW Button**
Used to select the Low fan speed mode.
- 7 AUTO Button**
Used to select the Auto fan speed mode.
- 8 TIMER Button**
Used to set or cancel timer operation..
- 9 POWER Button**
Used to select the Energy-saving mode.
- 10 SWING Button**
Used to select start or stop vertical air vanes swinging.

- ☑ • Changing modes during operation, sometimes the unit does not response at once. Wait 3 minutes.
- Wait 3 minutes before restarting the appliance.

Operating Instructions

► Remote control

How to Insert the Batteries

Remove the battery cover according to the arrow direction. Insert new batteries making sure that the (+) and (-) of battery are matched correctly. Reattach the cover by sliding it back into position.

Note:

Use 2 LR6 AA(1.5volt) batteries. Do not use rechargeable batteries. Replace batteries with new ones of the same type when the display becomes dim or effective response. If the replacement is done within 1 minute, the remote control will keep original presetting.

How to Use

To operate the room air conditioner, aim the remote control to the signal receptor. The remote control will operate the air conditioner at a distance of up to 23 feet when pointing at signal receptor of indoor unit.

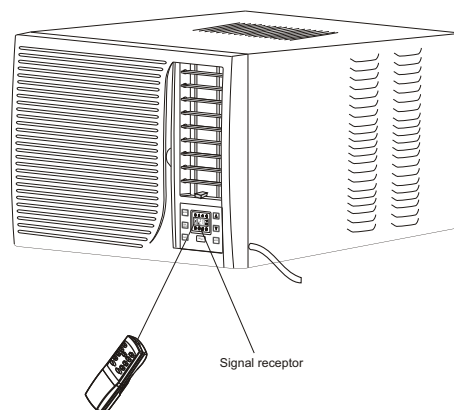
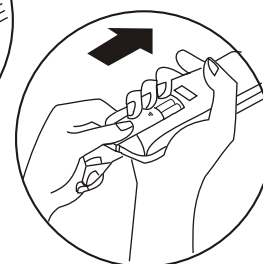
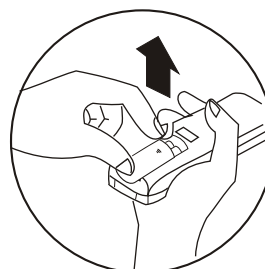
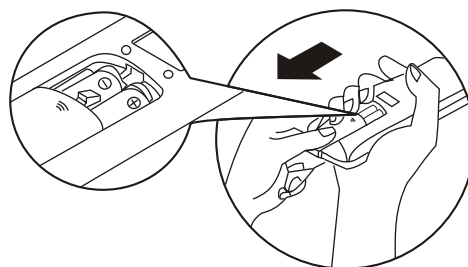

Care and Maintenance

Front panel maintenance

- 1 Unplug from power source

Unplug from power source after switch off the air conditioner.

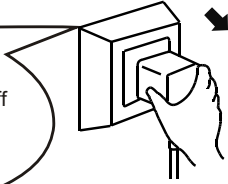

- 2 Wipe with a soft and dry cloth

Use lukewarm water (below 40°C) to clean if the air conditioner is very dirty.



Use a dry and soft cloth to clean it.

- 3 Never use volatile substance such as gasoline or polishing powder to clean the appliance.



Air filter maintenance

- 1 Stop operation and take out air filter.

Take out air filter as shown

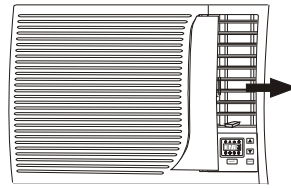

- 2 Clean and reinstall the air filter.

If the dirt is conspicuous, wash it with a solution of detergent in lukewarm water. After cleaning, dry well in shade.



Operation Tips

Operating condition

The protective device maybe trip and stop the appliance in the cases listed below.



COOLING	Outdoor air temperature is over *43°C
	Room temperature is below 18°C

**For Tropical (T3) Climate condition models, the temperature point is 52°C instead of 43°C.*

If the air conditioner runs in COOLING or DRY mode with door or window opened for a long time when relative humidity is above 80%,dew may drip down from the outlet.

Noise pollution

The noise level of air conditioner sounds higher at night than in the daytime.

Please set  (LOW FAN SPEED) or  (FAN ONLY) mode at night in order to decrease noise.

Features of protector

The protective device will work at following cases.

- Restarting the unit at once after operation stops or changing mode during operation, you need to wait 3 minutes.
- Connect to power supply and turn on the unit at once, it may start 20 seconds later.

Caution

① Use proper fuse

- Do not use wire or anything else instead of fuse. Otherwise, air conditioner will be damaged, or cause stock, fire, etc.

② • You need to wait 3 minutes before restarting.

(Note : If you let the appliance on after power cut, the compressor may be burned)

Trouble Shooting

The following cases may not always be a malfunction, please check it before asking for service.

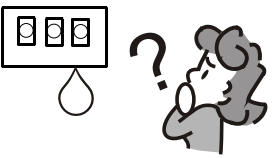
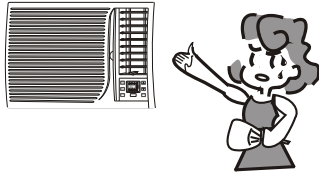
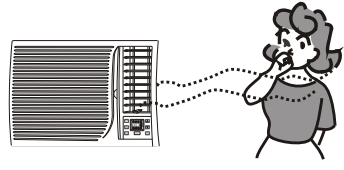
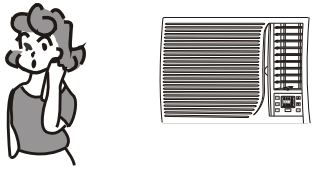
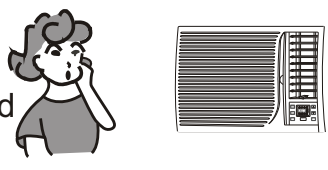
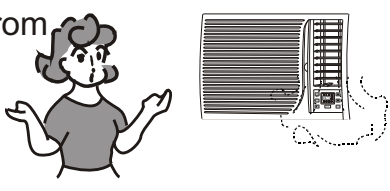
Trouble	Analysis
<p>Does not run</p> 	<ul style="list-style-type: none"> • If the protector trip or fuse is blown. • Please wait for 3 minutes and start again, protector device may be preventing unit to work. • If batteries in the remote controller exhausted. • If the plug is not properly plugged.
<p>Not cool enough</p> 	<ul style="list-style-type: none"> • Is the air filter dirty? • Are the intakes and outlets of the air conditioner blocked? • Is the temperature set properly? • Is the fresh air lever shut off? • Is the door or windows closed?
<p>Peculiar odor</p> 	<ul style="list-style-type: none"> • This odor may come from another source such as furniture, cigarette etc, which is sucked in the unit and blows out with the air.
<p>Sound of flowing water</p> 	<ul style="list-style-type: none"> • Caused by the flow of refrigerant in the air conditioner, not a trouble.
<p>Cracking sound</p> 	<ul style="list-style-type: none"> • The sound may be generated by the expansion or contraction of the front panel due to change of temperature.
<p>Spray mist from the outlet</p> 	<ul style="list-style-type: none"> • Mist appears when the room air becomes very cold because of cool air discharged from indoor unit during COOLING or DRY operation mode.

Installation Instructions

Installation accessories

Note: All mentioned accessories are prepared or purchased by user.

RWC-3217

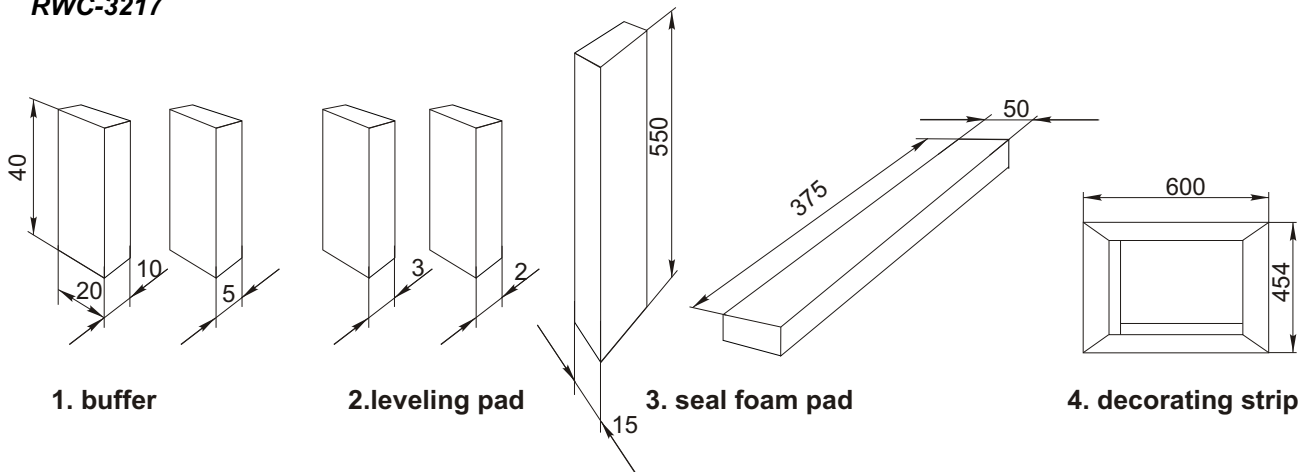

Note: All mentioned accessories are prepared or purchased by user.

RWC-4717

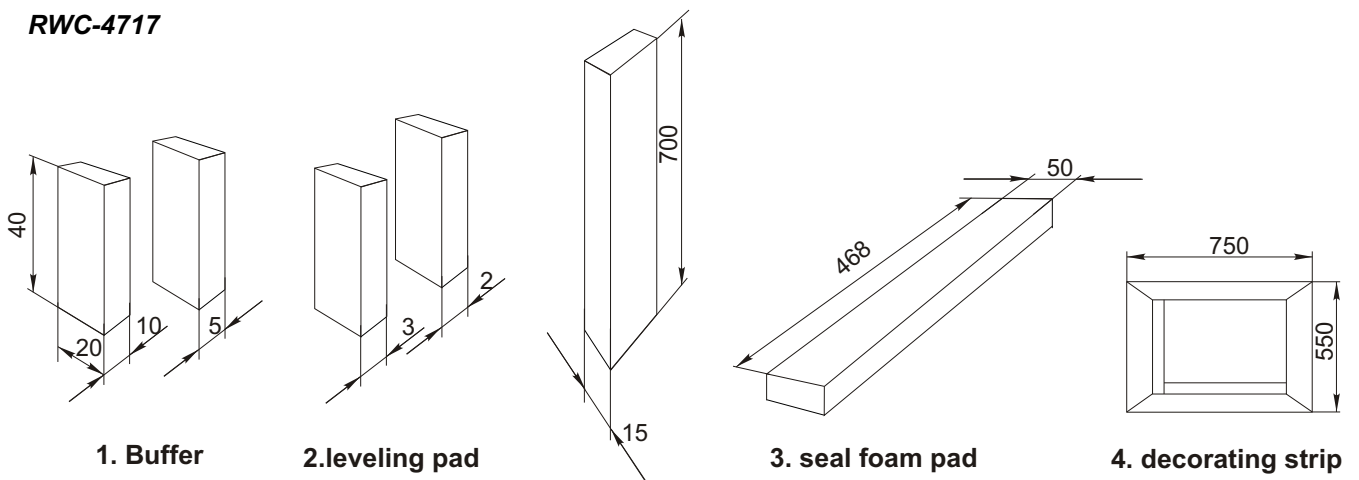

Installation Instructions

Installation Requirements

- Leave a space more than 100 cm at the rear of the appliance and ensure the outdoor air intake not be blocked.
- A wooden frame as shown in fig.1 is advisable if the appliance is installed through a window. The installation bracket as shown in fig.2 should not be welded with the window sash.
- The square hole should be smooth enough if the appliance is installed through a wall. A space as shown in fig.3 for outdoor air intake should be prepared if the wall is too thick.
- The metallic installation bracket should be constructed as fig.4.
- All the installation structure should be strong enough.

RWC-3217

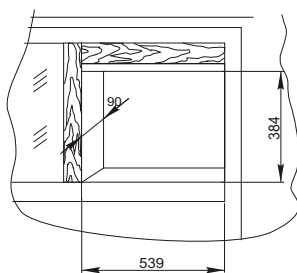

Fig.1

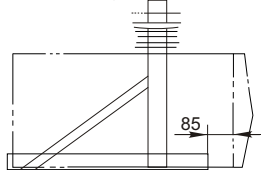

Fig.2

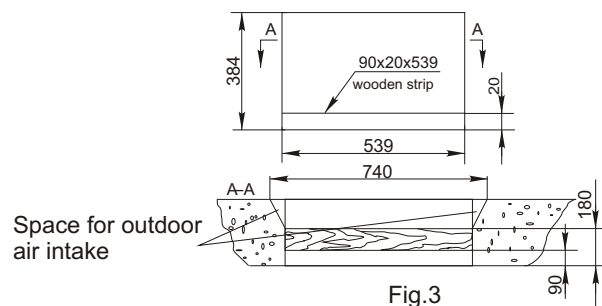

Fig.3

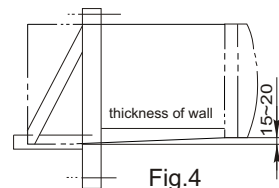

Fig.4

RWC-4717

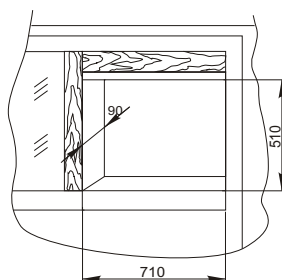

Fig.1

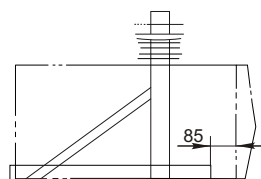

Fig.2

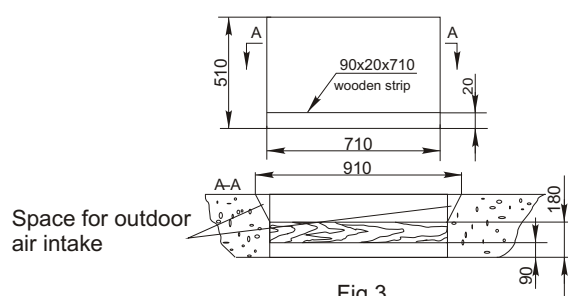

Fig.3

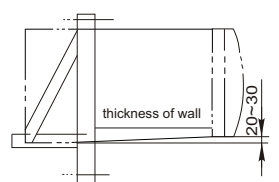

Fig.4

Installation Instructions

Installation Steps

Test the appliance by plugging the power supply cord in a correct outlet of power source before installation.

- A clearance of 20 mm is advisable between the appliance cabinet and the wall. Fix the indoor air intake panel with the cabinet by employing two screws which packed in the packing bag as shown in Fig.5.
- Put the buffers on the installation bracket as shown in Fig.6. Adjust the appliance as shown in Fig.4. The leveling pads are employed to tilt the appliance in order that the indoor side is about (15~20) mm higher than the outdoor side for fear the condensate overflow into the room.
- The seal foam pads are employed to prevent outside air from leaking into the room (Fig.7) and the decorating strip is presented for aesthetical appearance as Fig.8.

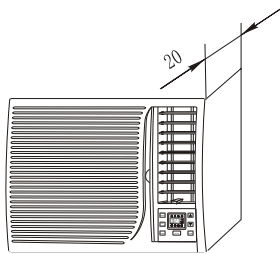

Fig.5

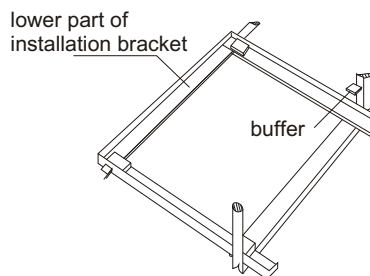

Fig.6

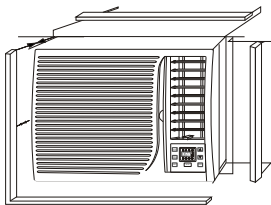

Fig.7

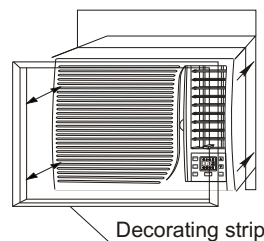

Fig.8

Drainage

Condensate will form during the cooling or dry operation, user can choose drainage or no drainage. Remove the drainage tip and fix the drainage hose when drainage is chosen. On the contrary, the condensate is splashed to cool the condenser so that the cooling capacity and energy conservation is improved with a little high noise when no drainage is chosen.

Fuse and Grounding

- A proper time-delay fuse should be employed in the power supply circuit.
- For your personal safety, this air conditioner must be grounded.
- The extension of power supply cord is inadvisable.
- Connect this air conditioner to its own individual wall receptacle to prevent itself and other appliances or household lights from causing a overload that could cause a power outage.



NEC Australia Pty. Ltd
ABN 86 001 217 527
Home Electronics Group

NEC Service Centres

NEW South Wales

Sydney	184 Milperra Rd, Revesby 2212	(02) 9780 8688
Newcastle	120 Parry Street, Newcastle 2302	(02) 4926 2466

Victoria

Melborne	480 Princes Highway, Noble Park 3174	(03) 9554 6245
----------	--------------------------------------	----------------

Queensland

Brisbane	116 Ipswich Rd, Woollongabba 4102	(07) 3361 5858
Southport	Shop 1, 48 Ferry Rd, Southport 4215	(07) 5591 3670

South Australia

Adelaide	84A Richmond Rd, Keswick, 5053	(08) 8375 5710
----------	--------------------------------	----------------

Western Australia

Perth	45 Sarich Courl, Osborne Park 6017	(08) 9445 5901
-------	------------------------------------	----------------

For Service in outer areas, please contact your **NEC** retailer for the address of the nearest Authorized NEC Service Centre.

NEC Australia Pty. Ltd.
244 Beecroft Road EPPING 2121
Tel. 131- 632 Fax. (02) 9930 2380