

DM525™ and DM575™ Series Digital Mailing System



DM525™ Series Mailing System



DM575™ Series Mailing System
Shown with Weigh-On-The-Way®

Operator Guide US English Version

SV62201 Rev. C

SV62201 Rev. C ©2009 Pitney Bowes Inc.

All rights reserved. This book may not be reproduced in whole or in part in any fashion or stored in a retrieval system of any type or transmitted by any means, electronically or mechanically, without the express, written permission of Pitney Bowes.

We have made every reasonable effort to ensure the accuracy and usefulness of this manual; however, we cannot assume responsibility for errors or omissions or liability for the misuse or misapplication of our products.

Due to our continuing program of product improvement, equipment and material specifications as well as performance features are subject to change without notice. Your postage meter may not have some of the features described in this book.

AccuTrac, Ascent, DM525, DM575, DM Series, E-Z Seal, IntelliLink, WEIGH-ON-THE-WAY (WOW) Postage By Phone, INVIEW and Pitney Bowes Supply Line are trademarks or registered trademarks of Pitney Bowes Inc. All other trademarks are trademarks or registered trademarks of the respective owners.

Alerting Messages

Various messages are used throughout this guide to alert you to potentially hazardous or error causing conditions. These messages are as follows:



WARNING! Alerts you to conditions or practices that could cause serious injury.



CAUTION: Alerts you to conditions or practices that could cause damage to the equipment or to the material being run.

IMPORTANT: Alerts you to conditions or practices that could adversely affect equipment operation if instructions are not followed exactly.

NOTE: Provides a comment or explanation of the associated topic.

FCC Compliance

This equipment has been tested and found to comply with the limits for a Class A digital device, pursuant to part 15 of the FCC rules. These limits are designed to provide reasonable protection against interference when the equipment is operated in a commercial environment. This equipment generates, uses, and can radiate radio frequency energy and, if not installed and used in accordance with the instruction manual, may cause interference to radio communications. Operation of this equipment in a residential area is likely to cause interference, in which case the user will be required to correct the interference at his own expense.

Use only a shielded interface cable to operate this equipment with a scale or other peripheral device



CAUTION: Changes or modifications to this equipment not expressly approved by the party responsible for compliance (Pitney Bowes) could void the user's authority to operate the equipment.

FCC Compliance of Modem

This equipment complies with Part 68 of the FCC rules and the requirements adopted by the ACTA. On the bottom of the IntelliLink® Control Center is a label that contains, among other information, a product identifier in the format US:AAAEQ##TXXXX. If requested, this number must be provided to the telephone company.

This equipment is designed to be connected to a Facility Interface Code 02LS2 network with RJ11C network interface.

A plug and jack used to connect this equipment to the premises wiring and telephone network must comply with the applicable FCC Part 68 rules and requirements adopted by the ACTA. A compliant telephone cord and modular plug is provided with this product. It is designed to be connected to a compatible modular jack that is also compliant. See installation instructions for details.

The ringer equivalence number (REN) is used to determine the number of devices that may be connected to a telephone line. Excessive RENs on a telephone line may result in the devices not ringing in response to an incoming call. In most but not all areas, the sum of RENs should not exceed five (5.0). To be certain of the number of devices that may be connected to a line, as determined by the total RENs, contact the local telephone company. The REN for this product is part of the product identifier that has the format US:AAAEQ##TXXXX. The digits represented by ## are the REN without a decimal point (for example 03 is a REN of 0.3).

If this IntelliLink® Control Center causes harm to the telephone network, the telephone company will notify you in advance that temporary discontinuance of service may be required. But if advance notice isn't practical, the telephone company will notify you as soon as possible. Also, you will be advised of your right to file a complaint with the FCC if you believe it is necessary.

The telephone company may make changes in its facilities, equipment, operations, or procedures that could affect the operation of the equipment. If this happens the telephone company will provide advance notice in order for you to make necessary modifications to maintain uninterrupted service.

If trouble is experienced with this IntelliLink® Control Center please contact the help desk for repair or warranty information. Refer to the *Pitney Bowes Contact Information List* in this guide for the number of the help desk. If the equipment is causing harm to the telephone network, the telephone company may request that you disconnect the equipment until the problem is resolved. This equipment is not intended to be repaired by the customer (user).

Connection to party-line service is subject to state tariffs. Contact the state public utility commission, public service commission, or corporation commission for information.

If the installation site has specially wired alarm equipment connected to the telephone line, ensure the installation of this IntelliLink® Control Center does not disable the alarm equipment. If you have questions about what will disable alarm equipment, consult your telephone company or a qualified installer.

Table of Contents



Pitney Bowes Contact List

Chapter 1 - Read this First

Chapter 2 - Meet the DM Series™ Digital Mailing System

Chapter 3 - Mail in a Minute

Chapter 4 - Running Mail

Chapter 5 - Mailing System Setup

Chapter 6 - Adding Postage

Chapter 7 - INVIEW™ Accounting

Chapter 8 - Reports

Chapter 9 - Maintaining and Updating

Chapter 10 - Troubleshooting

Chapter 11 - Supplies and Options

Chapter 12 - Specifications

Appendix A - Glossary

Index

Pitney Bowes Contact Information List

PB Web Sites

- For frequently asked questions, go to:
<http://www.pb.com>
- To place requests for service or training, go to:
*<http://www.pb.com> and click on **My Account**.*
- To order PB supplies and accessories, go to:
*<http://www.pb.com> and click on **Online Store**.*
- To view and pay invoices online, go to:
*<http://www.pb.com> and click on **My Account**.*
- To view inventory, go to:
*<http://www.pb.com> and click on **My Account**.*
- To add postage to your Postage By Phone® Meter Payment System account, go to:
*<http://www.pb.com> and click on **Add Postage to Your Meter**.*

Our Help Desk

For direct questions, call: 1.800.522.0020. Customer Service Representatives are available Monday through Friday, 8AM - 8:00PM EST.

Postage By Phone® System

To contact, call 1.800.243.7800

Pitney Bowes Supplies

To order Pitney Bowes approved supplies, call our PB Supply Line™ at 1.800.243.7824.

1 • Read This First



Contents

<i>What's in this Guide</i>	<i>1-2</i>
<i>Other Information</i>	<i>1-2</i>
<i>What You Need to Know</i>	<i>1-3</i>
<i>Safety Requirements.....</i>	<i>1-3</i>
<i>Important Information About Powering Your DM Series™ Digital Mailing System Off.....</i>	<i>1-6</i>

What's in this Guide

Chapter 1 - Read this First contains important information about USPS requirements and equipment and telephone safety precautions.

Chapter 2 - Meet the DM525™ and DM575™ Digital Mailing System gives an overview of the mailing system and the location of each control and machine feature. Please read this section carefully. It provides a foundation for the instructions in later sections of this book.

Chapter 3 - Mail in a Minute explains the basics of running mail on your system. By following these instructions, you will be able to run mail quickly.

Chapter 4 - Running Mail explains how to run mail in the different mail modes as well as when to use the various options.

Chapter 5 - Mailing System Setup provides step-by-step instructions for customizing your mailing system to suit your needs.

Chapter 6 - Adding Postage explains how to add postage funds to your postage meter (Postal Security Device) using the Pitney Bowes Postage By Phone® Meter Payment system.

Chapter 7 - INVIEW™ Accounting explains how to use the INVIEW™ accounting feature to track postage.

Chapter 8 - Reports explains the different types of reports available and how to print them.

Chapter 9 - Maintaining and Updating explains how to check the quality of the meter stamp and how to take care of the moistener and tape feeder. It also tells you how to add features and update postal rates and carriers.

Chapter 10 - Troubleshooting contains a list of problems you may encounter while using your mailing system.

Chapter 11 - Supplies and Options lists the supplies available for your system and how to order them.

Chapter 12 - Specifications contains the specifications for the mailing system and mailing materials.

Appendix A - Glossary defines mailing terms used throughout this operator guide.

Other Information

This section describes other sources of information available for the DM525™ and DM575™ Digital Mailing System.

- **Quick Reference Cards** - Much of the information contained in the Operator guide, such as how to set postage, process mail, or clear jams is summarized in the Quick Reference Card Set. The cards are located in a slot in the Stacker module of your system.
- **Our Help Desk** - For a list of the Pitney Bowes web sites, refer to the *Pitney Bowes Contact Information List* located at the front of this guide.

What You Need to Know

USPS Requirements

Since your postage meter (Postal Security Device) is licensed by the United States Postal Service (USPS), you must follow a few basic requirements.

- Mail must have the correct date and postage amount in the meter stamp.
- Metered mail must bear the ZIP Code location of the post office where the postage meter (Postal Security Device) is registered.
- If you move to another ZIP Code location, you must update the ZIP Code. You can do this by calling Postage by Phone®.
- Each time you refill your postage meter (Postal Security Device) through the modem, the Postage By Phone® Meter Payment System computer automatically performs a postal inspection. If the postage meter in your mailing machine has not detected a modem refill transaction at certain intervals, the message “Inspection Required” appears on the main screen of the IntelliLink® Control Center. (The system will then prompt you to connect to Pitney Bowes and perform an inspection.)
- The postage tape you use must meet USPS specifications.

Safety Requirements



WARNING! Follow normal safety precautions for all office equipment whenever using your mailing system.

Read all instructions before you attempt to operate the machine. Use the equipment only for its intended purpose.

- Use only Pitney Bowes approved supplies, in particular aerosol dusters. Improper storage and use of aerosol dusters or flammable aerosol dusters, can cause an explosive-like condition that could result in a personal injury and/or property damage. Never use aerosol dusters labeled flammable and always read instructions and safety precautions on the duster container label.
- Use the power cord supplied with the machine and plug it into a properly grounded wall outlet located near the machine and easily accessible. Failure to properly ground the machine can result in severe personal injury and/or fire.
- The power cord wall plug is the primary means of disconnecting the machine from the AC supply.
- Do not remove the power cord's ground pin and do not use a ground adapter.
- Make sure the area in front of the power outlet is free of obstruction.
- DO NOT route the power cord over sharp edges or trap it between pieces of furniture. Make sure there is no strain on it.
- To reduce the risk of fire or electrical shock, DO NOT attempt to remove covers or disassemble the equipment. The housing encloses hazardous parts. If any components are dropped or otherwise damaged, report such damage to your Pitney Bowes customer service representative.
- Keep fingers, long hair, jewelry, neck ties, and loose clothing away from moving parts at all times.

- When removing jammed material, avoid using too much force to prevent personal injury and damaging equipment.
- To prevent overheating do not cover system vent openings.
- When lifting covers, wait for all parts to stop moving before placing hands near feeder path or printer.
- Do not remove covers as they enclose hazardous parts that should only be accessed by a Pitney Bowes Service Representative.
- Use only Pitney Bowes approved supplies, e.g., inks, tapes, and cleaners. Call the Pitney Bowes Supply Line™ listed in the *Pitney Bowes Contact Information List* at the front of this guide.
- Always follow the specific occupational safety and health s prescribed for your workplace

NOTE: Your mailing system requires annual cleaning by a Pitney Bowes service representative. For continued safe operation, contact your local Pitney Bowes office for a scheduled cleaning

If you use an AC adapter to power the meter when it is off the mailing machine base:

- Use only the AC adapter designed specifically for the IntelliLink® Control Center. Third-party AC adapters may damage the IntelliLink® Control Center.
- To protect against electrical shock, plug the AC adapter into a properly grounded power outlet.
- Do not route the AC adapter cable over sharp edges or trap between furniture.



CAUTION: In case of an ink spill, leaking ink or excessive ink accumulation, immediately power down and disconnect the power cord from the wall plug and call your local Pitney Bowes office for a cleaning.

The IntelliLink® Control Center and its built-in postage meter (Postal Security Device) connect directly to analog telephone lines. For your protection we urge you to follow basic safety precautions to reduce the risk of fire, electric shock and injury to persons, as well as the following:

- Never connect telephone wiring during a lightning storm.
- Disconnect the meter telephone line during a lightning storm.
- Avoid using a telephone or equipment that connects to a telephone line during an electrical storm; there may be a remote risk of electrical shock from lightning.
- Never install telephone jacks in wet locations.
- Do not use this product near water, for example, near a bath tub, wash bowl, kitchen sink or laundry tub, in a wet basement or near a swimming pool.
- Never touch non-insulated telephone wires or terminals unless the telephone line has been disconnected at the network interface.
- Use caution when installing or modifying telephone lines.
- Do not use the telephone or equipment connected to the telephone line in the vicinity of a gas leak.
- Do not connect your postage meter (Postal Security Device) to a digital phone line. The device's built-in modem is designed to work with an analog phone line only. (Your fax machine is usually connected to an analog phone line.) If you do not know if your line is digital, call your phone provider for verification.
- Disconnect the telephone cord from the wall before removing the IntelliLink® Control Center.



CAUTION: To reduce the risk of fire, use only the 26 AWG telecommunication line cord either supplied with the machine or supplied separately.

Important Information About Powering Your DM Series™ Digital Mailing System Off

Your DM Series™ Digital Mailing System is designed to remain powered on at all times. This is necessary so that the printer station can perform the required maintenance it needs to maintain peak performance.

Your DM Series™ System has a power switch (for the location, refer to *Chapter 2, page 2-6*) so that you can properly remove power to the system.

If you need to power off your system, you must use the power switch. When you power off the system, the system immediately moves the print-head back to the capping station to keep the printhead from drying out.

Powering off your system by any other means, such as a wall switch, a power strip, or unplugging from a wall outlet, will result in higher than normal ink consumption and could damage your mailing system.

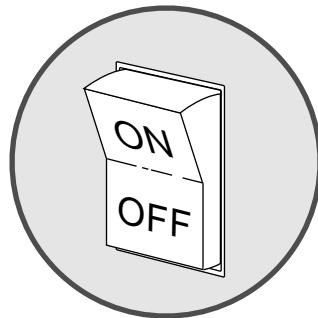

YES

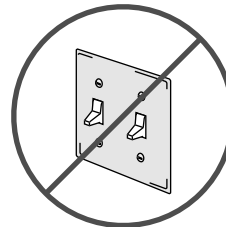

NO

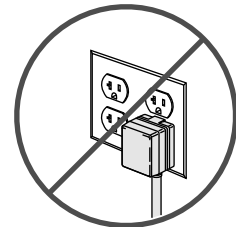

NO

2 • Meet the DM525™ and DM575™ Series Digital Mailing System



Contents

<i>Introducing the DM Series™ Mailing System</i>	2-2
<i>Features and Benefits</i>	2-2
<i>Parts of the Mailing System</i>	2-4
<i>Mailing System Exterior</i>	2-4
<i>Mailing System Interior</i>	2-7
<i>The IntelliLink® Control Center</i>	2-9

Introducing the DM Series™ Mailing System

The DM Series™ Digital Mailing System is an easy-to-use digital mailing system you can tailor to satisfy the unique requirements of your organization. This system:

- Automatically feeds a stack of mail.
- Moistens and seals the envelope flaps.
- Imprints the correct postage amount.
- Stacks the finished mail.

Features and Benefits

The following section provides a summary of the main features and benefits of the DM525™ and DM575™ Series System. The Weigh-On-The-Way® capability for the DM525™ and DM575™ Series Systems is available in limited markets, and is represented in this guide only for those markets. Inclusion in this guide does not imply availability.

Postage Meter

The postage meter on your mailing system is a Postal Security Device (PSD) that incorporates the latest technology approved by the United States Postal Service to secure funds. This technology eliminates the need to perform physical inspections thereby making the system easier and more convenient to use. The PSD contains the funds and performs all of the calculations necessary to print meter stamps that comply with the latest USPS standards.

Easy-to-Use IntelliLink® Control Center

The IntelliLink® Control Center is mounted on the top of your mailing system and features a large easy-to-read graphic display, function keys and alpha and numeric keypads. A series of messages and options appear in the display to prompt you through all of the setup and mailing operations. You use the function keys and keypads to respond to the system prompts and select your options.

Variety of Communications Options

Your DM Series™ Digital Mailing System comes with communications ports for data communications with Pitney Bowes support services and for interfacing to external devices such as a personal computer, an optional scale, or other peripherals.

If you do not have access to your organization's Local Area Network, an internal modem for connecting to an analog telephone line is also available to allow data communications with Pitney Bowes support services as well as external mail/parcel carriers.

Communications with Pitney Bowes provides the following benefits:

- Postage By Phone® Meter Payment System refills
- Remote postage inspections
- USPS Confirmation Services (Delivery Confirmation, Signature Confirmation, and electronic filing of Certified Mail)
- Ability to download graphic images (ads, inscriptions, and permits)
- Ability to download rate change and software updates

Accounting and Reporting

INVIEW™ Accounting

The INVIEW™ accounting and reporting feature allows you to store postage costs for 100 accounts, or you can purchase an option to store 300 accounts. You can run reports on single or multiple accounts and limit access to the accounts by password protecting them. For more information on the INVIEW™ accounting package, refer to *Chapter 7, INVIEW™ Accounting* in this guide.

Budget Manager

You can also acquire the enhanced accounting package, Budget Manager. Budget Manager allows you to create more accounts with higher levels of detail.

For more information on Budget Manager, refer to *Budget Manager Operator Guide, SV60957*.

Business Manager

You can connect your DM Series™ system directly to a Business Manager host PC and control all of your accounts, operators and postal transaction data through the Business Manager Administration module. For more information on Business Manager, refer to the help within the Business Manager application.

Advertisements and Inscriptions

Ads and inscriptions are messages you can include in the meter stamp. A number of standard advertisements and inscriptions are included with your mailing system. You can order customized ads and inscriptions by calling the Pitney Bowes Supply Line™ (refer to the *Pitney Bowes Contact Information List* at the front of this guide for the phone number). For information on ordering ads and inscriptions, refer to *Chapter 11, Supplies and Options* in this guide.

When you order additional advertisements or inscriptions you receive an art card which you insert into a slot on the side of the IntelliLink® Control Center. Once installed, you can select an advertisement or inscription when you run mail.

Shape Based Rating



Shape based rates are USPS® rates that are based on the weight and dimensions (thickness, length, width) of the mail piece. All DM Series mailing systems support this rating structure.

Optional Permits

You can print a permit on a piece of mail instead of a meter stamp. A permit is a postal mark containing a permit number that provides you with special processing or discount rates. You get the permit(s) from the US Post Office and the permit artwork from Pitney Bowes. For information on ordering permits, refer to *Chapter 11, Supplies and Options* in this guide.

Parts of the Mailing System

This section describes the parts of your DM525™ and DM575™ Series System and includes:

- The Mailing System Exterior, including the Weigh-On-The-Way® (WOW®) Module
- The Mailing System Interior
- The IntelliLink® Control Center
- The Main Screen

Mailing System Exterior

- 1 IntelliLink® Control Center** - This contains the screen and keypad for communicating with the mailing machine and the built-in postage meter (Postal Security Device).
- 2 Feed Cover** - Protect moving parts and prevent foreign objects from entering the machine. The feed cover protects the feeder.
- 3 WOW (Weigh-On-The-Way®) Cover** - Protects the WOW® transport area on the DM Series™ systems that have the optional
- 4 Printer Cover** - protects the print head and ink cartridge components.
- 5 Thickness Adjustment Knob** - You use this knob to adjust for the thicknesses of the envelopes you are feeding into your mailing system.
- 6 Weighing Capability** - You can acquire a 5 or 10 lb. integrated platform scale for your DM Series™ Digital Mailing System.
- 7 On/Off switch** - Turns the mailing system on and off. This is located on the lower left side of the feed deck
- 8 Feed Deck** - This is where you load the mail.
- 9 Side Guide** - Set this to reduce the skewing of pieces of mail as you feed them into the feeder.
- 10 Transport Release Knob** - You pull this knob out to drop the lower half of the transport deck if you need to clear a jam.
- 11 Art Card Slot** - The art card plugs into the art card slot on the right side of the IntelliLink® Control Center (as shown in the photo on the right). The art card contains advertisements and inscriptions.
- 12 Quick Reference Card Set** - These are easy reference cards containing instructions for performing operations like how to set postage, process mail, or clear jams. The cards are located in a slot in the stacker module of your mailing system.
- 13 Stacker** - This is where mail is deposited after the postage is applied to the piece of mail. It is located on the right side of the machine.



The DM525™ and DM575™ Series Digital Mailing System

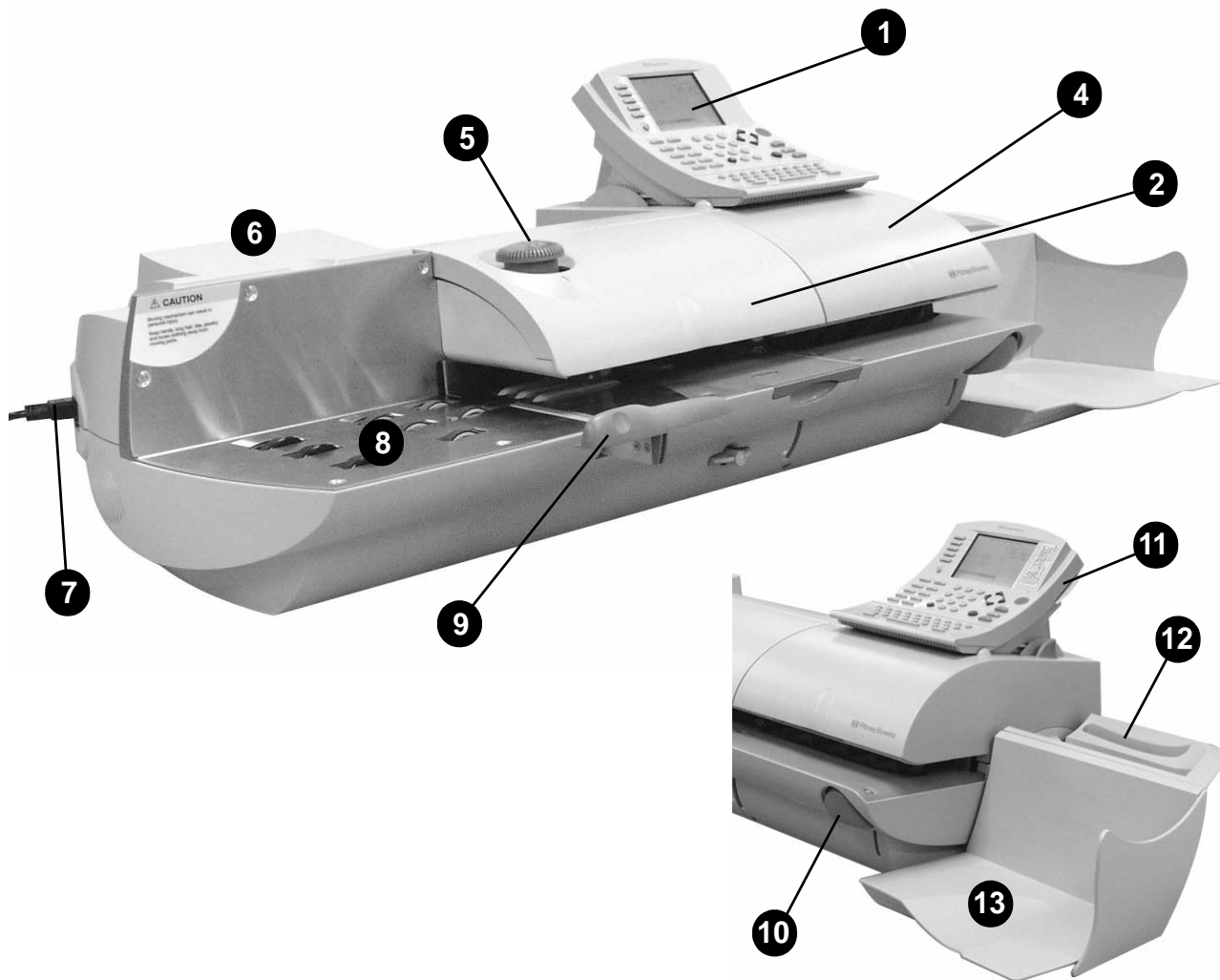

Mailing System with Optional WOW™ Module

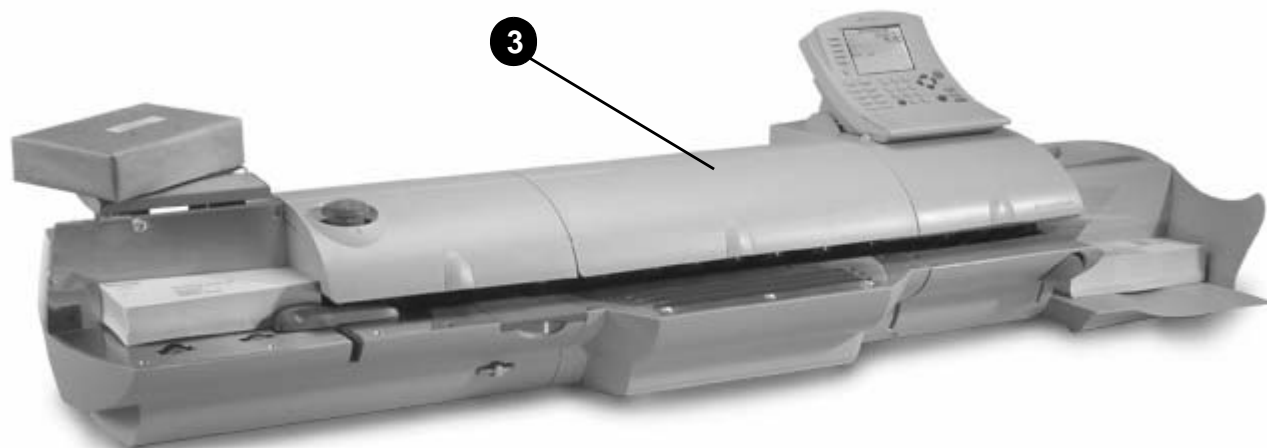

Connectors on the Back of the Mailing System Base



USB Ports - Four USB ports are located on the back, lower right side of the machine. These provide communications with external devices like a printer, an external scale, optional power stacker or a PC. If you are connecting to your organization's Local Area Network (LAN), use one of these USB ports to make the connection. For details, refer to section *Connecting Your Postage Meter to a LAN* in *Chapter 6* of this guide.

Serial Port Connector - One Pitney Bowes serial port connector. This is for Pitney Bowes use only.

Mailing System Interior

Interior of the Mailing System (Under the Front Cover)

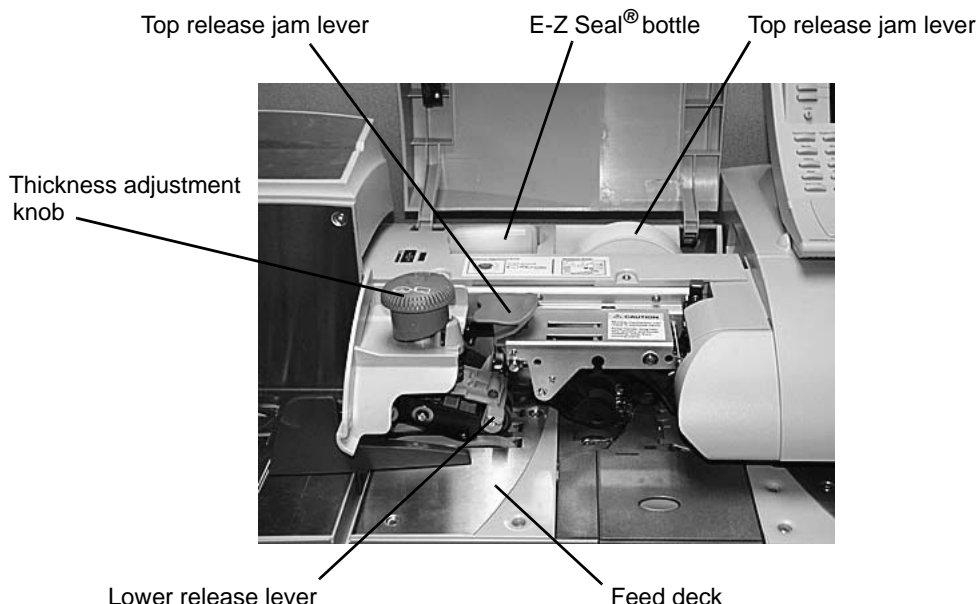

Thickness Adjustment Knob - Use this to adjust for the thicknesses of the envelopes. You do not have to lift the cover to adjust the knob.

For thicker pieces of mail (3/8" to 5/8"), or mail containing several inserts, use the thick mail setting. For mail containing only single inserts, or for postcards, use the normal mail setting. Refer to the figure on the right.



Top Release Jam Lever/Lower Release Lever - Lift these to clear jams on the Feed deck.

Pressure-Sensitive Postage Tape - The DM Series™ system uses this pressure sensitive tape to print reports and meter stamps for packages or pieces of mail that are outside the limits specified for mailing materials. See *Specifications* in *Appendix C* of this guide for details.

Feed Deck - This feeds the envelopes to the printer. If your system has the option WOW® module, this feed the envelopes to the WOW® transport deck.

E-Z Seal® Sealing Solution Bottle - This contains the E-Z Seal® solution used for moistening and sealing envelopes.

Interior of the Mailing System with Optional WOW® (Under the WOW® Cover)

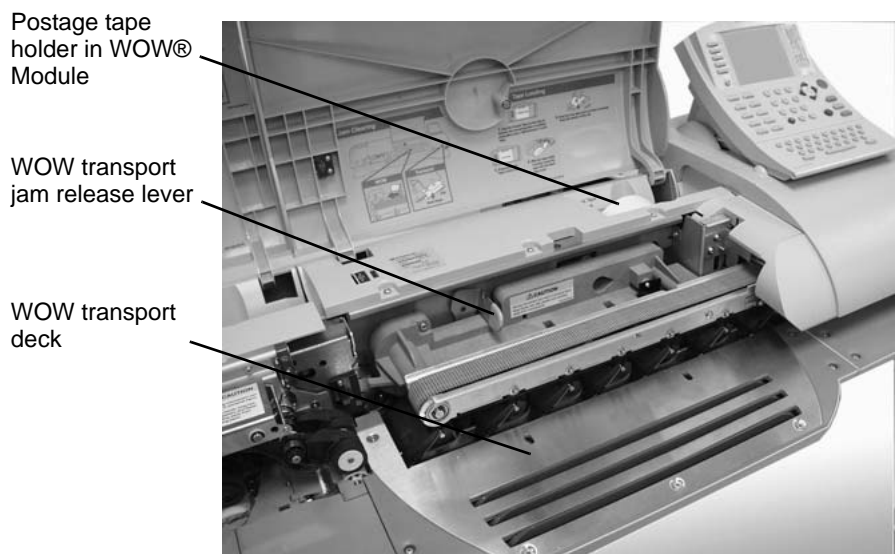

WOW® Transport Jam Release Lever - Pull this to clear jams on the transport deck.

Pressure-Sensitive Postage Tape - In the DM Series™ system with optional WOW® module, the pressure sensitive postage tape is located as shown below in the WOW® module.

WOW® Transport Deck - This transports the envelopes to the printer.

Interior of the Mailing System (Under the Print Cover)

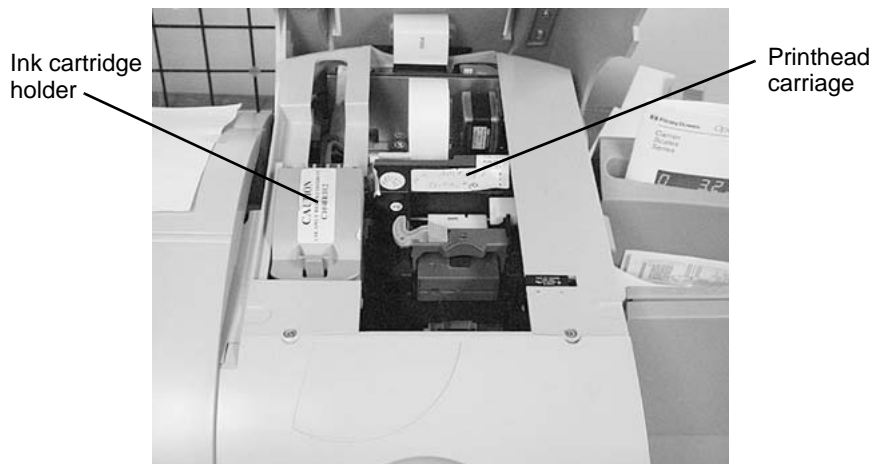

Ink Cartridge Holder - This contains the ink used to create the meter stamp.

Printhead Carriage - This produces the meter stamp.

The IntelliLink® Control Center

This section describes all of the function keys on the IntelliLink Control Center, the control center Main Screen, and the connectors on the back of the control center used to connect it to the AC adapter and to an analog phone line.

Function Keys

- 1 Five Screen Keys** - The five keys directly to the left of the display screen allow you to select options displayed on the screen.
- 2 Lock Button** - Locks the IntelliLink® Control Center.
- 3 Normal Preset Key** - Returns you to the most commonly used setting.
- 4 Mode Key** - Press to choose from a variety of mail processing modes.
- 5 Class Key** - Enables you to select the correct class for your mailing (e.g., First Class, Priority, Media mail).
- 6 Seal Key** - Allows you to moisten and seal envelopes, with or without applying postage. You can also choose not to seal the envelopes at all.
- 7 Accounts Key** - Press to set up and edit accounts.
- 8 Custom Preset Key** - Use this to choose frequently-used system key settings for running different jobs
- 9 Menu Key** - Press to view the following settings and options:
 - Meter Stamp Options
 - Set Up
 - Zero Scale
 - Maintenance
 - Turn Features On
 - Confirmation Services
 - Adjust Display Contrast
- 10 Funds Key** - Press to view the following settings and options:
 - Funds Available (in postage meter)
 - Funds Used
 - Total Pieces (of mail processed by your mail system)
- 11 Reports Key** - Offers a selection of different types of reports to run.
- 12 Help Key** - Gives detailed information about a screen you are viewing.
- 13 Numeric Keys** - Press numbered keys to enter postage amounts and weight. You can also use these keys to select numbered options appearing in the display.
- 14 Enter Key** - Press to enter the information you have selected for the mailing system.
- 15 Arrow Keys** - Moves you to new menus, or scrolls menus and selects options.

- 16 **Start Key** - Begins processing mail with the options you have selected.
- 17 **Tape Key** - Allows you to print postage tapes for packages or pieces of mail that are outside the limits specified for mailing materials. See *Specifications* in *Appendix C* of this guide for details.
- 18 **Stop Key** - Ends a mail or tape processing job in progress.
- 19 **Clear Key** - Clears an entry, or takes you back one screen.
- 20 **Alpha Keyboard** - Use to enter accounts and other setup information. This keyboard is under a cover that opens for access.

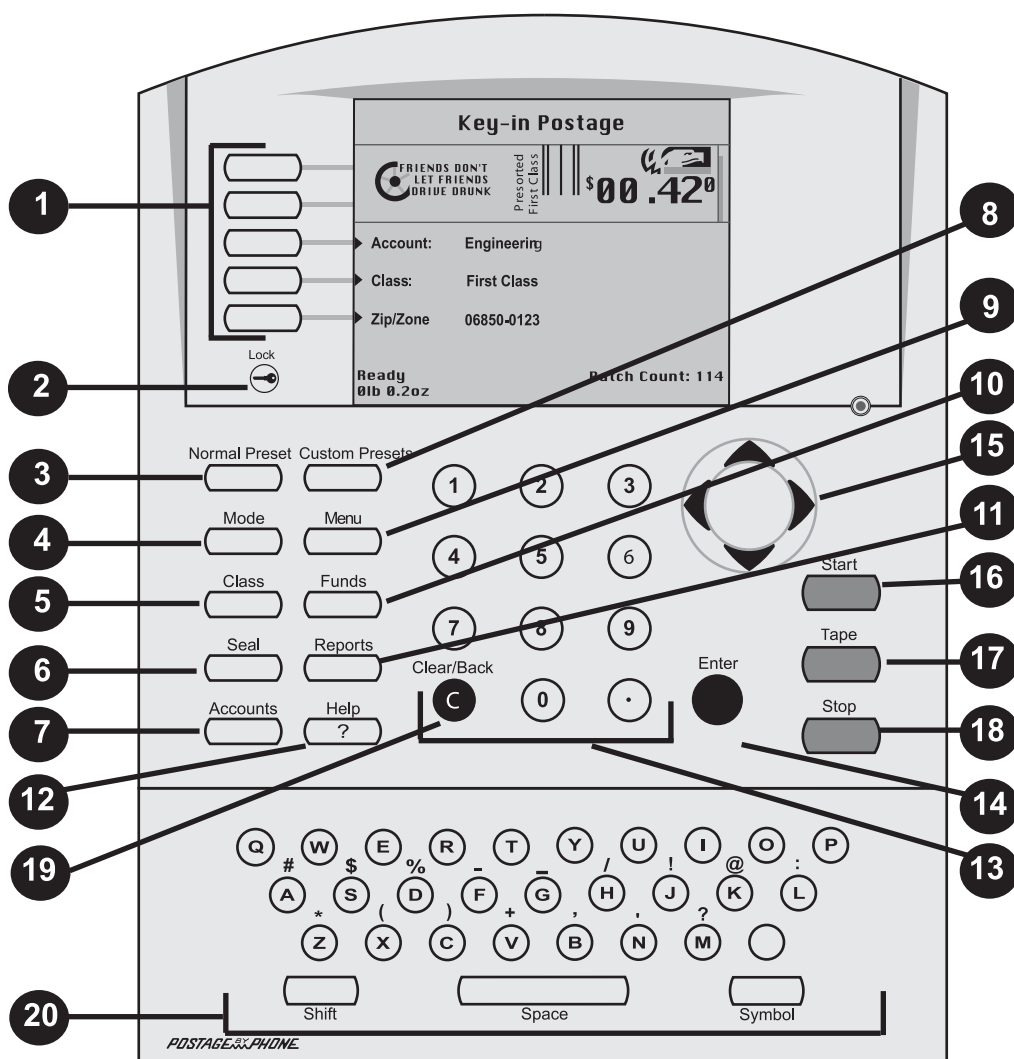

The Main Screen

The content of the main screen depends upon the current mode of the machine. Main screens are the only screens that contain a meter stamp replica area and a main status area.

The main screen enters a sleep mode after a certain period of inactivity. Pressing any key wakes up the system and shows the last screen on the display, or the one corresponding to the Normal Preset settings (refer to *Define Presets* in *Chapter 5* in this guide for more information).

- 1 **Advertisement Display** - The optional message to be printed on the envelopes or tape (if selected).
- 2 **Account** - The optional account number or name charged with postage.
- 3 **Class** - The class you selected for the piece of mail.
- 4 **Main Status Area** - Important information such as warnings or help or navigation tips. For example, if you select a class, a message appears in this area.
- 5 **Weight Display Area** - The weight of the piece of mail.
- 6 **Mode** - The mode in which the piece of mail will be processed, or what the next required action will be.
- 7 **Meter Stamp** - The official USPS indicia printed on the envelope or tape.
- 8 **Batch Count** - The number of pieces of mail run in a job.

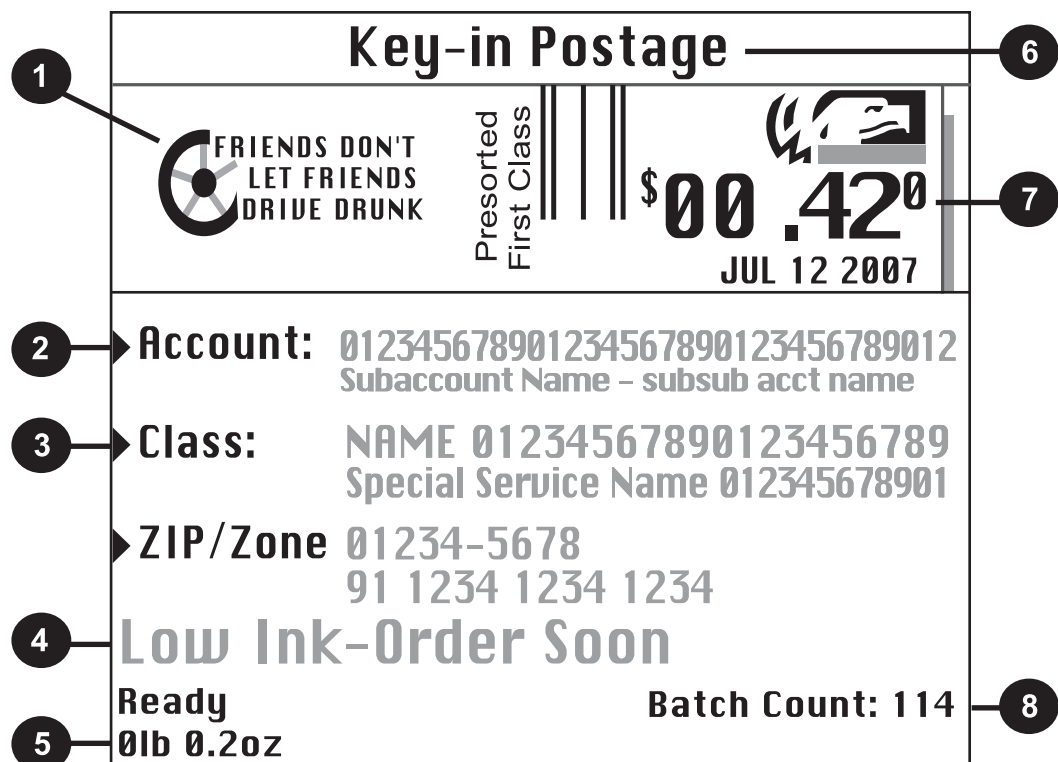

Connectors on the Back of the IntelliLink® Control Center

- **Analog Phone Line Connector** - The term analog phone line refers to a RJ11C or RJ11W compatible (single line) telephone wall plug typically used for a residential phone or facsimile hookup. If you do not have a LAN connection, you can use the analog phone line connector to add postage funds to your meter. If the analog phone line is not close to your DM Series™ system, you can remove the IntelliLink® Control Center from your system and move it to another location. For more information, refer to *Connecting Your Control Center to a Remote Analog Line* in Chapter 6 of this guide.
- **External USB Connector** - The USB connector on the back of the IntelliLink® Control Center is used for connecting to the flash memory drive required to run INVIEW™ Accounting. Refer to Chapter 7, *INVIEW™ Accounting* in this guide for more information.
- **IntelliLink® Control Center AC Adapter Receptacle** - The receptacle for the AC adapter is located on the back of the IntelliLink® Control Center. If you need to remove the control center from the mailing system base and move it to an analog telephone line, you plug the AC adapter into this receptacle.



Analog Phone Line Connector

AC Adapter Receptacle

USB Connector

3 • Mail in a Minute



Contents

<i>Mail in a Minute</i>	<i>3-2</i>
<i>Preparing Your Mail.....</i>	<i>3-2</i>
<i>Running the Mail</i>	<i>3-3</i>
<i>Printing Postage Tapes</i>	<i>3-4</i>

Mail in a Minute

This chapter explains how to use the “Key In Postage” mode. It’s the quickest and easiest way to run a piece of mail or print a postage tape.

Use this mode if:

- You know the postage amount.
 - All envelopes are the same size.
 - You are printing postage on postcards.
-

For instructions on other available modes for running your mail, refer to *Determining the Correct Postage Mode* section in *Chapter 4* in this guide.

For tips on feeding light weight or bulky pieces of mail, flats and postcards, or any mail that is easily damaged, refer the *Tips on Feeding Mail* section in *Chapter 4* in this guide.

Preparing Your Mail

1. Remove any onion skin/airmail type envelopes, Tyvek® envelopes, envelopes that are thicker than 5/8” or any pieces of mail that are outside the limits specified for mailing materials - see *Specifications* in *Chapter 12* of this guide for details. Print the postage for this type of mail on tape.
2. Sort the mail by envelope size and weight. If you are using the accounting feature, sort by account as well.
3. Shingle the envelopes so they are slanted slightly to the left as shown in the picture shown below.



- Place the stack of mail on the feed deck shown in the picture below.



- Place the envelopes with the flaps down and against the rear wall.
 - Make sure the envelopes are pushed far enough so that they cover the feed sensor on the rear wall.
- Adjust the side guide so it is close to, but not touching, the bottom edge of the envelope stack. Be sure and leave a slight clearance between the side guide and envelopes (about 1/16 inch clearance).

- Adjust the thickness adjustment knob to adjust for envelope thickness. For thicker pieces of mail (3/8" to 5/8"), or mail containing several inserts, use the thick mail setting. For mail containing only single inserts, or for postcards, use the normal mail setting. Refer to the figure on the right.

To pick a setting, turn the knob to the arrow located on the feed cover.

- Make sure you have sufficient funds in your postage meter. If the message "Low Funds" appears on the screen, make sure you can complete the mail run with the funds you have. If you do not have enough funds, see *Chapter 6, Adding Postage* in this guide. uide and envelopes (about 1/16 inch clearance).

Thick Mail Setting



Thin Mail Setting

Running the Mail

- Press the **Mode** key on the IntelliLink® Control Center.
- Select **Key In Postage**.
- Key in the correct postage value using the numeric keys on the control center, then press the **Enter** key.
- Place the piece of mail on the feed deck and press the **Start** key.

Printing Postage Tapes

Print postage tapes for:

- Packages
- Onion skin/airmail type envelopes
- Tyvek® envelopes
- Envelopes that are thicker than 5/8"
- Any pieces of mail that are outside the limits specified for mailing materials - see *Specifications, Mailing Materials* in *Chapter 12* of this guide for details.

You can request up to 99 tapes at a time. The tapes exit into the stacker. The DM525™ and DM575™ Digital Mailing System is designed to use a special pressure sensitive adhesive tape made exclusively for it.



CAUTION: Use only fresh rolls of Pitney Bowes tape to avoid distortion or jams in the mechanism and possible loss of postage.

To print a postage tape:

1. Locate the tape exit on the right side of the mailing system.
 2. With the correct postage set on the main screen, press the **Tape** key to print one tape.
 3. To print more than one tape, use the numeric keys to type in the number of tapes you want, then press the **Tape** key. The system prints the tapes.
-

NOTE: Do not lift any of the covers on the mailing system while the tape is printing or the system will stop printing, cut and eject the tape.

4 • Running Mail



<i>Navigating Hints</i>	<i>4-2</i>
<i>Applying Postage and Running Mail</i>	<i>4-3</i>
<i>Determining the Correct Postage Mode</i>	<i>4-4</i>
<i>Preparing Your Mail</i>	<i>4-6</i>
<i>Selecting the Postage Mode and Running the Mail</i>	<i>4-10</i>
<i>Selecting or Deselecting an Account</i>	<i>4-16</i>
<i>Selecting the Class, Carrier, Special Services or Options</i>	<i>4-18</i>
<i>Selecting the Meter Stamp Options</i>	<i>4-20</i>
<i>Using Electronic Confirmation Services</i>	<i>4-22</i>
<i>Adding Postage or Changing the Date</i>	<i>4-31</i>
<i>Clearing the Batch Count</i>	<i>4-32</i>

Navigating Hints

- The maximum number of options displayed is 5. To view more options, press the down arrow key.
- You can select a numbered option either by pressing the screen key next to the option, or by pressing the corresponding number on the keyboard and then pressing the **Enter** key.
- To go back one screen or more, clear an entry, or return to the “Ready” screen, press the **Clear** key. Pressing the left arrow key returns you to the main screen.
- Other selection or navigation or help information appears at the bottom of the screen. Also, check for messages next to the arrow keys on the bottom right side of the screen.

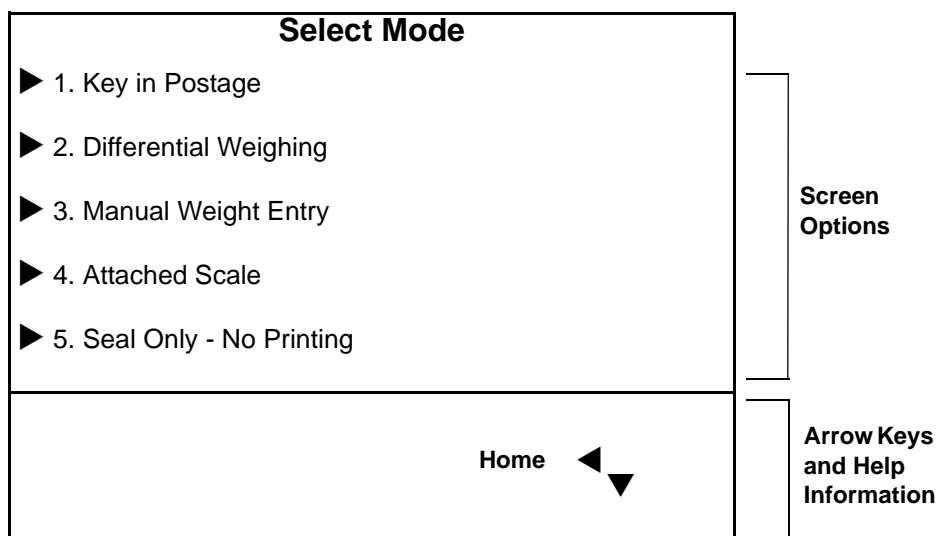

Applying Postage and Running Mail

To apply postage and run mail on the DM525™ and DM575™ Series System, follow the procedures listed here.

You must follow procedures 1 and 2 before you run mail through the system and apply postage. If you are using Accounting, you must also follow procedure 4.

Follow the other procedures listed here as needed.

For details on each procedure, refer to the section number listed here.

- 1 Determining the Correct Postage Mode.** Deciding the appropriate mode for your specific mail run.
- 2 Preparing Your Mail.** Getting your mail ready for the DM525™ and DM575™ Series Digital Mailing System.
- 3 Selecting the Postage Mode and Running Mail.** Choosing the mode for running your mail and tapes.
- 4 Selecting or Deselecting an Account to Print Postage.** Refer to this section if your system uses accounting.
- 5 Selecting the Class.** Refer to this section if you need to specify a class or select a special service.
- 6 Selecting Meter Stamp Options.** This section describes how to change the elements printed on your piece of mail.
- 7 Using Electronic Confirmation Services.** This section tells you how to use preprinted barcode labels provided by Pitney Bowes to electronically process and submit records for USPS Confirmation Services to the Pitney Bowes Data Center.
- 8 Adding Postage or Changing the Date.** This sections tells you how to add more postage or change the date of your postage.
- 9 Clearing the Batch Count.** Refer to this section if you want to clear or reset the number of pieces of mail processed by your system.

1 Determining the Correct Postage Mode

Feeding Mail or Printing Tape?

1. If your mail requires no application of postage, see Chart C on the following page to choose your mode.
2. If your mail requires postage, you must determine if you can print directly on your mail. You can feed mail if your pieces of mail are:
 - under 5/8in. (15.9mm) thick.
 - over 3.5 in. x 5 in. or under 13 in. x 10 in.
 - under 10 lbs.
 - not too thin (such as fliers, or Tyvek® envelopes) or too fragile (such as air mail and onion skin envelopes) to pass through the feeder.
 - Meet the other requirements for mail feeding listed in *Chapter 12, Specifications* in this guide.
3. If your mail meets the above requirements, select the appropriate mode from Chart A below.
4. If your mail does NOT meet the requirements for direct printing, you MUST print a postage tape. Select the applicable postage mode from Chart B on the following page.

Chart A - Printing on Mail	
If:	Then use this mode:
You know the amount of postage needed for your piece of mail.	Key In Postage
You do not know the weight of your piece of mail.	Attached Scale
The pieces of mail are different weights but fall within the guidelines listed above and in the <i>Specifications</i> in <i>Appendix C</i> in this guide.	WOW® - Weigh-On-The-Way®
All pieces of mail are identical.	Weight First Piece (only available with WOW®)
Your pieces of mail vary in types, sizes, and/or weights.	Differential Weighing (available as an option on your DM Series™ Digital Mailing System).

Chart B - Postage Tape Mode	
If:	Then use this mode:
You know the amount of postage needed for your piece of mail.	Key In Postage
You do not know the weight of your piece of mail.	Attached Scale
You have several pieces of mail and do not know their postage	Attached Scale - AutoTape (An option you can purchase, not available on all systems.)
You know the weight.	Manual Weight Entry (An option you can purchase, not available on all systems.)
Your pieces of mail vary in types, sizes and/or weights.	Differential Weighing

Chart C - Mail Modes with NO Postage	
If:	Then use this mode:
Your mail requires a permit.	Print Permit (An option you may be able to purchase. Not available on all systems.)
You only want to seal the envelope and do NOT want to apply postage.	Seal Only (No Printing)
You want to print the date or time on incoming mail for record keeping.	Time and Date Stamp (An option you can purchase, not available on all systems.)

2 Preparing Your Mail

If you intend to run pieces of mail through your system, read *About Running Mail* below. If you are going to print postage tapes, read *About Printing Postage Tapes* in this section.

Then, proceed to instructions for selecting the mode and running the job.

Refer to *Chapter 12, Specifications* in this guide to make sure your mail is compatible with your mailing system. For tips on feeding light weight or bulky pieces of mail, flats and postcards, or any mail that is easily damaged, refer to *“Tips on Feeding Mail”* in this section.

About Running Mail

1. Sort the mail by envelope size and unless you are using the optional WOW module, sort by weight also. If you are using the accounting feature, sort by account as well.
2. Shingle the envelopes so they are slanted slightly to the left as shown in the picture on the right.



3. Place the stack of mail on the feed deck shown in the picture below.



- Place the envelopes with the flaps down and against the rear wall.
 - Make sure the envelopes are pushed far enough so that they cover the feed sensor on the rear wall.
4. Adjust the side guide so it is close to, but not touching, the bottom edge of the envelope stack.
Be sure and leave a slight clearance between the side guide and envelopes (about 1/16 inch clearance).

5. Adjust the thickness adjustment knob to adjust for envelope thickness. For thicker pieces of mail (3/8" to 5/8"), or mail containing several inserts, use the thick mail setting. For mail containing only single inserts, or for postcards, use the normal mail setting. Refer to the figure on the right.

To pick a setting, turn the knob to the arrow located on the feed cover.

6. Make sure you have sufficient funds in your postage meter. If the message "Low Funds" appears on the screen, make sure you can complete the mail run with the funds you have. If you do not have enough funds, see *Chapter 6, Adding Postage* in this guide.

Thick Mail Setting



Thin Mail Setting

Tips on Feeding Mail

- **Presealed Envelopes:** If you are using presealed envelopes, make sure you press the **Seal** key on the IntelliLink® Control Center and select **Sealer off** or the envelopes will jam.
- **Pieces of mail that are 5/8" thick:** If you are running pieces of mail that are each 5/8" thick, you must run them one piece at a time. Do not stack them on the feed deck and attempt to feed them automatically - they will jam.
- **Puffy mail:** Be sure to compress all "puffy" mail before placing it on the feed deck.
- **Portrait flats or light, easily damaged mail:** You may want to reduce the speed at which the pieces of mail travel through the machine. To do this, press the **Mode** key, then press the right arrow key (**speed**) to change between normal and reduced speed.
- **Any mail with the flap on the opposite side:** For mail where the indicia is located on the side opposite of the flap (the flap is on the bottom of the mail piece), make sure the mail is completely sealed before processing the mail in the WOW® mode as shown below.
- **Postcards:** You may want to process postcards using the reduced speed mode. Remember to use the Key in Postage mode for postcards.

if this is where you want the indicia ...

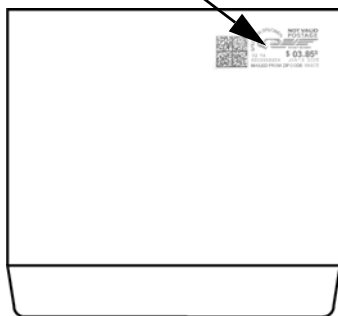

make sure the mail is completely sealed when you feed it through the machine

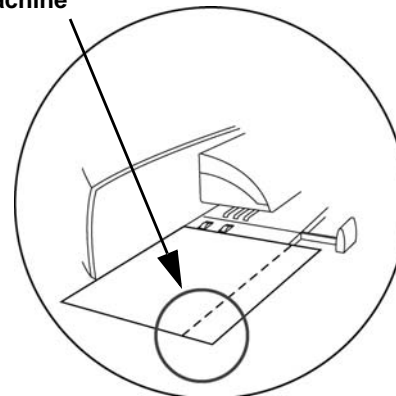

Flap face-down and sealed

About Printing Postage Tapes

Print postage tapes for:

- Packages
- Onion skin/airmail type envelopes
- Tyvek® envelopes
- Envelopes that are thicker than 5/8"
- Any pieces of mail that are outside the limits specified for mailing materials - see *Appendix C, Specifications* in this guide for details.

You can request up to 99 tapes at a time. The tapes exit into the stacker. The DM525™ and DM575™ system is designed to use a special pressure sensitive adhesive tape made exclusively for it.



CAUTION: Use only fresh rolls of Pitney Bowes® tape to avoid distortion or jams in the mechanism and possible loss of postage.

- To print one tape, you simply press the **Tape** key instead of placing mail on the feed deck.
 - To print more than one tape, use the numeric keys to type in the number of tapes you want, then press the **Tape** key. The tapes exit into the stacker on the right side of the mailing system.
-

NOTE: Do not lift any of the covers on the mailing system while the tape is printing or the system will stop printing, cut and eject the tape.

3 Selecting the Postage Mode and Running the Mail

Once you decide the appropriate mode for running your mail job, you select the mode on your mailing system. To access the modes, press the **Mode** key on the Intel-Link® Control Center.

The names of the modes as they appear on the screen are shown in the menu on the right.

Depending on your model number, you may have all or only some of these options.

For a detailed description of each mode, refer to the specific mode topic in this section. Follow the steps for your mode exactly.

Select Mode

- ▶ Key in Postage
- ▶ WOW - Weigh on the Way
- ▶ Weigh First Piece
- ▶ Differential Weighing
- ▶ Manual Weight Entry
- ▶ Attached Scale
- ▶ Seal Only - No Printing
- ▶ Time and Date Stamping

While your mailing system processes the mail, the screen:

- Displays the status of the current job.
- Instructs you, if necessary: to insert an envelope or to reboot your system (or displays an error message).
- Keeps a running count of processed mail.
- Displays errors, at which point the machine stops immediately.

Mode Selection: **Reduced Speed Mode**

Reduced Speed Mode provides "Normal" or "Reduced" speed mode for mail that requires extra care during processing. This option can be saved in a custom preset.

To use this mode:

1. Press the **Mode** key.
2. Press the right arrow key to toggle between "Normal" and "Reduced" speed. The current speed appears on the bottom left corner of the screen.

Reduced Speed Mode will remain active unless it is changed by the operator, or the system defaults to 'Normal' as part of the Normal Preset.

**Mode Selection:
Key in Postage**

Use this mode if you know what the correct amount of postage is for your mail and you intend to apply this postage to each piece.

1. Press the **Mode** key.
2. Select **Key In Postage**.
3. Key in the correct postage value using the numeric keys on the IntelliLink® Control Center, then press the **Enter** key.
4. If you are done, place the mail on the feed deck and press the **Start** key, otherwise go to step 4.
5. If you want to change the date, add or change an advertisement or inscription, press the **Menu** key and select **Meter Stamp Options**. For more information, refer to “*Selecting the Meter Stamp Options*” in this chapter.
6. When finished, place the stack of mail or piece of mail on the feed deck and press the **Start** key.

**Mode Selection:
WOW® - Weigh-
On-The-Way®**

This feature is available only on systems that have the optional Weigh-On-The-Way® (WOW®) module installed.

WOW® feature increases your productivity by weighing the piece of mail and applying the correct postage as it travels through the mailing machine.



WARNING! Do not lean on or disturb the system while it is processing mail in this mode. It will affect the amount of postage applied to the mail piece.

To run mail in the WOW® mode:

1. Press the **Mode** key.
2. Select **WOW - Weigh on the Way**.
3. Press the **Class** key and select the class. For more information, refer to “*Selecting the Class, Carrier, Special Services or Options*” in this chapter.
4. Press the **Seal** key and select your sealing option.
5. Place the stack of mail on the feed deck.
6. Press the **Start** key.

Mode Selection: Weigh First Piece

This feature is available only on systems that have the optional Weigh-On-The-Way® (WOW®) module installed.

In this mode, the machine weighs the first mail piece and processes the remaining mail at the same postage rate.



WARNING! Do not lean on or disturb the system while it is processing mail in this mode. It will affect the amount of postage applied to the mail piece.

To run mail in this mode:

1. Press the **Mode** key.
2. Select **Weigh First Piece**.
3. Press the **Class** key and select the class. For more information, refer to 4-“*Selecting the Class, Carrier, Special Services or Options*” in this chapter.
4. Press the **Seal** key and select your sealing option.
5. Place the stack of mail on the feed deck.
6. Press the **Start** key.

Mode Selection: Differential Weighing

This option is available on your system if it has the optional integrated platform scale or an attached external scale.

This option allows you to place all of the mail on the scale at once, then remove each piece, one at a time and run it through the system. The system calculates the postage for each piece of mail you remove from the scale and applies the postage to the piece as it goes through the mailing system.

For larger pieces of mail (large envelopes or packages), you can use differential weighing to have the system automatically print a tape every time you remove a piece of mail from the scale.

Before using differential weighing:

- Make sure each piece of mail weighs at least as much as the amount specified as the differential trip weight during the installation of your mailing system. Refer to the *Set Up the Scale/Select Rates: Diff Weigh Trip Weight* section in *Chapter 5* in this guide.
- Make sure the stack of mail is less than the capacity of the scale. If "overweight" appears on the display, remove pieces of mail until the message disappears.

To use differential weighing:

1. Remove all pieces of mail from the scale.
 2. Set the scale to zero by pressing the **Menu** key, then selecting **Zero Scale**.
 3. Press the **Mode** key.
 4. Select **Differential Weighing**.
 5. The system prompts you to place the mail on the scale.
-



CAUTION: Make sure you center the mail on the scale and check to be sure it is not touching any other surface or object.

6. Place the mail on the scale.
 - If you have previously selected a class, the system displays the following prompt at the top of the screen: *Print tapes automatically On or Off.*
 - If you select **On**, then when you remove each piece of mail, the system automatically prints a tape.
 - If you select **Off**, you remove the first piece of mail and place it on the feed deck. The system automatically feeds the mail.
 - If you have not previously selected a class, you are prompted to select one now. For more information, refer to “*Selecting the Class, Carrier, Special Services or Options*” in this chapter.
7. Begin removing mail from the scale. Please note the following:
 - Remove each piece of mail in a single continuous motion.
 - If you mistakenly remove more than one piece of mail, put all of the pieces of mail back on the scale. If you only put one piece back on, the system does not print the correct postage.
8. When you remove the last piece of mail from the scale, the system asks you if you want to print postage. This is in case the last piece you remove from the scale is the container for the mail.

**Mode Selection:
Manual Weight
Entry**

To perform manual weight entry:

1. Press the **Mode** key.
2. Select **Manual Weight Entry**.
3. Type in the number of pounds and press **Enter**.
4. If the weight of your mail is less than 1 lb, press the right arrow key to go to the ounces field.
5. Type in the number of ounces and press **Enter**.
Press the **Class** key if required and select the class. For more information, refer to “*Selecting the Class, Carrier, Special Services or Options*” in this chapter.

NOTE: If the weight you enter is invalid for the class, you are prompted to select another class.

6. If this is a package, press the **Tape** key, otherwise go to step 7.
7. Place the piece of mail on the feed deck.
8. Press the **Start** key.

Mode Selection: Attached Scale

Use this option if the AutoScale feature is set to Off see *Set Up Scales/Rates: AutoScale* in *Chapter 5* in this guide.

1. Press the **Mode** key.
2. Select **Attached Scale**. The “Attached Scale Mode” screen appears.
3. Place the piece of mail on the scale.



CAUTION: Make sure you center the mail on the scale and check to be sure it is not touching any other surface or object.

4. If the class displayed in this screen is incorrect, press the **Class** key and select the class. For more information, refer to “*Selecting the Class, Carrier, Special Services or Options*” in this chapter.
5. If this is a package, press the **Tape** key, otherwise go to step 6.
6. Place the piece of mail on the feed deck.
7. Press the **Start** key.

Mode Selection: Seal Only

Seal Only Mode allows you to seal envelopes without applying postage. If you are running INVIEW™ Accounting, and you select Seal Only Mode, you will be prompted to select an account to track the pieces against.

When you view or print an accounting report, “Seal Only” will appear in the Class column if the pieces were processed in Seal Only mode.

1. Press the **Mode** key.
2. Select **Seal Menu - No Printing** and select the appropriate option.
3. Select the **Reset Counter** option if you want to clear the number of pieces of mail fed into the machine in the seal only mode.
4. Place the mail on the feed deck.
5. Press the **Start** key.

NOTE: For additional sealing options, press the **Seal** key on the IntelliLink® Control Center. This allows you to select the following options:

- Sealer on (seal envelopes)
- Sealer off

Seal only, don't print

**Mode Selection:
Time and Date
Stamping**

Time Date Stamping mode allows you to print the current time and date, along with the word “Received” on incoming mail.

NOTE: If you are using INIVEW™ Accounting, Time and Date Stamping mode has additional attributes. Refer to “*Selecting an Account in Time Date Stamping Mode*” in *Chapter 7* for more information.

The time and date will remain the same during a single transaction (whether you process a single envelope or 100 envelopes.) The system will update the date and time during the mail run.

NOTE: The mailing system may operate at a slightly slower speed during this process.

1. Press the **Mode** key.
2. Select **Time and Date Stamping**. The time/date stamp appears in place of the meter stamp on the Main screen.
3. Turn the piece of mail over, so the meter stamp is facing down. Then, place the envelope on the feed deck with the flap facing up.
4. Press the **Start** key. The Time/Date stamp prints on the envelope.

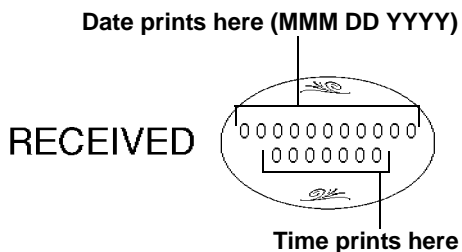

4 Selecting or Deselecting an Account

If you use Accounting, you must select an account. If you are using Budget Manager or Business Manager refer to the operator guide or help system provided with those applications.

Selecting an Account

You can select an account manually by scrolling through the entire list of accounts on your system.

If you know part of the account name or the speed code, you can use the account name search or the speed code search to locate the account you want to use.

If you know only part of the account name or the speed code, you can use the account name or speed code search to narrow down the list of accounts to those that most closely match the search criteria you entered.

NOTES: You can use the left arrow key to toggle between the account name and speed code search methods on the Select Account screen. When you select an account by name or by speed code, the search setting remains in effect even after you leave the Select Account screen. The next time you select an account, the last search method you used will be active.

Selecting an Account Manually

Follow the steps below to select an account:

1. Press the **Account** screen key. The Select Account screen appears listing all of your accounts.
2. Select the Account you want to use to charge postage. Use the down arrow key to scroll through the Account list, then press the screen key that corresponds with the account name.
3. If the Account password is enabled, the Enter Account Password screen appears. If the Account password is not enabled, go to step 4.
 - a. Type in the password.
 - b. Press **Enter**.
4. The system returns to the Main screen. The name of the account you selected appears in the Account field.

Selecting an Account by Name

The account name search allows you to type in the account name, or part of the account name, to narrow down your search. Follow the steps below to select an account by name:

1. Press the **Account** screen key. The Select Account screen appears listing all of your accounts.
2. If necessary, press the left arrow key to toggle the search by account name method.
3. Type in the first few characters of the account name. The list on the screen will show all the account names that start with the characters you have entered.
4. Select the account you want to use:
 - Press **Enter** to select the account that most closely matches the characters you searched on; or
 - If a list of account names appear on the screen, press the screen key that corresponds with the account you want to use.The system returns to the Main screen, and the name of the account appears in the Account field.
5. If the account password is enabled, the Enter Account Password screen appears. If the account password is not enabled, go to step 4.
 - a. Type in the password.
 - b. Press **Enter**.

Selecting an Account by Speed Code

The speed code search allows you to type in the speed code, or part of the speed code, to narrow your search. Follow the steps below to select an account by speed code:

1. Press the **Account** screen key. The Select Account screen appears listing all of your accounts.
2. If necessary, press the left arrow key to toggle the search by account name method.
3. Type in the speed code, or the first few numbers of the speed code. The screen will show the account names that correspond with the speed code you typed.
4. Select the account you want to use:
 - Press **Enter** to select the account that most closely matches the characters you searched on; or
 - If a list of account names appear on the screen, press the screen key that corresponds with the account you want to use.The system returns to the Main screen, and the name of the account appears in the Account field.
4. If the account password is enabled, the Enter Account Password screen appears. If the account password is not enabled, go to step 4.
 - a. Type in the password.
 - b. Press **Enter**.

Deselecting an Account

1. Press the **Accounts** key.
2. Select **0. None** from the top of the list.
3. "Account: None" now appears in the main screen.

5 Selecting the Class, Carrier, Special Services or Options

Each carrier has its own set of classes and each class has its own set of special services. When you select a class or carrier, only those options available for that selection display in the main screen.

NOTE: When selecting a class/carrier:

- If your system has been set up to retain the class on each piece of mail weighed then the class that appears in the main screen will be the one you selected last.
- If you turn off and then turn on the power to your system, or if your system has been set up to clear the class on each piece of mail weighed, it will clear the class. In this case, you need to select a new class.
- If you place a piece of mail on the scale, or enter a weight manually, the system automatically prompts you to select a new class if the new weight requires a different class.

-
1. Press the **Class** key. A list of available classes appears in the screen.
 2. Select the class and press **Enter**.
 3. If a ZIP Code or Zone is required, you are prompted to enter it. Press **Enter** to accept it. For more information, refer to *“Selecting ZIP Codes and Zones”* in this section.
 4. If a country is required, you are prompted to select it. Press **Enter** to accept. For more information, refer to *Selecting a Country* in this section.
 5. If special services are available with the class you select, they are displayed.
 6. Even if you do not want any special services, press the **Enter** key to confirm the class.
 7. Press the **Tape** key to print a postage tape. To apply postage to a piece of mail, place it on the feed deck and press the **Start** key.

Selecting ZIP Codes and Zones

If your postal rate or special service requires a ZIP Code or Zone, you are prompted to enter it. The system prompts you for either the ZIP Code or Zone (for details, see *Setting Up the Scale/Rates: ZIP/Zone prompt* section in *Chapter 5* of this guide).

1. When you select a class, you may be prompted to enter the ZIP Code or Zone:
 - To access the Intra-BMC Package Services Parcel Post rates, enter only the first 3 digits of the ZIP Code.
 - To access the Inter-BMC Package Services Parcel Post rates, enter all 5 digits of the ZIP Code.
2. Press **Enter**.

Selecting a Country

If your class requires you to select another country:

1. A list of countries appears in the display. You can scroll through the countries:
 - Using the up/down arrows;
 - By typing in the first few letters of the country until you get a match; or
 - By typing in the numeric code for that country.
2. Select the country you want.

Selecting a Smart Class™

1. Press the **Class** key.
2. Press the right arrow key (**II Rates**).
3. You are prompted to "Select Rate". Select the name of the custom carrier you created, for example, *Carrier 1*.
4. You are prompted to "Select Class". Select the name of the Smart Class™ you created, for example, *Smart Class 1*.
5. The name of the Smart Class™ appears in the main display along with the first weight break class:

▶	Class: Smart Class 1
	1st Class Auto Letter 5 Digit

6. For more information on creating a Smart Class™, refer to *Setting up the Optional Smart Class™ Feature* in *Chapter 5* in this guide.

6 Selecting the Meter Stamp Options

The Meter Stamp Options selection allows you to change the elements printed on your piece of mail or tape.

You access the Meter Stamp options by pressing the **Menu** key on the IntelliLink® Control Center and then selecting **Meter Stamp Options**.

The list of options that display depends on the model number of your mailing system. All of the possible options, shown in the menu on the right, are described in this section.

Meter Stamp Options

- ▶ Date
- ▶ Ad/Message
- ▶ Inscription
- ▶ Piece ID Number*
- ▶ Print Position
- ▶ Multiple Tapes
- ▶ Custom Messaging

*International Use Only

Meter Stamp Options: Date

1. Press the **Menu** key.
2. Select **Meter Stamp Options**.
3. Select the **Date** option. Depending on your previous selections, a combination of the following selections appears.
 - Don't Print Date
 - Print only Month and Year
 - Advance Date (see NOTE)
4. Make your selection and follow the prompts on the main screen. Press **Enter** when complete.

NOTE: If you select **Advance Date** and choose to store it in a preset, refer to *How to Store Advance Date in a Custom Preset* in Chapter 5 in this guide.

Meter Stamp Options: Advertisement

You can have a variety of advertisements appear on your mail.

To add more advertisements, refer to *Performing Updates or Adding Features* in Chapter 9 in this guide.

1. Press the **Menu** key.
2. Select **Meter Stamp Options**.
3. Select the **Ad/Message** option.
4. Use the down arrow key to scroll through the advertisements.
5. Press the screen key that is next to the advertisement you want. The advertisement then appears next to the meter stamp.

The advertisements provided with your system are shown here.

Address Service Requested
 Return Service Requested
 Seasons Greetings
 United States Flag

Recycle
 Happy Thanksgiving
 Please Open Immediately
 Urgent

ADDRESS SERVICE
 REQUESTED

**PLEASE OPEN
 IMMEDIATELY**



RETURN SERVICE
 REQUESTED



**Meter Stamp
Options:
Inscription**

You can have a variety of inscriptions appear on your piece of mail. For a list of the inscriptions provided with your mailing system, refer to *Chapter 11, Supplies and Options* in this guide.

To add more inscriptions, refer to *Performing Updates or Adding Features* in *Chapter 9* in this guide.

1. Press the **Menu** key.
2. Select **Meter Stamp Options**.
3. Select the **Inscription** option.
4. Use the down arrow key to scroll through the inscriptions.
5. Press the screen key that is next to the inscription you want. The inscription then appears next to the meter stamp.

The inscriptions provided with your system are shown here.

Presorted First Class	Air Mail
Presorted Standard	Printed Matter
Non Profit Organization	First Class
Standard	Priority Mail
Par Avion	Presorted

PRESORTED FIRST CLASS	PRESORTED STANDARD	BULK RATE	NON PROFIT ORGANIZATION	STANDARD	PAR AVION	AIR MAIL	PRINTED MATTER	FIRST CLASS	PRIORITY MAIL	PRESORTED
--------------------------	-----------------------	-----------	----------------------------	----------	-----------	----------	-------------------	-------------	---------------	-----------

**Meter Stamp
Options: Print
Position**

This selection allows you to move the print position of the meter stamp away from the right edge of the envelope.

1. Press the **Menu** key.
2. Select **Meter Stamp Options**.
3. Select the **Print Position** option.
4. Use the left and right arrow keys to switch between the possible positions (1 - 5 where 1 is the position closest to the right edge).

**Meter Stamp
Options:
Multiple Tapes**

This provides an alternate method for printing multiple tapes.

1. Press the **Menu** key.
2. Select **Meter Stamp Options**.
3. Select the **Multiple Tapes** option.
4. Enter the number of tapes you want to print.
5. Press **Enter**.

**Meter Stamp
Options:
Custom
Messaging**

This selection allows you to add a custom message adjacent to the meter stamp. For more information about custom messaging, refer to *Creating Custom Messages* in *Chapter 5*.

1. Press the **Menu** key.
2. Select **Meter Stamp Options**, then select **Text Entries**.
3. Select the custom message you want to print on the envelope.
4. Press **Enter** when done.
5. Press the left arrow key to return to the Main screen.

7 Using Electronic Confirmation Services

The United States Post Office (USPS) provides three types of confirmation services:

- **Delivery Confirmation** - shows you when the postal carrier delivered the mail.
- **Signature Confirmation** - shows you who signed for the mail.
- **Certified Mail** - provides you with proof that you mailed the item.

Each of these services has its own barcode labels. Using preprinted barcode labels provided by Pitney Bowes, you can electronically process and submit records for the three types of USPS Confirmation Services to the Pitney Bowes Data Center.

Overview

Postage Calculation for Confirmation Services

As soon as you weigh your piece of mail and select the class and service, your mailing system automatically calculates the postage.

NOTE: When using these services, you cannot type in the postage manually. You can however use manual weight entry.

Discounts for Confirmation Services

- When you use any of these services with your mailing system and send the barcodes electronically over the phone line, you get a discount on the cost of the service.
- In some cases, like adding Electronic Delivery Confirmation to a Priority letter, you only pay the postage required for Priority mail.

NOTE: Your discounts are valid only if you use the barcode labels provided by Pitney Bowes and send the records electronically.

Sending Your Records to Pitney Bowes

Your system stores up to 100 of your barcode records and automatically connects to Pitney Bowes and uploads these records either at the scheduled time you specified during set up, or whenever you have processed the maximum number of pieces of mail on the system.

NOTE: In order to automatically upload your records, your system must have a full-time LAN or dedicated analog phone line connection.

Tracking Information on the Internet

- After 24 hours you can track your mail on the internet using your Pitney Bowes Postage By Phone® Meter Payment System account number and the barcode number. Refer to the *Contact Information List* at the front of this guide for more information.
- You can also track your mail by going to the Postal Service's web site at www.usps.com.

Adding Services or Making Changes

- If you already have postage on the mail and then decide you want to add a service, follow the instructions here for *Adding Confirmation Services After Printing Postage*.
- If you need to add more postage to cover the confirmation services, refer to the section, *Add Postage and/or Change the Date* in this chapter.
- If you realize you have put the wrong barcode on a piece of mail or package, you can change it as long as you have not sent the records to Pitney Bowes. Follow the instructions here for *Editing, Deleting or Sending Confirmation Services Records*.

Using Confirmation Services Before Printing Postage

USPS Confirmation Services are available when you are in the Attached Scale mode, or Manual Weight Entry mode. Refer to “*Selecting the Postage Mode and Running the Mail*” in this chapter for more information.

The following procedure is based on using a **Priority** class and the **E-Del Con** service. Your procedure may vary slightly depending on your class and service.

1. Place the piece of mail or package on the scale.
2. Press the **Class** key.
3. Select the class, for example, **Priority**.
4. Select the service, for example, **E-Del Con**. As soon as you select the service, a check mark appears in front of it.
5. Press the **Enter** key.
6. At this point, you are prompted to enter the 5-digit destination ZIP Code. Use the numeric keyboard to enter the code.
7. Press the **Enter** key and the “Barcode” screen appears.
8. If this is the first time you are entering a confirmation service, the screen is blank and you need to enter the entire barcode value. If you have a barcode scanner, you can scan in the number.
 - a. If you have used the confirmation service before, the next barcode value (in the series of barcode labels) appears, minus the last digit.
 - b. If you have used all of the labels in a series of barcode labels, make sure you start with the top label with the lowest last 4-digits and not the bottom label with the highest last 4-digits. If you have a barcode scanner, you can scan in the number.
9. If you are using a barcode scanner and have set up your system to automatically enter the barcode value (see *Setting Auto-Enter* in *Chapter 5* in this guide), go to step 10.

If you type in the barcode value, enter the last digit of the number from the label you will use. Then press the **Enter** key to accept the barcode value and the system returns to the main screen (“Attached Scale Mode” appears).

NOTE: Make sure the barcode on the label matches the barcode value you just entered in the system.

10. Press the **Tape** key to print a tape. To print postage on a piece of mail, place it on the feeder and press the **Start** key.
11. You are prompted to apply the barcode label to the package. Apply the barcode to the package.

12. Press the **Enter** key. The “Enter another package?” screen appears. Follow the screen prompts to process more pieces of mail for confirmation services.

Adding Confirmation Services After Printing Postage

If you have already applied postage to a piece of mail and you now want to add a confirmation service to it, follow the procedure here.

This procedure is based on using a **Priority** class and the **E-Del Con** service. Your procedure may vary slightly depending on your class and service.

1. Place the piece of mail or package on the scale.
2. Press the **Menu** key.
3. Press the down arrow key and then select **Confirmation Services**.
4. Select **Add Record**. The “Select Class” screen appears.
5. Select the class, for example **Priority Mail**. The “Select Service” screen appears.
6. Select the service, for example, **E-Del Con**. Press the **Enter** key.
7. At this point, you are prompted to enter the 5-digit destination ZIP Code. Use the numeric keyboard to enter the code.
8. Press the **Enter** key and the “Barcode” screen appears.
 - If this is the first time you are entering a confirmation service, the screen is blank and you need to enter the entire barcode value. If you have a barcode scanner, you can scan in the number.
 - If you have used the confirmation service before, the next barcode value (in the series of barcode labels) appears, minus the last digit.
 - If you have used all of the labels in a series of barcode labels, make sure you start with the top label with the lowest last 4-digits and not the bottom label with the highest last 4-digits. If you have a barcode scanner, you can scan in the number.
 - If you are using a barcode scanner and have set up your system to automatically enter the barcode value (see *Setting Auto-Enter* in *Chapter 5* in this guide), go to step 9.
 - If you type in the barcode value, enter the last digit of the number from the label you will use. Then press the **Enter** key. Once you have entered or accepted the displayed barcode value, you get a screen that summarizes the information you are sending.

NOTE: If you have selected a confirmation service that is not free, the postage amount appearing in the summary will be greater than the amount of postage you have already applied. If this is the case, you must add more postage after you have applied the barcode. Refer to the *Add Postage* section in this chapter.

9. Press the screen key for **OK** and the system stores the confirmation information. You are prompted to apply the barcode label to the package.
10. Press the **Enter** key. The “Enter another package?” screen appears. Follow the screen prompts to process more pieces of mail for confirmation services.

**Editing, Deleting
or Sending
Confirmation
Services
Records**

This procedure tells you how to edit, delete or send confirmation services records once you have entered them into your system.

Your system can store up to 100 of your barcode records before sending them to Pitney Bowes.

1. Press the **Menu** key.
2. Press the down arrow key and then select **Confirmation Services**.
3. Select the appropriate option:
 - To edit an existing record, select **Edit records**. You can edit either the ZIP Code or barcode entry. To modify the class or service, you need to delete the record and add it as a new record.
 - To delete a record, select **Mark record for deletion** (you cannot delete a record once you have sent it to Pitney Bowes).
 - To send all of the confirmation service records now, select **Send records**.
4. As soon as the system sends all of your records, you can select to print a receipt on a tape or an envelope, or you can skip printing a receipt altogether.

**Using Electronic
Return Receipt
(ERR)**

ERR is the electronic version of the Return Receipt, and is a complimentary service to the E-Certified Mail service offered on the DM Series system. When the user selects E-Certified, and E-Return Receipt, they will be able to track their Certified Mail and Return Receipts over the Internet, including both www.pb.com and www.usps.com.

NOTE: These electronic services for Certified Mail and Return Receipt are fully approved by the USPS.

Processing Certified Mail electronically through the DM Series™ mailing system enables you to track delivery over the Internet. When this E-Certified Mail is processed with E-Return Receipt, the mailer receives a significant benefit by processing through the mailing system.

- First, the E-Return Receipt is processed at a discount from the normal "Green Card" for Return Receipt.
- Secondly, the Green Card is substituted by an electronic PDF document that includes the delivery information and recipient signature. This eliminates the hard copy Green Cards that often get lost or misfiled.
- And most importantly, the electronic information is stored for 7 years, allowing electronic access to the records at no additional charge.

Installation/Setup

IMPORTANT: Perform the following steps in the order given.

1. Verify that services are enabled:
 - a. Press **Existing Features**.
 - b. Press **Confirmation Services**.
 - c. Verify that the services are enabled. The list of services that appears may look like the sample shown at the right.
2. If you have not already done so, enter the Customer **Data Universal Numbering System Number**. This number must be manually entered the first time on the Mailer ID/DUNS prompt screen after ERR is enabled.

Confirmation Services	
Delivery Confirmation:	Enabled
Signature Confirmation:	Enabled
E-Certified:	Enabled
E-Return Receipt:	Enabled
E-Ret Receipt w/Ref #:	Enabled

NOTE: The Mailer ID/D-U-N-S[®] number is a unique nine-digit identification sequence that identifies businesses by geographical location. The intent is to identify both the mailer and unique location of the mailer.

- a. Press the **Menu** button.
 - b. Select **Set Up**, then **Basic Settings**.
 - c. Select **My Mailer ID/DUNS Number**.
 - d. Type in the Mailer ID/DUNS number.
 - e. Press **Enter** when done.
 - f. Press the left arrow key to return to the Main screen.
3. Verify the barcode scanner is set up and functional. With the auto-enter feature set to "ON" you can save some keystrokes as you step through a Confirmation Services transaction.
4. Verify the printer is set up and functional.

Setup Options

1. Press the **Menu** button.
2. Select **Confirmation Services**.
3. Select the right arrow to go to **Set Up CFM Svcs**. You are now in the Cfm Svcs Setup Screen. Each option is explained below.
 - **Apply Label Prompt** - If this option is on, the system automatically prompts the operator to apply the barcode label to each Confirmation Services mail piece.
 - **Upload Records Prompt** - When on, this option prompts the operator to upload records after each Confirmation Services piece of mail is run.
 - **Receipt Prompt** - When on, this option prompts the operator to print receipts after uploading records.
 - **Postal Manifest Prompt** - When on, this option prompts the operator to print the manifest report after uploading records.
 - **DelCon Customer Reference** - If this option is on, and Delivery Confirmation is selected, the system will prompt the operator to enter a customer reference number.
 - **SigCon Customer Reference** - If this option is on, and Signature Confirmation is selected, the system will prompt the operator to enter a customer reference number.
 - **E-Certified Customer Ref** - If this option is on, and E-Certified is selected, the system will prompt the operator to enter a customer reference number.
 - **BPOD for SigCon** - If this option is on, and Signature Confirmation is selected, the system will include your D-U-N-S® Number for bulk signature retrieval.
 - **Records Warning** - This option allows the operator to enter the number at which the system will warn that only a few more Confirmation Services mail pieces can be processed: 0 records remaining.

Processing Electronic Return Receipt

1. Weigh the envelope/package. Place the mail piece on the attached scale or process using the mailing machine in the WOW® mode.
2. Select class: Select the class of mail, for example, **First Class** or **Priority Mail**.
3. Select services:
 - a. Select **E-Certified** as the service for mail.
 - b. Select **E-Ret Receipt**.
 - c. Press **Enter**.
4. Enter the destination ZIP Code:
 - a. Scan or manually type the 5-digit destination ZIP Code.
 - b. Press **Enter**. (This step is not required if the system is set to auto-enter.)

5. Enter the USPS tracking barcode number.

NOTES:

- You will not be prompted to enter the Customer Reference Number if you scanned a combined barcode when entering the destination ZIP Code.
 - If you use labels supplied by Pitney Bowes, be sure to use the correct label for the selected service, in this case E-Certified (dark green) labels. If the control panel display shows the next number in the barcode sequence, enter the last digit to accept it as long as it matches the number on your next label; or scan or manually type in the 22-digit barcode number from the label you're using.
 - If the control panel does not show the next number in the barcode sequence, it shows the next number in the barcode sequence MINUS the check digit (last digit). You must enter the check digit.
-

6. Apply the barcode:
 - a. Apply the 22-digit barcode label to your mail piece if it is not already pre-printed on the mail piece.

NOTE: 22-digit barcode labels for tracking E-Certified Mail *must* begin with "9171" in order to be tracked correctly per USPS guidelines.

- b. Press **Enter**. (This step is not required if the system is set to auto-enter.)
7. Print postage:
 - Press **Start** to print the postage on the envelope, *or*
 - Press **Tape** to print a tape.The control center returns to the Main screen.

8. For multiple mail pieces:
 - a. Press the **ZIP** key.
 - b. Type in the ZIP Code.
 - c. Press **Enter**.
 - d. Start processing the next mail piece.

9. Repeat steps 1-8 as necessary.

10. Transfer Files:
 - a. Connect the control center to the Pitney Bowes Data Center.
 - b. Upload your records no later than the end of every day. To do this, press **Menu** and select **Confirmation Services**.

11. The display automatically prompts you to print receipts or reports after you upload records, provided this feature is enabled in the customer setting menu (the default for this option is enabled). Use the **Reports** key to select and print receipts and, optionally, a report of all tracking information processed through the control panel.

Using ERR with a Customer Reference Number

The Pitney Bowes solution for Electronic Return Receipt (ERR) may include the option to use a Reference Number that can tie the USPS Tracking Number to an internal tracking number your organization assigns to a client or matter. By using this Reference Number, you'll be able to look up tracking numbers on the Internet, and relate that piece of mail to a specific client.

Pitney Bowes provides a Reference Label Application to support you with processing mail using the Reference Number. This includes the ability to print a barcode label (in the standard 3 of 9 format) that can be applied to the mail piece for customer reference tracking for Electronic Return Receipt. The label includes the 5-digit destination ZIP Code required by the USPS, which eliminates the steps required to enter this information manually into the DM Series™ mailing system. The Reference Number can be up to 14 alphanumeric characters in length.

This information can be easily scanned into the mailing machine during mail processing, saving valuable time in entering the data manually. Also, you can access delivery information from *www.pb.com* at "MyAccount." Using this site, you can search records using your unique customer reference number or the USPS tracking number from the Green Label.

Processing ERR with a Customer Reference Number

1. Weigh the envelope/package. Place the mail piece on the attached scale or process using the mailing machine in the WOW® mode.
2. Select class: Select the class of mail, for example, **First Class** or **Priority Mail**.
3. Select services:
 - a. Select **E-Certified** as the service for mail.
 - b. Select **E-Ret Receipt**.
 - c. Press **Enter**.
4. Enter the destination ZIP Code:
 - a. Scan or manually type the 5-digit destination ZIP Code.
 - b. Press **Enter**. (This step is not required if the system is set to auto-enter.)
5. Enter the USPS tracking barcode number.

NOTES:

- You will not be prompted to enter the Customer Reference Number if your barcode includes the reference number.
- If you use labels supplied by Pitney Bowes, be sure to use the correct label for the selected service, in this case E-Certified (dark green) labels. If the control panel display shows the next number in the barcode sequence, enter the last digit to accept it as long as it matches the number on your next label; or scan or manually type in the 22-digit barcode number from the label you're using.
- If the control panel does not show the next number in the barcode sequence, it shows the next number in the barcode sequence MINUS the check digit (last digit). You must enter the check digit.

-
6. Apply the barcode:
 - a. Apply the 22-digit barcode label to your mail piece if it is not already pre-printed on the mail piece.

NOTE: 22-digit barcode labels for tracking E-Certified Mail *must* begin with "9171" in order to be tracked correctly per USPS guidelines.

- b. Press **Enter**. (This step is not required if the system is set to auto-enter.)
7. Enter the customer reference number.
 - a. Scan or manually type your own unique reference number for this mail piece. This can be a Client Number, Summons Number, Policy or Claim Number, or Invoice Number. You will not be prompted for this number if you scanned a combined barcode that includes the customer reference number and destination ZIP Code.
 - b. Press **Enter**.
8. Print postage:
 - Press **Start** to print the postage on the envelope, *or*
 - Press **Tape** to print a tape.The control center returns to the Main screen.
9. For multiple mail pieces:
 - a. Press the **ZIP** key.
 - b. Type in the ZIP Code.
 - c. Press **Enter**.
 - d. Start processing the next mail piece.
10. Repeat steps 1-9 as necessary.
11. Transfer Files:
 - a. Connect the control center to the Pitney Bowes Data Center.
 - b. Upload your records no later than the end of every day. To do this, press **Menu** and select **Confirmation Services**.
12. The display automatically prompts you to print receipts or reports after you upload records, provided this feature is enabled in the customer setting menu (the default for this option is enabled).
Use the **Reports** key to select and print receipts and, optionally, a report of all tracking information processed through the control panel.

Off-Line Electronic Return Receipt (ERR)

Off-line ERR allows you to process Certified Mail™ with Electronic Return Receipt using applications other than Pitney Bowes' electronic Certified Mail solution.

If you already have a Certified Mail solution, or acquire one outside of Pitney Bowes, you can use the Off-line ERR feature to process your Certified Mail and Electronic Return Receipt without entering or scanning the tracking number into the meter. The appropriate fees for Certified Mail and ERR will be applied to the mailpiece automatically. You then refer to your service provider's application to track the mail and obtain the electronic return receipt.

Follow the steps below to select the Off-line ERR feature:

1. On the main screen, select **Class**. The Select Class menu opens.
2. Select **1stCl Letter**.
3. Select **Letter**.
4. Select **Certified**.
5. Select **Offline eRR**.
6. Press **Enter**. The system returns to the main screen.

8 Adding Postage or Changing the Date

If you do not have the correct postage or date on a piece of mail, you can add more postage or change the date directly on a piece of mail. If you prefer, you can print the corrections on at a tape instead and then apply it to the piece of mail.

To add more postage:

1. If you are printing more postage on an envelope and if the envelope is sealed, press the **seal** key and select **Sealer Off**. If you are printing on a tape, go to step 3.
2. Turn the piece of mail around 180 degrees so that the meter stamp is in the lower left corner as shown here. Then, place the envelope on the feed deck with the flap facing down.

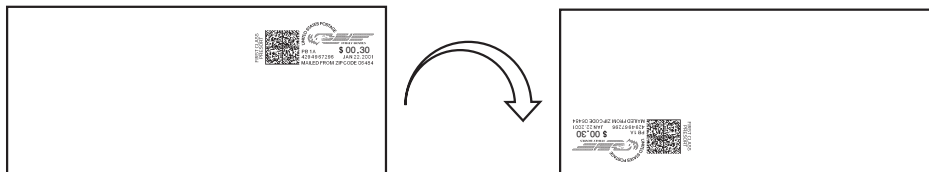

3. To add more postage, press the **Mode** key and select **Key In Postage**.
4. Enter the additional amount using the numeric keys and press **Enter**. Press the **Start** key. If you are printing a tape, press the **Tape** key.
5. The additional postage prints on the envelope as shown here.

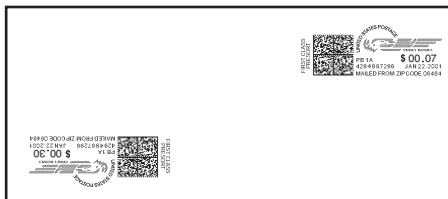

6. If you print a tape, apply the tape to the envelope below the existing meter stamp.

To change the date:

1. If you are printing the date correction on an envelope and if the envelope is sealed, press the Seal key and select Sealer Off. If you are printing on a tape, go to step 3.
2. Turn the piece of mail around 180 degrees so that the meter stamp is in the lower left corner as shown here. Then, place the envelope on the feed deck with the flap facing down.

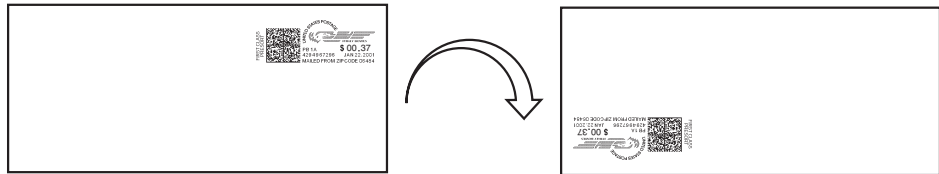

3. Press the **Mode** key and select **Key In Postage**.
4. Enter the 00.00 for the postage value using the numeric keys and press Enter.
5. Press the **Menu** key and then select **Meter Stamp Options**.
6. Select the **Date** option and make the appropriate selection.
7. Follow the prompts on the main screen. Press Enter when complete.
8. Press the **Start** key.
If you are printing a tape, press the **Tape** key.
9. The date correction prints on the envelope as shown here:

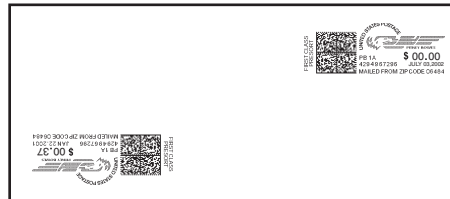

10. If you print a tape, apply the tape to the envelope below the existing meter stamp.

9 Clearing the Batch Count

If you keep track of the number of pieces of mail you process for each job or mail run, you may want to clear the batch count at the end of a run or just before starting a new run. The batch count appears on the display in the lower right corner.

To clear the batch count:

1. Press the **Funds** key.
2. The “View Funds” screen appears.
3. Press the right arrow key to clear the batch count.
4. If you have specified that a supervisor password must be entered to clear the batch count, you are prompted to enter the password now.
5. Enter the password and press the **Enter** key.

5 • Mailing System Setup



Contents

<i>Navigating Hints</i>	<i>5-2</i>
<i>Overview of Mailing System Set Up</i>	<i>5-3</i>
<i>Setting the Display Language</i>	<i>5-4</i>
<i>Adjusting Display Contrast</i>	<i>5-4</i>
<i>Setting the Date and Time of Day</i>	<i>5-5</i>
<i>Setting Up a Supervisor Password</i>	<i>5-6</i>
<i>Setting Up a Lock Code</i>	<i>5-6</i>
<i>Setting Up the Scale and Selecting Rates</i>	<i>5-7</i>
<i>Setting Up Postage By Phone® Meter Payment System</i>	<i>5-16</i>
<i>Configuring High/Low Funds Warning</i>	<i>5-19</i>
<i>Configuring Low Ink Warning</i>	<i>5-19</i>
<i>Configuring System Timeouts</i>	<i>5-20</i>
<i>Defining Presets</i>	<i>5-22</i>
<i>Creating Custom Messages</i>	<i>5-27</i>
<i>Taking the Meter Out of Service</i>	<i>5-30</i>
<i>Adding an Optional Printer</i>	<i>5-30</i>
<i>Configuring the Optional Barcode Scanner</i>	<i>5-31</i>

Navigating Hints

- The maximum number of options displayed is 5. To view more options, press the down arrow key.
- You can select a numbered option either by pressing the screen key next to the option, or by pressing the corresponding number on the keyboard and then pressing the **Enter** key.
- To go back one screen or more, clear an entry, or return to the “Ready” screen, press the **Clear** key. Pressing the left arrow key returns you to the main screen.
- Other selection or navigation or help information appears at the bottom of the screen. Also, check for messages next to the arrow keys on the bottom right side of the screen.

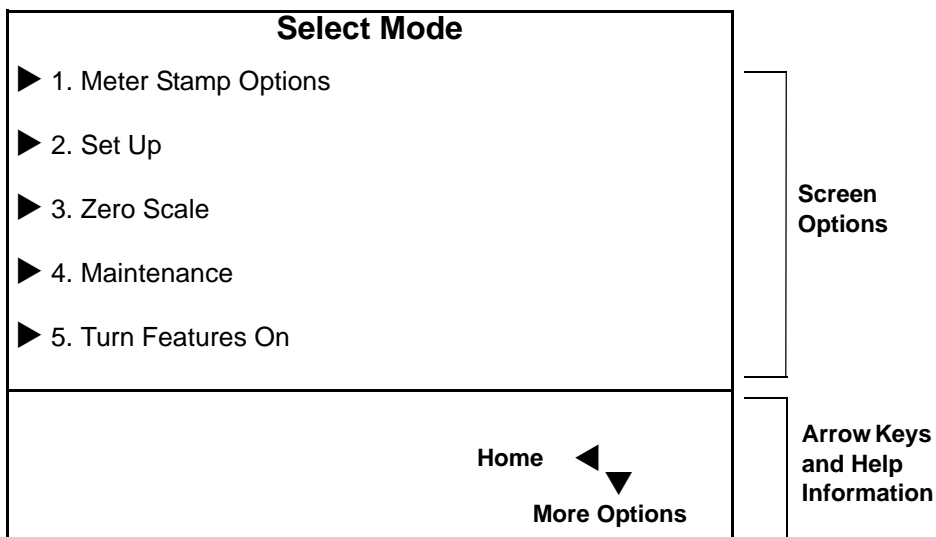

Overview of Mailing System Set Up

Follow the other procedures listed here as needed.

For details on each procedure, refer to the section number listed here.

- 1** Set the Display Language.
- 2** Adjusting the Display Contrast and Volume Control.
- 3** Setting the Date and Time of Day.
- 4** Setting up a Supervisor Password.
- 5** Setting up a Lock Code.
- 6** Setting up the Scale and Selecting Rates.
- 7** Setting up Postage By Phone®.
- 8** Configuring High and Low Funds Warnings.
- 9** Configuring Low Ink Warnings.
- 10** Configuring System Timeouts.
- 11** Defining Presets.
- 12** Creating Custom Messages.
- 13** Taking the Meter Out of Service.
- 14** Setting up the Optional Printer.
- 15** Configuring the Optional Barcode Scanner.

1 Setting the Display Language

Depending on the model of your mailing system, you may be able to set the display to any of the following languages:

- English
- Espanol
- Francais

To change the language of the display:

1. Press the **Menu** key.
2. Select **Set Up**, or press **1** and the **Enter** key.
3. Select **Change Language**, or press **4** and the **Enter** key.
4. Select the language you want to appear in the display.
 - Press **1** for English.
 - Press **2** for Espanol.
 - Press **3** for Francais.
5. Press the **Enter** key.

2 Adjusting Display Contrast

You can adjust the contrast of your display and set the volume (1D00 only) of the speaker on your mailing system.

To adjust the contrast level of your display:

1. Press the **Menu** Key.
2. Press the down arrow key and then select **Adjust Display Contrast**, or press **?** and the **Enter** key
3. Use the left or right arrow keys on the control center to select the contrast (1 - 9) you want. The screen updates to the new setting.
4. Press the **Enter** key to save this setting.

3 Setting the Date and Time of Day

If your mail is picked up at a certain time each day, you can set your system to advance the date at the mail pickup time.

NOTE: The date on the meter stamp should correspond to the date when your mail goes to the post office.

If you enter an invalid time or date, the system beeps and the screen displays the message: "Invalid Time".

To adjust the time and enter date advance:

1. Press the **Menu** key.
2. Select **Set Up**.
3. Press the down arrow and select **Time of Day**.
4. Select the option you want to set:
 - **Current Time** - if you select this option, enter the actual time. Use the right arrow key to toggle between AM and PM. You do not need to enter the colon (:) between hours and minutes. Press **Enter** to accept the time. To return to the main screen, press the left arrow key.
 - **Date will Advance After** - if you select this option, enter the time when you want the date to advance. As soon as your system reaches the time you set, it automatically advances the date 24 hours and prints that date on your postage.

EXAMPLE: If your mail goes to the Post Office at 3:00 PM each day, then set the date advance to "3:00 PM". Any mail processed after 3:00 PM will have the date for the following day printed on it. This ensures that the date printed on the mail piece corresponds with the date it is brought to the Post Office.

Press **Enter** to accept the time. To return to the main screen, press the left arrow key.

- **Daylight Saving** - if you select this option, you will be able to turn the Daylight Saving mode on or off. Select **Turn off**, or **Turn on**. To exit the Daylight Saving mode, press the left arrow key.

NOTE: Turn Daylight Savings Time on in the Spring and off in the Fall.

4 Setting Up a Supervisor Password

You can limit access to the following operations by creating a supervisor password.

- Adding Postage (Refill)
- Clearing Batch Information (the number of pieces of mail your system processes)
- Setting up Scale/Rates
- Accounting Set Up

Whenever you perform any of these operations, the system prompts you for the password.

Creating a Supervisor Password

1. Press the **Menu** key.
2. Select **Set Up**, then select **Basic Settings**.
3. Select **Supervisor Set Up**. Enter the current password if prompted.
4. Select **Edit (or Add) Supervisor Password** to create or change an existing password. The system prompts you to enter the password and then confirm it.

NOTE: Passwords are case-sensitive and must be at least 4 characters or digits long.

Password Protecting an Operation

1. Press the **Menu** key.
2. Select **Set Up**, then select **Basic Settings**.
3. Press the down arrow and select **Supervisor Set Up**.
4. Select the option that corresponds to the operation you want to password protect. The options are:
 - a. **Refill** - select this to require a password for adding postage.
 - b. **Clear Batch** - select this to require a password before you can clear the batch count information from the system. The batch count corresponds to the number of pieces of mail processed by the system.
 - c. **Scale/Rates Set Up** - select this to require a password before you can modify any of the Scale/Rates features.
 - d. **Accounting Set Up** - select this to password protect account editing and setup.

5 Setting Up a Lock Code

Use the Lock Code option to enter a four-digit password to prevent unauthorized use of your postage meter.

1. Press the **Menu** key.
2. Select **Set Up**, then select **Basic Settings**.
3. Select **Lock Code** and two options are displayed:
 - a. **Lock Code - On/Off**
 - b. **Change Lock Code**If this is the first time you are setting up a lock code, "Off" appears next to the Lock Code selection.
4. Select **Lock Code** and enter a four digit code. Press **Enter** and the system prompts you to confirm it. As soon as you confirm the code, "On" appears next to the Lock Code selection.
5. Press the **Clear** key or the left arrow to exit and set the lock code.
6. To activate the system lock, press the **Lock** button on the IntelliLink® Control Center.

6 Setting Up the Scale and Selecting Rates

You can use this section to set up how your scale works with your system.

For example, the **Attached Scale** option allows you to set your scale to accommodate for environments subject to vibrations.

The **Class if new Piece**, **Dest. if new Piece** and **Dest. if new Class** options allow you to specify if you want to clear or retain the class or destination (ZIP Code or Zone) whenever you put a new piece of mail on the scale.

The list of options that displays depends on the model number of your mailing system. All of the options are listed in the menu on the right.

1. To access the scale/rates options, press the **Menu** key on the IntelliLink® Control Center and select **Set Up** from the main screen. Press the down arrow key and select **Scale/Rates**.
2. If you have set up a supervisor password for Scale/Rates, you are prompted to enter the password.

Scale/Rates Set Up

- ▶ Attached Scale
- ▶ WOW® Weight Limit
- ▶ WOW® Start Key
- ▶ Autoscale
- ▶ Diff Weigh Trip Wt
- ▶ Carrier/Class Disp
- ▶ Class if new Piece
- ▶ Dest. if new Piece
- ▶ Dest. if new Class
- ▶ Autoclear Dest Value
- ▶ ZIP/Zone Prompt
- ▶ BMC Intra ZIP
- ▶ Add ZIPs to Zone 0
- ▶ Discount Code
- ▶ Cfm Svc
- ▶ Smart Classes
- ▶ Auto Rate Large Env

Scale/Rates: Attached Scale

This option appears only if you have an integrated scale or an attached external scale connected to your mailing system.

Use this option to select how much time your system allows the scale to settle (Normal or Adjust for Motion).

Select Adjust for motion if your mailing system is in an environment subject to vibrations, such as near air-conditioning vents or closing doors. If you select this, the scale will require more time to settle.

NOTE: If this is the first time you are using an attached scale, you may be prompted to enter a location code. Refer to the documentation that arrived with the scale, or contact the Pitney Bowes Help Desk. Refer to the *Pitney Bowes Contact Information List* at the front of this guide for the phone number.

1. Press the **Menu** key on the control center and select **Set Up**. Press the down arrow key and select **Scale/Rates**.
2. Select **Attached Scale**. The “Vibration Setting” screen displays.
3. Press the screen key for the Attached Scale selection in this screen to toggle between **Normal** and **Adjust for Motion**.
4. Press the **Enter** key to accept.

Scale/Rates: WOW® Weight Limit

You can set the WOW® weight limit to prevent the system from printing postage on pieces of mail that exceed a set weight.

1. Press the **Menu** key on the control center and select **Set Up**. Press the down arrow key and select **Scale/Rates**.
2. Select **WOW Weight Limit**.
3. Enter the weight in lbs., and/or press the right arrow key and enter the weight in oz. The weight cannot be great than 1 lb. 0 oz (or 0 lb. 16 oz).

NOTE: Select **Return to Maximum** If you want to reset to the default settings for the WOW weight limit.

4. Press the **Enter** to set the weight limit.

Scale/Rates: WOW® Start Key

While in WOW® mode, placing mail on the scale and manually typing a postage amount will change the postage mode. Select what should happen when the Start key is pressed.

- Select **Revert to WOW** to process the piece of mail in WOW® mode.
 - Select **Use Current Mode** to process the piece of mail in the current postage mode.
1. Press the **Menu** key on the control center and select **Set Up**. Press the down arrow key and select **Scale/Rates**.
 2. Select **WOW Start Key**.
 3. Select the appropriate option.
 4. Press **Clear** or press the left arrow key to exit.

Scale/Rates: Autoscale

You can set AutoScale to On or Off.

Select **On** to enable the AutoScale feature. When a mail piece is placed on the scale it will automatically weigh and rate the mail piece.

Select **Off** to disable this feature. If you disable this feature and your system has an attached scale, you need to select the Attached Scale mode when running mail if you want your system to weigh the mail and calculate postage. Refer to “*Selecting the Postage Mode and Running the Mail*” in *Chapter 4* of this guide.

1. Press the **Menu** key on the control center and select **Set Up**. Press the down arrow key and select **Scale/Rates**.
2. Press the screen key for the **AutoScale** selection to toggle between On and Off.
3. Press **Clear** or press the left arrow to exit.

Scale/Rates: Diff Weigh Trip Weight

Use this option to set the minimum weight that a piece of mail must weigh in order to use the differential weighing mode to print postage on a tape or on a piece of mail. For more information on differential weighing, refer to “Selecting the Postage Mode and Running the Mail” in Chapter 4 of this guide.

When your system is shipped, the trip weight is set to 0.5 ounces (10 grams). It is best to set the trip weight as high as possible to match the lowest weight that you will use. For example, a #10 envelope with a single insert typically weighs 0.4 ounces. In this case, you would set the trip weight to 0.4 ounces. This will improve the efficiency of your system, especially in the AutoTape mode.

1. Press the **Menu** key on the control center and select **Set Up**. Press the down arrow key and select **Scale/Rates**.
2. Select the **Diff Weigh Trip Wt** option and use the numeric keypad to enter the trip weight.
3. Press the **Enter** key to set the weight.

Scale/Rates: Carrier/Class Display

Use this option to control how the carrier and class are displayed on the Main screen.

1. Press the **Menu** key on the control center and select **Set Up**. Press the down arrow key and select **Scale/Rates**.
2. Select **Carrier/Class Disp.**
 - Select **Class Only** if you only want the class to display on the Main screen.
 - Select **Concatenate Carrier and Class** if you want the carrier and class to display on the main screen. |

NOTE: If you select this option the carrier and class name will be concatenated, or broken out onto multiple lines.

Scale/Rates: Class if New Piece

Use this option to set the system to clear the class for each piece of mail weighed or to keep the last class used.

1. Press the **Menu** key on the control center and select **Set Up**. Press the down arrow key and select **Scale/Rates**.
2. Select **Class if new Piece.**
 - To clear the class information select **Clear; set class to none.**
 - To retain the class information select **Retain; use previous class.**
3. The system returns to the Scale/Rates Set Up menu.

Scale/Rates: Destination if New Piece

Use this option to set the system to clear the destination ZIP or Zone code for each piece of mail weighed, or to keep the last class used.

Press the **Menu** key on the control center and select **Set Up**. Press the down arrow key and select **Scale/Rates**.

1. Select **Dest. if new Piece**.
 - To clear the destination select **Clear; set class to none**.
 - To retain the destination select **Retain; use class destination**.
2. The system returns to the Scale/Rates Set Up menu.

Scale/Rates: Destination if New Class

Use this option to set the system to clear the destination ZIP or Zone code each time you change the class of mail, or to keep the last destination ZIP or Zone code used.

1. Press the **Menu** key on the control center and select **Set Up**. Press the down arrow key and select **Scale/Rates**.
2. Select **Dest. if new Class**.
 - To clear the destination select **Clear; set destination to none**.
 - To retain the destination select **Retain; use previous destination**.
3. The system returns to the Scale/Rates Set Up menu.

Scale/Rates: Autoclear Destination Value

Use this option to set the system to automatically clear the destination value, so that the destination value is blank each time you are prompted to enter a destination or to automatically retain the destination value.

1. Press the **Menu** key on the control center and select **Set Up**. Press the down arrow key and select **Scale/Rates**.
2. Select **Autoclear Dest. Value**.
 - To clear the destination select **Yes: Clear Destination Value**.
 - To retain the destination select **No: Retain Last Destination**.
3. The system returns to the Scale/Rates Set Up menu.

Scale/Rates: ZIP/Zone Prompt

This feature may be offered as a standard or optional feature and is not available on all Pitney Bowes solutions. Please contact your local account representative to determine if this option is accessible on your system.

If the class and weight of your mail requires you to provide a destination ZIP or Zone code, select this option to enter a ZIP or Zone code.

1. Press the **Menu** key on the control center and select **Set Up**. Press the down arrow key and select **Scale/Rates**.
2. Select **ZIP/Zone Prompt**.
3. If you prefer to enter ZIP codes all the time when you are running mail, select **ZIP Code**.
If you prefer to enter Zones all the time when you are running mail, select **Zone**.
4. If you use both ZIP and Zones when running mail, select **Prompt**.

**Scale/Rates:
BMC Intra ZIP**

Use this option to edit a group of predefined zip code ranges, or create a new group of ZIP Codes, within a Bulk Mailing Center (BMC).

1. Press the **Menu** key on the control center and select **Set Up**. Press the down arrow key and select **Scale/Rates**.
2. Select **BMC Intra ZIP**.
3. To create a new group, select **Create new group** and enter the new beginning and ending ZIP Code. You only need to enter the first three digits of the beginning and ending ZIP Code.
4. To edit an existing group press the corresponding screen key for that group. You are prompted to enter a new beginning and ending ZIP Code. You only need to enter the first three digits of the beginning and ending ZIP Code.

**Scale/Rates:
Add ZIPs to
Zone 0**

This feature may be offered as a standard or optional feature and is not available on all Pitney Bowes solutions. Please contact your local account representative to determine if this option is accessible on your system.

Use this option to take advantage of local zone rates for one or more ZIP codes. When you select this option, you can add a new ZIP Code to the zone 0 rate, delete all ZIP Codes from the zone 0 rate, or edit an existing ZIP Code in the zone 0 rate.

1. Press the **Menu** key on the control center and select **Set Up**. Press the down arrow key and select **Scale/Rates**.
2. Select **Add ZIPs to Zone 0**.
3. Select the option you want.
4. To add a new ZIP or edit an existing one, use the numeric keys to enter all 5 digits of the new or edited ZIP Code.
5. Press **Enter** when complete.

**Scale/Rates:
Discount Code**

This feature may be offered as a standard or optional feature and is not available on all Pitney Bowes solutions. Please contact your local account representative to determine if this option is accessible on your system.

This is for international use. Use this option to apply discounts and/or surcharges to a different carriers and classes.

1. Press the **Menu** key on the control center and select **Set Up**. Press the down arrow key and select **Scale/Rates**.
2. Select **Discount Code**.
3. Select **Create new** to create a new discount code or select one of the displayed carrier names to edit an existing discount code.
4. Define or edit the carrier, class, sub and subclass, and whether you are applying a discount or surcharge at a percentage or flat rate.
5. Follow the system prompts.

**Scale/Rates:
Confirm Svc
Barcode Prompt**

This feature may be offered as a standard or optional feature and is not available on all Pitney Bowes solutions. Please contact your local account representative to determine if this option is accessible on your system.

When using USPS Confirmation Services, you can turn this option on to have the system display the following prompt when it is time to apply a barcode: *“Apply barcode label to package”*

1. Press the **Menu** key on the control center and select **Set Up**. Press the down arrow key and select **Scale/Rates**.
2. Select **Confirm Svc Barcode Prompt** to toggle between on and off.
3. Press **Clear** or the left arrow to exit.

**Scale/Rates:
Smart Classes**

The Smart Class™ capability of the DM Series™ mailing system software has been enhanced to provide fully automatic printing of postal inscriptions or postal endorsements. With the Smart Class™ feature, you are able to set the WOW® (Weigh-On-The-Way®) in an automatic mode to allow changes in Class based on the weight of the mail-piece. (Example: Automatically switch between Presort Classes depending on the weight of mail-pieces.) Now, the system can also automatically switch between Postal Inscriptions (i.e. PRESORT) or Postal Endorsement (i.e. MEDIA MAIL, ADDRESS SERVICE REQUESTED) that you choose for each weight break.

Two steps are required to use this feature. First, you must select an advertisement and/or inscription while setting up the Smart Class™ template. Second, you must turn “on” the printing capability of printing Auto Inscriptions. See *Setting Up a Smart Class™ with an Auto Inscription* in this section for more information.

Creating a Smart Class™ with an Auto Inscription

The following example shows how to set 3 different weight breaks. The weight breaks will use the following three classes.

For weight break:	Use Class:
0.0 oz to 3.0 oz	1st Class Automation Letter 5 Digit
3.0 oz to 13.0 oz	1st Class Non-Automation Presort
13.0 oz to 1.0 lb	Priority

1. Press the **Menu** key.
2. Select **Set Up**, then press the down arrow and select **Scales/Rates**.
3. Press the down arrow (depending on your system you may have to press it twice) and select **Smart Classes**.
4. Select **Create**.
5. Select the appropriate Carrier, in this example, **USPS Domestic**.
 - a. You are prompted to enter the maximum weight for this weight break:

Enter the max weight for this weight break				
0 lb	0.0 oz	to	__lb	__oz

- b. To set the first weight break, use the numeric keys and enter 0 for lb. Press the **Enter** key. Enter 3 for oz and press the **Enter** key.
- c. Select the appropriate class, in this example, **1st Class Auto**.
- d. Select the appropriate subclass. In this example, select **Letter**, then select **5-Digit**.
- e. The Fees screen appears. Press **Enter**.
- f. The Select Auto Ad/Inscriptions screen appears:
 - To add an ad, select **Ads/Messages**. Scroll through the list and select the appropriate option.
 - To add an inscription, select **Inscriptions**. Scroll through the list and select the appropriate option.
 - Press **Enter** when done. The display shows the first weight break for this Smart Class™:

Weight					Class/+Fees
0 lb	0.0 oz	—	0 lb	3.0 oz	1stAuto...r 5 Dig

- 6. To set the next weight break point, select **Add Another Class**.
 - a. You are prompted to enter the maximum weight for this weight break:

Enter the max weight for this weight break				
0 lb	3.0 oz	to	__lb	__oz

- b. For the second weight break, enter **0** for lb. Press the **Enter** key.
- c. Enter 13 for oz and press the **Enter** key. Select the appropriate class, in this example, **1st Cls Presort**.
- d. The Fees screen appears. Press **Enter**.
- e. The Select Auto Ad/Inscriptions screen appears:
 - To add an ad, select **Ads/Messages**. Scroll through the list and select the appropriate option.
 - To add an inscription, select **Inscriptions**. Scroll through the list and select the appropriate option.
 - Press **Enter** when done. The display shows the first weight break for this Smart Class™.

Weight					Class/+Fees
0 lb	0.0 oz	—	0 lb	3.0 oz	1stAuto...r 5 Dig
0 lb	3.0 oz	—	0 lb	13.0 oz	1st Cls Presort

- 7. To set the next weight break point, select **Add Another Class**.
 - a. You are prompted to enter the maximum weight for this weight break:

Enter the max weight for this weight break				
0 lb	13.0 oz	to	__lb	__oz

- b. For the third weight break, enter 1 for lb. Press the **Enter** key.
- c. Enter 0 for oz and press the **Enter** key.
- d. Select the appropriate class, in this example **Priority Mail**. The Fees screen appears. Press **Enter**.

- e. The Select Auto Ad/Inscriptions screen appears:
 - To add an ad, select **Ads/Messages**. Scroll through the list and select the appropriate option.
 - To add an inscription, select **Inscriptions**. Scroll through the list and select the appropriate option.
 - Press **Enter** when done. The display shows the first weight break for this Smart Class™. Since we did not create a fourth weight break it is listed as None.

Weight					Class/+Fees
0 lb	0.0 oz	—	0 lb	3.0 oz	1stAuto...r 5 Dig
0 lb	3.0 oz	—	0 lb	13.0 oz	1st Cls Presort
0 lb	13.0 oz	—	1 lb	0.0 oz	Priority Mail
0 lb	0.0 oz	—	0 lb	0.0 oz	None

8. Press the **Enter** key again and "Select Custom Carrier" appears in the display. You are presented with a list of available custom carriers for grouping your Smart Classes.
9. Select one that is listed as "Available". You can have up to a maximum of 4 custom carriers.
10. Next, you are prompted to enter a "Carrier Name". Enter a name (up to 15 letters and/or numbers) for your Smart Class grouping, for example, *Carrier 1*. Press the **Enter** key.
11. You are now prompted to enter the "Smart Class™ Name". This will be the class name for the Smart Class™ you have created. Enter the name (up to 15 letters and/or numbers), for example, *Smart Class 1*, and press the **Enter** key.
12. To exit, press the left arrow key. The main display appears. You can now begin to use this Smart Class™.

To use a Smart Class™, refer to "Selecting a Smart Class™" in Chapter 4 of the operator guide for your mailing system.

Setting Up a Smart Class™ with an Auto Inscription

1. Press the **Menu** key.
2. Select **Set Up** and press the down arrow key.
3. Select **Auto Ad/Inscription Setup** to toggle printing:
 - "On" means the ad and/or inscription will print when a Smart Class™ is used.
 - "Off" means the ad and/or inscription will not print when a Smart Class™ is used.
4. Follow the prompts to save your changes.

Modifying a Smart Class™ with an Auto Inscription

1. Press the **Menu** key.
2. Select **Set Up**, then press the down arrow and select **Scales/Rates**.
3. Press the down arrow (depending on your system you may have to press it twice) and select **Smart Classes**.
4. Select **View**.
5. Select the Smart Class™ you wish to edit.
6. Select **View Detail**.
7. Select **Modify Auto Ad/Inscription**.
8. The Select Auto Ad/Inscriptions screen appears:
 - To add an ad, select **Ads/Messages**. Scroll through the menu screens and select the appropriate option.
 - To add an inscription, select **Inscriptions**. Scroll through the menu screens and select the appropriate option.
9. Press **Enter** when done.

Scale/Rates: Auto Rate Large Envelope

Use this option to automatically post large envelopes using the Flat category when using Shape Based Rating.

1. Press the **Menu** key.
2. Select **Set Up**, then press the down arrow and select **Scales/Rates**.
3. Press the down arrow (depending on your system you may have to press it twice) and select **Auto Rate Large Env**.
 - If you want to post large envelopes using the Flat category, select **Yes, Post as Flat**.
 - If you do not want to post large envelopes using the Flat category, select **No, Display Error**.
4. The system returns to the Scale/Rates Set Up menu.

7 Setting Up Postage By Phone® Meter Payment System

This section describes how to set up Postage By Phone® Meter Payment System on your mailing system. It also includes advanced phone setup instructions for modifying individual phone connection parameters (user ID and password and server IP address).

To access the Postage By Phone® System setup options, press the **Menu** key on the IntelliLink® Control Center, select **Set Up** from the main screen, and then select **Phone/Network Set Up**.

All of the possible options are listed on the menu at the right.

Phone/Network Set Up

- ▶ PBP Account #
- ▶ Dialing Prefix
- ▶ PB Phone #
- ▶ Secondary PB #
- ▶ My Phone #
- ▶ Modem Type
- ▶ LAN Firewall Settings
- ▶ Network Settings
- ▶ Remote PC Refill

Phone/Network Set Up: PBP Account

Your Pitney Bowes representative uses this to set up your Postage By Phone® Meter Payment System account when installing your mailing system. Your account number is supplied by Pitney Bowes when you order your system.

Do not change this unless you are directed to do so by Pitney Bowes.

Phone/Network Set Up: Dialing Prefix

If you need to dial a number in order to reach an outside line, use this option to enter that prefix number.

1. Press the **Menu** key on the control center. Select **Set Up** from the main screen, then select **Phone/Network Set Up**.
2. Select **Dialing Prefix**.
3. Use the numeric keypad to enter the number you need to dial to reach an outside line, for example, 9.
To enter a symbol hold down the **Symbol** key and at the same time press the key for the symbol (for example, the # or * keys).
4. Press the **Enter** key.

Phone/Network Set Up: PB Phone

Use this option to enter the Pitney Bowes phone number that you use to add postage to your postage meter.

1. Press the **Menu** key on the control center. Select **Set Up** from the main screen, then select **Phone/Network Set Up**.
2. Select **PB Phone #**. This number is supplied by your Pitney Bowes representative.
3. Use the numeric keypad to enter the phone number you need to dial to connect to Pitney Bowes to add postage, or select **Reset to Factory Phone Number** to change back to the number present when the system was delivered.
4. Press the **Enter** key.

**Phone/Network
Set Up:
Secondary PB #**

This feature may be offered as a standard or optional feature and is not available on all Pitney Bowes solutions. Please contact your local account representative to determine if this option is accessible on your system.

Use this option to enter a secondary or alternative Pitney Bowes phone number to dial if the first or primary number is busy.

1. Press the **Menu** key on the control center. Select **Set Up** from the main screen, then select **Phone/Network Set Up**.
2. Select **Secondary PB #**. *This number is supplied by your Pitney Bowes representative.*
3. Use the numeric keypad to enter the phone number you need to dial to perform add postage.
4. Press the **Enter** key.

**Phone/Network
Set Up: My
Phone #**

Use this option to enter your local phone number (the number to which your mailing system is connected).

1. Press the **Menu** key on the control center. Select **Set Up** from the main screen, then select **Phone/Network Set Up**.
2. Select **My Phone #**.
3. Use the numeric keypad to enter your local phone number. Be sure and include the area code with your number. Also, use only digits and do not include spaces or dashes.
4. Press the **Enter** key.

**Phone/Network
Set Up: Modem
Type**

Use this option to select the modem type: USB, Serial, or Internal.

1. Press the **Menu** key on the control center. Select **Set Up** from the main screen, then select **Phone/Network Set Up**.
2. Select **Modem Type** and the "Select Modem Type" screen appears.
3. Select the appropriate modem type (USB, Serial, or Internal). The Phone/Network Set Up screen reappears.
4. In order for this change to take effect you must restart your system. Use the On/Off switch located on the base of your machine to restart your system (see *Mailing System Exterior* section in *Chapter 2* of this guide for the location of the On/Off switch).

Phone/Network Set Up: Use LAN Firewall Settings

This option allows you to modify individual LAN firewall settings.

1. Press the **Menu** key on the control center. Select **Set Up** from the main screen, then select **Phone/Network Set Up**.
2. Select **LAN Firewall Settings**. The "LAN Firewall Settings" screen appears and displays the following options:
 - Ping
 - Trust
 - Default Settings
3. Select **Ping** to toggle between Enable/Disable.
4. Select **Trust**. The "LAN Firewall Trusted Host Settings" screen appears. and displays the following options:
 - Trust All
 - Trust None
 - Trust Hosts OnlySelect the appropriate option.
5. Select **Default Settings** to revert to the default LAN firewall settings for the system.

Phone/Network Set Up: Network Settings

This option allows you to modify individual phone connection parameters.



CAUTION: Changing these parameters may result in errors when trying to contact Pitney Bowes. Contact your Pitney Bowes representative or call the Help Desk if you are not sure. Refer to the *Pitney Bowes Contact Information List* at the front of this guide for the phone number.

1. Press the **Menu** key on the control center. Select **Set Up** from the main screen, then select **Phone/Network Set Up**.
2. Select **Network Settings**. The "Network Set Up" screen appears and displays the following options:
 - Distributor Parameters
 - Mailing System Network Settings
3. If you select **Distributor Parameters**, the system displays the following connection parameters:
 - Global Account & User Id
 - Global Password
 - ANI/LCZ Server IP
 - ANI/LCZ Server Port #
 - Primary DNS Server
 - Secondary DNS Server
 - Distributor URL
 - Backup Data Center URL
4. If you select **Mailing System Network Settings**, the system displays the following options.
 - Get IP Address
 - IP Address
 - Subnet Mask
 - Default Gateway
 - MAC Address (you cannot modify this)
5. Select the parameter you want to edit and make the changes.
6. Press **Enter** when complete.

Phone/Network Set Up: Remote PC Refill

This option is available only on systems that have the optional Remote Refill feature installed.

Use this option to turn the Remote PC Refill feature on or off.

NOTE: Once you select this option, the system will restart.

1. Press the **Menu** key on the control center. Select **Set Up** from the main screen, then select **Phone/Network Set Up**.
2. If necessary, press the down arrow key and select **Remote PC Refill** to toggle this option on or off.

The mailing system must restart in order for the change to take effect. The system will restart automatically; however, you can select **OK, restart now** to expedite the process.

8 **Configuring High/Low Funds Warning**

Setting the Low Funds Warning Value

Use this option to set a value at which the mailing system warns you that the funds remaining in the meter are getting low.

1. Press the **Menu** key on the control center, select **Set Up** from the main screen, and then select **Basic Settings**.
2. Select **Low Funds Warning**.
3. Enter the low value warning amount using the numeric keyboard.
4. Press the **Enter** key.

Setting the High Value Warning for Key In Postage

Use this option to set a value at which the mailing system warns you that you have entered a postage value that is more than the amount you are setting here. This feature prevents you from accidentally printing a postage amount that is more than you need.

1. Press the **Menu** key on the control center, select **Set Up** from the main screen, and then select **Basic Settings**.
2. Select **High Value Warning**.
3. Enter the high value warning amount (\$0 - \$99.99) using the numeric keypad.
4. Press the **Enter** key.
5. Confirm that the high value warning amount that appears in the displayed is correct. Press the key corresponding to the option you want.

9 **Configuring Low Ink Warning**

Use this option to specify how you want the system to notify you when you are running low on ink.

1st Low Ink Warning

1. Press the **Menu** key on the control center, and select **Set Up**.
2. Select **Basic Settings**.
3. Press the down arrow key and select **1st Low Ink Warning**.
4. Press the screen key corresponding to the option you want. You can choose to have the system notify you when there is less than a 5-day supply of ink, or you can choose to ignore the warning.

2nd Low Ink Warning

Repeat the above for 1.5 day notification.

10 Configuring System Timeouts

This section describes how to set various system timeouts for your mailing system.

1. To access the system timeouts, press the **Menu** key on the control center, and select **Set Up**.
2. Select **Basic Settings** and then **Timeouts** to get all of the timeout options.

The timeout options are listed on the right. All of these options are described in the following sections.

Timeouts
▶ Display Sleep
▶ System Sleep
▶ Normal Preset Timer
▶ Feeding Timeout
▶ Waiting for Env
▶ Transaction Timeout

Standby Mode: Least Power Usage

In order to reach the lowest level of power consumption, the mailing system can be manually switched "Off" while still plugged into the wall. Toggle the "On/Off" switch to "Off" when not using the mailing system for an extended period of time. When switched back "On" expect some delay for a normal reboot to assure that the entire system is ready to go.

Timeouts: Display Sleep

This option allows you to specify how long the system can remain inactive before the display turns off. You can set the timeout for 1 - 30 minutes, in 1 minute increments. The default timeout is 5 minutes.

The display turns on again when you press any key on the control center or if you place mail in the feeder or on the scale (either integrated or attached external scale).

1. Press the **Menu** key and select **Set Up**.
2. Select **Basic Settings** and then **Timeouts**.
3. Select **Display Sleep**.
4. Enter the number of minutes (1-30) using the numeric keyboard.
5. Press the **Enter** key.

Timeouts: System Sleep

Use this option to specify how long the system remains inactive before it goes into "sleep".

You can set this timeout for 40 - 240 minutes, in 1 minute increments. The default timeout is 10 minutes.

The system goes into display sleep before it goes into system sleep. The system wakes up again when you press any key on the control center or if you place mail in the feeder or on the scale (either integrated or attached external scale).

1. Press the **Menu** key and select **Set Up**.
2. Select **Basic Settings** and then **Timeouts**.
3. Select **System Sleep**.
4. Enter the number of minutes (40 - 240 minutes) using the numeric keypad.
5. Press the **Enter** key.

**Timeouts:
Normal Preset
Timer**

The normal preset timer option allows you to specify how much time you want to allow the system to remain idle before it returns to the Normal Preset settings (refer to *Define Preset* section in this chapter for more information on Normal Presets).

You can set this timeout for 0 - 1440 minutes, in 1 minute increments. The default timeout is 30 minutes.

1. Press the **Menu** key and select **Set Up**.
2. Select **Basic Settings** and then **Timeouts**.
3. Select **Normal Preset Timer**.
4. To set the timer, enter the number of minutes (0-1440) using the numeric keyboard.
5. If you want the system to stay at the last settings used, select **Never reset to Normal Preset**.
6. Press the **Enter** key.

**Timeouts:
Feeding Timeout**

Use this option to specify how much time to allow before the feeder stops after the last envelope is processed.

You can set this timeout for 5 - 90 seconds, in 1 second increments. The default timeout is 5 seconds.

This reduces the wear on your machine and acts as a safety measure if you leave the machine unattended.

1. Press the **Menu** key and select **Set Up**.
2. Select **Basic Settings** and then **Timeouts**.
3. Select **Feeding Timeout**.
4. Enter the number of seconds (0 - 90) using the numeric keyboard, or press the screen key corresponding to **Turn Rollers off Immediately, or Run Until Stop key is Pressed**.
5. If you entered the number of seconds, press the **Enter** key.

**Timeouts:
Waiting for Env**

This option allows you to specify how long the system will continue to feed mail placed on the feed deck without having to press the **Start** key.

You can set this timeout for 0 - 90 seconds, in 1 second increments. The default timeout is 20 seconds.

1. Press the **Menu** key and select **Set Up**.
2. Select **Basic Settings** and then **Timeouts**.
3. Select **Waiting for Env**.
4. Enter the number of seconds (0 - 90) using the numeric keyboard.
5. Press the **Enter** key.

Timeouts: Transaction Timeout

This option is available only if your mailing machine is connected to the AccuTrac™ Mail Accounting system.

Use this option if you routinely batch your mail runs. This option allows you to specify how much time to allow the system to remain idle before it ends the current accounting transaction. You can set this timeout for 10 - 65520, in 1 second increments. The default timeout is 14,400 seconds.

1. Press the **Menu** key and select **Set Up**.
2. Select **Basic Settings** and then **Timeouts**.
3. Select **Transaction Timer**.
4. Enter the number of seconds (10 - 65520) using the numeric keyboard.
5. Press the **Enter** key.

11 Defining Presets

You can define up to 50 sets (0- 49) of preset mailing system values, with each set having different values for such items as the account name, postage value, class, carrier, a special service, a mode such as **Attached Scale** or **Differential weighing**, and the like. You can use these presets for different mailing jobs.

The 0 preset is the normal preset and the one you use to store your most commonly used system values. These are the values your system will use whenever you restart your machine.

NOTE: If this is a newly purchased DM Series™ mailing system, the normal preset will be set to First Class, 1 oz mail.

After you define all of your presets, you can invoke the normal preset values simply by pressing the **Normal Preset** key. To select any of the other presets, press the **Custom Preset** key and select the preset you want for the particular mailing operation.

Defining Normal Preset Values

When defining the normal preset values, the mailing system will prompt you to select a class of mail if you are using Key In Postage mode. Selecting a class will ensure your preset values are updated automatically when postage rates change.

NOTE: You can elect to save the normal preset without a selecting a class, but your preset values will not update automatically when postage rates change.

1. Enter the values you use most often to run a mail job, for example, the weighing mode, the postage value, class and carrier etc.

NOTE: Proceed as if you were actually running a job. Select the mode and class and service etc. By doing this, you are entering the values that you will use for the normal preset. Refer to *Chapter 4, Running Mail* in this guide for more information on selecting mode and class.

2. Press the **Custom Presets** key.
3. A list of presets, starting with "0 Normal" appears. Do not press any of the screen keys corresponding to these presets.
4. Press the right arrow key (**Set up Presets** appears next to the right arrow key).
5. Press the screen key for **Store Current Setting to Preset**.

If you selected the Key in Postage mode, the system prompts you to choose a class for the preset. Choosing a class ensures that your preset values are automatically updated when the postage rates change.

- To choose a class, press the **Select Class** screen key and follow the prompts to select weighing and class options. Once you make the selections, the system returns to the Main screen. Return to step 2 to set the normal preset.
 - To continue without selecting a class, press the down arrow.
6. Select the normal preset by pressing the key for **0. Normal**. The "View Preset" screen appears and displays all of the values you defined in this session.
After a certain period of inactivity, or when you power up, the system restores the normal preset settings.
 7. Press the **Enter** key to return to the main screen.

Defining Custom Preset Values

When creating a custom preset, the mailing system will prompt you to select a class of mail if you are using Key In Postage mode. Selecting a class will ensure your preset values are updated automatically when postage rates change.

NOTE: You can elect to save the custom preset without selecting a class, but your preset values will not update automatically when postage rates change.

1. Enter the values for the mail job (for example, the weighing mode, the postage value, class and carrier etc.) that correspond to the values you want to be able to call up in the future by selecting a custom preset key. For example, you may want to define a set of conditions so that the envelopes are sealed only (no postage applied).

NOTE: Proceed as if you were actually running a job. Select the mode and class and service etc. By doing this, you are entering the values that you will use for the normal preset. Refer to *Chapter 4, Running Mail* in this guide for more information on selecting mode and class.

2. Press the **Custom Presets** key.
3. Press the right arrow key.
4. Select **Store Current Setting to Preset**.
5. A list of presets, starting with "0 Normal" appears. Select one of the presets that has not been defined yet. These presets are named "Available". To change an existing preset, refer to "Editing Custom Preset Values" in this section.

If you selected the Key in Postage mode, the system prompts you to choose a class for the preset. Choosing a class ensures that your preset values are automatically updated when the postage rates change.

- To choose a class, press the **Select Class** screen key and follow the prompts to select weighing and class options. Once you make the selections, the system returns to the Main screen. Return to step 2 to set the custom preset.
 - To continue without selecting a class, press the down arrow.
6. The system prompts you to "Enter New Preset Name". Type in the name using the alphanumeric keys.
 7. Press the **Enter** key. The "View Preset" screen appears and displays all of the values you defined in this session.
 8. To use these values in the future, simply press the **Custom Presets** Key and select the screen key corresponding to this preset name.
 9. Press the **Enter** key to return to the main screen.

Store Advance Date in a Custom Preset

This feature may be offered as a standard or optional feature and is not available on all Pitney Bowes solutions. Please contact your local account representative to determine if this option is accessible on your system.

In order to store an Advance Date setting in a custom preset, you need to first turn on this feature. For information on setting an advance date, refer to *Meter Stamp Options: Date* section in *Chapter 4* in this guide.

To enable this feature:

1. Press the **Custom Presets** key.
2. Press the right arrow key and the "Set Up Preset" screen opens.
3. Select **Date Advance**. The following message appears: *"If set on, presets stored when the date is not advanced will return the system to today's date."*
 - Select **On** to turn on this feature and store the date advance.
 - Select **Off** if you want to turn off the feature.
4. Refer to the examples on the next page for more information on how storing the Advance Date in custom presets works.

NOTE: If you create a custom preset with the Advance Date feature turned off and you recall this preset, the current date setting is not affected.

Example 1 - If today is Wednesday and you set the advance date for 2 days* and store this advance in a custom preset, then:

- if you recall the preset on the same day (Wednesday) it will print Friday's date on your postage.
- if you recall the preset on the next day (Thursday) it will print Saturday's date on your postage.

* To set advance date, press the **Menu** button, select **Meter Stamp Options**, then select **Advance Date**.

Example 2 - If you have previously set up your system so that it automatically advances the date at 3 PM*, and you created a custom preset with the Advance Date set to zero (that is, you did not advance the date), then:

- if you recall the preset before 3 PM it will print today's date on your postage.
- if you recall the preset after 3 PM it will print tomorrow's date on your postage.

* To automatically advance the date (by 24 hours), press **Menu** button, select **Set Up**, press the down arrow key, then select **Date will advance after**.

Example 3 - If you have previously set up your system so that it automatically advances the date at 3 PM, and you create a custom preset that advances the date by 2 days, then:

- if you recall the preset before 3 PM, the system will set the date two days ahead.
- if you recall the preset after 3 PM, the system will still set the date two days ahead.

Editing Custom Preset Values

To edit an existing custom preset, you define its new values and then overwrite the old values.

1. Enter the new values for the mail job that correspond to the custom preset you want to change or edit.
2. Press the **Custom Presets** key.
3. Press the right arrow key (**Set up Presets** appears next to the right arrow key).
4. Press the screen key for **Store Current Setting to Preset**.
5. The system prompts you to “*Select Preset to Replace*”. Press the screen key next to the name of the preset you want to edit.
6. Press the **Enter** key to view the preset values. Press **Enter** again to return to the main screen.

Viewing, Renaming, or Deleting Presets

1. Press the **Custom Presets** key.
2. A list of presets, starting with *0 Normal* appears. Select the appropriate preset. 0 - 4 presets are displayed on the screen. To view the other preset names, press the down arrow key.
3. Press the right arrow key (**Set up Presets** appears next to the right arrow key).
4. The following options appear:
 - Store Current Setting to Preset
 - View Preset
 - Rename Preset
 - Delete Preset

Select the screen key corresponding to the option you want. Follow the screen prompts.

12 Creating Custom Messages

Custom Messaging enables you to enter text at the Control Center which can print directly on envelopes as they pass through the mailing system. Custom messages can be saved in the memory of the system, and recalled whenever appropriate to print. In the Control Center, this feature is shown as “Text Entries.”

IMPORTANT: You should be familiar with the USPS regulations and standards relating to custom message printing and envelope usage for guidance concerning appropriate content, format, and other usage considerations

Sample:

ACME Corporation
Finance Department
Bldg 3, Floor 4
201 Aberdeen Parkway
Charlotte NC 28255

Specifications

- Print up to five lines of information.
- Print a maximum of 20 characters per line (including spaces).
- Fixed font (Lucida Console, 10 Point).
- UPPER CASE and lower case available.
- Special characters available (as outlined on the keypad).
- Save up to five custom messages in memory.
- Custom messages can be saved in the Normal or Custom Presets.
- Uses full QWERTY keypad standard on all DM Series™ mailing systems.
- Custom messages always print to the left of the postage, and left of any advertisements and inscriptions.
- Operating speed is reduced slightly to accommodate printing operation.

The Custom Messaging capability of your DM Series™ mailing system has several applications. Use it for all outgoing mail that does not have a pre-printed custom message such as Business Reply Mail. Even if you use a pre-printed custom message on outgoing mail, this capability can be used to define a department or section of your organization for “return mail.” By implementing this as a process, undeliverable mail can bypass the Mail Center, and be returned directly to the department that generated the mailing.

IMPORTANT: Custom Messaging requires an envelope at least 6 3/4" long to print effectively. See *Envelope Guidance* in this section regarding testing of your envelopes before running.

Postal Rules and Guidance

IMPORTANT: Any custom message printed by the DM Series™ system must follow USPS guidelines as published in the *Domestic Mail Manual (DMM)*.

Creating a Custom Message for the First Time

1. Press the **Menu** key.
2. Select **Set Up**, then select **Text Entry Set Up**.
3. Select **Create**.
4. Select a line of text to enter. Type in the text and press **Enter**.
5. Repeat step 4 until all lines of text have been entered. You can enter up to five lines of text.
6. Press **Enter** when done. The Enter Text Entry Name screen appears.
7. Type in a name for the custom message and press **Enter**.
8. Press the left arrow key to return to the Main screen.

Adding Additional Custom Messages

The system can hold up to five custom messages at a time. To add additional custom messages to the system:

1. Press the **Menu** key.
2. Select **Meter Stamp Options**, then select **Text Entries**.
3. Follow steps 3 through 8 in *Creating a Custom Message*, above, to add and save the address information.

TIP: Print a sample piece of mail to see ensure the custom message prints as desired on the envelope.

Selecting/Deselecting a Custom Message

1. Press the **Menu** key.
2. Select **Meter Stamp Options**, then select **Text Entries**.
3. Select the custom message you want to print on the envelope.
If you do not wish to print a custom message at this time, select **Don't Print Text Entry**.
4. Press **Enter** when done.
5. Press the left arrow key to return to the Main screen.

Viewing a Custom Message

1. Press the **Menu** key.
2. Select **Meter Stamp Options**, then select **Text Entries**.
3. Press the right arrow key, then select **View**.
4. Select the appropriate custom message. The custom message appears on the screen.
5. Press **Enter** when done.
6. Press the left arrow key to return to the Main screen.

Editing a Custom Message

1. Press the **Menu** key.
2. Select **Meter Stamp Options**, then select **Text Entries**.
3. Press the right arrow key, then select **Edit**.
4. Select the appropriate custom message.
5. Select a line of text to edit.
 - a. Press **Clear** to clear the existing entry, or press the left arrow key.
 - b. Make any necessary changes to the text.
 - c. Press **Enter** when done.
6. Repeat step 5 until you have edited the appropriate lines of text.
7. Press **Enter**. The Edit Text Entry Name screen appears.
8. If necessary, edit the name of the custom message. Press **Enter** when done.
9. Press the left arrow key to return to the Main screen.

Deleting a Custom Message

1. Press the **Menu** key.
2. Select **Meter Stamp Option**, then select **Text Entries**.
3. Press the right arrow key, then select **Delete**.
4. Select a custom message to delete.
5. Select **Yes**. The custom message is deleted from the list.
6. Press the left arrow key to return to the Main screen.

Envelope Guidance

NOTE: Always run a test print (at \$0.00 postage) before using Custom Messaging to ensure proper placement on an envelope. Custom Messaging prints a custom message or other information directly to the left of your postage meter imprint and any Postal Endorsements or Inscriptions on the envelope. This message does not print on the left margin of the envelope, nor does your mailing system allow for placement of the custom message on your envelope. Therefore, before printing a mailrun using this feature, you should always process a Test Print with ZERO POSTAGE to ensure that the full message is properly positioned on the envelope.

Drop Shipment Endorsement

NOTE: In most cases, the Drop Shipment Authorization is printed using an Endorsement purchased from the Pitney Bowes Online Store. The Custom Messaging feature of the DM Series™ may satisfy USPS requirements for Drop Shipment endorsements on your mailings. However, the application and endorsement format must be authorized locally by the USPS. Under current Postal guidelines, the local business mail entry management of the USPS must approve the application or endorsement format for mail deposited as “Drop Shipment Authorization.” Contact the USPS directly for further guidance.

13 Taking the Meter Out of Service

Call your Pitney Bowes representative if you need to return the postage meter (contained in the IntelliLink® Control Center) to Pitney Bowes. When instructed, follow the procedure here.

1. Press the **Menu** key and select **Set Up**.
2. Select **Take Meter Out of Service**.
3. Select **Transfer Funds from Meter**.
This transfers the funds from your meter back to your account.
4. The system transfers the funds and displays the amount transferred.
7. To print this amount on an envelope, place an envelope on the feed deck and press the **Start** key. To print on a tape, simply press the **Tape** key.

14 Adding an Optional Printer

You can connect a Pitney Bowes USB printer to your mailing system. To add this optional external printer, all you need to do is plug the USB connector from the printer into one of the two upper-most USB connectors on the back of the mailing system base. Your mailing system recognizes the printer as soon as you plug it into the base.

The dual USB ports are located on the right back corner of the system base as shown here.



15 Configuring the Optional Barcode Scanner

If you have a barcode scanner attached to your mailing system, you can configure it to scan:

- account names,
- account codes (Business Manager only),
- speed codes (INVIEW™, Budget Manager only),
- Custom and Normal Presets,
- Job IDs, or
- ZIP Codes

if you are in the INVIEW™, Budget Manager or Business Manager accounting systems.

NOTE: You can use a barcode scanner to scan in barcodes for USPS Special Services regardless of the accounting system you are using. USPS Special Services do not require any set up operations here.

Refer to the appropriate topic in this section:

- If you are using an accounting system on your mailing system you can set the default scan type so that your system recognizes your particular accounting application when it scans the barcode. Refer to *Setting the Default Scan Type*.
- If you are attempting to scan barcodes that were defined for other accounting systems and those accounts contain a prefix, you can set up your system to recognize that prefix when it scans in the barcode. Refer to *Adding Barcode Prefixes*.
- If you need to combine multiple barcode scans into a single barcode, refer to *Combining Barcodes*.
- If you want your system to require an operator to press the **Enter** key to accept each barcode value after it is scanned and displayed on the IntelliLink® Control Center screen, refer to *Setting Auto-Enter*.

Setting the Default Scan Type

If you are using an accounting system on your mailing system you can set up the scanner so that it knows what field is scanning without using a prefix code. Your selection of Account Name or Account Code depends on your accounting system. You can then scan the account code or name directly from the Main screen on IntelliLink® Control Center display.

To set the default value:

1. Press the **Menu** key on the control center, then select **Set Up**.
2. Press the down arrow key and then select **Barcode Scanner**.
3. At the "Barcode Scanner Setup" menu, select **Default Scan Type**.
4. Select the appropriate option according to the table here:

If your accounting system is:	And the barcode contains:	Select this default scan type:
Business Manager	Account Name	Account Name
	Account Code	Account Code
	Preset	Preset
	Job ID 1	Job ID 1
	Job ID 2	Job ID 2
INVIEW™ or Budget Manager	Account Name	Account Name
	Account Code	Account Code
	Preset	Preset
	Job ID 1	Job ID 1
	Job ID 2	Job ID 2

5. If you do not want any default account system, or preset, or if you will be scanning multiple fields select **None**.
6. As soon as you make your selection, the "*Barcode Scanner Setup*" menu reappears. You can make other selections or press the left arrow key to return to the "*Set Up*" menu.

Adding Barcode Prefixes

If you are going to scan multiple fields, you will need to create barcodes that contain a 1 or 2 digit prefix. This prefix identifies the field you are scanning. You may use this if you are transferring accounts from a different accounting system like the Paragon®, or from a set of pre-printed barcode labels that have a prefix as part of the barcode. You can then scan these barcodes when the Main screen displays IntelliLink® Control Center.

To set the prefix value:

1. Press the **Menu** key on the control center, then select **Set Up**.
2. Press the down arrow key and then select **Barcode Scanner**.
3. At the "Barcode Scanner Setup" menu, select **Barcode Prefixes**.
4. Select the **Prefix Size** and then select 1 or 2 whichever is appropriate.
5. Select the appropriate barcode prefix option according to the table here:

If your accounting system is:	And the barcode contains:	Select this barcode prefix option:
Business Manager	a prefix and Account Name	Account Name Prefix
	a prefix and Account Code	Account Code Prefix
	a prefix and Job ID 1	Job ID 1 Prefix
	a prefix and Job ID 2	Job ID 2 Prefix
INVIEW™ or Budget Manager	a prefix and Account Name	Account Name Prefix
	a prefix and Speed Code	Speed Code Prefix
	a prefix and Job ID 1	Job ID 1 Prefix
	a prefix and Job ID 2	Job ID 2 Prefix

6. When you select the barcode prefix, the default value for that option appears on the screen. To enter a new value, press the **Clear** key to remove the default, then type in the prefix character(s).

NOTE: Barcode prefixes are case-sensitive.

7. Press the **Enter** key.
8. As soon as you make your selection, the "*Barcode Scanner Setup*" menu reappears. You can make other selections or press the left arrow key to return to the *Set Up* menu.

Combining Barcodes

If you need to combine multiple barcode scans into a single barcode, use this setup option. For example, the typical barcode scanner can only accept a maximum of 30 characters. If you want to scan an account name that contains more than 30 characters, say 50 characters, you add a "join character" at the end of the first 30 characters. These first 30 characters with the join character at the end, would be on the first line and the second 20 characters would be on the second line. When you scan these two barcode lines, the system will combine them into a single barcode account value.

To select the character to join multiple barcode scans:

1. Press the **Menu** key on the control center, then select **Set Up**.
2. Press the down arrow key and then select **Barcode Scanner**.
3. At the "Barcode Scanner Setup" menu, select **Concatenate Scans**.
4. A list of possible "join character" options is displayed. Select the character you use to combine the barcode values.
5. As soon as you make your selection, the "*Barcode Scanner Setup*" menu reappears. You can make other selections or press the left arrow key to return to the *Set Up* menu.

The following is an example using a + symbol as a join character.



When you scan in these three barcodes, the system will combine them into a single barcode value.

NOTE: When creating your own barcodes, create them in uppercase. If you create them in lowercase, the length of the barcode will be twice that of the same barcode created using uppercase text.

Setting Auto-Enter

You can set up your system so that after it scans in a barcode value and displays it on the IntelliLink® Control Center screen, it requires you to press the Enter key to accept that value. You can do this if you want to be sure that an operator verifies that the correct barcode has been scanned. By default, the system will automatically enter the value as soon as it scans in the barcode.

To require you to press Enter to accept each scan:

1. Press the **Menu** key on the control center, then select **Set Up**.
2. Press the down arrow key and then select **Barcode Scanner**.
3. At the "*Barcode Scanner Setup*" menu, select **Auto-enter**.
4. Select **Off** to disable the Auto-enter. This will now require you to manually press the **Enter** key after each scan.

6 • Adding Postage



- Postage By Phone® Meter Payment System 6-2*
- Your Postage Meter 6-2*
- USPS Rekey Requirements..... 6-3*
- Managing Your Postage Funds..... 6-4*
- Connecting Your Postage Meter to an Analog Phone Line..... 6-5*
- Checking Available Funds in Your Postage Meter 6-6*
- Checking Your Postage By Phone® Meter Payment System Account
Balance 6-6*
- Adding Postage..... 6-7*
- Postage Pass - Automated Postage Refill 6-7*

Postage By Phone® Meter Payment System

Postage By Phone® Meter Payment System is a Pitney Bowes service that you use to add postage to your meter. You can access the Postage By Phone® System 24 hours a day, 7 days a week through your IntelliLink® Control Center. For more information, refer to the Postage By Phone® System materials furnished with your system.

If you need assistance with Postage By Phone® System: If you need assistance, have your account number ready and call the Postage By Phone® System number. Refer to the *Pitney Bowes Contact Information List* at the front of this guide for the phone number.

Your Postage Meter

The postage meter on your mailing system is a Postal Security Device (PSD) that incorporates the latest technology approved by the United States Postal Service to secure funds. This technology eliminates the need to perform physical inspections thereby making the system easier and more convenient to use. The PSD contains the funds and performs all of the calculations necessary to print meter stamps that comply with the latest USPS standards.

The United States Postal Service (USPS) licenses your meter and requires a modem inspection of the meter. Periodically, your IntelliLink® Control Center will be required to connect to Postage By Phone® as a means of inspecting the PSD (Postal Security Device) and validating information in your Control Center.

To ensure that your operations are not interrupted, the time periods for the Data Center Connection are pre-established in your system, and will give adequate warning to you when this connection may be required:

- The message “*Data Center Contact Required*” will first be shown approximately 21 days after your last connection. The Control Center will allow you to either “*Connect Now*” or “*Later*.” By selecting “*Later*”, you enter a grace period that lasts approximately 7 days.
- The “*Data Center Contact Required*” message will appear each day for 7 days (when you power-up your system), and will only disappear after a successful connection. This may also appear on the main screen in reverse-type with the “*Connect to Data Center*” message.
- On the 28th day after your last successful connection, your Control Center will display a message, “*You will not be able to print postage until this process is completed.*” Please connect to the Postage By Phone® Data Center to continue your operations.
- Follow the prompts on your Control Center or perform a Balance Inquiry to make a successful connection. After a successful connection, your screen will indicate “*Data Center Contact Complete.*”

To improve overall productivity, Pitney Bowes recommends that you establish a “constant connection,” where a LAN connection or phone line is connected to your Control Center (direct or wireless), or you use an approved alternative connection. See the *Connection Alternatives – Review* section of this guide for more details.

Connection Alternatives - Review

You can connect your mailing system to the Pitney Bowes network using one of four methods:

- **Constant (High Speed) Connection** - using your organization's Local Area Network and approved connection device.
- **Direct Analog Connection** – requiring a direct, constant connection. (The phone line comes out of the wall, and plugs in directly to the back of the Control Center.)
- **Shared Analog Connection** - the phone line comes out of the wall, but may be used for a fax machine. The phone line is either detached from the fax machine and used for the Pitney Bowes connection, or a splitter is installed to facilitate a connection to this shared line.
- **Wireless Analog Connection** - using an approved wireless device. (A remote receiver is attached at the phone line coming out of the wall, and a transmitter is attached to the back of the Control Center. All data is transferred without a physical connection of the phone line.)

IMPORTANT: Please contact your Pitney Bowes account representative to determine which connection options are available to you.

USPS Rekey Requirements

The United States Postal Service (USPS) also requires, for security reasons, that the meter keys expire after 3-6 years. Meter keys are cryptographic codes that your system uses to protect your funds during printing and when connecting to your account.

When the meter keys expire, the system reports that a rekey operation is required.

To rekey your meter, perform a refill. This upgrades the keys. If you do not perform a refill within three months (90 days) of the rekey message, the system locks the meter and does not allow you to print postage.

You may still perform a refill to upgrade the keys and resume operation.

Managing Your Postage Funds

Refer to the appropriate section listed here for checking funds and account balances and adding postage when using the Postage By Phone® Meter Payment System.

- 1 Connecting Your Postage Meter to a Local Area Network (LAN)** - Refer to this section if you are using your organization's Local Area Network and an approved connection device. This is the recommended method.
- 2 Connecting Your Postage Meter to an Analog Phone Line.** If you do not have a LAN connection, refer to this section to see how to connect your postage meter to an analog line. This shows the recommended connections for when the analog line is close to your mailing system, and when you have to remove the IntelliLink® Control Center and take it to a remote location.
- 3 Checking Available Funds in Your Meter.** Follow this procedure to see if you have sufficient funds in your meter.
- 4 Checking Your Postage By Phone® System Account Balance.** Follow this procedure to see how many funds are in your account.
- 5 Adding the Postage.** Follow this procedure to add postage from your Postage By Phone® System account to your postage meter.
- 6 Postage Pass - Automated Postage Refill.** Follow this procedure to set up automatic postage refills on your postage meter.

1 Connecting Your Postage Meter to a LAN

Adding postage funds to your system is fast, easy, and convenient. Connect to the internet (and to Pitney Bowes) using your organization's Local Area Network (LAN).

NOTE: If a LAN connection is not available, you can connect via analog phone line. Refer to 2, *Connecting Your Postage Meter to an Analog Line Phone Line* in this chapter for more information.

Plug one end of the Ethernet cable (supplied) into the internet source and the other end into the USB adapter. Plug the USB adapter into one of the available USB ports on the back of your DM Series™ machine base as shown here.

USB network adapter plugs into the DM Series™ base USB connector

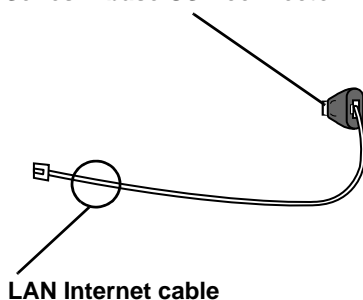

USB connectors on the DM Series™ base

Visit www.pb.com/constantconnection for more information.

2 Connecting Your Postage Meter to an Analog Phone Line

If you do not have access to a Local Area Network (LAN) connection, you can connect to the analog phone line connector on the back of the IntelliLink® Control Center.

NOTE: If you need to connect to an analog phone line that is not located near your IntelliLink Control Center, you can remove the control center and move it to a location near the analog line. Refer to *Connecting Your IntelliLink Control Center to a Remote Analog Phone Line* in this chapter for more information.

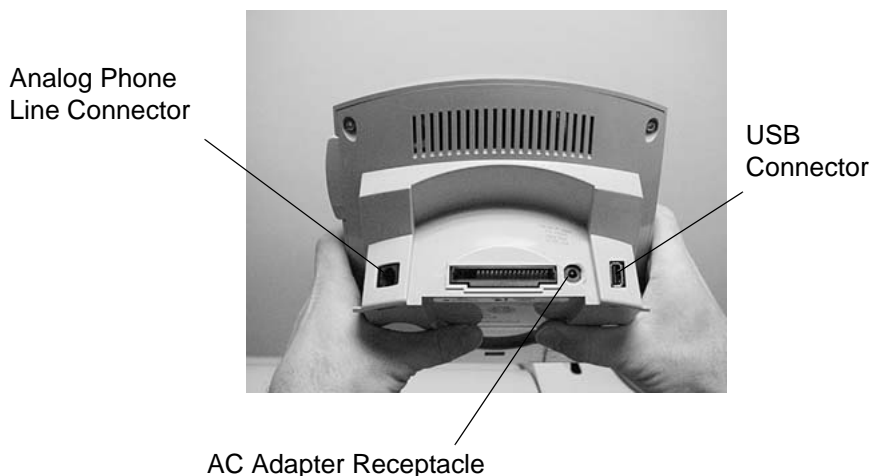

Connecting Your Control Center to a Remote Analog Line

In order to connect the control center to a remote analog line, you need an A/C Adapter (P/N 1C85005).

To remove the control center and move it to another location:

1. Turn off the power to the mailing system.
2. Pull the blue lever at the right of the control center towards you.
3. Slide the control center forward to remove it.
4. Take the control center (and external modem) to where the analog phone line is.
5. Connect the telephone cord (AWG 26) from the analog phone line connector to the analog telephone line.
6. Connect the A/C Adapter (P/N 1C85005) to the back of the control center and plug it into an AC outlet.
7. Add or check your postage funds as described in *Checking Your Postage By Phone® Meter Payment System Account Balance* in this chapter.
8. Reinstall the IntelliLink® Control Center by sliding it into the docking station on top of the mailing system until you hear it click into place.
9. Turn the power back on.



3 Checking Available Funds in Your Postage Meter

If you are not sure if you have enough money to run mail or print tapes, you should check the amount of money (funds) in your postage meter.

To check available funds in your meter:

1. Press the **Funds** key. The amount of funds available in your postage meter displays at the top of the screen.
2. To print a funds report on an envelope, place an envelope on the feed deck and press the **Start** key. To print on a tape, simply press the **Tape** key.

The system returns to the mailing screen.

If you do not have enough postage funds in your meter, check your Postage By Phone® Meter Payment System account balance (see *Checking Your Postage By Phone® Meter Payment System Account Balance* in this chapter). If there are enough funds in your account, move funds to your postage meter (see *Adding Postage* in this chapter).

4 Checking Your Postage By Phone® Meter Payment System Account Balance

Before adding postage to your meter, you should check the funds available through the Postage By Phone® System. Remember, with your new mailing system it is no longer necessary to prepay for postage. Your mailing system is designed to save you time and make adding postage to your meter even more convenient. Although you can still prepay, you can take advantage of the full meter capabilities and add postage now and be billed later. Please allow up to seven days for your check to post if you plan to add postage to your meter using pre-paid funds.

To check your account balance:

1. Press the **Funds** key.
2. Select **Get Postage by Phone® Balance**. The system dials Pitney Bowes to connect to your account. When the connection is made, the system displays your Postage By Phone® System balance.
3. Select **Done** to return to the main screen.

5 Adding Postage

To add postage from your Postage By Phone® System account to your postage meter, follow these steps.

1. Press the **Funds** key.
2. Select **Quick Refill**, or **Other Refill Amount**.
3. If you have set up a supervisor password, you are prompted to enter the password now.
Enter the password and press the **Enter** key.
4. If you select **Quick Refill**, the system adds the same amount it did the last time you added postage.
5. If you select **Other Refill Amount**, use the number keys and enter in the amount you want to add (up to \$1000). Use whole dollars only; do not key in cents. Your meter automatically adds two decimal places.
6. Press the **Enter** key. The system dials Pitney Bowes to connect to your account and begins to add the postage to your meter.
7. The system notifies you when it finishes adding your postage and displays the message "Refill Complete". The system prompts you to download an available update or:
 - **Press Tape to Print Tape**
 - **Press Start to Print an Envelope**
 - **Don't Print Receipt**
8. Select the appropriate option.

NOTE: To view or print a statement showing the details of the last five times you added postage to your meter, press the **Reports** key on the control center and select **Last 5 Refills**. Refer to *Chapter 8, Reports* in this guide for details of all system reports.

6 Postage Pass - Automated Postage Refill

With this feature, you determine the amount of postage you want transferred to your meter during each refill and you choose the dollar amount at which you want a refill to occur. When the postage balance in the meter drops to the amount you've set as the low funds value, the meter automatically downloads the amount you preset. Your meter is always ready for use.

IMPORTANT: This feature requires a constant connection via one of three methods:

- direct analog phone line,
 - wireless connection using an analog device (see below), or
 - LAN connection using an approved Ethernet device.
-

When this feature is enabled, your system will automatically initiate contact with Pitney Bowes to refill your meter according to the values you establish in the system. Your mailing system will only initiate a refill when the system powers down (Sleep Mode), wakes up (if it was turned off), or if your postage meter runs low on funds. Your system will not initiate a refill during a transaction, or in-between transactions. This ensures that your normal operations will not be interrupted.

When your system automatically connects, it will also check to see if any other tasks are necessary during the same connection. This includes uploads of tracking records, electronic postal inspection, or other functions performed during the refill. If an update is required, you will be prompted to do so at that time.

Recommended Funds Values

When the Postage Pass - Automated Postage Refill capability is enabled, your mailing system will make recommendations for both Auto Refill Amounts and the Low Funds Warning.

- The *Auto Refill Amount* is the dollar value of the reset when you refill for postage.

Recommended	Minimum	Default
\$2000 - \$8000	\$1000	\$5000

- The *Low Funds Value* is the dollar amount that becomes the trigger for the Auto Refill. When your postage meter reaches this level, the Auto Refill capability will be initiated (the next time your system powers down.)

Recommended	Minimum	Default
\$1000 - \$4000	\$ 50	\$2500

Setting the Auto Refill Amount

1. Press the **Menu** key.
2. Select **Set Up** then select **Basic Settings**. The Basic Settings screen appears.
3. Scroll down and select **Auto Refill Amount**.
4. Press the **Clear** key and then enter your desired refill amount.
5. Press **Enter** when done.

Setting the Low Funds Value

1. Press the **Menu** key.
2. Select **Set Up** then select **Basic Settings**. The Basic Settings screen appears.
3. Scroll down and select **Low Funds Value**.
4. Press the **Clear** key and then enter the amount you want to activate the automatic refill.
5. Press **Enter** when done.

Enabling/Disabling Automated Postage Refill

To disable or enable the automated postage refill feature:

1. Press the **Menu** key.
2. Select **Basic Settings**.
3. Press the down arrow key and select **Automatic Refill**.
 - Select **On, enable automatic refill** to enable the automatic refill. A connectivity alert message will appear indicating that the meter must be physically connected through a phone line or LAN. Select **OK** to continue.
 - Select **Off** to disable the automatic refill.

7 • INVIEW™ Accounting



Contents

<i>Navigating Hints</i>	<i>7-2</i>
<i>Overview of Accounting</i>	<i>7-3</i>
<i>Before You Begin</i>	<i>7-3</i>
<i>Using the INVIEW™ Accounting Setup Procedures</i>	<i>7-4</i>
<i>Setting Up the Mailing System for INVIEW™ Accounting</i>	<i>7-4</i>
<i>Setting Up Operators</i>	<i>7-10</i>
<i>Working with INVIEW™ Accounts.....</i>	<i>7-13</i>
<i>Running Mail</i>	<i>7-16</i>
<i>Transaction Options</i>	<i>7-18</i>
<i>INVIEW™ Accounting Reports.....</i>	<i>7-23</i>

Navigating Hints

- You can access all of the INVIEW™ Accounting features by pressing the **Accounts** key on the IntelliLink® Control Center. The system displays the account names in the format shown here:

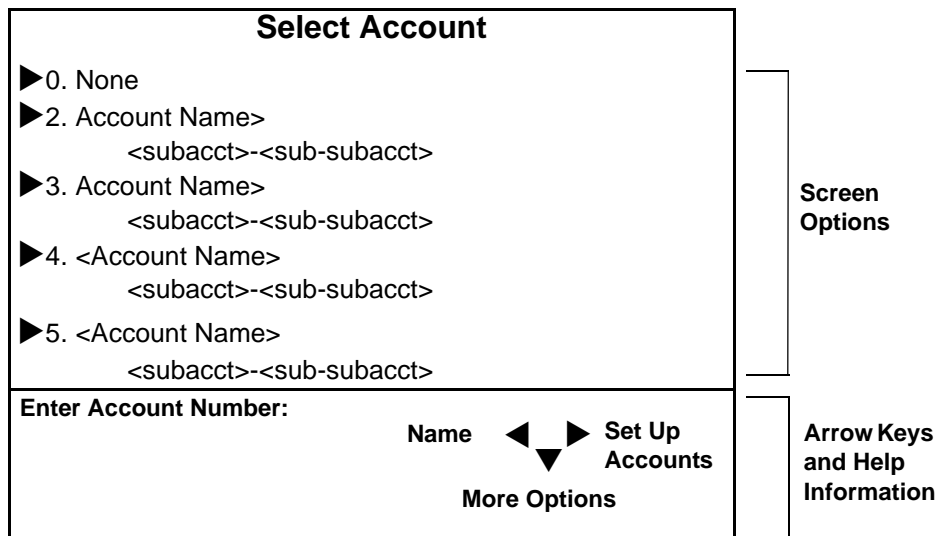

- To enter the INVIEW™ account set up mode, press the right arrow key on the control center as indicated by the help information on the bottom on the right side of the main screen.
- The maximum number of options displayed is 5. To view more options, press the down arrow key.
- You can select a numbered option either by pressing the screen key next to the option, or by pressing the corresponding number on the keyboard and then pressing the **Enter** key.
- Pressing the left arrow key returns you to the main screen.

Overview of Accounting

The information in this chapter describes how to set up the INVIEW™ Accounting package provided with your mailing system. If you purchased the enhanced accounting package, Budget Manager, or if your system is connected to an AccuTrac™ Mail Accounting Software SA system, or is part of the Business Manager system, refer to the documentation provided with these applications.

- For the Budget Manager, refer to SV60957.
- For the AccuTrac™ Mail Accounting System SA, refer to SV60514.
- For Business Manager, refer to the help file provided with the application.

For information on your system's accounting features, or if this is the first time you are setting up accounts and would like some examples of accounting structures and hierarchy see *“Working with INVIEW™ Accounts”* in this chapter.

To begin using the account setup procedures, go to *“Using the INVIEW™ Accounting Setup Procedures”* on the next page.

Before You Begin

Make sure the flash memory drive required to run INVIEW™ Accounting is installed on the IntelliLink® Control Center on your DM Series™ system as shown in the picture here.



If the flash memory is not installed, contact your Pitney Bowes service representative.

Using the INVIEW™ Accounting Setup Procedures

The following is a list of all the account setup procedures. For details on each procedure, refer to the section number listed here.

- 1 **Setting Up the Mailing System for INVIEW™ Accounting.**
- 2 **Setting Up Operators.**
- 3 **Working with Accounts.**
- 4 **Running Mail.**
- 5 **Transaction Options.**
- 6 **Reporting.**

1 **Setting Up the Mailing System for INVIEW™ Accounting**

This section contains the basic setup instructions necessary to run INVIEW™ Accounting on your mailing system.

Depending on your requirements, you may need to follow all or only some of the setup procedures listed here.

- *“Setting the Accounting Period”*
- *“Setting Up a Global Surcharge or Discount”*
- *“Selecting an Accounting Type”*
- *“Setting the INVIEW™ Accounting Owner”*
- *“Turning INVIEW™ Account Passwords On or Off”*
- *“Turning Weight Breaks On or Off”*
- *“Setting a Station ID”*
- *“Selecting Job ID Requirements”*
- *“Reporting Options”*
- *“Clearing Account Data”*

Setting the Accounting Period

When you enter the start date for the fiscal year, the system automatically determines the end date. (For example, if January 1, 2008 is the beginning of your fiscal year, the system sets the end date as December 31, 2008.)

Once the fiscal year is set, you will need to select the number of accounting periods. You can select one of the predefined accounting periods (none, annual, twice yearly, quarterly, and monthly) or you can define up to two custom account periods.

Follow the steps below to set your fiscal year and select the type of accounting period you will use:

1. Press the **Menu** key.
2. Select **Set Up, Accounting Set Up**, then **Accounting Period**. The Accounting Periods screen appears.
3. Select **Fiscal Year Start**.

- a. Type in the start date of your fiscal year.

NOTES:

- You can enter a start date that is within the current year. For example, if today's date is 1/20/2008, you can enter a start date back to 1/20/2008. When you enter the year, be sure to enter the full 4-digit year (e.g., 2008 or 2008).
 - Once you run a transaction you cannot change the start date of the fiscal year until you clear the accounting data, or the fiscal year ends.
-

- b. Press **Enter** to save the date. The Accounting Periods screen reappears.
4. Select **Number of Periods**.
 - a. Select the number periods for your fiscal year. Use the down arrow key to scroll through the list, if necessary.
 - b. b.If you select one of the preset periods, press **Enter** to return to the Accounting Set Up menu, then press the left arrow key to exit the set up.
 - c. If you select **Custom** period, the Custom Period screen appears. Go to step 5.
5. You can set up two custom periods. The start date for both periods is the date you activate the custom periods. You cannot change the start date.
 - a. Select **End Date 1** to set the end date for the first custom period. Key in the date and press **Enter**.
 - b. Select **End Date 2** and set the end date for the second custom period. The end date for the second period must always be the same as, or after the end date for the first period. Press **Enter**.
6. Press the left arrow key to exit set up.

NOTES for Custom Periods:

- For custom periods only, you can extend the end dates at any time during the period. The end date for custom period 2 must always be the same as custom period 1, or after custom period 1.
 - Once the end date is reached, you must clear the account data, extend the end date, or both. You will be prompted to print the data before it is cleared.
 - When the period expires, you will not be allowed to run mail until you either clear the data or extend the period.
-

Setting Up a Global Surcharge or Discount

When you select the surcharge method from the Set Up menu, you are setting a *global surcharge*, or a surcharge that applies to each transaction (or batch) processed by INVIEW™ Accounting, unless a *batch surcharge* overrides it.

You can apply a global surcharge per piece of mail, per transaction, and/or per transaction percentage.

- A per piece of mail surcharge is calculated by multiplying the number of pieces processed by the surcharge setting. The per piece surcharge can be set anywhere from -1.00 to 1.00.
- A per transaction surcharge is applied to each batch (or transaction) run on the system. The per transaction surcharge can be set anywhere from -50.00 to 50.00.
- A per transaction percentage surcharge is calculated multiplying the postage cost of the entire batch by the percent transaction setting. The per transaction percentage can be set anywhere from -100% to 100%.

NOTE: The dollar amount enter can be either positive or a negative. A *negative* amount indicates a discount will be applied to the postage amount for the transaction. A *positive* amount indicates a surcharge will be applied to the postage amount for a transaction.

If you want to apply a batch surcharge, or a surcharge that is customized for a specific transaction, see *Running Mail, Entering a Surcharge* in this chapter.

Follow the steps below to set a global surcharge or discount:

1. Press the **Menu** key.
2. Select **Set Up**, then **Accounting Set Up**. The Setup Accounting screen appears.
3. Select **Global Surcharge**.
4. To add a surcharge or discount per piece:
 - a. Select **Per Piece**.
 - b. Type in the surcharge or discount amount you wish to use for each individual piece of mail.
 - c. If necessary, select **Change to Discount** to apply a discount.
 - d. Press **Enter**.
5. To add a surcharge or discount per transaction:
 - a. Select **Per Transaction**.
 - b. Type in the surcharge or discount amount you wish to use for each individual piece of mail.
 - c. If necessary, select **Change to Discount** to apply a discount.
 - d. Press **Enter**.
6. To add a surcharge or discount per transaction percentage:
 - a. Select **Per Transaction Percentage**.
 - b. Type in the surcharge or discount percentage you wish to use for each individual piece of mail.
 - c. If necessary, select **Change to Discount** to apply a discount.
 - d. Press **Enter**.
7. Press **Enter**. The Enter Surcharge Value screen appears.
8. Press **Enter**.

Selecting an Accounting Type

Follow the procedure below to select an accounting type, or to disable the accounting feature on your mailing system.

1. Press the **Accounts** key.
2. Press the right arrow key to enter the “Set up Account” screen.
3. Press the down arrow key to press the down arrow key and select **Accounting**.

NOTE: The type of accounting currently set for your system is displayed next to the Accounting selection.

4. Depending on the option(s) you purchased, you can select from the following options:
 - To disable the current accounting, select **Off**.
 - To enable INVIEW™ accounting provided with your system, select **INVIEW™**.
 - If you have purchased Business Manager, select **Business Manager**.
 - If you have purchased Budget Manager, select **Budget Manager**.
 - If you have an AccuTrac SA connected to your system, select **AccuTrac..**



CAUTION: If you switch from one accounting system to another, you will lose all of the data in the original accounting system.

Setting the INVIEW™ Accounting Owner

Follow the steps below to enter information about the owner of the INVIEW™ Accounting system.

1. Press the **Menu** key.
2. Select **Set Up**, then select **Accounting Set Up**.
3. Use the down arrow key to scroll through the menu options, then select **Owner**.
4. Select **Name**. Type in the owner’s name and press **Enter**.
5. Select **Address 1**. Type in the address information (e.g. the street address) and press **Enter**.
6. Select **Address 2**. Type in any additional address information and press **Enter**.
7. Press **Enter** to save the owner information.
8. Press the left arrow key to exit setup and return to the Main screen.

**Turning
INVIEW™
Account
Passwords On or
Off**

By turning passwords on, you can protect each account from unauthorized access.

NOTE: Before you can turn account password protection on or off, you need enable the supervisor password protection feature. Refer to *Setting up a Supervisor Password* in *Chapter 4* of this guide for more information.

To turn account passwords on or off:

1. Press the **Menu** key.
2. Select **Set Up**, then select **Accounting Set Up**.
3. Use the down arrow key to scroll through the menu options, then select **Account Passwords** to toggle the feature On or Off.

**Turning Weight
Breaks On or Off**

Follow the steps below to turn weight breaks on or off.

1. Press the **Menu** key.
2. Select **Set Up**, then select **Accounting Set Up**.
3. Use the down arrow key to scroll through the menu options, then select **Weight Breaks** to toggle the feature On or Off.

**Setting a Station
ID**

The Station ID is printed on accounting reports to identify the mailing system where the reports were generated. This feature is useful when you have several different mailing systems that generate reports.

Station IDs are numeric and must be two characters in length.

Follow the step below to set a Station ID:

1. Press the **Menu** key.
2. Select **Set Up**, then select **Accounting Set Up**.
3. Use the down arrow key to scroll through the menu options, then select **Set Station ID**.
4. Type in the Station ID and press **Enter**.
5. Press the left arrow key to return to the Main screen.

**Selecting Job ID
Requirements**

The DM Series™ mailing system has the ability to track mail runs using Job IDs. Job ID tracking is commonly used for tracking expenses of projects accessed by multiple departments within the organization like client jobs or grants.

These entries can be scanned or entered manually by the operator before processing a mail run.

Requiring Job IDs

You can set up the system to require Job IDs in order to process mail. To require Job IDs:

1. Press the **Menu** key.
2. Select **Set Up**, then **Accounting Set Up**.
3. Press the down arrow key twice.
4. Select **Job ID Setup**.
5. Select **Job ID Required** to toggle this option on/off.
6. Press **Enter** when done.

Autoclearing Job IDs

You can set up the system to automatically clear Job IDs at the end of each transaction. To autoclear Job IDs:

1. Press the **Menu** key.
2. Select **Set Up**, then **Accounting Set Up**.
3. Press the down arrow key twice.
4. Select **Job ID Setup**.
5. Select **Job ID Autoclear** to toggle this option on/off.
6. Press **Enter** when done.

Reporting Options

Including Active and Inactive Accounts

When you select the Include Active and Inactive option on the Reporting Options menu, you can choose which types of accounts appear in INVIEW™ Accounting reports: Active and Inactive, Active Only, or Inactive Only.

1. Press the **Menu** key.
2. Select **Setup**, then **Accounting Set Up**.
3. Select **Report Options**. The Report Account Options screen appears.
4. Select **Include Active and Inactive**.
5. Select the type of accounts you want to include:
 - Active and Inactive
 - Active Only
 - Inactive Only
6. Press **Enter** when done.

Including Zero Values

When you select the Zero Value option on the Reporting Options menu, you can choose whether or not to include accounts with no charges for the reporting period in reports.

1. Press the **Menu** key.
2. Select **Setup**, then **Accounting Set Up**.
3. Select **Report Options**. The Report Account Options screen appears.
4. Select **Zero Value**.
5. Select the appropriate option: Include or Don't Include.
6. Press **Enter**.
7. Press **Enter** when done.

Clearing Account Data

Follow the steps below to clear the account data.



CAUTION: Clearing the account data will permanently erase all transaction data.

1. Press the **Menu** key.
2. Select **Set Up**, then **Accounting Set Up**. Use the down arrow key to scroll through the list of accounting set up options.
3. Select **Clear Account Data**.
4. Select **Clear Data**.
5. Select **Yes**.
6. Press the left arrow key to exit set up.

2 Setting Up Operators

This section contains the basic instructions necessary to set up and maintain operators on your mailing system.

- “Enabling Operator Passwords”
- “Creating Operators”
- “Enabling Operators”
- “Setting Operator Auto Log Off”
- “Deleting Operators”
- “Viewing and Editing Operators”

Enabling Operators

Follow the steps here to set up your mailing system so that you can assign operators and require each operator to enter his or her operator ID and password.

If operators have already been enabled on your system, then you will need supervisor privileges to complete this operation.

1. Press the **Menu** key.
2. Select **Set Up**, then select **Basic Settings**.
3. Select **Operators**.

If operators have been enabled, the Enter Supervisor Password screen appears. At this point, you must enter a supervisor password to continue with the operation or log off the system.

4. Press the screen key for the **Operators** selection to toggle between On and Off.

This change will take effect the next time you or another operator logs onto the system. At that time, the system will require a valid operator ID and password to log on.

Enabling Operator Passwords

Follow the steps here to require each operator to enter his or her password when they log onto the system.

If operators have already been enabled on your system, then you will need supervisor privileges to complete this operation.

1. Press the **Menu** key.
2. Select **Set Up**, then select **Basic Settings**.
3. Select **Operators**.

If operators have been enabled, the Enter Supervisor Password screen appears. At this point, you must enter a supervisor password to continue with the operation or log off the system.

4. Press the screen key for the **Operators Passwords** selection to toggle between On and Off.

This change will take effect the next time you or another operator logs on to the system. At that time, the system will require a valid operator ID and password to log on.

Creating Operators

Follow the steps below to create a new operator and assign a 4-digit alphanumeric password for the operator.

This operation requires that you have supervisor privileges:

- If supervisor passwords are on; **or**
- If operators have been enabled.

If you do not have supervisor privileges, you can log on to the system, but you cannot create any new operators.

1. Press the **Menu** key.
2. Select **Set Up**, then select **Basic Settings**.
3. Select **Operators**.

If operators have been enabled, the Enter Supervisor Password screen appears. At this point, you must enter a supervisor password to continue with the operation or log off the system.

4. Select **Create Operators**.
5. Type in the operator name and press **Enter**.
6. Type in the operator password and press **Enter**. The Operator Information screen appears.
 - Select **Name** to edit the operator name. Type in your changes and press **Enter**.
 - Select **Status** to toggle the operator active or inactive.
 - Select **Password** to assign an operator password. Type in the operator password and press **Enter**.

NOTE: You can create an operator password if operator passwords are disabled. However, the password cannot be used until you enable operator passwords. (See *Enabling Operator Passwords* in this section.)

- Select **Report Printing** to toggle between enabling and disabling report printing capabilities for the operator.
 - Select **Access Level** to toggle between operator and supervisor access privileges.
7. Press **Enter** to save your changes.
 8. Press the left arrow key to return to the Main screen.

Setting Operator Auto Log Off

You can set up your system so that operators are automatically logged out of INVIEW™ Accounting after a certain period of inactivity. The period of inactivity is defined by the Display Sleep timeout value. For more information on the Display Sleep timeout refer to the *System Setup* chapter in your DM Series™ Digital Mailing System operator guide.

1. Press the **Menu** key.
2. Select **Set Up**, then select **Basic Settings**.
3. Select **Operators**.

If operators have been enabled, the Enter Supervisor Password screen appears. At this point, you must enter a supervisor password to continue with the operation or log off the system.

4. Select **Auto Log Off**.
 - If the feature was not previously enabled, selecting Auto Log Off enables it and "On" appears next to the Auto Log Off selection.
 - If the feature was previously enabled, selecting Auto Log Off disables it and "Off" appears next to the Auto Log Off selection.
5. Press the left arrow key to return to the Main screen.

Deleting Operators

If there is transaction data associated with an operator and you delete the operator, the system does not remove the operator from the system until the end of the fiscal year. Instead, the operator becomes inactive, and will not be able to log on to the system. At the end of your fiscal year, you will receive a prompt indicating that the last reporting period has ended. At that time, you must select the inactive operator(s) you want to permanently delete and redefine the yearly fiscal period.

If there is no information connected to the operator, the system will remove the operator from the system at the time you delete it.

This operation requires that you have supervisor privileges.

1. Press the **Menu** key.
2. Select **Set Up**, then select **Basic Settings**.
3. Select **Operators**.

If operators have been enabled, the Enter Supervisor Password screen appears. At this point, you must enter a supervisor password to continue with the operation or log off the system.

4. Select **Delete Operator**. The Select Operator screen appears.
5. Select the operator you wish to delete, or type in the operator name and press **Enter**. The Delete Operator screen appears.
6. Select **Yes**.
7. Press the left arrow key to return to the Main screen.

Viewing and Editing Operators

The Viewing/Editing Operators screen allows you to access operator-specific information that has been entered into INVIEW™ accounts. You can view or edit the operator's name; lock or unlock the operator; enable, disable, or edit a password; enable or disable report printing; and edit the access level.

This operation requires that you have supervisor privileges.

1. Press the **Menu** key.
2. Select **Set Up**, then select **Basic Settings**.
3. Select **Operators**.

If operators have been enabled, the Enter Supervisor Password screen appears. At this point, you must enter a supervisor password to continue with the operation or log off the system.

4. Select **View/Edit Operators**.
5. Select the operator you wish to view and/or edit. The Operator Information screen appears. This screen allows you to view and edit the basic settings for the operator you have selected.
 - Select **Name** to edit the operator name. Type in your changes to the operator name and press **Enter**.
 - Select **Status** to toggle between locking and unlocking the operator.
 - Select **Password** to edit the operator password. Type in the operator password and press **Enter**.
 - Select **Report Printing** to toggle between enabling and disabling report printing capabilities for the operator.
 - Select **Access Level** to toggle between operator and supervisor access privileges.
6. Press **Enter** to save your changes.
7. Press the left arrow key to return to the Main screen.

Any changes you make will be seen by the edited operator the next time he or she logs on to the system.

3 Working with INVIEW™ Accounts

This section contains the basic instructions necessary to set up and maintain accounts on your mailing system.

- “*INVIEW™ Accounting Account Structure*”
- “*Creating an Account*”
- “*Creating a Subaccount or Subsubaccount*”
- “*Viewing or Editing an Account*”
- “*Deleting an Account*”

INVIEW™ Accounting Account Structure

You can use INVIEW™ Accounting to track and account for postage used by departments or individuals within your organization. Your system is set up to accept a total of 74 characters for single level accounts, a total of 73 characters for an account and sub account, and a total of 72 characters for an account, subaccount, and subsubaccount.

When accounts are linked (account-subaccount, or account-subaccount-subsubaccount) they become a set and are treated as one separate account, with one account number and one password. The existing account number and password are rolled down to the subaccount when the first subaccount is created. When you create another subaccount to this account, you create another linked set of accounts with a different account number and password.

NOTE: Only the lowest level of the account hierarchy is chargeable. This means that transactions can only be posted to that account.

The following examples demonstrate some of the ways in which you can structure your accounts.

- When you create a top level account, you can charge funds and pieces to that account. This is the working (chargeable) account because at this point it does not have any subordinate accounts:

Example: Account - Engineering

If you create subaccounts for the original account, they become the end links in the account chain and identify the departments where you charge to:

Examples:

Account - Engineering, Subaccount - Software

Account - Engineering, Subaccount - Industrial Design

The original account now serves as an administrative account that owns and contains totals for the lower subaccounts.

- If you create subsubaccounts for subaccounts, the subsubaccounts become the end links and identify the departments that are charged for postage.

Examples:

Account - Engineering, Subaccount - Software,

Subsubaccount - Software Testing

Account - Engineering, Subaccount - Software,

Subsubaccount - Software Design

Account - Engineering, Subaccount - Industrial Design,

Subsubaccount - Graphics and Layout

Account - Engineering, Subaccount - Industrial Design,

Subsubaccount - User Friendly Testing

Creating an Account

Follow the steps below to create an account:

1. Press the **Accounts** key.
2. Press the right arrow key to enter the Set Up Accounts screen.

NOTE: If this is the first account on the system, skip to step 3.

3. Select **Create Account**.
4. Select **Create a New Account**. The system prompts you to enter an account name.

NOTE: When naming your accounts, the total number of characters you can use for the name is 74. This means that if you intend to add sub and subsub accounts to this top level account name, the sum of the characters for all three accounts levels cannot be greater than 74.

5. Type in the name using the keyboard or numeric keypad and press **Enter**. The Account Information screen appears.
6. Select the appropriate option and follow the prompts.
 - **Name:** Select this option to edit the name of an account.
 - **Speed Code:** A speed code is a number that uniquely identifies an account. You can use it as a short cut to identify accounts with long names. As soon as you enter the name of your account, the system automatically assigns a speed code to your account. Select this option to change the speed code number assigned by the system.
 - **Password:** The account password is a four digit number that you can assign to limit access to an account. As soon as you enter the name of your account, the system will request that you enter the account password if it is enabled. Select this option to assign, change or disable the password if necessary. When you are running mail, passwords must be globally enabled.
 - **Create Another Account:** Select this option to add another account, subaccount or subsubaccount to the system.
 - **Add Subaccount to:** Select this option to add a subaccount to your new account.
 - **Description:** This option allows you to type in a brief description of the account.
7. When you are done, press the right arrow key to save your account information. If you press the **Clear** key or the left arrow key during this process the system will ask you if you want to save your changes.

Creating an Subaccount or Subsubaccount

Any data charged to the existing account will be transferred to the subaccount or subsubaccount you create.

1. Press the **Accounts** key.
2. Press the right arrow key to enter the Set Up Accounts screen.
3. Select **Create Account or SubAccount**.
4. Select **Add to an Existing Account** to enter the Select Account screen. The system displays a list of all the existing accounts.
5. Select the appropriate account or subaccount. If necessary, press the down arrow to scroll through the list.
6. Type in the name of the new subaccount or subsubaccount and press **Enter**. The Account Information screen appears.
7. Select the appropriate option and follow the prompts.
8. When you are done, press **Enter** to save the account information.
9. Press the left arrow key to exit set up.

Viewing or Editing an Account

You can view or edit the account name, status, budget amount, spending limit, owner information and description for all of the accounts entered into INVIEW™ Accounting.

1. Press the **Accounts** key.
2. Press the right arrow key to enter the Set Up Accounts screen.
3. Select **View/Edit Accounts**.
4. Select the account you want to view and/or edit by pressing the screen key that corresponds with the account name, *or* type in the account name and press **Enter**. The View/Edit Accounts screen appears.
5. Select the appropriate option and follow the prompts.
 - **Edit Account Name:** Select this option to make changes to the name of the account you have selected.
 - **Change Speed Code:** Select this option to change the speed code number assigned by the system.
 - **Status:** Once you have added an account to the system, you can set the account active or inactive. Active status is the default setting for all accounts. If you have an account that you no longer wish to use, you can set the status to inactive. The inactive account will remain on the system, but you will not be able to process transactions against it.
 - **Password:** The account password is a four digit number that limits access to an account.
 - **Description:** Select this option to edit the account description.
6. Once you have finished viewing and/or editing the account information, press **Enter** to exit the View/Edit Accounts screen.
7. Press the left arrow key to return to the Main screen.

Deleting an Account

When you delete an INVIEW™ account, you remove its data completely. That data is then unrecoverable. Make sure you do not need the account's data before you delete the account. *Once you delete an account, its data cannot be retrieved.*

1. Press the **Accounts** key.
2. Press the right arrow key to enter the "Set Up Account" screen.
3. Select **Delete Account**.
4. Select the account you want to delete..

NOTES:

- You can only select a chargeable account to delete. The selected account, subaccount and/or subsub-account, along with its postage and pieces of mail is deleted.
- The subaccounts appear in the display as two separate accounts under the main account title:

**Engineering
Software
Engineering
Industrial Design**

5. As soon as you select an account, the system prompts you to print a report. To keep a record of your account data, select **Print Report**.
6. Select **Delete** to remove the account from the system.
7. Press the left arrow key to return to the main screen.

4 Running Mail

This section describes unique features available when running mail with INVIEW™ Accounting. Refer to the *Running Mail* chapter in this guide for complete directions on how to run mail.

- “Selecting an Account in Time Date Stamping Mode”
- “Selecting an Account in Seal Only Mode”
- “Entering a Batch Surcharge”
- “Selecting a Job ID”

Selecting an Account in Time Date Stamping Mode

Time Date Stamping mode allows you to print the current time and date, along with the word “Received” on incoming mail. When using Budget Manager or Business Manager accounting, you can: select an account to charge back to, apply a surcharge and/or select Job ID to apply the time date stamp to.

The time and date will remain the same during a single transaction (whether you process a single envelope or 100 envelopes.) The system will update the date and time during the mail run.

NOTE: The mailing system may operate at a slightly slower speed during this process.

1. Press the **Mode** key.
2. Select **Time and Date Stamping**.
3. Select **Acct** if you want to apply the time date stamp to a specific account. Once you have made your selection, the system returns to the Time Date Stamp Mode screen.
4. Select **Surcharge** if you want to apply a batch surcharge (a surcharge that applies only to this transaction). You can apply a surcharge per piece of mail, per transaction, and/or per transaction percentage.
 - a. Select the appropriate surcharge option and enter the surcharge amount.
 - b. Press **Enter**. The system returns to the Time Date Stamp Mode screen.
5. Select **Job ID** if you want to add a Job ID to the transaction.
 - If you know the Job ID, type in the Job ID number and press **Enter**.
 - If you want to see a list of recently used Job IDs, select **Most Recent Job ID**, then select the Job ID. (You can use the down arrow key to scroll through the list.)

Once you have made your selection, the system returns to the Time Date Stamp Mode screen.

6. Turn the piece of mail over, so the meter stamp is facing down. Then, place the envelope on the feed deck with the flap facing up.
7. Press the **Start** key. The Time/Date stamp prints on the envelope. A sample Time/Date stamp is shown below.

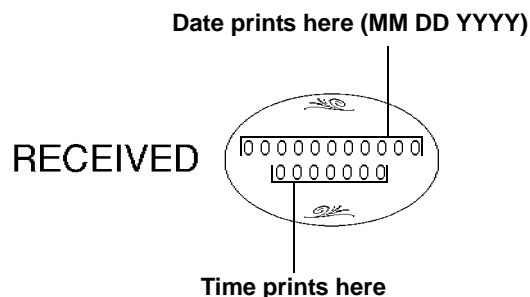

Selecting an Account in Seal Only Mode

Seal Only Mode allows you to seal envelopes without applying postage. If you are running INVIEW™ Accounting, and you select Seal Only Mode, you will be prompted to select an account to track the pieces against.

When you view or print an accounting report, “Seal Only” will appear in the Class column if the pieces were processed in Seal Only mode.

Entering a Batch Surcharge

When you select the surcharge method from the Main screen, you are setting a batch surcharge, or a surcharge that will be applied only to the current transaction being processed.

Setting a batch surcharge will override your global surcharge settings, but only for the current transaction. Once the transaction is complete, the system will revert to the global surcharge settings for the system.

You can apply a batch surcharge per piece of mail, per transaction, and/or per transaction percentage.

If you want to set up a global surcharge, or a surcharge that will be applied to each and every transaction processed by the INVIEW™ Accounting system, see *Setting Up Accounting, Selecting a Surcharge Mode* in this chapter.

To enter a batch surcharge:

1. At the Main screen, press the down arrow key.
2. Select **Surcharge**. The Batch Surcharge screen appears.
3. To clear the existing batch surcharge settings, select **Clear Surcharges**. The per piece, surcharge per transaction, and per transaction percentage surcharges are set to 0.
4. To add a surcharge per piece:
 - a. Select **Per Piece**.
 - b. Type in the surcharge amount you wish to use for each individual piece of mail and press **Enter**.
5. To add a surcharge per transaction:
 - a. Select **Per Transaction**.
 - b. Type in the surcharge amount you wish to use for each transaction and press **Enter**.
6. To add a surcharge per transaction percentage:
 - a. Select **Per Transaction Percentage**.
 - b. Type in the percentage amount you wish to use and press **Enter**.
7. Press **Enter** to save your changes.

Selecting a Job ID

The Job ID field allows you to identify specific tasks within an account. Assigning a Job ID to a transaction allows you to track the amount of money you spend on postage, as well as how frequently you process a given transaction.

Follow the steps below to add a Job ID to a transaction:

1. From the Main screen, press the down arrow key.
2. Select **Job ID**. The Job ID screen appears.
 - If you know the Job ID, type in the Job ID number and press **Enter**.
 - If you want to see a list of recently used Job IDs, select **Most Recent Job ID**, then select the Job ID. (You can use the down arrow key to scroll through the list.)
3. The system returns to the Main screen once you have made your Job ID selection.

4 Transaction Options

This section tells you how to create manual transactions and view transactional data using INVIEW™ Accounting.

- *“Entering Manual Transaction”*
- *“Viewing the Transaction Log”*
- *“Transferring Transaction Data”*
- *“Clearing the Transaction Log”*
- *“Setting the Condition for the Log Full Warning”*
- *“Defining the Action to Take When the Log is Full”*
- *“Printing Transaction Receipts”*

Entering Manual Transaction

Follow the steps below to create a manual transaction.

1. Press the **Menu** key.
2. Select **Manual Transaction**. The Manual Transaction screen appears. The options you choose to use will vary depending upon your manual transaction needs.
3. Select **Account** to choose an account from the available accounts on your system to run the manual transaction against. Use one of the following methods to select an account:
 - Manually scroll through the account list, then press the screen key that corresponds with the account name; or
 - Press the left arrow key to toggle the speed code search, type in the speed code, and press **Enter**; or
 - Press the left arrow key to toggle the account name search, type in the account name, and press **Enter**.
4. Select **Class** to set the postage class. Follow the prompts to select the appropriate carrier, class and special service options.
5. Select **Actual Postage** to set the actual postage amount for a piece of mail. Type in the actual postage amount for a piece of mail and press **Enter**.
6. Select **Charged Amount** to set the postage amount that you will be charging for each piece of mail. (This is the actual postage amount plus any surcharges you may want to add.) Type in the charged postage amount for a piece of mail and press **Enter**.
7. Select **Piece Count** to set the number of pieces of mail you want to process. Type in the number of pieces you want to mail and press **Enter**.

8. Select **Weight to** enter the weight of a piece of mail. Type in the weight and press **Enter**.
9. Select **Job ID** to assign a Job ID to the manual transaction.
 - a. Type in the Job ID number and press **Enter**; or
 - b. Select the **Most Recent Job ID** option, select the **Job ID**, then press **Enter**.
10. Once you have finished setting up your manual transaction select **Create Another** to enter an additional manual transaction, or press **Enter** to save your changes and return to the Main screen.

Viewing the Transaction Log

The transaction log contains a list of summary information for each of the transactions you have processed on the system. Each log contains the:

- Account;
- Transaction number and date;
- Actual postage;
- Charged amount;
- Piece count;
- Total weight;
- Transaction type;
- Carrier, class and fee (special services) used; and
- Operator ID.

Once you select to view the transaction log, you can view the transactions by date range and/or account. You also have the option of printing the transactions that meet the date and/or account criteria.

Follow the steps below to view the transaction log:

1. Press the **Menu** key.
2. Select **Set Up, Accounting Set Up**, then **Transaction Options**. The Transaction Options screen appears.
3. Select **View Transaction Log**.
4. The Select Account screen appears. You can:
 - Select **All Accounts**,
 - Select **For Each Account**. or
 - Select a specific account from the list.
5. The Enter a Date Range to Print screen appears.
 - a. Select **Start** to enter the date you want the transaction log to start. Type in the date in MMDDYYYY format. Press **Enter** when done.
 - b. Select **End** to enter the date you want the transaction log to end. Type in the date in MMDDYYYY format. Press **Enter** when done.
6. Press **Enter** to preview the transaction log.
7. Press **Enter** again to print the transaction log to an attached printer.

Transferring Transaction Data

You can use the transfer transaction data option to correct transactions that have been processed against with the wrong account.

Follow the steps below to select the transaction you want to transfer:

1. Press the **Menu** key.
2. Select **Set Up, Accounting Set Up**, then **Transaction Options**. The Transaction Options screen appears.
3. Select **Transfer a Transaction**. The Select Transaction By screen appears.
4. Use one of the following methods to select transactions:
 - Select **Date** to view the transactions processed on a specific date. Type in the date and press **Enter**.
 - Select **Account** to view the transactions processed against a specific account. Select an account from the list provided.
 - Select **Date and Account** to view transactions processed against a specific account on a specific date. Type in the date and press **Enter**. Select an account from the list provided.
5. Use the left and right arrow keys to sort through each of the transactions that met your date and/or account criteria.
6. Press **Enter** once you have found the transaction you want to transfer. The Select Account To Transfer To screen appears.
7. Select the account you want to transfer the transaction to. The Transaction Log screen appears with the updated account information in the Account field.
8. Press **Enter**.
9. Press the left arrow key to return to the Main screen.

Clearing the Transaction Log

The transaction log can hold up to 4,000 transactions, depending upon the INVIEW™ Accounting package you use. When the transaction log reaches full capacity, you can clear out the log to allow the inclusion of new transactions.

Follow the steps below to clear the transaction log:

1. Press the **Menu** key.
2. Select **Set Up, Accounting Set Up**, then **Transaction Log**. The Transaction Options screen appears.
3. Select **Clear Transaction Log**. The Clear Transaction Log screen appears.
4. If you want to print a report select **Yes**. If you do not want to print a report select **No**. The Continue to Clear Log screen appears.
5. Select **Yes** to clear the log. The system returns to the Transaction Options screen.
6. Press the left arrow key to return to the Main screen.

Setting the Condition for the Log Full Warning

You can set the “log full warning” to notify you when the transaction log is filled to a certain percentage. The default setting is 90%, which means that when the transaction log is 90% full, you will receive a warning. The lowest setting you can use is 80%. The highest setting you can use is 100%.

Follow the steps below to set the log full warning:

1. Press the **Menu** key.
2. Select **Set Up, Accounting Set Up**, then **Transaction Log**. The Transaction Options screen appears.
3. Select **Log Full Warning**.
4. Type in the percentage you want use (from 80 to 100) and press **Enter**. The system returns to the Transaction Option menu.
5. Press the left arrow key to return to the Main screen.

Defining the Action to Take When the Log is Full

The Action When Full option allows you to select the action you want the system to take when the transaction log is full. You can choose to stop processing mail, to continue processing mail with accounting disabled, or to process mail and overwrite the transaction log.

Follow the steps below to select the action to take when the log is full:

1. Press the **Menu** key.
2. Select **Set Up, Accounting Set Up**, then **Transaction Log**. The Transaction Options screen appears.
3. Select **Action When Full**. The Select Action screen appears.
4. Select the action you want the system to take. The system returns to the Transaction Options menu.
5. Press the left arrow key to return to the Main screen.

**Printing
Transaction
Receipts**

The Receipt Printing option allows you to select the action you want the system to take at the end of each transaction. You can choose to print a short form receipt, to print a long form receipt, or to turn receipt printing off.

You must have an external (attached) printer or a receipt printer connected to your system in order to print transaction receipts.

Follow the steps below to print transaction receipts:

1. Press the **Menu** key.
2. Select **Set Up, Accounting Set Up**, then **Transaction Log**. The Transaction Options screen appears.
3. Select **Receipt Printing**. The Receipt Printing screen appears.
4. Select the appropriate option:
 - **Short Form** - The receipt includes the date, time, station, serial number, operator, account, Job ID 1, carrier, class, total pieces, surcharge and charge.
 - **Long Form** - This receipt includes the date, time, station, serial number, operator, account, Job ID 1, carrier, class, total pieces, surcharge, charge, start/end ascending register, start/end descending register, start/end piece count.
 - **Off**.

```

-----
                                Transaction Receipt
Date: 2008/07/23                Time: 16:31
Station: 0                      Serial No. : 0123450

Operator: Joe

Account: Bridgeport
        Job ID : Black

                                Batch Information

Carrier : 50-USPS Domestic

Class : 124-Express Mail PO-Addresses

                                Surcharge :    0.240
Total                               Charge : 2.640
        Pieces :    24

-----
    
```

Short Form Receipt

```

-----
                                Transaction Receipt
Date: 2008/07/23                Time: 16:31
Station: 0                      Serial No. : 0123450

Operator: Joe

Account: Bridgeport
        Job ID : Black

                                Batch Information

Carrier : 50-USPS Domestic

Class : 124-Express Mail PO-Addresses

                                Surcharge :    0.240
Total                               Charge : 2.640
        Pieces :    24

                                Meter Information

Start Ascending Register :      21.010
End Ascending Register :      23.410

Start Descending Register :    9979.000
End Descending Register :    9976.600

                                Start Piece Count :    97
                                End Piece Count :    121

-----
    
```

Long Form Receipt

5 INVIEW™ Accounting Reports

This section tells you how to view, print and create reports unique to the INVIEW™ Accounting system.

With INVIEW™ Accounting, you have the ability to create a broad range of accounting reports. The following is a list of INVIEW™ Accounting reports:

- “Report Printing Queue”
- “Report Macros”
- “Custom Reports”
- “Transaction Log Report”
- “Weight Break Account/Class Report”
- “Weight Break Carrier/Class Report”
- “Weight Break Job ID/Class Report”
- “Account Summary Report”
- “Quick Profile Report”
- “Accounting Setup Report”
- “Account List Report”
- “Account Speed Code List Report”
- “Operator List Report”

Refer to the *Reporting* chapter in this guide for additional reporting information.

Printing Reports

You can print accounting reports using an external (attached) printer if one is connected to your system.

NOTE: You must enable report printing for an operator in order for that operator to print a report. *Setting Up Operators, Viewing and Editing Operators* in this section for more information.

Follow the steps below to print a report:

1. Press the **Reports** key.
2. Select the report you want to print. Follow the prompts, if any, that may appear.
3. Press **Enter** to print the report to the attached printer.
4. Press the left arrow key to return to the main screen.

Report Printing Queue

The Report Print Queue will function with most reports, except for the Confirmation Services reports. (A warning message will appear if you attempt to print a Confirmation Services report when there are reports in the queue.)

If a series of reports are scheduled to print, the Reports Queue option will appear on the main report screen.

1. Press the **Reports** key.
2. If necessary, press the down arrow key and select **Reports Queue**. Once selected, this option will list information about the report that is currently printing, as well as a list of the reports that are remaining in the queue.

NOTE: You can cancel reports out of the queue. If the printer runs out of paper, the "Check external printer" message will appear on the main screen.

Report Macros

Report macros allow you to print up to five reports at once. For example, you can print up to five reports related to the same account, or the same report for up to five different accounts.

Creating a Report Macro

Follow the steps below to create a report macro.

1. Press the **Reports** key
2. Select **Accounting Reports** and then **Report Macros**.
3. Press the right arrow key to enter the Set Up menu. The Set Up Report Macro screen appears.
4. Select **Create Macro**.
5. Type in the macro name and press **Enter**.
6. Select a report to add to the macro. Use the down arrow key to scroll through the list of reports, if necessary.
7. Select an account to include in the report and press **Enter**. Depending upon your selection, you may be prompted to enter a date range.
Select:
 - Select **Current Day** to print the report for the current day.
 - Select **Current Week** to print the report for the current week.
 - Select **Current Month** to print the report for the current month.
 - Select **N days back from today** to print the report for a set number of days. Enter the number of days back, up to 364, that you want to print the report for.Press **Enter** when done.
8. Press **Enter** to save the report and account information.
9. Repeat steps 6 to 8 to add additional reports to the macro. You can add reports to the macro until all "Available" options are used.
10. Press **Enter** to save the macro.

Using a Report Macro to Print Reports

You can print report macros using an external (attached) printer if one is connected to your system.

Follow the steps below to print a report macro:

1. Press the **Reports** key
2. Select **Accounting Reports** and then **Report Macros**.
3. Select the report macro you want to print.
4. Press **Enter** to print the report macro.
5. Press **Enter** to return to the main screen.

Viewing and Editing Report Macros

1. Press the **Reports** key
2. Select **Accounting Reports** and then **Report Macros**.
3. Press the right arrow key to enter the Set Up menu. The Set Up Report Macro screen appears.
4. Select **View/Edit Macro**.
5. Select the macro you want to view or edit.
6. The Edit Macro name screen appears.
 - If you want to rename the report macro, use the left arrow key to delete letters in the macro name, or press the **Clear** key to clear the name. Type in the new macro name and press **Enter**.
 - If you want to keep the existing macro name, press **Enter**.
7. To replace a report in the macro, press the screen key that corresponds with the report you want to replace. Follow the prompts and select the appropriate report options.
If there are "Available" options, you can add reports to them as well.
8. Press **Enter** to save your changes.

Deleting a Report Macro

Follow the step below to delete a report macro from the system.

1. Press the **Reports** key
2. Select **Accounting Reports** and then **Report Macros**.
3. Press the right arrow key to enter the Set Up menu. The Set Up Report Macro screen appears.
4. Select **Delete Macro**.
5. Select the macro you want to delete.
6. The Delete Macro screen appears. Select **Yes** to delete the macro.

Custom Reports

You can design your own report formats using the Custom Reports Report Generation feature. This tool allows you to select the report format you want (summary or detailed) as well as select the fields of information you want to appear on the report.

A detailed report outputs specific information about each transaction processed by the system. If you select the detailed report format you will be able to include any, or all, of the following data in your report:

- Transaction ID;
- Date of Transaction;
- Time;
- Account;
- Carrier;
- Class/Fee;
- Job ID 1;
- Operator;
- Total Weight;
- Pieces;
- Postage;
- Surcharge;
- Total Charge; and
- Transaction Type.

A summary report groups transaction information together by time period. If you select the summary report format you will be able to include any, or all, of the following data in your report:

- Account;
- Carrier
- Class/Fee
- Pieces;
- Postage;
- Surcharge;
- Total Charge;
- Year to Date Pieces;
- Year to Date Postage;
- Year to Date Surcharge; and
- Year to Date Total Charge.

Custom Report Tips:

- “Available” options on the Select Custom Report screen indicate open spaces where you can create a new custom report.
 - When selecting data to include in the report:
 - “Selected” appears next to the data name to indicate that it will be used in the report.
 - Each data selection you make will appear as a column in the report.
 - The “Spaces Used” counter on the bottom of the screen indicates how much space you have left in the report. You will receive a “Not Enough Space Left” warning if you select data that exceeds the amount of space the report can take up on the printed page.
-

Creating a Custom Report

Follow the steps below to create a custom report.

1. Press the **Reports** key.
2. Select **Accounting Reports**, then **Custom Reports**.
3. Select the first Available option on the list.
4. Select **Create Report**.
5. Type in the report name and press **Enter**.
6. Select the appropriate report format.
7. Press the screen keys that correspond with the data you want to include in your report.
8. Press **Enter** when you are done selecting data.
9. If you selected any data that can be grouped, the Select Data to Group By screen appears. Select the appropriate option(s) and press **Enter**.
10. If you selected any data that can be subtotaled, the Select Data to subtotal screen appears.
 - a. Press the screen keys that correspond with the data you want to subtotal in your report.
 - b. Press **Enter** once you are done selecting data.
11. If you selected accounts to be grouped or subtotaled, the Accounts to Include screen appears.
 - Select **Prompt for an Individual Account...** to require an operator to select an account before printing the report.
 - Select **Include All Accounts** to include all accounts when printing the report.
12. Press **Enter** to save the custom report.

Viewing and Editing a Custom Report

Follow the steps below to view and/or edit a custom report.

1. Press the **Reports** key.
2. Select **Accounting Reports**,
3. Press the right arrow key. The Set Up Custom Reports screen appears.
4. Select **View/Edit Report**.
5. Select the custom report you want to view or edit. The Edit Report Name screen appears.
6. Use the left arrow key to backspace, or press the **Clear** key to delete the existing name. Type in the new report name and press **Enter**.
7. The Select Data to Include screen appears. Select or deselect the appropriate options.
8. If you selected any data that can be subtotaled, the Select Data to subtotal screen appears.
 - a. Press the screen keys that correspond with the data you want to subtotal in your report.
 - b. Press **Enter** once you are done selecting data.
9. If you selected accounts to be grouped or subtotaled, the Accounts to Include screen appears.
 - Select **Prompt for an Individual Account...** to require an operator to select an account before printing the report.
 - Select **Include All Accounts** to include all accounts when printing the report.
10. Press **Enter** to save the custom report.

Deleting a Custom Report

Follow the steps below to delete a custom report from the system:

1. Press the **Reports** key.
2. Select **Accounting Reports**,
3. Press the right arrow key. The Set Up Custom Reports screen appears.
4. Select **Delete Report**.
5. Select the custom report you want to delete.
6. Select **Yes**.
7. Press the left arrow key to return to the Main screen.

Transaction Log Report

The Transaction Log report lists the transaction ID, account, pieces, postage, surcharge, and total amount charged for each transaction during the time period specified on the report.

Pitney Bowes Incorporated		Page:		1		
1 Elmcroft Road		Date:		JAN 5 2008		
Stamford, CT 06926		Time:		3:02P		
		Station:		2A		
Transactions for JAN 1 2008 to JAN 5 2008						
Trans						Trans
ID	Account	Pieces	Postage	Surcharge	Total	Type
1	Shelton	9	5.400	0.00	5.400	I
2	Stamford	24	13.070	0.00	13.070	I
3	Newtown	3	11.550	0.00	11.550	I
=====						
Grand Total:		43	34.450	0.00	34.450	

**Weight Break
Account/Class
Report**

The Weight Break Account/Class report contains a summary of the pieces and postage for each weight break by specific account or all accounts showing the carrier/class used.

Weight Break Account/Class for Jan 4 2008 to Jan 4 2008

<u>Account</u>	<u>Carrier</u>	<u>Class</u>	<u>Weight</u>		<u>Pieces</u>	<u>Postage</u>
			<u>Break</u>	<u>Units</u>		
NE Cities - Hartford	USPS Dom	1st Cls Regular	1.0	oz	3	1.110
			2.0	oz	3	1.800
			3.0	oz	3	2.490
			Subtotal:			
	Subtotal:				9	5.400
Subtotal						9 5.400
NE Cities - New Haven	USPS Dom	1st Cls Presort	1.0	oz	4	1.408
			2.0	oz	4	2.308
			3.0	oz	4	3.044
			Subtotal:			
	Subtotal:				12	6.760
Subtotal:						12 6.760
=====						
Grand Total:					25	12.160

**Weight Break
Carrier/Class
Report**

The Weight Break Carrier/Class report contains a summary of the pieces and postage for each weight break by carrier and class.

Weight Break Carrier/Class for Jan 4 2008 to Jan 4 2008						
<u>Carrier</u>	<u>Class</u>	<u>Weight</u>		<u>Pieces</u>	<u>Postage</u>	
		<u>Break</u>	<u>Units</u>			
	No Class	0.0	oz	61	104.170	
	Subtotal:			61	104.170	
Subtotal:				61	104.170	
	Seal Only	0.0	oz	25	0.000	
	Subtotal:			25	0.000	
Subtotal:				25	0.000	
USPS Dom	1st Cls Presort	1.0	oz	4	1.408	
		2.0	oz	4	2.308	
		3.0	oz	4	3.044	
		Subtotal:				12
	1st Cls Regular	0.0	oz	6	3.330	
		1.0	oz	30	38.520	
		2.0	oz	30	44.700	
		3.0	oz	30	51.600	
	Subtotal:				96	138.150
Subtotal:				108	144.910	
=====						
Grand Total:				194	249.080	

**Weight Break
Job ID/Class
Report**

The Weight Break Job ID/Class report contains a summary of the pieces and postage for each weight break by specific Job ID, showing the carrier and class used.

Weight Break Job ID-1/Class for Jan 4 2008 to Jan 4 2008

<u>Job ID</u>	<u>Carrier</u>	<u>Class</u>	<u>Weight</u>		<u>Pieces</u>	<u>Postage</u>
			<u>Break</u>	<u>Units</u>		
Black		No Class	0.0	oz	25	96.250
		Subtotal:			25	96.250
	Subtotal:				25	96.250
		Seal Only	0.0	oz	25	0.000
		Subtotal:			25	0.000
	Subtotal:				25	0.000
	USPS Dom	1st Cls Regular	1.0	oz	1	0.420
			2.0	oz	1	0.600
			3.0	oz	1	0.830
		Subtotal:			3	1.800
	Subtotal:				3	1.800
Subtotal:					53	98.050
Green	USPS Dom	1st Cls Regular	0.0	oz	6	3.330
			1.0	oz	8	18.170
			2.0	oz	8	19.650
			3.0	oz	8	21.490
		Subtotal:			30	62.640
	Subtotal:				30	62.640
Subtotal:					30	62.640
=====						
Grand Total:					83	160.690

**Account
Summary Report**

The Account Summary Report lists a summary of pieces, postage and surcharges for an account or all accounts that have been charged for the time period specified for the report.

If this report is for a single account it can be viewed on the screen.

Pitney Bowes Incorporated	Page:	1		
1 Elmcroft Road	Date:	JAN 5 2008		
Stamford, CT 06926	Time:	3:02P		
	Station:	2A		
Account Summary - JAN 1 2008 to JAN 30 2008				
<u>Account</u>	<u>Pieces</u>	<u>Postage</u>	<u>Surcharge</u>	<u>Total</u>
PB				
Stamford				
WHQ	28	31.030	0.00	31.030
Subtotal:	28	31.030	0.00	31.030
=====				
Grand Total:	28	31.030	0.00	31.030

Quick Profile Report

The Quick Profile report lists the summary of pieces, postage and surcharges for all of the INVIEW™ accounts.

You can view the Quick Profile reports on the IntelliLink® Control Center before printing them..

Quick Profile Report	
Period: JAN 01 2008 - JAN 08 2008	
Pieces:	677
Postage:	\$393.836
Surcharge:	\$28.65
Total:	\$422.486

Accounting Setup Report

The Accounting Set Up report lists the INVIEW™ Accounting options and settings.

Accounting Setup	
<u>Configuration Item</u>	<u>Value</u>
Accounting PCN	####
Number of Accounts	13
Accounting Periods	12
Account Passwords	Enable
Default Spend Limit Basis	90%
Spend Limit	Enable
Operators	Enable
Passwords	Enable
Global Surcharge Method	0
Per Piece Surcharge	+0.000000
Per Transaction	+0.000000
Percentage Surcharge	0%
Per Piece Surcharge Limit	1.000000
Per Transaction Limit	50.000000
Transaction Warning	90%
Transaction Full Action	Alert Operator
Owner Name	Pitney Bowes
Owner Address	35 Waterview Drive, Shelton CT 06484
	Version 19x

Account List Report

The Account List report lists the accounts that have been defined in the system with speed codes. The accounts are sorted by account name, then by subaccount and subsubaccount.

Account List & Status			
<u>Account</u>	<u>Account Status</u>	<u>Password Required</u>	<u>Account Description</u>
Connecticut	Enable	No	
Bridgeport	Enable	No	
Hartford	Enable	No	
New Haven	Enable	No	
PB	Enable	No	
Danbury	Enable	No	
DMT	Enable	No	
Newtown	Enable	No	

Account Speed Code List Report

The Account Speed Code List Report lists the accounts that have been defined in the system and the account status. The report is sorted by account speed code. Account speed codes refer to chargeable accounts.

Account Speed Code List		
<u>Speed Code</u>	<u>Account</u>	<u>Description</u>
1	Shelton	
2	Stamford	
3	Connecticut - Hartford	
4	Connecticut - New Haven	
5	Connecticut - Bridgeport	
6	PB-Shelton-27WV	
7	PB-Shelton-35WV	
8	PB-Stamford-Main Plant	
9	PB Newtown-Distribution	
10	PB Newtown-RMA	

Operator List Report

The Operator List report lists the operators on the accounting system. This report contains the operator name, ID, status (enabled/disabled), and whether or not report printing is enabled (Y/N).

Operator List				
<u>Operator Name</u>	<u>Op</u>		<u>Reports</u>	
	<u>ID</u>	<u>Status</u>	<u>Enabled</u>	<u>Privilege</u>
Joe	5	Active	Yes	
Lynn	4	Active	Yes	
Mark	1	Active	Yes	Supervisor
Mike	2	Active	Yes	Supervisor
Rushi	3	Active	Yes	

Resync with Host PC

If you are using Business Manager accounting, the Resync with Host feature removes transaction from the mailing system and resets accounts, operators and the Job ID 1 list with the default settings on the Business Manager Host PC.

If necessary, you can manually resync the accounting information on the mailing system to the settings on the Host PC.

1. Press the **Accounts** key.
2. Select **ReSync with Host**. The Resync with Host screen displays with the following warning message: "This action removes transactions! Accounts, Operators and the Job ID 1 will be reset to the settings on the Host."
3. Select **Yes** to continue. The following message displays: "*Download In Progress. Accounting information is being downloaded from Host.*" The main screen will reappear once the download is complete.

8 • Reports



<i>Introduction</i>	8-2
<i>Viewing a Report</i>	8-2
<i>Printing a Report</i>	8-2
<i>Report Print Queue</i>	8-3
<i>Single Account Report</i>	8-3
<i>Multi-Account Summary Report</i>	8-4
<i>Last Five Refills Report</i>	8-6
<i>USPS Confirmation Services Report (System Printer Required)</i>	8-7
<i>Account List Report (External Printer Required)</i>	8-8
<i>Funds Report</i>	8-8
<i>System Set Up Report</i>	8-9
<i>Error Report</i>	8-10
<i>Job Report</i>	8-11
<i>Data Capture Report (Non-US Use Only)</i>	8-12
<i>Electronic Return Receipt Report</i>	8-12
<i>Installed/Pending Rates Report</i>	8-12
<i>Last Rates Downloaded Report</i>	8-13
<i>View Download Log Report</i>	8-13

Introduction

Creating a report is quick and easy on your mailing system. With the capability to print out reports on roll tape or envelopes using the internal mailing system printer, you can easily keep an accurate record of all your mailing activities.

NOTE: The accounting reports described in this chapter are for the INVVIEW™ accounting package provided with your DM Series™ Digital Mailing System. If you are using another optional accounting package (for example, Budget Manager), refer to the documentation provided with that application.

For some reports, you need an external or attached printer. For instructions on how to set up an attached printer, refer to *Chapter 5 - Mailing System Setup, Set Up Optional Printer*, in this guide.

Each report is described in the following sections. Each section shows you the display on the screen and the information that prints out.

Viewing a Report

1. Press the **Reports** key.
2. Select the report you want to view. The report appears in the main display.

Printing a Report

You may print reports using the internal mailing system printer, or an attached external printer if one is connected to your system.

1. Press the **Reports** key.
2. Select the report you want to print. The report appears in the main display. Press **Enter**.
3. Depending on your particular system, select one of the bulleted options below.
 - If your system can only print using the internal mailing system printer: press the **Start** or **Tape** key to print on an envelope or tape.
 - If you have an external printer and your report can only print to an external printer, the system asks you to press **Enter**.
 - If you have an external printer and your report can print to an external printer or the internal printer, the system prompts you to "Select a Printer." If you want to use the attached external printer, select **Attached Printer** and press **Enter**. If you want to use the system printer, select **Mailing Machine**. Press the **Start** or **Tape** key to print on an envelope or tape.

Report Print Queue

The Report Print Queue will function with most reports, except for the Confirmation Services reports. (A warning message will appear if you attempt to print a Confirmation Services report when there are reports in the queue.)

If a series of reports are scheduled to print, the Reports Queue option will appear on the main report screen.

1. Press the **Reports** key.
2. If necessary, press the down arrow key and select **Reports Queue**. Once selected, this option will list information about the report that is currently printing, as well as a list of the reports that are remaining in the queue.

NOTE: You can cancel reports out of the queue. If the printer runs out of paper, the "Check external printer" message will appear on the main screen.

Single Account Report

The Single Account Report gives the total pieces of mail and the postage for a selected account. After you select **Single Account Report** the last account used is displayed. To view another account, press the screen key for **Select Another Account**.

If you have re-powered the system since the last time you processed mail, the "Select Account" screen displays. Use this screen to choose a specific account for the report.

Accounts can be printed even if they are inactive.

Screen Display

Single Account Report	
<Account name>	
<Subacct> <Sub-Subacct>	
Account Number	<Account Number>
Pieces	<Account Piece Count>
Postage	<Account Value Total>
> Select Another Account	

Printed Report

The Single Account Report prints on one envelope or a strip of tape. Information contained in the report:

- Date report is printed.
- Time report printed.
- Meter Stamp Serial Number: identifies the meter which printed the report.
- Account Number: Number of each account that has used postage.
- Pieces: Total of pieces processed for the account.
- Postage: Total postage amount charged to the account.
- Station ID: a user-defined number to identify the meter.

Multi-Account Summary Report

Internal Printer Version

The Multi-Account Summary supplies the total pieces and postage for all enabled accounts.

You can view and print the Multi-Account Summary report sorted by account number, as well as by account name. When viewing this report, press the left arrow key to toggle between the account name and account number sorting options.

This report can be printed on an envelope with the internal printer.

Screen Display

Multi-Account Summary		
Account	Pieces	Postage
<Account Number>	<Account Piece Count>	<Postage Value Total>
<Account Number>	<Account Piece Count>	<Postage Value Total>
<Account Number>	<Account Piece Count>	<Postage Value Total>
<Account Number>	<Account Piece Count>	<Postage Value Total>

Printed Report

- Date report is printed.
- Time report is printed.
- Meter Stamp Serial Number: identifies the meter which printed the report.
- Account Number: Number of each account that has used postage.
- Pieces: Total of pieces run for account.
- Postage: Total postage value for account; no sub total is provided for subaccounts or sub-subaccounts.
- Station ID: a user-defined number to identify the meter.
- Page numbers.

NOTE: The account name only appears on the report when you print the report on an external printer.

**External Printer
Version**

This version of the Multi-Account Summary can only be printed on an attached external printer. Account numbers are only assigned to the lowest level of the account hierarchy or transaction level. Account numbers will only appear if the account does not have subaccounts. If the account has subaccounts or subsubaccounts, account numbers will only be displayed for the lowest level account. The piece and postage totals for accounts with subaccounts displays as “Subtotal.”

Screen Display

Account Summary		
Account	Pieces	Postage
<Account name>	<Account Piece Count>	<Postage Value Total>
<Account name>	<Account Piece Count>	<Postage Value Total>

Printed Report

The Multi-Account Summary prints out on an attached printer. This report provides the following information:

- Meter stamp number.
- Date report is printed.
- Time report is printed.
- Page number.
- Station ID: a user-defined number to identify the meter.
- Number assigned to an account, subaccount, or sub-subaccount.
- Name of the account, subaccount, or sub-subaccount.
- Total of Items of mail for account, subaccount, or sub-subaccount.
- Amount of funds used in account.
- Total of funds used for each level of accounts.
- The grand total of pieces of mail.
- The grand total of the funds used.

Last Five Refills Report

The Last Five Refills Report lists the last five refills for any enabled account and prints the information on a single envelope or strip of tape. The refills are displayed in chronological order.

Screen Display

Last 5 Refills Report		
Date	Time	Amount
<Date>	<Time>	<Refill Amount>
<Date>	<Time>	<Refill Amount>
<Date>	<Time>	<Refill Amount>
<Date>	<Time>	<Refill Amount>
PbP Account: <Account>		

Printed Report

The Refill Statement provides the following information:

- Date of Refill.
- Time of Refill.
- Refill Amount: Amount of the last five refills for this particular account.
- Account No: Postage By Phone® Meter Payment System account number.
- Meter Stamp Serial Number: identifies the meter which printed the report.
- Date Printed.
- Page number of report.

USPS Confirmation Services Report (System Printer Required)

The Confirmation Services Report provides details for Confirmation Services pieces processed and uploaded via IntelliLink® Control Center. It prints the information on an envelope or strip of tape. When you select Confirmation Services from the "Select Report" screen, you can choose one of the following options:

- **View or print a specific record** - You can scroll through the uploaded records one at a time. You can print to a tape or envelope.
- **Print receipts for last batch sent** - If a tape is loaded, the system prints the receipts.
- **Print summary to attached printer** - You must have an external printer attached.

Screen Display

Confirmation Services Report	
Barcode:	
Service:	
Postage:	
Class:	
ZIP:	
Date Uploaded:	
> Print tapes for last group sent	

Printed Report: System Printer

- The report provides the following information about a piece of mail:
- Barcode or package identification code.
- Destination ZIP Code of the package.
- The Postage by Phone® Meter Payment System account number.
- Meter Serial number.
- Date and time record was uploaded via IntelliLink® Control Center.
- A fill-in space where the customer can write in the recipient and delivery address.

Printed Report: Attached Printer

The external printer version of the USPS Services Report provides the following information for each package:

- Package identification barcode.
- Amount of postage used.
- Class of mail for the package.
- Type of Special Service used.
- Destination ZIP Code.
- Date package was uploaded via IntelliLink® Control Center.

Account List Report (External Printer Required)

The Account List Report lists the names and numbers of all accounts that are set up in your mailing machine.

Screen Display

Account List	
Number	Name
<Account Number>	<Account Name>
<Account Number>	<Account Name>
<Account Number>	<subaccount>
<Account Number>	<subsubaccount>

Printed Report

This report prints a list of all your accounts and the account numbers.

Funds Report

The Funds Report gives a summary of the funds used and available in the meter, total pieces run, batch pieces and value. It prints on one envelope or tape.

Screen Display

Funds Report	
Funds Used:	<Funds Used>
Funds Available:	<Funds Available>
Total Pieces:	<Total Pieces>
Control Sum:	<Control Sum>
Batch Count:	<Batch Count>
Batch Value:	<Batch Value>

Printed Report

The Funds Report provides the following information:

- Date report is printed.
- Time report is printed.
- Meter Stamp Serial Number.
- Used: Postage funds currently spent.
- Available: Postage funds still available for processing.
- Control Sum: The total of used funds and available funds.
- Total Pieces: Total of pieces imprinted with postage.
- Batch Value: Postage spent for this batch.
- Batch Count: Number of pieces in the batch.
- Postage By Phone® Meter Payment System serial number.

System Set Up Report

The System Setup Report is an extensive report that gives you comprehensive information about your total mailing system. You can only print the entire system set up. However, the entire report must be printed on an attached printer. It provides information on:

- **Serial Numbers:**
Meter, IntelliLink® Control Center, Meter Stamps, Base, and Postal Security Device.
- **Software Versions:**
IntelliLink® Control Center, Postal Security Device, Scale Software, Rates Module.
- **Downloaded Features:**
Features, Rates, Software, Scale Capacity, Number of Uploaded Records.
- **Funds and Piece Information:**
Funds Used, Funds Available, Control Sum, Total Pieces, Batch Value, Batch Count.
- **Warning Values:**
High Value, Low Funds, Maximum Settable Value.
- **Time Settings:**
Time Zone Offset, Daylight Time Offset, Daylight Savings, Clock Drift Adjustment, Date Advance Time.
- **Advertisements:**
Advertisement ID and Name.
- **Inscriptions:**
Inscription ID and Name.
- **Accounting Set Up:**
Accounting Feature on/off, System, Passwords, Number of Accounts.
- **Modem Set Up:**
Dial Out Prefix, Dial Method, Local Number, Pitney Bowes Number, PBP Account, Initialization String.
- **Scale Settings:**
Adjustment for Motion, AutoScale, Trip Weight, Units, Origin, Location Code, AutoClear, Clear Zone If New Class, ZIP/Zone Prompt, BMC Intra ZIP, Add ZIPs to Zone), Discount Code, Min. Confirmation Service, Scale Capacity.
- **Presets.**

Error Report

This feature may be offered as a standard or optional feature and is not available on all Pitney Bowes solutions. Please contact your local account representative to determine if this option is accessible on your system.

The Error Report lists the last ten errors in chronological order with the most recent error at the top. It prints on an envelope or tape strip.

Screen Display

Error Report			
Date	Time	Location	Error ID
<Date>	<Time>	<Location>	<Error Code>
<Date>	<Time>	<Location>	<Error Code>
<Date>	<Time>	<Location>	<Error Code>
<Date>	<Time>	<Location>	<Error Code>

Printed Report

The Error Report gives the following information:

- Date report printed.
- Time report printed.
- Meter Stamp Serial Number.

The Error Report lists the following information for each error:

- Error Date.
- Error Time.
- Error Identification.
- Location: Where in the system the error occurred.
- Page Numbers.

Job Report

This feature may be offered as a standard or optional feature and is not available on all Pitney Bowes solutions. Please contact your local account representative to determine if this option is accessible on your system.

The Job Report summarizes a job that is processed in a mode that did not dispense funds. It can be printed on an envelope or tape.

Screen Display

Job Report	
<Account Name>	
<SubAccount>	<Sub-SubAccount>
Account Number	<Account Number>
Pieces	<Account Piece Count>
Job:	<Mode>

Printed Report

The Job Report gives the following information:

- Time: date printed report printed.
- Meter Stamp Serial Number: identifies the meter which printed the report.
- Station ID: A user-defined number to identify the meter.
- Pieces: Total of pieces processed for the account.
- Postage: Total postage amount charged to the account.
- Job: mode of operation.
- Account Number: Number of each account that has used postage.
- Account Name: Name of each account that has used postage.

Data Capture Report (Non-US Use Only)

The Data Capture Short Report provides information on the data that is transferred from the mailing system through Pitney Bowes Data Center to the Post Office.

The Data Capture Report prints on an envelope or tape.

Electronic Return Receipt Report

This report can be used as a firm mailing book (Form 3877) for proof of mailing for Certified Mail. A USPS clerk can round date stamp this form which can be generated after processing a batch of Certified Mail with e-Return Receipt.

Verify with your local postmaster this facsimile will be accepted in place of the actual USPS Form 3877

USPS Form 3877 Facsimile
Mixed Special Services

Customer DUNS Number: 082133393

Software Version: 15.01.01

USPS Article Number	Destination Zip Code	Postage	Special Service Type	Special Service Fee	Other Fees	Total Charge	Customer Reference
9171082133393111643017	24560	0.37	C RR	2.30 1.30		3.97	DDDDGGGGG1245
9171082133393111643024	14569	0.37	C RR	2.30 1.30	0.12	4.09	0000CVG124565
9171082133393111643031	42569	0.37	C RR	2.30 1.30		3.97	0000CV02462208
9171082133393111643048	76490	0.37	C RR	2.30 1.30		3.97	0000CV02462209
9171082133393111643055	07654	0.37	C RR	2.30 1.30	0.12	4.09	DDDDGGGGG1246
9171082133393111643062	56470	0.37	C RR	2.30 1.30		3.97	0000CV04491460
9171082133393111643079	12564	0.37	C RR	2.30 1.30		3.97	0000CVG124566
9171082133393111643086	76542	0.37	C RR	2.30 1.30		3.97	0000CVG124567
9114082133393000155138	65746	0.37	DC	0.13		0.50	
9134082133393000494330	12564	0.37	SC	1.30		1.67	
Page Totals	10	3.70		30.23	0.24	34.17	
Cumulative Totals	10	3.70		30.23	0.24	34.17	

Postal Service Certification

Total Number of Pieces Received: _____

Signature of Receiving Employee _____

Round Stamp: _____

USPS Form 3877(Facsimile)

Date: MM/DD/YYYY

Page 1 of 1

Installed/Pending Rates Report

This report displays only on the screen. Use the up and down arrow keys to

scroll through all the rate files loaded on the system.

Rate: Description (name) File Name Part Number Version Service level Effective date Active or Inactive

Last Rates Downloaded Report

This report displays only on the screen. Use this report to confirm whether you have downloaded the newest rate files prior to a Rate Change.

Screen Display

Last Rates Downloaded	
Description	Effective
USPS International Rates	E.01 2009/01/18
USPS Domestic Rates	S.01 2009/01/18

View Download Log Report

This report displays only on the screen. Use the up and down arrow keys to scroll through the list of history of files that have been downloaded.

9 • Maintaining and Updating



Contents

<i>Items to Keep On Hand</i>	9-2
<i>Cleaning the Exterior</i>	9-2
<i>Tape Maintenance</i>	9-2
<i>E-Z Seal® Sealing Solution Maintenance</i>	9-4
<i>Moistener Maintenance</i>	9-5
<i>Printer Maintenance</i>	9-11
<i>Replacing the Ink Cartridge</i>	9-13
<i>Changing the Printhead</i>	9-15
<i>Changing the Wiper Blade Assembly</i>	9-18
<i>Performing Updates or Adding Features</i>	9-19

Items to Keep On Hand

The following is a list of items you should keep on hand:

- Ink Cartridge
- Tape Roll
- E-Z Seal[®] Sealing Solution

Refer to *Chapter 11, Supplies and Options* for details on how to order these items.

Cleaning the Exterior

To clean the outside of your mailing system, wipe it off with a soft dry cloth. Do not use harsh chemical cleaners. If necessary, use only Windex[®] or soapy water.

You may clean the display screen on the IntelliLink[®] Control Center with a mild glass cleaner and soft cloth.



CAUTION: Do not pour or spray cleaner directly on the display screen or machine. Spray on the cloth and wipe the screen with the dampened cloth.

Tape Maintenance

Tape maintenance consists of installing a new tape roll.

The DM Series[™] Digital Mailing System uses adhesive tape. A red stripe appears along its edge approximately 22 inches from the end to indicate a low tape condition. Replace the tape when the stripe appears. To order new tape, refer to *Chapter 11, Supplies and Options* in this guide.



CAUTION: If you do not use Pitney Bowes supplied tape, you will not be able to determine when the tape is running out and this may cause a jam.

The red stripe on the tape notifies you that you are running low on tape. There is also a black stripe that tells the machine when it is out of tape. When the system detects the black stripe on the tape it stops the machine. At this point there is still a small amount of tape on the roll.

- If you install a new roll before the system actually runs out of tape, go to *Tape is still on roll* in this section.
- If the system runs out of tape and the message “Out of Tape” appears on the display, go to *Tape has run out* in this section.

Tape is still on roll

1. When you see the red stripe on the tape, go to the Tape Maintenance screen:
 - a. Press the **Menu** key.
 - b. Select **Maintenance**.
 - c. Select **Load Tape**.
 - d. Select **Unload Tape**.
2. If your DM Series™ Digital Mailing System does not have the optional WOW® module, open the feed cover and remove the tape roll.

If your DM Series™ Digital Mailing System has the optional Weigh-On-The-Way® (WOW®) module, open the WOW® cover.

Refer to the appropriate figure below.

Location of the tape roll under the feed cover on a DM525™ or DM575™ system without the optional WOW® module.

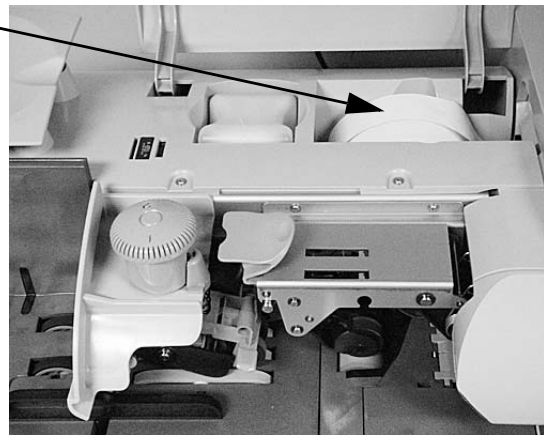

DM525™ or DM575™ Series Digital Mailing System

Location of the tape roll under the WOW® cover on a DM525™ or DM575™ system with the optional WOW® module.



DM525™ and DM575™ Series Digital Mailing System with the optional WOW® module

- Drop the new tape in so that it feeds from the bottom of the roll to the right.

The protective backing on the tape should be facing down. Pull about 10 inches of tape from the end of the roll up toward the cover and then loop it down into the slot.

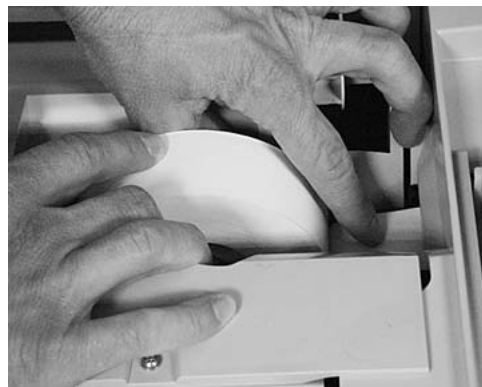

CAUTION: Do not load a tape strip that has any pink or black stripes showing. This will cause the last piece of tape to jam in the machine which and you will need to place a service call.

- From the “Out of Tape” or “Load Tape” screen, select **Load Tape**. Feed the tape into the slot while the tape motor is running. The machine automatically cuts off the excess tape.
- Close the feed cover.

Tape has run out

- If the system actually runs out of tape, the “Out of Tape” screen appears.
- Open the cover and select **Unload Tape** from the “Out of Tape” screen.
- Remove any remaining tape on the tape roll. Follow steps 2 - 4 in the *Tape still on roll* procedure above.

E-Z Seal® Sealing Solution Maintenance

Your mailing system displays a message telling you when your E-Z Seal® Solution is running low. When you receive this message, your system can still seal approximately 50 envelopes.



CAUTION: Pitney Bowes recommends using E-Z Seal® Solution because it helps keep your moistener tank clean and improves sealing efficiency. To order E-Z Seal® Solution, refer to *Chapter 11, Supplies and Options* in this guide.

- Open the feed cover and lift out the E-Z Seal® bottle. The bottle is located to the left of the tape roll.



2. Remove the cap from the bottle.
3. Add enough E-Z Seal® to bring the level up to the bottom of the fill cap.



CAUTION: Do not overfill the E-Z Seal® bottle.

CAUTION: Make sure you do not spill any solution in the tape well. If the tape gets wet, it can warp and cause a jam.

4. Replace and tighten the cap and replace the bottle. The nozzle should be facing down and the flat side of the bottle facing the front of the system.
5. Close the feed cover.

Moistener Maintenance

This section describes how to clean and/or replace the part of your mailing system that moistens the flap on the envelope. This part of the mailing system is the moistener brush assembly and consists of the moistener brush, moistener wick and moistener tank.

If the seal quality does not improve after cleaning, you can replace the wick or moistener brush as needed. To order replacements, refer to *Chapter 11, Supplies and Options* in this guide. Only a Pitney Bowes representative can install a new moistener tank.



CAUTION: Never remove the E-Z Seal® bottle and the moistener tank at the same time. This can result in E-Z Seal® leaking into the mailing machine.

Cleaning or Replacing the Moistener Brush

1. Lift the feed cover.
2. Push down on the moistener brush button.
3. Grasp the moistener brush assembly and pull it straight out towards you.

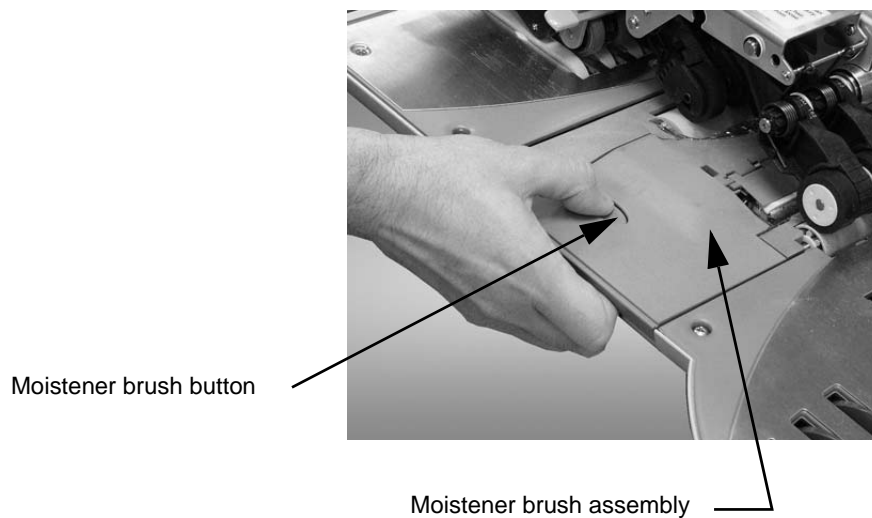

4. Clean the moistening brush by running the brush under warm water.
5. If you need to clean or replace the wick, go to *Cleaning or Replacing the Wick* procedure below. Otherwise go to step 6.
6. Replace the existing clean moistener brush assembly, or install a new one by pushing the assembly back on its track until it snaps into position.
7. Check to make sure that the flap blade of the moistener brush assembly is under (and not over) the stripper finger as shown here.

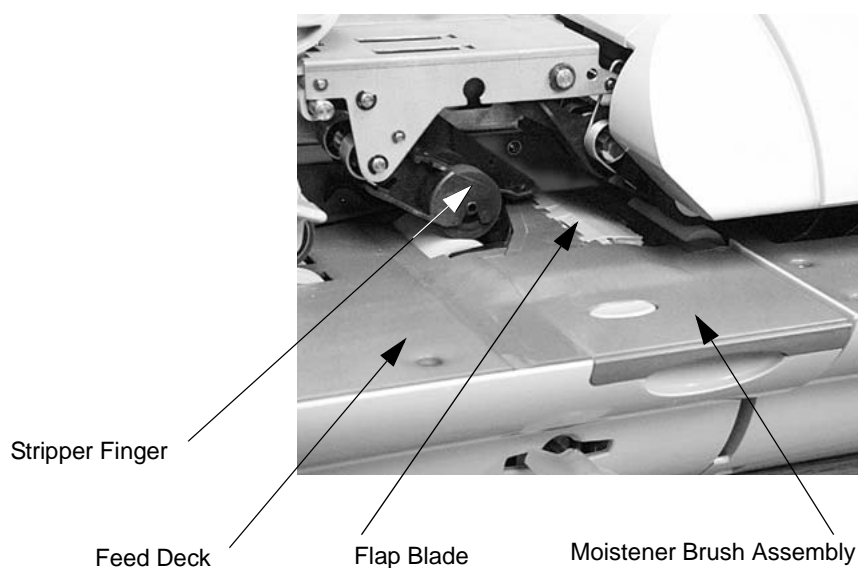

8. Verify that the moistener brush assembly is perfectly level with the feed deck.

Cleaning or Replacing the Wick

1. Open the feed cover and lift the E-Z Seal® bottle out of its holder.
2. Remove the Moistener Brush Assembly as described above in *Cleaning or Replacing the Moistener Brush* procedure.
3. Place your finger in the moistener tank round guide and pull straight out towards you.

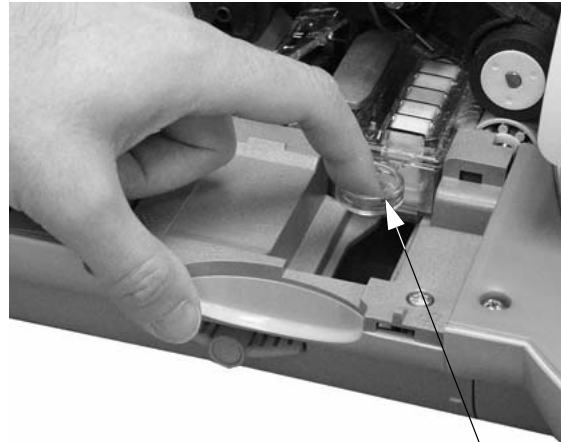

Moistener tank round guide

4. Gently lift the moistener tank up and out.

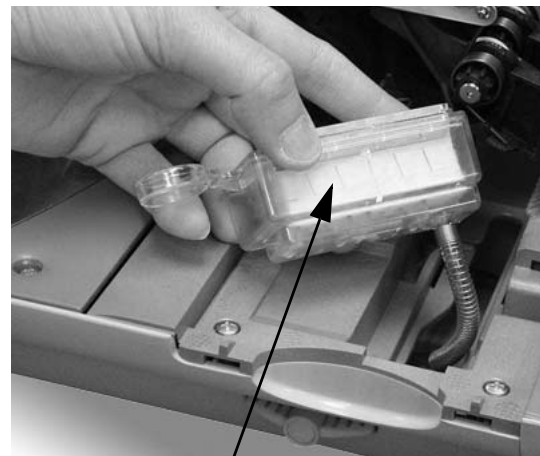

Moistener tank



CAUTION: The tank may be full of E-Z Seal® liquid

5. Remove the wick, using the metal shield to gently pry it out of the moistener tank.

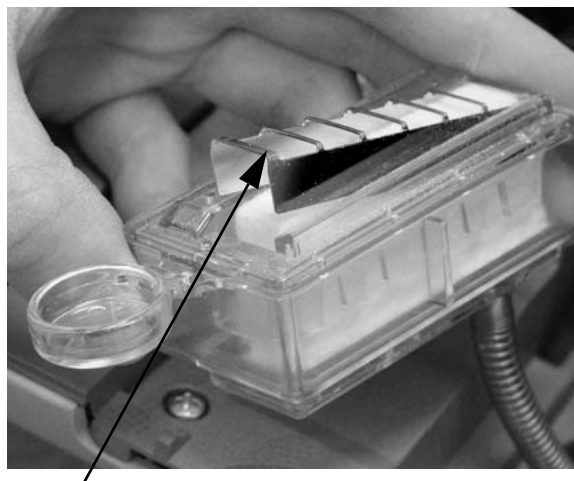

Metal shield

6. Drain the moistener tank over the front of the machine into a receptacle as shown here.



7. To clean the moistener tank, remove the E-Z Seal® Sealing Solution supply tube and wipe out the tank with E-Z Seal® solution. Clean the wick by holding it under running water.
8. Push the supply tube back onto the moistener tank nozzle. Push the tube back on as far as it will go to prevent leaking.

9. After cleaning the wick and tank, place the shield on the wick, making sure that there is no gap between the shield and the surface of the wick.

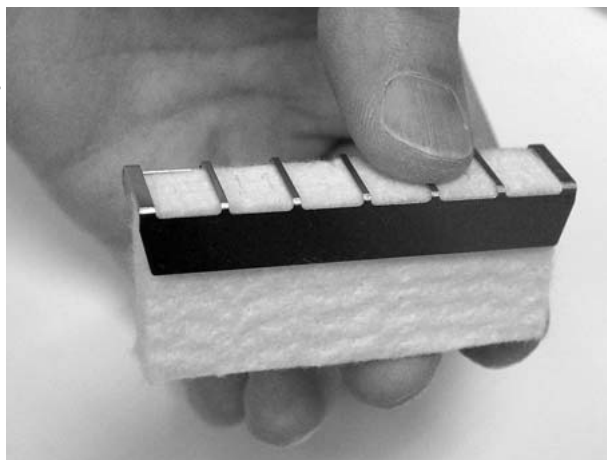

10. Place the shield and wick assembly in the moistener tank and push down on the shield to push the assembly into the tank.

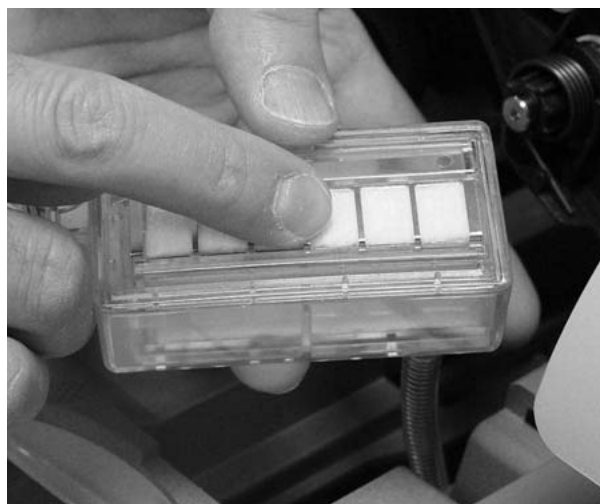

11. Replace the moistener tank and gently slide it back into the machine, taking care not to crimp the supply tubing. To measure the solution, position a ruler as shown in the picture on the right.

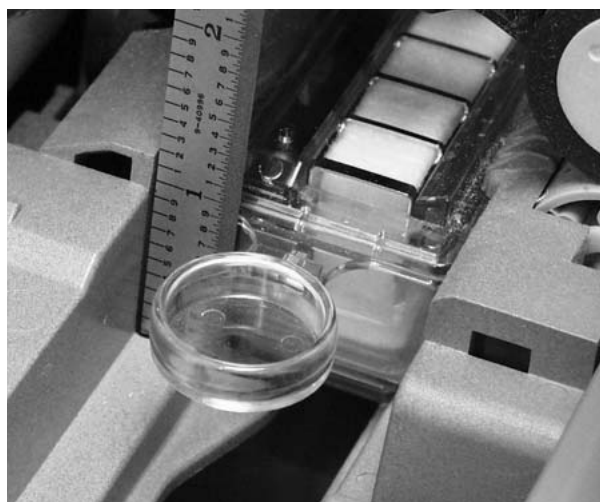

12. Replace the E-Z Seal® Sealing Solution bottle. Gently tap the top of the solution bottle. Wait for about 5 minutes and then check to make sure the moistener tank is filled with the correct amount of E-Z Seal® solution. Measure the amount of solution as shown in the diagram on the right. The solution level should be:

14-18mm(0.55-0.71 in.)

If after another 5 minutes the level is still not correct, go to step 13. Otherwise go to step 14.

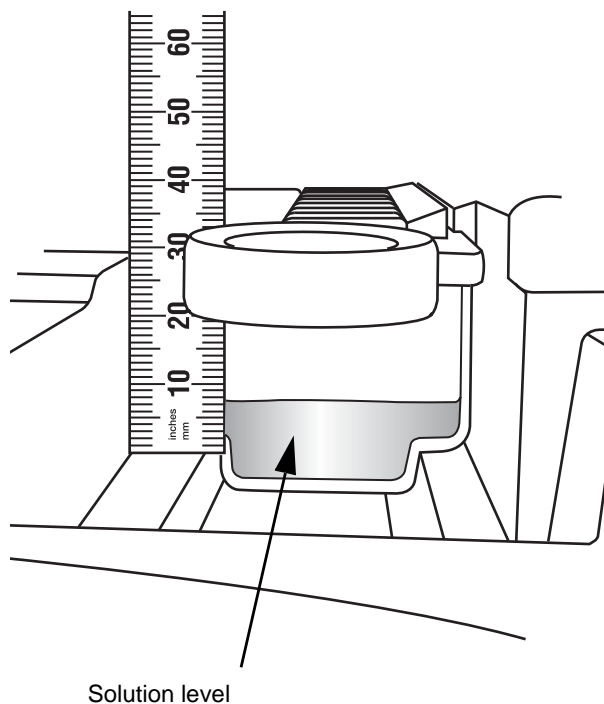

13. Remove the moistener tank and hold it as high as you can above the machine as shown in the picture on the right.

Hold it in this position for approximately 20 seconds.

a. Replace the moistener tank again and gently slide it back into the machine, taking care not to crimp the supply tubing. Do not push the tank all the way back into the machine yet.

b. Wait about 5 minutes and then check the level of E-Z Seal® Sealing solution again as described in step 12.



- c. If the tank is still not filled to the correct level, remove the moistener tank and drain it over the front of the machine, then replace the tank and check the level again after 5 minutes.
14. Once you verify that the moistener tank is filled to the correct level with E-Z Seal® Solution, gently push the tank all the way back to its original position.



Replace the moistener brush assembly by pushing it back on its track until it snaps into position. Check to make sure that the flap blade of the moistener brush assembly is under (and not over) the stripper finger as shown here.

15. Verify that the moistener brush assembly is perfectly level with the feed deck.
16. Close the feed cover.
- 17.

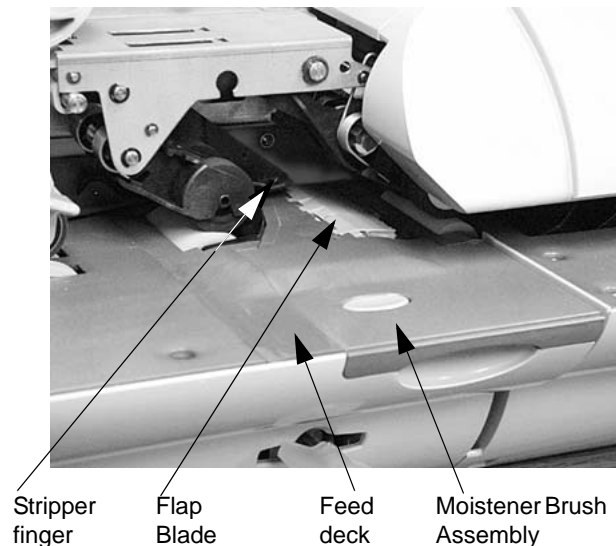

Printer Maintenance

The printer components, consisting of the printer nozzle, ink cartridge and printhead, require minimum maintenance to ensure clean, clear meter imprints on your mail.

If the print quality deteriorates and you cannot improve it with the procedures in this chapter, contact the Pitney Bowes Help Desk. Refer to the *Pitney Bowes Contact Information List* at the front of this guide for the phone number.

Printing a Test Pattern

You can print a test pattern to check the quality of the meter imprint without spending any of your postage funds.

To print a test pattern:

1. From the IntelliLink® Control Center, press the **Menu** key.
2. Select **Maintenance**.
3. Select **Print Test Pattern**.
4. The “Print Test Pattern” screen appears and prompts you to “Press Tape or print an envelope”.
5. Load an envelope on the feed deck and press **Start**, or press **Tape** to print on a tape.
6. Once the test pattern prints, the system asks you if the test pattern printed correctly.

If the test pattern looks like the sample shown here, press the **Yes, Lines are unbroken** screen key. Go to step 10.

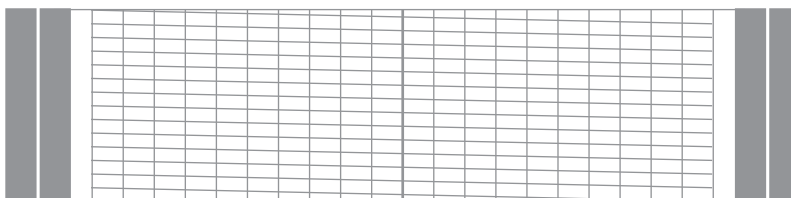

If the test pattern has missing or incomplete lines as shown here, press **No, clean the print nozzle** screen key. Go to step 7.



7. The “Cleaning Print Nozzle” screen displays until the cleaning operation completes.
8. Once the cleaning operation completes, the “Print Test Pattern” screen appears again.
9. Repeat steps 5 and 6 again. If the print pattern still has broken or missing lines, you may need to replace the ink cartridge (see *Replacing the Ink Cartridge*) or printhead (see *Changing the Printhead*).

If the test pattern is ok, go to step 10.

10. Press the left arrow key to return to the postage screen.

Cleaning the Printer Nozzle

You can clean the printer nozzle at any time by following these steps:

1. From the IntelliLink® Control Center, press the **Menu** key.
2. Select **Maintenance**.
3. Select **Clean Printer Nozzle**. The “Cleaning Print Nozzle” screen displays until the cleaning operation completes.
4. Once the cleaning operation completes, the “Print Test Pattern” screen appears.
5. Print a test pattern as described above in Printing a Test Pattern to verify that you can print a clean and clear meter stamp.
6. Repeat this operation at least one more time.

Replacing the Ink Cartridge

“Low Ink - Order Ink” appears on the IntelliLink® Control Center main screen when there is only enough ink for approximately 10 days of mailing.

You can choose to ignore this warning - refer to the *Configuring Low Ink Warning* section in *Chapter 5* in this guide.

Your actual ink usage will vary depending on whether you routinely print advertisements or inscriptions and how many pieces of mail you print per day.

“Low Ink” displays approximately two days before the ink runs out. You can print about another 300 meter stamps or leave the mailing system running for six days without printing. If you do not have a replacement cartridge, order one now. Refer to *Supplies and Options, Chapter 11* in this guide.

“Out of Ink” displays when there is no more ink left in the cartridge and your mailing system stops printing. In order to resume printing you must change the ink cartridge.



WARNING! Use Pitney Bowes ink cartridges to ensure best printer performance. Other ink cartridges may cause: poor print quality, rejected/returned mail and uncovered service expense.

WARNING! The ink in the cartridge may be harmful if swallowed. Keep new and used cartridges out of reach of children. Discard empty cartridges immediately.

WARNING! Do not remove the ink cartridge if the printhead is not installed. If the ink cartridge and printhead are removed at the same time, ink from the print supply line will flow down the tube and squirt from the needle in the ink cartridge holder out into the printer and system interior.

WARNING! Make sure there is enough room to fully lift the main cover without bumping the IntelliLink® Control Center.

To replace the ink cartridge:

1. Lift up the main cover and locate the ink cartridge lid.



Ink cartridge lid

2. Push the tab on the front of the cartridge lid. Lift the lid up and push toward the back of the machine.

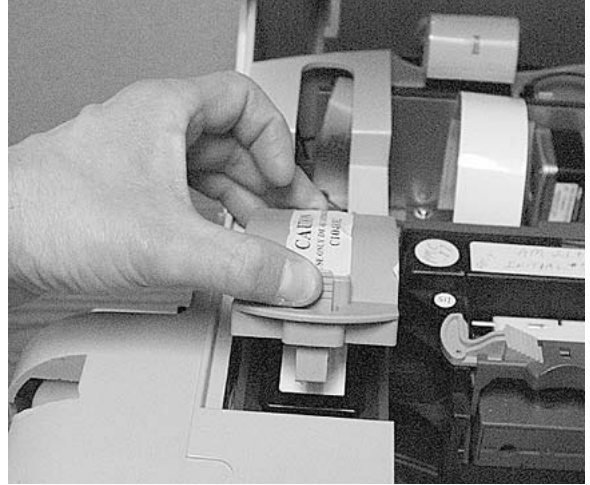

3. Remove the old ink cartridge by lifting it straight up.

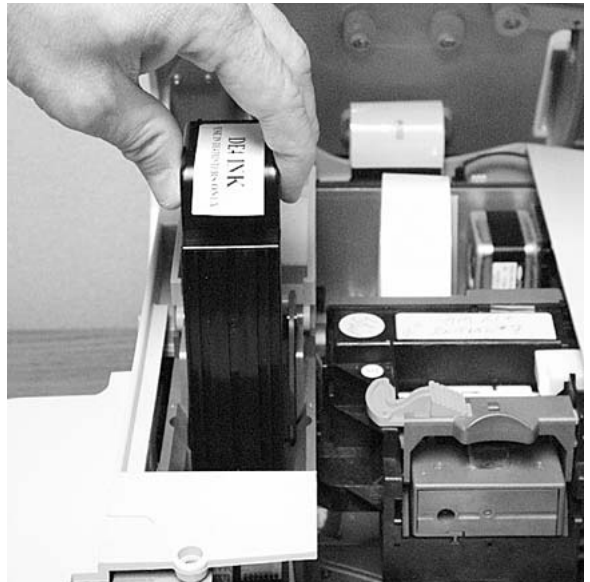

4. Insert the new cartridge with the grooved side facing you.
5. Close the ink cartridge lid and push down until it locks into place.
6. Close the main cover.
7. Print a test pattern to verify that you have installed the ink cartridge correctly (see *Printing a Test Pattern* in this chapter).

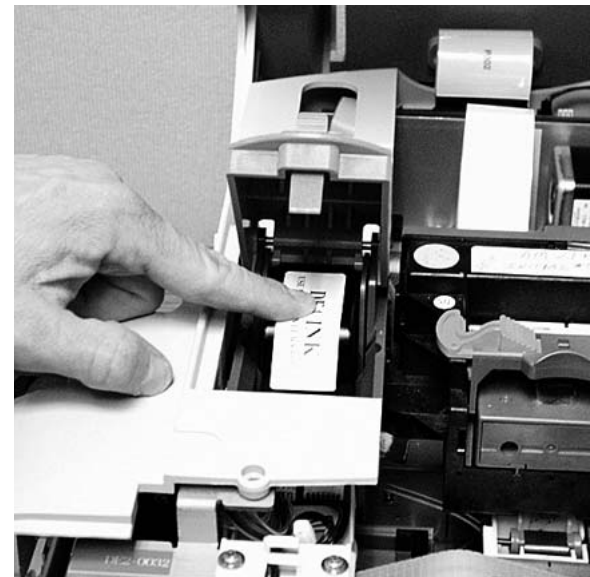

Changing the Printhead

If you have cleaned the printer nozzle and changed the print cartridge and the meter stamp is still not satisfactory, replace the printhead.



CAUTION: Do NOT attempt to clean the printhead.

Instructions for replacing the printhead are included with each replacement and are repeated here for your convenience.

1. Press the **Menu** key.
2. Select **Maintenance**.
3. Select **Replace Printhead**. The “Printhead Warning - Continue?” screen appears. Read this screen carefully since once you agree to continue, you cannot cancel the process.
4. Once you verify that you have a replacement printhead, select **Yes**, continue from the screen. The “Replace Printhead” screen appears.
5. Open the main cover and locate the printhead tab.

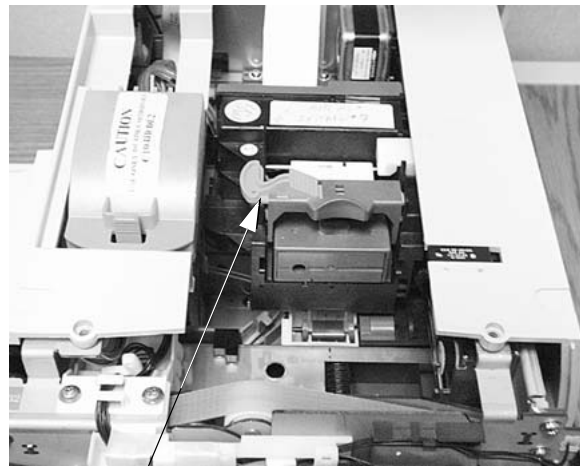

Printhead tab

6. Push the printhead tab to the left as shown here.

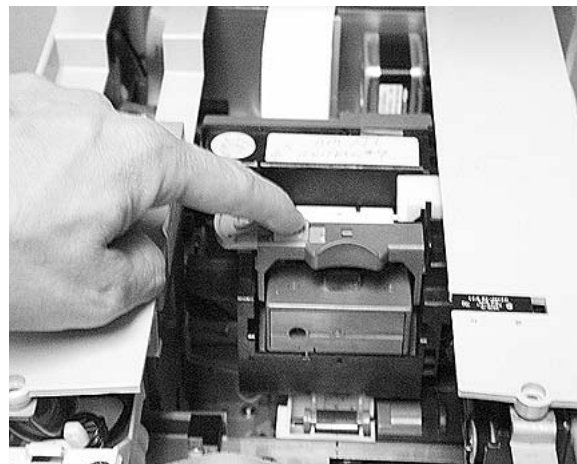

7. While continuing to press the printhead tab to the left, pull the assembly forward as shown here. This exposes the printhead cover.

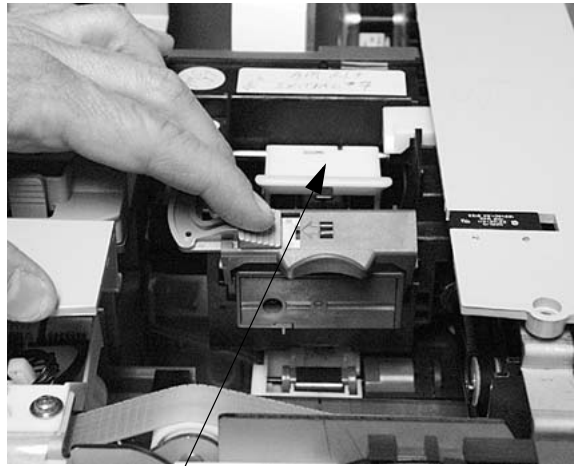

Printhead cover

8. Grasp the printhead cover and pull as shown here.

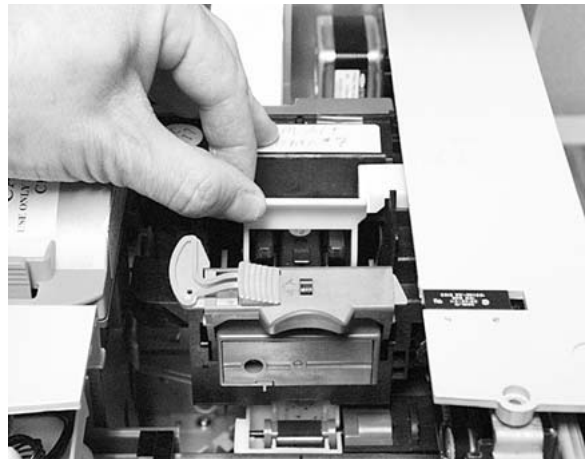

9. Locate the stand-off on top of the printhead shown here.

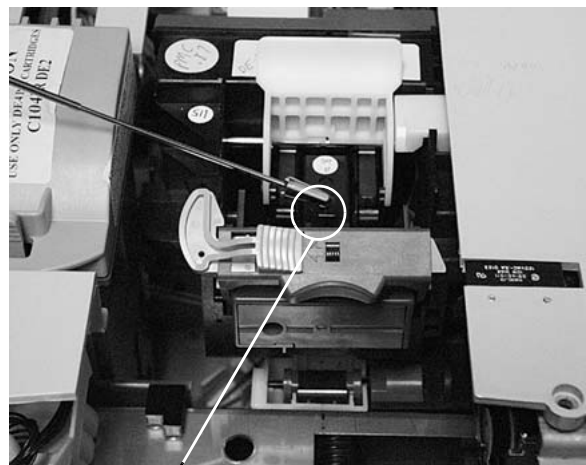

Printhead stand-off

10. Grasp the printhead stand-off and lift the printhead up and out.
11. Discard the old printhead.

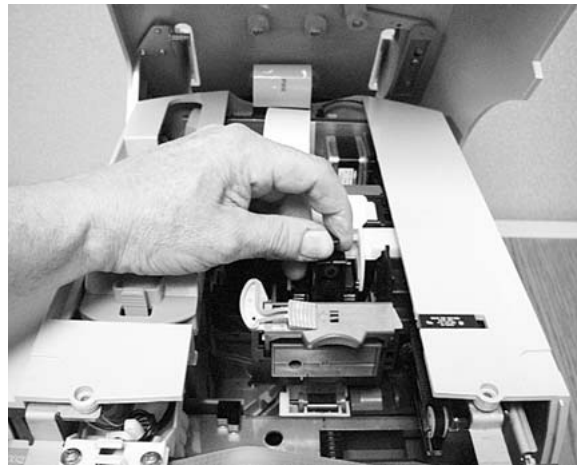

12. Locate the new printhead. Remove the orange packing tab from the new printhead as shown here.
13. Install the new printhead in the printhead slot.



14. Close the printhead cover and push the printhead tab back into place.
15. Close the main cover; the “Initializing Printhead” screen appears
16. Once the initializing is complete, the “Print Test Pattern” screen opens and prompts you to “Press Tape or print an envelope”.

You must perform the print test at this time. Follow the prompts, or refer to *Printing a Test Pattern* in this chapter for more information.

17. Proceed to *Changing the Wiper Blade Assembly* section.

Changing the Wiper Blade Assembly

When you change the printhead, you must also replace the wiper blade assembly.

Instructions for replacing the wiper blade assembly are included with each replacement and are repeated here for your convenience.

1. From the IntelliLink® Control Center, press the **Menu** key.
2. Select **Maintenance**.
3. Select **Replace Wiper Blade Assembly**.

The “Preparing Wiper Blade” screen appears. During this time, the system moves the printhead assembly back so that you can access the wiper blade assembly.

4. The “Replace Wiper Blade Assembly” screen appears instructing you to remove the wiper blade assembly from the package.

5. Lift the main cover and locate the wiper blade assembly.

6. Push the wiper blade tab toward the back of the machine. This causes the wiper blade to slide to the left.

7. Lift the wiper blade up and out of the assembly and discard.

8. Place the new wiper blade in the assembly with the two white prongs facing to the right. Slide it to the right until it snaps into place.

9. Close the main cover; the “Initializing Wiper Blade” screen appears.

9. Once the initializing is complete, the “Print Test Pattern” screen appears and prompts you to “Press Tape or print an envelope”.

10. You must perform the print test at this time. Follow the prompts, or refer to *Printing a Test Pattern* in this chapter for more information.

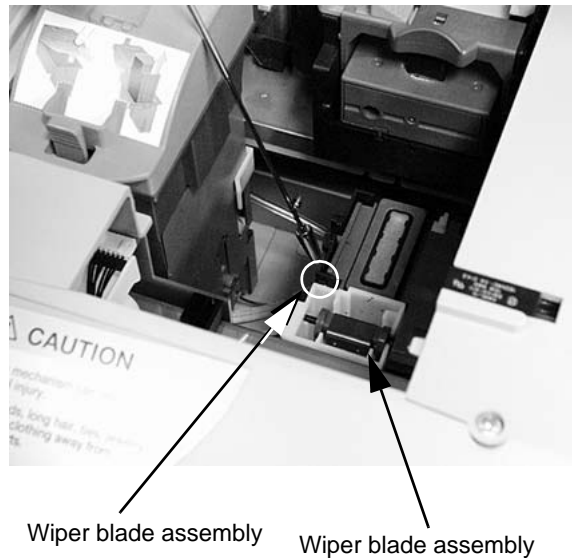

Performing Updates or Adding Features

Your IntelliLink® Control Center can remotely turn on features or download graphic files to print on envelopes. To activate a new feature, feature upgrade, or to download an envelope advertisement or inscription, you will be instructed by a Pitney Bowes representative to connect to the IntelliLink® infrastructure.

NOTE: You must first purchase a new feature and graphic before downloading it remotely.

Ensure your system is connected to a LAN or phone line as you do when refilling postage.

To initiate this process, simply follow the steps to “Get Update Now.”

1. Press the **Menu** key.
2. Select **Set Up**, then scroll down and select **Updates and Add-Ons**.
3. Select **Check for Updates**. The *Requesting Update...* screen appears.
4. Once the system has connected with Pitney Bowes, the *Software Update Available* screen appears. Select **Get Update Now**.

NOTE: You have 15 seconds to select this option. If you do not select the option within 15 seconds, the system will proceed with download process.

When the download process is complete, the system will return to the Main screen. Advertisements and inscriptions are added to the memory of your system, and will be listed on the display under *Meter Stamp Options*. New features and feature upgrades will be resident in the software capabilities of your system, and can be selected from appropriate menus.

10 • Troubleshooting



<i>How to Troubleshoot your Mailing System</i>	10-2
<i>Ink Waste Full Tray Warning</i>	10-2
<i>Envelope Sealing Problems</i>	10-3
<i>Envelope Feeding Problems</i>	10-4
<i>Tape Feeding Problems</i>	10-8
<i>Printing Problems</i>	10-8
<i>Postage Refill Problems</i>	10-10
<i>Display Problems</i>	10-10
<i>Weighing Problems</i>	10-11

How to Troubleshoot your Mailing System

This chapter contains a list of problems you may encounter while using your DM Series™ System.

Review the problems and if you are unable to find a solution, call the Help Desk or you can schedule a request for service at our web site. Refer to the *Pitney Bowes Contact Information List* at the front of this guide for the phone number of the Help Desk and the web site addresses.

Ink Waste Full Tray Warning

The Ink Waste Tray Full Warning appears when you power up or exit sleep mode on the mailing system. It indicates that the ink waste tray is approaching maximum capacity. Contact your customer service representative to schedule replacement of the ink waste tray.



WARNING! Failure to replace full inkwaste tray will result in ink leakage, causing system damage.



<p style="text-align: center;">INK WASTE TRAY FULL WARNING</p> <p>Ink Waste Tray is near full. Ink leakage may occur.</p> <p style="text-align: center;">Please contact service.</p> <p>▶ OK</p>
<p>Error: Waste Tray Full-Call Srvc</p>

Select **OK** to return to the main screen. While you can continue to process mail, the “*Waste Tray Wrng-Call Srvc*” message will appear in the main status area of the main screen until the ink waste tray is replaced. *The ink waste tray must be replaced to prevent system damage.*

The Ink Waste Tray Full Alert indicates that the ink waste tray has reached maximum capacity and must be replaced. If the Ink Waste Tray Full Alert appears, and you have not already done so, contact your customer service representative to schedule replacement of the ink waste tray.

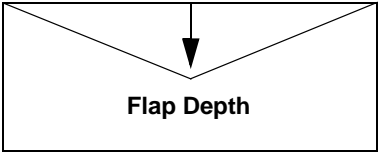
<p style="text-align: center;">INK WASTE TRAY FULL ALERT</p> <p style="text-align: center;">CONTACT SERVICE IMMEDIATELY.</p> <p style="text-align: center;">Failure to replace full ink waste tray will result in ink leakage, causing system damage.</p> <p>▶ OK</p>
<p>Error: Waste Tray Full-Call Srvc</p>

Envelope Sealing Problems		
Description	Possible Causes	Solution
Envelope(s) not sealing or not sealing properly	No E-Z Seal® Sealing Solution in the bottle, or bottle is placed incorrectly.	Remove the E-Z Seal® solution bottle and refill or reposition the bottle. Refer to the <i>E-Z Seal® Maintenance</i> section in <i>Chapter 9</i> of this guide.
	Moistener brush is dirty or worn.	Replace or clean the moistener brush. Refer to the <i>Cleaning or Replacing the Moistener Brush</i> section in <i>Chapter 9</i> of this guide.
	Envelopes are not positioned on the feed deck correctly, or side guide is out too far.	Place envelopes with the flap down on the feed deck against the rear wall. Make sure the envelopes are pushed far enough so that they cover the feed sensor on the rear wall. Push the side guide close to the envelope or stack of envelopes but not to the point where it is touching the envelopes. Leave about 1/16" clearance (the thickness of a dime).
	 <p>The diagram shows a close-up of the envelope feed deck. A 'Feed Sensor' is located on the rear wall, and a 'Side Guide' is positioned to the right. A 'CAUTION' label is visible on the rear wall. The sensor and guide are used to position envelopes correctly for sealing.</p>	
Envelope(s) not sealing or not sealing properly	Envelope flap dimensions are not within the acceptable range.	Use envelopes with flap depths between 1" and 3" (25.4 mm and 76.2 mm).  <p>The diagram shows a simple envelope with a vertical arrow pointing to the depth of the flap, labeled 'Flap Depth'.</p>

Envelope Feeding Problems		
Description	Possible Causes	Solution
More than one envelope is feeding	Too many envelopes are on the feed deck; envelopes are not stacked properly on the feed deck.	Remove some of the envelope and test with a smaller stack. Slant the envelopes slightly to the left (shingled).  Envelopes shingled to the left
	Feeder adjustment setting is incorrect. OR Envelopes are too thick or thin for the feeder adjustment setting.	Adjust the thickness adjustment knob to correspond to the envelope thickness. For thicker pieces of mail (3/8" to 5/8"), or mail containing several inserts, use the thick mail setting. For mail containing only single inserts, or for post-cards, use the normal mail setting. Thick mail setting  Normal mail setting

Envelope Feeding Problems		
Description	Possible Causes	Solution
Envelope(s) getting jammed	Trying to feed presealed envelopes with the seal mode set to Sealer On.	Press the Seal key from the control center and select Sealer off .
	You are using envelopes that have dimensions that are outside the acceptable range.	<p>Refer to the <i>Specifications</i> section in this guide for the acceptable envelope dimensions.</p> <p>To clear a jam in the feed deck:</p> <ol style="list-style-type: none"> 1. Lift the feeder cover. 2. Pull up on the top release jam lever. 3. Lift up the lower release lever. 4. Release the envelope as shown in the figure below. <div style="display: flex; align-items: center;"> <div style="margin-right: 10px;"> <p>Top Release Jam Lever</p> <p>Lower Release Lever</p> </div>  </div> <ol style="list-style-type: none"> 5. Depending on how badly the envelope is damaged, you may need to replace it. 6. Make sure the feed deck is clear and the jam release levers are down. 7. To continue processing mail, close the cover and select Start to continue from the display.

Envelope Feeding Problems		
Description	Possible Causes	Solution
Envelope(s) getting jammed (continued)	You are using envelopes that have dimensions that are outside the acceptable range. (continued)	<p>To clear a jam in the WOW® deck:</p> <ol style="list-style-type: none"> 1. Lift the WOW® cover. 2. Pull the WOW® transport jam release lever to the left. 3. Remove the envelope. 4. Depending on how badly the envelope is damaged, you may need to replace it. 5. Make sure the WOW® deck is clear and the jam release lever is down. 6. To continue processing mail, close the cover and select Start to continue from the display.





WOW® transport jam release lever

Envelope Feeding Problems		
Description	Possible Causes	Solution
Envelope(s) getting jammed (continued)	You are using envelopes that have dimensions that are outside the acceptable range. (continued)	<p>To clear a jam from the transport deck:</p> <ol style="list-style-type: none"> 1. Pull out on the transport release knob. 2. Remove the envelope. 3. If the jam occurred before the system applied postage to the envelope, the system will now print the postage on a tape. 4. Apply the postage tape to the envelope. 5. Push the transport deck back up until it snaps into position. 6. Make sure the transport deck is level with the feed deck. 7. Run a test pattern to make sure the print-head isn't damaged. Refer to the <i>Printing a Test Pattern</i> section in <i>Chapter 9</i> in this guide. <p style="text-align: center;">Transport Deck</p>  <p style="text-align: center;">Transport Release Knob</p>

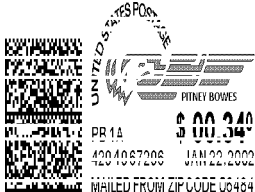

Tape Feeding Problems		
Description	Possible Causes	Solution
Tape jamming in the feeder	Adhesive is left on the leading edge of the new tap roll, or the leading edge of the tape is rolled or folded under the tape roller.	<ol style="list-style-type: none"> 1. Lift the feed cover. 2. Select Unload Tape from the screen. The system backs the tape out of the tape slot. NOTE: If the system fails to back the tape out of the slot, gently pull the tape out of the slot. 3. Cut off the portion of the tape that is rolled over or crimped. Make sure the leading edge of the tape is completely covered with the protective backing and that you have a clean straight cut. 4. Put the tape back in so that it feeds from the bottom of the roll to the right. NOTE: The protective backing on the tape should be facing down. 5. Pull about 12 inches of tape from the end of the roll up toward the cover and then loop it down into the slot. Feed the tape back into the tape slot. 6. From the "Out of Tape" screen, select Press Tape to feed tape to feed the tape through the machine. The machine automatically cuts off the excess tape. 7. Close the feed cover. 8. If this problem persists, call the Help Desk. Refer to the <i>Pitney Bowes Contact Information List</i> in this guide.

Printing Problems		
Description	Possible Causes	Solution
No postage is printing	The Postage Mode is set to Seal Only.	From the IntelliLink® Control Center, press the Mode key and select the appropriate postage mode option displayed on the screen. Refer to the <i>Selecting the Postage Mode</i> section in <i>Chapter 4</i> in this guide.
	Postal Inspection is required. Your mailing system performs an automatic postal inspection every time you do a refill. If you have not done a refill in the last 120 days, you will not be able to print postage.	Add postage. If you do not need to add postage at this time, simply log onto the Pitney Bowes Data Center and check for updates. The system will automatically perform a meter inspection.
	Your postal rate or special service requires a ZIP Code or Zone.	Enter the ZIP Code or Zone. Refer to the <i>Entering ZIP Codes and Zones</i> section in <i>Chapter 4</i> in this guide.

Printing Problems		
Description	Possible Causes	Solution
Meter imprint is out of alignment	Envelope is skewing on the feed deck.	<p>Adjust the thickness adjustment knob to correspond to the envelope thickness. For thicker pieces of mail (3/8" to 5/8"), or mail containing several inserts, use the thick mail setting. For mail containing only single inserts, or for post-cards, use the normal mail setting.</p> <p style="text-align: center;">Thick mail setting</p>  <p style="text-align: center;">Normal mail setting</p>  <p>Position the side guide close to but not touching the envelope.</p>
Meter imprint is streaked or incomplete; poor print quality: 	The printer nozzle requires maintenance.	<p>Clean the printer nozzle and run a test print as described in the <i>Cleaning the Printer Nozzle</i> action in <i>Chapter 9</i> in this guide.</p>
	You need to change the printhead and wiper blade assembly.	<p>If you have already cleaned the printer nozzle and this fails to correct the problem, you need to change the printhead and wiper blade assembly.</p> <p>Refer to the <i>Changing the Printhead and Changing the Wiper Blade Assembly</i> sections in <i>Chapter 9</i> in this guide.</p> <p>If this fails to correct the problem, call the Help desk. Refer to the <i>Pitney Bowes Contact Information List</i> in this guide.</p>

Postage Refill Problems		
Description	Possible Causes	Solution
Refill operation fails when IntelliLink® Control Center is on or off the mailing system	Phone line is not connected to an analog line or is loose.	Reconnect the phone line to the back of the IntelliLink® Control Center.
	Phone cord is damaged.	Check phone cord for damage (cuts or crimps) and replace if necessary.
	Problem with the phone line.	Test the main phone outlet and repair if necessary.
	You are using the wrong Postage By Phone® Meter Payment System telephone number.	Contact the Help Desk for correct number. Refer to the <i>Pitney Bowes Contact Information List</i> in this guide for the phone number of the Help Desk. The Help Desk may also provide you with a local number to use for Postage By Phone® System. To change the Postage By Phone® System number, refer to <i>Phone/Network Set Up: PB Phone #</i> section in <i>Chapter 5</i> of this guide.
Refill amount exceeds the funds in your account.	Check your account balance. Refer to the section <i>Checking Your Postage By Phone® Meter Payment System Account</i> in <i>Chapter 6</i> of this guide.	

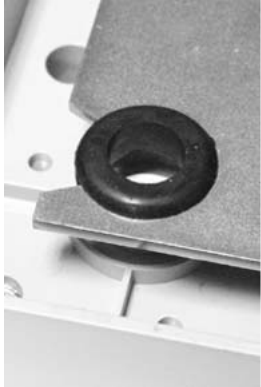
Display Problems		
Description	Possible Causes	Solution
Display is blank after moving the IntelliLink® Control Center.	There is no power to the IntelliLink® Control Center.	<ol style="list-style-type: none"> 1. Make sure the AC adapter is plugged into the back of the control center. 2. Test the outlet to make sure it has power. 3. If the problem persists, call the Help Desk. Refer to the <i>Pitney Bowes Contact Information List</i> in this guide.
Unable to access display, or keyboard does not respond.	This may be a system error.	Call the Help Desk. Refer to the <i>Pitney Bowes Contact Information List</i> in this guide for the phone number.
Difficult to read the display	You need to adjust the display contrast.	Adjust the display contrast; refer to <i>Adjusting the Display Contrast and Volume Control</i> section in <i>Chapter 5</i> in this guide. If the problem persists, call the Help Desk. Refer to the <i>Pitney Bowes Contact Information List</i> in this guide.

Weighing Problems		
Description	Possible Causes	Solution
Weight on internal scale is erratic	Possible interference.	Remove everything from the scale and turn off the power. Rezero the scale. To rezero the scale, press the Menu key, then select Zero Scale . Make sure when you place mail on the scale you center it and check to make sure that it is not touching another surface.
Weights on external scale are erratic or the scale does not return to zero	For MP Series External Weighing Platform scales: The scale top cover may not be seated properly on the scale	<ol style="list-style-type: none"> Remove the top cover and make sure the 4 plastic grommets in the scale are seated properly. The 4 plastic posts on the top cover fit into these grommets. If a grommet, or any part of a grommet, is pushed below the surface of the metal on the scale, reseal it until it appears as shown here: <div style="display: flex; justify-content: space-around; align-items: center;"> <div style="text-align: center;">  <p>Grommet seated properly</p> </div> <div style="text-align: center;">  <p>Grommet pushed below surface</p> </div> </div> Check to make sure the bubble is centered in the circle as shown on the next page. If not, and you have a flatblade screwdriver, center the bubble by adjusting the legs, otherwise go to step 4. <div style="text-align: center; margin-top: 10px;">  <p>Center the bubble</p> </div>

Weighing Problems		
Description	Possible Causes	Solution
Weights on external scale are erratic or the scale does not return to zero (continued)	For MP Series External Weighing Platform scales: The scale top cover may not be seated properly on the scale (continued)	<p>4. If you do not have a flathead screw driver, lift the corner and adjust the leg(s) until the bubble is centered in the circle.</p>  <p>5. Replace the top cover and test the scale.</p> <p>To test the scale:</p> <ol style="list-style-type: none"> 1. Place a piece of mail of known weight and correct postage on the scale. 2. Press the Mode key. 3. Select Attached Scale. "Attached Scale Mode" appears in the display 4. Press the Class key and enter a class. 5. Press the Enter key. 6. Check to see that the correct postage amount appears on the screen.
	Mail may be touching another surface or object.	Make sure you center the mail on the scale and check to be sure it is not touching any other surface or object.

11 • Supplies and Options



Contents

<i>Ordering Supplies.....</i>	<i>11-2</i>
<i>Ordering a Pitney Bowes Supply Catalog</i>	<i>11-2</i>
<i>Moistener Kits.....</i>	<i>11-2</i>
<i>Printhead and Wiper Blade Replacements.....</i>	<i>11-2</i>
<i>USPS Confirmation Services Labels</i>	<i>11-2</i>

Ordering Supplies

You can order supplies through the Pitney Bowes Supply Line™, or you can order from the Pitney Bowes web site. Refer to the *Pitney Bowes Contact Information List* at the front of this guide for the Pitney Bowes Supply Line™ phone number and the web site addresses. The Pitney Bowes web site features a wide assortment of genuine Pitney Bowes supplies at attractive prices. You can take advantage of special quantity pricing and online discounts.

Ordering a Pitney Bowes Supply Catalog

You can order a Pitney Bowes Supply Line™ Catalog. Refer to the *Pitney Bowes Contact Information List* at the front of this guide for the Pitney Bowes Supply Line™ phone number.

Consumables You Can Order

Ink Cartridges

Shelf life/installed life is 1.5 years.

Red Ink Cartridges 621-1



WARNING! Use Pitney Bowes ink cartridges to ensure bet printer performance. Other ink cartridges may cause: poor print quality, rejected/returned mail and uncovered service expense.

Tape

4" Pressure - Box of 3 rolls 610-7

5" Pressure - Box of 3 rolls 627-8

E-Z Seal® Sealing Solution

16 ounce bottles - 4 601-0

Moistener Kits

Moistener Kit: 771-0

Moistener kit includes complete stripper blade assembly with brush in holder, wick and protective grate.

Printhead and Wiper Blade Replacments

Printhead & Wiper Blade Replacement Kit: 771-1 (includes 1 printhead and 2 wiper blades)

Wiper Blade Replacement, 1 per box: 771-2

USPS Confirmation Services Labels

Delivery Confirmation Labels: 639-6

Signature Confirmation Labels: 639-9

E-Certified Labels 639-5

USPS Confirmation Services Request Book: 640-7

12 • Specifications



Contents

Dimensions and Weight..... 12-2

Electrical and Operating Conditions 12-2

Capacities and Features..... 12-3

Accounting Features 12-4

Mailing Materials 12-5

Specifications

Dimensions and Weight

Dimensions and Weigh:	DM525™	DM575™
Size (in) w/o Stacker	35L x 15H x 19W	
Size (mm) w/o Stacker	889L x 381H x 483W	
Weight (lbs)	64	66
Weight (kgs)	29	30
Size (in) with Optional WOW®	20L x 9.75H x 19.5W	
Weight (lbs) with Optional WOW®	33.5	
Weight (kgs) with Optional WOW®	15.2	

Electrical and Operating Conditions

Electrical:	DM525™	DM575™
Electrical Power Requirements VAC +/- 1 Hz	120-240	
Power Consumption:	145W	
Operating Conditions:		
Temperature Range F (C)	Min 40 (04), Max 100 (43)	
Relative Humidity	Min 8%, Max 95%	

Capacities and Features

	DM525™	DM575™
Feeder Type	Automatic with deskew	
Feeder Deck Capacity	4 inches (102 mm) for a stack of mail	
Side Guide	Yes	
Storage Fluid in Storage Tank	Enough to seal approximately 3000 pieces of mail	
Throughput Speed #10 Envelopes/min ⁽¹⁾	Up to 150	Up to 175
Throughput Speed #10 Envelopes/ min in WOW® mode (with Optional WOW® module ⁽¹⁾)	Up to 65	Up to 95
Throughput Speed Tape/min for longest meter stamp	14	
Sealing Method	Sealing with flap closed.	
EZ Seal® Fluid Sensing	Warning method for low fluid level of E-Z Seal®.	
Stacker Type	Drop Stacker	
Ink Capacity	Up to 9,300 impressions without an advertisement. Up to 4500 impressions with an advertisement. NOTE: These quantities require a minimum of 80 impressions per day.	
Internal Modem	56 Kbytes/sec	
Telephone Cord for Analog Line	26 AWG or smaller	
Optional Integrated Scale	Platform (5 or 10 lbs. capacity)	
Advertisements	Up to 10 custom advertisements plus preloaded advertisements (see <i>Chapter 4, Meter Stamp Options</i> section in this guide for a list of the preloaded advertisements).	
Inscriptions	Up to 20 custom inscriptions plus preloaded inscriptions (see <i>Chapter 4, Meter Stamp Options</i> section in this guide for a list of the preloaded inscriptions).	
Permit Mail Image	Maximum number of images is 3. Maximum identifying image name length is 15 characters. (An option you may be able to purchase. Not available on all systems.)	
(1) The actual throughput of your mailing system will vary depending on the material processed, the skill of the operator, and whether you are running in reduced speed mode. Refer to <i>Chapter 4, Running Mail</i> for information on running in reduced speed mode.		

Accounting Features

INVIEW™ Accounting	Up to 50 accounts Up to 15 operators 2 custom reports 4,000 transactions
Optional Budget Manager	Up to 3000 accounts Up to 50 operators 1-32 custom carriers 1-50 custom class/fee 1-15 custom reports 10,000 to 15,000 transactions

Mailing Materials

Envelope Dimensions (refer to the envelope measurement figure on next page)	
Minimum	3 in. x 5 in. (76.2 mm x 127 mm) postcard size.
Maximum	10 in. x 13 in. (254 mm x 330 mm) in landscape orientation. C5 envelopes can be processed when in portrait orientation.
Envelope Flap Depth (refer to the envelope measurement figure)	
Minimum	1 in. (25.4 mm)
Maximum	3 in. (76.2 mm)
Envelope Thickness	
Minimum	0.007 in. (0.2 mm)
Maximum	5/8 in. (15.9 mm)
Acceptable Envelope Materials Include:	
<ul style="list-style-type: none"> • Standard envelope paper • Self-mailers • Tri-fold mail • Pre-sealed envelopes 	
Envelope Flap Profiles:	
<ul style="list-style-type: none"> • Commercial (square and baronial) • Executive • Monarch 	
Weight of the Mail Piece	<ul style="list-style-type: none"> • 5 or 10 lbs. maximum for each piece (depending on capacity of optional scale). • 1 lb. (16 oz). for systems with optional WOW® module.
Tape Roll Width	Either 4 in. (102 mm) or 5 inches (127 mm)

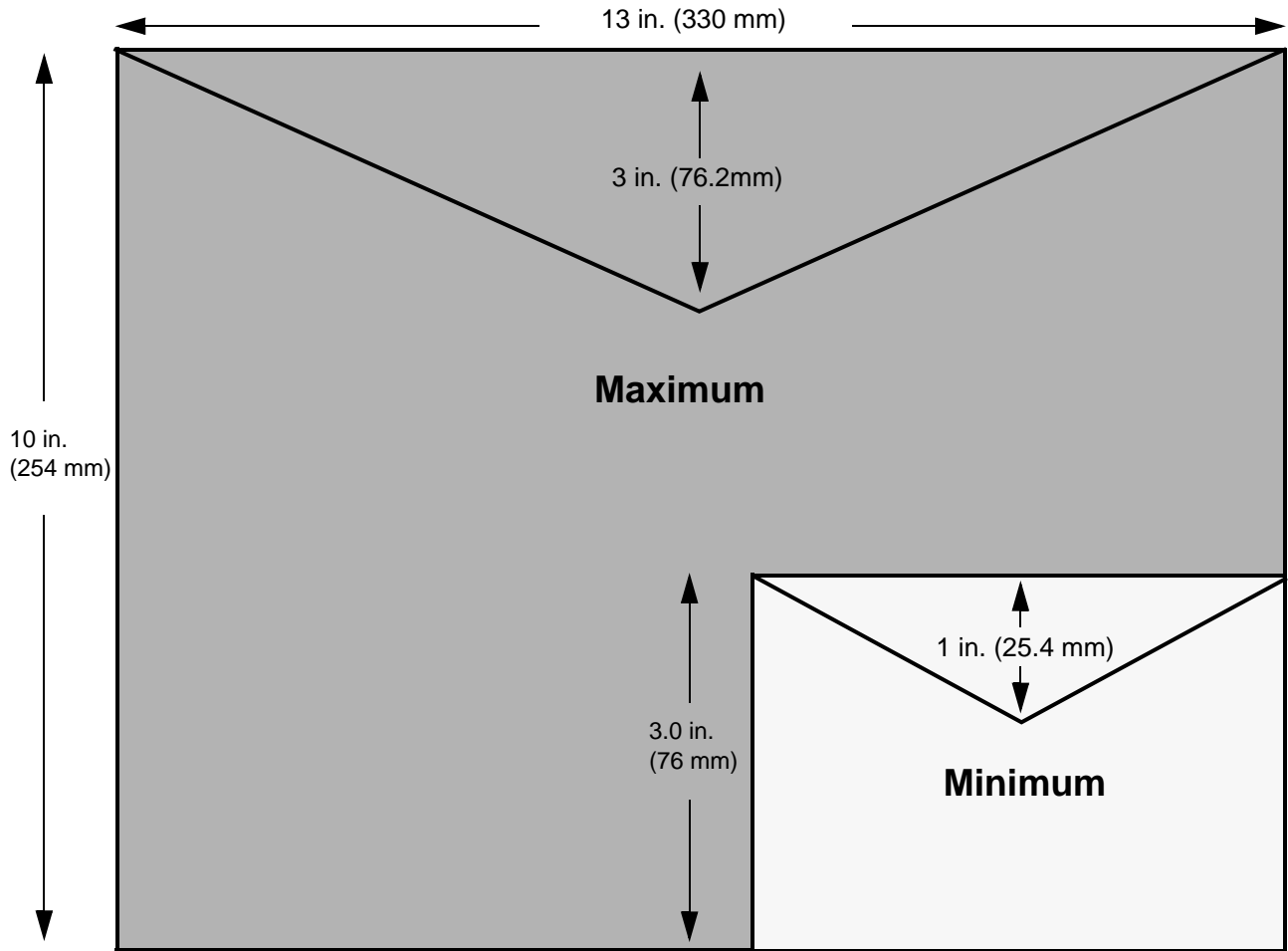

A • Glossary



Glossary

A • Glossary

Accounting	A feature of the mailing system that allows you to charge postage to individual accounts.
AccuTrac™ Mail Accounting System	A Pitney Bowes mail accounting system software application that allows you to record postage transactions to track costs so you can charge these costs to accounts or customers.
Advertisement	Advertisements contain messages and graphics you can print next to the meter stamp.
Alpha Keyboard	The part of the keyboard used to enter accounts and other set up information.
Alphanumeric Text	Text consisting of alphabetic and numerical symbols that can include punctuation marks and other conventional symbols.
Arrow keys	The keys you can use to move to new menus, scroll through menus, and select options.
Art Card Slot	This slot is on the right side of the IntelliLink® Control Center on the mailing machine and accepts the plug-in art card . The art card contains ads, inscriptions, and permits.
Barcode	A series of vertical bars and spaces that represent a correct ZIP code for the delivery address on a piece of mail.
Budget Manager	This is an optional enhanced accounting package you can acquire for your DM Series™ Digital Mailing System. It allows you to create and more accounts with higher levels of detail.
Business Manager	Business Manager is an enterprise accounting system that allows you to capture and manage postal transactions from the several different Pitney Bowes meters, mailing machines, and mailing systems. You can manage all systems from a single host PC that is running the Business Manager application.
Calibrate	The action performed which sets the scale at zero in order to assure accuracy.
Carrier	The service that delivers your mail such as the USPS or Federal Express.
Certified Mail	Certified Mail is a service offered by the United States Postal Service® for a fee in addition to postage. Sending Certified Mail provides a delivery record that the Postal Service maintains for a period of two years. For additional Certified Mail options, see Return Receipts or Restricted Delivery in this glossary.
Certified Mail Rates	Please refer to the USPS web site at www.usps.com for rates.
Class Key	Enables you to select the correct class for your mailing (e.g. First Class, Priority, Express Flat Rate).
Clear Key	Press to clear an entry or if no data has been entered press to take you to the previous screen.
Communications Port	Place to connect an optional Pitney Bowes scale, printer, or a PC.
Control Center	The IntelliLink® Control Center is the module mounted on top of the mailing machine that contains the graphic display, function keys, alpha, and numeric keys and the Postal Security Device (PSD).
Data Exchange	Importing account information to a program on your PC.

Delivery Confirmation	<p>Delivery Confirmation is a service offered by the United States Postal Service® that allows you to verify the date and time of delivery of your mail or, if the delivery was unsuccessful, the date and time of the delivery attempt. The service is currently available for Priority Mail and Package Services, which includes Parcel Select, Parcel Post, Bound Printed Matter, Special Standard Mail and Library Mail.</p> <p>You may combine Delivery Confirmation with other services such as COD, insured mail, registered mail, parcel airlift (PAL) or special handling.</p> <p>There is no charge for Delivery Confirmation when you ship by Priority Mail and provide an electronic file to the Postal Service. There is a per piece charge when you ship Package Services using the electronic option. To get the latest fees, go to www.usps.com and search for "Delivery Confirmation".</p>
Differential Weighing	<p>The weighing mode that allows you to put all of the mail on the scale, then remove each piece one at time. As you remove each piece, the system calculates the weight and prints postage (either on envelopes or tapes). This saves time by eliminating the need to place each piece individually on the scale.</p>
Error Message	<p>An indication that notifies the operator of a disabling event (i.e, out of ink).</p>
External Device Port	<p>A plug on the machine that allows you to connect an optional external device, such as a scale or a PC.</p>
E-Z Seal® Sealing Solution	<p>The envelope moistening solution you can order from the Pitney Bowes Supply Line™.</p>
Feed Deck	<p>The area of the mailing machine where you feed the envelopes.</p>
FIM (Facing Identification Mark)	<p>A series of five or six vertical bars used by automated postal equipment to identify, orient, and separate reply mail.</p>
Funds	<p>The amount of money in your Postage meter (Postal Security Device - PSD).</p>
Funds Key	<p>Press to get information about funds used in a job, add funds to your meter, enter new refill amounts or get Postage By Phone® Meter Payment System balance.</p>
High Value Warning	<p>A warning that you have entered a postage value above the value that you have entered into the system as your maximum allowable amount. This feature prevents you from accidentally printing more postage than you need.</p>
Indicia	<p>See Meter Imprint.</p>
Ink Cartridge	<p>Cartridge containing the ink used to produce the meter stamp.</p>
Inscription	<p>An optional message, such as "First Class" or "Non-Profit," that prints vertically to the immediate left of the postage imprint.</p>
Inspection	<p>A meter check required by the USPS.</p>
Insufficient Funds	<p>A warning message that alerts you when you attempt to use more postage than is currently in your Postage Meter (Postal Security Device - PSD).</p>
IntelliLink® Control Center	<p>See Control Center.</p>
Jam Release Lever	<p>Relieves the tension along the feeder path.</p>

Lock Code	A code that locks the mailing system with a four digit password preventing unauthorized use of your meter.
Low Funds Warning	You may set your machine to warn you when your funds go below a specified amount.
Menu Key	Press to view the main settings and options available.
Meter	See Postal Security Device.
Meter Imprint (or Meter Stamp)	Postage stamp printed directly on a piece of mail or tape using a meter device in place of traditional glue or adhesive affixed stamps. This type of postage requires a special form of indicia called an "information based indicia" (IBI). The US Postal Service's IBI Program (IBIP) is the program that makes printing of postage by a meter device possible.
Mixed Mail	Mail consisting of varying lengths and widths.
Mode Key	Press to choose from a variety of mail processing modes.
Modem	That part of the mailing system that dials the Pitney Bowes Postage By Phone® Meter Payment System center and transfers information over the phone.
Numeric Keys	The part of the IntelliLink® Control Center that you use to enter amounts and numbers.
Password	See Supervisor Password.
Permit	A permit is a special postal mark used instead of the usual meter stamp imprint. You open a permit account at the Post Office. These permits provide you with special processing or discount rates.
Postage by Phone® System	The Pitney Bowes system that allows you to purchase postage over the phone line.
Postage Meter	See Postal Security Device.
Postal Security Device (PSD)	The PSD contains the funds and performs all of the calculations necessary to print meter stamps that comply with the latest USPS standards. The PSD is contained in the DM Series™ Digital Mailing System IntelliLink® Control Center.
Postage Tape	Tape on which reports or meter stamps are printed when a piece of mail is too large or small, or too fragile to run through the mailing system.
Presets	A combination of mailing system settings you create and name so that you can call them up as a named preset thereby eliminating the need to enter each setting whenever you use this combination of settings.
Printer Nozzle	The mechanism in the print engine that sprays the ink onto the envelope or tape.
Prompt	A displayed message requesting you to respond to a choice, condition, or action.
Quick Refill	This refill repeats the same amounts of the previous refill.
Rate update	Changing of the postal rates by the USPS.
Reports Key	This key allows you to view a or select a report to print.

Return Receipts	A return receipt for Certified Mail serves as a legal document proving the date and time when the recipient took possession of the piece of mail. You fill out a return receipt postcard and the Postal Service sends the green return receipt postcard back to you, the sender.
Restricted Delivery	Restricted Delivery for Certified Mail requires your USPS carrier to deliver only to the person you specified. This person must sign for the mail.
Screen Keys	The five keys directly to the left of the display screen that allow you to select options from the menus displayed on the screen.
Seal Key	Press if you want to seal your envelopes without applying postage.
Shape Based Rating	Shape based rates are USPS® rates that are based on the weight and dimensions (thickness, length, width) of the mail piece. All new DM Series™ mailing systems have been updated to support this rating structure.
Shingle	A way to arrange pieces of mail in stepped positions for feeding, so that the mail is accepted one at a time.
Side Guide	The moveable guide at the front of the feed deck used to stabilize the envelope position when feeding it.
Signature Confirmation	<p>A signature proof of delivery service which provides mailers with the signature and text name of the recipient, along with the date, time, and ZIP Code that is provided with Delivery Confirmation. Actual signatures can be easily obtained from the USPS via fax or mail. This service meets the needs of mailers who require a signature for high-value shipments, legal requirements, or who are specifically concerned with avoiding fraud. For security purposes, digital signatures are not publicly displayed on the web site.</p> <p>Signature Confirmation may be combined with special services. To get the latest fees, go to www.usps.com and search for "Signature Confirmation".</p>
Sleep Timer	The mode that the mailing system automatically enters after a certain period of inactivity.
Stacker	The holder at the end of the feeder path where mail is deposited. Two types of stackers are available: tabletop drop-stacker and power-stacker.
Supervisor Password	Code that restricts access to certain mailing system operations.
Tape Exit	Location where the tape comes out of the right side of the mailing system.
Test Pattern	The pattern printed during a test to show the clarity of the meter imprint.
Thickness Adjustment Knob	Adjusts the tension to accommodate the thickness of the pieces of mail you are feeding.
Tyvek®	A plastic material used for envelopes.
USPS	The United States Postal Service.
Weigh-On-The-Way® (WOW®)	A mail weighing mode that weighs mixed mail as it passes along the feed deck and applies the appropriate postage.
Wiper Blade	Part of the printing assembly that wipes excess ink off the printhead.
ZIP Code	A ZIP Code is a numeric code used by the USPS to identify general and specific geographic areas in the United States.

ZIP+4 Code

A 9-digit numeric code incorporating the original 5-digit ZIP Code, a hyphen, and 4 additional digits. The first 5 digits identify the delivery office. The 4-digit add-on identifies specific delivery segments.

A

AC adapter
connector location **2-15, 6-5**

Accessories
description **2-5**
ordering **2-5, 11-2**

Account speed code list report **7-32**

Accounting and Reporting **2-4**

Accounting set up report **7-31**

Accounts
checking Postage By Phone balance **6-6**
deselecting **4-17**
overview **2-4**

Accounts (INVIEW™)
account structure **7-13**
clearing account data **7-9**
creating accounts **7-14**
adding a subaccount **7-14**
adding a subsubaccount **7-14**
deleting an account **7-15**
enabling operator passwords **7-10**
enabling operators **7-10**
reporting options
including active/inactive accounts **7-9**
including zero values **7-9**
reports **7-23**
account list **7-32**
account speed code list **7-32**
account summary **7-30**
accounting set up **7-31**
custom **7-26**
operator list **7-33**
quick profile **7-31**
report macros **7-24**
report print queue **7-24**
transaction log **7-28**
weight break account/class **7-29**
weight break carrier/class **7-29**
weight break job ID/class **7-30**
selecting an account to print postage **4-17**
by name **4-18**
by speed code **4-18**
selecting Job ID requirements **7-8**
setting the station ID **7-8**
turning weight breaks on/off **7-8**
using Seal Only mode **7-17**
using Time Date Stamping mode **7-16**
viewing or editing an account **7-15**

Accounts key
location **2-12**

Adding funds to your postage meter **6-7**

Advance Date
storing in a custom preset **4-21, 5-25**

Advertisements

selecting **4-21**

Alpha keyboard
description and location **2-13**

Arrow keys
description and location **2-12**
on the main screen **4-2, 5-2**

Art card
description and location **2-6**

Attached scale
when to use **4-5**

Attached scale - autotape mode
how to use **4-14**

Attached scale mode
when to use **4-4, 4-14**

Auto Refill Amount **6-8**

B

Barcode scanner
configuring **5-31**

Barcodes
using for USPS Confirmation Services **4-24**

Batch count
clearing or resetting **4-33**
location on main screen **2-14**

Batch surcharge **7-6, 7-17**

Budget Manager
description **2-4**

C

Catalog
ordering a Pitney Bowes Supply catalog **11-2**

Class
selecting a Smart Class **4-20**
selecting class, carrier, special services **4-19**

Class key
description and location **2-12**

Cleaning
exterior of the mailing machine **9-2**
moistener brush **9-6**
moistener wick **9-7**
printer nozzle **9-8**

Clear key
description and location **2-13**

Communications
location of ports **2-9**
options **2-3**

Connectors
mailing machine base **2-9**
on IntelliLink Control Center **2-15**

Correcting postage **4-32**

Correcting the postage date **4-33**

Cover
feeder **2-7**
printer **2-6, 2-7**
WOW cover **2-6**

Custom preset key

Index

- description and location **2-12**
- Custom presets key
 - how to define preset values **5-24, 5-26**
- D**
- Date
 - advancing the date **5-5**
 - changing postage date **4-33**
 - selecting date options **4-21**
 - setting date options **5-5**
- Daylight saving
 - setting up **5-5**
- Deleting
 - operators **7-12**
- Dialing prefix **5-16**
- Differential weighing
 - how to use **4-12**
 - when to use **4-5**
- Discount codes **5-11**
- Discounts **7-6**
- Display
 - adjust the contrast **5-4**
- DJPS/DMPS Power Stacker **2-3, 2-6, 4-11, 4-12, 4-13, 4-14, 4-15, 4-19**
- E**
- Editing
 - operators **7-12**
- Electronic Return Receipt (ERR) **4-26**
 - Off-line **4-31**
 - using ERR with a Customer Reference Number **4-30**
- Enabling
 - operator passwords **7-10**
 - report printing **7-11**
- Enter key
 - description and location **2-12**
- Envelopes
 - acceptable dimensions **12-5**
- Error report **8-10**
- E-Z Seal
 - ordering **11-2**
- E-Z Seal bottle
 - description **2-10**
 - location **2-10**
- E-Z Seal®
 - adding more solution **9-4**
- F**
- Features
 - adding new features **9-15**
- Feed cover **2-6**
 - WOW **2-6**
- Feed deck
 - optional WOW™ location **2-11**
- Funds
 - setting the high value warning **5-19**
 - setting the low value warning **5-19**
- Funds key
 - adding postage **6-7**
 - check Postage By Phone **6-6**
 - checking available funds **6-6**
 - clear batch number **4-33**
 - description and location **2-12**
- Funds report **8-8**
- G**
- Global discounts **7-6**
- Global surcharges **7-6**
- H**
- Help
 - Postage By Phone **6-2**
- Help key
 - description **2-12**
- High funds warning
 - description **5-19**
 - setting up **5-19**
- I**
- Ink cartridge
 - location **2-11**
 - ordering **11-2**
 - replacing **9-9**
- Inscriptions
 - included with the system **4-22**
 - selecting **4-22**
- Inspections
 - required by USPS **6-2**
- IntelliLink Control Center (ICC)
 - definition **2-2**
 - keys **2-12**
- IntelliLink Control Panel (ICC)
 - location **2-6**
- J**
- Jam release levers
 - description and location **2-10, 2-11**
- Jams
 - clearing envelope in feed deck **10-5**
 - clearing envelope jams in the feed module **10-5, 10-6, 10-7**
 - clearing jams in the WOW™ module **10-6**
 - clearing tape jams **10-8**
- Job ID
 - autoclearing at end of transaction **7-9**
 - requiring to run mail **7-8**
 - selecting **7-18**
- K**
- Keep track marker **2-14**
- Key in postage mode
 - how to use **3-3, 4-11**
 - when to use **4-4**
- L**
- LAN Firewall Settings **5-18**

- Language
 - options **5-4**
 - select **5-4**
- Loading a tape roll **9-2**
- Lock button
 - description and location **2-12**
- Low Funds Value **6-7, 6-8**
- Low funds warning
 - description **5-19**
 - setting up **5-19**
- M**
- Mail
 - acceptable mailing materials **12-5**
 - preparation **3-2**
 - quick setup and start **3-2**
 - selecting the postage mode **4-10**
 - tips for feeding mail **4-8**
- Mail Machine Interface (MMI) **2-3**
- Mailing materials **12-5**
- Mailing system
 - description of components **2-6**
- Maintenance
 - cleaning the exterior **9-2**
 - cleaning the printer nozzle **9-8**
 - moistener **9-5**
 - adjusting the wetness **9-7**
 - cleaning or replacing the wick **9-7**
 - cleaning/replacing the brush **9-6**
 - moistener brush assembly **9-5**
 - printing a test pattern **9-7**
 - replacing the E-Z Seal **9-4**
 - replacing the ink cartridge **9-9**
 - replacing the printhead **9-11**
 - replacing the tape **9-2**
 - replacing the wiper blade assembly **9-14**
- Manual transactions **7-18**
- Menu key
 - description and location **2-12**
 - using to change elements on mail **4-21**
- Meter stamp
 - change the elements of **4-21**
 - on the main screen **2-14**
- Meter, *see Postage meter*
- Mode key
 - description and location **2-12**
 - using to select postage mode **4-10**
 - when running mail **3-3**
- Modem
 - selecting dialing sound **5-17**
 - setting up **5-16**
- Moistener
 - priming **9-5**
- Moistener brush assembly
 - adjusting wetness **9-7**
 - cleaning/replacing the brush **9-6**
 - cleaning/replacing the wick **9-7**
- Moistener kit
 - ordering **11-2**
- N**
- Navigating hints
 - running mail **4-2**
 - setting up the mailing system **5-2**
- Normal preset key
 - description and location **2-12**
 - how to set up **5-22**
- Normal preset timeout **5-21**
- O**
- Off-line Electronic Return Receipt (ERR) **4-31**
- On/off switch
 - description and location **2-6**
- Operator passwords **7-10**
- Operators
 - access level **7-11**
 - activating/deactivating **7-11**
 - deleting **7-12**
 - editing **7-12**
 - enabling **7-10**
 - operator list report **7-33**
 - viewing **7-12**
- Ordering
 - E-Z Seal **11-2**
- Ordering supplies **11-2**
 - ink cartridges **11-2**
 - tape **11-2**
- P**
- Password
 - protecting mail operations **5-6**
 - setting up supervisor **5-6**
 - turning on/off for operators **7-10**
- Per piece surcharge **7-6, 7-17**
- Per transaction percentage surcharge **7-6, 7-17**
- Per transaction surcharge **7-6, 7-17**
- Permit
 - defined **2-5**
 - selecting **4-15**
- Pitney Bowes Supply Line™ **2-5**
- Postage By Phone
 - automated postage refill **6-7**
 - checking funds in account **6-6**
 - checking funds in postage meter **6-6**
 - entering the number to dial **5-17**
 - setting up your account **5-16**
- Postage date
 - changing **4-33**
- Postage funds
 - adding to postage meter **6-7**
 - automatically adding funds **6-7**
 - checking account **6-6**

Index

- Postage meter
 - adding funds **6-7**
 - automatically adding funds **6-7**
 - description **2-2**
 - USPS inspections **6-2**
- Postage modes
 - attached scale **4-5**
 - attached scale - autotape **4-5**
 - differential weighing **4-4, 4-5, 4-11, 4-12**
 - key in postage **4-5, 4-11**
 - manual weight entry **4-5**
 - seal only **4-5, 4-15**
 - time and date stamp **4-5**
 - weigh first piece **4-12**
- Postage tape
 - description **2-10, 2-11**
 - location **2-10, 2-11**
 - location in option WOW™ module **2-11**
 - printing **3-4**
 - specifications **12-5**
 - when to use **3-4, 4-9**
- Postal Security Device **2-2, 6-2**
- Power stacker
 - optional DJPS **2-3, 2-6, 4-11, 4-12, 4-13, 4-14, 4-15, 4-19**
- Presets
 - custom presets **5-24, 5-26**
 - normal preset **5-23**
- Priming the moistener **9-5**
- Printer
 - adding optional attached **5-30**
 - attached (external) **8-2**
 - cleaning the printer nozzle **9-8**
 - location of USB connector **5-30**
 - maintenance **9-7**
 - printing a test pattern **9-8**
- Printhead
 - location **2-11**
 - ordering a replacement **11-2**
 - replacing **9-11**
- Printhead carriage
 - location **2-11**
- Printing
 - transaction receipts **7-22**
- Printing postage
 - on envelopes **3-3**
 - on tapes **3-4**
- Q**
- Quick Profile Report **7-31**
- R**
- Rates
 - adding ZIPs to zero zone **5-11**
 - how to select for your scale **5-7**
 - setting up discount codes **5-11**
- Reduced speed mode
 - how/when to use **4-8**
- Report Print Queue **8-3**
- Reports
 - account list **8-7, 8-8**
 - custom **7-27**
 - data capture **8-12**
 - data capture (non US only) **8-12**
 - error **8-10**
 - funds **8-8**
 - installed or pending rates **8-12**
 - job **8-11**
 - last 5 refills **8-6**
 - last rates downloaded **8-13**
 - multi-account summary **8-4**
 - operator list **7-33**
 - quick profile **7-31**
 - single account **8-3**
 - system setup **8-9**
 - USPS confirmation services **8-7**
 - weight break carrier/class **7-29**
- Reports key
 - description and location **2-12**
- S**
- Safety requirements **1-3**
- Safety requirements for power stackers **1-5**
- Scales
 - password protecting setup **5-6**
 - procedures for setting up **5-7**
 - setting up ZIP code prompt **5-10**
 - setting up Zone prompt **5-10**
 - weighing problems **10-11**
- Screen keys
 - description **2-12**
- Seal key
 - when running mail **4-8**
- Seal Only mode
 - using with INVVIEW™ accounting **7-17**
- Seal only mode
 - how to use **4-15**
- Shape Based Rating **2-5, A-5**
- Side guide
 - adjusting for mail **3-3, 4-6**
- Smart Class
 - selecting **4-20**
 - setting up **5-12**
- Specifications
 - accounting features and options **12-4**
 - electrical **12-2**
 - mailing materials **12-5**
 - mailing system features and capabilities **12-4**
 - operating conditions **12-2**
- Speed codes
 - speed code list report **7-32**

- Stacker
 - definition **2-6**
- Standby mode **5-20**
- Supplies
 - ordering **11-2**
- Surcharges
 - batch **7-17**
 - global **7-6**
 - per piece **7-6**
 - per transaction **7-6**
 - per transaction percentage **7-6**
- T**
- Tape
 - installing **9-2**
 - ordering **11-2**
- Tape key
 - when printing tapes **3-4**
- Time Date Stamping Mode
 - using with INVIEW™ accounting **7-16**
- Timeouts
 - display sleep **5-20**
- Transactions
 - action to take when the log is full **7-21**
 - clearing the transaction log **7-20**
 - entering manual **7-18**
 - printing transaction receipts **7-22**
 - transferring account data **7-20**
 - transferring transaction data **7-20**
 - viewing the transaction log **7-19**
- Troubleshooting
 - display problems **10-10, 10-11**
 - weighing problems **10-11**
- U**
- Updates
 - performing **9-15**
- Using ERR with a Customer Reference Number **4-30**
- USPS Confirmation Services
 - ordering labels **11-2**
- USPS confirmation services
 - using barcodes **4-24**
- W**
- Warnings
 - configuring high and low fund warning **5-19**
 - configuring low ink warning **5-19**
 - high value warning **A-3**
 - ink waste full tray **10-2**
 - insufficient funds **A-3**
 - low funds warning **A-4**
 - main screen display area **2-14**
 - replacing ink cartridges **9-9, 11-2**
 - report showing warning values **8-9**
 - safety **1-3**
 - using postage tape **3-4, 4-9**
 - USPS inspection due **6-2**
 - when changing the printhead **9-11**
 - when using WOW **4-11, 4-12**
- Weigh First Piece
 - using **4-12**
- Weighing mail
 - using Weigh First Piece **4-12**
 - using WEIGH-ON-THE-WAY™ **4-11, 4-12**
- Weighing problems **10-11**
- WEIGH-ON-THE-WAY™
 - using **4-11, 4-12**
- WEIGH-ON-THE-WAY™ Module **2-6**
- Weight
 - on the main screen **2-14**
- Weight breaks
 - turning on/off **7-8**
- Wick
 - cleaning and replacing **9-7**
- Wiper blade
 - ordering a replacement **11-2**
- Z**
- ZIP Code
 - setting system to prompt for **5-10**
- Zone
 - entering **4-19**
 - setting system to prompt for **5-10**



1 Elmcroft Road
Stamford, Connecticut 06926-0700
www.pb.com

For Service or Supplies

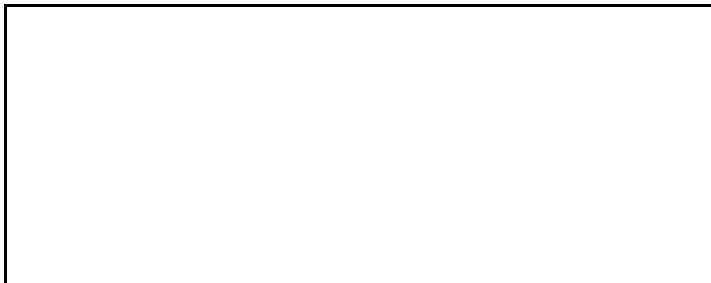

PB Form SV62201 Rev. C 6/09
©2009 Pitney Bowes Inc.
All Rights Reserved
Printed in the USA or Canada



* S V 6 2 2 0 1 R E V C *