

HP-100 SERIES

UNINTERRUPTIBLE POWER SUPPLIES
(1 Phase Input & Output)



HP-110

10 kVA

USER MANUAL

CONTENTS

I. SAFETY	2
II. INTRODUCTION	3
2.1 System Description.....	3
2.2 Technical Specifications	5
III. INSTALLATION	7
3.1 Unpacking.....	7
3.2 Location Selection	7
3.3 Cable Connections	7
3.4 Start-Up	9
IV. OPERATING PROCEDURE	10
4.1 Turn On procedure	10
4.2 Turn Off procedure	10
4.3 When Utility Power Is Interrupted.....	10
4.4 Operator Control Panel	10
4.4.1 Push buttons	10
4.4.2 First message (Up) line of the LCD.....	11
4.4.3 Second message line of the LCD.....	12
4.5 Automatic battery test system (optional)	12
V. OPTIONAL EQUIPMENT	13
5.1 Software Options	13
5.1.1 T-MON Software	13
5.2 SNMP Module	14
5.3 UPS DB-9 (female) port definition	14
5.4 Remote monitoring panel (RMP).....	15
5.5 UPS Port Sharer (Multiple server shut down unit)	15
5.6 RSC24 RS232 / RS485 Interface.....	15
VI. CUSTOMER SERVICE	18
6.1 Maintenance	18
6.2 Troubleshooting.....	18
6.3 Storage	18
VII. LIMITED WARRANTY	19

I. SAFETY

This manual contains important instructions for HP-100 series UPS that should be followed during installation and maintenance.

IMPORTANT NOTICES

1. Read instructions carefully before operating the UPS
2. All warnings in the manual should be adhered to.
3. All operating instructions should be followed.
4. The unit should be supplied by a grounded outlet. Do not operate the unit without ground source.
5. Power cord of the UPS should be routed carefully so that they are not to be walked on.
6. Please save this manual.
7. Please save or recycle the packaging materials.

WARNING!

- Do not insert any object into ventilation holes or other openings.
- To reduce the risk of fire or electric shock, install in temperature and humidity controlled indoor area free of conductive contaminants.
- To reduce the risk of fire, replace fuses with the same type and rating when necessary.

CAUTION!

- **Only qualified personnel should install or service UPS/batteries.**
- **Risk of electric shock, do not remove cover. No user serviceable parts inside, refer servicing to qualified service personnel.**
- The output may be energized when the unit is not connected to a mains supply.
- **Risk of electric shock hazardous live parts inside this unit are energized from the battery supply even when the input AC power is connected.**
- To reduce the risk of electric shock, disconnect the UPS from the mains supply before installing a computer interface signal cable. Reconnect the power cord only after signaling interconnections have been made.

ABOUT THE BATTERY

- A battery can present a risk of electric shock or burn from high short circuit currents. The following precaution should be observed when working on batteries:
 - * Remove watches, rings or other metal objects.
 - * Use tools with insulated handles.
- The batteries in this UPS are recyclable. Batteries must be disposed of according to local environmental laws. The batteries contain lead and pose a hazard to the environment and human health if not disposed of properly.
- Do not dispose of batteries in a fire. The batteries will explode. Do not open or mutilate the batteries. They contain an electrolyte which is toxic and harmful to the skin and eyes. If electrolyte comes into contact with the skin the affected area should be washed immediately.
- The internal energy source (the battery) cannot be de-energized by the user.

II. INTRODUCTION

Thank you for selecting this uninterruptible power supply (UPS). To choose the HP-100 series as your equipment protector was a wise investment. It includes many features to protect your critical equipments.

The HP-100 series UPS system is connected between mains and critical loads, such as computer systems, telecommunication systems, computerized instruments etc.

The advantages of using UPS:

- **Increased power quality:**
The UPS has its own internal voltage and frequency regulator circuits which ensure that its output is maintained within close tolerances independent of voltage and frequency variations on the mains power lines.
- **Increased noise rejection:**
By rectifying the input ac power to dc power, and then converting it back to ac, any electrical noise that may present on the input mains supply line is effectively isolated from the UPS output, therefore the critical load sees only clean power.
- **Power blackout protection:**
If the mains power fails, the UPS continues to power the critical load from its battery source, leaving the load immune from power disturbances.

2.1 System Description

Features:

- **On-line** technology with pure **sine wave** output.
- PWM and IGBT technology.
- Microprocessor controlled main controller board.
- Static (STS) and maintenance by-pass.
- LCD (Liquid Crystal Display) display.
- Alarm history (Memory for max. 64 alarms.)
- Automatic battery testing (optional).
- High quality maintenance-free lead-acid type batteries.
- High nonlinear load capacity, special for computers.
- **Accessories :**
 - Optional UPS monitoring software (T-MON, RUPS[®], RUPSII[®], UPSILON 2000[®]) SNMP devices, compatible to any operating system.
 - Remote Monitoring Panel (RMP) available: You can observe the UPS status and parameters without using a computer at a remote location up to 200 meters away (via RS485 interface).
 - UPS Port Sharer available

HP-100 Series Uninterruptible Power Supplies (UPS) are advanced true On-Line Sine wave devices with static transfer switch which provide reliable, regulated, transient-free AC power to sensitive equipment.

Since the UPS is a true On-Line system, conditioned power is provided continuously to the connected equipments. Unlike standby power systems, the UPS is constantly regulating and filtering the output power. When incoming power is interrupted, the UPS protects the computers instantaneously without any transfer time.

The HP-100 Series has high non-linear load capability (i.e. Crest Ratio 3:1) and this is suitable for powering special loads such as switching power supplies or highly capacitive inputs like computers.

The system's static transfer switch (STS) provides by-pass power as its standby source. During an overload condition, the S.T.S will switch the customer's load over to the bypass line with no interruption. The S.T.S will transfer back to the inverter automatically when the overload condition has been cleared. If the inverter fails internally, the unit switches to bypass within a few milliseconds.

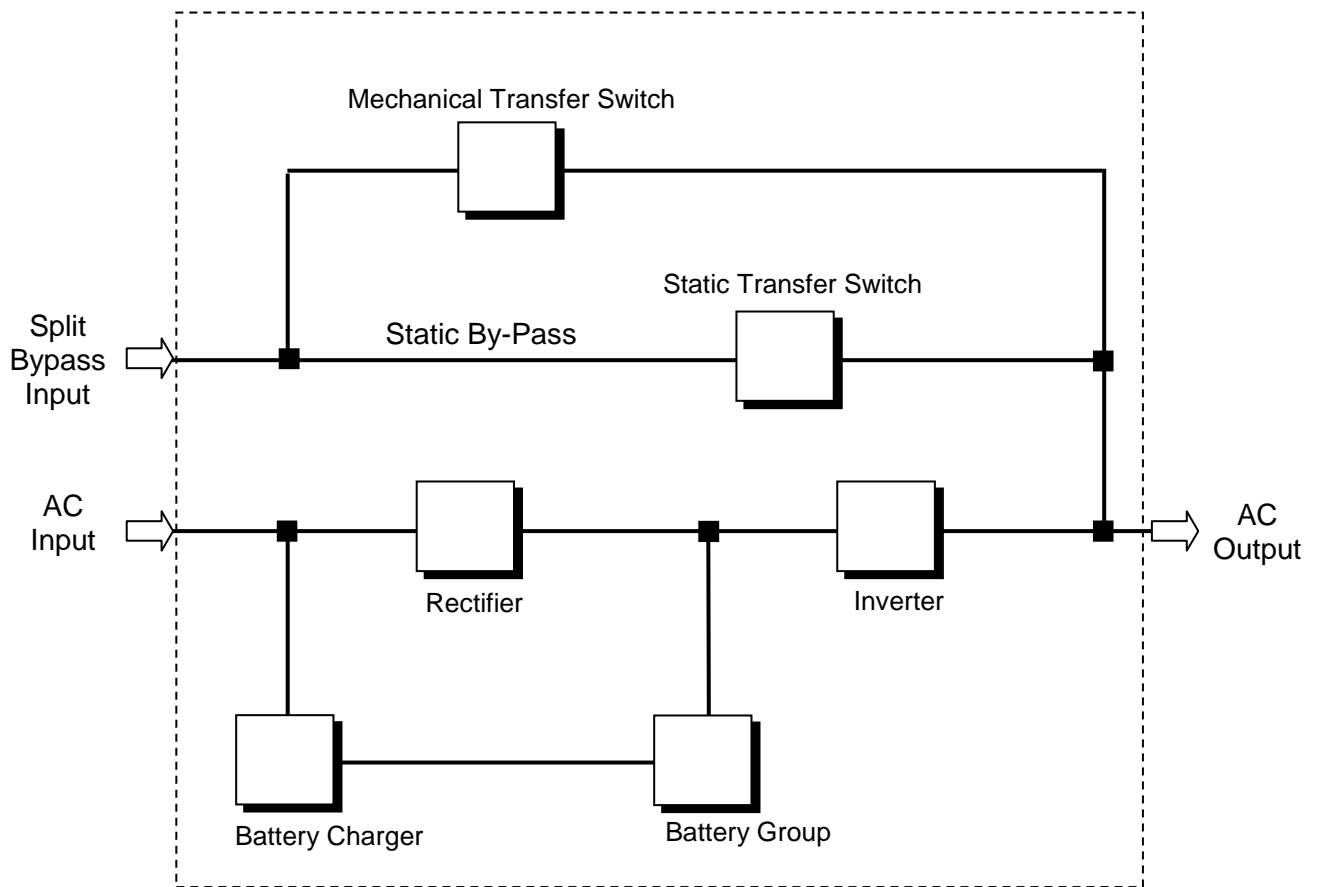

Figure 2.1 UPS Block Diagram

Rectifier : The first stage of the UPS. It supplies the DC bus voltage, which is necessary for operating the inverter by rectifying line voltage.

Inverter : It is made by utilizing the latest technology of power transistor (IGBT) and pulse width modulation (PWM). Inverter converts dc bus voltage into an alternative voltage like line voltage. And provides this voltage and frequency being fixed.

Static Transfer Switch (static by-pass) : Static transfer switch is an electronically controlled switching circuit checked by main controller board. In case of inverter overload or any other faults, STS transfers the critical load to the mains without any interruption.

Mechanical Transfer Switch : The mechanical transfer switch consists of a manually operated switch. When the UPS is switched off due to failure or maintenance, it feeds critical loads from mains.

Battery Group : It keeps dc voltage, which is necessary for the inverter, as a reservoir dc power supply in case of mains failure.

Battery Charger : It produces a well regulated dc voltage suitable for charging the UPS batteries.

2.2 Technical Specifications

	HP-110
Power	10 kVA
Power Factor	$\geq 0,9$
Automatic Battery Test	O
Alarm Relays	✓
RS 232	✓
INPUT	
Input Voltage	220 or 230 VAC 1Ph + N
Input Voltage Tolerance	+ 15%, -15%
By-pass Voltage	220 or 230 VAC $\pm 10\%$
Input Current	60 A
Input Frequency	50 Hz. $\pm 5\%$
RFI Level	EN50091
OUTPUT	
Nominal Output Power	7000W
Output Voltage	220 or 230 VAC
Output Voltage Tolerance	$\pm 1\%$
Output Frequency	50 Hz.
Output Frequency Tolerance	Line Synchronized $\pm 1\%$
	Free Running $\pm 0.2\%$
Efficiency (100% Load)	85-87 %
Crest Factor	3:1
Overload capacity	100% - 125% Load 2.5 min. 125% - 150% Load 10 sec. >150% instant by-pass.
Total Harmonic Distortion (THD)	< 3%
BATTERY	
Batteries	20x12V
Floating Charge Voltage	270 Vdc
End of Discharge Voltage	200 Vdc
Autonomy Time (100%Load)	10 min.
Charging Current	2.5 A
ENVIRONMENT	
Operating Temperature	0 - 40 °C
Acoustic Noise	<45dBA
Dimension (HxWxD mm)	710x265x740
Relative Humidity (max.)	90 %

* O : Optional

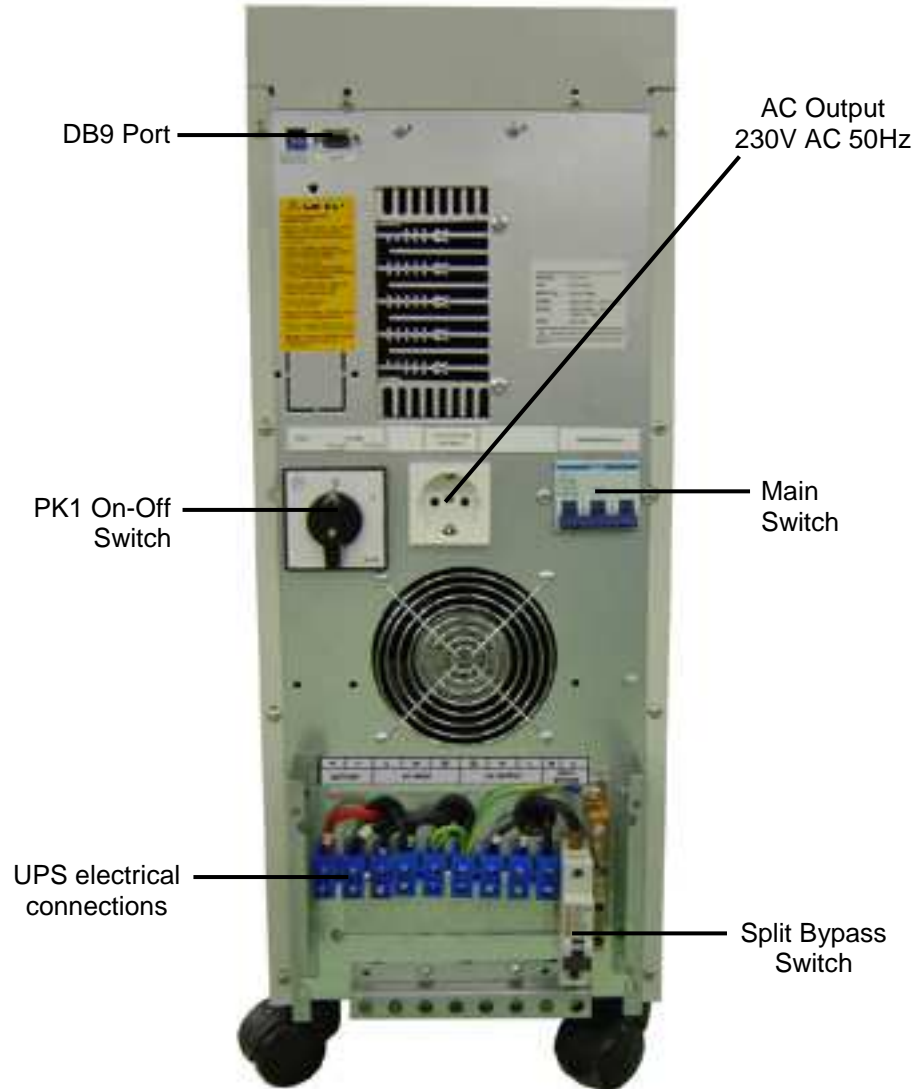

Figure 2.2 Rear views

III. INSTALLATION

3.1 Unpacking

The UPS is packed and enclosed in a structural cardboard carton to protect it from damage.

1. Inspect for damage that may have occurred during the shipment. If any damage is noted, call the shipper immediately and retain the shipping carton and the UPS.
2. Carefully open the carton and take the UPS out.
3. Retain the carton and packing material for future use.

Unit package contents :

	HP-110
User Manual	✓
Guarantee Certificate	✓
Battery Cabinet	-
Additional battery cabinet	O
220V Input cable	-
UPS Monitoring Software	T-MON

* O : Optional

3.2 Location Selection

The UPS is designed to be installed in a protected environment. The following conditions should be prohibited.

1. Blocking the airflow intake and outlet. (It is recommended to retain 10 cm (4") minimum. Between the rear side and the wall.)
2. Environment temperature and humidity out of specification.
3. Location subject to excessive moisture, dust and corrosion.
4. Location exposed to heat source or direct sunlight.

3.3 Cable Connections

CAUTION!
Only qualified personnel should install or service UPS / batteries.

The ac input to the UPS should be supplied by a separate line from the ac distribution board.

The input/output cables can be sized to suit the modules rating according to the table below.

10 kVA	3 x 6 mm ²
--------	-----------------------

The safety earth cable must be connected to the earth bus bar and bonded to each cabinet in the system. All cabinets should be earthed in accordance with local regulations.

The UPS itself has no effect on the earthing quality i.e. it doesn't change the unwanted voltage difference between the earth and neutral lines.

Once the equipment has been finally positioned and secured, connect the power cables as described in the following section.

It is recommended that the UPS should be connected to the line voltage protected by a circuit breaker.

1. Before connecting AC and DC power to the UPS make sure that the On-Off Switch PK1 and Main Switch on the rear panel are in the "0" position "OFF".
2. Connect the AC and/or DC input power to the UPS according to the label on the rear panel. Perform the load connections according to the same label too..
3. Check if the connections are correct. (battery polarity, ac voltage ratings etc.)

+	-	L	N	⊕	⊕	N	L	N	L
BATTERY		AC INPUT			AC OUTPUT			SPLIT BYPASS	

Figure 3.2 10kVA

3.4 Start-Up

1. Turn on the Main Switch on the rear panel. (In this case, there is line voltage at the output and battery charger board is active)
2. Turn the On-Off Switch PK1 on the rear panel to "1" position. In a few seconds the cooling fan will start to operate, then the red LED "by-pass" indicator will be off and the green LED indicator "inverter" will turn on and the UPS will start to give the inverter power to the output.
3. Disconnect the input power. The "LINE FAILURE" indicator will be on and audible alarm will sound intermittently. Now the output receptacles are supplied from the battery source.
4. Connect the power again and see that "LINE FAILURE" alarm is off.
5. Now your UPS is ready to operate. Plug in the critical loads to the output receptacles of the unit.

NOTE

If any condition is different from the above situation, call our local service representative for assistance.

CAUTION !

After initial start-up, keep power continuously to the unit for at least 12 hours to ensure that the batteries are fully charged.

During battery charging, the inverter can be shut down by turning the On-Off Switch PK1 to " off - 0 " position. In this case the main switch should be kept in " on-1 " position and it must be kept in mind that there is line voltage at the output.

IV. OPERATING PROCEDURE

4.1 Turn On procedure

1. Turn on the Main Switch on the rear panel to "1" position. *(There is line voltage at the output.)*
2. Turn on the On-Off Switch PK1 on the rear panel to the "1" position. Turn on the power switches on your critical load after the "Inverter" indicator (green light) is turned on. *(There is inverter voltage at the output.)*

4.2 Turn Off procedure

1. Turn off all the power switches on your critical equipments that are connected to the UPS.
2. Turn off the On-Off switch PK1 and the Main Switch to "0" position.

CAUTION

A- For daily TURN ON / TURN OFF operation, it is recommended to keep the Main switch at "1" position to ensure proper battery operation.

B- If the Main switch is in "1" position the line power will be supplied to output receptacles directly. DO NOT insert objects other than equipment power cords into outlets.

4.3 When Utility Power Is Interrupted

In case the utility power is interrupted, the UPS converts the built-in battery source to output terminals immediately to protect your critical loads from loss of data or damage.

Battery back-up time is more than 10 minutes for full load and can be extended by removing non-critical loads.

After an utility power blackout, the audible alarm and "**LINE FAILURE**" indicator on LCD panel will start operating. 1 minute after the power is interrupted, and you will see the message "**BAT.USED :001min**" on the LCD panel. This will show you for how long the batteries were used since the power was interrupted. When the "**Battery Low**" alarm appears, you have to shut down all your loads immediately, and turn the main switch **PK1** to position "**0**".

4.4 Operator Control Panel

The panel can be divided into two functional sections; "LED indications" and "control and display". As can be seen the upper section consists of leds which indicate the operation mode.

This panel shows the systems operation such as input and output Voltages, Frequency, % Load Status etc. by LCD.

4.4.1 Push buttons

- 1- **Sound on-off button** : When you push this button it will disable the audible alarm on the UPS. If you want to enable the sound alarm again you have to push the DISPLAY SELECT button for 2 sec.
- 2- **Display select button** : Each time you push this button, you can see one of the parameters of the FIRST (up) MESSAGE LINE.

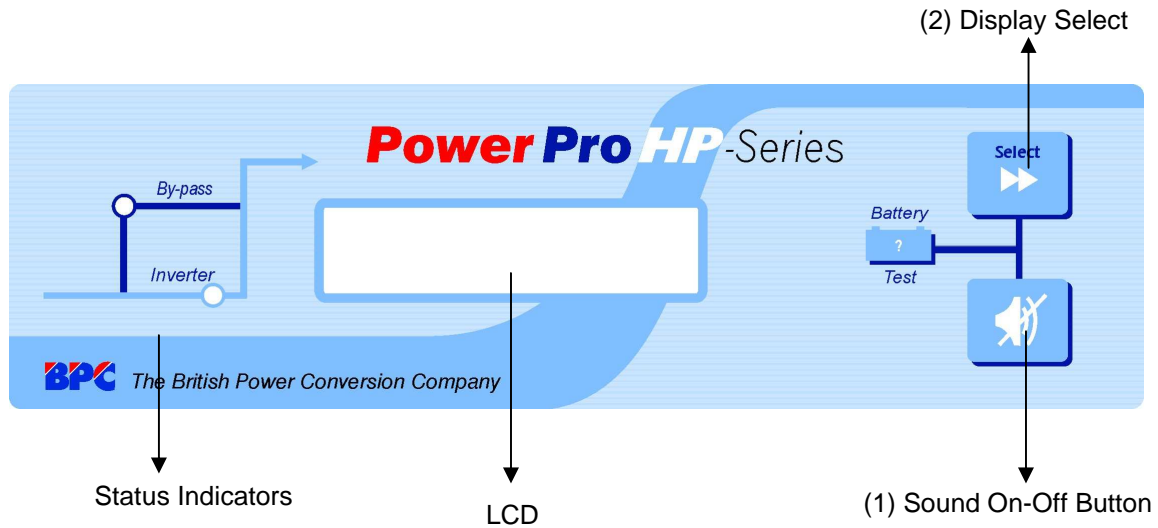

Figure 4.1 Control Panel

4.4.2 First message (Up) line of the Lcd

LOAD	The percentage of the load connected to the UPS output during this message the sound button enables/disables sound alarm.	
OUTPUT	UPS output Voltage during this message the sound button enables/disables sound alarm.	
BATTERY	UPS battery Voltage during this message the sound button enables/disables sound alarm.	
LINE	Line Voltage at the UPS input during this message the sound button enables/disables sound alarm.	
LANG. ENGLISH	Display language during this message the sound button enables/disables sound alarm.	
FREQ	UPS output frequency during this message the sound button enables/disables sound alarm.	
SOUND ON SOUND OFF	Audible alarm is active. Audible alarm is not active.(disabled by the user)	Each press to this button will change the status.
BATT.USED	It shows battery operation time (the time passed after the last line failure alarm)	
MOD: ONLINE MOD : ECONO	This parameter determines the operation type of the UPS. Econo mode means that if the mains is okay the load is fed from mains if the line failure alarm occurs UPS feeds the load. (OFFLINE UPS)	
SYNC:OK COMM:OK	UPS and LINE synchronization status. Communication active. (If PC sends data to UPS COMM:OK message will be showned for 3 seconds)	
LOG. EVENT	Your UPS records and keeps all its faults and alarms up to 64 events in its memory for future monitoring. Events are recorded in the order of occurrence. The upper line on LCD indicates the recorded event number, "000" being the last event. The lover line shows the name of the event. While monitoring the recorded events, you can return to event number "000" by pressing the "sound off" button for a relatively long time.	

4.4.3 Second message line of the LCD

VERSION XXXX	Micro controller software version of the UPS.
BYPASS FAILURE	This message shown that there is a problem of the static bypass system, please call for service.
FAULT 2	"INVERTER FAILURE" Inverter can not generate AC output. Turn-off the UPS and then turn it on again. If it doesn't start, please call for service.
FAULT 3	The temperature on the heatsink inside the UPS cabinet has exceeded 90 °C three times in the last 30 minutes. In such a case, the UPS should be turned-off and on again to resume normal operation.
FAULT 4	"Output Failure" alarm has occurred 4 times in the last 30minutes. Please call for service.
BAT.AUTONOMY END	Battery autonomy has finished during line failure.
BATTERY FAILURE	Battery test aborted. Battery test performed whilst battery not perfectly charged or battery cells damaged. Please call service
FAULT 7	Rectifier fault. Please call service for checking the UPS.
FAULT 8	Line voltage out of tolerance.
ONLINE MODE	UPS operating mode is ONLINE mode.
ECONO MODE (optional)	This message shown the alternate, operating mode is active OFFLINE.

4.5 Automatic battery test system (optional) :

There are some conditions to make this test (e. g availability of by-pass supply, line synchronization. a min. time requirement since the last line failure etc.). The first test is performed automatically, 8 hours later following the first turning on of the UPS. There is a 65 hours interval between two successive tests an each test lasts about 36 seconds.

During the battery test operation, the inverter power will be supplied from batteries. At the end of this test,if the battery voltage is below a predetermined value, " BATTERY FAILURE / BATTERY LOW Fault messages appear on the LCD panel and the UPS starts operating in By-Pass mode.

In this case you have to call your service.

If the batteries are in normal conditions the system will start operating in normal mode after 36 sec.

This test protects your operation against unexpected battery failures, and indicates you if there are any damaged batteries. It also discharges the batteries periodically, which is a good thing for extending battery life.

V. OPTIONAL EQUIPMENT

5.1 Software Options

The UPS can send digital data (optional) to the computer through the **RS232** port. No additional card is needed. It also has **two alarm relays: Line failure and battery low**.

Computer systems require time to perform an orderly shutdown, without corrupting or losing data. In an extended power failure, a computer system protected by a UPS eventually will lose power when the battery is exhausted. Using a UPS monitoring (T-MON, RUPS, RUPSII, UPSILON 2000) software the UPS and the computer system communicate so that the computer system is warned of impending UPS shutdown.

Software (T-MON, RUPS[®], RUPSII[®], UPSILON 2000[®]) and **SNMP** devices, is available for most operating systems and is supplied with a signaling cable that connects to the UPS.

RUPS software supports alarm relay option. (Line Failure & Battery Low) Cable code: M2501 / CC04
T-MON, RUPSII & UPSILON 2000 software support RS232 option. Cable code: M2502 / CC05

5.1.1 T-MON Software

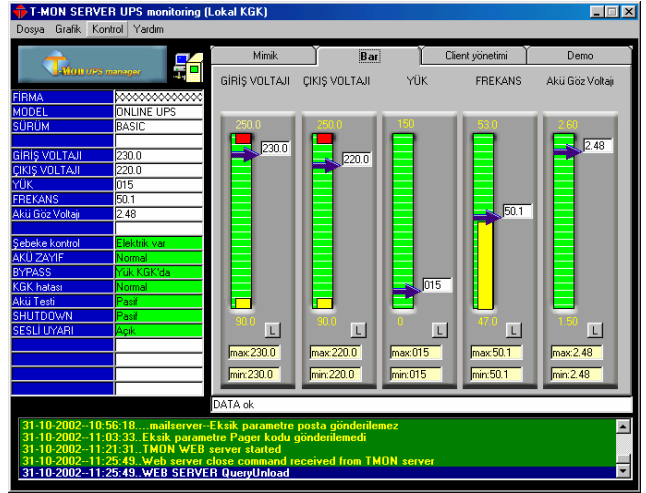
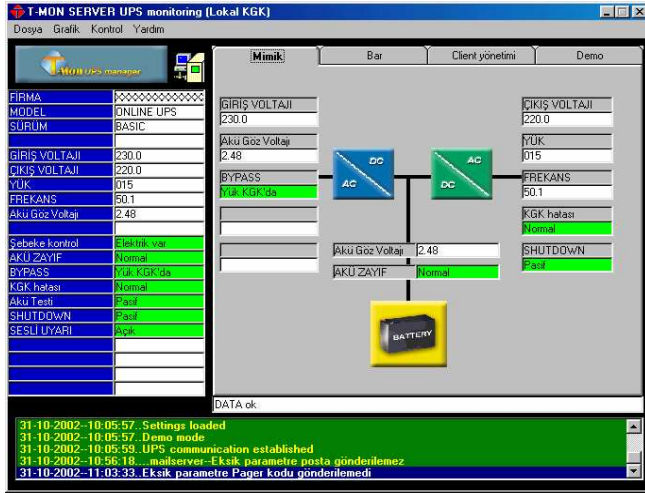

Using this software all the monitoring and control functions of the LCD panel of the UPS can be performed using your PC or Server. It is also possible to monitor a remote Ups with TCP/IP protocol and to shutdown your server and users with T-MON server Connector Software.

Operating systems : MS Windows 95-98-2000-XP[®] , NT Server[®] , UNIX Client.

5.2 SNMP Module

Using the SNMP module, your UPS is seen as a network device in your WAN or LAN applications, and with this way it can be monitored more than one UPS's connected to your network through SNMPVIEW Software supplied with the module or it is possible to monitor the UPS through an Internet Browser. It is possible to shutdown the servers or users with Client mate Software that communicates with SNMP module.



5.3 UPS DB-9 (female) port definition :

Pin assignments	Pin number
Line Failure Relay Common	4
Line Failure Relay NO	2
Battery Low Relay Common	4
Battery Low Relay NO	5
RS232 Signal Gnd	7
RS232 Receive	6
RS232 Transmit	9
	1, 3, 8 Not Connected



5.4 Remote monitoring panel (RMP)

You can see UPS status and parameters without using a computer up to 200 meters (via RS485 interface). And you can connect more than one remote panel in cascade for monitoring your UPS system from several different locations at the same time.



5.5 UPS Port Sharer (Multiple server shut down unit)

Using one of this units, you can automatic shut down of 4 / 8 servers or PC (where without LAN) connected to the same UPS by RUPS[®] software. Please look at the following connection diagram.

US-8



US-4



5.6 RSC24 RS232 / RS485 Interface

This interface should be used if the distance between the UPS and its remote monitoring panel exceeds 20 meters.



US SERIES UPS SHARING UNITS

US-8 CONNECTION DIAGRAM

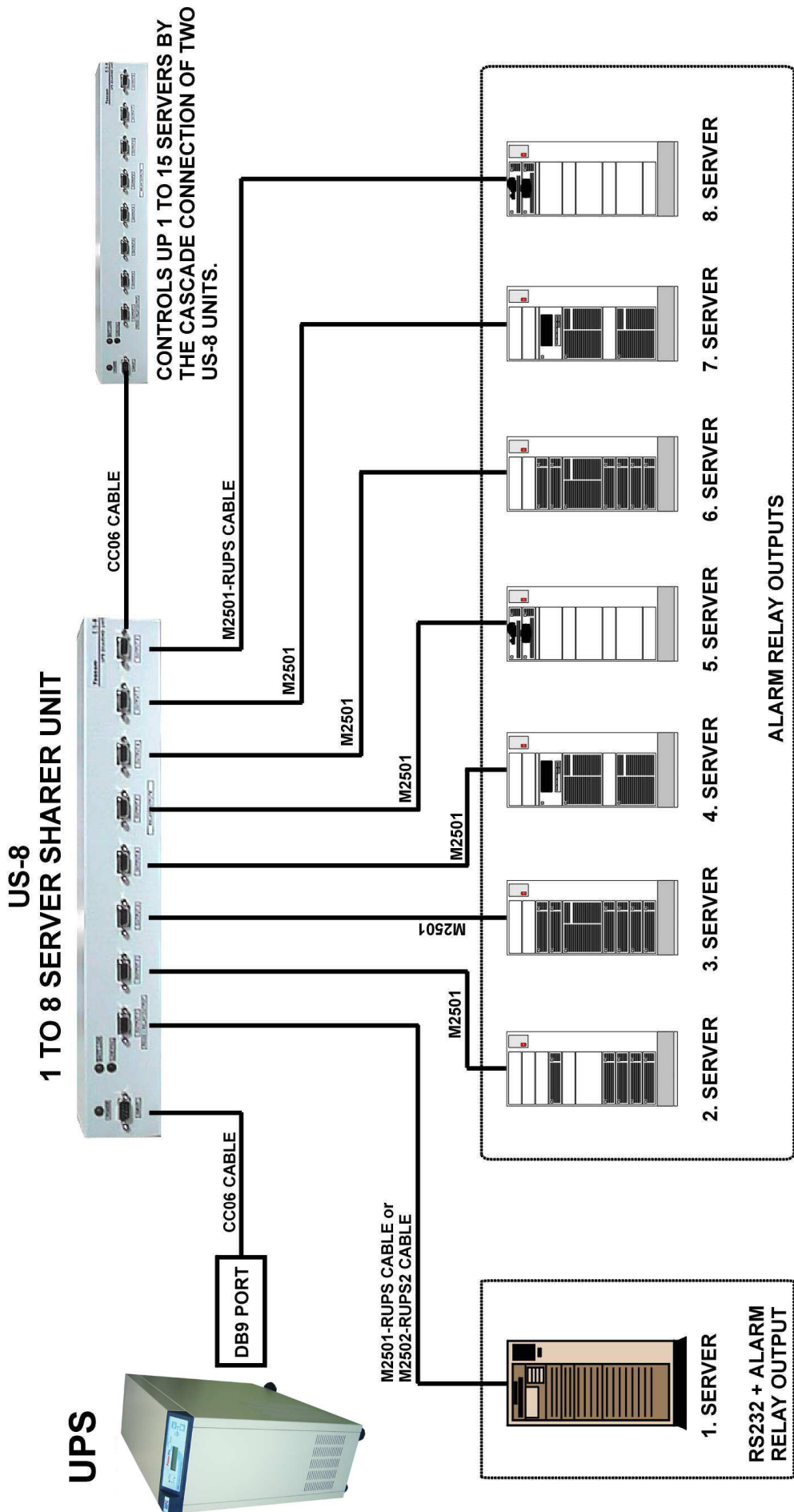

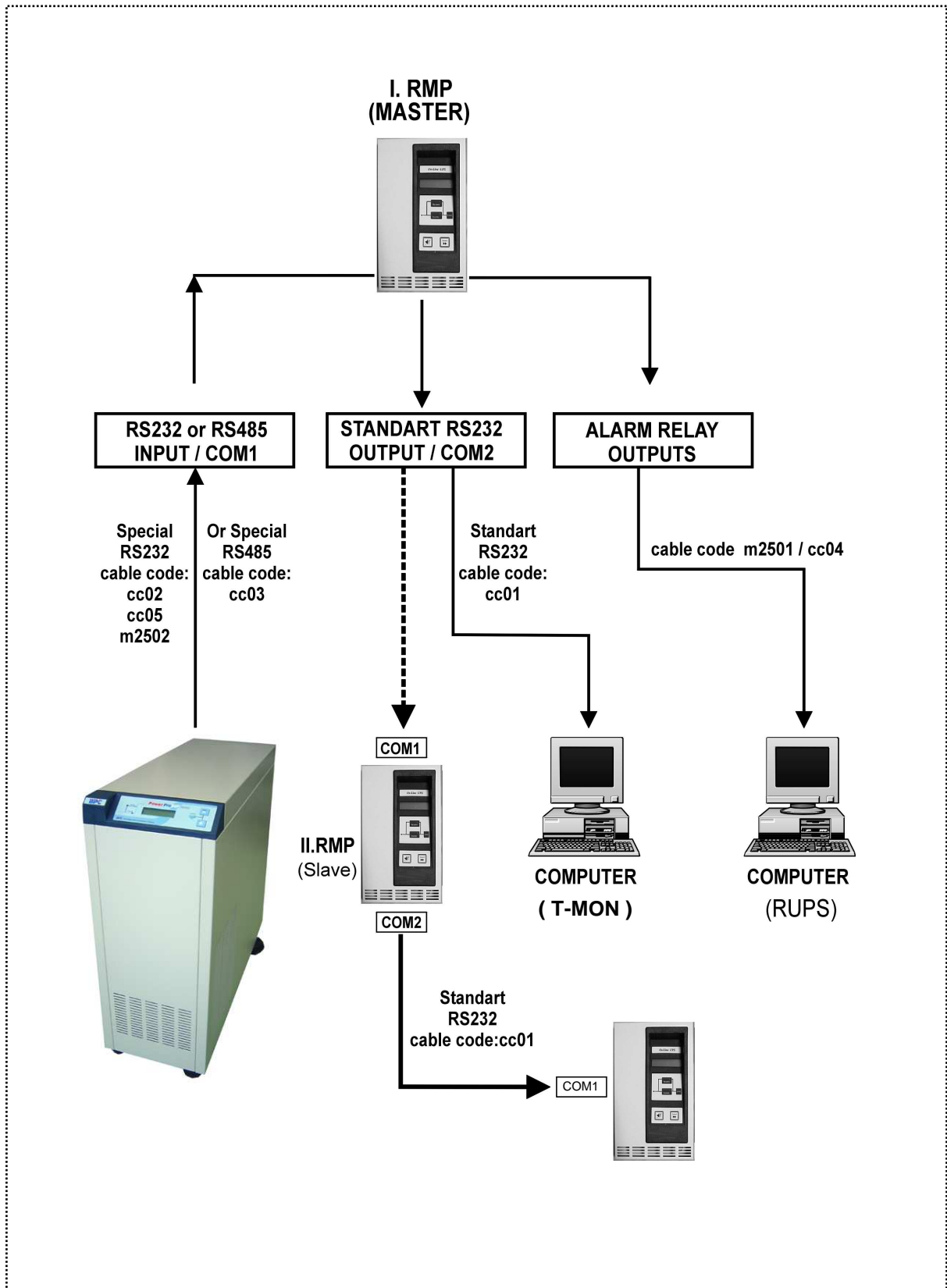

Connection Diagram Of The RMP

VI. CUSTOMER SERVICE

WARNING!

There are no customer serviceable components inside. DO NOT open the cover or attempt to service the unit. High voltage may remain when the unit is shut down. Unauthorized service will void the warranty and could cause serious injury.

6.1 Maintenance

The unit is designed for easy maintenance. Very little customer maintenance is required. The following will help to ensure trouble-free operation for several years:

1. Vacuum the dust from the ventilation intake on the front panel.
2. Wipe the cover with a damp cloth.
3. Periodically unplug the power cord of the UPS from the wall outlet to test the batteries condition (If automatic battery testing option not available.)

CAUTION!

It is recommended to test the battery discharging capability only after the software in use has been saved and all files have been closed.

6.2 Troubleshooting

Due to the unique design, the unit can be serviced only by authorized people. In case of a persistent failure or problem properly turn off the unit first. Then review the following check list. Be prepared to answer the questions before calling the service.

1. Did you follow the operation procedure? Did it happen on installation?
2. Is the on-off switch PK1 on the rear panel turned to position "1"?
3. Is the utility power of the wall outlet correct?
4. Did a power failure occur just after or before the malfunction noted on the UPS?
5. What is the indicators status? (see LCD alarms and FAULT codes)
6. Were any changes made recently to unit or the critical equipment connected to the unit?
7. Did an overload condition occur? Remove load from the unit and restart it.

6.3 Storage

1. Check the batteries charge with the manual battery test before storage.
2. Connection's uninstall operation will be done by the authorized service.
3. During the storage period the batteries should be charged once, per six months.
4. Keep the equipment and the batteries in a dry, cool place.
Best storage temperature for the UPS : Between 0°C and 40°C max.
Best storage temperature for the batteries : Between 10°C and 35°C max.

VII. LIMITED WARRANTY

The UPS is warranted against all defects in workmanship and materials under normal use for a period of one () year from the date of shipment to the original user. The conditions of this warranty and the extent of responsibility of

.....

corporation under this warranty are as follows.

1. The warranty does not apply if the product has been subjected to physical abuse, improper installation, unauthorized service or modification.
2. The sole responsibility of

.....

corporation under this warranty shall be limited to the repair or replacement of the product, at the sole discretion of

.....

corporation.

3. If it becomes necessary to send a defecting unit to

.....

corporation, the product should be shipped in its original carton or in suitable equivalent, and with shipping charges prepaid.

.....

corporation will not assume any responsibility for any loss damage incurred in shipping.

AGKK8710 08/2009