

FUGOO

Fugoo Bluetooth Speaker

User Manual

CoreX-6

We create experiences

Contents

In the Box	2
Speaker parts	2
Charging	3
Checking your battery level	3
Charging your speaker	3
Power	3
Connecting	3
Connecting through an audio cable	3
Pairing to another Bluetooth device	4
Un-pairing a Bluetooth device	4
Re-pairing to a previously connected device	4
Clearing all pairings	4
Audio playback	4
Adjusting the volume	4
Playback	4
Speakerphone	4
Taking a call	4
Voice Response mode	4
Adjusting the volume	5
Using the remote control	5
Remote control buttons	5
Replacing the battery	5
Customization	5
Changing jackets	5
Turning voice prompts on / off	5
Change tones	5
Resetting the speaker	6
Updating your software	6
Optional accessories	6
Remote control	6
Bike mount	6
Clip	6
Strap	6
Customer support	7
Legal notices	7

In the box

- Fugoo Bluetooth Speaker
- Remote control (included with some models)
- AC wall charger
- Micro-USB charging cable
- 3.5 mm audio cable
- Accessory pouch
- Quick Setup Guide
- Remote lanyard (included with some models)
- Remote wrist strap (included with some models)

Fugoo Bluetooth Speaker controls

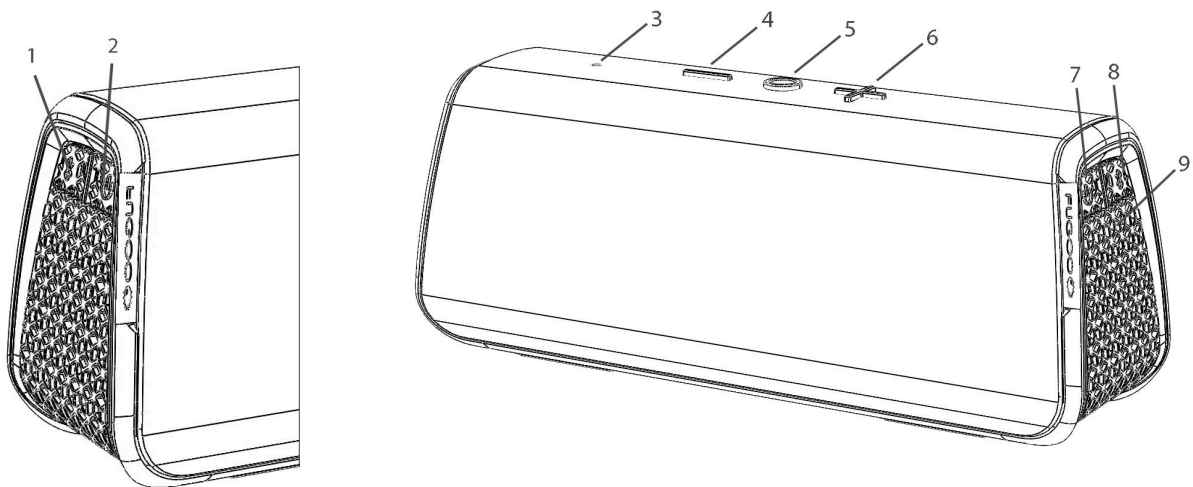

	Part	Description
1	Micro-USB charging connector / update port	For charging the Fugoo Bluetooth Speaker, and for updating its software
2	3.5 mm AUX input jack	For playing music from the headphone output of another device
3	Microphone	For speakerphone function
4	Volume down button (-)	Lowers the volume
5	Action button	Pause / Play and speakerphone control.
6	Volume up button (+)	Raises the volume
7	Power button	Turns the Fugoo Bluetooth Speaker On
8	Bluetooth button	For pairing with other Bluetooth devices
9	LED indicator	Indicates status of the Fugoo Bluetooth Speaker

Charging your Fugoo Bluetooth Speaker

Checking the battery level

- Press the  (Power) button briefly. The LED blinks one to four times to indicate the charge of the battery.
- If voice prompts are enabled, the speaker responds with "Battery is almost full" or another indication of how fully charged the battery is.





LED indicator	Voice prompt	Battery level
one blink	Battery is full	100%
two blinks	Battery medium	50%
three blinks	Battery low	25%
four blinks*	Battery needs recharging	5%

*The LED blinks red when the battery reaches 5%.

Charging your speaker

- Connect one end of the Micro-USB charging cable to the speaker and the other end to a power outlet.
- The LED indicator blinks green during charging.
- The LED indicator glows steady green once the battery is fully charged.

Turning on your speaker

- Press and hold the  (Power) button to turn the speaker on or off.
- When the speaker is running from battery power, it will turn off after 5 minutes of inactivity. To turn the speaker back on, press the ,  (volume down), or  (volume up) button.

Connecting your speaker to smartphones and other devices

You can connect to your Fugoo Bluetooth Speaker either through its AUX input jack, or through a Bluetooth wireless link. Only one of these inputs can be active at a time.

Connecting through an audio cable to the AUX input

- Connect one end of a 3.5 mm audio cable to your Fugoo Bluetooth Speaker's AUX input jack, then connect the other end to headphones jack of your audio device.
- The LED glows blue and a voice may say, "Disconnected. Bluetooth off. Connected"
- Plugging an audio cable into the speaker's AUX input jack turns off the Bluetooth wireless link, to save power and maximize battery life.

Connecting and pairing with another Bluetooth device

1. Place your Fugoo Bluetooth Speaker and your other Bluetooth device within 30 feet (10 meters) of each other.
2. Turn the speaker and the other device on.
3. Press and hold the  (Bluetooth) button for 3 seconds. The LED blinks red and blue repeatedly. If voice prompts are enabled, the speaker says, "Pairing mode. Please use the Bluetooth settings of your device to connect." The speaker will remain in pairing mode for three minutes.
3. On your other Bluetooth device, turn on Bluetooth and enter pairing mode. See the instructions that came with your Bluetooth device for more information.
4. Wait for the speaker to detect your Bluetooth device. If voice prompts are enabled, the speaker says, "Pairing successful." or "Pairing is unsuccessful. Please try again. Powering off."

Disconnecting from another Bluetooth device

To disconnect your speaker from another Bluetooth device, you can:

- Move your Fugoo Bluetooth Speaker and the other Bluetooth device more than 30 feet (10 meters) apart.
- Turn off your Fugoo Bluetooth Speaker.
- Turn off the other device.
- Turn off Bluetooth on your other device.
- Disconnecting temporarily interrupts the Bluetooth wireless link between the speaker and the other devices. The devices will still be paired, allowing them to automatically reconnect when they are placed within 30 feet of each other.

Re-connecting with a previously-paired device

- To reconnect to a Bluetooth device that you have previously paired with, just turn on the speaker and the other device, and place them within 30 feet (10 meters) of each other. Typically, they will reconnect automatically.
- If voice prompts are enabled, the speaker says "Connected".

Clearing all pairings

- To clear all of the Bluetooth pairings with other devices, turn the speaker on, and then press and hold the Bluetooth button for 10 seconds.
- If voice prompts are enabled, the speaker says "All Bluetooth pairings cleared. Pairing mode. Please use the Bluetooth settings of your device to connect."

Audio playback



Adjusting the volume

- Press the + (Volume up) or – (Volume down) buttons to raise or lower the volume.

Playback

- Press  (Action) to play or pause your audio.
OR
- Use the playback controls on your audio device to control playback.

Navigation





- Press  (Action) and together with the + (Volume up) and – (Volume down) buttons to skip to the next and previous track of the recording you're listening to.
- Next track: press  and + .
- Previous track: press  and - .

Taking a call – Speakerphone mode

Your Fugoo Bluetooth Speaker can act as a very high quality speakerphone for your cell phone or smartphone. You can receive and end calls and manage a call on hold.

Receiving a call

If you receive a call on your phone when it is connected to the speaker, you'll hear it ringing through the speaker.

- Press  (Action) to receive (pick up) the call.
- Talk and listen through the speaker during the call
- Press + or - to raise or lower the volume.
- Press  (Action) to end (hang up) the call.
- If you have a call on hold, press  (Action) to switch to it, and to switch back to the other call.
- Press and hold  (Action) to end the active call and switch to the call on hold.
- Use your phone's controls if you would like to transfer the call back to your phone.

Turning voice prompts on and off

- With the speaker turned off, press and hold the – (volume down), and + (volume up) buttons, then press the  (Power) button for two seconds. The speaker will turn on, and announce that voice prompts have been turned off or on.

Voice Response mode

- While your phone is paired to the speaker (and a call is not in progress) press and hold **O** (Action). A tone sounds through the speaker to activate a voice response service, such as Siri .
- Speak voice response commands through the speaker's microphone.
- Press **+** or **-** to raise or lower the volume.

Using the remote control

Remote control buttons

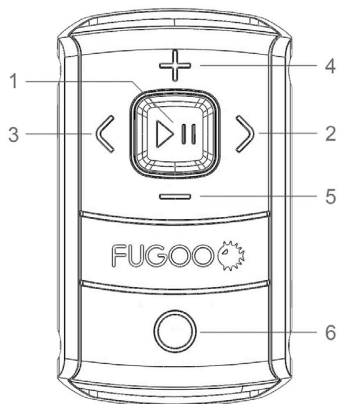



#	Description
1	Play/Pause
2	Next track
3	Previous track
4	Volume up
5	Volume down
6	Action

Replacing the battery

The remote for the Fugoo Bluetooth Speaker operates from a readily-available 3 volt CR2032 lithium button cell battery. It may last as long as three years, so will rarely need replacing.

1. Use a small Phillips screwdriver to loosen the captive screw on the underside of the remote. Turn the screw until it releases and pops upward. Don't try to remove the screw, which is held in place by a spring.
2. Insert the edge of a small coin, or a CR2032 battery, into the slot in the battery cover (beneath the lanyard hole), and gently pry the cover open.
3. Turn the battery cover over, and pop the old battery out with a thumbnail or a small flat-blade screwdriver.
4. Orient the new battery so that its '+' sign is facing the inside of the battery cover (also marked with a "+" sign).
5. Insert the battery under the two plastic tabs next to the edge of the battery cover.
6. Press the new battery firmly to seat it against the remaining plastic tab.
7. Insert the battery cover back into the metal frame of the remote control, and press it firmly until it seats securely, and its edge is flush with the body of the remote.
8. Re-tighten the screw in the battery cover, just enough to seat it.

Resetting the Fugoo Bluetooth Speaker

- Press and hold the  (Bluetooth) and  (Action) buttons for 10 seconds to reset the Fugoo Bluetooth Speaker to 'factory defaults' -- the state it was in the first time it was turned on. The LED blinks green once when the reset happens.
- Resetting the speaker works whether the speaker is powered on or is off.
- If the speaker is off when it is reset, it will enter pairing mode when next turned on.

Customization

Changing jackets

To remove a jacket (Style Jacket shown):

1. Turn the Fugoo Bluetooth Speaker upside down.
2. Lift up the release latch (It has a teal arrow.).
3. Slide the speaker core toward the latch, and out from the jacket.

To add a jacket:

1. Turn the core upside down
2. Locate the key-indentation on the bottom of the core.
3. Insert the end of speaker core with the key-indentation into the jacket, and slide it all the way in until it snaps in place.

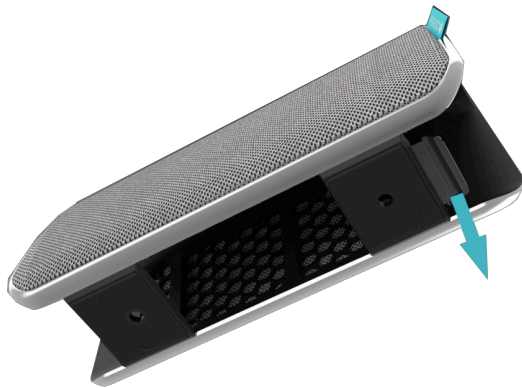

Updating your Fugoo Bluetooth Speaker's software

You can change the personality of your Fugoo Bluetooth Speaker by downloading and installing a software update that contains a different set of voice prompts. Fugoo may post new versions of the Fugoo Bluetooth Speaker software from time to time to fix problems, and to improve its user interface and behavior.

1. Download the software update app from the Fugoo support website, at support.fugoo.com/update to your computer (Mac or PC).
2. Turn off your Fugoo Bluetooth Speaker.
3. Connect the small end of the USB cable to your speaker, then connect the other end to a USB port on your computer.
4. Launch the software update app, and Follow the on-screen instructions
5. Follow the on-screen instructions to update your software. The app will tell you when the software update is finished.

Legal notices

FCC Statement

This equipment has been tested and found to comply with the limits for a Class B digital device, pursuant to part 15 of the FCC Rules. These limits are designed to provide reasonable protection against harmful interference in a residential installation. This equipment generates uses and can radiate radio frequency energy and, if not installed and used in accordance with the instructions, may cause harmful interference to radio communications. However, there is no guarantee that interference will not occur in a particular installation. If this equipment does cause harmful interference to radio or television reception, which can be determined by turning the equipment off and on, the user is encouraged to try to correct the interference by one or more of the following measures:

- Reorient or relocate the receiving antenna.
- Increase the separation between the equipment and receiver.
- Connect the equipment into an outlet on a circuit different from that to which the receiver is connected.
- Consult the dealer or an experienced radio/TV technician for help.

This device complies with FCC radiation exposure limits set forth for an uncontrolled environment.

This device complies with Part 15 of the FCC Rules. Operation is subject to the following two conditions: (1) this device may not cause harmful interference, and (2) this device must accept any interference received, including interference that may cause undesired operation.

Caution!

Any changes or modifications not expressly approved by the party responsible for compliance could void the user's authority to operate the equipment.

IC Statement

This device complies with Industry Canada licence-exempt RSS standard(s).

Operation is subject to the following two conditions: (1) this device may not cause interference, and (2) this device must accept any interference, including interference that may cause undesired operation of the device.

Le présent appareil est conforme aux CNR d'Industrie Canada applicables aux appareils radio exempts de licence. L'exploitation est autorisée aux deux conditions suivantes : (1) l'appareil ne doit pas produire de brouillage, et (2) l'utilisateur de l'appareil doit accepter tout brouillage radioélectrique subi, même si le brouillage est susceptible d'en compromettre le fonctionnement.

The device meets the exemption from the routine evaluation limits in section 2.5 of RSS 102 and compliance with RSS-102 RF exposure, users can obtain Canadian information on RF exposure and compliance.

Le dispositif rencontre l'exemption des limites courantes d'évaluation dans la section 2.5 de RSS 102 et la conformité à l'exposition de RSS-102 rf, utilisateurs peut obtenir l'information canadienne sur l'exposition et la conformité de rf.

COFETEL

La operación de este equipo está sujeta a las siguientes dos condiciones: (1) es posible que este equipo o dispositivo no cause interferencia perjudicial y (2) este equipo o dispositivo debe aceptar cualquier interferencia, incluyendo la que pueda causar su operación no deseada.