

EN

User Manual

# USER MANUAL

Freezer

ZQF11431DA  
ZQF11432DA

**ZANUSSI**

## Contents

---

|                          |   |                            |    |
|--------------------------|---|----------------------------|----|
| Safety information.....  | 2 | Hints and tips.....        | 6  |
| Safety instructions..... | 3 | Care and cleaning.....     | 7  |
| Operation.....           | 4 | Troubleshooting.....       | 8  |
| First use.....           | 6 | Installation.....          | 10 |
| Daily use.....           | 6 | Technical information..... | 12 |

Subject to change without notice.

## Safety information

---

Before the installation and use of the appliance, carefully read the supplied instructions. The manufacturer is not responsible if an incorrect installation and use causes injuries and damages. Always keep the instructions with the appliance for future reference.

### Children and vulnerable people safety

- This appliance can be used by children aged from 8 years and above and persons with reduced physical, sensory or mental capabilities or lack of experience and knowledge if they have been given supervision or instruction concerning use of the appliance in a safe way and understand the hazards involved.
- Do not let children play with the appliance.
- Cleaning and user maintenance shall not be made by children without supervision.
- Keep all packaging away from children.

### General Safety

- This appliance is intended to be used in household and similar applications such as:
  - Farm houses; staff kitchen areas in shops, offices and other working environments
  - By clients in hotels, motels, bed and breakfast and other residential type environments
- Keep ventilation openings, in the appliance enclosure or in the built-in structure, clear of obstruction.

- Do not use mechanical devices or other means to accelerate the defrosting process, other than those recommended by the manufacturer.
- Do not damage the refrigerant circuit.
- Do not use electrical appliances inside the food storage compartments of the appliance, unless they are of the type recommended by the manufacturer.
- Do not use water spray and steam to clean the appliance.
- Clean the appliance with a moist soft cloth. Only use neutral detergents. Do not use abrasive products, abrasive cleaning pads, solvents or metal objects.
- Do not store explosive substances such as aerosol cans with a flammable propellant in this appliance.
- If the supply cord is damaged, it must be replaced by the manufacturer, its Authorised Service Centre or similarly qualified persons in order to avoid a hazard.

## Safety instructions

---

### Installation



#### **WARNING!**

Only a qualified person must install this appliance.

- Remove all the packaging.
- Do not install or use a damaged appliance.
- Obey the installation instruction supplied with the appliance.
- Always be careful when you move the appliance because it is heavy. Always wear safety gloves.
- Make sure the air can circulate around the appliance.
- Wait at least 4 hours before connecting the appliance to the power supply. This is to allow the oil to flow back in the compressor.
- Do not install the appliance close to radiators or cookers, oven or hobs.
- The rear of the appliance must stand against the wall.
- Do not install the appliance where there is direct sunlight.
- Do not install this appliance in areas that are too humid or too colds, such as the construction appendices, garages or wine cellars.

- When you move the appliance, lift it by the front edge to avoid scratching the floor.

### Electrical connection



#### **WARNING!**

Risk of fire and electrical shock.

- The appliance must be earthed.
- Make sure that the electrical information on the rating plate agrees with the power supply. If not, contact an electrician.
- Always use a correctly installed shockproof socket.
- Do not use multi-plug adapters and extension cables.
- Make sure not to cause damage to the electrical components (e.g. mains plug, mains cable, compressor). Contact the Authorised Service Centre or an electrician to change the electrical components.
- The mains cable must stay below the level of the mains plug.
- Connect the mains plug to the mains socket only at the end of the installation. Make sure that there is access to the mains plug after the installation.
- Do not pull the mains cable to disconnect the appliance. Always pull the mains plug.

## Use



### WARNING!

Risk of injury, burns, electrical shock or fire.

- Do not change the specification of this appliance.
- Do not put electrical appliances (e.g. ice cream makers) in the appliance unless they are stated applicable by the manufacturer.
- Be careful not to cause damage to the refrigerant circuit. It contains isobutane (R600a), a natural gas with a high level of environmental compatibility. This gas is flammable.
- If damage occurs to the refrigerant circuit, make sure that there are no flames and sources of ignition in the room. Ventilate the room.
- Do not let hot items to touch the plastic parts of the appliance.
- Do not put soft drinks in the freezer compartment. This will create pressure on the drink container.
- Do not store flammable gas and liquid in the appliance.
- Do not put flammable products or items that are wet with flammable products in, near or on the appliance.
- Do not touch the compressor or the condenser. They are hot.
- Do not remove or touch items from the freezer compartment if your hands are wet or damp.
- Do not freeze again food that has been thawed.
- Obey the storage instructions on the packaging of frozen food.

## Operation

### Control panel

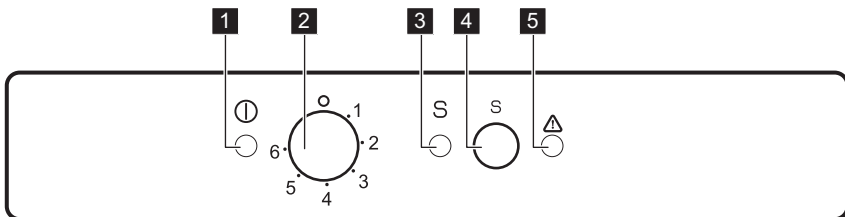

**1** Power indicator light

**2** Temperature regulator

## Care and cleaning



### WARNING!

Risk of injury or damage to the appliance.

- Before maintenance, deactivate the appliance and disconnect the mains plug from the mains socket.
- This appliance contains hydrocarbons in the cooling unit. Only a qualified person must do the maintenance and the recharging of the unit.
- Regularly examine the drain of the appliance and if necessary, clean it. If the drain is blocked, defrosted water collects in the bottom of the appliance.

## Disposal



### WARNING!

Risk of injury or suffocation.

- Disconnect the appliance from the mains supply.
- Cut off the mains cable and discard it.
- Remove the door to prevent children and pets to be closed inside of the appliance.
- The refrigerant circuit and the insulation materials of this appliance are ozone-friendly.
- The insulation foam contains flammable gas. Contact your municipal authority for information on how to discard the appliance correctly.
- Do not cause damage to the part of the cooling unit that is near the heat exchanger.

- 3 QuickFreeze light
- 4 QuickFreeze switch and alarm reset switch

## Switching on

Connect the appliance to the main power supply.

1. Turn the Temperature regulator clockwise to a medium setting.

The power indicator light will turn on and a sound will signal for 2 seconds.

 If the temperature inside the appliance is too high, the Alarm light will blink and the sound signal alarm will turn on.

2. Push the QuickFreeze switch and the sound signal alarm will get off.
3. Push the QuickFreeze switch once again and the QuickFreeze indicator will light up. The appliance will start to operate.

## Switching off

Turn the Temperature regulator to the "O" position.

After a 2 second sound, the power indicator light will turn off.

## Temperature regulation

The temperature is regulated automatically.

 A medium setting is generally the most suitable. However, the exact setting should be chosen keeping in mind that the temperature inside the appliance depends on:

- room temperature,
- how often the door is opened,
- the quantity of food stored,
- the location of the appliance.

1. Turn the Temperature regulator toward lower settings to obtain the minimum coldness.
2. Turn the Temperature regulator toward higher settings to obtain the maximum coldness.

- 5 Alarm light



## CAUTION!

If the ambient temperature is high or the appliance is fully loaded, and the appliance is set to the lowest temperatures, it may run continuously causing frost to form on the rear wall. In this case the dial must be set to a higher temperature to allow automatic defrosting and therefore reduced energy consumption.

## QuickFreeze function

Press the QuickFreeze button. The QuickFreeze indicator appears. To switch off the function before its automatic end, press the QuickFreeze button until the QuickFreeze indicator turns off

## Door open alarm

An acoustic alarm will sound if the door is left open for a few minutes. The door open alarm conditions are indicated by:

- a flashing Alarm indicator;
- an acoustic buzzer.

When normal conditions are restored (door closed), the alarm will stop. The buzzer can also be switched off by pressing any button.

## High temperature alarm

If the temperature inside the freezer has risen to a point where the safe storage of frozen food is no longer ensured (for example due to a power failure), the Alarm light will blink and an acoustic alarm will sound.

 When the freezer is first switched on, the Alarm light blinks until the temperature has dropped to a safe level for the storage of frozen food.

1. Switch off the warning tone by pressing the QuickFreeze switch. The QuickFreeze indicator appears. The Alarm light blinks until the required temperature has been reached again.
2. Release the QuickFreeze switch as soon as the Alarm light is off. The QuickFreeze indicator turns off.

## First use

---

### Cleaning the interior

Before using the appliance for the first time, the interior and all internal accessories should be washed with lukewarm water and some neutral soap to remove the typical smell of a brand-new product, then dried thoroughly.

### Daily use

---



#### **WARNING!**

Refer to Safety chapters.

### Freezing fresh food

The freezer compartment is suitable for freezing fresh food and storing frozen and deep-frozen food for a long time.

To freeze fresh food activate the QuickFreeze function at least 24 hours before placing the food to be frozen in the freezer compartment.

Place the fresh food to be frozen in the two top compartments.

The maximum amount of food that can be frozen in 24 hours is specified on the **rating plate**, a label located on the inside of the appliance.

The freezing process lasts 24 hours: during this period do not add other food to be frozen.

When the freezing process is completed, return to the required temperature (see "QuickFreeze Function").

### Storage of frozen food

When first starting-up or after a period out of use, before putting the products in the

## Hints and tips

---

### Normal operating sounds

The following sounds are normal during operation:

- A faint gurgling and bubbling sound from coils sound when refrigerant is pumped.
- A whirring and pulsating sound from the compressor when refrigerant is pumped.
- A sudden cracking noise from inside appliance caused by thermic dilatation (a natural and not dangerous physical phenomenon).



#### **CAUTION!**

Do not use detergents or abrasive powders, as these will damage the finish.

compartment let the appliance run at least 2 hours on the higher settings.



In the event of accidental defrosting, for example due to a power failure, if the power has been off for longer than the value shown in the technical characteristics chart under "rising time", the defrosted food must be consumed quickly or cooked immediately and then re-frozen (after cooling).

### Cold accumulators

The freezer contains at least one cold accumulator which increases storage time in the event of a power cut or breakdown.

### Thawing

Deep-frozen or frozen food, prior to being used, can be thawed in the refrigerator compartment or at room temperature, depending on the time available for this operation.

Small pieces may even be cooked still frozen, directly from the freezer: in this case, cooking will take longer.

- A faint click noise from the temperature regulator when the compressor switches on or off.

### Hints for energy saving

- Do not open the door frequently or leave it open longer than absolutely necessary.
- If foreseen, do not remove the cold accumulators from the freezer basket.

## Hints for freezing

To help you make the most of the freezing process, here are some important hints:

- the maximum quantity of food which can be frozen in 24 hrs. is shown on the rating plate;
- the freezing process takes 24 hours. No further food to be frozen should be added during this period;
- freeze only top quality, fresh and thoroughly cleaned, foodstuffs;
- prepare food in small portions to enable it to be rapidly and completely frozen and to make it possible subsequently to thaw only the quantity required;
- wrap up the food in aluminium foil or polythene and make sure that the packages are airtight;
- do not allow fresh, unfrozen food to touch food which is already frozen, thus avoiding a rise in temperature of the latter;
- lean foods store better and longer than fatty ones; salt reduces the storage life of food;

- water ices, if consumed immediately after removal from the freezer compartment, can possibly cause the skin to be freeze burnt;
- it is advisable to show the freezing in date on each individual pack to enable you to keep tab of the storage time.

## Hints for storage of frozen food

To obtain the best performance from this appliance, you should:

- make sure that the commercially frozen foodstuffs were adequately stored by the retailer;
- be sure that frozen foodstuffs are transferred from the foodstore to the freezer in the shortest possible time;
- not open the door frequently or leave it open longer than absolutely necessary;
- once defrosted, food deteriorates rapidly and cannot be refrozen;
- do not exceed the storage period indicated by the food manufacturer.

## Care and cleaning



### WARNING!

Refer to Safety chapters.

### General warnings



### CAUTION!

Unplug the appliance before carrying out any maintenance operation.



This appliance contains hydrocarbons in its cooling unit; maintenance and recharging must therefore only be carried out by authorized technicians.



The accessories and parts of the appliance are not suitable for washing in a dishwasher.

### Periodic cleaning



### CAUTION!

Do not pull, move or damage any pipes and/or cables inside the cabinet.



### CAUTION!

Take care of not to damage the cooling system.



### CAUTION!

When moving the cabinet, lift it by the front edge to avoid scratching the floor.

The equipment has to be cleaned regularly:

1. Clean the inside and accessories with lukewarm water and some neutral soap.
2. Regularly check the door seals and wipe clean to ensure they are clean and free from debris.
3. Rinse and dry thoroughly.
4. If accessible, clean the condenser and the compressor at the back of the appliance with a brush.  
This operation will improve the performance of the appliance and save electricity consumption.

## Defrosting the freezer



### CAUTION!

Never use sharp metal tools to scrape off frost from the evaporator as you could damage it. Do not use a mechanical device or any artificial means to speed up the thawing process other than those recommended by the manufacturer. A temperature rise of the frozen food packs, during defrosting, may shorten their safe storage life.



About 12 hours prior to defrosting, set a lower temperature, in order to build up sufficient chill reserve for the interruption in operation.

A certain amount of frost will always form on the freezer shelves and around the top compartment.

Defrost the freezer when the frost layer reaches a thickness of about 3-5 mm.

1. Switch off the appliance, or pull out electrical plug from the wall socket.
2. Remove any stored food, wrap it in several layers of newspaper and put it in a cool place.



### WARNING!

Do not touch frozen goods with wet hands. Hands can freeze to the goods.

3. Switch on the appliance. After three hours reload the previously removed food into the freezer compartment.

## Troubleshooting



### WARNING!

Refer to Safety chapters.

### What to do if...

| Problem                         | Possible cause   | Solution  |
|---------------------------------|--|---|
| The appliance does not operate. | The appliance is switched off.                                 | Switch on the appliance.                              |
|                                 | The mains plug is not connected to the mains socket correctly. | Connect the mains plug to the mains socket correctly. |

## Cleaning the air channels

1. Remove the plinth (A), then the ventilation grille (B).
2. Clean the ventilation grille.
3. Carefully pull the air deflector out (C), checking that there is no water left from the defrosting.
4. Clean the lower part of the appliance with a vacuum cleaner.

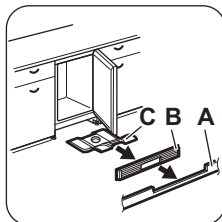

## Periods of non-operation

When the appliance is not in use for long periods, take the following precautions:

1. Disconnect the appliance from electricity supply.
2. Remove all food.
3. Defrost (if necessary) and clean the appliance and all accessories.
4. Leave the door/doors open to prevent unpleasant smells.



### WARNING!

If the cabinet will be kept on, ask somebody to check it once in a while to prevent the food inside from spoiling in case of a power failure.



| <b>Problem</b>                       | <b>Possible cause</b>   | <b>Solution</b>  |
|--------------------------------------|---|--|
|                                      | There is no voltage in the mains socket.  | Connect a different electrical appliance to the mains socket. Contact a qualified electrician. |
| The appliance is noisy.              | The appliance is not supported properly.  | Check if the appliance stands stable.  |
| Audible or visual alarm is on.       | The cabinet has been recently switched on or the temperature is still too high. | Refer to "Door Open Alarm" or "High Temperature Alarm".  |
|                                      | The temperature in the appliance is too high.                                   | Refer to "Door Open Alarm" or "High Temperature Alarm".  |
|                                      | The door is left open.  | Close the door.  |
| Power indicator light is flashing.   | An error has occurred in measuring the temperature.                             | Contact a qualified electrician or contact the nearest Authorized Service Centre.              |
|                                      | The appliance is not working properly.  | Contact a qualified electrician or contact the nearest Authorized Service Centre.              |
|                                      | The temperature in the appliance is too high.                                   | Contact a qualified electrician or contact the nearest Authorized Service Centre.              |
| The compressor operates continually. | Temperature is set incorrectly.   | Refer to "Operation" chapter.  |
|                                      | Many food products to be frozen were put in at the same time.                   | Wait some hours and then check the temperature again.  |
|                                      | The room temperature is too high.   | Refer to climate class chart on the rating plate.  |
|                                      | Food products placed in the appliance were too warm.                            | Allow food products to cool to room temperature before storing.                                |
|                                      | The door is not closed correctly.   | Refer to "Closing the door".   |
|                                      | The QuickFreeze function is switched on.  | Refer to "QuickFreeze function".   |
| There is too much frost and ice.     | The door is not closed correctly or the gasket is deformed/dirty.               | Refer to "Closing the door".   |
|                                      | The water drainage plug is not correctly positioned.                            | Position the water drainage plug in the correct way.   |
|                                      | Food products are not wrapped properly.   | Wrap the food products better.   |
|                                      | Temperature is set incorrectly.   | Refer to "Operation" chapter.  |

| Problem  | Possible cause   | Solution  |
|--|--|---|
| The compressor does not start immediately after pressing the QuickFreeze, or after changing the temperature. | This is normal, no error has occurred.                 | The compressor starts after a period of time.   |
| Temperature cannot be set.   | The QuickFreeze or QuickChill function is switched on. | Switch off QuickFreeze or QuickChill manually, or wait until the function resets automatically to set the temperature. Refer to "QuickFreeze or QuickChill function". |
| The temperature in the appliance is too low/too high.  | The temperature regulator is not set correctly.        | Set a higher/lower temperature.   |
|  | The door is not closed correctly.                      | Refer to "Closing the door".  |
|  | The food products' temperature is too high.            | Let the food products temperature decrease to room temperature before storage.  |
|  | Many food products are stored at the same time.        | Store less food products at the same time.  |
|  | The thickness of the frost is greater than 4-5 mm.     | Defrost the appliance.  |
|  | The door has been opened often.                        | Open the door only if necessary.  |
|  | The QuickFreeze function is switched on.               | Refer to "QuickFreeze function".  |
|  | There is no cold air circulation in the appliance.     | Make sure that there is cold air circulation in the appliance.  |

**i** If the advice does not lead to the desired result, call the nearest Authorized Service Centre.

### Closing the door

1. Clean the door gaskets.

2. If necessary, adjust the door. Refer to "Installation".
3. If necessary, replace the defective door gaskets. Contact the Authorized Service Centre.

## Installation



### WARNING!

Refer to Safety chapters.

### Location



Refer to the assembly instructions for the installation.

To ensure best performance, install the appliance well away from sources of heat such as radiators, boilers, direct sunlight etc. Make sure that air can circulate freely around the back of the cabinet.

## Positioning

This appliance can be installed in a dry, well ventilated indoor where the ambient temperature corresponds to the climate class indicated on the rating plate of the appliance:

| Climate class | Ambient temperature |
|---------------|---------------------|
| SN            | +10°C to + 32°C     |
| N             | +16°C to + 32°C     |
| ST            | +16°C to + 38°C     |
| T             | +16°C to + 43°C     |



Some functional problems might occur for some types of models when operating outside of that range. The correct operation can only be guaranteed within the specified temperature range. If you have any doubts regarding where to install the appliance, please turn to the vendor, to our customer service or to the nearest Authorised Service Centre.

## Electrical Connection



### CAUTION!

Any electrical work required to install this appliance should be carried out by a qualified electrician or competent person.



### WARNING!

This appliance must be earthed. The manufacturer declines any liability should these safety measures not be observed.

The wires in the mains lead are coloured in accordance with the following code:

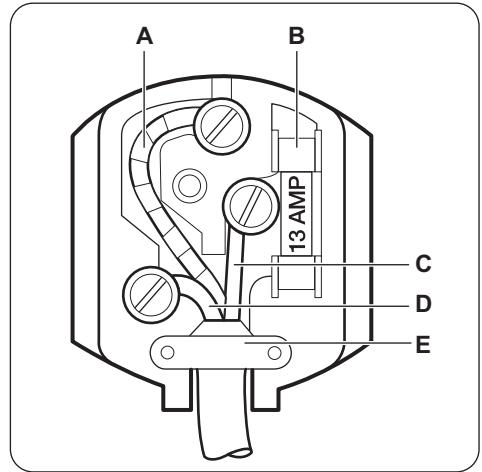

- **A** - green and yellow: Earth
- **C** - brown: Live
- **D** - blue: Neutral

As the colours of the wires in the mains lead of this appliance may not correspond with the coloured markings identifying the terminals in your plug, proceed as follows:

1. Connect the wire coloured green and yellow to the terminal marked either with the letter "E" or by the earth symbol  $\oplus$  or coloured green and yellow.
2. Connect the wire coloured blue to the terminal either marked with the letter "N" or coloured black.
3. Connect the wire coloured brown to the terminal either marked with the "L" or coloured red.
4. Check that no cut, or stray strands of wire is present and the cord clamp (**E**) is secure over the outer sheath. Make sure the electricity supply voltage is the same as that indicated on the appliance rating plate.
5. Switch on the appliance.

The appliance is supplied with a 13 amp fuse (**B**). In the event of having to change the fuse in the plug supplied, a 13 amp ASTA approved (BS 1362) fuse must be used.



### WARNING!

A cut off plug inserted into a 13 amp socket is a serious safety (shock) hazard. Ensure that it is disposed of safely.

## Technical information

---

### Technical data

|                          |       |           |
|--------------------------|-------|-----------|
| Dimensions of the recess |       |           |
| Height                   | mm    | 815       |
| Width                    | mm    | 596       |
| Depth                    | mm    | 550       |
| Rising time              | Hours | 29        |
| Voltage                  | Volts | 230 - 240 |
| Frequency                | Hz    | 50        |

The technical information are situated in the rating plate, on the external or internal side of the appliance and in the energy label.

## ENVIRONMENT CONCERNS

---

Recycle the materials with the symbol . Put the packaging in applicable containers to recycle it. Help protect the environment and human health and to recycle waste of electrical and electronic appliances. Do not dispose

appliances marked with the symbol  with the household waste. Return the product to your local recycling facility or contact your municipal office.









[www.zanussi.com/shop](http://www.zanussi.com/shop)



211622666-B-202015