

FERMAX

100 CODE MEMOKEY

MANUAL DE INSTALADOR INSTALLER'S MANUAL MANUEL D'INSTALLATION
INSTALLATIONSHANDBUCH MANUAL DO INSTALADOR MANUAL DE INSTAL
MANUAL MANUEL D'INSTALLATION INSTALLATIONSHANDBUC
INSTALADOR MANUAL DE INSTALADOR INSTALLER'S MANUA
INSTALLATIONSHANDBUCH MANUAL DO INSTALA
INSTALADOR INSTALLER'S MANUAL MANUEL D'INSTALLATION
SHANDBUCH MANUAL DO INSTALADOR MANUAL DE INSTAL
MANUAL MANUEL D'INSTALLATION INSTALLATIONSHANDBUC
ESTALADOR MANUAL DE INSTALADOR INSTALLER'S MANUA
TALLATION INSTALLATIONSHANDBUCH MANUAL DO INSTALA
STALADOR INSTALLER'S MANUAL MANUEL D'INSTALLATION



cityline



skyline

USER & INSTALLER'S MANUAL

ENGLISH

KEYPAD MODULE TEST

This kit is programmed at the factory with **3 default codes**. The preprogrammed codes are different for each unit, therefore you are the only one to know them.

You can use this codes to test the equipment operation as well.

To test the code, dial the the one corresponding to the device you want to verify.

CODE	ACTION
CODE 1 (*)	OPEN THE DOOR
CODE 2 (*)	ACTIVATE THE AUXILIARY DEVICE (if any)
CODE 3 (*)	BOTH OPEN THE DOOR AND ACTIVATE THE AUXILIARY DEVICE

(*) These codes are shown in a sticker in the back side of the panel controller.

Code 97528I, V04_13

Technical publication of an informative nature published by FERMAX ELECTRONICA S.A.U.

As part of its policy of constant improvement, FERMAX ELECTRONICA S.A.U. reserves the right to modify the content of this document and the characteristics of the products referred to in it at any time and without prior notice.

Any modification will be reflected in subsequent editions of this document.

PROGRAMMING MANUAL INDEX

<i>Introduction....</i>	4
<i>Function Programming and Configuration</i>	6
Changing the Master Code.....	9
Establishing the User Code Length	10
Full Reset of All Codes	12
Restoring Factory Settings	13
Adding or Editing User Codes	14
Deleting User Codes	16
Allowing User Codes to be Changed.....	17
Changing the Free Access Code.....	18
Activating/Deactivating the Free Access Button	20
Enabling/Disabling the Exit Buttons (interior)	21
Timing Lock-Release Activat. Relays and Aux. Devices.....	22
Enabling the Auxiliary Output (AUX).....	24
<i>Quick Programming Guide.....</i>	26
<i>Technical Features</i>	29
<i>Wiring Diagram.....</i>	30

USER MANUAL INDEX

<i>Introduction....</i>	31
<i>Keypad Operation.....</i>	32

PROGRAMMING MANUAL

Introduction

The Memokey's 100 codes are designed for keypad based access control, where we want each system user to have their own access code.

System Features:

- The Memokey has capacity for 100 different codes of variable length (between 4 and 6 digits).
Entering one of the codes via the keypad activates a relay which activates the lock-release or another device.
- The system does not allow user codes to be repeated.
- To enter programming mode, you must enter a special code, known as the Master Code.
- If this option is enabled, any user can modify their personal access code without knowing the Master code.
- The system has an auxiliary output which supplies a maximum of 125mA to connect/activate another device (auxiliary relay, alarm ...) or a speaker, with the memokey itself generating an alarm tone.
- It is equipped with 2 auxiliary inputs for the exit button.
- Free Access Codes
- Key Press Confirmation via an acoustic tone.

The following sections in the Manual explain in detail the configuration and management of each of the system functions.

Acoustic Tones and Signal Leds.

The Memokey has a series of acoustic tones and leds which advise as to the system's current status:

Acoustic Tones: Each time an access code, programming code or configuration setting is entered the system emits a different tone depending on whether the data entered is correct or not:



beep (x3) : correct

noc : incorrect

beep (1 second) : Lock Release

Signal Leds: Has two leds, one red and one green.



RED - GREEN	DEFINITION
○ ○	No Power
● ○	Normal mode (awaiting access code entry, programming...). Device Powered Up.
● ●	Opening Door
● ↻ ● ↻	Quick Flashes: Programming Mode Slow Flashes: Awaiting the new value for the selected function

(● Led on ○ Led off ↻ Leds flashing)

PROGRAMMING AND CONFIGURATION

Programming Mode allows you to modify the system's different settings and configuration.

Initially the system is programmed by default with a 4 digit code. As such the user codes and MASTER code are 4 digits in length. If you require greater security you can change the length to 5 or 6 digits. See the chapter on: "Establishing the User Code Length"

- 1) To enter *programming mode* (having been in normal mode), enter the **Master Code** (1480 by default).

The system emits “3 beeps” to advise we are in programming mode, and the green led flashes in quick sequence.

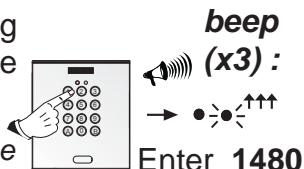

- 2) To configure each of the functions (in programming mode) enter the corresponding function code (for example: “A4” code length).

At this point the system once again emits “3 beeps” to advise that the setting entered is correct, and the green led flashes in a slow sequence .

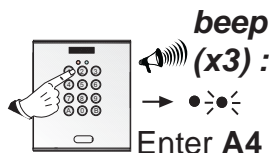

- 3) Then a new value is entered to be assigned to the function selected (for example: selecting a code of 6 digits in length).

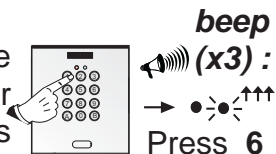

To exit Programming mode at any time, press **B** or allow 20 seconds to elapse without any activity.

NOTES:

Default Master Code:





- 4 digit length: **1480**
- 5 digit length: **14803**
- 6 digit length: **148036**

If for any reason we need to reset the master code, having forgotten the previous one (refer to the corresponding chapter: “Restoring Factory Settings”), this will be the master code established for this operation.

Below are all the system functions and the configuration steps for each of these.

Changing the Master Code (A0)

The Master code is necessary to enter programming mode. The equipment is programmed with a default Master code in factory (**1480 by default**). ***The procedure to change it is the following:***





	1 Enter programming mode:	Code Master (1480)	 Bip (3 x)
	2 Enter the relevant option:	A0	 Bip (3 x)
	3 Indicate the new Master code:	New Master Code	 Bip (3 x)
	<i>Example:</i> <i>New Master Access Code for Programming. 1234</i>	1480 A0 1234	

NOTE: If you forget the Master code, you can reset it to the default code of 1480, as explained in the “Restoring the Master Code” section.

A master code cannot be a user code and vice versa.

Establishing the User and Master Code Length (A4)

Initially the user codes are 4 digits in length, including the MASTER code. If you require greater security you can change the length to 5 or 6 digits.

	1 Enter programming mode:	Code Master (1480)	 Bip (3 x)
	2 Enter the relevant option:	A4	 Bip (3 x)
	3 Indicate the new length:	4, 5 or 6	 Bip (3 x)
	<i>Example :</i> <i>6 Digit Access and Master Codes</i>	1480 A4 6	

NOTE:

If once the user codes have been programmed their length is changed to include a greater number of digits, additional zeros will be added to the existent codes to bring them in line with the new length.

e.g.: User Code:

- 4 digits: 1234 => select a greater n° of digits.

For example: 6

- 6 digits: 1234**00**Code.

If once the user codes have been programmed their length is changed to include a fewer number of digits, the existent codes will have the last digits removed to bring them in line with the new length.

e.g. User Code:

- 6 digits: 123456 => select a fewer n^o of digits.

For example: 4

- 4 digits: 1234

If additional digits are to be re-added to the **existing** codes, the original digits will automatically be re-added.

e.g. User Code:

- 4 digits: 1234 => select a greater n^o of digits.

For example: 6

- 6 digits: 1234**56**

Each time the code length is changed, the existing codes should be reset to avoid the codes being deleted or overwritten. The configuration of “code length” should be done before setting up the codes on the system.

This will also effect the MASTER Code and the Free Access Code.

Default Master Code:

- 4 digit length: **1480**
- 5 digit length: **14803**
- 6 digit length: **148036**





Default Free Access (trade) Code :

- 4 digit length: **1593**
- 5 digit length: **15935**
- 6 digit length: **159357**

If for any reason we need to reset any of these codes, having forgotten the previous one (refer to the corresponding chapter: “Restoring Factory Settings”), these are the codes that will be set on undertaking the operation in line with the code length established on the system.

Full Code Reset (A9)

This operation allows deletion of ***all existing*** access codes in the system’s memory.

	1 Enter programming mode	Code Master (1480)	 Bip (3 x)
	2 Enter the relevant option:	A9	 Bip (3 x)
	3 Re-enter the master code (<i>set by default as 1480</i>) to confirm all codes have been deleted.	1480	 Bip (3 x)
	<i>Example :</i> <i>Reset all existing access codes.</i>	1480 A9 1480	

NOTE: Resetting is an **irreversible operation**, whereby any previously stored codes cannot be recovered.

Restoring Factory Settings

Resetting the Master and Free Access/Trade Code (where you have forgotten the previous one)





This operation is carried out by electrically modifying the equipment, in the aim of ensuring it is impossible for anyone without physical access to the equipment to modify it in any way.

1. Disconnect the system's power supply.
2. Short-circuit the "S2" and the system.
If the system is equipped with a PI exit button, just press and hold it down (refer to the installation diagram).
3. Reconnect the system's power supply and remove the short-circuit (or release the exit button) within 5 seconds.
4. If the process has been carried out correctly a double "beep" will sound and the green light will stay on. Next enter the following code **A708B9**. A double "beep" will sound and the system will reset itself, restoring its factory settings.

NOTE: The restoration of default factory settings does not delete the rest of the information programmed on the system.

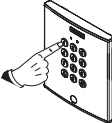
Add or Edit User Codes (0099)





The codes are stored in the memory in sequence: **position - code - action**. Allows up to 100 access codes be stored.

	<p>1 Enter programming mode:</p>	<p>Code Master (1480)</p>	 <p>Bip (3 x)</p>
	<p>2 Enter the position in the access code's memory:</p>	<p>00...99</p>	 <p>Bip (3 x)</p>
	<p>3 Re-enter the new access code: (The code length must coincide with that established on the system).</p>	<p>New Access Code</p>	 <p>Bip (3 x)</p>
	<p>4 Enter the associated action: 1: The door will open. (Relay 1) 2: The auxiliary device will be activated (if exists). (Relay 2) 3: The door will open and the auxiliary device will be activated simultaneously.</p>	<p>1, 2 or 3</p>	 <p>Bip (3 x)</p>
	<p><i>Example: New access code 1111 saved in the 00 position.</i></p>	<p>1480 00 1111 1</p>	

NOTES: If the position to be recorded is already in use, the new code will replace the old one. If the code entered already exists you cannot record and an error message will sound. **It is very important that a list is prepared of the codes, their positions and actions.**

Deleting User Codes (AA)

It is possible to delete a specific user code. The procedure to follow is the following:



	1 Enter programming mode:	Code Master (1480)	 Bip (3 x)
	2 Enter the relevant option:	AA	 Bip (3 x)
	3 Enter the position of the access code to be deleted in the system's memory:	00...99	 Bip (3 x)
	<i>Example: Delete the access code saved in the 00 position.</i>	1480 AA 00	

NOTES: It is only possible to delete a code if the associated position is known, based on which we reiterate the importance of keeping a list with the position data, codes and actions programmed on the system.

Deleting a code is irreversible, such that once a code has been deleted it cannot be recovered.

Allows user codes to be changed by users themselves (A7)

Users can change their assigned access code for another code of their choice if they wish. To do this the following option must be enabled.





	1 Enter programming mode:	Code Master (1480)	 Bip (3 x)
	2 Enter the relevant option:	A7	 Bip (3 x)
	<i>Example: Allows users change their personal access code</i>	1480 A7	



NOTE: See the User Manual Section.

Changing the Free Access Code (A1)

There is a special “free access” code (initially this code is: “1593”) which allows free access via an additional button. It has an associated default relay which activates the lock-release.

This function is especially useful when you want to offer free access to an area to be controlled. Entering the “free access” code, (by default 1593), the button remains enabled until this code is re-entered at which point it will be disabled.

	1 Enter programming mode:	Code Master (1480)	 Bip (3 x)
	2 Enter the relevant option:	A1	 Bip (3 x)
	3 Enter the Free Access Code:	New Free Access Code	 Bip (3 x)





	<p>4 Enter the associated action:</p> <p>1:The door will open. (Relay 1). 2:The auxiliary device will be activated (if exists). (Relay 2). 3: The door will open and the auxiliary device will be activated simultaneously.</p>	<p>1, 2 or 3</p>	 <p>Bip (3 x)</p>
	<p><i>Example :Create a Free Access Code: 5251 to open the door.</i></p>	<p>1480 A1 5251 1</p>	

NOTE: The default free access (trade) code based on the number of digits will be:

- 4 digit length: **1593**
- 5 digit length: **15935**
- 6 digit length: **159357**

Activate/Deactivate the Free Access Button



Entering the “free access” code, (by default 1593), the button remains enabled until this code is re-entered at which point it will be disabled.



	<p>1 Enter the “free access” code (1593 by default)</p>	<p>Free Access Code (1593)</p>	 <p>Bip (3 x)</p>
	<p>2 Button Enabled</p>		
	<p><i>Example: Enable the “free access” button.</i></p>	<p>1593</p> 	
	<p>4 Re-enter the “free access” code (1593 by default)</p>	<p>Free Access Code (1593)</p>	 <p>Bip (3 x)</p>
	<p>5 Button Disabled.</p>		
	<p><i>Example: Disable the “free access” button.</i></p>	<p>1593</p>	

Enabling/Disabling the Exit Buttons (A5 - A6)

The system can be equipped with one or two buttons (P1 and P2) which are installed in the interior of the building and allow you to open the door (relay activation) from inside or activate an additional electronic device installed.

These buttons can be enabled or disabled in the following way:

	1 Enter programming mode:	Code Master (1480)	 Bip (3 x)
	2 Enter the relevant option: A5: 1 Button. (Relay 1) A6: 2 Button. (Relay 2)	A5 or A6	 Bip (3 x)

	<p>3 Enter the associated action:</p> <p>0: Button Disabled.</p> <p>1: Button Enabled. Action, the door will open. (Relay 1)</p> <p>2: Button Enabled. Action, the auxiliary device will be activated (if exists). (Relay 2)</p> <p>3: Button Enabled. Action, the door will open and the auxiliary device will be activated simultaneously.</p>	<p>0, 1, 2 or 3</p>	 <p>Bip (3 x)</p>
	<p><i>Example : Enable exit button 1 to open the door.</i></p>	<p>1480 A5 1</p>	





Relay Timing:

- lock-release activation (A2)

- auxiliary device activation (A3)

Initially the relays (which will activate the lock-release or the auxiliary device) are set at 3 seconds.

The activation time can be changed to any value between 00 and 99 seconds or it can also operate in bistable mode (the first valid code activates the relay and the next one deactivates it):



	<p>1 Enter programming mode:</p>	<p>Code Master (1480)</p>	 <p>Bip (3 x)</p>
	<p>2 Enter the relevant option: A2 Relay 1 (lock-release) A3: Relay 2 (additional electrical device activation)</p>	<p>A2 or A3</p>	 <p>Bip (3 x)</p>
	<p>3 Enter the new activation code or select bistable mode:</p>	<p>00: Bistable Mode 01..99: (01 to 99 seconds)</p>	 <p>Bip (3 x)</p>
	<p>4 Enter 1 if the device is normally deactivated. Enter 0 if the device is normally activated.</p>	<p>1 or 0</p>	 <p>Bip (3 x)</p>
	<p><i>Example: Change the relay timing to 5 seconds and normally deactivated.</i></p>	<p>1480 A2 05 0</p>	

NOTE: The most common case is that of normally deactivated devices such as normal lock-releases for example. The inversely operated lock-releases on the other hand are normally activated devices.

Enabling the Auxiliary Output (all-purpose device) - AUX (A8)

This equipment has a free contact auxiliary output which can be connected to a 12 Vdc device with a maximum current of 125 mA to carry out various functions.

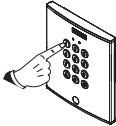
Where the equipment to be connected does not adjust to these specifications, a relay should be used (Ref. 2013).

	1 Enter programming mode:	Code Master (1480)	 Bip (3 x)
	2 Enter the relevant option:	A8	 Bip (3 x)



3 Select the option **you** require:

0: The all purpose output is not used (by default). The auxiliary output remains deactivated.

1: Each time a valid code is entered a 1 second pulse will be generated.

2: Every time Relay 1 is activated the all-purpose device will also activate, and will remain activated for 5 seconds longer than the associated device.

3: The all purpose output will switch every time a valid code is entered.

4: The all purpose output will be activated and will remain active every time you press "A" and a valid keypad code, (purpose output will remain during 1 minute active).

5: The all purpose output activates once 5 erroneous codes are entered in order, and will remain active for 5 minutes or until a valid code is entered.

6: The all purpose output activates once any key is pressed or deactivates after 15 seconds with inactivity.



**Bip
(3 x)**

Example: Enable auxiliary output.

1480 A8 1

GUIDE RAPIDE DE PROGRAMMATION

Function Code	Function Description
00...99	Activation and Assignment of Access Codes (100 codes).
A A	Code Deactivation.
A0	Master Code Programming.
A1	Programming the Free Access (trades) Code.
A2	Programming the Relay Activation Time. (Relay 1)
A3	Programming the Auxiliary Device Time. (Relay 2)
A4	Changing the code length from 4 to 6 figures.
A5	Enabling/Disabling the P1 lock-release exit button.(Relay 1)
A6	Enabling/Disabling the P2 auxiliary device button. (Relay 2)
A7	Enabling/Disabling the option for users to change their code.
A8	All-Purpose Device Auxiliary Output Configuration (which is called "AUX").
A9	Delete all Codes.

Sequence of codes to be entered:



**Code Master
(1480)**

+

			Example
00...99 Memory Position	+	Access Code (4 to 6 digits) + associated action (1, 2 or 3).	1480 02 1144 1
AA	+	00...99: Memory Position of the Code to be Deleted .	1480 AA 02
A0	+	New Master Code	1480 A0 1234
A1	+	New Free Access Code:	
A2/A3	+	00: Bistable Mode 01..99 (01 to 99 seconds)	1480 A2 00 0 1480 A2 05 1
A4	+	4, 5 or 6	1480 A4 6

Sequence of codes to be entered:



**Code Master
(1480)**

+

			Example
A5/ A6	+	0: Button Disabled.	1480 A5 0
		1: Button Enabled. Lock Release. (Relay 1)	1480 A5 1
		2: Button Enabled. Activate auxi- liary devices. (Relay 2)	1480 A5 2
		3: Button Enabled. Activate door + auxiliary device simultaneously	1480 A5 3
A7	+	Allowing User Codes to be Chan- ged	1480 A7
A8	+	All-Purpose Device Auxiliary Out- put Configuration (0, 1, 2, 3, 4, 5 or 6).	1480 A8 1
A9	+	Code Master (1480)	1480 A9 1480

TECHNICAL FEATURES

Power Supply: 12 Vdc/Vac.

Operating Temperature: -20° to 55° C.

Capacity: 100 Access Codes Non-Volatile Memory.

Consumption:

* **On standby:** 40 mA

* **With the lock-release relay active:** 110 mA

Panel Connectors:

+, -: 12 Vdc Power Supply.

C1, R1: relay output 1 (potential free)

- C1: relay 1 common wire (lock-release).

- R1: Normally open (NA) or normally closed (NC) contact (based on configuration).

C2, R2: relay output 2 (potential free)

- C2: relay 2 common wire (lock-release).

- R2: Normally open (NA) or normally closed (NC) contact (based on configuration).

A: auxiliary/panic output. Collector Output Open. Maximum current of 125 mA

CABLING DIAGRAM

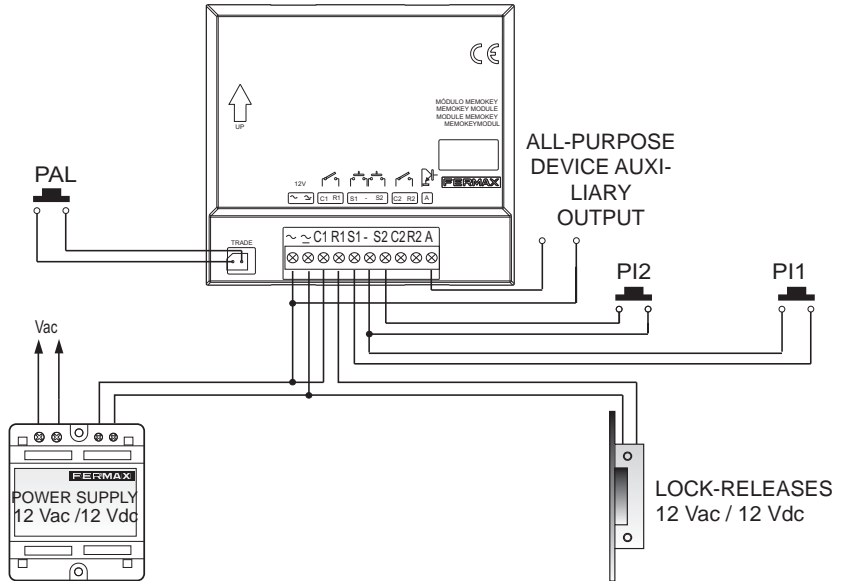

Memokey Connections:

PI1-Output Button (S1,-): Button to open the door from inside.

PI2-Exit Button (S2,-): Auxiliary Electronic Device Activation Button.

PAL-Free Access Button (TRADE): Optional button to allow free access to the building.

Notes:

The operating parameters for the free access, auxiliary exit (all purpose) and lock-release buttons are configurable.

Use a lock-release suitable for the power supply you are going to use (Vac or Vdc).

USER MANUAL

Introduction

This equipment includes a **keypad** which allows the door be opened in addition to the activation of an auxiliary electronic device on entering a personalised code.

It is possible to programme up to 100 **different personalised** codes.

Generally one of these codes is given to each of the system **users**, taking users to be not just the people that frequently access the residence or the area, but also those who will be granted access in the future (for example in the case of offices). In the case of personalised codes, we can prohibit the use of any code by a specific user just by deleting the code from the system.

Management of all these personalised codes (activation, deactivation, etc) is done by the system **administrator**.

NOTES:

- ✓ The SYSTEM ADMINISTRATION can assign a personal code for opening the door and/or activate auxiliary devices for any of the authorised users.
- ✓ Users can change their personal code if this option has been enabled by the SYSTEM ADMINISTRATOR.
- ✓ The system has anti-sabotage protection, such that once 5 erroneous codes have been entered on the keypad it will remain locked for 30 seconds, emitting a warning tone throughout this period.

Keypad Operation

- Code: ***Code to be entered using the keypad to activate the lock-release.***
- Emergencies: ***Opens the door and generates an alarm tone (where this option has been configured).***
- Free Access: ***Entering this code the door will remain open until the free access code is re-entered.***
- Changing the Code: ***Users can change their own personal code if this option has been enabled by the SYSTEM ADMINISTRATOR.***

FERMAX

User: _____

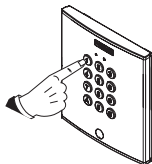

Code: _____

Emergencies (*):



'A' + CODE

Free Access (*):



Change Code (*):

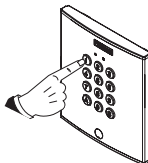

**'AB' + CODE to be
changed + NEW**

(*) This option should be enabled. Contact the system administrator.

Cut out and deliver a copy of this section to each of the users.

FERMAX