

INSTRUCTION MANUAL

PA Combo Amplifier ACDT90

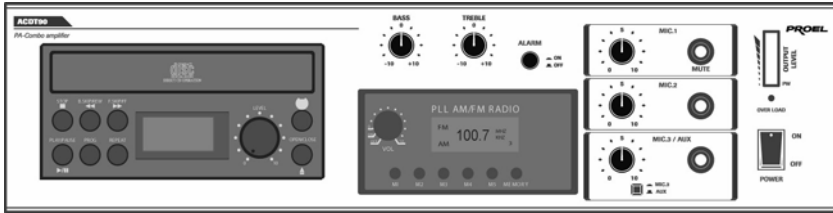

PROEL

UK

1. IMPORTANT SAFETY INSTRUCTIONS



CAUTION: To reduce the risk of electric shock do not remove cover (or back panel). No user serviceable parts inside. Refer servicing to qualified personnel only.

WARNING: To reduce the risk of fire or electric shock, do not expose this apparatus to rain or moisture.



This symbol is intended to alert the user of the presence of uninsulated dangerous voltage within the product enclosure that may be of sufficient magnitude to constitute a risk of electric shock to persons.



This symbol is intended to alert the user of the presence of important operating and maintenance (servicing) instruction in the literature accompanying the appliance. Please carefully read the owner's manual.

INSTRUCTIONS:

All safety and operating instructions should be read before the product is operated.

Retain these instructions:

All safety and operating instructions should be retained for future reference. This owner's manual should be considered as a part of the product and it must accompany it every time, and delivered to the new user when this product is sold. In this way the new owner will be aware of all the installations, operating and safety instructions.

Heed all warnings:

All warnings on the product and in owner's manual should be adhered to. Heed all warnings.

Follow all instructions:

All operating and user's instructions must be followed.



Sentences preceded by  symbol contain important safety instruction. Please read it carefully.

DETAILED SAFETY INSTRUCTIONS.

Water and moisture:

This apparatus should not be used near water (i.e. bathtub, kitchen sink, swimming pools, etc.)

Ventilation:

This apparatus should be placed in a position that doesn't interfere with correct ventilation. This unit, for example, should not be placed on a bed, sofa cover or similar surfaces that could cover ventilation openings, or placed in a built-in installation, such a bookcase or a cabinet that could block air flow through ventilation openings.

Heat:

This apparatus should be placed away from heat sources, like radiators, heat registers, stoves or other products (including amplifiers) that produce heat.

Power sources:

- This apparatus should be connected only to power source type specified in this owner's manual or on the unit.
- If the supplied AC power cable plug is different from the wall socket, please contact an electrician to change the AC power plug.

Grounding or Polarization:

- All precautions must be observed in order to avoid grounding or polarization defeating.
- Unit metal parts are grounded through the AC power cord.
- If the AC power outlet doesn't have grounding, consult an electrician for outlet grounding.

Power cord protection:

The power cord should be routed in a way it will not be walked on or pinched by items placed upon or against it, paying particular attention to cords at plugs, convenience receptacles and wall outlet.

Cleaning:

- You can clean the unit with a compressed air flow or a wet cloth.
- Don't clean the unit using solvents like trichloroethylene, thinners, alcohol, or other fluids with very strong volatility and flammability.

Non use periods:

The unit AC power cord should be unplugged from the outlet if it's unused for a long period.

Objects or liquid entry inside the unit:

Be careful that no objects fall or liquid is spilled inside the unit through ventilation openings.

Safe power line use:

- Keep firmly the plug and the wall outlet while disconnecting the unit from AC power.
- If the unit will not be used for a long period of time, please unplug the power cord from AC power outlet.
- In order to avoid unit power cord damages, please don't strain the AC power cable and don't bundle it.
- In order to avoid unit power cord damages, please be sure that the power cord is not walked on or pinched by heavy objects.

Unit relocation:

Before any unit relocation please control the unit is turned off. The power cord must be unplugged by the wall outlet, and all the connections wires should be disconnected as well.

Don't open this unit:

Don't attempt to open or to repair this unit by yourself. For any problem solution not described in this owner's manual, please refer to qualified personnel only or consult us or your National Distributor. Any improper operation could result in fire or electric shock.

Damages requiring services:

- Don't attempt to do operations not described in this user's manual.
- In the following cases please refer to an authorized maintenance center or skilled personnel:
 - When the unit works improperly or it doesn't work at all.
 - If power cord or plug are damaged.
 - If liquid has spilled, or objects have fallen into the unit.
 - The unit has been exposed to rain.
 - The unit doesn't operate normally or it exhibits a marked change in performance.
 - If the product has dropped or it has been damaged in any way.

Maintenance:

The user shouldn't attempt maintenance operation not described in this user's manual. Every maintenance operation should be done by qualified personnel only.

IMPORTANT SAFETY INSTRUCTIONS:

- Install this unit following owner's manual instructions.
- Don't install, connect or disconnect power supply when the unit is powered, otherwise there's an high risk of electric shock.
- Don't open the unit, there are no user serviceable parts inside.
- If you detect a particular smell from the unit, please immediately turn it off and disconnect the AC power cord.
- Don't block the unit ventilation openings.
- Avoid using this unit in overload for a long period.
- Don't force commands (switches, controls, etc.)

UK

- To obtain good speakers wire contacts, please tighten the screw terminals firmly.
-  For safety reason, don't defeat the grounding connection. Grounding is useful for user safety.
- Use only manufacturers suggested connectors and accessories.
- This unit should be placed in a rack (see INSTALLATION) and kept far from:
 - Wet places
 - Direct exposure to heat sources (like sun light)
 - Non properly ventilated places
- Disconnect the power cord during storms or when the unit is not used.

-  In order to prevent fire and electric shock risks, it's necessary to keep the unit far from sprinkling and drops. Please don't put cups, vases or other object containing liquids over the unit. In case of interferences from source signal, THD value will raise over 10%. Don't place this unit in a bookshelf or in other places with small room.
- PROEL S.P.A. is not responsible for any damage that occurs due to a wrong unit installation.

Thank you for choosing one of Proel products, and for your confidence towards our brand, synonymous of professionalism, accuracy, high quality and reliability. All our products are CE approved and designed for continuous use in professional installation systems.

2. DESCRIPTION

This unit is designed for speech, music, paging and sound reinforcement applications.

FEATURES

- State-of-the-art design and manufacturing accuracy.
- Wide frequency response: 50 Hz – 18KHz.
- Low distortion and low noise level.
- Digital AM FM tuner, with 5 memories for each band, and CD player sections built-in. Each section has its own independent power switch and volume control.
- Bass and Treble tone controls.
- LED level indicator.
- Two unbalanced microphone inputs, for dynamic microphones, and one unbalanced switchable Microphone/Aux input.
- Four outputs – one constant impedance outputs (4Ω) – three constant voltage outputs (25 V, 70 V, and 100 V).
- 24 V DC emergency power.
- Protection circuits.

3. FRONT PANEL DESCRIPTION

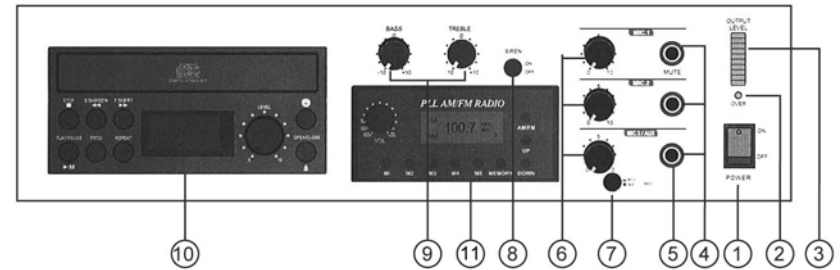

fig.1

1. Power On/Off switch.
2. Overload LED.
3. Output LED meter.
4. Unbalanced 1/4" jack (MIC1 and MIC2).
5. Unbalanced Microphone/Aux 1/4" jack.
6. MIC1, MIC2, MIC3/AUX volume controls.
7. MIC3/AUX switch.
8. Siren On/Off switch.
9. Tone controls (BASS and TREBLE).
10. CD player section.
11. Digital tuner section.

4. REAR PANEL DESCRIPTION

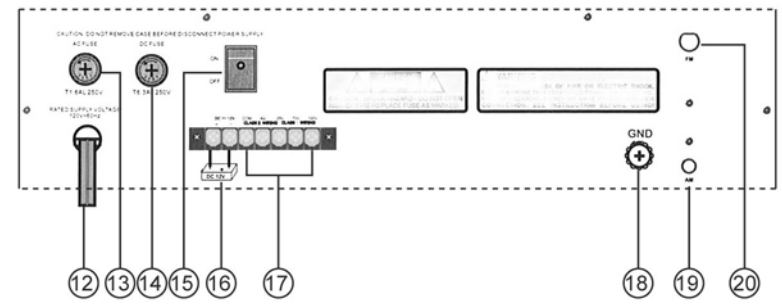
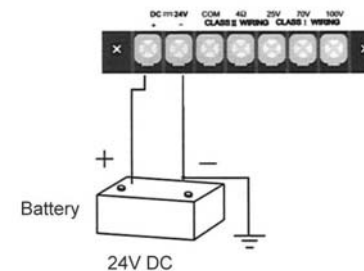

fig.2

12. IEC AC power socket.
13. AC type T 1,6 AL 250 V fuse-holder.
14. DC type T 10 AL 250 V fuse-holder.
15. Emergency DC power switch (24 V DC).
16. 24V DC emergency power terminal.
17. Speakers output for constant impedance/constant voltage.
18. Grounding terminal.
19. AM loop antenna.
20. FM antenna connector.

5. INSTALLATION

1. 24V DC emergency power connection (generator or battery).
 - Use terminals # **16** of **fig. 2**.
 - In case of AC power fault or black out, the unit will be powered by 24 V DC, with automatic and silent switchover to backup power.



Note: to activate this feature switch # **15** of **fig. 2** must be set to ON position.

- We inform our customers that if DC power supply is supplied by a battery, the unit won't be able to recharge the battery.
- When the amplifiers is powered by 24 V DC, amplifier nominal power will be reduced by 20%.

2. Input connections

- **MICROPHONE CONNECTION:**

Despite the kind of microphones you're using, please always use a shielded wire.

Please see the following drawings for details about the different wirings:

Balanced low impedance microphone:

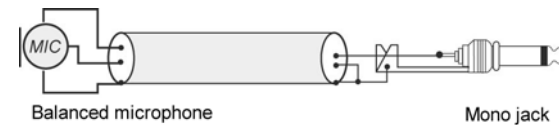

Unbalanced low impedance microphone:

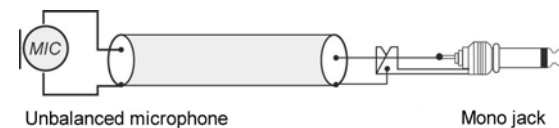

AUX balanced and unbalanced connections.

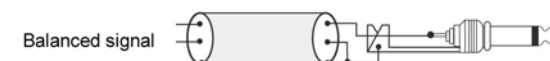
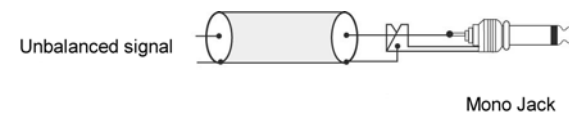

3. Output connections

⚠ Attention

To prevent the risk of electric shock, never touch amplifier outputs when the amplifier is turned on.

To access to the speaker connection terminals (**fig. 2 ref. 17**) remove the protection cover unscrewing the screws.



This unit can be used both with constant impedance speakers (4 Ω) and constant voltage speakers (25V, 70V, and 100V).

CONSTANT IMPEDANCE LINE

To use this amplifier with a constant impedance line (4Ω), please connect the COM terminal to the negative post of your speaker, and connect the 4Ω terminal to the positive post COM (**fig. 2 ref. 17**).

- To obtain the best performances, total speakers impedance connected to the line, should be equal to the amplifier output impedance.
- The speakers power sum should not be lower than the amplifier output power.
- We suggest you don't use long cables. Anyhow, for longer distances application use a thicker cable.

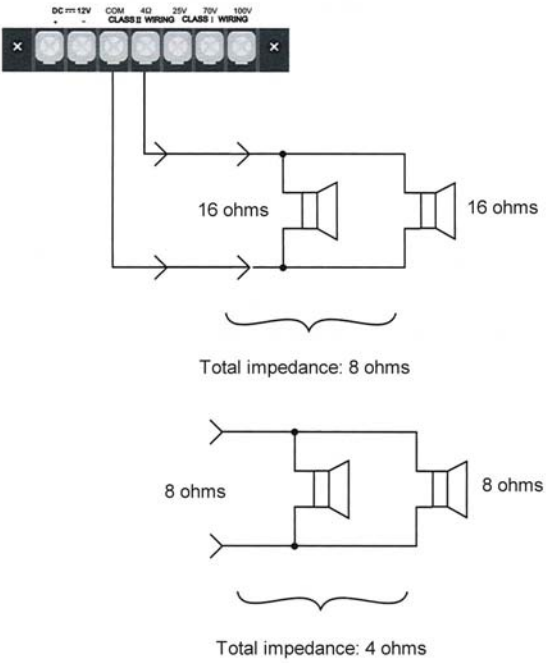



CONSTANT VOLTAGE LINE

If you're using a constant voltage line, connect either the 25V, 70, or 100V to the "+" side of the speaker system, and connect COM to "-" side of the speaker (fig. 2 ref. 17).

- Speakers should have a transformer of the same voltage developed by the amplifier.
- The speakers power sum should not exceed the amplifier maximum output power.

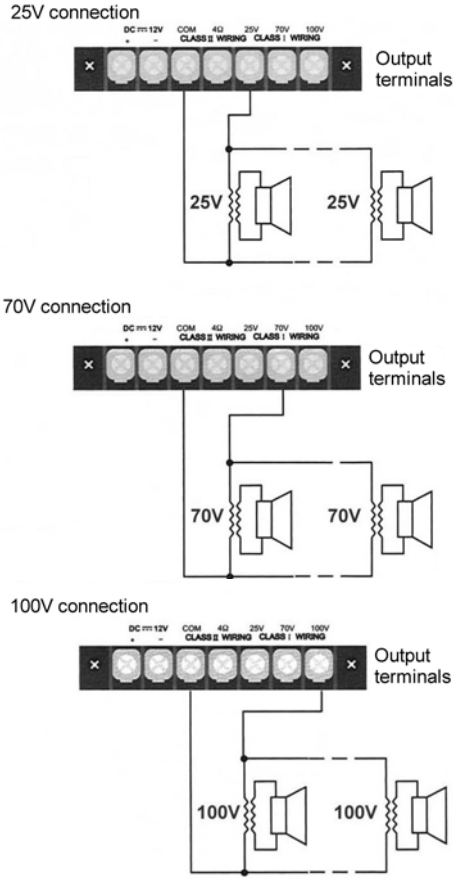

6. OPERATIONS:

1. Pressing the POWER switch the unit turns on, and its LED is lit. Pressing it again the unit turns off.
2. BASS control modifies signal lower frequencies output (up to 10 dB of boost or cut). Set this control level by personal taste and ambient acoustic character.
3. TREBLE control modifies signal higher frequencies output (up to 10 dB of boost or cut). Set this control level by personal taste and ambient acoustic character.
4. Turning clockwise MASTER volume control, the playback level will raise, turning it counter clockwise it will be lower.
5. LED ladder level indicator shows the output level. When red LEDs are lit, output signal may be distorted, so please lower the volume.

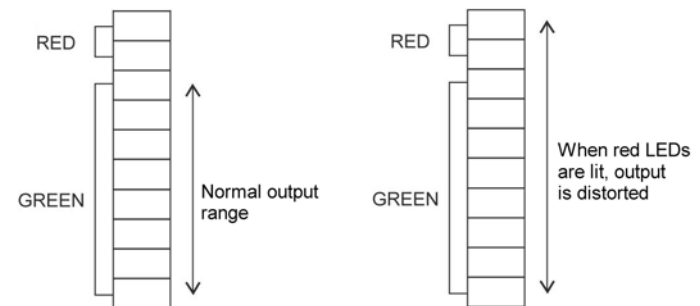

6. CD PLAYER SECTION.

- a. Pressing this section power switch (fig.1 ref.10) the display is lit and the CD player is ready for use.
- b. Pressing the **open/close** key the CD tray opens, now you can insert the CD and close the tray by pressing again the same key. After some seconds the display will show the CD track content, now it's possible to begin CD playback pressing **play/pause** key.

CD player functions:

- **OPEN/CLOSE.** Press this key to open/close the CD tray.
- **PLAY/PAUSE.** Starts/stops track playback.
- **LEVEL.** This control serves to set CD player volume.
- **STOP.** Stops CD playback.
- **B.SKIP/REV.** Pressing this key once, playback starts from the beginning of current track.
Pressing it twice, playback starts from the beginning of previous track. Keeping this key pressed, the CD will be in fast reverse play.
- **F.SKIP/FF.** Pressing this key once, playback starts from the beginning of next track.
Keeping this key pressed, the CD will be in fast forward play.
- **REPEAT.** Pressing this key once, the current track is in continuous playback. Pressing it twice, the whole CD is in continuous playback. Pressing it three times the CD player will resume to normal playback.
- **PROG.** It's possible to program the tracks you wish to play in a sequence of your choice. Pressing this key the display flashes, using the arrows keys you select the track you want to insert into program, then confirm it using again the PROG key. Repeat the same procedure to add other tracks to program. Pressing PLAY the CD player will begin programmed playback.
Note: It's possible to insert in a program up to 20 tracks.

7. RADIO

- **POWER.** From OFF position moving the knob clockwise the tuner is turned on.
- **PROGRAM LISTENING.** Radio station may be selected both manually both automatically.
- **AUTOMATIC STATION RESEARCH.** This feature can be used with strong and without interferences station signal.
 - a. Press BAND key to select desired band (AM or FM).
 - b. Press UP or DOWN key for about 2 seconds to start automatic radio station search. This search stops at first station with a good signal.

- **MANUAL SEARCH.** If signal is too weak, automatic search operation will not be possible, so it's necessary to perform manual search.
 - a. Press BAND key to select desired band (AM or FM).
 - b. Pressing shortly the UP or DOWN key, frequency will changes with 100KHz step. In this way it's possible to tune the radio tuner on every desired frequency.
- **MEMORY.** The receiver allows you to store in memory 5 FM station and 5 AM station. These radio station are recallable using M1-M5 keys on front panel.
- **STORING RADIO STATION.**
To store a radio station, after tuning the desired radio station please press the MEMORY key followed by the memory number to store the radio station (M1~M5).

NOTES.

- a. If, during the automatic search the tuner reaches the band end, the tuner will continue searching starting from the beginning of that band.
- b. When a new radio station is stored in an already used memory, the former radio station will be substituted by the new radio station.
- c. This unit is able to keep the stored memories for one week, even if no mains power is applied.

7. TROUBLESHOOTING

Problem	Solution
LED is not lit when the POWER switch is ON.	<ul style="list-style-type: none"> • Check that AC plug is firmly connected. • Check that the fuse is properly working.
Ventilation fan is not working.	<ul style="list-style-type: none"> • Check that AC plug is firmly connected. • Check that the fuse is properly working.
No sound or only a very low-level sound is heard.	<ul style="list-style-type: none"> • Check that inputs have been properly selected. • Check proper speakers connection.
Output signal is discontinuous, with hum and noises.	<ul style="list-style-type: none"> • Check that power supply is correct.

<p>There's no output signal on one or both channels.</p>	<ul style="list-style-type: none"> • Check speakers wires and overall line. • Check that pilot signal has a proper level.
<p>CD player display doesn't turn lit.</p>	<ul style="list-style-type: none"> • Check that dedicated CD player POWER switch is ON.
<p>No output signal from CD player.</p>	<ul style="list-style-type: none"> • Check that CD disk is clean and not defective.
<p>Output radio signal is distorted, there are many interferences or a very low-level sound is heard.</p>	<ul style="list-style-type: none"> • Check antenna proper connection. • Check antenna proper orientation. • Check that antenna is of the right type to receive desired radio station and band.
<p>Output radio signal is discontinuous, with hum and noises.</p>	<ul style="list-style-type: none"> • It frequently depends on neon light, lamps, engines and electric appliances generated interferences.
<p>LED level indicator shows signal but no signal is output.</p>	<ul style="list-style-type: none"> • Turn off the unit for some seconds thus resetting the protection circuit that probably has been turned on and turn on the unit again. • Check all input/output connections. • If the problem remains, please contact a qualified maintenance centre.
<p>CD player display shows an error message (ER..).</p>	<ul style="list-style-type: none"> • Open and close the CD player tray. • Cut the volume, turn off the CD player section for some seconds then turn on the CD player section again. • If the problem remains, please contact a qualified maintenance centre.

8. Technical specifications

Model	ACDT90
Output power	90 W RMS 130 W MAX
Constant impedance output	4Ω ~ 16Ω
Constant voltage output	25 V / 70 V / 100 V
Inputs connectors	MIC1 – MIC3: unbal. 6.3 mm jack 600Ω -52dB ±2 dB AUX 2: unbal 6.3 mm jack 600Ω / 10 KΩ, -20dB ±2 dB
Outputs connectors	4Ω on terminal board
Frequency response	50Hz – 18 KHz
Harmonic distortion	Less than 0.8% @ 1000Hz
Signal to noise ratio (tone controls defeat)	60 dB
Tone controls	BASS: ±10 dB @ 100Hz TREBLE: ±10 dB @ 10KHz
Controls	MIC1 volume control MIC2 volume control MIC3/ AUX volume control CD player volume control TUNER volume control TONES (BASS - TREBLE) Siren activation switch AC/DC mains power switch
Indicators	Power on LED Output power level LED ladder CD player and digital tuner display
AC power	220-240 V AC 60/50 Hz
DC power	24 V DC
AC Power consumption	225 W @ full RMS power
DC Power consumption	90 full RMS power
Dimensions (W x H x D)	400 mm x100 mm x 305 mm – 15.7 x 4 x 13.2 in.
Weight	9.45 Kg – 20 lbs
Color	Black

9. Typical hookup diagrams

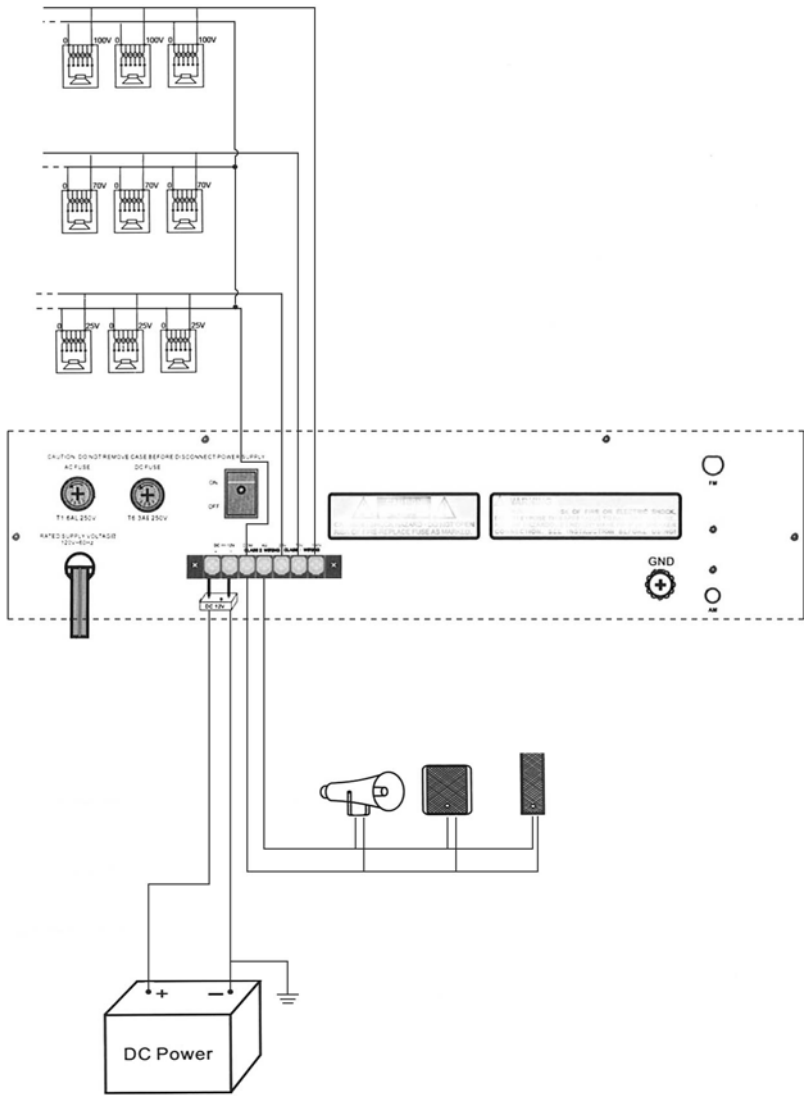

UK

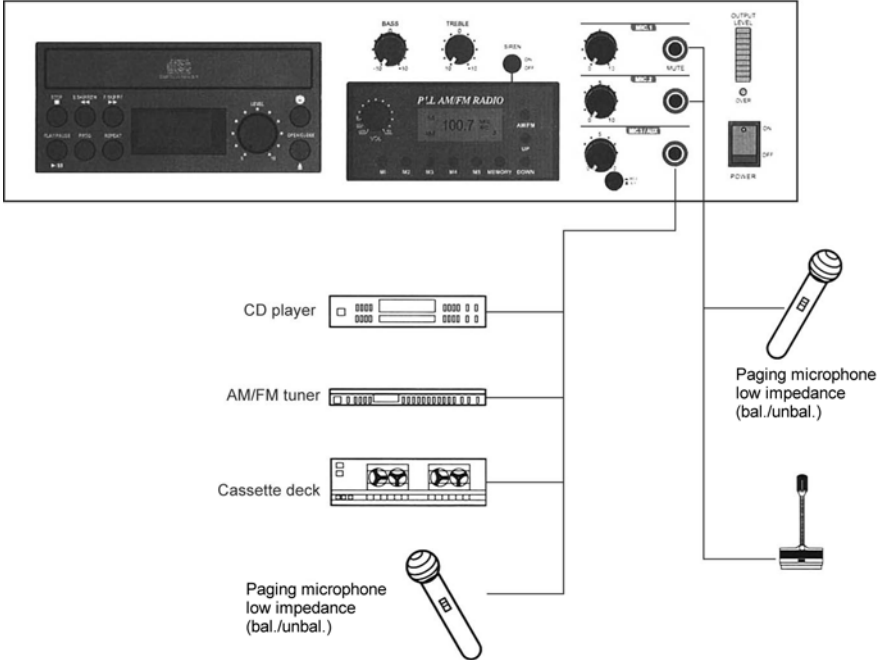



The product is in compliance with Directive 89/336/EEC (Electromagnetic Compatibility) and following modifications 92/31/EEC and 93/68/EEC, as the following standards:
EN 50082-1:1997, EN 55013:1990, EN 55020:1994

it is also in compliance with Directive 73/23/EEC (Low Voltage) and following modifications 93/68/EEC, as the following standard:
EN 60065:1998

Proel SpA pursue a policy of continuous research and development. Proel SpA reserve the right to modify product circuitry and appearance at any moment, without prior notice.



PROEL S.p.A.
(World Headquarters - Factory)
Via alla Ruenia 37/43
64027 Sant'Omero (Te) – Italy
Tel: +39 0861 811241
Fax: +39 0861 887862
E-mail: info@proelgroup.com

installation.proelgroup.com