



EN

Heart Rate Monitor with Speed and Distance

Model: SE300

USER MANUAL

PATENT PENDING

CONTENTS

Introduction	3
Training Information	3
How the Heart Rate Monitor Helps You	3
Training Tips	3
Product Overview	4
Watch	4
LCD	5
Getting Started	7
Unpacking the Watch	7
Wearing the Chest Belt and Watch	8
Transmission Signal	9
Signal Search	10
Setting the Keypad Tone / Light Mode	11
Activating the Backlight	11
Activating the Keypad Lock	12
Switching Between Operation Modes	12
Clock	12
Alarm	13
User Profile	14
Activity Level	15
Exercise Profile	15
Target Activity	17
Maximum / Lower / Upper Heart Rate Limit	17
Heart Rate Alert	18



2
EU

Calibration, Speed and Targets18

- Calibration18
- Unit for Speed and Distance20
- Speed Limit.....20
- Setting Target(s)21
- Using Target Function21
- Viewing Target Data when Workout is Paused or Stopped.....22

About the Smart Training Program.....23

- Using the Smart Training Program.....23
- Viewing Data While Smart Training Program is Running24
- Viewing Smart Training Program Memory Records.....25
- Recovery Heart Rate25

Stopwatch.....25

- Viewing Data while Stopwatch / Lap is Running26
- Viewing Overall or Lap Memory Records27

About the Fitness / Body Mass Index28

- Fitness Index28
- Body Mass Index.....29
- Viewing Fitness30

Care Instructions30

- Aquatic and Outdoor Activities31

Batteries31

Specifications33

Warnings35

About Oregon Scientific36

EU-Declaration of Conformity.....36



INTRODUCTION

Thank you for selecting the Oregon Scientific™ Heart Rate Monitor Watch (SE300) as your sports fitness product of choice.

IMPORTANT This product is for sport purposes only and it is not meant to replace any medical advice.

This manual contains important safety and care information, and provides step-by-step instructions for using this product. Read the manual thoroughly, and keep it in a safe place in case you need to refer to it later.

TRAINING INFORMATION

HOW THE HEART RATE MONITOR HELPS YOU

A heart rate monitor is the most important tool in cardiovascular health and an ideal training partner. It enables you to see and monitor results. This helps you assess your past performance, maximize your workout and adapt your future exercise program to achieve your desired goals in a safer and more effective way.

When you exercise, the chest belt picks up your heartbeat and sends it to the watch. Now you can view your heart rate and start monitoring your performance based on your heart rate readings. As you get fitter, your heart will need to do less work and the speed of your heartbeat will decrease. The reason for this is as follows:

- Your heart pumps blood to your lungs to obtain oxygen. Then, the oxygen rich blood will travel to your muscles. The oxygen is used as fuel and the blood leaves the muscles and returns to the lungs to begin the process again. As you get fit, your heart is able to pump more blood with every beat. As a result, your heart doesn't have to beat as often to get the necessary oxygen to your muscles.

TRAINING TIPS

To gain maximum benefit from your training program and to ensure that you exercise safely, please observe the following guidelines:



- Start with a well-defined training goal, such as to lose weight, keep fit, improve health or compete in a sporting event.
- Select a training activity you enjoy and vary your training activities to exercise different muscle groups.

- Start slowly, and then gradually step up your workout as you become fitter. Exercise regularly. To maintain a healthy cardio-vascular system, 20-30 minutes three times a week is recommended.
- Always allow at least five minutes before and after exercising for warm-up and cool-down.
- Measure your pulse after training. Then repeat the procedure again after three minutes. If it does not return to its normal resting rate, you may have trained too hard.
- Always check with your doctor before starting a vigorous training program.

PRODUCT OVERVIEW

WATCH



1. **LAP / MEM / -** : Display training records; decrease setting value; mark a lap
2. **MODE**: Switch to another display Mode; press and hold to search signal
3. **ST / SP / +** : Start / stop timer; increase setting value
4.  /  : Turn on backlight for 3 seconds; lock / unlock the keypad
5. **SET**: Enter setting mode; confirm setting; display different information during training or memory mode; reset timer / stopwatch / target countdown function

LCD

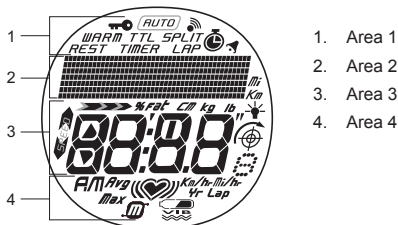

1. Area 1
2. Area 2
3. Area 3
4. Area 4

Area 1

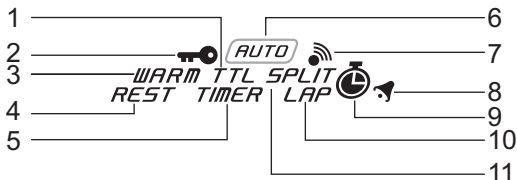

1. **TTL**: Total exercise time is displayed
2. : Keypad lock is enabled
3. **WARM**: Warm-up timer is shown or running
4. **REST**: Recovery timer is shown or running
5. **TIMER**: SMART TRAINING PROGRAM is shown or running
6. **AUTO**: Auto-lap is running
7. : Key tone is enabled
8. : Alarm is enabled
9. : Stopwatch is shown or running
10. **LAP**: Shows current lap time or memory lap time
11. **SPLIT**: Shows and calculates split time

Area 2

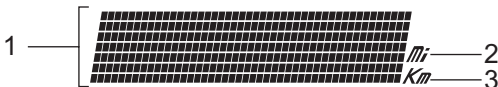

1. Displays mode and relevant info
2. *Mi* : Distance in miles
3. *Km* : Distance in kilometers



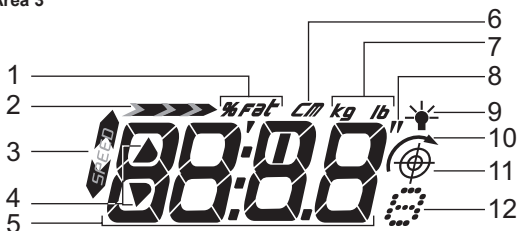



Area 3



1. *%Fat* : Percentage of fat burned
2. : Icon animates when a speed reading is being taken
3. : Flashes up / down arrow when the speed is out of zone
4. : Flashes up / down arrow when heart rate is out of zone
5. Displays information
6. *CM* : Height unit
7. *kg / lb* : Body weight units
8. : Height unit
9. : Light Mode is enabled
10. : Repeat function is activated
11. : Speed Mode is shown or running
12. : Speed Mode - shows target number;
Training Mode - shows number of repeats remaining

Area 4



1. (()) : Heart rate is above or below limit; audio heart rate alert is activated
2. *Avg* : Appears when average heart rate / average speed / average pace is displayed
3. *AM / PM* : Appears when the 12-hour clock / alarm is being used
4. *Max* : Maximum value of speed and distance is displayed
5.  : Appears when in memory mode
6.  : Flashes when auto-searching heart rate signal
7.  : Flashes when a signal has been found
8. *Km/hr* : Speed is displayed in Km/hr
9. *Mi/hr* : Speed is displayed in Mi/hr
10. *Lap* : Displays when lap is taken
11. *Yr* : Appears when setting year of birth
12.  : Battery status
 : Battery is too low for vibrate function
13.  : Vibration alert is activated

GETTING STARTED

UNPACKING THE WATCH

In this box, you will find:

- Watch
- Heart rate chest belt
- Adjustable elastic belt
- Storage pouch

- Bike mount
- 2 x CR2032 lithium batteries – already installed

To turn on the watch (first-time use only):

Press any key for 2 seconds to activate the LCD.

WEARING THE CHEST BELT AND WATCH**CHEST BELT**

The heart rate chest belt is used to count your heartbeat and transmit the data to the watch.

To wear the chest belt:

1. Wet the conductive pads on the underside of the chest belt with a few drops of water or a conductive gel to ensure solid contact.
2. Strap the heart rate chest belt across your chest. To ensure an accurate heart rate signal, adjust the strap until the belt sits snugly below your pectoral muscles.

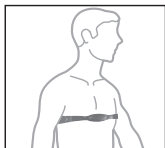
**TIPS**

- The position of the chest belt affects its performance. Move the chest belt along the strap so that it falls above your heart.
- Avoid areas with dense chest hair.
- In dry, cold climates, it may take several minutes for the chest belt to function steadily. This is normal and should improve with several minutes of exercise.

WATCH

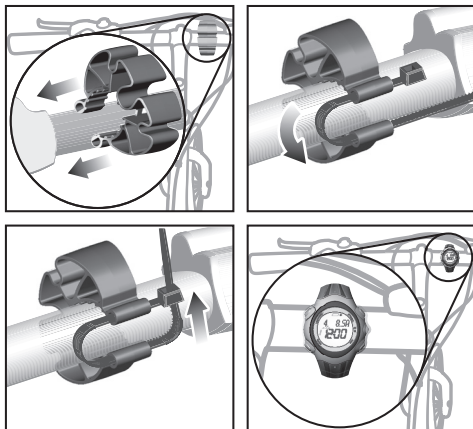

You can wear the receiver watch on your wrist or strap it to a bike or exercise machine, as shown below.



TRANSMISSION SIGNAL

The chest belt and watch have a maximum transmission range of about 62.5 centimeters (25 inches). They are equipped with the latest digital coding system to reduce signal interference from the environment and for more accurate readings.

NOTE Whenever the watch is searching for the chest belt signal (manual or automatic search), make sure that the chest belt is no further than 10 cm (4 inches) from the watch.

ICON	DESCRIPTION
 The outer heart flashes	Searching for a signal
 The inside heart flashes	A signal has been found
	No signal has been found

NOTE If the watch is kept idle without receiving a signal from the chest belt for 5 minutes, the heart rate and speed functions will be turned off.

IMPORTANT If the heart rate icon does not appear on the display or is not flashing because no signal has been found, force a signal search. See "Signal Search" section for how to do this.

In the event that you experience a weak signal or your signal is disrupted by interference in the environment, follow the instructions below to identify and resolve the situation.

1. The signal is weak – the watch will only show "0":
 - Shorten the distance between the heart rate chest belt and watch.
 - Re-adjust the position of the heart rate chest belt.
 - Check the batteries. If they are low or exhausted, the range may be less.
 - Force a signal search (see "Signal Search" section).
2. Interference from another person's heart rate monitor – their heart rate readings appear on your watch, or the watch shows "0":
 - Take the chest belt off for 12 seconds to automatically change your User ID. (The watch has 4 User ID's. When the watch receives the chest belt signal it will tell you which User ID it has selected. Only products with a digital coding system have User ID capability.)

NOTE The heart rate readings may interfere with other users if the distance is less than 84 cm (33 inches).

3. The signal is jammed – the heart rate reading on your watch is flashing:
 - There is too much interference in the environment for your heart rate monitor to function. Move to an area where the heart rate reading stops flashing.

WARNING Signal interference in the environment can be due to electromagnetic disturbances. These may occur near high voltage power lines, traffic lights, overhead lines of electric railways, electric bus lines or trams, televisions, car motors, bike computers, some motor driven exercise equipment, cellular phones or when you walk through electric security gates. Under interference, the heart rate and speed readings may become unstable and inaccurate.

SIGNAL SEARCH

To force a signal search:

1. Press **MODE** to enter SPEED, TRAIN or CHRONO Mode.
2. Press and hold **MODE** for 2 seconds. The signal-searching icon  with the outside flashing will appear to confirm a signal search is taking place. Whenever the watch is searching for the chest belt signal, make sure that the chest belt is no further than 10 cm (4 inches) from the watch.

The signal search will take approximately 10 seconds. If after 10 seconds the heart icon is not flashing, then your signal search has been unsuccessful and you need to force another signal search. See the table in the "Transmission Signal" section for more signal status information.

SETTING THE KEYPAD TONE / LIGHT MODE

You can set the watch to have the:

- Keypad "Beep" tone ON or OFF.



- Light Mode ON or OFF (see "Activating the Backlight" section).



To set these features:

1. Press **MODE** to enter TIME Mode.
2. Press **SET** until you reach the feature you wish to change.
3. Press **ST / SP / +** or **LAP / MEM / -** to change the setting.
4. Press **SET** to confirm the setting and move on to the next one.

ACTIVATING THE BACKLIGHT

To activate when the Light Mode is set to OFF:

- Press  to turn on the backlight for 3 seconds. Press any other key whilst the light is on and it will extend the light time by another 3 seconds.

To activate when the Light Mode is set to ON:



- Press any key to turn ON or extend the backlight for 3 seconds.

To help conserve power the Light Mode ON setting will automatically switch to OFF after 2 hours.

NOTE The backlight does not work when the low battery icon is shown and will return to normal once the battery is replaced.

ACTIVATING THE KEYPAD LOCK

To turn the keypad lock **ON** or **OFF**:

- Press and hold  for 2 seconds.  appears on the display when the keypad lock is on.

SWITCHING BETWEEN OPERATION MODES

Press **MODE** to switch between the 5 operation modes:

- **TIME**: Real-time Clock and Alarm
- **SPEED**: Calibration, Speed and Distance / Time targets
- **TRAIN**: Warm-up timer / Exercise timer / Rest (recovery) timer
- **CHRONO**: Stopwatch
- **USER**: Exercise and User profile

The modes are described in the sections that follow.

NOTE You can run the SMART TRAINING PROGRAM or stopwatch in the background as you access other modes. The icon for the mode that is running will flash until you switch back to that mode.

CLOCK

To set real-time clock:

1. Press **MODE** to switch to TIME Mode.



2. Press and hold **SET** until the first setting flashes.



3. Press **ST / SP / +** or **LAP / MEM / -** to change the 12 or 24 hour clock format setting. Hold down for fast advancement. Press **SET** to confirm the setting and move on to the next one.



EN

- Repeat step 3 to change other settings:
Hour / Minute / Year / DD:MM or MM:DD date format / Month / Day.

NOTE The clock is programmed with a 50-year auto-calendar, which means you do not need to reset the days of the week and dates each month.

ALARM

Your watch has an alarm that can be set to activate daily (Mon-Sun), on weekdays (Mon-Fri), or on the weekend (Sat-Sun).

To set alarm:

- Press **MODE** to enter **TIME** Mode.

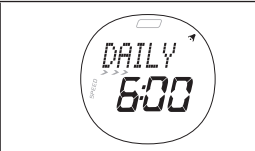

- Press **SET** to select alarm.

- Press and hold **SET** until the first setting is flashing to enter the setting mode for the alarm.



- Press **ST / SP / +** or **LAP / MEM / -** to change the Daily, Weekday or Weekend setting. Hold down for fast advancement. Press **SET** to confirm the setting and move on to the next one.
- Repeat step 4 to change other settings: Hour / Minute.
- The alarm will automatically be activated once you have finished setting the alarm time.

To activate / deactivate the alarm:

- Press **MODE** to enter TIME Mode.
- Press **SET** to select alarm.
- Press **ST / SP / +** or **LAP / MEM / -** to activate or deactivate the alarm. The alarm icon  displays when the alarm is activated.

To turn the alarm sound off:



Press any key to turn the alarm sound off. The alarm will automatically reset itself unless you deactivate it.



USER PROFILE

To access the full benefits of the heart rate monitor set up your user profile before you exercise. This will automatically generate a fitness index and body mass index. These calculations along with the calorie and % fat burned will help you track your progress over time.

To set user profile:

- | | |
|------------------------------------------------------------------------|-----------------------------------------------------------------------------------|
| 1. Press MODE to enter User Profile. |  |
| 2. If this screen appears, press SET to enter the User Profile. |  |
| 3. Press and hold SET until the first setting flashes. |  |
4. Press **ST / SP / +** or **LAP / MEM / -** to change the Male or Female setting. Hold to speed through the options. Press **SET** to confirm the setting and move on to the next one.
5. Repeat step 4 to change other settings: Year of Birth / Month of Birth / Day of Birth / Weight - lbs or Kg option / Weight / Height - feet / inch or centimeter option / Height / Activity Level - Little, Hobby or Athlete.

Once you complete your user profile, a fitness index and body mass index is automatically calculated and displayed for you. Refer to the "About the Fitness / Body Mass Index" section for further information.

NOTE You can display and adjust your user profile at any time.

NOTE You must set up your user profile to use the calorie count and % fat burned features.

ACTIVITY LEVEL

The activity level is based on your own self-assessment of the amount of exercise you regularly perform.

ACTIVITY LEVEL	DESCRIPTION
LITTLE	Low - You do not usually participate in programmed recreation sports or exercise.
HOBBY	Medium - You are engaged in modest physical activity (such as golfing, horseback riding, table tennis, calisthenics, bowling, weight lifting or gymnastics) 2-3 times a week, totaling 1 hour per week.
ATHLETE	High - You actively and regularly participate in heavy physical exercise (such as running, jogging, swimming, cycling, or skipping rope) or engage in vigorous aerobic exercise (such as tennis, basketball or handball).

EXERCISE PROFILE

To use the SMART TRAINING PROGRAM you need to set the exercise profile. You can set 3 different exercise profiles.

Different activities exercise the body in different ways and help you to achieve a variety of fitness goals. To accommodate this, the exercise profile can be set to suit different exercise activities. For example, if you are running, your exercise profile settings are likely to differ from those you would use when undertaking a weight training activity.

Also, the time you require to warm-up and complete an exercise will vary. That is why you can change the warm-up and exercise countdown time to suit you.

To set exercise profile:

1. Press **MODE** to enter USER Mode.



2. Press **SET** to enter Exercise Profile.



3. Press **SET** to choose between the 3 exercise profiles.

4. Press and hold **SET** until the first setting flashes. The display will change to "WALK", "JOG" or "RUN" after a while.



5. Press **ST / SP / +** or **LAP / MEM / -** to change the walk / jog / run setting. Hold down for fast advancement. Press **SET** to confirm the setting and move on to the next one.

6. Repeat step 5 to change other settings:

- Lower Limit Heart Rate
- Upper Limit Heart Rate
- Heart Rate Alert ON or OFF
- Repeat Exercise Timer ON or OFF
- Exercise Timer or Distance / Distance (if Distance is chosen)
- Exercise Timer Hour (if Timer is chosen)
- Exercise Timer Minute (if Timer is chosen)
- Warm-Up Timer (set to 5, 10, 15 mins to activate or 0 to deactivate timer)
- Rest (Recovery) Timer ON or OFF

NOTE Resume vibration mode will appear after the upper limit heart rate setting when the battery is low, this warning enables you to resume vibration mode or turn it OFF to save power.

NOTE Once you have set your user profile and target activity your lower and upper heart rate limit will be set automatically. However, if the automatic settings don't suit you, you can manually change them. If you change the target activity, they will automatically be updated.

TARGET ACTIVITY

There are 3 target activity levels:

TARGET ACTIVITY		MHR%	DESCRIPTION
WALK	Health Maintenance	65-78%	This is the lowest training intensity level. It is good for beginners and those who want to strengthen their cardiovascular systems.
JOG	Aerobic Exercise	65-85%	Increases strength and endurance. It works within the body's oxygen intake capability, burns more calories, and can be maintained for a long period of time.
RUN	Anaerobic Exercise	78-90%	Generates speed and power. It works at or above the body's oxygen intake capability, builds muscle, and cannot be maintained for a long period of time.

MAXIMUM / LOWER / UPPER HEART RATE LIMIT

Before you begin any exercise program and to achieve maximum health benefits from your workout, it is important to know your:





- Maximum heart rate (MHR)
- Lower heart rate limit
- Upper heart rate limit

To manually calculate your own heart rate limits, follow the instructions below:

MHR	LOWER LIMIT	UPPER LIMIT
MHR = 220 - age	MHR x lower target activity %. E.g. Target activity is WALK Lower Limit = MHR x 65%	MHR x upper target activity %. E.g. Target activity is WALK Upper Limit = MHR x 78%

HEART RATE ALERT

You can set the heart rate alert in the exercise profile to the following settings:

ICON	DESCRIPTION
	Heart rate sound and vibration alert are OFF
	Heart rate sound alert is ON <ul style="list-style-type: none"> • 1 beep means you have gone below your lower zone limit • 2 beeps means you have gone above your upper zone limit
	Heart rate vibration alert is ON
	Heart rate sound and vibration alert are ON

When the heart rate alert is activated, a flashing down or up arrow will appear on the display to show which heart rate limit you have surpassed.

NOTE Using the vibration feature consumes battery life at a faster rate than the sound alarm.

CALIBRATION, SPEED AND TARGETS

CALIBRATION

Before you use the speed and distance function, you have to set a real calibration or parameter. To set the real calibration you pre-set a distance to get a rough estimate of your speed when running this distance. You have to run the distance and then set the real calibration. You can set the

calibration for running and / or walking. You can use the watch without calibration, but the accuracy of speed and distance will be lower. After calibration, the accuracy of the speed and distance will increase.

To set real calibration:

1. Make sure the transmission between the watch and the chest belt is well connected.
 2. Press **MODE** to enter SPEED Mode.
 3. Press and hold **SET** to enter setting mode.
-
4. Press **ST / SP / +** or **LAP / MEM / -** to select CALIBRATION (Cali) and press **SET** to confirm.



5. Press **ST / SP / +** or **LAP / MEM / -** to select calibration for walking or running. It is suggested to do the calibrations for both walking and running separately. The watch can automatically distinguish if you are walking or running.
6. Press **ST / SP / +** or **LAP / MEM / -** to select real calibration ("SET CAL" will flash) or input calibration parameter ("SET PAR" will flash) directly and press **SET** to confirm.

For first time use, please select real calibration. After calibration, record the calibration parameters for walking and running respectively so that in the future, you can manually insert these parameters as opposed to doing a real calibration again. For example, if you lend the watch to someone who puts in his/her own calibration, you can simply input your calibration parameter directly when you use the watch again.

7. Press **ST / SP / +** or **LAP / MEM / -** to select the distance you want to walk or run (400 meters is suggested for each one) and press **SET** to confirm.
8. Press **ST / SP / +** to start calibration and **immediately** start walking or running.
9. After you have walked or run the desired distance, press **ST / SP / +** to end the calibration.
10. The watch can sense whether your calibration is ok or not. If you receive a failure message, try running at a slower speed as sometimes the watch cannot calibrate accurately when you are running too quickly.
11. If the calibration has failed, you can redo it by pressing **SET** and repeating steps 8 and 9, or stop it by pressing **ST / SP / +**.

NOTE You can stop the calibration at any time by pressing **ST / SP / +** and exit the setting mode by pressing **MODE**.

NOTE The speed and distance function is only for running or walking, not for cycling or driving.

NOTE The calibration depends on the body's walking or running behavior, even the shoes you are wearing. Therefore, when another person uses the watch, he/she must re-do the calibration.

NOTE It will take the watch about 10 seconds to return to "0" once you've stopped walking or running.

UNIT FOR SPEED AND DISTANCE

To set unit (Km or Miles):

1. Press **MODE** to enter SPEED Mode.
2. Press and hold **SET** to enter setting mode.
3. Press **ST / SP / +** or **LAP / MEM / -** to select UNIT setting and press **SET** to confirm.
4. Press **ST / SP / +** or **LAP / MEM / -** to toggle between Km and Mile. Press **SET** to confirm selection.

SPEED LIMIT

Your watch has a real-time measurement for speed. The average speed can be viewed during the workout. The upper and lower speed limit can be set before working out with an option to have a speed alert when exceeding the upper or lower limit.

To set speed limit:

1. Press **MODE** to enter SPEED Mode.
2. Press and hold **SET** to enter setting mode.
3. Press **ST / SP / +** or **LAP / MEM / -** to select SPEED LIMIT and press **SET** to confirm.
4. Press **ST / SP / +** or **LAP / MEM / -** to alter lower limit, press **SET** to confirm and enter the next setting.
5. Repeat step 4 to set upper limit and speed alert.

NOTE Visual and sound alerts activate every 10 seconds when the lower or upper speed limits are exceeded. For sound alert, 3 short beeps indicates being below the lower limit while 4 short beeps indicates being above the upper limit.



SETTING TARGET(S)

Before you start exercising you can set different targets (by distance or by time). There are 9 sets of targets available. When first target is complete, it will go to the next target automatically and so on until all targets are complete. This is useful for those who want to do training for various exercise segments.

To set targets:

1. Press **MODE** to enter SPEED Mode.
2. Press and hold **SET** to enter setting mode.

3. Press **ST / SP / +** or **LAP / MEM / -** to select TARGET and press **SET** to confirm.



4. Press **ST / SP / +** or **LAP / MEM / -** to enable number of targets 1-9 you want to play. Press **SET** to confirm.
5. Press **ST / SP / +** or **LAP / MEM / -** to select "By distance" or "By time" and press **SET** to confirm.
6. Press **ST / SP / +** or **LAP / MEM / -** to select the target you want to set and press **SET** to confirm.
7. Press **ST / SP / +** or **MEM / LAP / -** to change the setting value (distance or minute/second) and press **SET** to confirm.
8. Repeat step 6 and 7 to set other targets or press **MODE** to quit setting mode.

NOTE The distance can be set between 0.10 - 99.99Km and the time can be set between 00'01"-99'59".

USING TARGET FUNCTION

To start / stop target function:

1. Press **MODE** to enter SPEED Mode.
2. Press **ST / SP / +** to start the first target.
3. You can press **ST / SP / +** to pause / resume each target OR you can skip each target by pressing and holding **ST / SP / +**, 3 short beeps will indicate skipping a target.
4. When all targets are finished, there will be a long beep and "FINISH" will flash.

NOTE You can reset all the targets at any time by pressing and holding **SET**.

During the workout you can check the following information by pressing **SET**:

- Target distance / time remaining and speed
- Target distance / time remaining and heart rate
- Clock and pace
- Total distance for all targets done and average speed
- Total time and average pace

NOTE The pace is the time (MM'SS") required to finish one kilometer or mile.

VIEWING TARGET DATA WHEN WORKOUT IS PAUSED OR STOPPED

To view the memory for target performance:

1. Press **ST / SP / +** to pause or stop the target function.
2. Press **LAP / MEM / -** to enter memory mode. Odometer will be shown.
3. Press **SET**, "ALL" will flash. Then press **ST / SP / +** or **LAP / MEM / -** to select viewing overall memory or an individual memory.
4. Press **SET** to view each data.

For each individual target, the following data can be viewed:

- Time elapsed and average speed
- Distance traveled and average pace
- Average heart rate

For overall performance, the following data can be viewed:

- Total time elapsed and average speed
- Total distance traveled and best pace
- Average pace and average heart rate

NOTE Odometer is the total distance traveled after system reset. It is shared with **SPEED**, **TRAIN** and **CHRONO** modes. To reset the odometer press and hold **SET**.

ABOUT THE SMART TRAINING PROGRAM

The SMART TRAINING PROGRAM enables you to complete exercise cycles effectively. It will guide you through from a 5-minute warm-up (default setting) to the end of your exercise program. In addition to monitoring your heart rate and altering you whenever you fall out of the range for the selected training zone, the Program allows you to check the calories consumed and the % fat burned.

USING THE SMART TRAINING PROGRAM

The SMART TRAINING PROGRAM monitors your exercise performance once you have entered your user profile and exercise profile.

NOTE You cannot use the SMART TRAINING PROGRAM if you are running the stopwatch.

To enter the SMART TRAINING PROGRAM:

1. Press **MODE** to enter TRAIN Mode.



2. Press and hold **SET**. Then, press **ST / SP / +** or **LAP / MEM / -** to select 1 of the 3 exercise profiles. Press **SET** to confirm.



3. To start or stop the warm up, exercise or recovery countdown timer, press **ST / SP / +**. Once you stop any countdown timer, you can press **ST / SP / +** again to resume it. At the end of each countdown period you will hear a beep.
 - 3 short beeps = Warm-up time completed
 - 1 long beep = Exercise time or distance completed
 - 6 short beeps = Recovery time completed
4. To bypass a timer and move onto the next one, press and hold **ST / SP / +**.
5. To reset the timer, press and hold **SET**.

The order of the Timer Mode is:

- Warm-up time
 - The warm-up will not display if it has been set "0" in the exercise profile.
- Exercise time or distance
 - The exercise time or distance is set in the exercise profile.
- Rest time
 - The rest (recovery) time is automatically set to 3 minutes and cannot be changed. When the timer reaches "0", the recovery heart rate will flash.

NOTE You can enable or disable the recovery timer by selecting On / Off setting in Exercise profile (please refer to "Set Exercise Profile" - step 6).

VIEWING DATA WHILE SMART TRAINING PROGRAM IS RUNNING

During warm-up, exercise or rest time countdown, press **SET** to view and toggle between the following screen displays:

Remaining warm-up / exercise / rest time with current heart rate:

<ul style="list-style-type: none"> • Current calorie and % fat burned 		
<ul style="list-style-type: none"> • Distance traveled and speed 		



- Clock with pace



VIEWING SMART TRAINING PROGRAM MEMORY RECORDS

When the SMART TRAINING PROGRAM has been completed, press **LAP / MEM / -** to enter memory mode. The odometer will be displayed, then press **SET** to view the following records:

- Total time and maximum heart rate
- Recovery heart rate and average heart rate
- Total calorie and % fat burned
- In zone time: Time spent without exceeding your upper or lower heart rate
- Above zone time: Time spent exceeding your upper heart rate limit
- Below zone limit: Time spent exceeding your lower heart rate limit
- Average pace and average speed
- Distance and maximum speed

NOTE You cannot use the SMART TRAINING PROGRAM, Stopwatch and Target function at the same time.

RECOVERY HEART RATE

Your recovery heart rate is a good indication of cardiovascular fitness. The faster your heart rate recovers after the exercise, the better shape you are in. The watch uses a time-based recovery method, which checks your recovery heart rate 3 minutes after exercise.

Compare your recovery heart rate between exercise sessions to track the effect your exercise is having.

STOPWATCH

The stopwatch function is particularly beneficial to use when you are unsure how long your activity will take, or when you want to measure the time it takes to complete a task and your performance over that time. You can also take lap and split time readings when using the stopwatch function.

To get the most out of your stopwatch functions complete your user and exercise profile. If you have not completed the user profile you will be unable to use the calorie and % fat burned function.

- Press **MODE** to enter **CHRONO** Mode. You can now perform the following functions:

TASK	INSTRUCTION
Start stopwatch	Press ST / SP / + .
Pause / resume stopwatch	Press ST / SP / + .
Reset	Press and hold SET .
Save lap	Press LAP / MEM / - while the stopwatch is running. NOTE Up to 60 laps or 99 hrs:59 mins total can be stored in the memory.
Select exercise profile for stopwatch	<ol style="list-style-type: none"> 1. Press and hold SET. 2. Press ST / SP / + or LAP / MEM / - to select 1 of the 3 exercise profiles. Press SET to confirm.
Turning on / off auto lap	<p>After selecting exercise profile, the setting AUTO-LAP on/off will appear. Press ST / SP / + or LAP / MEM / - to select. Press SET to confirm.</p> <p>If AUTO-LAP is on, a lap will be taken automatically once you have traveled a pre-set distance (e.g. 1.0km).</p> <p>NOTE If auto-lap function (by distance) is selected, stopwatch will be paused if speed is zero.</p>

NOTE The stopwatch begins measurement in min:sec:1/100 sec. After 59 minutes pass, the display will change to hrs:min:sec.

VIEWING DATA WHILE STOPWATCH / LAP IS RUNNING

While the stopwatch or lap functions are being used, press **SET** to view and toggle between the following screen displays:

- Total time / split time and current heart rate
- Lap time and current heart rate



EN

- Current calories and % fat burned
- Distance and speed
- Clock with pace

If the battery is low when taking a lap, this screen will appear and no more laps will be saved.



VIEWING OVERALL OR LAP MEMORY RECORDS

To view memory:

1. The stopwatch must be stopped (press **ST / SP / +**).

2. Press **LAP / MEM / -** to enter memory mode. Odometer will be displayed.



3. Press **SET**, "ALL" will flash. Press **ST / SP / +** or **LAP / MEM / -** to select viewing overall or an individual lap memory.



4. Press **SET** to view each record.

For overall memory, the records will appear in the following order:

- Total time and maximum heart rate
- Total time and average heart rate
- Total calories and % fat burned
- In zone time: Time spent without exceeding your upper or lower heart rate limit
- Above zone time: Time spent exceeding your upper heart rate limit
- Below zone time: Time spent exceeding your lower heart rate limit



- Average pace and average speed
- Distance and maximum speed

For each individual lap, the records will appear in the following order:

- Lap time and lap number
- Lap time and maximum heart rate
- Split time and average heart rate
- Calorie and % fat burned - per lap
- In zone time - per lap
- Above zone time - per lap
- Below zone time - per lap
- Average pace and average speed
- Distance and maximum speed

ABOUT THE FITNESS / BODY MASS INDEX

FITNESS INDEX

Your watch will generate a fitness index based on your aerobic fitness. This index is dependent and limited by the body's ability to deliver oxygen to the working muscles in training. It is often measured by maximum oxygen uptake (VO₂ Max), which is defined as the highest amount of oxygen that can be utilized when exercising at an increasingly demanding level. The lungs, heart, blood, circulatory system, and working muscles are all factors in determined VO₂ Max. The unit of VO₂ Max is ml/kg min.

The higher the index, the fitter you are. See the tables below for a rough guide to what your fitness index means:





FITNESS INDEX FOR WOMEN

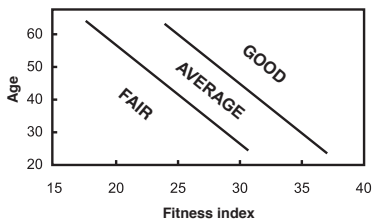

BODY MASS INDEX

Your body mass index is a measurement of the relative percentages of fat and muscle mass in the human body.

HEALTH INDICATION	BMI RANGE	DESCRIPTION
Underweight	Less than 18.5	Your body weight is currently lower than average. Work toward healthy, regular food intake and exercise routine to build up your health to recommended levels.
Recommended	18.5 to 24.9	Your health is at the recommended level. Maintain a balanced diet and exercise to keep your current level of health.
Overweight	25.0 to 29.9	Your body weight may be above normal. Increase your exercise and work out a diet plan to lower your risk for serious illness.
Obese	30.0 or greater	At this level, you may be at risk for heart disease, high blood pressure, and other illnesses. Consult with your doctor to develop a proper health and fitness plan.

NOTE The above BMI information is based on BMI classification from WHO 2004.

VIEWING FITNESS

Press **MODE** to enter **USER** Mode. Then, press **LAP / MEM / -** to display your fitness and body mass index.



NOTE If you have not completed your user profile, these will not display and “- -” will show on the display.





CARE INSTRUCTIONS

To ensure you receive the maximum benefit from using this product, please observe the following guidelines:

- Clean the watch and chest belt thoroughly after each training session. Never store the products when wet.
- Use a soft, slightly moistened cloth. Do not use abrasive or corrosive cleaning agents, as these may cause damage.
- Avoid pressing the keys with wet fingers, under water, or in heavy rain, as this may allow water to gain entry into the electrical circuitry.
- Do not bend or stretch the transmitter part of the chest belt.
- Do not subject the product to excessive force, shock, dust, temperature changes, or humidity. Never expose the product to direct sunlight for extended periods. Such treatment may result in malfunction.
- Do not tamper with the internal components. Doing so will terminate the product warranty and may cause damage. The main unit contains no user-serviceable parts.
- Do not scratch hard objects against the LCD display as this may cause damage.
- Remove the batteries whenever you are planning to store the product for a long period of time.
- When replacing batteries, use new batteries as specified in this user manual.
- Do not dispose this product as unsorted municipal waste. Collection of such waste separately for special treatment is necessary.

AQUATIC AND OUTDOOR ACTIVITIES

The watch is water-resistant up to 50 meters. The chest belt is splash proof, and should not be worn for underwater activities, as the heart rate transmission cannot occur under water. Refer to the table for proper guidelines.





					
	RAIN SPLASHES ETC	SHOWERING (WARM/ COOL WATER ONLY)	LIGHT SWIMMING / SHALLOW WATER	SHALLOW DIVING/ SURFING/ WATER SPORTS	SNORKELING / DEEP WATER DIVING
Watch 50 m / 165 ft	OK	OK	OK	NO	NO

When using the watch for aquatic or outdoor sports activities, observe the following guidelines:

- Do not press the keys under water or with wet fingers.
- Rinse with water and mild soap after use.
- Do not use in hot water.

BATTERIES

Both the watch and the heart rate chest belt use 1 x CR2032 3V battery. Both are already installed. See the table below for battery warnings.

LOW BATTERY ICON	DESCRIPTION
	The battery is too low to run the backlight
	The battery is too low to run the vibration alert
	The watch battery is low; the vibration alert and backlight cannot be used
	The chest belt battery is nearly too low to send a signal to the watch

The batteries typically last one year. We highly recommend that you contact the retailer or our customer service department if you need to replace them.

To replace the watch battery:

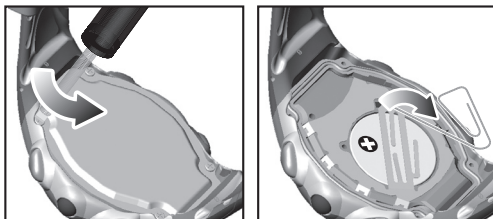

1. Undo the four screws and remove the back plate.
2. Using a thin blunt instrument, hook the release catch and lift the clip.
3. Remove the old battery and slide the new battery into the battery compartment with the +side upwards.
4. Replace the battery clip, back plate and screws.

To replace the chest belt battery:

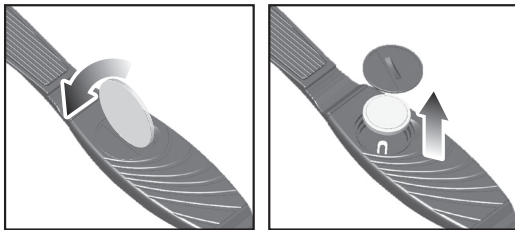

1. Using a coin, twist the compartment lid counter-clockwise until it clicks out of place.
2. Remove the old battery and insert the new battery with the +side upwards.
3. Replace the battery compartment lid by twisting it clockwise until it is firmly in place.

IMPORTANT

- Non-rechargeable and rechargeable batteries must be disposed of properly. For this purpose, special containers are provided for non-rechargeable and rechargeable battery disposal at communal collection centers.
- Batteries are extremely dangerous when swallowed! Therefore, keep batteries and small articles away from children. If a battery has been swallowed seek immediate medical advice.
- The batteries supplied must not be recharged, reactivated by any other means, dismantled, put into fire or short-circuited.

SPECIFICATIONS**CLOCK**

Time format	12 hr / 24 hr
Date format	DD / MM or MM / DD
Year format	2001-2050 (auto-calendar)
Alarm	Alarm with daily, weekday or weekend settings

STOPWATCH

Stopwatch	99:59:59 (HH:MM:SS)
Resolution	1/100sec
Lap counter	60 laps share 99:59:59
Auto lap distance	0.01 to 99.99 km or mile

SMART TRAINING PROGRAM

Warm-up timer	Set to 5, 10, 15, or 0 mins
Exercise timer	99:59:00 (HH:MM:SS)
Maximum number of exercise timer repeats	9 By time: 99:59:00 (HH:MM:SS) By distance: 0.1 to 99.99 km OR 0.1 to 99.99 mile
Rest timer	3 mins fixed time

PERFORMANCE TRACKING

Heart rate (HR) alarm	Vibrate / sound / visual
HR measuring range	30-240 bpm (beats per minute)

Lower HR settable range	30-220 bpm (beats per minute)
Upper HR settable range	80-240 bpm (beats per minute)
Calories calculation	0-9,999 kcal
% fat burned calculation	0-99%

SPEED FUNCTIONS

Speed range	0 to 40.0 km/hr (0 to 24.8 mile/hr)
Distance	0 to 9999.99km (0 to 6211.17 mile)
Distance tolerance	Best 8% (approximately)
Odometer	0 to 99999 km (0 to 62111 mile)
Pace mile	0 to 99'59" (MM'SS") per km or mile
Maximum number of target distance / time in SPEED Mode	9
Target distance in SPEED Mode	0.10 to 99.99 km or mile
Target time in SPEED Mode	00'01" to 99'59" (MM:SS)
Lower speed limit	0.1 to 39.9 km/hr or mile/hr
Upper speed limit	0.2 to 40.0 km/hr or mile/hr (Upper >= lower + 0.1 km/hr or mile/hr)

TRANSMISSION

Range	62.5 cm (25 inches) - may decrease with low battery
-------	--------------------------------------------------------

WATER RESISTANT

Watch	50 meters (not actuating keys)
Chest belt	Splash proof

POWER

Watch	1 x CR2032 3V lithium battery
Chest belt	1 x CR2032 3V lithium battery

OPERATING ENVIRONMENT

Operation temperature	5°C-40°C (41°F-104°F)
Storage temperature	-20°C-70°C (-4°F-158°F)

WARNINGS

To ensure you use your product correctly and safely, read these warnings and the entire user manual before using the product. The warnings given here provide important safety information and should be observed at all times.

- Keep your watch water resistant.
- Avoid chemicals (gasoline, chlorine, perfumes, alcohol, hair sprays etc.)
- Reduce exposure to heat.
- Have your watch serviced by an approved service centre annually.
- The product is a precision instrument. Never attempt to take this device apart. Contact the retailer or our customer service department if the product requires servicing.
- Do not touch the exposed electronic circuitry, as there is a danger of electric shock.
- Take precautions when handling all battery types.
- Remove the batteries before storing the product for a long period of time.
- Do not use the chest belt in aircrafts or hospitals. The use of radio frequency products can cause malfunctions in the control devices of other equipment.
- Do not subject the product to impact or shock.
- Check all major functions if the device has not been used for a long time. Maintain regular internal testing and cleaning of your device.
- When disposing of this product, do so in accordance with your local waste disposal regulations.

ABOUT OREGON SCIENTIFIC

Visit our website (www.oregonscientific.com) to learn more about Oregon Scientific products such as digital cameras; MP3 players; children's electronic learning products and games; projection clocks; health and fitness gear; weather stations; and digital and conference phones. The website also includes contact information for our customer care department in case you need to reach us, as well as frequently asked questions and customer downloads.

We hope you will find all the information you need on our website, however if you're in the US and would like to contact the Oregon Scientific Customer Care department directly, please visit:

www2.oregonscientific.com/service/default.asp

OR

Call 1-800-853-8883.

For international inquiries, please visit:

www2.oregonscientific.com/about/international.asp

EU-DECLARATION OF CONFORMITY

Hereby, Oregon Scientific, declares that this Heart Rate Monitor (SE300) is in compliance with EMC directive 89/336/CE. A copy of the signed and dated Declaration of Conformity is available on request via our Oregon Scientific Customer Service.

