

# PerformaLift™ Series



Electric Salon Top  
Shown with optional  
Adjustable Side Arm Rests  
and Universal Table Extender



Lift-Assist Backrest Top



Flat Top  
Shown with optional  
QuickLock™ Face rest platform  
and Boiance™ crescent

made in the USA  
with US & imported parts



#### Notice

The information contained in this document is subject to change without notice and should not be construed as a commitment by OAKWORKS®, Inc.

OAKWORKS®, Inc. assumes no responsibility for any errors that may appear in this document nor does it make expressed or implied warranty of any kind with regard to this material, including, but not limited to, the implied warranties of merchantability and fitness for a particular purpose.

All rights are reserved. No part of this document may be photocopied, reproduced or translated to another language without prior written consent of OAKWORKS®, Inc.

OAKWORKS® is a registered trademark of OAKWORKS®, Inc.

OAKWORKS®, Inc. shall not be liable for incidental or consequential damages in connection with or arising out of the furnishing, performance, or use of this document and the program material which it describes.

---

## TABLE OF CONTENTS

Symbol Identification .....	1
Important Safety Instructions .....	1-2
Section I: Product Description & Photo	
Electric Salon Top .....	3
Lift Assist Backrest Top.....	4
Flat Top .....	5
Section II: Installation	
Grounding .....	6
Leveling .....	7
Moving the Table .....	8
Section III: Directions for Use	
Foot Control .....	9-10
Operating the manual backrest top .....	10
Hand Control .....	11-12
Locking Casters .....	13
Arm Rests .....	14
Lowered Arm Rest .....	15
QuickLock Face Rest .....	15
Section IV: Maintenance & Service	
Cleaning .....	16
Inspection & Maintenance .....	16
Troubleshooting .....	17
Foot and Hand Control Replacement .....	18
Parts Identification .....	19
Warranty Information .....	20
Part Number and Serial Number Location .....	20
Wiring Diagram .....	21
Specifications .....	21
Guidance and manufacturer's declaration -	
Electromagnetic emissions .....	22
Recommended separation distances .....	22
Guidance and manufacturer's declaration -	
Electromagnetic immunity .....	23-24
Contact Information .....	back cover

---

### SYMBOL IDENTIFICATION



This symbol, when used in this manual and on product labels, represents a caution warning. Be sure to read and comply with all precautions and warnings.



This symbol, when used in this manual and on product labels, warns against an electrical shock hazard. Be sure to observe and comply with all warnings.



This symbol, when used in this manual or on product labels, indicates a Protective Earth (Ground) Terminal.



This symbol, when used in this manual or on product labels, indicates the date of manufacture of the device.



This symbol, when used in this manual or on product labels, indicates alternating current (AC).



This symbol, when used in this manual or on product labels, indicates direct current (DC).



This symbol is used to indicate that the operator should consult the user manual.

### INTRODUCTION

Oakworks PerformaLift Series offers a variety of positioning capabilities for massage therapists and spa professionals of all specialties. On these multifunctional professional tables the practitioner can perform numerous protocols with ease and comfort. The fully electric PerformaLift Series is especially effective when professional protocols require specific positioning for the client or patient. While the client receives comfortable, relaxing support, the comfort level of the therapeutic professional is enhanced by superior ergonomics.

This table is intended to be operated by a Massage Therapist in a professional environment. No special training is required but a review of the following Safety Instructions is important for the safety of the operator and patient. The massage professional should read and understand this entire manual before use with a client. There are no known contraindications to the use of this equipment.

The PerformaLift Series should not be used in any other manner than that described within this manual. Use of any unnecessary force or unauthorized procedures could result in injury to practitioner, client or equipment.

**READ AND  
SAVE THESE  
INSTRUCTIONS**

**IMPORTANT SAFETY INSTRUCTIONS**



**CAUTION**

The PerformaLift Series Exam Table is a powered positioning table used for routine treatment and examination procedures. It is intended to be operated by a healthcare professional in a medical environment. No special training is required but a review of the following Safety Instructions is important for the safety of the operator and patient. The healthcare professional should read and understand this entire manual before use with a patient. There are no known contraindications to the use of this equipment.

Medical Electrical Equipment needs special precautions regarding EMC and needs to be installed and put into service according to the EMC information provided in this manual.

Portable and mobile RF communications equipment can affect Medical Electrical Equipment.

Table is not to be used as a gurney or to transport patient from room to room.

The use of accessories, transducers, and cables other than those specified by the manufacturer, may result in increased emissions or decreased immunity of the PerformaLift Series Exam Table. The PerformaLift Series Exam Table should not be used adjacent to or stacked with other equipment and that if adjacent or stacked use is necessary, the PerformaLift Series Exam Table should be observed to verify normal operation in the configuration in which it will be used.

The PerformaLift Series Exam Table is designed to be a stand-alone table. This table must not be modified or incorporated into any other equipment.

As with any moving mechanism there are potential pinch points around and underneath the table. It is the responsibility of the operator of this equipment to insure that bystanders are not in the area below or around this equipment during operation.

Proper operation of this equipment is very important for the safety of the operator, patient, and any other individuals in the area of this equipment. Directions for use of this equipment are described on pages 9 through 15. The operator should read these sections carefully.

Weight Limit: (patient and accessories) 550 lbs. (250 kg) Do not exceed.

Be certain that the table is completely lowered without any tilt being present prior to discharging an ambulatory patient. The patient may lose balance and fall.

This table is not suitable for use in the presence of flammable anesthetic mixture with air or oxygen or nitrous oxide.

Do not operate where aerosol (spray) products are being used or where oxygen is being administered.

Do not lift table by the table top. This can damage the table.

When lowering the table or using the Trendelenburg/Reverse Trendelenburg function, make sure there is nothing underneath the table top that can impede motion (like stools, cabinets, accessory parts, cleaners, etc)

Use this furnishing only for its intended use as described in these instructions. Do not use attachments not recommended by the manufacturer.

Close supervision is necessary when this furnishing is used by, or near children, invalids, or disabled persons.



**WARNING**

To reduce the risk of burns, fire, electric shock or injury to persons:

1. Unplug this furnishing from the electrical outlet before cleaning.
2. Unplug from outlet before adding or removing parts.
3. Never operate this furnishing if it has a damaged cord or plug, if it is not working properly, if it has been dropped or damaged, or dropped into water. Contact Oakworks Customer Service before use at 717.235.6807.
4. Keep the cord away from heated surfaces.
5. Never drop or insert any object into any opening.
6. Do not use outdoors.



**DANGER**

Risk of electric shock - Connect this furnishing to a properly grounded outlet only. See Grounding Instructions on page 6.

Electrical Shock Hazard. The power supply/control module is located under the table top. No user serviceable parts are inside. Refer servicing to qualified personnel. Unplug wall plug prior to contact with any cables connected to the power supply.

# PerformaLift™ Electric Salon Top



## Table Specs\* :

- Lifting Capacity: 550 lbs. (250 kg)
- Height Range: 22"-38" (56 - 97 cm)
- Widths: 29" or 31" (74 or 79 cm)
- Length: 73" (185 cm)
- Top: Electric Salon Top
- Padding: 4" Aero•Cel™ or 6"
- Upholstery: TerraTouch™ Aero•Cel™
- Safety Standards: cETLus, CE marked

For electrical specs, see Specifications Chart in the back of this manual.

- published weight may differ due to options chosen, natural density material variations and padding

# PerformaLift™ Lift-Assist Backrest Top



## Table Specs\* :

- Lifting Capacity: 550 lbs. (250 kg)
- Height Range: 22"-38" (56 - 97 cm)
- Widths: 29" or 31" (74 or 79 cm)
- Length: 73" (185 cm)
- Top: Lift Assist Backrest
- Padding: 3" Plush (standard) or 6"  
4" Aero•Cel™  
Aero•Cel™
- Upholstery: TerraTouch™
- Safety Standards: cETLus, CE marked

For electrical specs, see Specifications Chart in the back of this manual.

- published weight may differ due to options chosen, natural material variations and padding density

# PerformaLift™ Flat Top



## Table Specs\* :

- Lifting Capacity: 550 lbs. (250 kg)
- Height Range: 21"-37" (53 - 94 cm)
- Widths: 29" or 31" (74 or 79 cm)
- Length: 73" (185 cm)
- Top: Flat Top
- Padding: 3" Plush (standard)  
4" Aero•Cel™ or 6"  
Aero•Cel™
- Upholstery: TerraTouch™
- Safety Standards: cETLus, CE marked

For electrical specs, see Specifications Chart in the back of this manual.

- published variations weight and may padding differ density due to options chosen, natural material



**READ AND SAVE THESE INSTRUCTIONS**

The tables come completely assembled and ready to use. Plug the cord into a functioning outlet that is rated for the table.

Arrange the power cord and control cords so that they will not create a tripping hazard and where the controls are located to your liking and are conveniently accessible.

To disconnect the table from electrical power, remove the plug from the outlet. Be sure access to plug is not blocked for disconnecting the table from power.

**GROUNDING**



**WARNING**

This product must be grounded. If it should malfunction or break down, grounding provides a path of least resistance for electrical current to reduce the risk of electric shock. This product is equipped with a cord having an equipment-grounding conductor and a grounding plug. The plug must be plugged into an appropriate outlet that is properly installed and grounded in accordance with all local codes and ordinances. See U.S. sample below.



Be sure to read all cautions, warnings and instructions given

in the manual to prevent injury to both operator and client.

This product is manufactured for use on a nominal 120-volt circuit for the United States and a nominal 220-volt circuit for use in Europe. The plug has a grounding pin (see figure A) in a pattern that varies by country as shown in the Product Identification section of this manual. Make sure that the product is connected to an outlet having the same configuration as the plug.

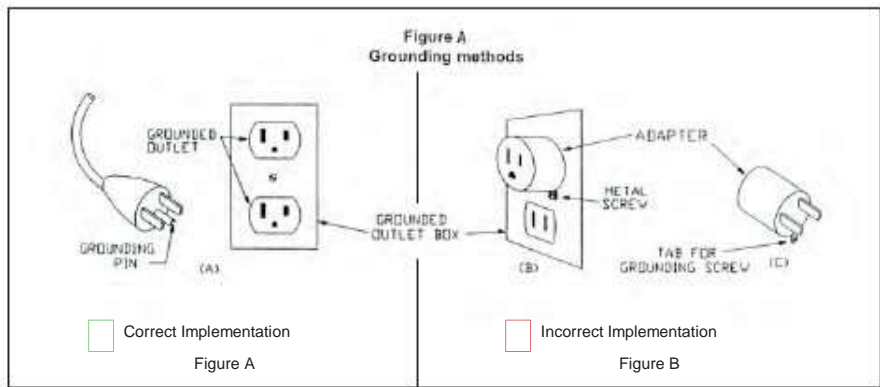

**DANGER-** Improper connection of the equipment-grounding conductor (see figure B) can result in a risk of electric shock. Check with a qualified electrician or service man if you are in doubt as to whether the product is properly grounded. Do not modify the plug provided with the product - if it will not fit the outlet, have a proper outlet installed by a qualified electrician.

To reduce the risk of electric shock, this furnishing has a polarized plug. This plug will fit in a polarized outlet only one way. Do not change the plug in any way.

### LEVELING INSTRUCTIONS:

#### If Table Will Not Sit Flat on the Floor:

The tables are equipped with Leveler Feet that adjust to level the table on uneven floors. To adjust the Leveler Feet to suit common floor differences, you will need to use a 1/2" open-end wrench or an adjustable wrench.

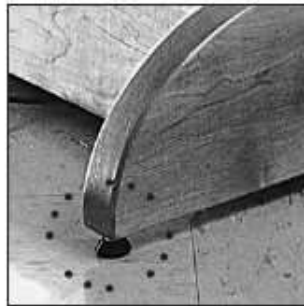

Leveler Foot



1/2" Open-end Wrench

#### To Adjust the Leveler Feet:

1. Place the table in the location where you plan to use it.
2. Rock the table to determine if it is level with the floor. If the table rocks back and forth at all, the foot that clears the floor when you rock the table will need adjustment.
3. Adjust the Leveler Foot by first loosening the locking nut found just above the rubber Leveler Foot with the open-end wrench.
4. Lower the adjustable rubber Leveler Foot until it meets the floor snugly. Tighten the locking nut against the wooden leg of the table with the open-end wrench to fix the Leveler Foot in position.
5. Rock the table again to be sure adjustments have stabilized the table. If necessary make any additional adjustments in the same way.



Locking Nut



Tighten Locking Nut

MOVING THE TABLE

CAUTION



The table weighs as much as 235 lbs. DO NOT lift or move the unit using proper safety procedures or equipment. DO NOT turn the table on its side for any reason. To do so could cause damage to the base and will void the warranty. There are no items that require this action. Never lift the grasping the table top as the table top is not designed to hold the weight of the base and you could damage the table.

without

warranty. serviceable

table



The table weighs approximately 235 lbs. (107 kg) You will need 4 people working together if it is necessary to move the table. Never lift the table by grasping the table top as the table top is not designed to hold the weight of the base and you could damage the table and the electronics that run the tabletop.

by if you need to move the table, place one person at each corner of the table. Have each person firmly grasp the base at the bottom and lift the table. As when moving any piece of heavy equipment, bend at the knees and lift with your legs beneath you and not with your back. Be aware and use proper, safe procedures for moving a table of this size to prevent injury to yourself or the table. We strongly recommend that a flatbed dolly be used that can hold the entire table if moving the table involves any distance.

CAUTION



Before doing any work on the table, disconnect the power cord from the power outlet and secure the electrical cord, and foot controls for moving.

### FOOT CONTROL OPERATIONS (ELECTRIC TOP)



#### CAUTION

Do not sit on elevated back rest of leg section.

Do not leave back rest of leg section unattended when table is tilted near its limits.

The Multi-function Foot Control operates all functions of the table with the touch of a button. Follow the directions below to access these functions. If a function button does not release, pressing and holding any other function button will stop the motion.



#### WARNING

When lowering the table or using the Trendelenburg/Reverse

Trendelenburg function, make sure there is nothing underneath the table top that can impede motion (like stools, cabinets, accessory parts, cleaners, etc)

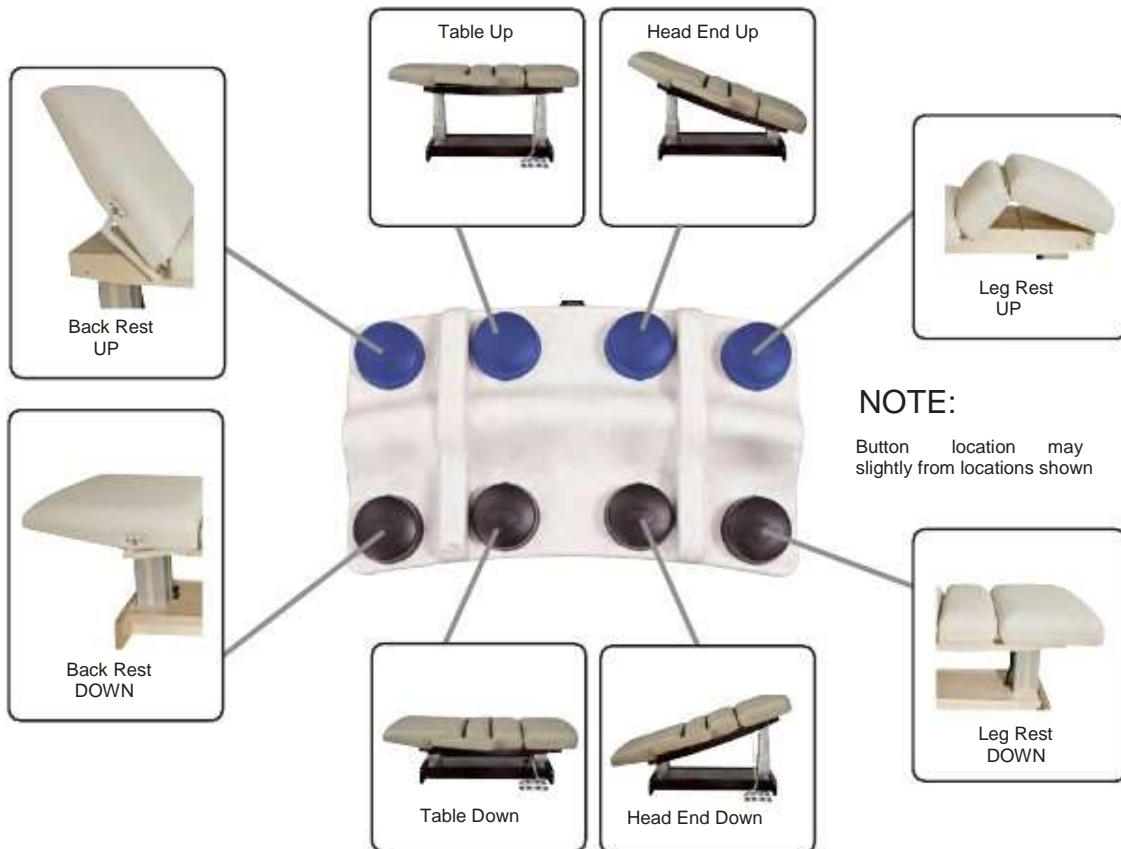

#### NOTE:

Button location may vary slightly from locations shown

**FOOT CONTROL OPERATIONS  
(LIFT-ASSIST BACKREST TOP & FLAT TOP)**

**CAUTION**

When operating the table controls be sure to observe all cautions and warnings given in the manual to prevent injury to and patient. Do not leave patient unattended when table is tilted near its limits.

Operate the foot control as shown below to raise or lower the height or to adjust the tilt of the table.



**WARNING**

When lowering the table or using the Trendelenburg/Reverse

Trendelenburg function, make sure there is nothing underneath the table top that can impede motion (like stools, cabinets, accessory parts, cleaners, etc)

**OPERATING THE MANUAL TOP  
(LIFT-ASSIST BACKREST TOP)**



**To Raise the Back Rest:**

Raise the back rest by pressing the lever under the head section and lifting up to the desired height. It is recommended that the client take some weight off the back rest while you lift.

**To Lower the Back Rest:**

Press the lever under the head section and push the back rest down. Release the lever and the back rest will stay in place.

**To Change Position of the Back Rest**

The back rest lever can be moved to the opposite side of the back rest by removing the screws and relocating the hand lever to the opposite side of the top into the four pre-drilled holes.

**HAND CONTROL OPERATIONS (ELECTRIC TOP)**

**CAUTION**

Do not sit on the elevated section.

Do not leave back rest or leg section unattended when table is tilted near its limits.

The Multi-function Hand Control operates all functions of the table with the touch of a button. Follow the directions below to access these functions. If a function button does not release, pressing and holding any other function button will stop the motion.

**WARNING**

When lowering the table or using the Trendelenburg/Reverse Trendelenburg function, make sure there is nothing underneath the table top that can impede motion (like stools, cabinets, accessory parts, cleaners, etc)

Trendelenburg function, make sure there is nothing underneath the table top that can impede motion (like stools, cabinets, accessory parts, cleaners, etc)



**NOTE:**

Button location may vary slightly from locations shown

**HAND CONTROL OPERATIONS  
(LIFT-ASSIST BACKREST TOP & FLAT TOP)**

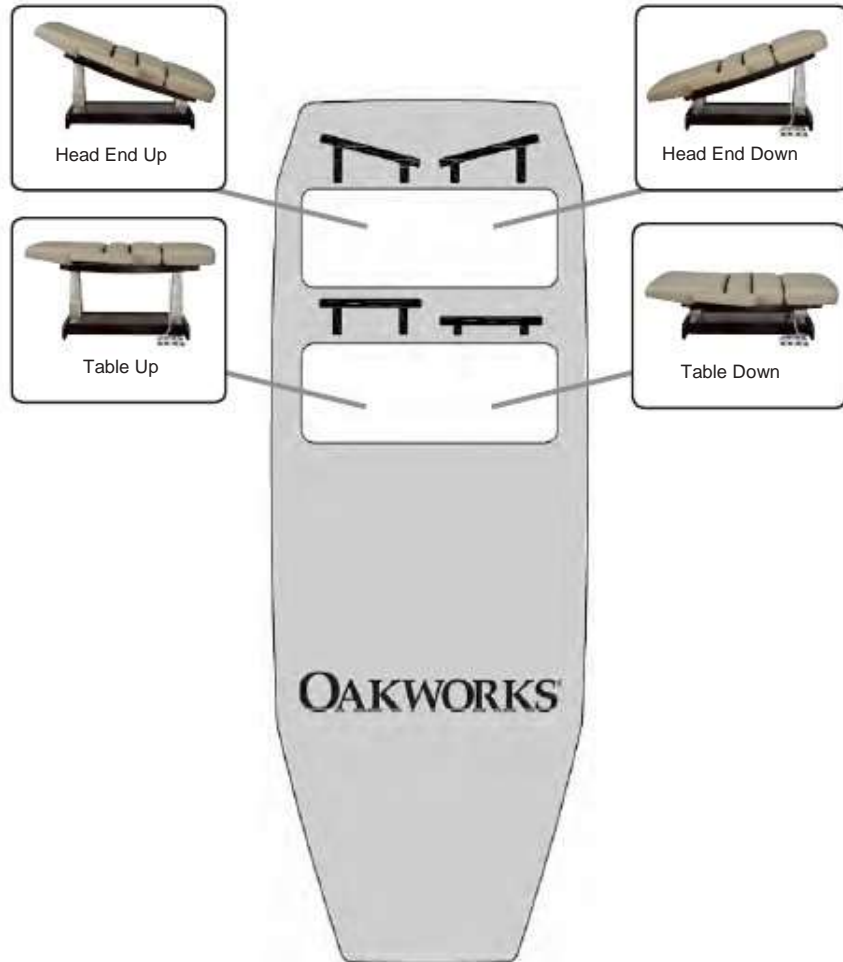

DIRECTIONS FOR USE

**LOCKING CASTERS**



**LOCK**  
To lock, push locking tab down.



**UNLOCK**  
To unlock, pull tab up as shown.



## ARM REST INSTALLATION AND ADJUSTMENT INSTRUCTIONS

### OPTIONAL ACCESSORY AVAILABLE ON 4 SECTION TOP ONLY

**CAUTION:** Do not use the arm rest for customer weight support during the mounting or dismounting of the table. The arm rest is not designed to support the patient's weight.



Adjustable Side Arm Rests



Manicure Arm Rests

### TO INSTALL THE ARM REST:

The arm rests adjust automatically as the table's back support moves to remain parallel to the floor in any position. They are designed to be strong and will take a reasonable amount of weight, but they are not designed to be used to sustain a person's weight when getting on or off the table.



1. Insert end of arm rest into hole in backrest while holding arm rest at 60° angle.



2. Push end all the way into hole and drop arm rest into horizontal position. Tug slightly to make sure the armrest is fully locked to the table (for patient safety).



To remove the arm rest, simply reverse the procedure above.

### TO LEVEL THE ARM REST:

The arm rest height is adjusted to level at the factory. When in use, some of the new parts will wear, and you may see some sagging of the arm rest over time. If the arm rest is too low the height can easily be adjusted using the enclosed Allen wrench.



#### To Raise the Arm Rest



1. Loosen bottom 2 set screws (turn counter-clockwise).



2. Turn side set screw (clockwise to raise or counter clockwise to lower) while lightly raising the arm rest with your other hand (to make the adjustment easier).



3. When you have achieved the desired height, tighten the two bottom set screws (turn clockwise).

### LOWERED ARM REST INSTRUCTIONS

For a totally comfortable and relaxed patient, add a Lowered Arm Rest Shelf to your lift table. It's covered in the same luxurious plush padding as the table itself. The Lowered Arm Rest Shelf can be removed when not in use and stored away. It can also act as a table extender, when used in place of the face rest or at the foot of the table. For complete use & care instructions see product instructions "Arm rest shelf instructions" included with the arm rest.

Lowered Arm Rest Shelf with Aromatherapy, shown here with QuickLock™ Face Rest

Lowered Arm Rest Shelf, shown here used as a table extender



#### CAUTION

Do not sit on excessive weight or pressure on lowered arm shelf.

### QUICKLOCK™ FACE REST INSTRUCTIONS

Double articulating action provides nearly limitless positioning options with the QuickLock™ Face Rest. The adjustable pad takes pressure off sensitive facial areas while providing superb support. The QuickLock™ Face Rest can be used in both prone and supine positioning and folds out of the way when not in use. Adjustments are made easily by loosening the cam locks, adjusting for height and angle and then locking the cam locks into that position.



#### CAUTION

Do not put excessive weight or pressure on the face rest.

Do Not extend the dowels of the Face Rest further than 3" from the table outlets to ensure a stable connection.

To remove the QuickLock™ Face Rest, just pull the frame from the outlets in the end of the table until it comes free. When replacing the QuickLock™ Face Rest, just push the frame back into the outlets being sure to keep the dowels within 3" of the table to ensure a stable connection. For complete use & care instructions see product instructions "QuickLock Face Rest instructions" included with the face rest.

QuickLock™ Face Rest

Important Safety Note: Maximum Distance from edge of Table = 3"



\* U.S. Patent #5,177,823

## CLEANING

CLEAN your upholstered items when needed using a mild solution of 4:1 diluted non-alcohol cleaner such as Formula 409®, Fantastik®, or Green Windex®

DISINFECT your fabric with Protex, MadaCide, MadaWipe, Accell TB, Virox® (Canada), or a diluted 1/10 bleach solution. Dry immediately after cleaning to remove excess cleaning solution.

DO NOT use citrus based cleaners or other strong cleaners, such as alcohol, acetone, higher concentrations of bleach or other products that contain high concentrations of these substances.

DO NOT expose the fabric to temperatures below 32°F/0°C or above 95°F/35°C.

DO NOT expose the fabric to direct sunlight, adhesives, liquids, or abrasive materials.

FAILURE TO FOLLOW RECOMMENDATIONS WILL VOID THE WARRANTY ON THE FABRIC.

## IMPORTANT



## CAUTION

Before cleaning with any liquid cleaner be sure to unplug the power cord from the power outlet.

## INSPECTIONS & MAINTENANCE

### RECOMMENDED REGULAR INSPECTIONS (monthly or local standard)

- Check for damage to the power, handset or foot switch cables.
- Visually inspect components for obvious damage that could cause problems during operation.

### RECOMMENDED PERIODIC INSPECTIONS (yearly or local standard)

- Check for damage to the power, handset or foot switch cables and all visible wiring.
- Visually inspect components for obvious damage that could cause problems during operation.
- Check all mechanical functions using the foot control. Repeat using the hand control. Check for abnormal noises.
- Replace any missing or illegible labels.
- Check that all fasteners are present and fastened securely.
- Check table grounding.
- Clean unusual buildup of dirt on the table and/or parts of the table not normally cleaned on a regular basis.
- Check for tears or cracks in the tabletop pads.

### MAINTENANCE

- No specific maintenance tasks are required.
- Oakworks medical tables are designed and built to provide many years of dependable service. Please follow local regulations and laws when disposing of the electrical components used in this table.

## IMPORTANT

## TROUBLESHOOTING

### DUTY CYCLE

The Oakworks PerformaLift Series Exam Table has two lifting columns that control height and Trendelenburg and two actuators to control the electric top. Each of these devices has a duty cycle of approximately 10%, meaning 2 minutes of operation within a 20 minute period. Exceeding this duty cycle can damage this equipment.



## CAUTION

The table weighs as much as 235 lbs. DO NOT lift or move the unit using proper safety procedures or equipment. DO NOT turn the table on its side for any reason. To do so could cause damage to the base and will void the warranty. There are no serviceable items that need this action.

- without
- warranty.
- serviceable items

### IF THE TABLE WILL NOT CHANGE POSITION

- Check the outlet to be sure that it has power and that the power cable is plugged in. Try each foot control and hand control to see if any work. If any work, then possibly there is a loose connection or a faulty controller.

- It may be necessary to do a reset of the control box.
  - a. Press second row of 2 buttons simultaneously on handset or the two lift buttons on the foot control. *(sometimes it takes several attempts to press them "simultaneously")*
  - b. Control box will beep approximately 10 times
  - c. Run all motors in system to fully retracted position (down)
  - d. Re-test table to insure proper functions.

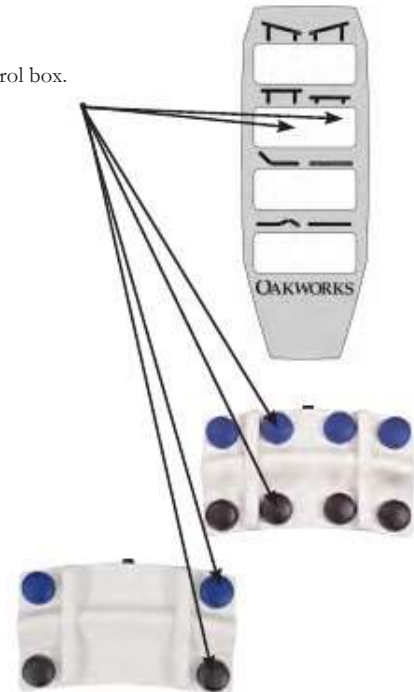

- Unplug the power cable from the wall outlet.
- Make sure that all male and female connectors on the control box are firmly pushed into each other. Even a slight misconnection can cause a possible malfunction. Check the connections on top at the columns.
- Plug the unit back into the wall and check the controls again. If none work, then contact customer service. 717.235.6807

### QUESTIONS TO ASK BEFORE CALLING CUSTOMER SERVICE

- Is the unit plugged in?
- Does the outlet have power?
- Check all connections of the control box, is everything seated securely?
- Do any of the foot control buttons work?

### IMPORTANT



#### SAFETY NOTE:

Always unplug power cord before removing or connecting cables to the control box.

### FOOT OR HAND CONTROL REPLACEMENT INSTRUCTIONS



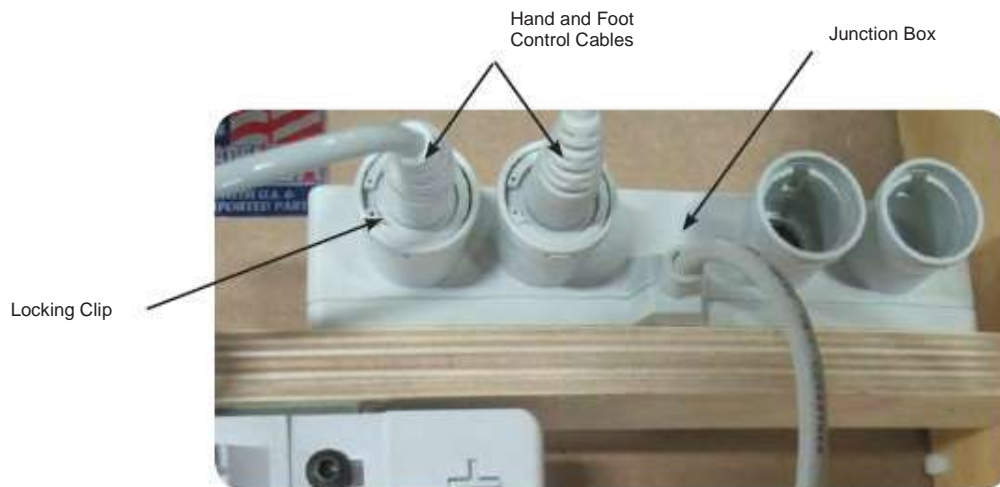

Replacement of the foot or hand control may be necessary if the control does not actuate the table functions. See troubleshooting section before ordering replacement controls.

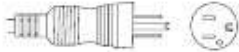

To replace the foot control, follow these steps:

1. Unplug power cord.
2. Follow control cord to locate junction box
3. Using a small screwdriver or tool, remove locking ring
4. Pull cable to remove from junction box
5. Insert new control cable and replace locking ring
6. Reconnect power cord.
7. Attempt to operate the table elevation functions from the control.
8. Should this fail to return the table to operating condition, contact the Customer Service Department at 717-235-6807.

**POWER CORD PLUG PARTS**

OAKWORKS Part #.:	Voltage (AC)	Power Cord Plug	
5097-11	120v 60 Hz	3 prong grounded hospital grade; North America	
5097-3	220v 50 Hz	Continental Plug; Europe	
5097-4	220v 50 Hz	Swiss plug; Switzerland	
5097-2	220v 50 Hz	British plug; United Kingdom	

**LIST OF TABLE PARTS**

Part Number	Description
2092-1	(4) Button Hand Control
55721	(8) Button Hand Control
6632	(4) Button Foot Control
6631	(8) Button Foot Control
67721	110 Volt Control Box
67720	220 Volt Control Box
57410	Lift Column
67722	Table Top Actuator
57921	Junction Box
0781	Locking Casters
xxxx	Stirrups

Part Number	Description - Optional Accessories
18010	Lowered Arm Rest/Table Extender
6011	QuickLock Platform
2410-xx	AeroCel Face Rest Crescent
11349	Paper Roll Holder
3419-06	Bolster Side Arm Rests

**WARRANTY INFORMATION**

View complete warranty details at [www.oakworks.com](http://www.oakworks.com)

**PART NUMBER & SERIAL NUMBER LOCATION**



The model number and serial numbers are located on the lift column at the foot end of the table.

Model Number                      Serial Number

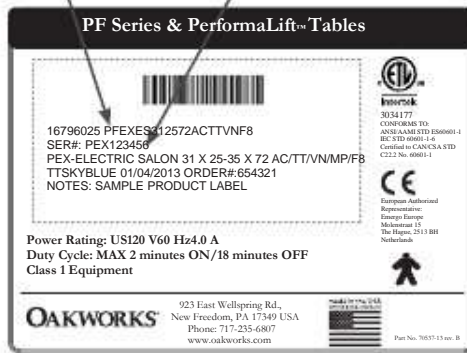

Model and Serial numbers always start with a letter.

**MODEL NUMBER CHART**

P F M P E S X X X X X A C T T Z Z X X

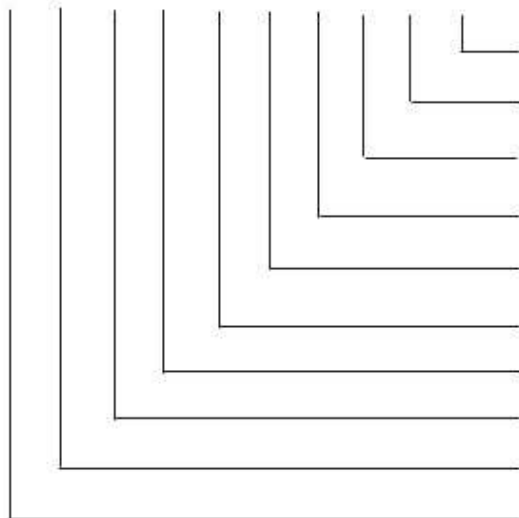



- Options
- Grommets
- Fabric: TerraTouch
- Padding: PL=3", AC=4"
- Table Top Length
- Minimum Table Height
- Table Width
- Top: FT=Flat, LB=Lift Assist Backrest, ES=Electric
- Maple Base
- PerformaLift Table

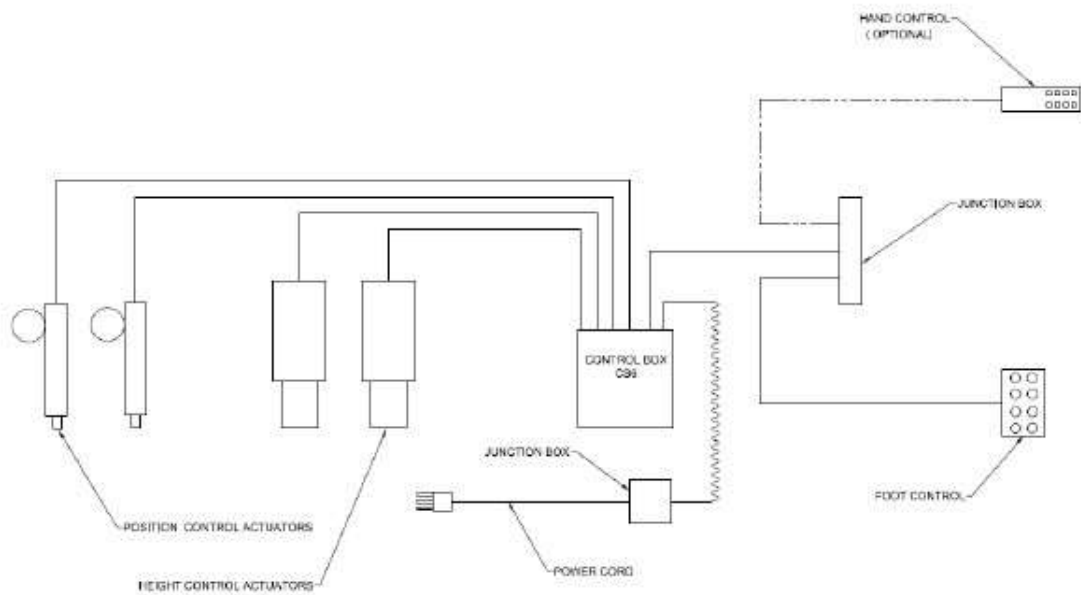

## WIRING DIAGRAM



## ELECTRICAL SPECIFICATIONS

Designed for:	North America	Europe
Input Service	120 VAC/15 amp/60Hz	220 VAC/10 amp/50/60Hz
Current Draw	4.0 amps	2.0 amps
Maximum Momentary Current Consumption	6.0 amps	3.0 amps
Voltage Output to Actuators	24 VDC	24 VDC
Electric Shock Protection	Class 1 Equipment	Class 1 Equipment
Tabletop Applied Part	 Type B Applied Part	 Type B Applied Part
Table Top IEC 529 Rating	IPX0	IPX0
Mode of Operation	Intermittent Operation MAX 2 minutes ON 18 minutes OFF	Intermittent Operation MAX 2 minutes ON 18 minutes OFF

## TABLE SPECIFICATIONS

	North America	Europe
Weight	~ 235 lbs.	~ 107 kg
Shipping Weight	~ 325 lbs.	~148 kg
Lifting Capacity	550 lbs.	250 kg.

## PERMISSIBLE ENVIRONMENTAL CONDITIONS

Conditions	Temperature	Humidity	Atmospheric Pressure
Normal Use	50° (10°C) to 104° (40°C)	20% to 60% RH	98 to 105 kPa
Storage & Transport	-20° (-29°C) to 135° (57°C)	20% to 95% RH	98 to 105 kPa



19.0 IEC 60601-1-2 (Ed.3) Clause 5 (IEC 60601-1-2 (Ed.3) Clause 5)

Guidance and manufacturer's declaration –electromagnetic emissions		
The PERFORMALIFT is intended for use in the electromagnetic environment specified below. The customer or the user of the PERFORMALIFT should assure that it is used in such an environment.		
Emissions test	Compliance	Electromagnetic environment – guidance
RF emissions CISPR 11	Group 1	The PERFORMALIFT uses RF energy only for its internal function. Therefore, its RF emissions are very low and are not likely to cause any interference in nearby electronic equipment.
RF emissions CISPR 11	Class A	The PERFORMALIFT is suitable for use in all establishments other than domestic and those directly connected to the public low-voltage power supply network supplies buildings used for domestic purposes.
Harmonic emissions IEC 61000-3-2		
Voltage fluctuations / emissions flicker IEC 61000-3-3		Class A Complies

Report Number: 101033247ATL-0

Intertek that

Issued: 03/14/2013

19.0 IEC 60601-1-2 (Ed.3) Clause 5 (IEC 60601-1-2 (Ed.3) Clause 5)

Data:

Recommended separation distances between portable and mobile RF communications equipment and the PERFORMALIFT			
The PERFORMALIFT is intended for use in an electromagnetic environment in which radiated RF disturbances are controlled. The customer or the user of the PERFORMALIFT can help prevent electromagnetic interference by maintaining a minimum distance between portable and mobile RF communications equipment (transmitters) and the PERFORMALIFT as recommended below, according to the maximum output power of the communications equipment.			
Rated maximum output power of transmitter  W	Separation distance according to frequency of transmitter m		
	150 kHz to 80 MHz  d $1.2\sqrt{P}$	80 MHz to 800 MHz  d $1.2\sqrt{P}$	800 MHz to 2,5 GHz  d $2.3\sqrt{P}$
Table 1 0,01	0.12	0.12	0.23
0,1	0.38	0.38	0.73
1	1.20	1.20	2.30
10	3.79	3.79	7.27
100	12.00	12.00	23.00
For transmitters rated at a maximum output power not listed above, the recommended separation distance d in metres (m) can be estimated using the equation applicable to the frequency of the transmitter, where P is the maximum output power rating of the transmitter in watts (W) according to the transmitter manufacturer.			
NOTE 1 At 80 MHz and 800 MHz, the separation distance for the higher frequency range applies.			
NOTE 2 These guidelines may not apply in all situations. Electromagnetic propagation is affected by absorption and reflection from structures, objects and people.			

19.0 IEC 60601-1-2 (Ed.3) Clause 5 (IEC 60601-1-2 (Ed.3) Clause 5)

Data:

Guidance and manufacturer's declaration –electromagnetic immunity			
The PERFORMALIFT is intended for use in the electromagnetic environment specified below. The customer or the user of the PERFORMALIFT should assure that it is used in such an environment.			
Imm unity test	IEC 60601 test level	Compliance level	Electromagnetic environment – guidance
Electrostatic discharge (ESD)  IEC 61000-4-2	±6 kV contact  ±8 kV air	±6 kV contact  ±8 kV air	Floors should be wood, concrete or ceramic tile. If floors are covered with synthetic material, the relative humidity should be at least 30 %.
Electrical fast transient/burst  IEC 61000-4-4	±2 kV for power supply lines  ±1 kV for input/output lines	±2 kV for power supply lines  Not Applicable for input/output lines	Mains power quality should be that of a typical commercial or hospital environment.
Surge  IEC 61000-4-5	±1 kV differential mode  ±2 kV common mode	±1 kV differential mode  ±2 kV common mode	Mains power quality should be that of a typical commercial or hospital environment.
Voltage dips, short interruptions and voltage variations on power supply input lines IEC 61000-4-11	<5 % $U_T$ (>95 % dip in $U_T$ ) for 0,5 cycle  40 % $U_T$ (60 % dip in $U_T$ ) for 5 cycles  70 % $U_T$ (30 % dip in $U_T$ ) for 25 cycles  <5 % $U_T$ (>95 % dip in $U_T$ ) for 5 sec	<5 % $U_T$ (>95 % dip in $U_T$ ) for 0,5 cycle  40 % $U_T$ (60 % dip in $U_T$ ) for 5 cycles  70 % $U_T$ (30 % dip in $U_T$ ) for 25 cycles  <5 % $U_T$ (>95 % dip in $U_T$ ) for 5 sec	Mains power quality should be that of a typical commercial or hospital environment. If the user of the PERFORMALIFT requires continued operation during power mains interruptions, it is recommended that the PERFORMALIFT be powered from an uninterruptible power supply or a battery.
Power frequency (50/60 Hz) magnetic field IEC 61000-4-8	3 A/ m	3A /m	Power frequency magnetic fields should be at levels characteristic of a typical location in a typical commercial or hospital environment.
NOTE $U_T$ is the a.c. mains voltage prior to application of the test level.			

Table 2

19.0 IEC 60601-1-2 (Ed.3) Clause 5 (IEC 60601-1-2 (Ed.3) Clause 5)

Data:

Guidance and manufacturer's declaration –electromagnetic immunity			
The PERFORMALIFT is intended for use in the electromagnetic environment specified below. The customer or the user of the PERFORMALIFT should assure that it is used in such an environment.			
Immunity test	IEC 60601 test level	Compliance level	Electromagnetic environment – guidance
Conducted RF IEC 61000-4-6	3 Vrms 150 kHz to 80 MHz	3 Vrms	<p>Portable and mobile RF communications equipment should be used no closer to any part of the [ME EQUIPMENT OR ME SYSTEM], including cables, than the recommended separation distance calculated from the equation applicable to the frequency of the transmitter.</p> <p>Recommended separation distance</p> $d = 1.2 \sqrt{P}$
Radiated RF IEC 61000-4-3	3 V/m 80 MHz to 2,5 GHz	3 V/m	<p> <math>d = 1.2 \sqrt{P}</math> 80 MHz to 800 MHz  <math>d = 2.3 \sqrt{P}</math> 800 MHz to 2,5 GHz                 </p> <p>where P is the maximum output power rating of the transmitter in watts (W) according to the transmitter manufacturer and d is the recommended separation distance in metres (m).</p> <p>Field strengths from fixed RF transmitters, as determined by an electromagnetic site survey, should be less than the compliance level in each frequency range.</p> <p>Interference may occur in the vicinity of equipment marked with the following symbol:</p> 
NOTE 1 At 80 MHz and 800 MHz, the higher frequency range applies.			
NOTE 2 These guidelines may not apply in all situations. Electromagnetic propagation is affected by absorption and reflection from structures, objects and people.			
<p><sup>a</sup> Field strengths from fixed transmitters, such as base stations for radio (cellular/cordless) telephones and land mobile radios, amateur radio, AM and FM radio broadcast and TV broadcast cannot be predicted theoretically with accuracy. To assess the electromagnetic environment due to fixed RF transmitters, an electromagnetic site survey should be considered. If the measured field strength in the location in which the PERFORMALIFT is used exceeds the applicable RF compliance level above, the PERFORMALIFT should be observed to verify normal operation. If abnormal performance is observed, additional measures may be necessary, such as re-orienting or relocating the PERFORMALIFT.</p> <p><sup>b</sup> Over the frequency range 150 kHz to 80 MHz, field strengths should be less than 1 V/m.</p>			

Table 4

# PerformaLift™

## CONTACT INFORMATION:

Oakworks® Inc.

923 East Wellspring Road  
New Freedom, PA 17349

Phone: 717-235-6807

FAX: 717-235-6798

[www.oakworksmid.com](http://www.oakworksmid.com)



European Authorized Representative  
Emergo Europe

Molenstraat 15  
The Hague, 2513 BH Netherlands  
Tel: +31 70 3458570  
Fax: +31 70 3467299



**Intertek**

3034177

CONFORMS TO:	ANSI/AAMI STD	ES60601-1		
IEC	STD	60601-1	3RD	EDITION
IEC	STD	60601-1-2	3RD	EDITION
IEC	STD	60601-1-6	3RD	EDITION
CERTIFIED TO	CAN/CSA STD	60601-1		C22.2
CB TEST	CERTIFICATE AND			REPORT

Manual Part Number MMMNST0026  
Revision date: 05.14.13  
1st Edition, February 2012  
English, Printed in USA  
Original Instructions

made in the USA  
with US & imported parts



**OAKWORKS®**