

**IEEE1394A FireWire/Hi-Speed USB2.0/eSATA  
3.5" Serial ATA Hard Drive Enclosure**

**G-S350SUA**



**User's Manual**

# CONTENTS

<b>INTRODUCING 1394A FIREWIRE/ USB2.0/eSATA HI-SPEED ENCLOSURE</b>	<b>3</b>
<b>About this Guide</b>	<b>3</b>
<b>System Requirements</b>	<b>3</b>
<b>Package Contents</b>	<b>4</b>
<b>Safety Precautions</b>	<b>4</b>
<b>HARDWARE BASICS</b>	<b>6</b>
<b>HARDWARE INSTALLATION</b>	<b>7</b>
<b>Software Installation for MAC</b>	<b>10</b>
<b>SATA Connection for MacOS X 10.2 and above</b>	<b>10</b>
<b>Firewire and USB Connection for Mac OS X</b>	<b>11</b>
<b>Software Installation for PC</b>	<b>12</b>
<b>SATA Connection for Windows XP/vista/7</b>	<b>12</b>
<b>Firewire and USB Connection for Windows XP/vista/7</b>	<b>12</b>
<b>HARD DRIVE PARTITION and FORMAT PROCEDURES in PC WINDOWS XP/vista/7</b>	<b>13</b>
<b>Frequently Asked Questions</b>	<b>16</b>

# Introducing IEEE1394A FireWire/Hi-Speed USB2.0/eSATA 3.5" Hard Drive Enclosure - G-S350SUA

Thank you for choosing the G-S350SUA aluminum IEEE1394A FireWire/Hi-Speed USB2.0/eSATA 3.5" Hard Drive Enclosure. This Aluminum enclosure supports 3.5" SATA Hard drive up to 1TB. It is simple to install and comes with all the parts you need to create an external hard drive.

Based on IEEE1394A FireWire/SATA II, SATA I, USB2.0 and USB1.1 specifications the transfer rates are up to:

SATA II - 3.0Gb/s

SATA I - 1.5Gb/s

1394A - 400Mb/s

USB2.0 - 480Mb/s

USB1.1 - 12Mb/s

G-S350SUA can support the speed specification listed above, however its transfer rates are possible to be lower, and will vary depending upon the Operating System, type of SATA, 1394A and USB host controller, SATA Hard Drive and computer hardware.

## About This Guide

Before you begin using the G-S350SUA, be sure to read this manual in its entirety.

This guide contains:

- Introducing IEEE1394A FireWire/Hi-Speed USB2.0/eSATA
- 3.5" Hard Drive Enclosure
- Hardware Installation
- Software Installation
- Hard Drive Partition and Format in PC Windows XP/vista/7
- FAQ

## System Requirements

- MacOS X 10.1 to 10.8 for USB and Firewire connection
- MacOS X 10.2 and later for SATA connection
- Windows XP/vista/7
- Any desktop or Notebook computer with an available SATA, FireWire or USB port

## Package Contents

The G-S350SUA-Aluminum IEEE1394A FireWire/Hi-Speed USB2.0 /eSATA 3.5" Hard Drive Enclosure package includes the following software and documentation:

- G-S350SUA enclosure
- 6 pin-6 pin1394A FireWire Cable
- USB2.0 cable
- AC/DC Adapter

## Safety Precautions

### ON INSTALLATION

1. To reduce the risk of fire or electric shock, do not expose this product to rain, water or moisture.
2. Do not place any containers with liquids (drinking glass, flower vase, etc.) or containers with small metal parts (paper clips, etc.) on top of the unit.
3. According to standard industry practice, surge protection is recommended for all telecommunications devices. Surge suppressors and/or line conditioning should be used on the input power supply.

### ON OPERATION

- Do not move the chassis during operation. Doing so may cause a malfunction.
- Protect the unit from shocks and vibrations.
- Do not use the subsystem in areas exposed to oily smoke or steam, such as a kitchen or close to a humidifier.
- Do not use the subsystem in locations exposed to rain or splashes of water, such as outdoors, in a bathroom, or close to a window.
- Do not use the subsystem on an unstable or slanted surface without proper support.
- Do not expose the unit to direct sunlight or hot air where the temperature could exceed 45°C, or very cold locations where the temperature is below 0°C.
- Keep the power cord away from hot appliances.
- Do not touch the power cord with wet hands.

## **ON TRANSPORTATION**

Save the packing materials as you may need to repack and transport the unit at a later date.

Always remove the disc before moving the unit.

## **ON POWER SOURCES**

When you are not using the unit for a long time, disconnect the power cord from the unit.

To unplug the AC power adapter from the wall outlet, grasp the adapter itself. Do not pull the cord.

### **Warning**

If any of the following conditions occur, immediately disconnect the power cord from the wall outlet and contact your dealer or an authorized service station. Continuing to use the computer involves the risk of fire and electric shock.

- Smoke or unusual smell is coming from the subsystem.
- Water has entered the unit, or the unit has become wet.
- A foreign object has entered the unit.
- The unit has been dropped or the front panel or frame has been damaged.
- The power cable is damaged, causing wire breakage or exposed leads.

# Hardware Basic

## Precaution:

Please make sure your hand is dry and remove static from your body by touching metal parts of your computer chassis.

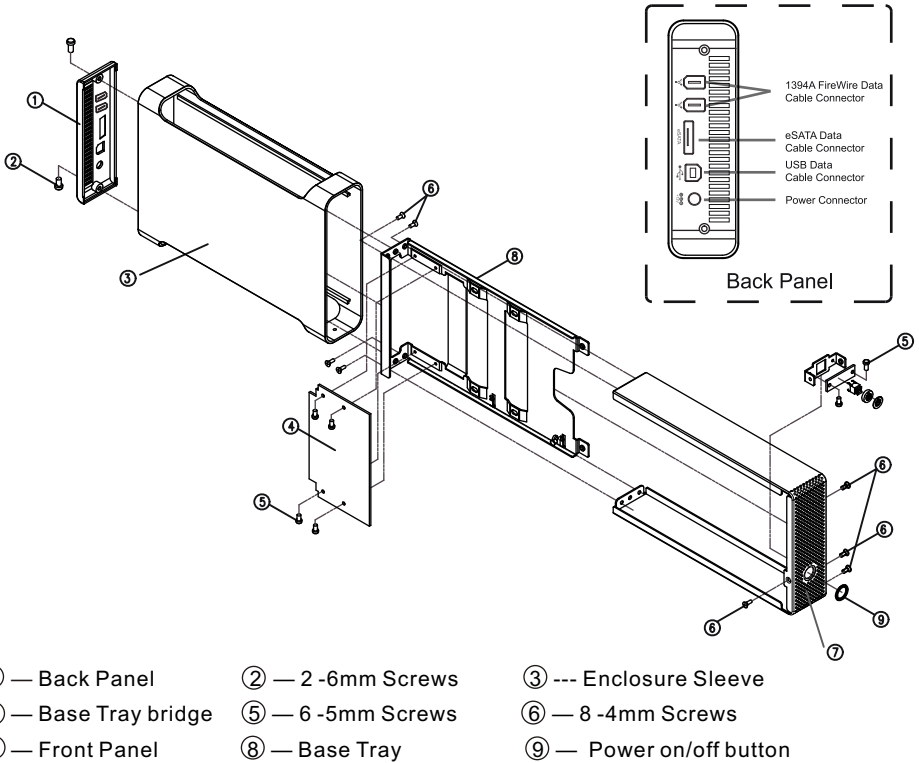

# Hardware Installation

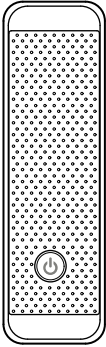

Front Panel

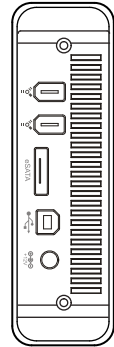
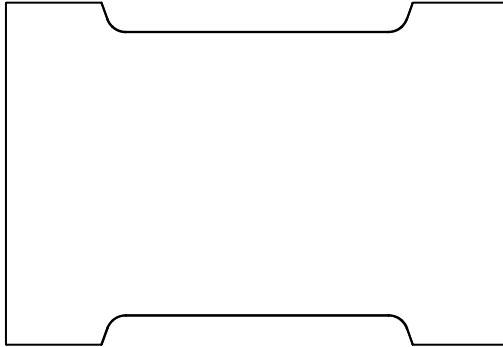

Back Panel

**Note:** The diagrams below uses the G-S350U Enclosure as an example.



1. Unscrew to loosen the Enclosure Back Panel. Remove the Back Panel.



2. Use your fingers to push the Base Tray out.

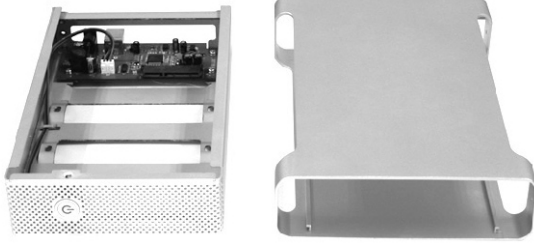

3. Pull the Enclosure Sleeve out from the Base Tray and place it aside.

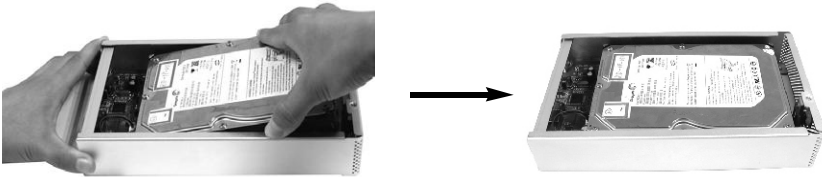

4. Align the black Power/SATA connector on the hard drive to the black female SATA connector on the Base plate bridge, and push the drive into the connector completely.

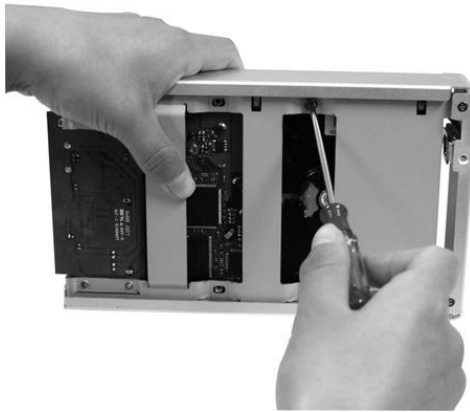

5. Secure the HDD to the Base Tray with 2 hard drive screws.



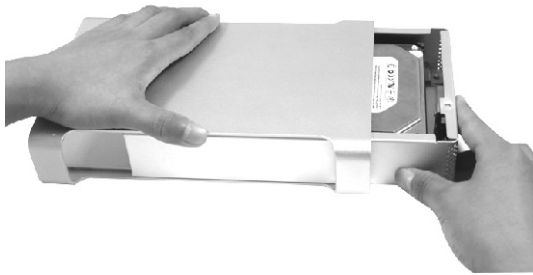

6. Push the Base Tray into the Enclosure Sleeve.



7. Secure the Base Tray and Enclosure Sleeve with two 6mm screws.



8. Plug the AC/DC adapter into the Enclosure, and connect the unit to your computer using a USB cable ,Firewire cable or eSATA cable. Then press the Power Button to turn it on.

## Software Installation for Mac

### SATA Connection for MacOS X 10.2 and above

At the time when this manual is written, none of Mac computers has built-in external SATA port accessible to connect G-S350SUA enclosure. In order to take advantage of high performance via SATA connection, current solution is to add a third-party Mac compatible SATA II or SATA I to PCI or ExpressCard host controller adapter with external SATA port (with “L” shaped key type) or eSATA port. When external SATA port is available, please follow steps below to use G-S350SUA enclosure:

1. When computer is powered off, attach G-S350SUA to the SATA port of the computer.
2. Power on G-S350SUA first, then turn on the computer.
3. After Mac OS boots up, it will recognize it automatically, ask you to initialize the new drive if it was not initialized yet, and mount the drive on desktop.

Above described connection and power sequence is referred to as Hot Boot. There are total five power sequence modes by which an external hard drive can possibly be used with a computer system. They are defined as follows:

**Hot Boot** - Computer is off, enclosure is on and is attached to computer. Boot up system.

**Cold Boot** - Computer is off, enclosure is off and is attached to computer. Boot up system completely, then turn on the enclosure.

**Hot Plug** - System is up and running, enclosure is turned on then attached to computer.

**Cold Plug** - System is up and running, enclosure is off then attached to computer. Enclosure is turned on.

**Power Cycle** - System is up and running, enclosure is on and mounted on the computer. Then, power off the enclosure, wait for several seconds and turn the enclosure back on.

It is important to note that different SATA host adapters handle the power sequence in different way. Some support all five power sequence modes, the other can only support Hot Boot. G-S350SUA supports all five power sequence modes. To find out what your SATA host adapter is capable of, please contact the manufacturer of SATA host adapter, or simply try all power sequence mode yourself.

Before disconnecting the SATA drive cable from the computer, we recommend you to shut down the computer first, because current system driver and SATA host specification do not make SATA hard drive 100% removable like USB or Firewire hard drive.

## **FireWire and USB Connection for MacOS X**

When the Enclosure is connected to the computer, MacOS X will recognize it automatically, initialize it (if the drive is not initialized) and mount the drive to desktop. All five power sequence modes are supported in Firewire or USB connection.

Note: MacOS X provides a Disk Utility to create multiple volumes, which is located in Utilities folder inside Applications folder.

## Software Installation for PC

### SATA Connection for Windows XP/Vista/7

Some PC computers nowadays are equipped with external SATA ports for peripheral connectivity, or provide a SATA cable and bracket to route internal SATA port on motherboard to external port. Otherwise, to take advantage of high performance SATA connection, you need to add a third-party SATA II or SATA I host controller adapter with external SATA port the “L” shaped key type). When external SATA port is available, please follow steps below to use G-S350SUA enclosure:

1. When computer is powered off, attach G-S350SUA to the SATA port of the computer.
2. Power on G-S350SUA first, then turn on the computer.
3. After Windows boots up, it will load the driver and recognize the Enclosure automatically. If you don't see a new(SATA) drive in My Computer, probably the SATA drive needs to be partitioned and formatted first.

Above described connection and power sequence is referred to as Hot Boot. There are total five power sequence modes, Hot Boot, Cold Boot, Hot Plug, Cold Plug, and Power Cycle, by which an external hard drive can possibly be used with a computer system. Please refer to the section “SATA Connection for MacOS X 10.2 and above” for definition.

It is important to note that different SATA host adapters handle the power sequence in different way. Some support all five power sequence modes, the other can only support Hot Boot. G-S350SUA supports all five power sequence modes. To find out what your SATA host adapter is capable of, please contact the manufacturer of SATA host adapter, or simply try all power sequence mode yourself.

### Firewire and USB Connection For Windows XP/Vista/7

When the enclosure is connected to the computer and power on, the system will start installing for the proper driver. Please follow the on-screen instruction to complete the driver installation.

If you do not see the new drive letter added in My Computer after the driver finishes loading, the reason could be the hard disk such as a brand new one has no partition and format yet. In this case, please follow the procedures in next section to partition and format it before using.

# HARD DRIVE PARTITION and FORMAT PROCEDURES in PC WINDOWS XP/Vista/7

If you can see a new entry under Disk drives of Device Manager, you are ready to partition and format the drive.

1. Open Control panel, “Administrative Tools” and “Computer management”.

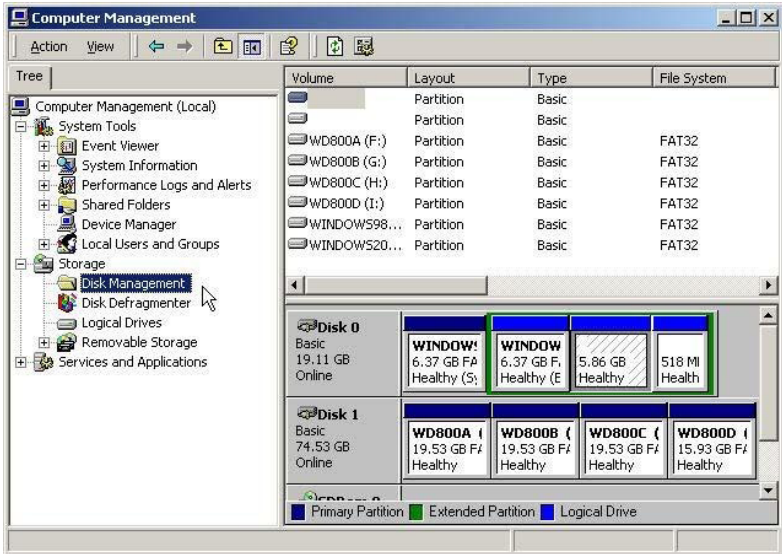

Step 2

2. Click on “Disk Management”.



Step 3

3. “Write Signature and Upgrade Disk Wizard” windows will show up and click “Next”.



Step 4

4. Write a signature to the new drive, click “Next”.



Step 5

5. Click “Finish” to close the wizard.

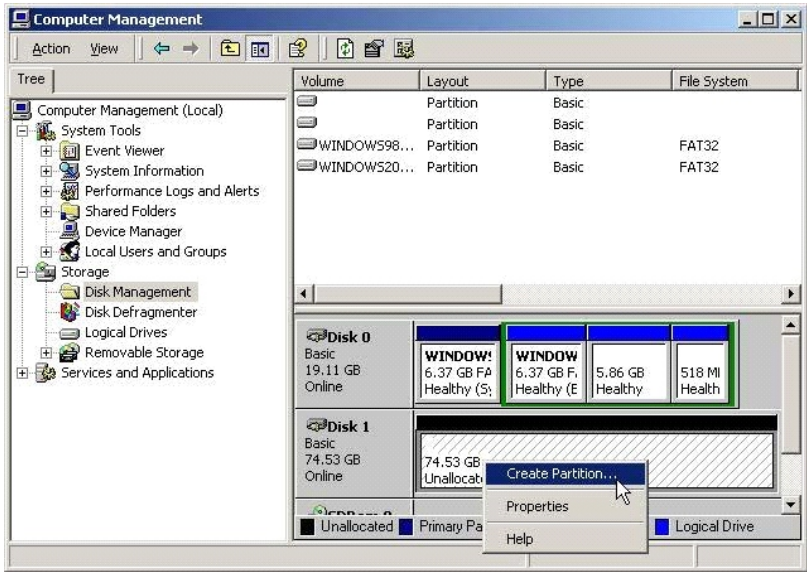

Step 6

6. Select the new “Unallocated” disk, and then right click to choose “Create partition”.



Step 7

7. Follow the onscreen instruction to partition and fully format the drive.  
 \*note: If it assigns a new hard drive letter but format dose not run automatically, please exit “Computer Management”, and find the new drive letter in My computer to format it completely.

## Frequently Asked Questions

**Q1, What are SATA, SATA I, SATA II, eSATA any way? How are they related to G-S350SUA enclosure?**

A1: SATA stands for Serial ATA, in contrast to old Parallel ATA (IDE, EIDE, ATA and ATAPI) technology. SATA starts with 1.5Gb/s specification, and evolves to 3.0Gb/s specification, which is commonly referred to as SATA II. Hence, original SATA 1.5Gb/s is called SATA I to distinguish with SATA II 3.0Gb/s.

Initially SATA was designed as an internal or inside-the-box interface technology for storage device like HDD. Both SATA I and SATA II hard drives use plug and receptacle interface with “L” shaped key as shown below.

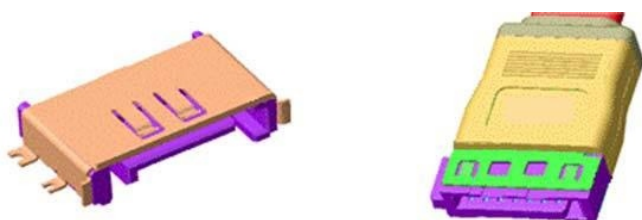

This connectors and cable(flat) with “L” shaped key support both SATA 1.5Gb/s and 3.0Gb/s, however the cable length is limited to 1m(around 3.3 feet) maximum. When this manual was written, majority of SATA ports provided by computers or add-on SATA host adapters are the receptacle with “L” shaped key.

As shown below, it is more and more common to find a new type of SATA receptacle in the system or PCI/ExpressCard host card and plug(without “L” shaped key), called eSATA. eSATA becomes a standard for external SATA peripherals. Our G-S350SUA has eSATA port built in. Depending on the type of SATA port you have in the computer, please get the proper SATA cable to connect them.



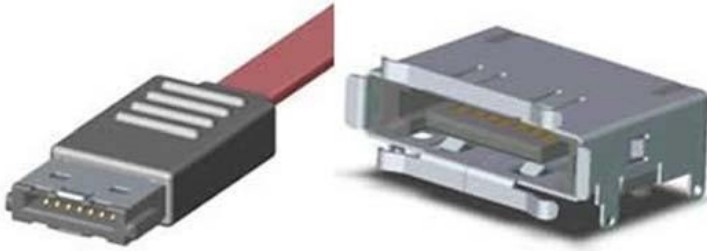

**Q2. How should I disconnect G-S350SUA safely from the computer? After I disconnect the SATA enclosure, why does the drive icon still stay on the desktop of MacOS X?**

A2: For Firewire or USB connection in Windows PC, please click “Safely remove mass storage device - Drive letter” line inside Safely Remove Hardware icon on the System Tray; In Mac computer, please trash the external drive icon. Then disconnect G-S350SUA from the system.

In SATA connection, depending on the SATA host controller (and sometimes OS) you use, some controllers support hot plug and unplug function, some don't. You have to find out its capability. To prevent data corruption, the safest way to disconnect SATA cable or power off G-S350SUA is to shut down computer first.

SATA drive (or SATA connection) is not treated essentially as removable device to the most of systems if not all. That is why there is no eject icon associated to SATA drive in Finder of Mac OS X, and System Tray in Windows has no Remove Hardware option for SATA drive. Therefore, when the SATA drive is connected, some system still keeps SATA drive icon, you just won't be able to use the drive until you connect it back.

**Q3. How is SATA compared to USB and Firewire in speed? What performance gain can one expect by using SATA connection?**

A3: Following chart shows the specification data rate(MBps) and Overhead among USB, Firewire and SATA.

**Typical Interface Speeds**

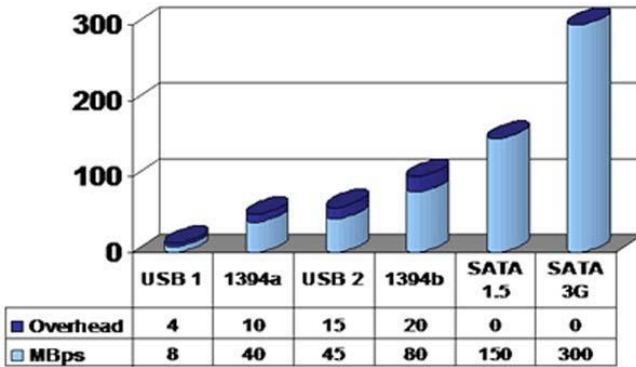

Next table compares real world benchmark between USB, Firewire and SATA drives:

	USB	1394	Seria
Raw Interface speed	480Mbps	400Mbps	1500Mbps
Benchmark comparison 64K read	31.6MB/sec	34.8MB/sec	42.4MB/sec
Benchmark comparison 64K write	26.5MB/sec	26.7MB/sec	56.2MB/sec
Burst Transfer Rate	33.5MB/sec	36.2MB/sec	111.3MB/sec

Table: Comparison of interface speeds and data transfer rates external disk drive interfaces

Above data are quoted from [www.sata-io.org](http://www.sata-io.org). The performance of G-S350SUA in your application might be higher or lower depending upon the hard drive used, SATA and USB host and computer hardware. In our test, we have seen over 60MB/s sequential read and write speed in SATA connection. SATA is the better choice for storage device.