**User's
Manual**

**AQ4280
Optical Light Source**

Notes

1. The contents of this manual are subject to change without prior notice as a result of continuing improvements to the instrument's performance and functionality. The figures given in this manual may differ from those that actually appear on your screen.
2. Every effort has been made in the preparation of this manual to ensure the accuracy of its contents. However, should you have any questions or find any errors, please contact your nearest YOKOGAWA dealer.
3. Copying or reproducing all or any part of the content of this manual without the permission of YOKOGAWA is strictly prohibited.

Trademarks

1. Microsoft, Windows are either registered trademarks or trademarks of Microsoft Corporation in the United States and/or other countries.
2. Adobe, Acrobat, and PostScript are trademarks of Adobe Systems Incorporated.
3. In this manual, the TM and R symbols do not accompany their respective registered trademark or trademark names.
4. Other company and product names are registered trademarks or trademarks of their respective holders.

1st Edition: October 2012(YMI)

All Rights Reserved, Copyright© 2012, Yokogawa Meters & Instruments Corporation

Product Registration

Thank you for purchasing YOKOGAWA products.

YOKOGAWA provides registered users with a variety of information and services.

Please allow us to serve you best by completing the product registration form accessible from our homepage.

<http://tmi.yokogawa.com/>

Safety Information

Warnings!

Do not short-circuit the batteries. Excessive electrical current may cause personal injury due to fumes, electric shock or equipment damage.

Do not operate the equipment near hot objects, in hot environments, in dusty/ humid atmosphere or when condensation is present on the equipment. This may result in electric shock , product malfunction or poor performance.

Safety Precautions

The general safety precautions described herein must be observed during all phases of operation. If the instrument is used in a manner not specified in this guide , the protection provided by the instrument may be impaired . YOKOGAWA assumes no liability for the customer's failure to comply with these requirements.

The following symbols are used on this instrument.



Improper handling or use can lead to injury to the user or damage to the instrument.

This symbol appears on the instrument to indicate that the user must refer to the user's manual For special instructions. The same symbol appears in the corresponding place in the user's manual to identify those instructions. In the manual, the symbol is used in conjunction with the word "WARNING" or "CAUTION".

WARNING

Calls attention to actions or conditions that could cause serious or fatal injury to the user, and precautions that can be taken to prevent such occurrences.

CAUTION

Calls attention to actions or conditions that could cause light injury to the user or cause damage to the instrument or user's data, and precautions that can be taken to prevent such occurrences.

Note

Calls attention to information that is important for proper operation of the instrument.

Table of contents

1. Introduction	1
2. Warranty.....	2
3. Preparing for Operation.....	3
4. Specifications	5
5. Operation	7
6. Trouble shooting.....	22
7. Recommended Replacement Parts	23
8. Maintenance	24
9. Outline drawing	25
10. Connector adapter	26

1 Introduction



The AQ4280 series Optical Light source offers excellent stability, portability and facile adjustments for accurate optical fiber testing.

The AQ4280 can be used to test single mode optical fiber of long distance and local network. Also it can work with optical power meter to measure the loss of optical fiber.

Features:

- Easy-to-use, straight forward operation
- Eye-catching handheld package
- LCD backlight for easy operation in darker environments

2 Warranty

Exclusions

The warranty on your equipment shall not apply to defects resulting from the following:

- Unauthorized repair or modification
- Misuse, negligence, or accident

Returning Product

To return product, you may contact YOKOGAWA to obtain additional information if necessary.

To serve you better, please specify the reasons for the return.

All delivery and mails should be sent to the following nearest YOKOGAWA dealer.

3 Preparing for Operation

3.1 Unpacking the instrument

Packing material

We suggest that you keep the original packing material. Using the original packing material is your guarantee of protecting the instrument during transit.

Checking the package contents

The standard accessories of AQ4280A/B/C are as follows:

No.	Product Name	Qty.
1	Main Unit	1
2	Dry battery AA	2
3	Connector Adapter(FC,SC,ST)	AQ4280A AQ4280B Each 1 AQ4280C Each 2
4	Carrying Case	1
5	Operation Guide(Paper)	1
6	User's Manual(CD)	1
7	Protector	1
8	Strap	1

Checking for damage in transit

After unpacking the instrument, check to see whether it was damaged in transit. This is particularly likely if the outer casing is clearly damaged. If there is damage, do not attempt to operate the instrument or to repair it without authorization. Doing so can cause further damage and you may lose your warranty qualification.

3.2 Power Supply

When you use the battery, the battery indicator on the screen will show the remaining charge. An empty battery indicator means the power is almost out. When the battery charge is extremely low to supply the necessary power, the instrument will automatically switch off . Please change the battery.



When the battery charge is extremely low to supply the necessary power, the instrument will automatically switch off.

Note

To eliminate the possibility of acid leakage, please take out the battery if the unit is not used for a long time.

4 Specifications

4.1 Light Source Specifications

Model	AQ4280A	AQ4280B	AQ4280C
Light emitter	LD		
Compliant fiber	SM (ITU-T G.652)		
Center wavelength ^①	1310/1550±20 nm	1310/1550±20 nm 1490±10 nm	1310/1550±20 nm 1490/1625±10 nm
Spectral width ^{①②}	<5 nm(1310 nm)	<5nm (1310 nm,1490 nm)	<5 nm(1310 nm,1490 nm,1625 nm)
	<10 nm(1550 nm)	< 10 nm(1550 nm)	<10 nm(1550 nm)
Optical output level ^③	-5 dBm±1 dB	-5 dBm±1 dB	-5 dBm±1 dB
Level stability (15min) ^{①③}	<±0.05 dB	<±0.05 dB (1310/1550nm)	<±0.05 dB (1310/1550 nm)
		<±0.1 dB (1490 nm)	<±0.1 dB (1490/1625 nm)
Modulation Mode	CW,CHOP(270Hz, 1kHz, 2kHz)		
Optical Connector	FC,SC,ST		

① Modulation Mode: CW, ambient temperature: 23 ±2°C

② RMS (2σ, -20 dB)

③ In the case of the PC/FC 2m code connection

4.2 General Specifications

Model		AQ4280A	AQ4280B	AQ4280C
Power supply		Dry and Rechargeable Battery AA		
	Battery life ^①	Approximately 25 hours		
	Power saving	Power turns off automatically when there is no key input for approximately 10 minutes (this function can be disabled)		
	Battery check	Battery indicator		
Environmental conditions		Operating temperature range:-10~50°C, Operating humidity range:20~80% Storage temperature range:-20~+70°C(no condensation) Storage humidity range:5~95%(no condensation)		
Laser Class		CLASS1(IEC 60825-1)		
Dimensions and weight ^②		76(W)×153(H)×43(D) mm, Approximately 300 g		

① Continuation Measurement, using alkaline dry cells, at 23°C ±2°C ② A protector is removed.

Note _____

Specifications are at 23°C ±2°C unless otherwise noted. Optical connector: FC/PC

5 Operation

5.1 Installing the Batteries

Turn the screw on the rear panel with a coin or other flat object to remove the cover, then install the batteries.

Turning the screw locks/unlocks the cover as shown in the figure.

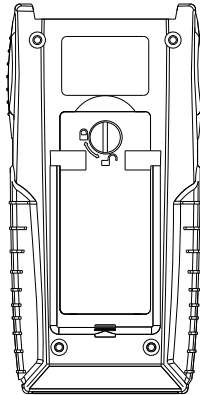

Unlock



Lock

Insert two AA batteries into the holder following the polarity markings. Always close the cover after installing batteries.

If the low battery indicator, you must change the batteries immediately. The instrument runs for approximately forty hours when using alkaline AA batteries (depending on operating conditions).

Note

Use the correct size and type of battery specified by the manufacturer of your device.

Keep battery contact surfaces and battery compartment contacts clean by rubbing them with a clean pencil eraser or a rough cloth each time you replace batteries.

Remove batteries from a device when it is not expected to be in use for several months.



Make sure that you insert batteries into your device properly, with the + (plus) and - (minus) terminals aligned correctly.

CAUTION:

Some equipment using more than three batteries may appear to work properly even if one battery is inserted incorrectly.

Store batteries in a dry place at normal room temperature.

Most batteries will provide dependable long life even after five years of storage in these conditions. Do not refrigerate batteries, this will not make them last longer.

Extreme temperatures reduce battery performance. Avoid putting battery-powered devices in very warm places.

5.2 Attaching a Connector Adapter

A specialized connector adapter is required for connecting an optical connector to the instrument. Choose an adapter that matches the optical connector you will use.

The screw mechanism that attaches the connector adapter to the instrument is of precision manufacture. Please handle all parts with care so as not to damage the screw threads.

Do not allow dirt to come into contact with the optical input section. Dirt or other foreign particles can influence measurement. Attach the protective cap to the optical input connector when not in use.

(1) Remove the optical input connector cap.

(2) Attach a connector adapter.

The connector adapter screws onto the connector; hold the adapter upright to align the threads properly, then turn to tighten.

Do not attach the connector adapter at an angle, and do not forcibly turn it any further after it has initially tightened. Doing so can damage the screw threads or sensor.

Note

It is recommended to clean the inside of the connector adapter using a dedicated swab or other cleaner and anhydrous alcohol.

Dedicated swabs for cleaning optical adapters are available from NTT, including the “CLETOP Stick-Type” (NTT-ME).

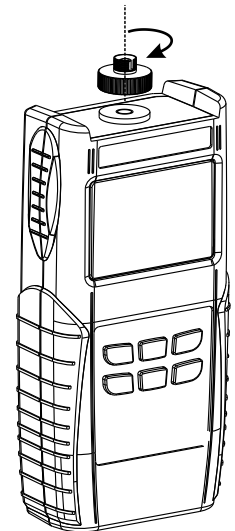

5.3 Attaching/Detaching a Protector

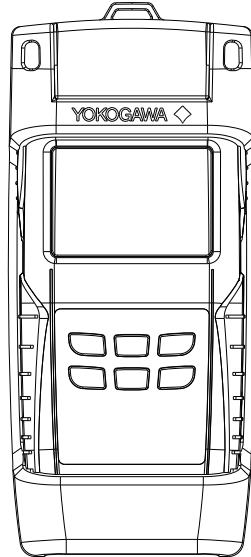

- (1) Please insert in the upper part to a protector.
- (2) Please insert the lower part in a protector.

Note _____
We recommend that you replace the protector when damaged.

5.4 Tilts the instrument.

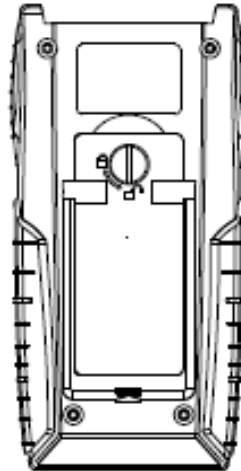







Note

-
- Do not use the stand as a handle to carry the AQ4280.
 - Use the stand only to tilt the AQ4280.
 - If you are tilting the AQ4280, check that the stand is fixed in place.
-

5.5 Keypad



No.	Key	Function
1		Switches Instrument on/off. Long Key press over 2 seconds while powering on to activate the instrument without Auto-off function.
2		Select CH1 , CH2(Only AQ4280C) CH1 and CH2 can emit light independently. ⚠ CH which is not used should stop light emitting.
3		Modulated Wavelength Shifting Key: Switch modulated wavelength and continuous wavelength.
4		AQ4280A:1310nm, 1550nm AQ4280B:1310nm, 1490nm, 1550nm AQ4280C:1310nm, 1550nm + 1490nm, 1625nm
5		SINGLE: Auto-wavelength recognition is off. TWIN: Auto-wavelength recognition is on.
6		Switches backlighting on/off.

5.6 LCD

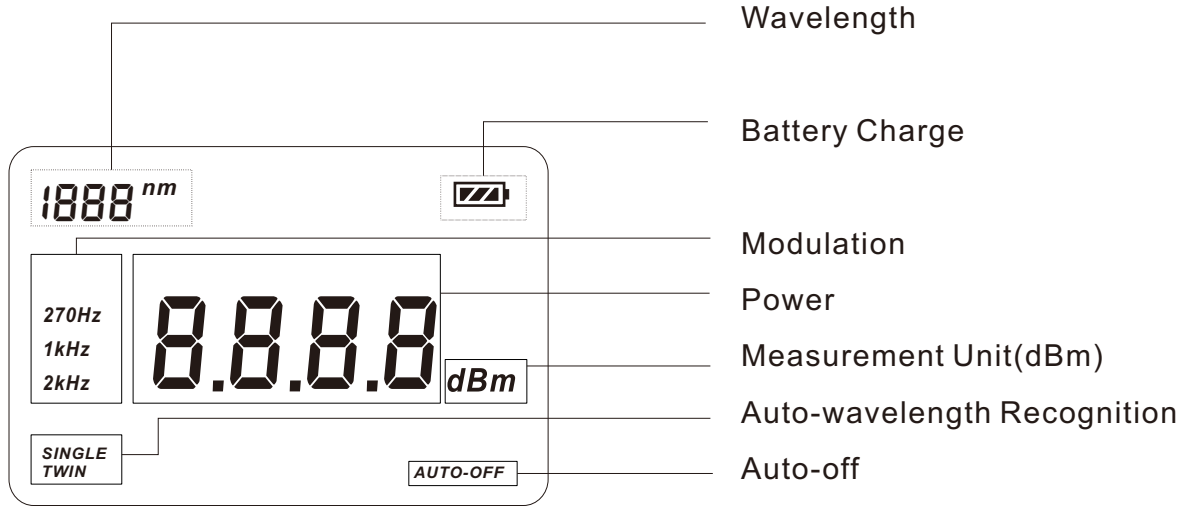

5.7 Turning the instrument on and off

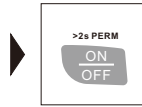

Press the “ON/OFF” key briefly.
The instrument powers-on.(See the figure)
Press the “ON/OFF” key briefly again.
The instrument powers-off.

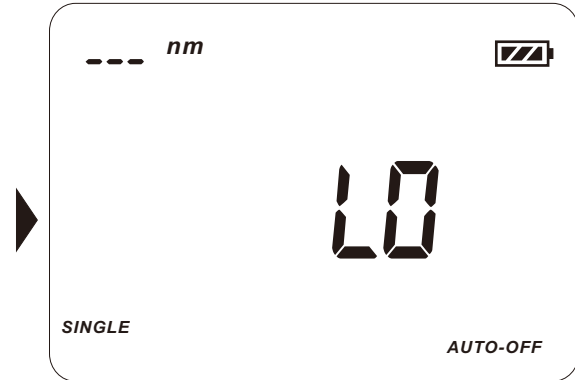

Note

Auto-off function

- 1 The instrument powers off automatically if no key press in 10 minutes.
- 2 Press the “ON/OFF” key for Long Key press over 2 seconds to power on the instrument with "Auto-off" function deactivated.

5.8 Switching the wavelength(AQ4280A)

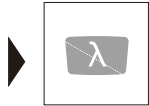

Press the “λ” Key to switch the wavelength between 1310nm, 1550nm and OFF.

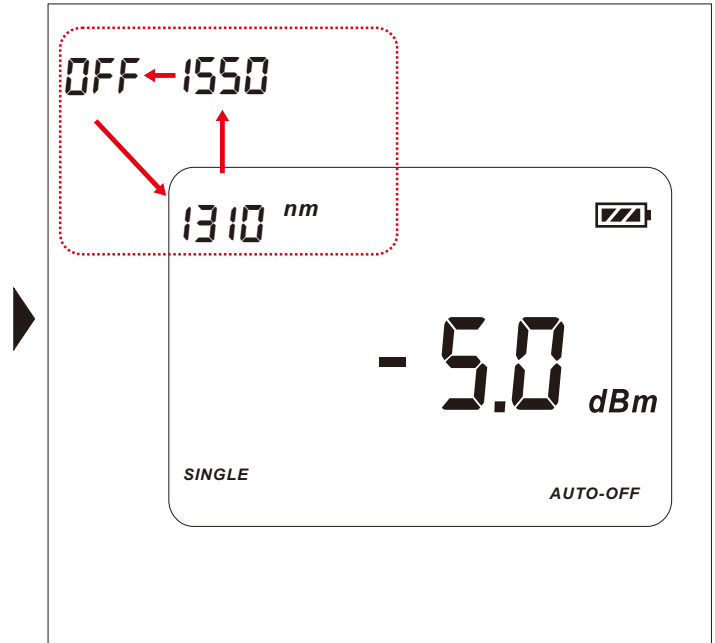

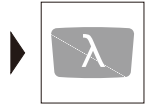

5.9 Switching the wavelength(AQ4280B)

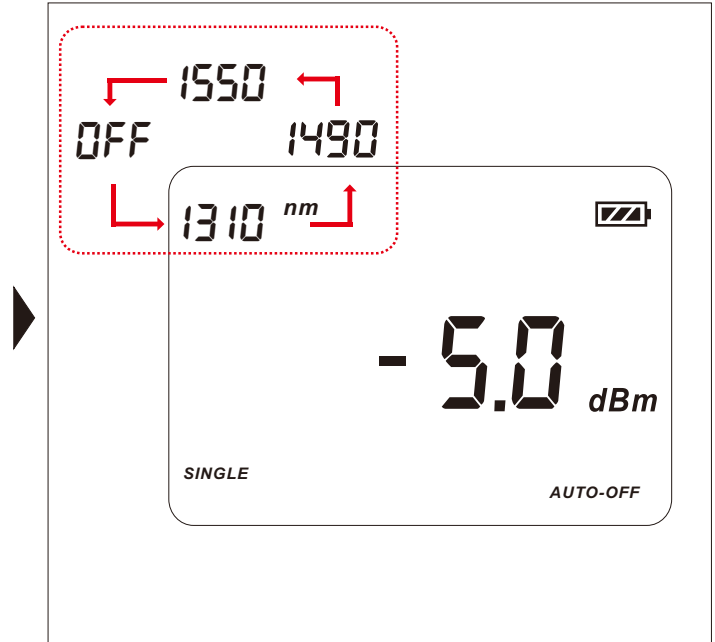

Press the “λ” Key to switch the wavelength between 1310nm, 1490nm, 1550nm and OFF.



5.10 Switching the wavelengths (AQ4280C)

Press the  to switch the wavelength between 1310nm, 1550nm and OFF.
Press the  to CH2
then Press  to switch the wavelength between 1490nm, 1625nm and OFF.

Note

CH1 and CH2 can emit light independently.
 CH which is not used should stop light emitting.

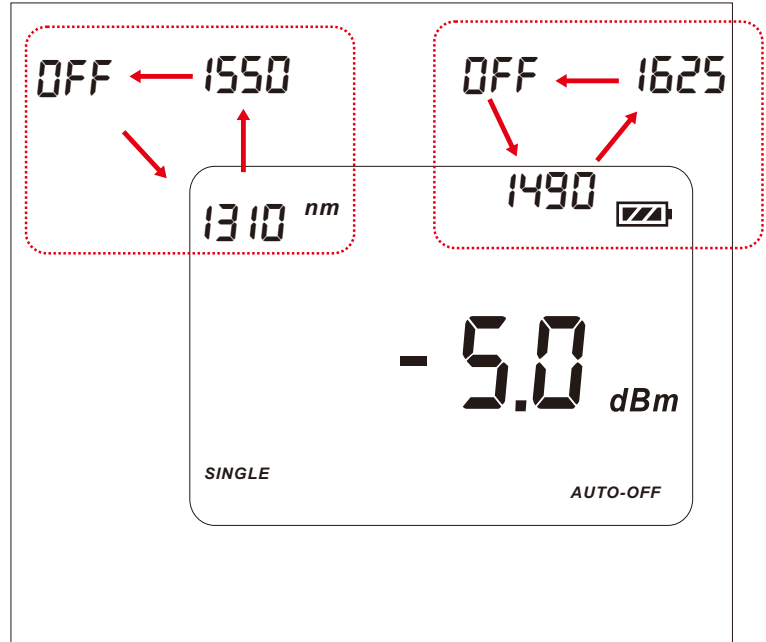

5.11 Frequency Output



The instrument defaults to CW when it switch on. When it is set to CW, there is no frequency on display. Press the "CW/Hz" Key to select the output among 270Hz, 1kHz and 2kHz.

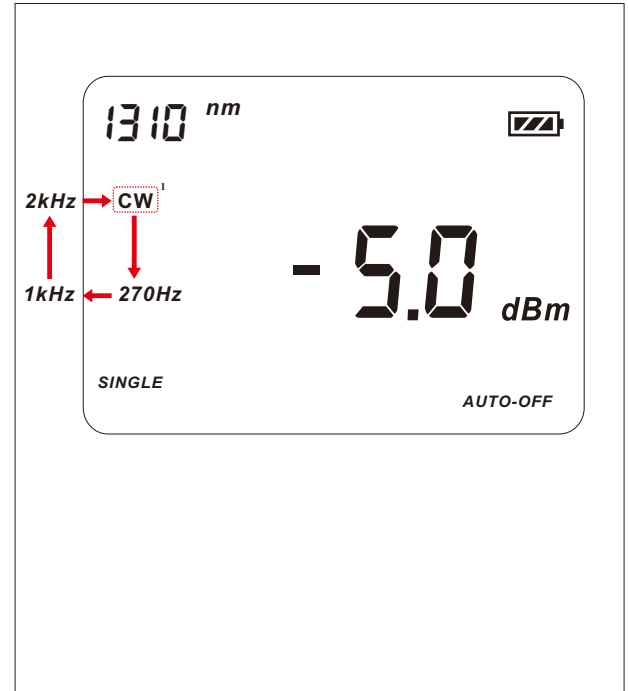

NOTE

1. "CW" is not displayed on the LCD

5.12 Auto-wavelength Recognition

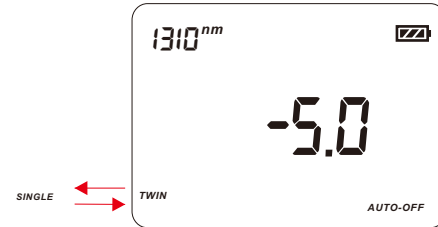
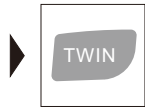

Press the "TWIN" Key to turn on and off the auto-wavelength recognition function.

Note

- 1) It is suggested to turn off the "TWIN" mode when you do not use it. The optical power output of laser source will be fluctuated.
 - 2) The function of "TWIN" and Modulation cannot work together. When the "TWIN" is on, modulation of laser source module is closed automatically.
 - 3) Wavelength will be shifted automatically according to the recognition when the "TWIN" of power meter module is on. In another word, the modulated signal of 270Hz, 1kHz and 2kHz cannot be recognized and received at the moment.
 - 4) Please refer to the manual of AQ2180 about the operation by the side of an optical power meter.
-

5.13 Connecting with Optical Power Meter

It can work with optical power meter to measure the loss of optical fiber accurately.



5.14 Switching backlighting of the LCD on and off

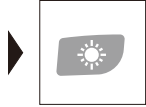

Press the backlighting key.
Backlighting switches on.
Press the backlighting key again.
Backlighting switches off.

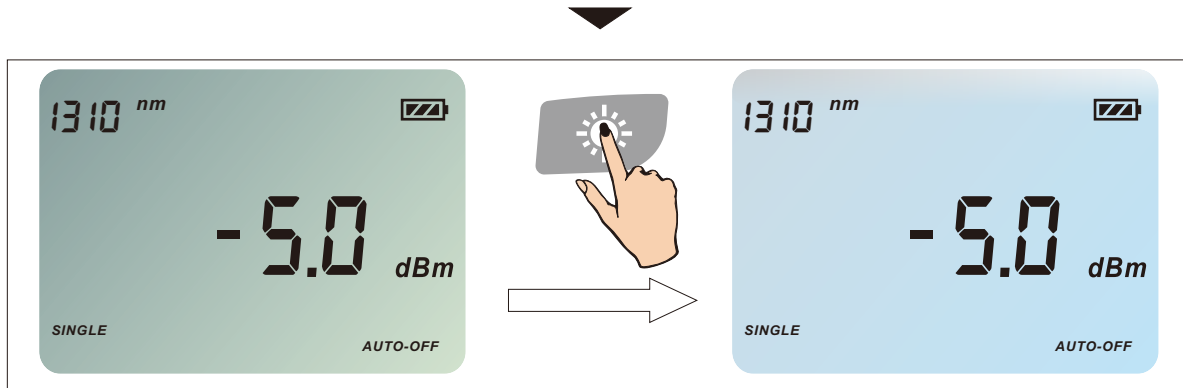

6 Trouble shooting

Malfunction Type	Possible Cause	Recommended solution	Remarks
Failure to turn on/off	Battery exhausted	Change battery	DIY Available
	Reverse-installed battery	Re-install battery	DIY Available
		(Still doesn't work)	
On&off disorder	Low battery	Change battery	DIY Available
Inaccurate measurement	Contaminated connector	Swab the dust by using an alcohol-impregnated thin cotton swab	DIY Available
	Connector unfitted	Re-install the connector	DIY Available
Improper indication	Humid environment	Try later while it is not too humid	DIY Available
	Magnetic field environment	Stay far away from magnetic field	DIY Available
	Metal dust environment	May cause damage on mainboard	Return to factory

Warm advice:This test instrument is available for single-mode optical fiber measurement only.

7 Recommended Replacement Parts

YOKOGAWA guarantees the AQ4280 for the period and under the conditions of the product warranty.

Under the conditions of the warranty, the following consumable parts and parts with limited service lives are excluded.

For part replacement, contact your nearest YOKOGAWA dealer.

Consumables

We recommend that you replace the following parts at the intervals listed below.

Part Name	Recommended Replacement Interval*	Notes
Battery cover (Screw lock)	Approx. 500 times	Purchase and replace
Universal and connector adapters	Approx. 1000 times	Purchase and replace

* The recommended replacement interval can vary greatly depending on the operating environment and the frequency of use. The above intervals are estimates.

8 Maintenance

- Please cover the protective dust cap once you finish using.
- It is a good idea to clean the connector and the instrument when they get dirty through use.
- Optical cleaning pads and anhydrous alcohol is recommended. And please be careful not to get the detergent inside the instrument.
- Periodic calibration is an effective means of keeping the instrument performing correctly for a long time and of detecting malfunctions at an early stage.
- We recommend that you have the AQ4280 calibrated once a year.
- Prohibitions against Actions that Cause Leaking, Ignition and Explosion.
- Do not leave it in a location that is exposed to direct sunlight.
- Do not throw the battery into fire or heat it.
- When you put the battery in the battery case, make sure that the battery is facing the right direction.
- If you will not use the battery for an extended period of time, remove it from the AQ4280 and store it in a dry place.
- please do not stare into beam

9 Outline drawing

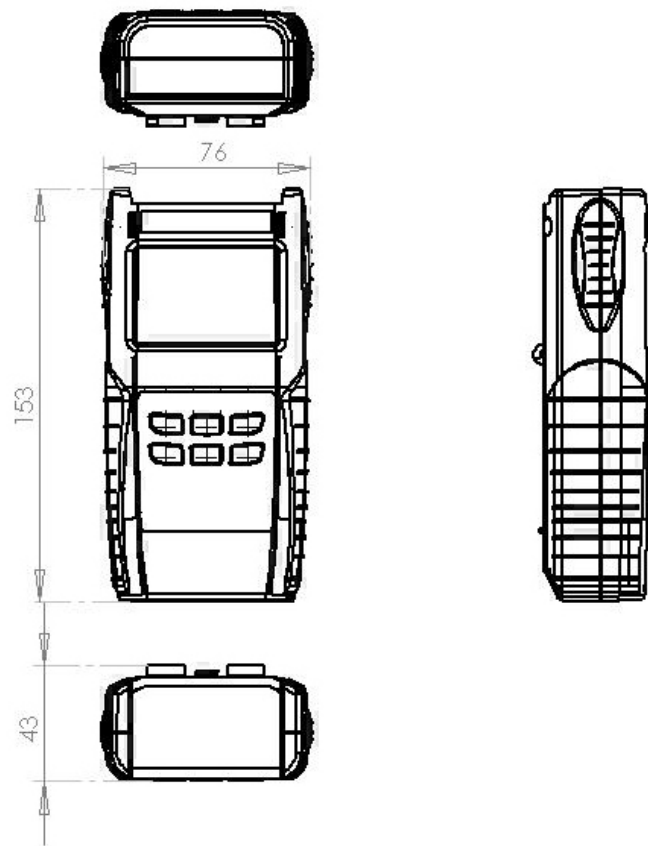

10 Connector adapter



SC



ST



FC