

# *robot coupe*®

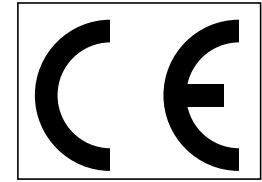

 **Robot Cook**®



## DECLARATION OF CONFORMITY

Robot-Coupe SNC:

Declares that the machines identified by their type above, comply with:

- The essential requirements of the following European directives and with the corresponding national regulations:

- Directive «Machinery» 2006/42/EC,
- Directive «Low voltage» 2006/95/EC,
- Directive «Electromagnetic compatibility» 2004/108/EC,
- Regulation (EC) n°1935/2004 «Materials and articles intended to come into contact with food»,
- Regulation (EU) n°10/2011 «Plastic materials and articles intended to come into contact with food»,
- Directive «Reduction of Hazardous Substances (RoHS) 2002/95/EC,
- Directive «WEEE» 2002/96/EC,

- The requirements of the European harmonized standards and with the standards specifying the hygiene and safety requirements:

- EN 12100 -1 & 2 - 2004: Safety of machinery – General principles for design,
- EN 60204-1 -2006: Safety of machinery – Electrical equipment of machines,
- EN 12852: Food Processors and Blenders,
- EN 1678-1998: Vegetable Cutting Machines,
- EN 454: Blender-Mixers,
- EN 12853: Hand-held Blenders and Whisks (stick blenders),
- EN 14655: Bread Slicers,
- EN 13208: Vegetable Preparation Machines,
- EN 13621: Salad Spinners,
- EN 60529-2000: Degrees of protection,
  - IP 55 for the electrical controls,
  - IP 34 for the machines.

Signed in Montceau en Bourgogne on 19 February 2013

Alain NODET  
Industrial Director

# SUMMARY

## ■ WARRANTY

## ■ IMPORTANT WARNING

## ■ YOU HAVE JUST ACQUIRED A Robot Cook®

## ■ SWITCHING ON THE MACHINE

- Advice on electrical connections
- Control panel
- Settings
- Operations
- Programming
- Programmed Recipes

## ■ ASSEMBLY

## ■ USES & EXAMPLES

## ■ HYGIENE

## ■ CLEANING

- Motor base
- Bowl
- Blade
- Scraper arm
- Lid seal

## ■ MAINTENANCE

- Blade
- Motor seal
- Scraper arm
- Lid seal
- Temperature control

## ■ TECHNICAL SPECIFICATIONS

- Weight
- Dimensions
- Working height
- Noise level
- Electrical data

## ■ SAFETY

## ■ OPERATION ERRORS

## ■ STANDARDS

## ■ TECHNICAL DATA

- Exploded views
- Electrical and wiring diagrams

# ROBOT-COUCPE S.N.C., LIMITED WARRANTY

Your new ROBOT-COUCPE appliance is warranted to the original buyer for a period of one year from the date of sale if you bought it from ROBOT-COUCPE S.N.C. If you bought your ROBOT-COUCPE product from a distributor your product is covered by your distributor's warranty (Please check with your distributor terms and conditions of the warranty).

The ROBOT-COUCPE S.N.C. limited warranty is against defects in material and/or workmanship.

## THE FOLLOWING ARE NOT COVERED BY THE ROBOT-COUCPE S.N.C. WARRANTY:

**1** - Damage caused by abuse, misuse, dropping, or other similar damage caused by or resulting from failure to follow assembly, operating, cleaning, user maintenance or storage instructions.

**2** - Labour to sharpen and/ or replacements for blades which have become blunt, chipped or worn after a normal or excessive period of use.

**3** - Materials or labour to replace or repair scratched, stained, chipped, pitted, dented or discoloured surfaces, blades, knives, attachments or accessories.

**4** - Any alteration, addition or repair that has not been carried out by the company or an approved service agency.

**5** - Transportation of the appliance to or from an approved service agency.

**6** - Labour charges to install or test new attachments or accessories (i.e., bowls, discs, blades, attachments) which have been arbitrarily replaced.

**7** - The cost of changing direction-of-rotation of three-phase electric motors (installer is responsible).

**8** - SHIPPING DAMAGES. Visible and latent defects are the responsibility of the freight carrier. The consignee must inform the carrier and consignor immediately, or upon discovery in the case of latent defects.

KEEP ALL ORIGINAL CONTAINERS AND PACKING MATERIALS FOR CARRIER INSPECTION.

Neither ROBOT-COUCPE S.N.C. nor its affiliated companies or any of its distributors, directors, agents, employees, or insurers will be liable for indirect damage, losses, or expenses linked to the appliance or the inability to use it.

The ROBOT-COUCPE S.N.C. warranty is given expressly and in lieu of all other warranties, expressed or implied, for merchantability and for fitness toward a particular purpose and constitutes the only warranty made by ROBOT-COUCPE S.N.C. France.



## WARNING

Keep these instructions in a safe place

# IMPORTANT WARNING

**WARNING:** In order to limit accidents such as electric shocks or personal injury or fire, and in order to limit material damage due to misuse of the appliance, please read these instructions carefully and follow them strictly. Reading the operating instructions will help you get to know your appliance and enable you to use the equipment correctly. Please read these instructions in their entirety and make sure that anyone else who may use the appliance also reads them beforehand.

## UNPACKING

- Carefully remove the equipment from the packaging and take out all the boxes or packets containing attachments or specific items.
- **WARNING** - some of the tools are very sharp e.g. blades, discs... etc.

## INSTALLATION

- We recommend you install your machine on a perfectly stable solid base.

## CONNECTION

- Always check that your mains supply corresponds to that indicated on the identification plate on the motor unit and that it can withstand the amperage.
- The machine must be earthed.

## HANDLING

- Always take care when handling the blades, as they are extremely sharp.

## ASSEMBLY PROCEDURES

- Follow the various assembly procedures carefully (see page 24) and make sure that all the attachments are correctly positioned

## USE

- Never try to override the locking and safety systems.
- Never insert an object into the container where the food is being processed.
- Never push the ingredients down with your hand.
- Do not overload the appliance.
- Never switch the appliance on when it is empty.

## CLEANING

- As a precaution, always unplug your appliance before cleaning it.
- Always clean the appliance and its attachments at the end of each cycle.
- Never immerse the motor base in water.
- For parts made from aluminum, use cleaning fluids intended for aluminum.

- For plastic parts, do not use detergents that are too alkaline (i.e. containing too much caustic soda or ammonia).
- Robot-Coupe can in no way be held responsible for the user's failure to follow the basic rules of cleaning and hygiene.

## MAINTENANCE

- Before opening the motor housing, it is absolutely vital to unplug the appliance.
- Check the seals and washers regularly and ensure that the safety devices are in good working order.
- It is particularly important to maintain and check the attachments since certain ingredients contain corrosive agents, e.g. citric acid.
- Never operate the appliance if the power cord or plug has been damaged or if the appliance fails to work properly or has been damaged in any way.
- Do not hesitate to contact your local Maintenance Service if something appears to be wrong.

## YOU HAVE JUST ACQUIRED A Robot Cook®

The Robot Cook® is a Cutter-Emulsifier-Heater perfectly adapted to the needs of professionals. It will be of great service to you which you will gradually discover as you use it.

The Advantages of Robot Cook®:

- Cutter function with a bottom bowl blade.
- Maximum liquid capacity of 2.5 litres.
- Precise temperature control of 1° or 2° C.
- Heating capacity up to 140° C.
- Programming function for 9 recipes.

Your Robot Cook® is equipped with the following accessories:

- 3.7 litre stainless steel bowl.
- Micro-serrated stainless steel blades.
- Lid and bowl scraper arm.

## SWITCHING ON THE MACHINE

### • ADVICE ON ELECTRICAL CONNECTIONS

Before plugging in, check that your power supply corresponds to that indicated on the machine's identification plate.



### Robot Cook®

This model is adapted to  
220-240V / 50-60Hz

The standardized plug must be calibrated to a minimum of 10 amps, and preferably 16 amps, if the appliance is used intensively.

### • CONTROL PANEL

#### SETTINGS

- Low and High Heat Function
- Speed Function
- Timer Function

#### PROGRAMMING

- Programme Function
- Step Button

- Rotary Dial (parameter setting)



### CONTROL PANEL

### - Power supply:



The general power supply is turned off by the black switch located at the back of the machine.

### • SETTINGS:

#### Switches:

Heat: Low heat .  
High heat .

Speed:

Timer:

Allow you to respectively choose temperature (°C), speed (rpm) and time (min).

The rotary dial is designed to regulate the chosen parameter (temperature, speed, time).

**For example:** after pressing the speed button, you regulate the speed using the rotary dial; the chosen speed is displayed on the speed line.

### - Settings:



The small arrow shows the parameter where the rotary dial is active.

#### 1. Low and high heat function:

##### 2 possibilities:

Adjustable temperature from 20°C - 140°C.

Low heat (small flame):

High heat (big flame):

You press the heat switch once to select low heat.

Then use the rotary dial to select the desired temperature.

Press twice on the heat switch to select high heat.

Then use the rotary dial to select the desired temperature (big flame displayed).

The desired temperature is displayed opposite the chosen arrow  72°C.

The temperature is the temperature measured in the bowl  47°C.

The power or heat temperature can be adjusted during operations.

If you do not wish to use the heat function, select the 2 dashes (— °C) on the heat line.

## 2. Speed function:

Speed variator from 80 to 3 500 rpm.





Once you have pressed the speed switch, the rotary dial will allow you to choose the desired speed.

Functions	Speeds
<b>Blend</b>	100 to 500 rpm or R-Mix -100 to -500 rpm
<b>Cut</b>	600 to 2 000 rpm
<b>Mix</b>	2 100 to 3 000 rpm
<b>Emulsify</b>	3 000 to 3 500 rpm

**The R-Mix function** (blend function: the blade turns in the opposite direction so as not to cut the food) can be accessed between -100 rpm and -500 rpm.

To obtain this, you need to turn the rotary dial to minus (-). If the motor is running, it will stop when reaching 0 rpm. You will need to restart the machine once the speed has been chosen.

**Intermittent Speed Function:** the blade rotates a few times every 3 seconds.

o obtain this, you need to turn the rotary dial to minus (-) until you reach the display    .

**Benefit:** This function maintains the temperature of the preparation-in-progress without changing the texture. It also prevents the motor from overheating on low speed if the bowl is very full.

## 3. Turbo/Pulse Function:



This function will enable you to reach a speed of 4500 rpm. To obtain this, you need to press on the Turbo/Pulse switch for the required run time.

## 4. Timer Function:

### 1 - Countdown Mode

By pressing the switch , you will set the run time of the appliance with the rotary dial.



At the end of the run time, a short bell will ring by default.

You can choose to activate the long bell option  to set a long ring alert by pressing twice on the Timer button .

### 2 - Timer Mode

A timer records the run time of the appliance by default.

### 3 - Differed Mode

By pressing 2 seconds on the Timer switch , the following display appears on your screen . You will set the desired run time of the appliance using the rotary dial once the chosen temperature is reached..

This mode will automatically deactivate after use and the indicator  will disappear.

**Benefit:** This mode enables you to activate the Timer only once the chosen cooking temperature is reached. You can thus program the cooking time independently of the start temperature and of the quantity of food.

## • OPERATIONS:

The Pulse, Run and Stop switches send instructions to the machine. They are present on all ROBOT-COUPE appliances.

They will carry out what appears on the display panel. (What has been « programmed »).



Black switch  
Turbo Pulse



Green switch  
Run



Red switch  
Stop

Pressing 2 seconds on the Red Stop switch will reset the settings to the initial configuration. (connect the appliance).



## • PROGRAMMING: +

### - Use a programme:

Go to the Programme function , choose the programme number using the rotary dial.

Turn on your appliance to the chosen programme.

### - Read a programme:

Once the programme has been chosen using the key , press on the step button  to view all the steps using the rotary dial.

You have the possibility of registering **9 programmes** on your Robot Cook®.

**3 recipes** are already pre-programmed, (see page 23):

**Programme 1:** Béchamel

**Programme 2:** Custard

**Programme 3:** Confectioner's custard

After each step of the programme, a bell will ring to indicate that the programme is moving onto the next step.

#### - Create or modify a programme:

By pressing once on the Programme Function  you then obtain the desired programme by using the rotary dial. It allows you to choose from the programmes 1 - 9.

For each step of the programme , you enter the following parameters:

**Heat power and Temperature**



**Speed**

**Timer**

To create or modify a step, choose the desired step by pressing the switch for a few seconds , which will allow you to enter your parameters.

After entering your parameters, confirm them by pressing the step switch  again so as register them.

#### - Delete a step:

Go to the step to be deleted, press the step switch  for a few seconds and then press the red stop switch  to delete the step.

The active step has now been replaced by the next step.

When all steps have been deleted, the programme is deactivated.







The word **End** is displayed at the last step. During operations, the programme will stop at this point.



• **PROGRAMMED RECIPES:**





**PROGRAMME 1: Béchamel Sauce**

*Ingredients for 1 litre: Butter 100 g - Flour 100 g - Milk 1 litre - Salt 5 g - Pepper 1 g - Nutmeg 1 g*

Ingredients	Weight	Action	 Heat setting	 Speed	 Time	Lid opening	Scraper Arm	Comment
<b>Step 1</b>								
Butter	100 g	Melt	 + 115° C	200 rpm	2 min.	Closed	No	
<b>Step 2</b>								
Flour	100 g	Add	 + 120° C	200 rpm	5 min.	Closed	Yes	
<b>Step 3</b>								
Milk Salt Poivre Nutmeg	1 Litre 5 g 1 g 1 g	Cook	 + 100° C	500 rpm	15 min.	Closed	Yes	Add in gently all at once





**PROGRAMME 2: Custard**

*Ingredients for 1 litre: Full Cream Milk 1 Litre - White Sugar 200 g - Egg Yolks 160 g - Vanilla 1 Pod*

Ingredients	Weight	Action	 Heat setting	 Speed	 Time	Lid opening	Scraper Arm	Comment
<b>Step 1</b>								
Full cream milk Vanilla	1 Litre 1 Pod	Infuse the vanilla seeds in the milk	 + 85° C	600 rpm	20 min.	Closed	No	
<b>Step 2</b>								
White sugar Egg yolks	200 g 160 g	Add into the hot milk	 + 85° C	600 rpm	3 to 4 min.	Open	Yes	The more yolks there are the creamier it is.
<b>Step 3</b>								
		Chill rapidly. Set aside at + 4° C						

**PROGRAMME 3: Confectioner's Custard**

*Ingredients for 1 litre: Full Cream Milk 1 Litre - White sugar 230 g - Egg Yolks 120 g - Vanilla 1 Pod - Flour 50 g - Cornflour 50 g - Chilled Butter 80 g*

Ingredients	Weight	Action	 Heat setting	 Speed	 Time	Lid opening	Scraper Arm	Comment
<b>Step 1</b>								
White sugar Egg yolks Flour Cornflour Vanilla	230 g 120 g 50 g 50 g 1 Pod	Blanch the ingredients		2000 rpm	30 sec.	Closed	Yes	
<b>Step 2</b>								
Milk	1 Litre	Add the milk to the mixture	 + 95° C	1000 rpm	12 min.	Open	Yes	
<b>Step 3</b>								
Butter	80 g	Add the butter in small pieces	 + 95° C	1000 rpm	30 sec.	Open	Yes	

## ASSEMBLY



1) With the motor unit facing you, make sure that the bowl handle is slightly to the left.

2) Turn the bowl handle to the right until the motor lugs are securely positioned in their sockets. The handle should now be straight in front of you.



3) Position the blade on the motor shaft and lower it right to the bottom of the bowl. Make sure that it is correctly positioned, by rotating it in the bowl.



### IMPORTANT

Never put your ingredients in the bowl before the blade is in place.

4) Make sure that the scraper arm is correctly assembled with the lid and the handle locked.



5) Place the lid on the bowl and rotate it to the right until it locks.



With everything in place, your appliance is ready to run.

## USES & EXAMPLES

- For liquids, never fill the bowl more than  $\frac{2}{3}$  or less than 2 cm below the upper part of the blade.
- Your Robot Cook® is designed to carry out the following functions:

H O T	Emulsify	C O L D
	Grind	
	Mix	
	Chop	
	Blend	
	Knead	

## HYGIENE

### IMPORTANT: NEVER USE PURE BLEACH

- Correctly dilute the detergent / disinfectant following the manufacturer instructions which are generally printed on the packaging.
- Scrub well if required.
- Let the detergent act.
- Rinse carefully.
- Dry thoroughly with a disposable cloth.

## CLEANING



### WARNING

As a precaution, always unplug your appliance before cleaning it (hazard of electrocution) and handle the blades with care (hazard of injury).

#### • MOTOR BASE

Never immerse the motor base in water. Clean using a damp cloth or sponge.

#### • BOWL

- Remove the lid
- Release the bowl by rotating it on the motor unit to unlock it.
- Gently lift it up to disengage it, leaving the blade in the bowl in order to prevent any spillage if the preparation is liquid.

If the food has a solid consistency, remove the blade and empty the bowl of its contents.

You can also remove any mixture stuck to the blade by running it in the emptied bowl of your Robot Cook®.

Your bowl can be washed in the dish-washer.

## • BLADE

It is important to thoroughly clean your blade after each use.

A cleaning tool is available to remove any mixture remaining on the blade.

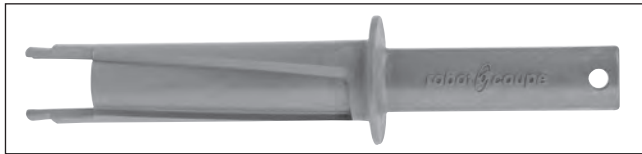

Proceed as follows:

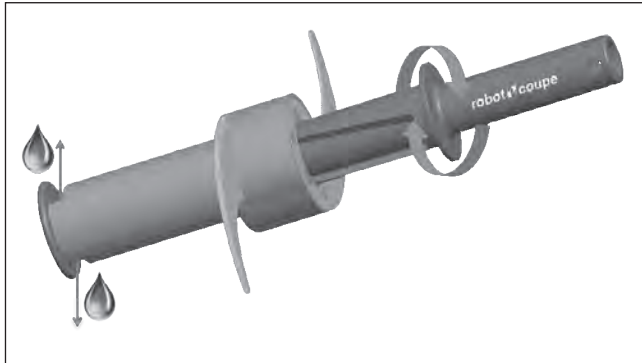

After cleaning the blades, always dry well to prevent rusting.

## • SCRAPER ARM

To clean the scraper arm, dismantle it as follows:

- 1- Hold the scraper arm in one hand and the handle in the other hand.
- 2- Press the two parts one on the other, then turn the handle 45° anti-clockwise
- 3- It is now possible to remove the two parts (scraper arm and handle) from the lid and clean them.

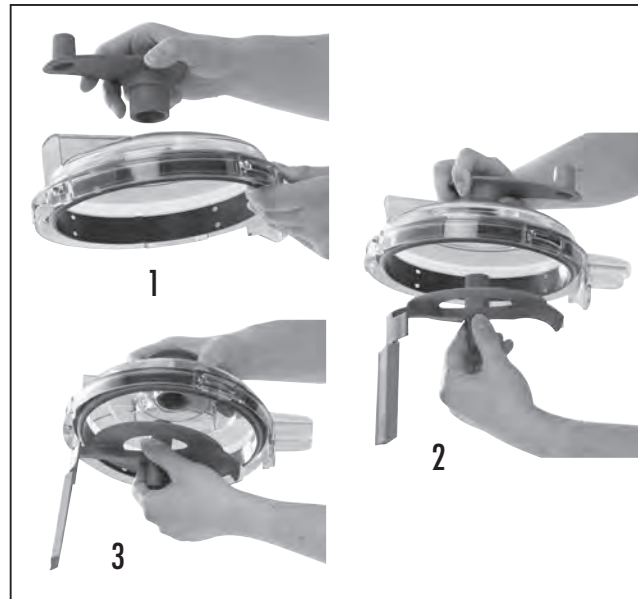

## • LID SEAL

After using your Robot Cook, clean the lid seal as follows:



## MAINTENANCE

### • BLADE

The quality of the cut depends mainly on the sharpness of your blades and the degree of wear and tear. The blade is subject to wear and tear and should be replaced regularly to ensure consistent quality in the final product.

### • MOTOR SEAL

The seal ring on the motor shaft should be lubricated regularly using a food safe lubricant.

In order to keep the motor completely watertight, it is advisable to check the seal ring regularly for wear and tear and replace it at least once per year.

The seal ring can be easily replaced without having to dismantle the motor, so we strongly advise you to always check that it is in good condition.

### • SCRAPER ARM



The scraper arm is equipped with rubber parts which are subject to wear and tear. They should be replaced regularly to ensure optimum efficiency of the scraper arm.

The lid scraper is easy to dismantle and also to assemble.

The scraper bowl needs to be replaced by a professional as it is attached to the scraper arm.

• **LID SEAL**

Replace the lid seal if there are liquid leaks.

• **TEMPERATURE CONTROL**

Your appliance has 8 temperature controls, 4 on the motor base and 4 under the bowl.



The temperature controls can become dirty from the cleaning products used (especially under the bowl). This causes a few degrees variation in the temperature display.

Simply brushing the 4 contacts with the abrasive side of a sponge will correct this malfunctioning.

**TECHNICAL SPECIFICATIONS**

• **WEIGHT**

	Net	Gross
Robot Cook®	13,5 kg	15 kg

• **DIMENSIONS (in mm)**

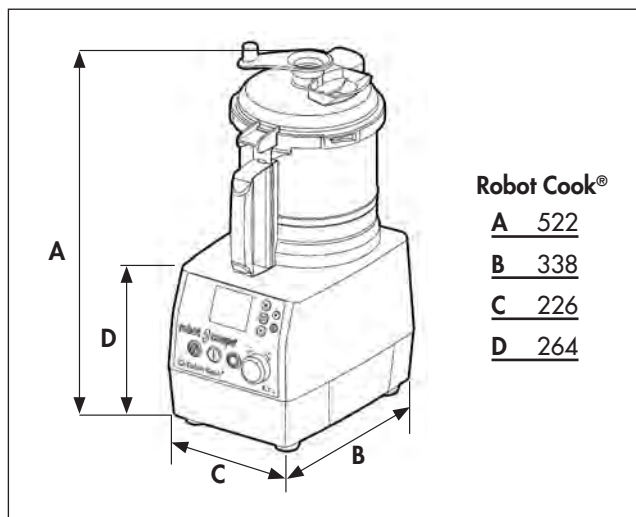

• **WORKING HEIGHT**

We recommend that you position your Robot Cook® on a stable work top so that the upper edge of the bowl is at a height of between 1.20 and 1.30 m.

• **NOISE LEVEL**

When the Robot Cook® is operating on no-load, the sound level is less than 70dB (A).

• **ELECTRICAL DATA**

Motor	Speed (rpm)	Power (Watts)	Intensity (Amp.)
230V / 50-60 Hz	100 to 4,500	Maximum heat capacity: 1200 W Motor capacity: 1000 W Nominal machine capacity: 1800 W	8

**SAFETY**

**! WARNING**  
**The blades and discs are extremely sharp. Handle with care.**

These models are fitted with the following safety systems:

- **Mechano-magnetic** safety and motor brake.
  - As soon as you open the lid, the motor stops.
  - In order to avoid any splash when processing liquids, we recommend you stop the machine before opening the lid. **Caution:** The risk of burns is greater when processing hot liquids.
  - **Thermal cut-out** which automatically stops the motor if the machine is left on for too long or is overloaded. (Er02 error).
- If this happens, allow the machine to cool completely before restarting.
- Safety of the heat system:
    - a - specific detection of bowl presence
    - b - thermal cut-out inside the bowl (automatic stopping of the machine above a safe temperature).
    - c - when the temperature of the preparation reaches 85° C, for security reasons the speed is automatically limited to 600 rpm as the bowl is too hot.

In this case, it's possible to mix your preparation by using the Turbo/Pulse switch.



## REMEMBER

Never try to override the locking and safety systems.

Never introduce any object into the container where the food is being processed.

Never push the ingredients down with your hand.

Do not overload the appliance

## OPERATION ERRORS

Your Robot Cook® has a function which enables it to display the different causes of possible errors.

Depending on the message displayed, you will be aware of the nature of the error, and of possible solutions.

See the table opposite.

### • LIST OF ERRORS DISPLAYED

Display	Description	Action to take
Er01	Thermal variator cut-out	Allow the machine to cool down; press on the Stop switch to reset
Er02	Thermal motor cut-out	Allow the machine to cool down; run faster or use the intermittent function 0101
Er03	Power supply	Check the machine's power supply

Display	Description	Action to take
Er04	Inconsistent configuration	Dismantle and assemble all accessories; press on the Stop Switch to reset
Er05	Internal bus over-voltage	Check the machine's power supply
Er06	Thermal cut-out control board	Allow the appliance to cool down; press on the Stop Switch to reset
Er07	Checking bowl safety	Remove the bowl then replace it to reset the safety features.
Other message		Contact your After-Sales Service

## STANDARDS

Consult the declaration of compliance on page 2.

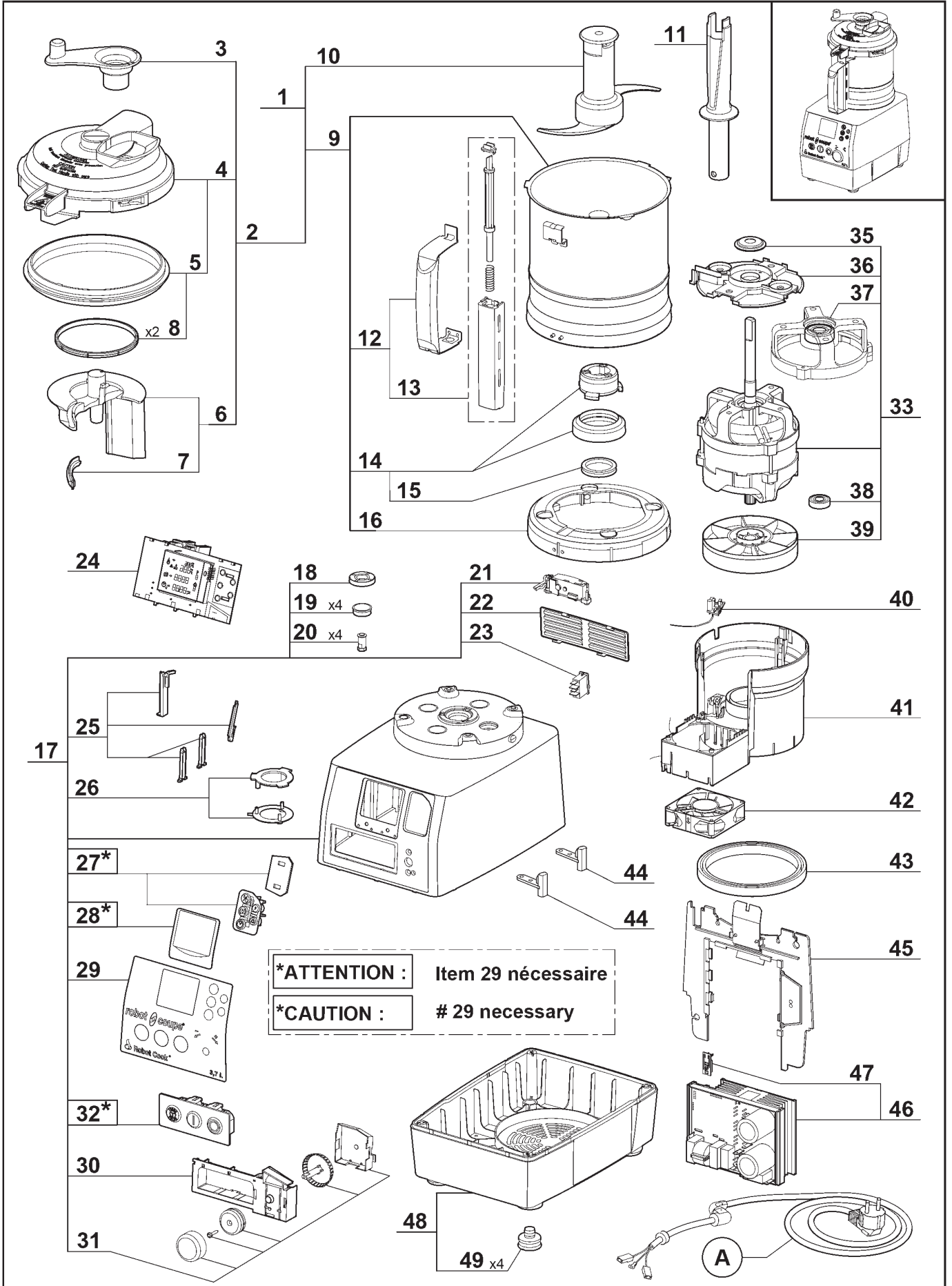

<i>Index</i>	<i>Pièce / Part</i>	<i>Désignation</i>	<i>Description</i>
1	39 854	ACCESSOIRE CUVE CHAUFFANTE 230V	HEATING BOWL ATTACHMENT 230V
2	39 641	ENSEMBLE COUVERCLE	LID ASSEMBLY
3	39 687	POIGNEE BRAS RACLEUR	SCRAPER ARM HANDLE
4	39 688	COUVERCLE	LID
5	39 638	ENSEMBLE JOINT COUVERCLE	LID SEAL ASSEMBLY
6	39 639	ENSEMBLE BRAS RACLEUR	SCRAPER ARM ASSEMBLY
7	39 689	RACLEUR DE COUVERCLE	LID SCRAPER
8	39 690	JOINT COUVERCLE (x2)	LID SEAL (x2)
9	39 637	ENSEMBLE CUVE ROBOT COOK 230V	BOWL ASSEMBLY 230V
10	39 691	COUTEAU ROBOT COOK	BLADE ASSEMBLY
11	39 858	OUTIL DE NETTOYAGE COUTEAU	BLADE CLEANING TOOL
12	39 634	ENSEMBLE POIGNEE CUVE	BOWL HANDLE ASSEMBLY
13	39 636	ENSEMBLE TIGE SECURITE	SAFETY ROD ASSEMBLY
14	39 633	ENSEMBLE JOINT CENTRAL CUVE	SEAL ASSEMBLY
15	500 901S	JOINT V RING SOUS CUVE	SEAL V-RING
16	39 599	ENSEMBLE RONDELLE D'ACCROCHAGE CUVE	BOWL LOCKING WASHER ASSEMBLY
17	39 622	ENSEMBLE SUPPORT MOTEUR	MOTOR SUPPORT ASSEMBLY
18	501 010S	BAGUE ETANCHEITE	SHAFT SEAL
19	39 074	CAPSULE CACHE VIS (x4)	BOLT COVER (x4)
20	39 642	ENSEMBLE PLOTS DE CONTACT (x4)	CONTACT STUDS ASSEMBLY (x4)
21	39 648	ENSEMBLE BLOC DE SECURITE	SAFETY BLOCK ASSEMBLY
22	104 122S	GRILLE VENTILATION	VENTILATION GRID
23	39 855	INTERRUPTEUR GENERAL	GENERAL SWITCH
24	39 692	CARTE DE COMMANDE	CONTROL BOARD
25	39 621	ENSEMBLE CLAVETTES	KEYS ASSEMBLY
26	39 686	ENSEMBLE ACCROCHAGE CENTRAL	CENTRAL LOCKING ASSEMBLY
27*	39 620	ENSEMBLE BOUTONS PROGRAMMATION	PROGRAMMING KNOBS ASSEMBLY
28*	39 853	VITRE AFFICHEUR	DISPLAY WINDOW
29	39 619	PLAQUE FRONTALE	FRONT PLATE
30	39 617	PLASTRON	CONTROL PANEL SUPPORT
31	39 618	ENSEMBLE BOUTON TOURNANT	ROTATING KNOB SET
32*	39 859	ENSEMBLE TABLEAU DE COMMANDE	CONTROL PANEL ASSEMBLY
33	39 631	ENSEMBLE MOTEUR	MOTOR ASSEMBLY
35	110 013S	DEFLECTEUR D'AXE	SHAFT DEFLECTOR
36	39 694	DEFLECTEUR MOTEUR	MOTOR DEFLECTOR
37	106 268S	ROULEMENT MOTEUR SUPERIEUR AVEC FLASQUE	UPPER BALL-BEARING WITH BRACKET
38	501 270S	ROULEMENT MOTEUR INFERIEUR	LOWER BALL-BEARING
39	39 695	VENTILATEUR MOTEUR	MOTOR FAN
40	102 920S	CAPTEUR DE VITESSE	SPEED SENSOR
41	39 696	CONDUIT DE VENTILATION	VENTILATION BAFFLE
42	39 697	VENTILATEUR AUXILIAIRE	AUXILIARY FAN
43	101 099S	TAMPON AMORTISSEUR	ABSORBER
44	102 390S	INTERRUPTEUR SECURITE	SAFETY SWITCH
45	39 623	ENSEMBLE SUPPORT VARIATEUR	VARIATOR SUPPORT ASSEMBLY
46	39 630	ENSEMBLE VARIATEUR	VARIATOR ASSEMBLY
47	39 698	ADAPTATEUR VARIATEUR / PTO	VARIATOR / PTO ADAPTER
48	39 614	ENSEMBLE SOCLE	BASE ASSEMBLY
49	39 928	PIED (x4)	FOOT (x4)

<i>Index</i>	<i>Désignation</i>	<i>Description</i>
<b>A</b>	CABLE D'ALIMENTATION + SELF	POWER CORD + INDUCTOR

Machine	Voltage	A
43 000	220-240/50-60/1	39 699
43 001 UK		504 275
43 002 Aust		504 278
43 006 CH		504 292
43 007 DK		504 276

# Robot Cook® 230V/50Hz 1~

ELECTRIC DIAGRAM

SCHEMA ELECTRIQUE

ELEKTRISCHES SCHALTBILD

	Français	English	Deutsch
<b>A</b>	Adaptateur VAR/PTO	Adapter VAR/PTO	Adapter VAR/PTO
<b>BT</b>	Bouton tournant	Rotating knob	Dreherschalter
<b>CV</b>	Capteur Vitesse Réf. 102920	Speed sensor Ref. 102920	Geschwindigkeit Sensor Ref. 102920
<b>CT1/2</b>	Capteur de Température	Temperature sensor	Sensor von Temperatur
<b>I</b>	Interrupteur général	General switch	Hauptschalter
<b>ISCH</b>	Inter Sécurité Cuve CHauffante	Heating bowl safety switch	Inter Heizung Schiffssicherheit
<b>ISCU</b>	Interrupteur de Sécurité CUTter	Cutter lid safety switch	Sicherheitsschalter Messerdeckel
<b>MO</b>	Moteur	Motor	Motor
<b>PCB</b>	Carte de commande Ref. 172064	Control Board Ref. 172064	Komand Kart numer Ref. 172064
<b>PTO</b>	Protecteur thermique intégré au moteur	Thermal protector integrated in the motor	Thermoschutz im Motor integriert
<b>Rch</b>	Résistance de chauffe	Heating Resistor	Heizwiderstand
<b>SAR</b>	Bouton poussoir ARRET	OFF switch	Stopschalter
<b>SMA</b>	Bouton poussoir MARCHE	ON switch	Betriebsschalter
<b>SPU</b>	Bouton poussoir IMPULSION	PULSE switch	Impulsschalter
<b>VAR</b>	Variateur Réf. 112401	Inverter Ref. 112401	Variator Ref. 112401
<b>VA</b>	Ventilateur Auxiliaire	Auxiliary Fan	Hilfsventilator
<b>BS</b>	Bloc de Sécurité	Safety block	Sicherheitsblock

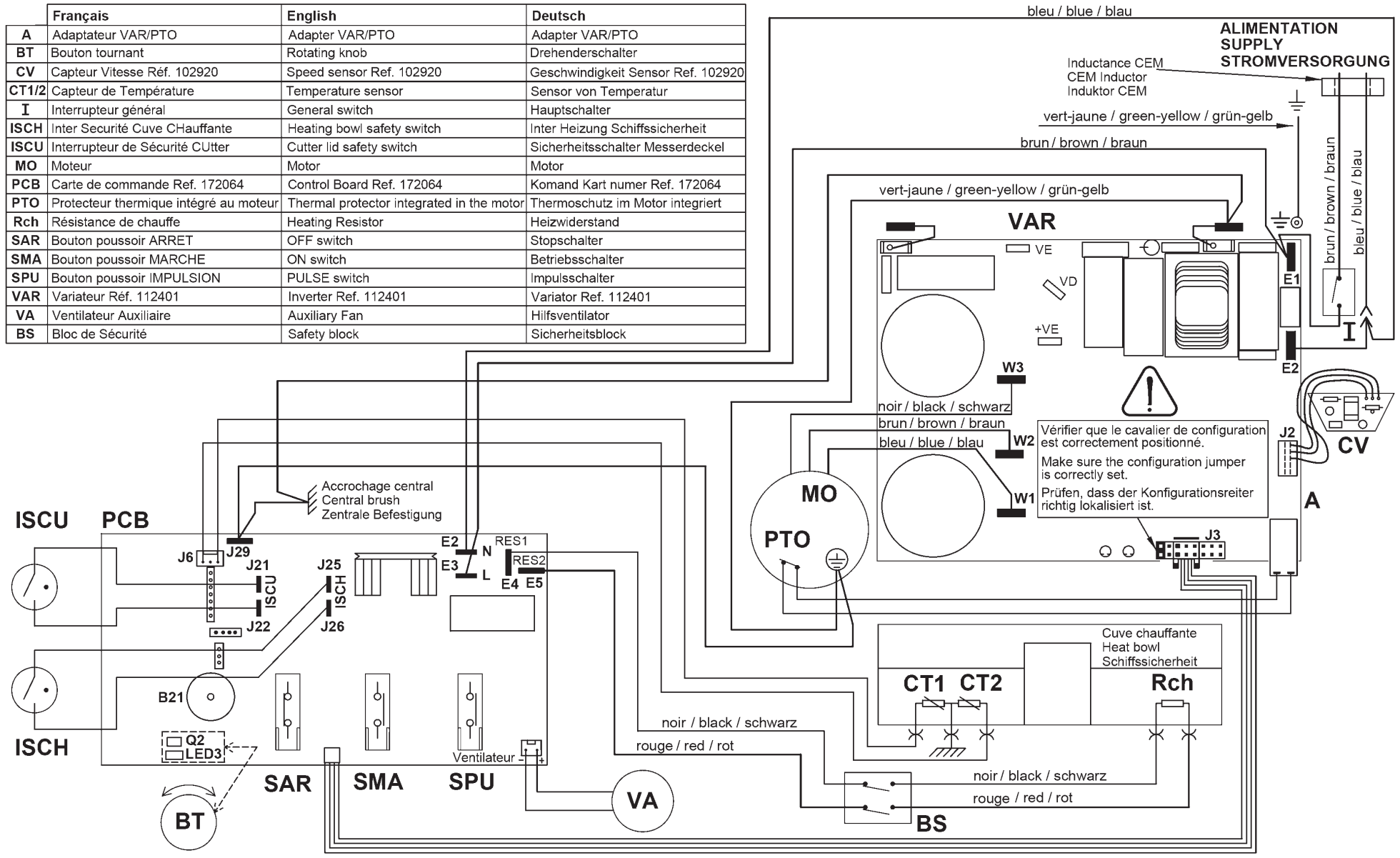





---

**robot coupe**®

**Head Office, French,  
Export and Marketing Department:**  
48, rue des Vignerons  
94305 Vincennes Cedex- France  
Tel.: 01 43 98 88 15 - Fax: 01 43 74 36 26  
Email: international@robot-coupe.com

**Robot Coupe Australia Pty Ltd:**  
Unit 3/43 Herbert St  
Artarmon NSW 2064 Australia  
T (02) 9478 0300  
F (02) 9460 7972  
Email: orders@robotcoupe.com.au

**Robot-Coupe U.K. LTD:**  
Fleming Way, Isleworth,  
Middlesex TW7 6EU  
Tel.: 020 8232 1800  
Fax: 020 8568 4966  
Email: sales@robotcoupe.co.uk

**www.robot-coupe.com**