

Storing your BAGPAX®

➔ To store your BAGPAX® properly, it is recommendable to fold it up after cleaning and drying. Keep your BAGPAX® with the accessory vacuum cups in the carrying case.

i The fastening cords can remain attached to the BAGPAX®.

DANGER Using Tools



Tools may damage your car as well as your BAGPAX®.

- ➔ Remove the vacuum cups manually from the windows of your car.
- ➔ Do not use tools when installing or uninstalling the BAGPAX® in your car.

When using your BAGPAX® often...

1. Place the top element as well as the bottom element onto each other.
2. Fold up the BAGPAX® to half its size and roll it up starting at the folded edge.
3. Put your BAGPAX® into the carrying case.

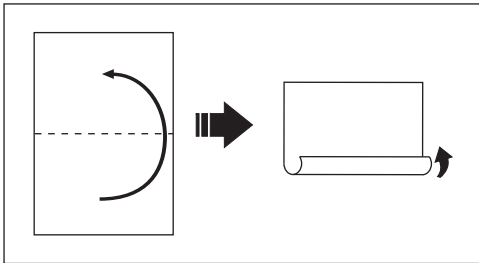

When storing your BAGPAX®...

1. Place the top element as well as the bottom element onto each other.
2. Fold up the BAGPAX® five times lengthwise and then to a length of a little less than 40 cm.
3. Put your BAGPAX® in the carrying case and fold up the carrying case to half its size.

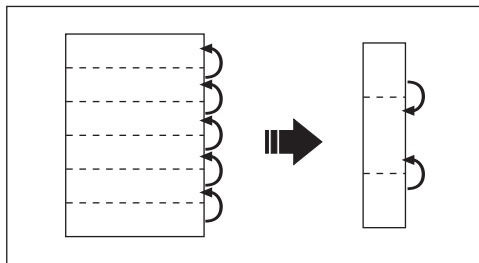

© 2007 BAGPAX Cargo Systems e.K.
User's Manual KW49/2007
All rights reserved.

Any reprinting, copying or distributing of this manual or parts of it is illegal unless BAGPAX Cargo Systems e.K. has issued written approval. The manufacturer grants a two year warranty according to the accompanying warranty card.

Improper use voids the warranty and leads to the exclusion of all liability claims. Please follow local regulations when discarding the BAGPAX®.

BAGPAX®

C a r g o S y s t e m s

User's Manual

Dear customer,
congratulations to your purchase of a BAGPAX® Compact Class.

The first time you use your BAGPAX®, we recommend that you read this manual completely to ensure your safety and to ensure that you get the most out of your BAGPAX®. Also, we would like to recommend keeping this manual in the carrying case that comes with your BAGPAX®.

Enjoy your BAGPAX®!

Product Features

BAGPAX® protects your trunk from dirt and it screens the contents in your trunk from the view of passers-by. The BAGPAX® Compact Class is particularly adequate for all compact class cars as well as SUVs. The flexible fastening cords that hold the BAGPAX® in place allow BAGPAX® to adapt to any trunk. BAGPAX® can be used with the back seats flipped over or upright.

Product Benefits

- Closed all around
- Quickly installed
- No changes to your car
- Small Carrying Case
- Easy to Clean

Contents of the Package

- 1 x BAGPAX®
- 1 x Manual and Warranty Card
- 5 x Vacuum Cup
- 2 x Fastening Cord
- 1 x Carrying Case

Please check if all items are included in your package!

Measurements

- Bottom Element [cm]: 130 x 95
- Top Element [cm]: 130 x 85
- Height [cm]: 70
- Capacity [l]: 818
- Carrying Case [cm]: 26 x 39 x 7

Material Properties

- Polypropylene material: water-resistant, laminated
- Seams: water-resistant and reinforced



BAGPAX®
Compact Class

EN

Safety Instructions

DANGER Danger of Suffocation



People or animals may suffocate in the BAGPAX®.

- ➔ Never leave children unattended around your BAGPAX®.
- ➔ Promptly put away the carrying case for your BAGPAX® after use.

DANGER Inflammable and Hot Materials



Hot materials may damage your BAGPAX®. Inflammable materials may be ignited by direct exposure to sunlight.



- ➔ Do not transport easily inflammable materials.
- ➔ Do not transport hot or glowing materials.

WARNING Obstructed view through the rear window



The view through the rear window may be obstructed.

- ➔ Use the BAGPAX® in cars that are equipped with two exterior mirrors.

Installing your BAGPAX®

1. Unpacking your BAGPAX®

- ➔ Open the carrying case and take out the BAGPAX®, the fastening cords and the vacuum cups.

i Make sure that the carrying case is out of reach of children when stored.

2. Mounting the Fastening Cords

- ➔ Pull the fastening cords through the loops and tie them to the respective loops of your BAGPAX®.

i It is not necessary to shorten the fastening cords.

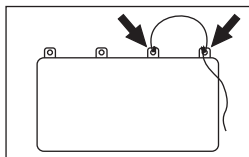

If the backseats are upright, the two rear loops should be used.

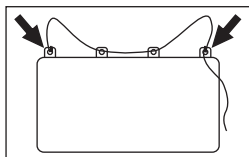

If the backseats are flipped over, the outer loops to the right and the left should be used.

3. Mounting the Vacuum Cups

- ➔ Clean the surface of your car windows and press the vacuum cups onto the windows.

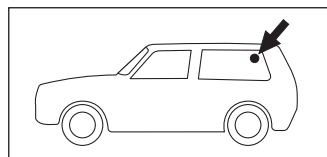

If the backseats are in an upright position, place the vacuum cups as indicated in the illustration above.

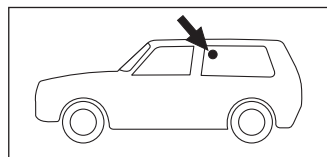

If the backseats are flipped over, place the vacuum cups as indicated in the illustration above.

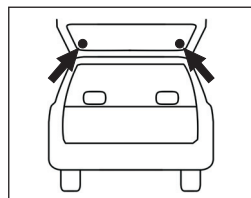

Place the rear vacuum cups on the inside of the deck lid.

i In individual cases you will have to deviate from these recommendations.

4. Mounting the BAGPAX® in your trunk

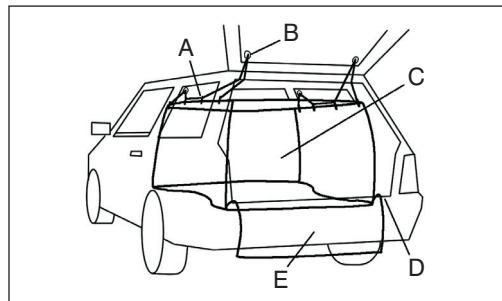

A fastening cord; **B** vacuum cup; **C** hatch; **D** rim of the trunk; **E** protective rear end.

If it turns out that the BAGPAX® cannot be installed in your car, please contact the manufacturer.

Using your BAGPAX®

Loading Cargo

- ➔ Load all cargo after installing the BAGPAX® in your car.

DANGER Unsecured Cargo



Unsecured Cargo in your BAGPAX® may be hazardous.

- ➔ Secure cargo to prevent it from shifting on the slippery surface of the BAGPAX®. It is also recommendable to secure cargo that has pointed or sharp edges.
- ➔ Place heavy cargo on the bottom of your BAGPAX® and make sure that heavy cargo is in a position that is no higher than 40 cm.

WARNING Overtaxing your BAGPAX®



Your BAGPAX® may be damaged if it is carried or moved while cargo is inside.

- ➔ Load all cargo after installing the BAGPAX® in your car.

Closing your BAGPAX®

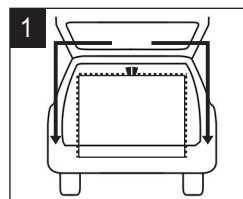

- ➔ Open the zipper up to the rim of the trunk of your car.

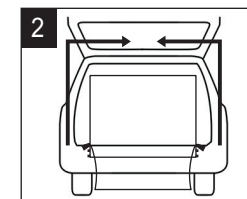

- ➔ Close the zippers after loading cargo into your BAGPAX®.

Cleaning your BAGPAX®

- ➔ Clean your BAGPAX® after use. You may use mild detergents like dishwashing liquid and a piece of cloth to clean your BAGPAX®.
- i** Do not use aggressive detergents.