

12'-18' Diameter Bins Cor-Lok and Cut-Lok Flooring and Grandstand Layout

Installation Manual

PNEG-214

Date: 03-07-08

GSI GROUP



PNEG-214

Contents

- Chapter 1 Safety 5**
 - Safety Guidelines 5
 - Safety Instructions 6
- Chapter 2 Recommended Method for Full Floor Installation 8**
 - Fan Placement Diagram 8
 - Grain Systems Recommended Method for Full Floor Installation 9
- Chapter 3 Grandstand Identification 11**
 - 20 Gauge Grandstand Identification 11
- Chapter 4 Flashing Installation 12**
 - Grain Systems Formed Flashing Installation 12
- Chapter 5 Grandstand Layout at Center Well for Recirculating System 13**
- Chapter 6 12' Cut-Lok/Cor-Lok Plank Order and Grandstand Layouts 14**
 - 12' Cor-Lok/Cut-Lok and 20 Gauge Grandstand Layout
 - 2.66" Corrugated Bins 3-7 Rings and 4.00" Corrugated Bins 3-5 Rings 15
- Chapter 7 15' Cor-Lok/Cut-Lok Plank Order and Grandstand Layouts 16**
 - 15' Cut-Lok/Cor-Lok Plank Order 16
 - 15' Cor-Lok/Cut-Lok and 20 Gauge Grandstand Layout
 - 2.66" Corrugated Bins 4 and 5 Rings and 4.00" Corrugated Bins 3 Rings 17
 - 15' Cor-Lok/Cut-Lok and 20 Gauge Grandstand Layout
 - 2.66" Corrugated Bins 6 Rings and 4.00" Corrugated Bins 4 Rings 18
 - 15' Cor-Lok/Cut-Lok and 20 Gauge Grandstand Layout
 - 2.66" Corrugated Bins 7 Rings and 4.00" Corrugated Bins 5 Rings 19
- Chapter 8 18' Cor-Lok/Cut-Lok Plank Order 20**
- Chapter 9 18' Grandstand Layout for Recirculating System 21**
 - 18' 20 Gauge Grandstand Layout for Recirculating System
 - Cut-Lok or 18 Gauge Cor-Lok Floors 21
- Chapter 10 18' Cut-Lok/Cor-Lok and Grandstand Layouts 22**
 - 18' Cor-Lok/Cut-Lok and 20 Gauge Grandstand Layout
 - 2.66" Corrugated Bins 5 and 6 Rings and 4.00" Corrugated Bins 3 and 4 Rings 22
 - 18' Cor-Lok/Cut-Lok and 20 Gauge Grandstand Layout
 - 2.66" Corrugated Bins 7 and 8 Rings and 4.00" Corrugated Bins 5 and 6 Rings 23
 - 18' Cor-Lok/Cut-Lok and 20 Gauge Grandstand Layout
 - 2.66" Corrugated Bins 9-11 Rings and 4.00" Corrugated Bins 7 and 8 Rings 24
 - 18' Cor-lok/cut-lok and 20 Gauge Grandstand Layout
 - 2.66" Corrugated Bins 12 Rings 25
 - 18' Cor-Lok/Cut-Lok and 20 Gauge Grandstand Layout
 - 4.00" Corrugated Bins 9 Rings 26

Table of Contents

Chapter 11 20 Gauge Floor Support Requirements	27
20 Gauge Grandstand Chart - 2.66" Corrugation	27
20 Gauge Grandstand Chart - 4.00" Corrugation	28
Chapter 12 Flashing Support Stiffeners	29
Stiffener Flashing Support Instructions for Internal Universal Stiffeners	29
Chapter 13 Air Flow Support Instructions	30
Installation of Air Flow Supports	30
Chapter 14 Warranty	37

SEE [PAGE 27](#) AND [PAGE 28](#) FOR 20 GAUGE FLOOR
SUPPORT REQUIREMENTS.

Safety Guidelines

This manual contains information that is important for you, the owner/operator, to know and understand. This information relates to protecting **personal safety** and **preventing equipment problems**. It is the responsibility of the owner/operator to inform anyone operating or working in the area of this equipment of these safety guidelines. To help you recognize this information, we use the symbols that are defined below. Please read the manual and pay attention to these sections. Failure to read this manual and its safety instructions is a misuse of the equipment and may lead to serious injury or death.



This is the safety alert symbol. It is used to alert you to potential personal injury hazards. Obey all safety messages that follow this symbol to avoid possible injury or death.



DANGER indicates an imminently hazardous situation which, if not avoided, will result in death or serious injury.



WARNING indicates a potentially hazardous situation which, if not avoided, could result in death or serious injury.



CAUTION indicates a potentially hazardous situation which, if not avoided, may result in minor or moderate injury.



CAUTION used without the safety alert symbol indicates a potentially hazardous situation which, if not avoided, may result in property damage.



NOTE indicates information about the equipment that you should pay special attention.

Safety Instructions

Our foremost concern is your safety and the safety of others associated with this equipment. We want to keep you as a customer. This manual is to help you understand safe operating procedures and some problems which may be encountered by the operator and other personnel.

As owner and/or operator, it is your responsibility to know what requirements, hazards and precautions exist, and to inform all personnel associated with the equipment or in the area. Safety precautions may be required from the personnel. Avoid any alterations to the equipment. Such alterations may produce a very dangerous situation where **SERIOUS INJURY** or **DEATH** may occur.

This equipment shall be installed in accordance with the current installation codes and applicable regulations which should be carefully followed in all cases. Authorities having jurisdiction should be consulted before installations are made.

Follow Safety Instructions

Carefully read all safety messages in this manual and safety signs on your machine. Keep signs in good condition. Replace missing or damaged safety signs. Be sure new equipment components and repair parts include the current safety signs. Replacement safety signs are available from the manufacturer.

Learn how to operate the machine and how to use controls properly. Do not let anyone operate without instruction.

Keep your machinery in proper working condition. Unauthorized modifications to the machine may impair the function and/or safety and affect machine life.

If you do not understand any part of this manual or need assistance, contact your dealer.

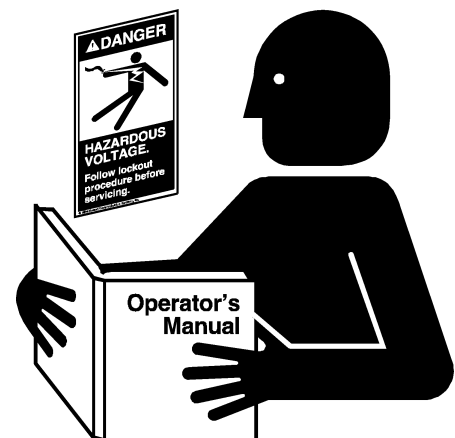

Read and Understand Manual

Rotating Flight

Grain augers can kill or dismember.

Keep clear of all augers and never enter the bin unless all power is disconnected and locked out. Failure to do so will result in serious injury or death.



Rotating Flight

Prepare for Emergencies

Be prepared if fire starts.

Keep a first aid kit and fire extinguisher handy.

Keep emergency numbers for doctors, ambulance service, hospital and fire department near your telephone.

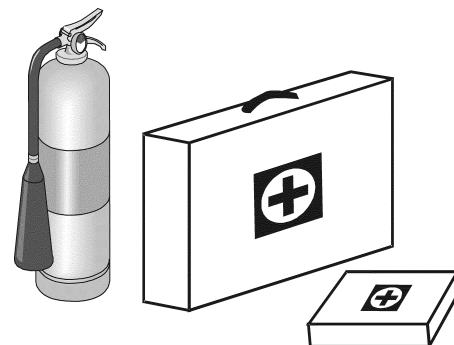

Keep Emergency Equipment Quickly Accessible

Wear Protective Clothing

Wear close fitting clothing and safety equipment appropriate to the job.

Remove all jewelry.

Long hair should be tied up and back.

Safety glasses should be worn at all times to protect eyes from debris.

Wear gloves to protect your hands from sharp edges on plastic or steel parts.

Wear steel toe boots to help protect your feet from falling debris. Tuck in any loose or dangling shoe strings.

A respirator may be needed to prevent breathing potentially toxic fumes and dust.

Wear hard hat to help protect your head.

Eye Protection

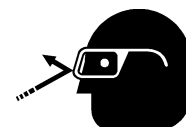

Gloves



Steel Toe Boots



Respirator



Hard Hat



2. Recommended Method for Full Floor Installation

Fan Placement Diagram

For uniform air flow, place the fans in relation to the unloading tube as shown in [Figure 2A](#). Floor planks should be perpendicular to the unloading tube.

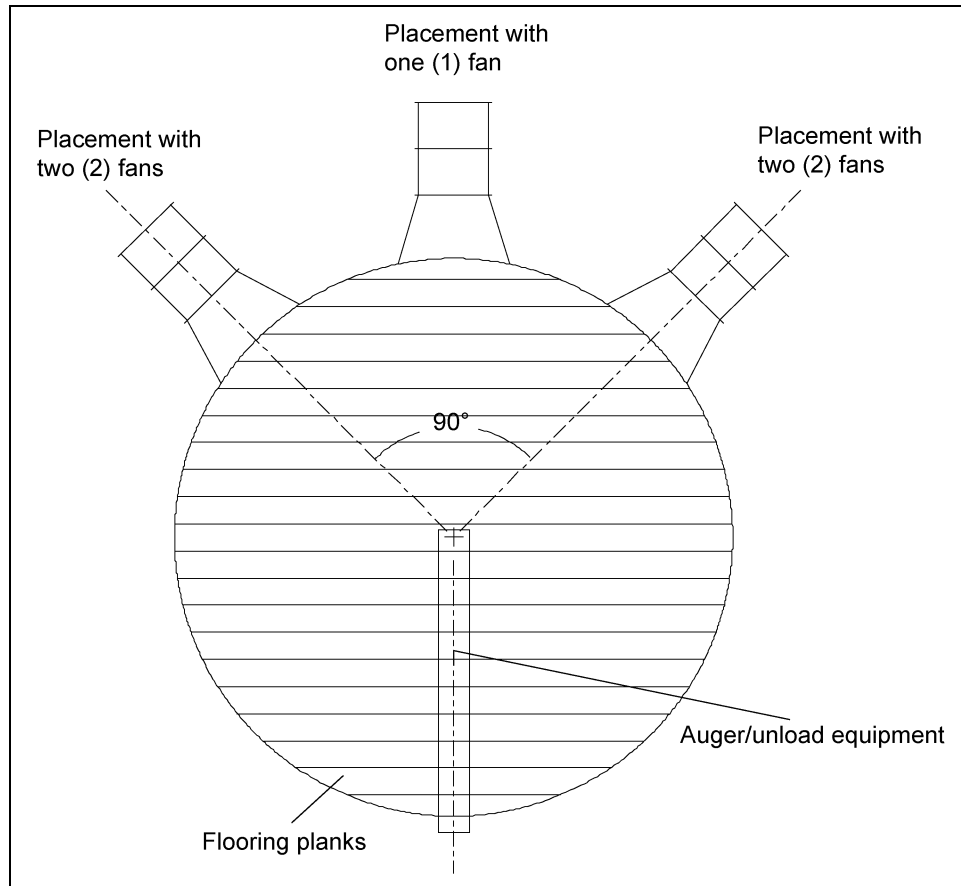

Figure 2A

Grain Systems Recommended Method for Full Floor Installation

Using the GSI recommended method for full floor installation should save construction time and eliminate the problem of improper installation which could invalidate your warranty. Note the following dimensions as shown in [Figure 2B](#).

- Dimension “A” is the leg-to-leg spacing along the centerline of a given plank.
- Dimension “B” is the amount of stagger between supports under adjacent planks and is half of Dimension “A”.
- Dimension “C” is the distance from the center of the unload auger to the nearest rows of supports and is half of Dimension “B”.

Dimensions “A”, “B” and “C” are shown on the appropriate grandstand layout for wall heights under 32 feet. For taller bins, grandstand quantity as well as dimensions “A” and “B” are given on [Page 27](#) and [Page 28](#) for 20 gauge.

1. Layout centerlines of tank. Make sure one centerline is in line with the direction of the flooring planks while the other centerline is perpendicular with the flooring planks. [See Figure 2B](#).
2. From the centerline that is perpendicular to the flooring planks, measure the distance of “C” Dimension and mark a chalk line. [See Figure 2B](#).
3. From the line chalked in the previous step, measure over the distance of “B” Dimension and chalk another line. Repeat this procedure across the bin until reaching the wall in both directions. When completed, there should be a set of parallel lines (perpendicular to the floor planks) with “B” Dimension distance between each line. [See Figure 2B](#).

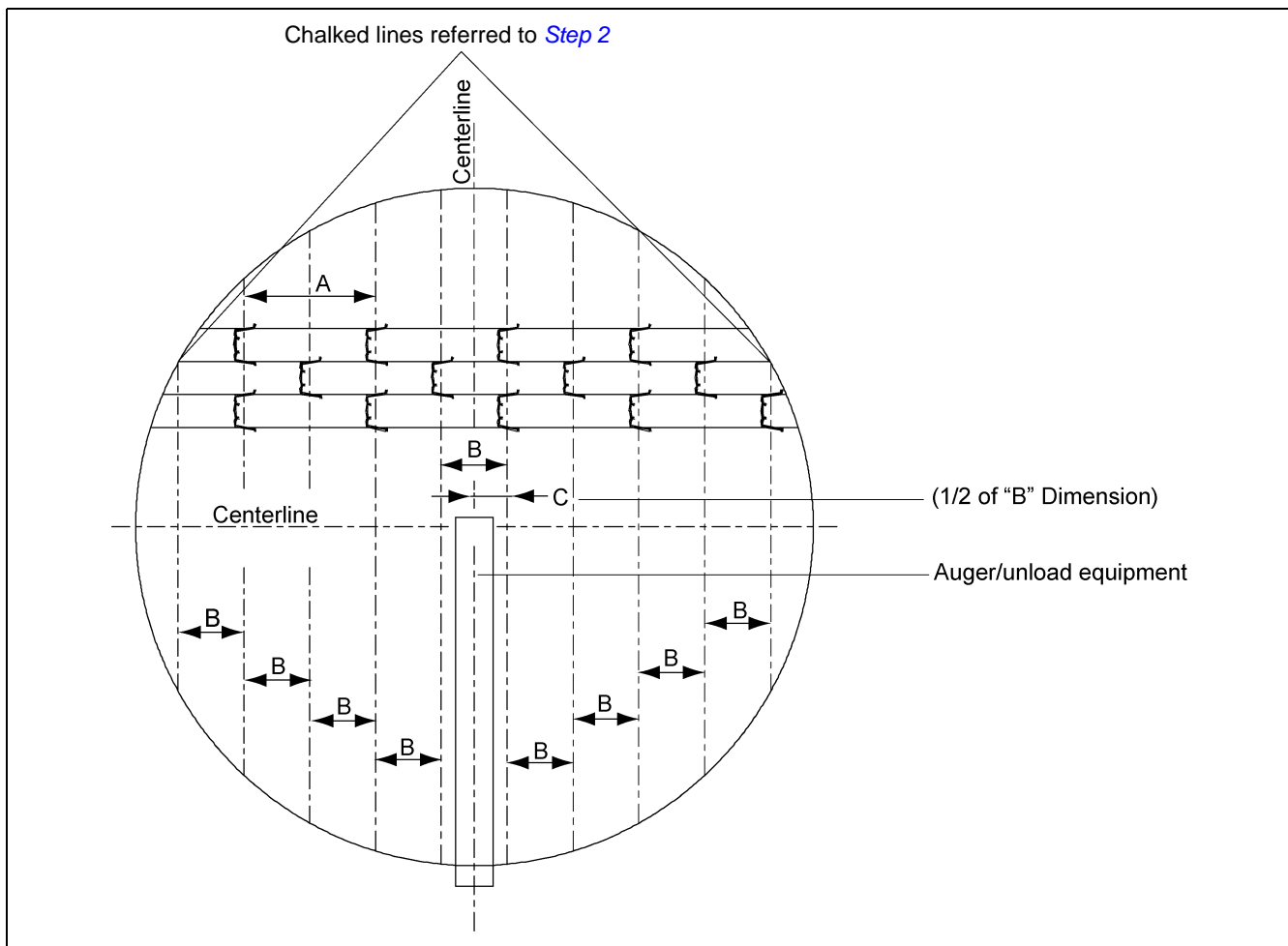

Figure 2B

2. Recommended Method for Full Floor Installation

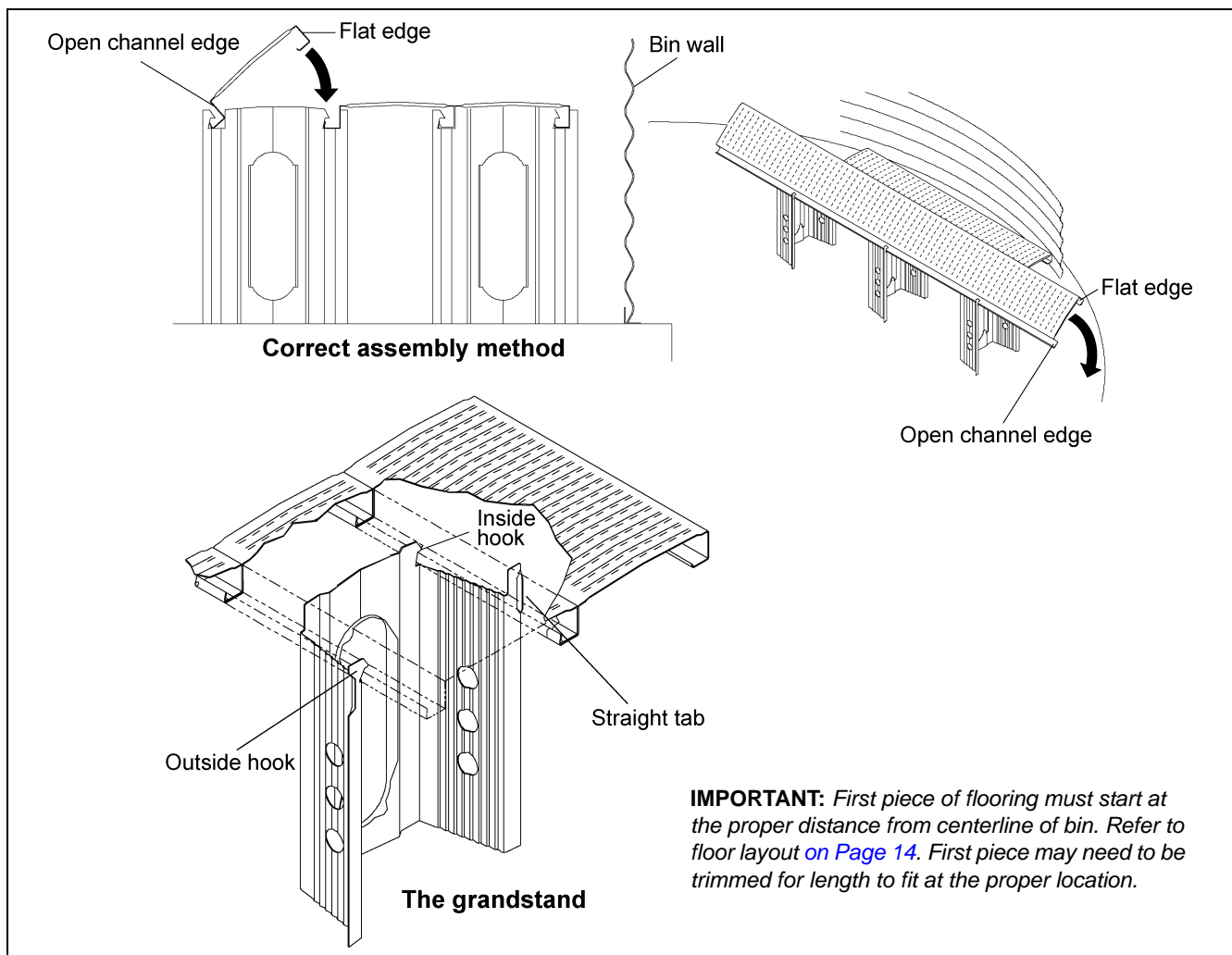

Figure 2C

4. Install flooring starting at the bin wall on the opposite side of the unload auger. Floor planks should be placed perpendicular to the unload auger with the outside edge the correct distance from the center of the bin. (See Figure 6A on Page 14.) Be sure the flat edge of the floor plank is facing the bin wall and the open channel edge is facing towards the center of the bin. (See Figure 2C.) Position the supports for the first/shortest floor plank according to the number of bin rings and corrugation as shown in the illustrations on Pages 21-26 or stated in the charts on Pages 27-28. Attach the flashing to flooring and bin wall to hold plank in place. (See Page 12 for flashing installation.)
5. **POSITION THE NEXT ROW OF SUPPORTS ACCORDING TO THE CHALK LINES** and support layout. The straight tab should “snap” under the first (previous) floor piece. After the supports in the row are correctly positioned, install the next floor piece by hooking the open channel edge under the outside hooks of the floor supports. Push down sharply on the edge of the floor piece until it snaps into the previous floor piece. (See Figure 2C.) Continue this process for the rest of the floor cutting planks for center and intermediate wells as needed. See Figure 5A on Page 13 for center well support locations.

NOTE: Whenever there is more than Dimension B divided by three inches ($B/3$) of plank unsupported beside the bin wall, there should be a support on that plank or a support on each of the planks adjacent to it such that no more than Dimension B divided by three inches ($B/3$) is unsupported. For example: 2.66" bin with 8 rings has a “B” dimension of 22". Take $22"/3 = 7.33$ " (Round to 7"). Therefore, there should be no more than 7" of unsupported floor plank.

20 Gauge Grandstand Identification

20 Gauge	
Plenum Clearance	Grandstand Color Code
11-7/8"	Blue
14-3/8"	White
17-3/16"	Yellow

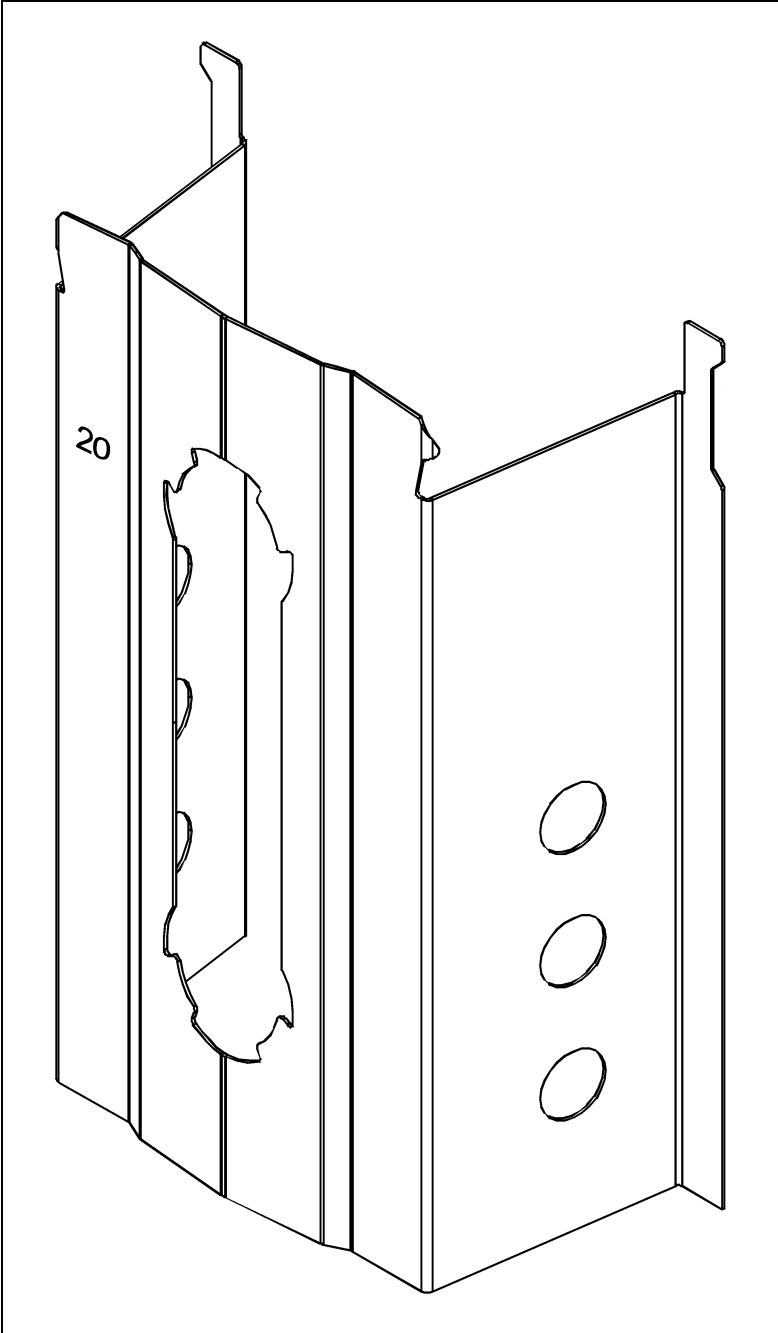

Figure 3A

4. Flashing Installation

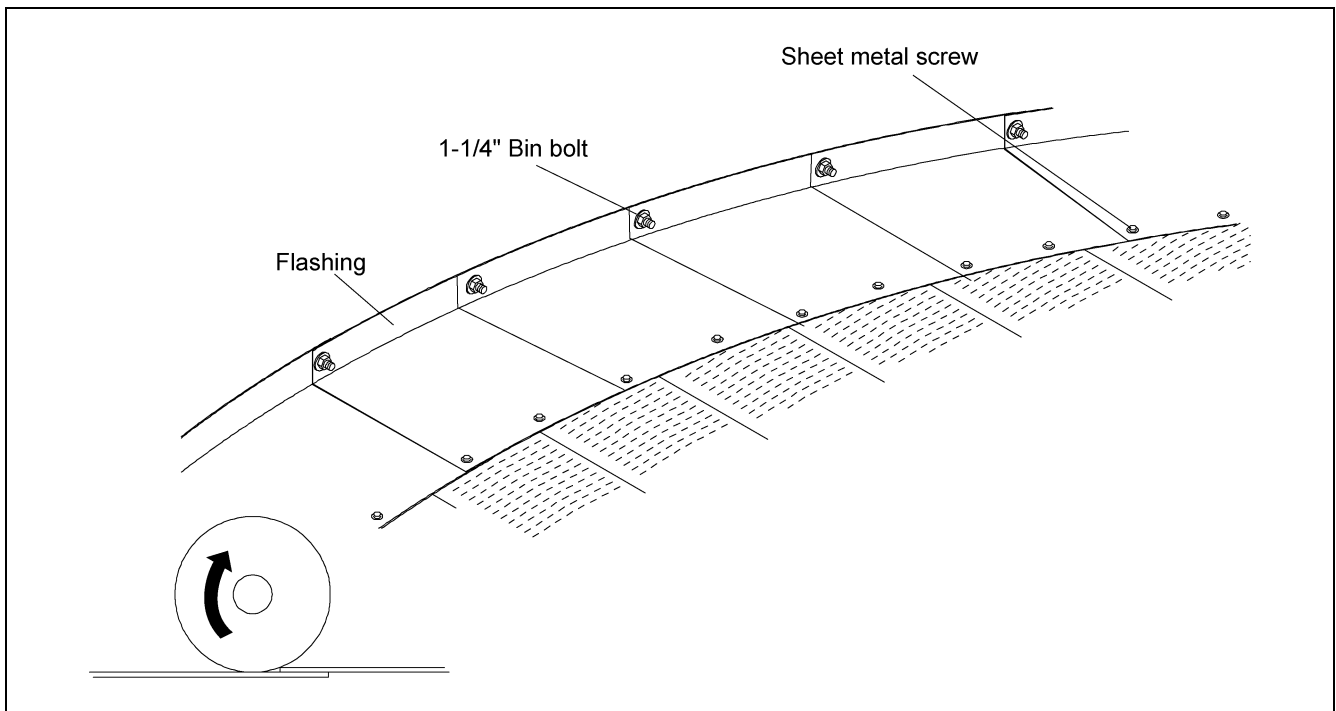

Figure 4A

Grain Systems Formed Flashing Installation

If a bin sweep auger will be used, overlap flashing so that the sweep will climb up on to the next flashing section when rotating (usually clockwise). (See Figure 4A.) This will prevent the rotating/slipping outer wheel of the sweep from catching on the flashing edges. (All GSI power sweeps and carry-in sweeps manufactured after April 2002 run clockwise.)

After floor is in place, place 1-1/4" bolts through pre-punched holes in sidewall. Bolt heads should be on outside of bin. See Figure 4B to determine the correct sequence for placing the nuts and washers. Finger tighten the nuts until all flashing is installed, then go back and fully tighten. While holding the flashing flat and pushing in towards the bin wall, fasten the flashing to the floor with two sheet metal screws.

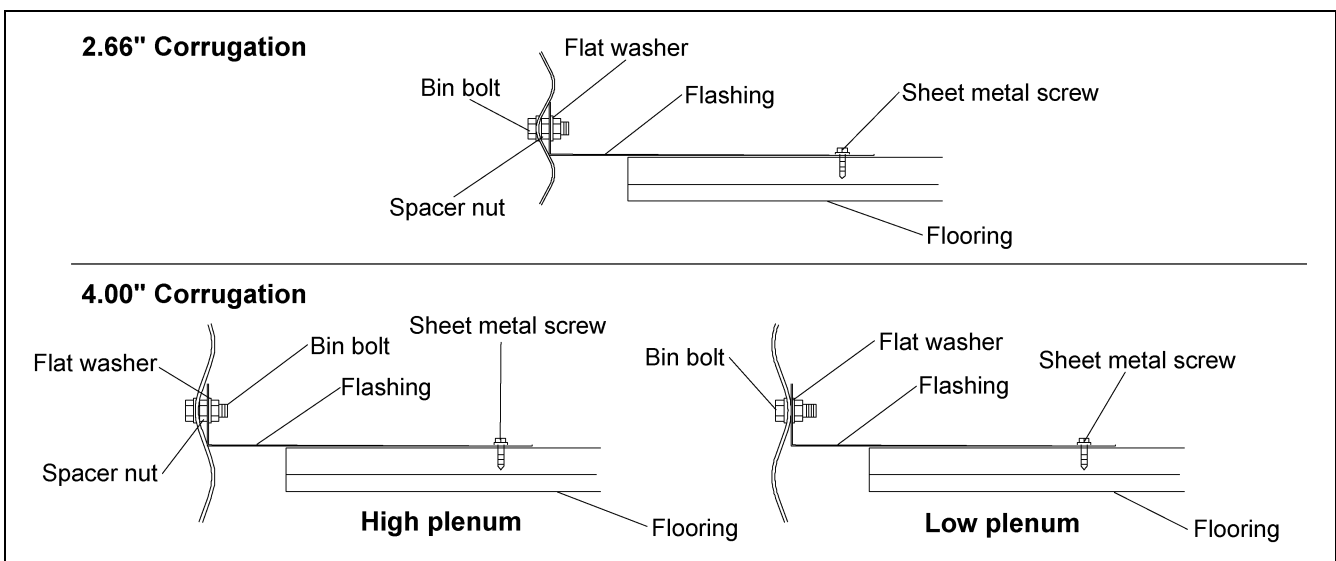

Figure 4B

5. Grandstand Layout at Center Well for Recirculating System

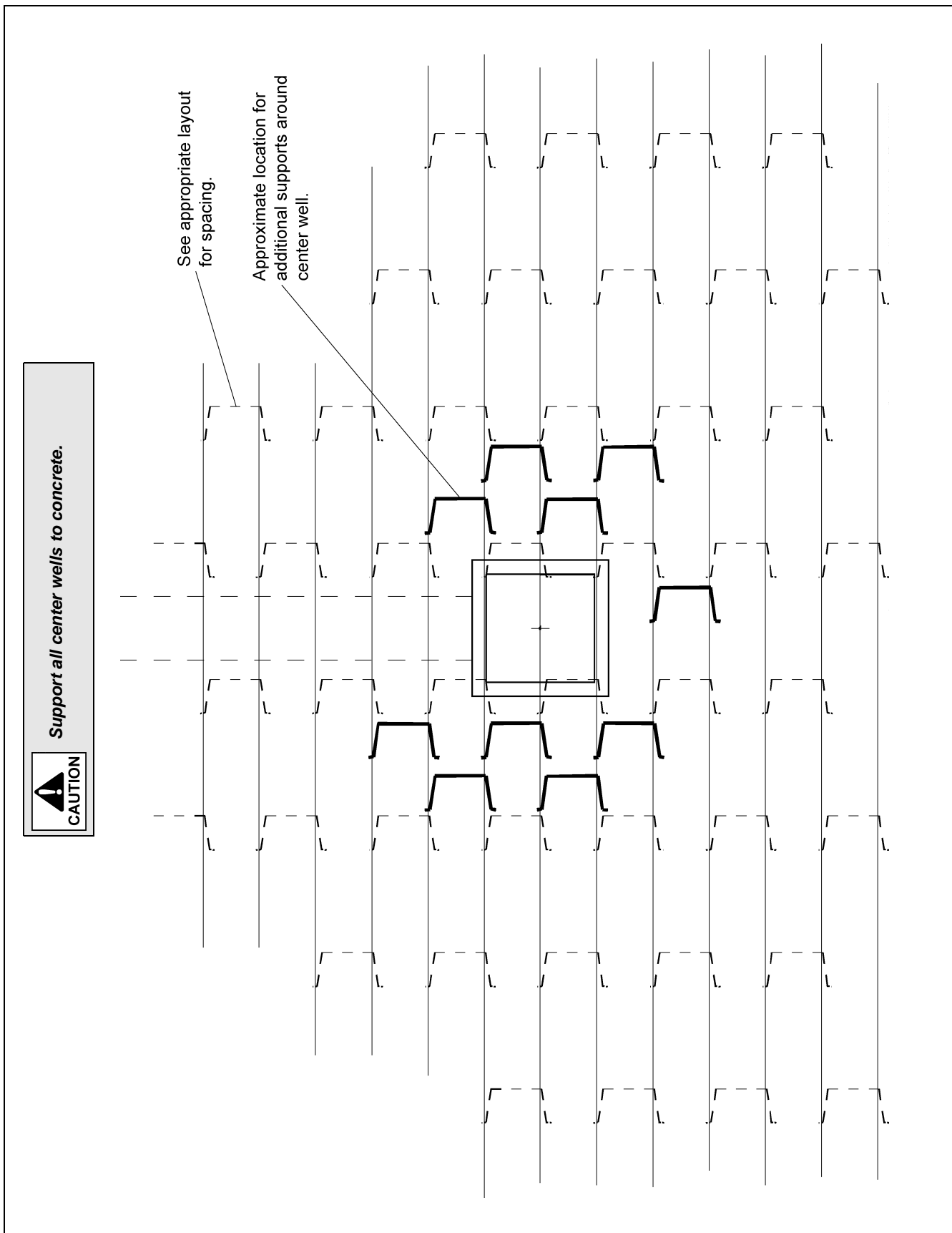

Figure 5A

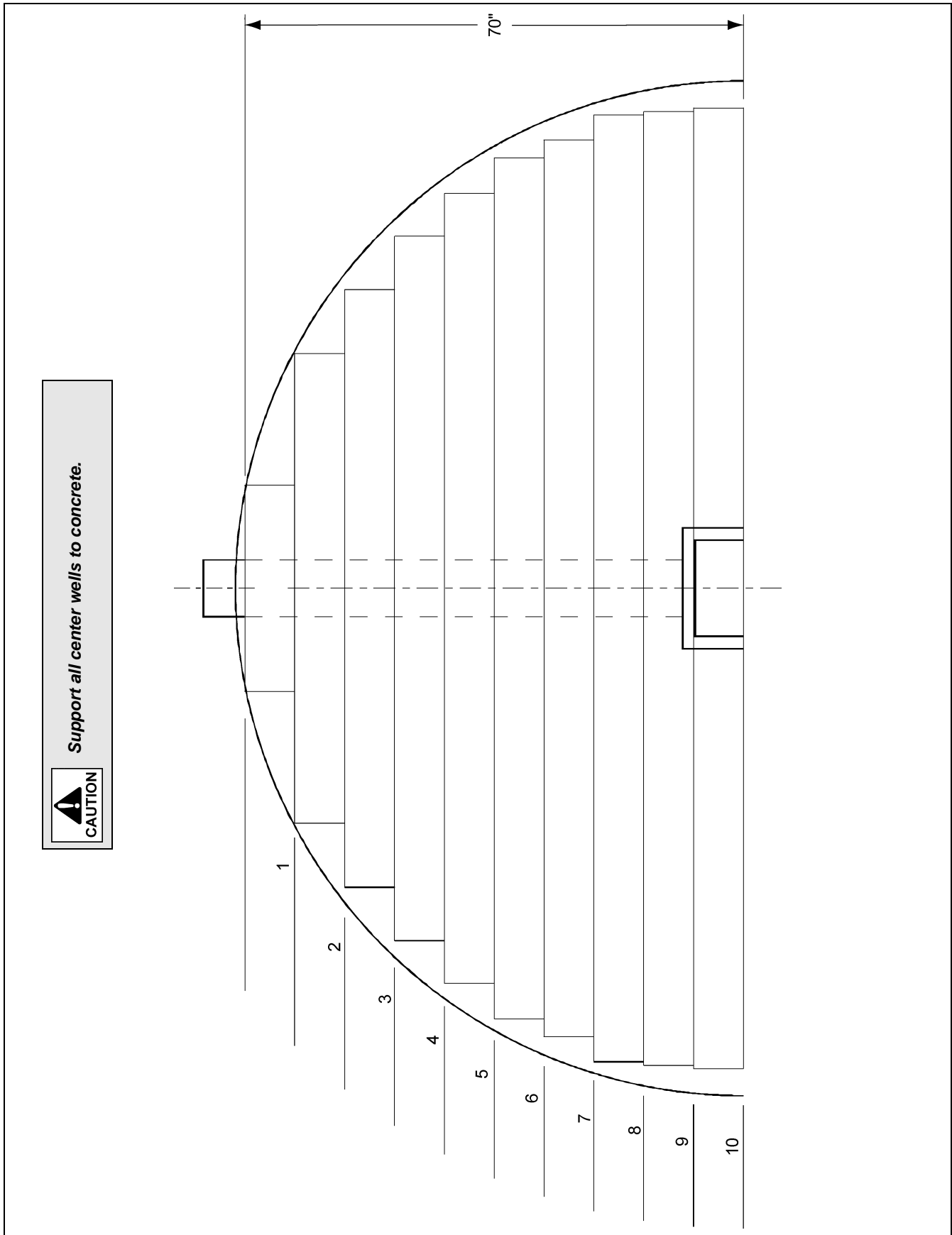

Figure 6A

12' Cor-Lok/Cut-Lok and 20 Gauge Grandstand Layout

2.66" Corrugated Bins 3-7 Rings and 4.00" Corrugated Bins 3-5 Rings

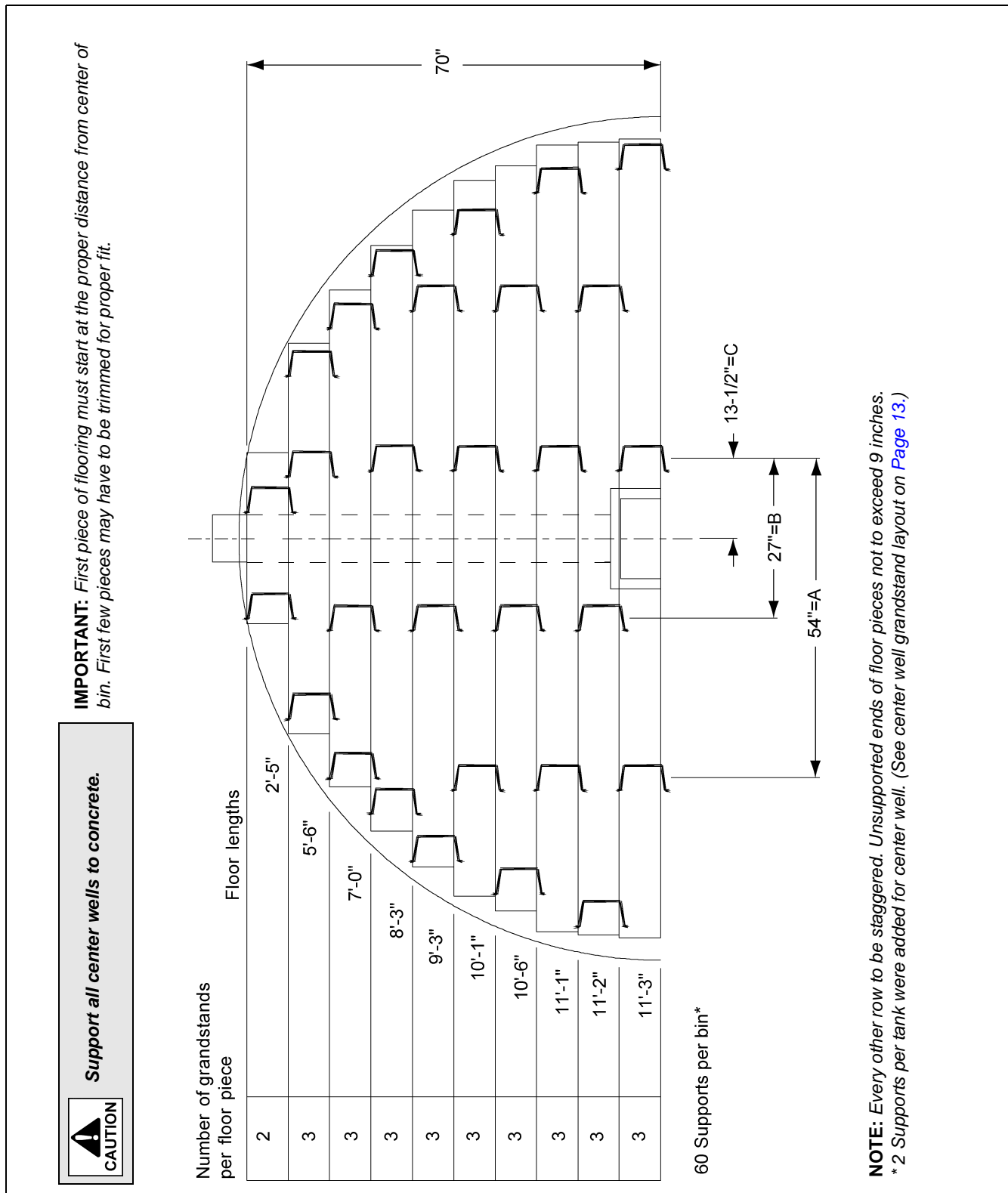

Figure 6B

15' Cut-Lok/Cor-Lok Plank Order

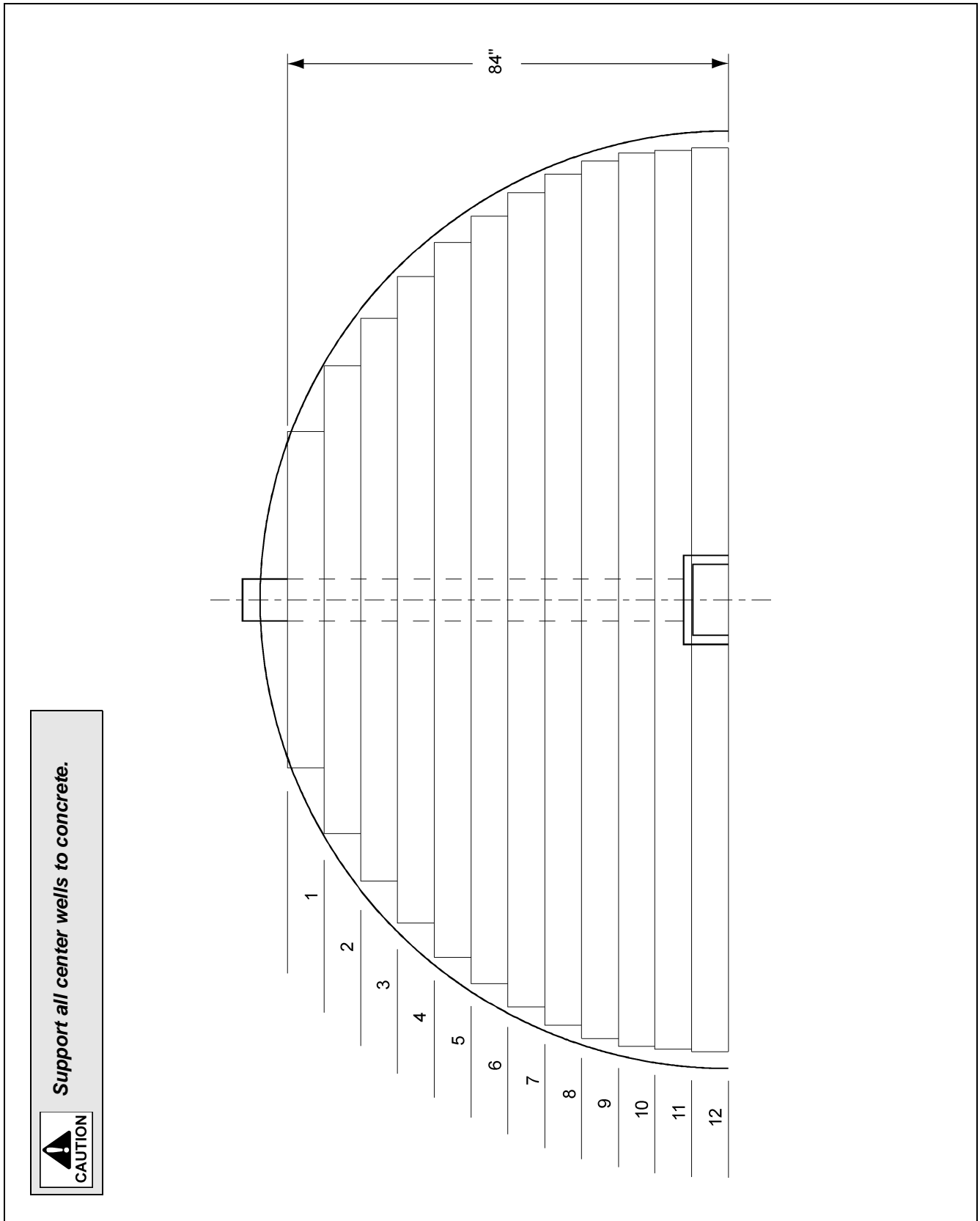

Figure 7A

15' Cor-Lok/Cut-Lok and 20 Gauge Grandstand Layout 2.66" Corrugated Bins 4 and 5 Rings and 4.00" Corrugated Bins 3 Rings

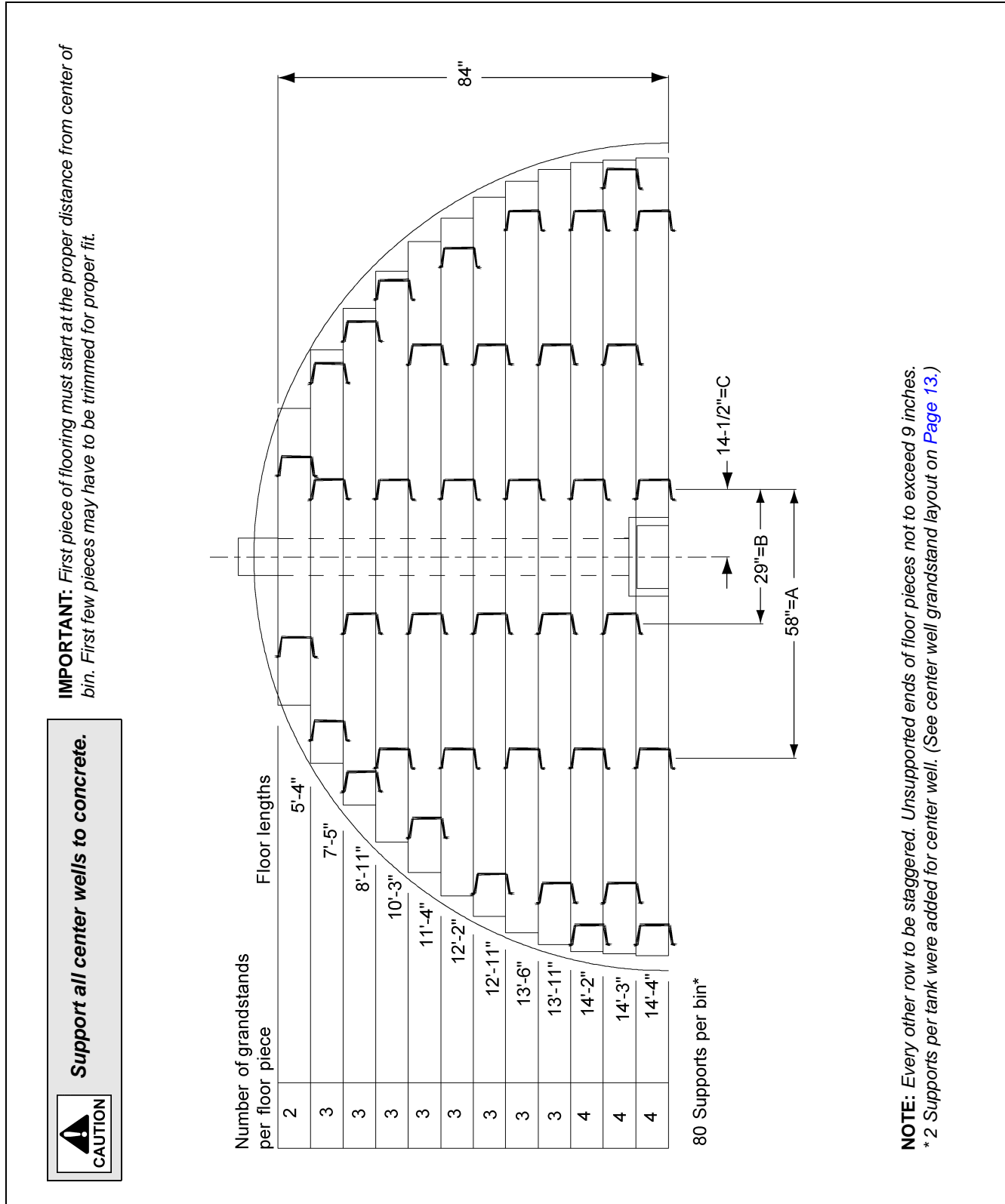

Figure 7B

15' Cor-Lok/Cut-Lok and 20 Gauge Grandstand Layout 2.66" Corrugated Bins 6 Rings and 4.00" Corrugated Bins 4 Rings

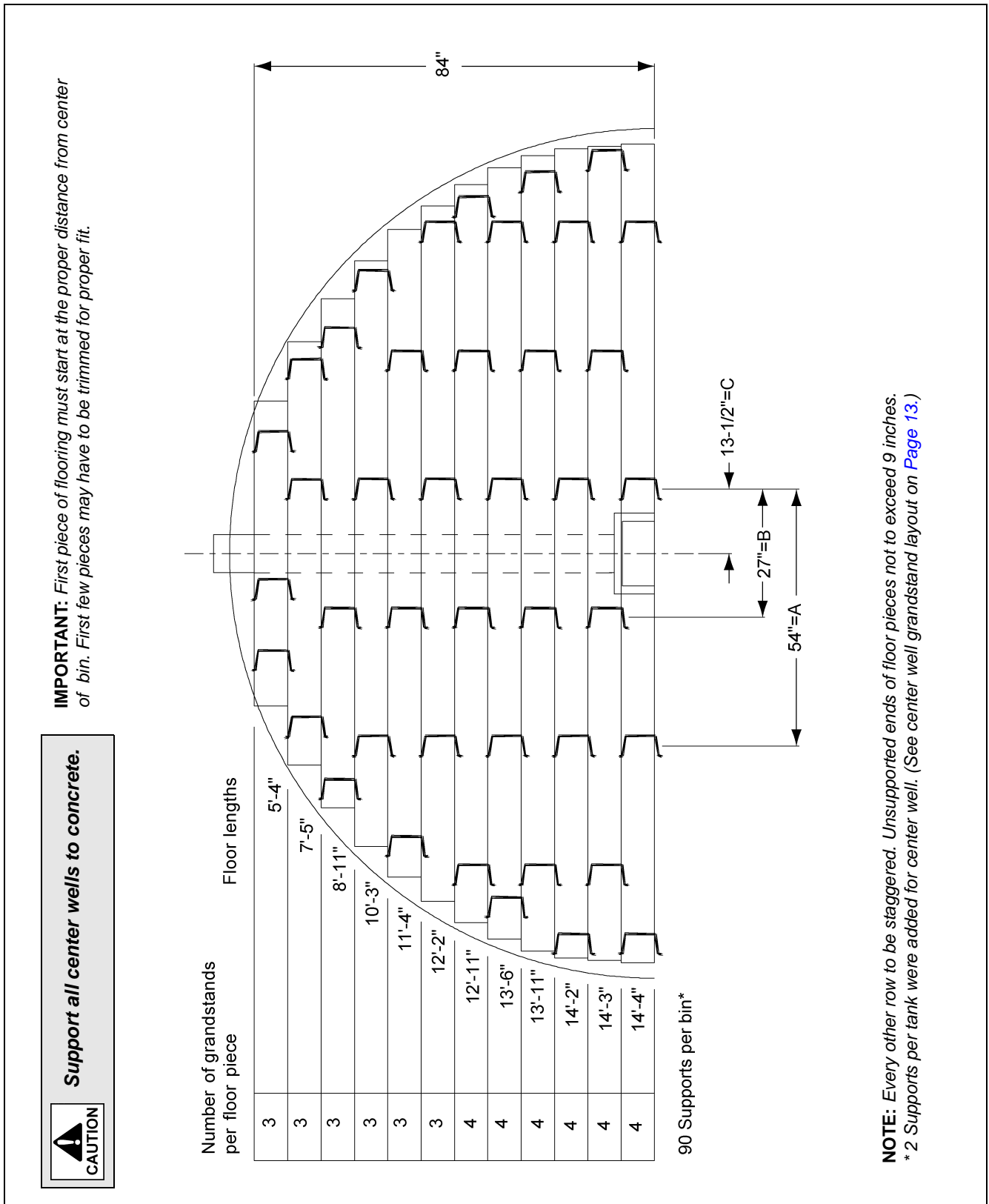

Figure 7C

15' Cor-Lok/Cut-Lok and 20 Gauge Grandstand Layout 2.66" Corrugated Bins 7 Rings and 4.00" Corrugated Bins 5 Rings

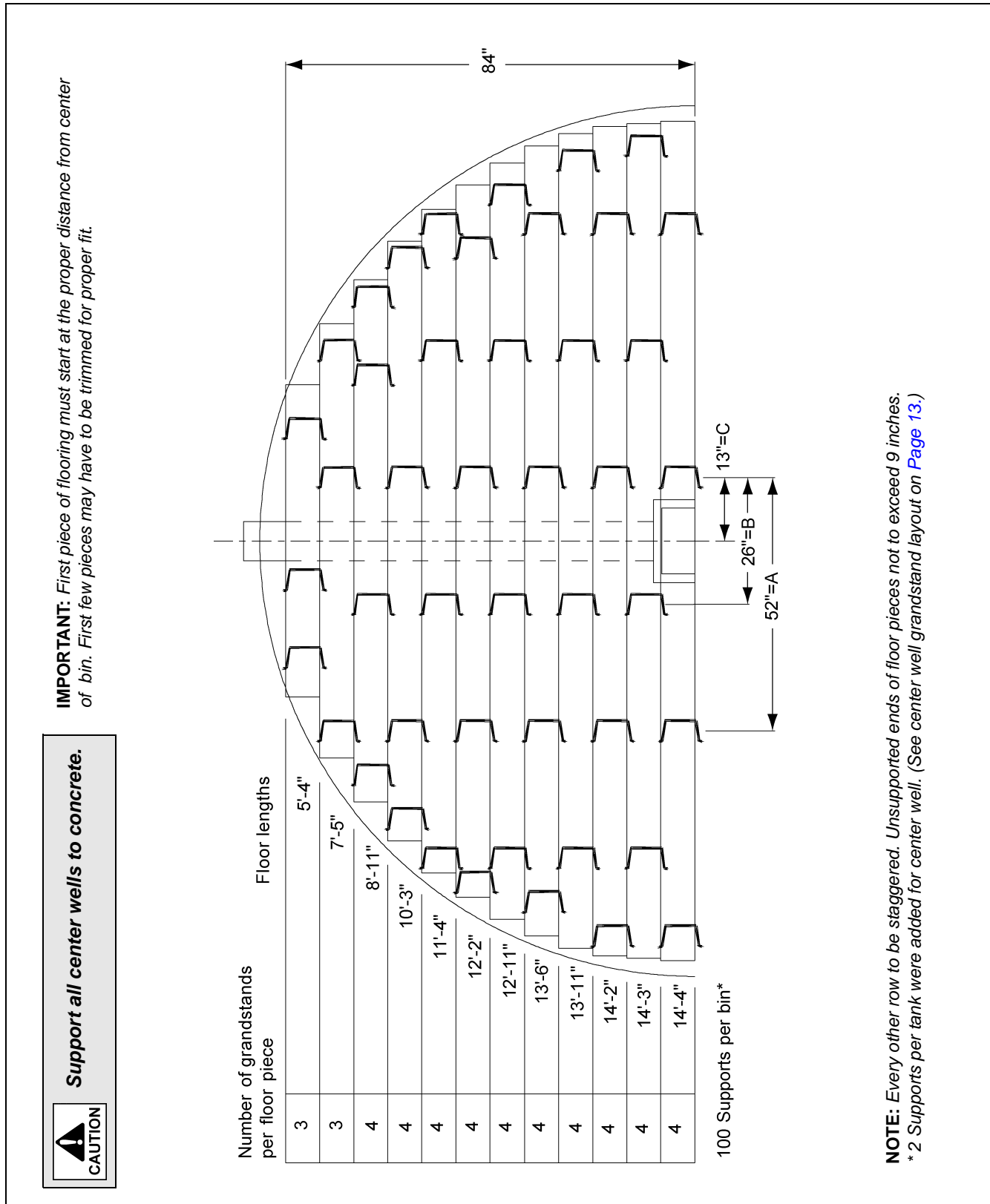

Figure 7D

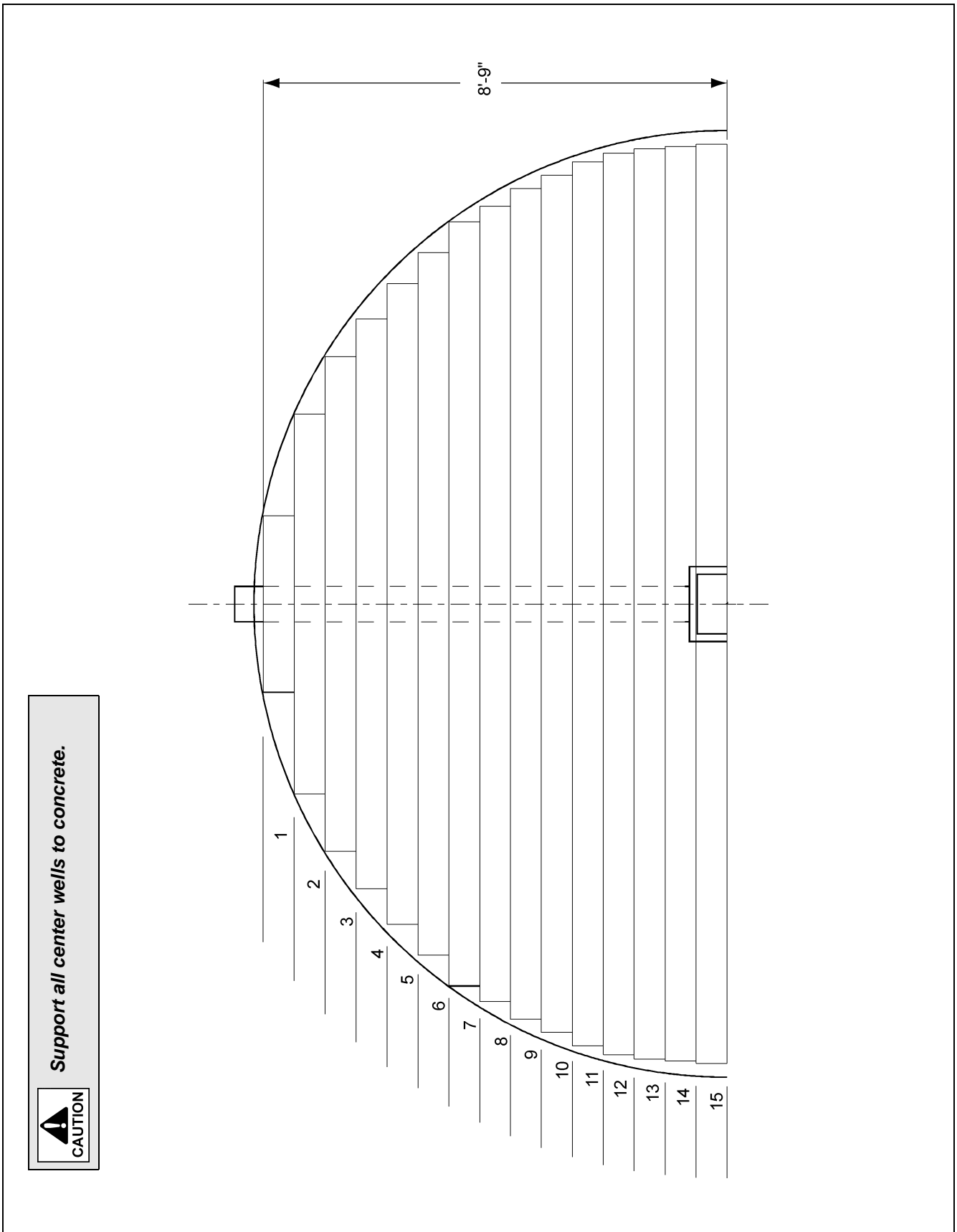

Figure 8A

18' 20 Gauge Grandstand Layout for Recirculating System Cut-Lok or 18 Gauge Cor-Lok Floors

2.66" Corrugated Bins 8 Rings Maximum and
4.00" Corrugated Bins 6 Rings Maximum

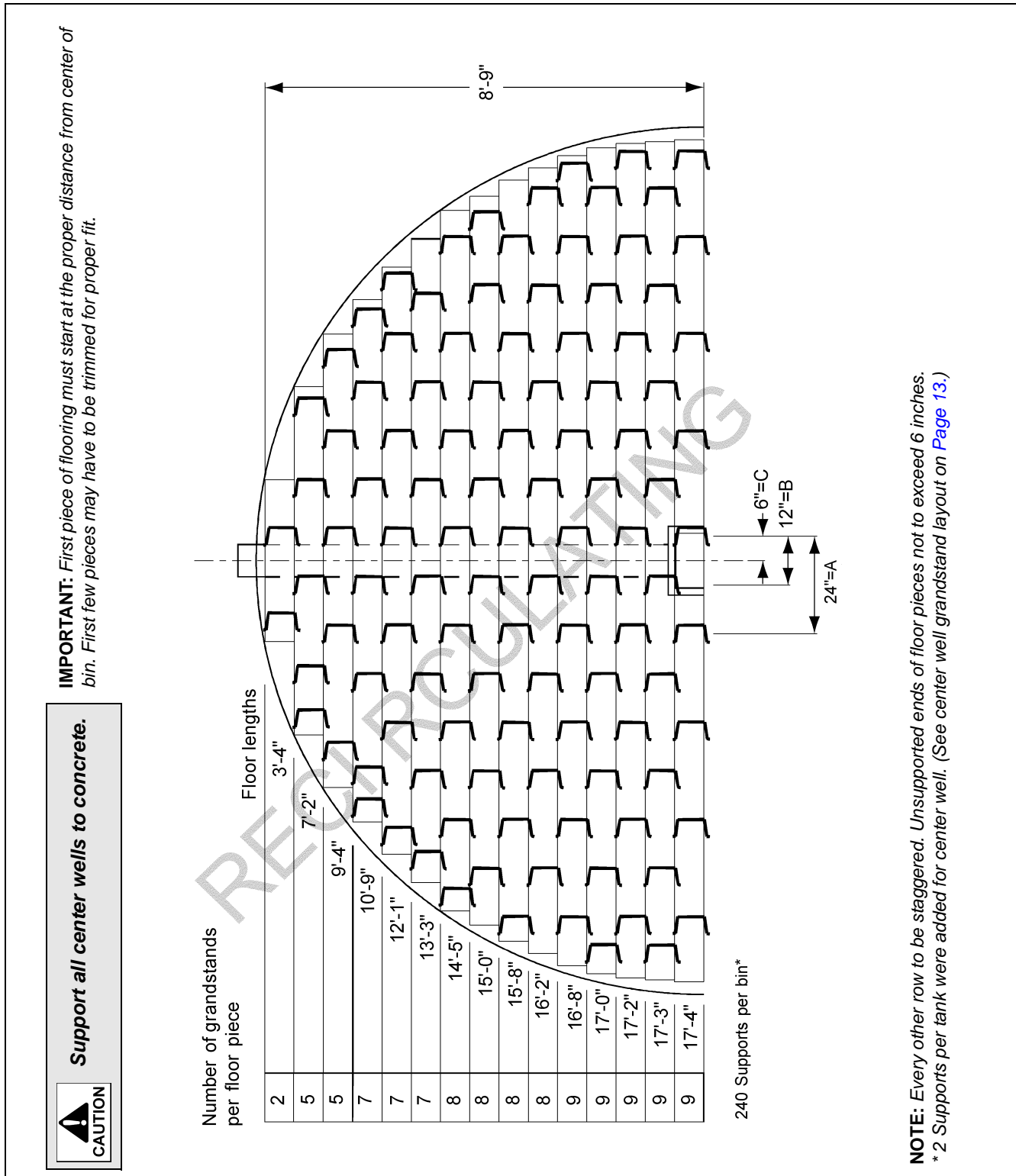

Figure 9A

18' Cor-Lok/Cut-Lok and 20 Gauge Grandstand Layout

2.66" Corrugated Bins 5 and 6 Rings and

4.00" Corrugated Bins 3 and 4 Rings

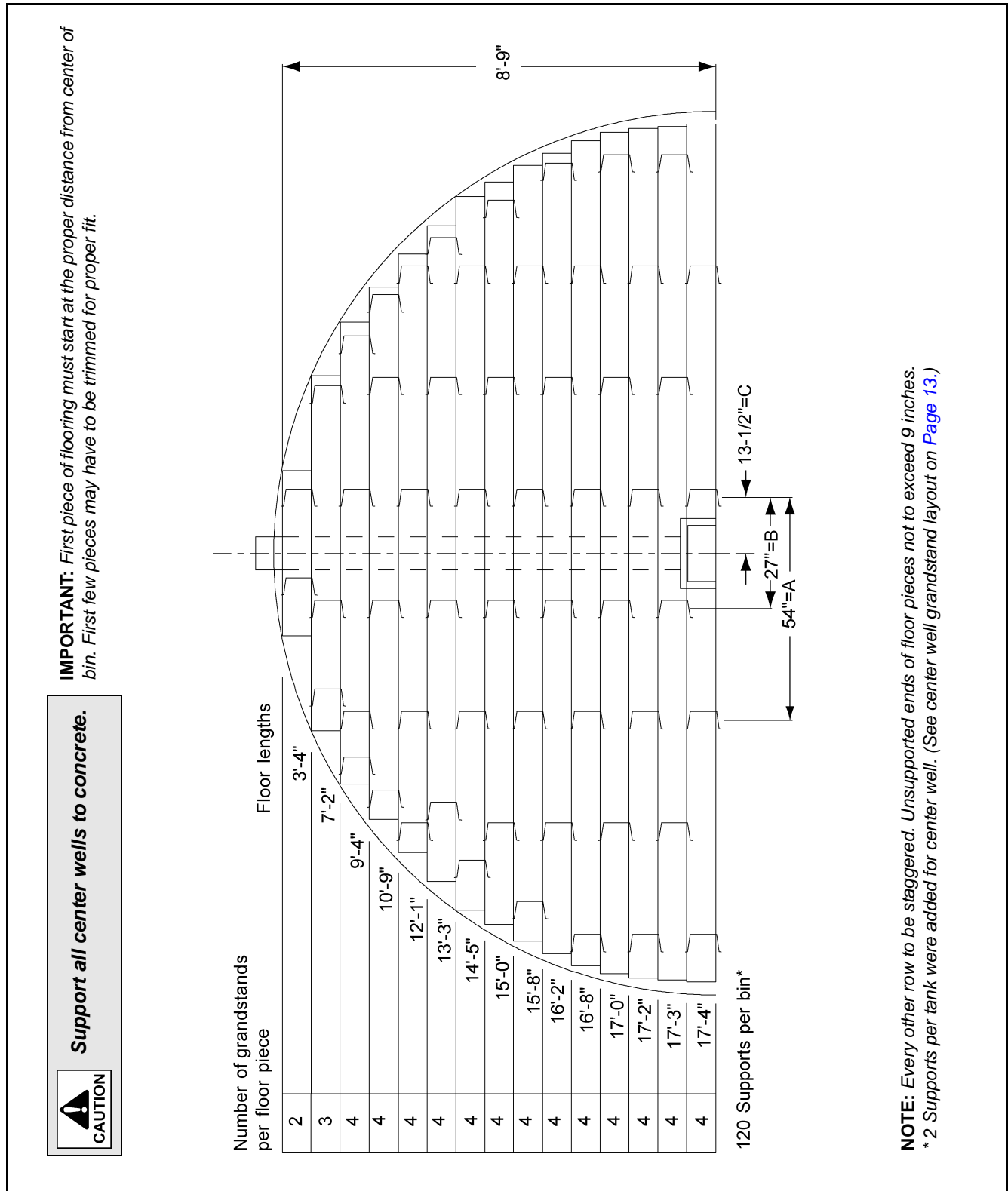

Figure 10A

18' Cor-Lok/Cut-Lok and 20 Gauge Grandstand Layout

2.66" Corrugated Bins 7 and 8 Rings and 4.00" Corrugated Bins 5 and 6 Rings

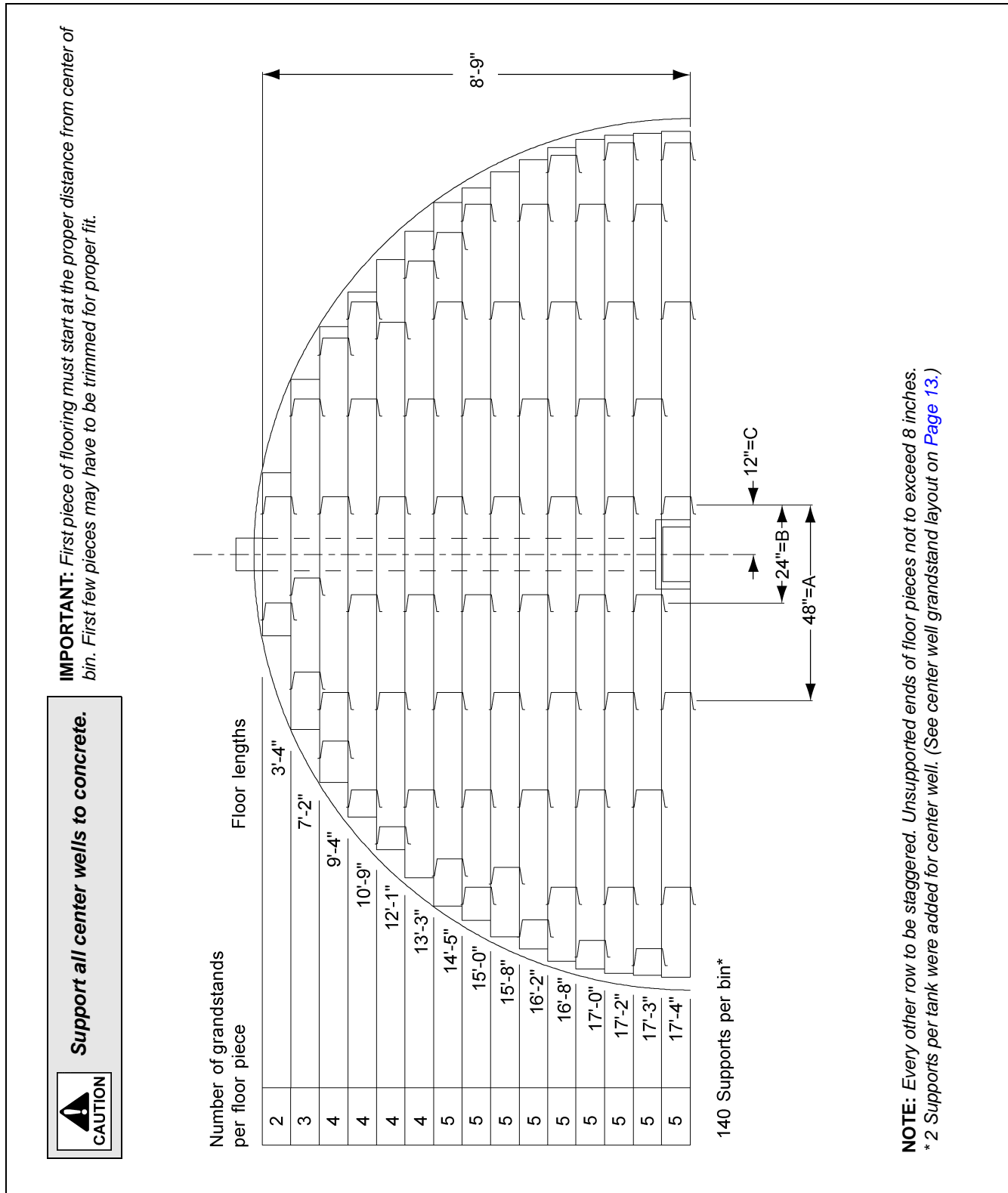

Figure 10B

18' Cor-Lok/Cut-Lok and 20 Gauge Grandstand Layout

2.66" Corrugated Bins 9-11 Rings and 4.00" Corrugated Bins 7 and 8 Rings

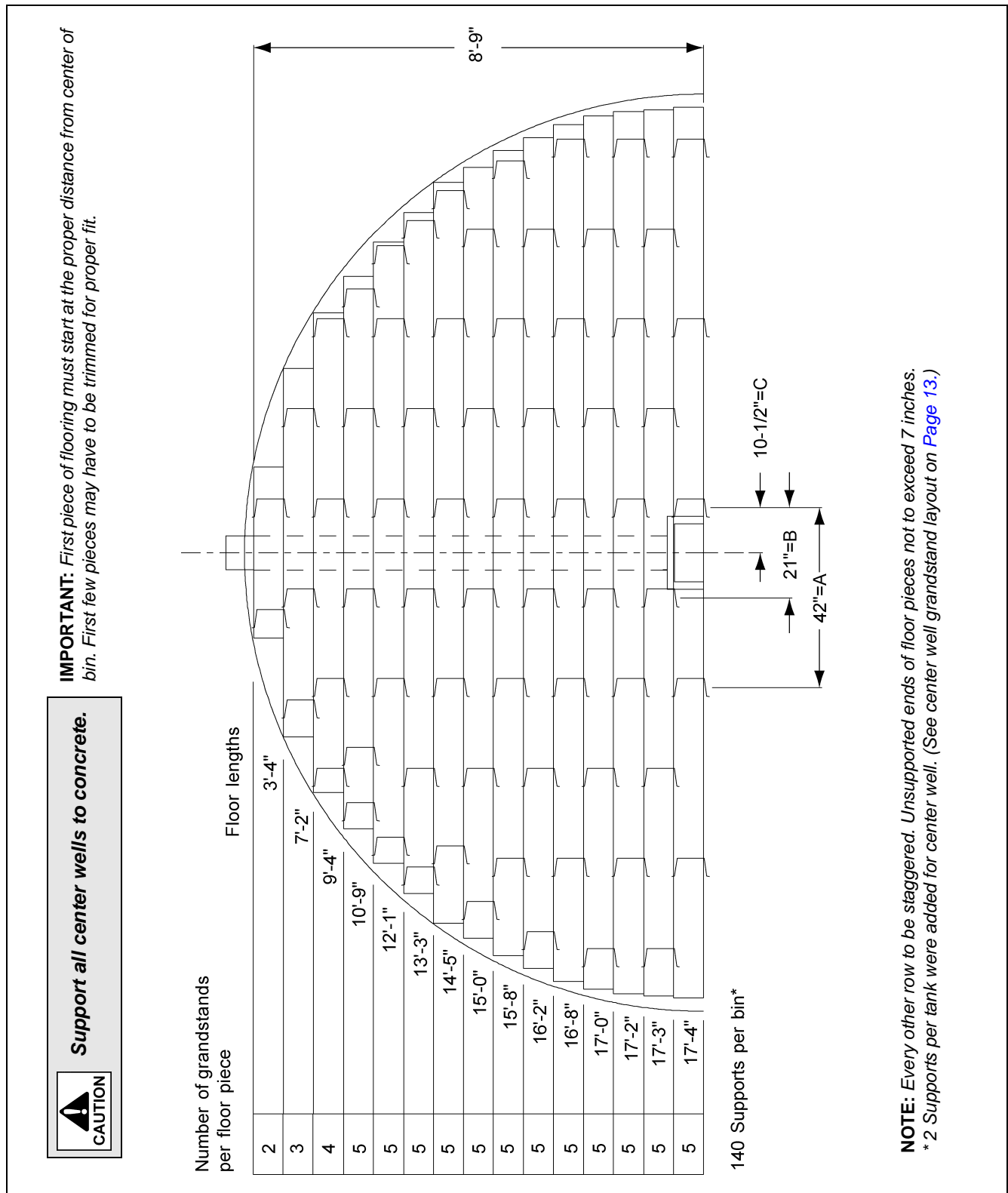

Figure 10C

18' Cor-lok/cut-lok and 20 Gauge Grandstand Layout 2.66" Corrugated Bins 12 Rings

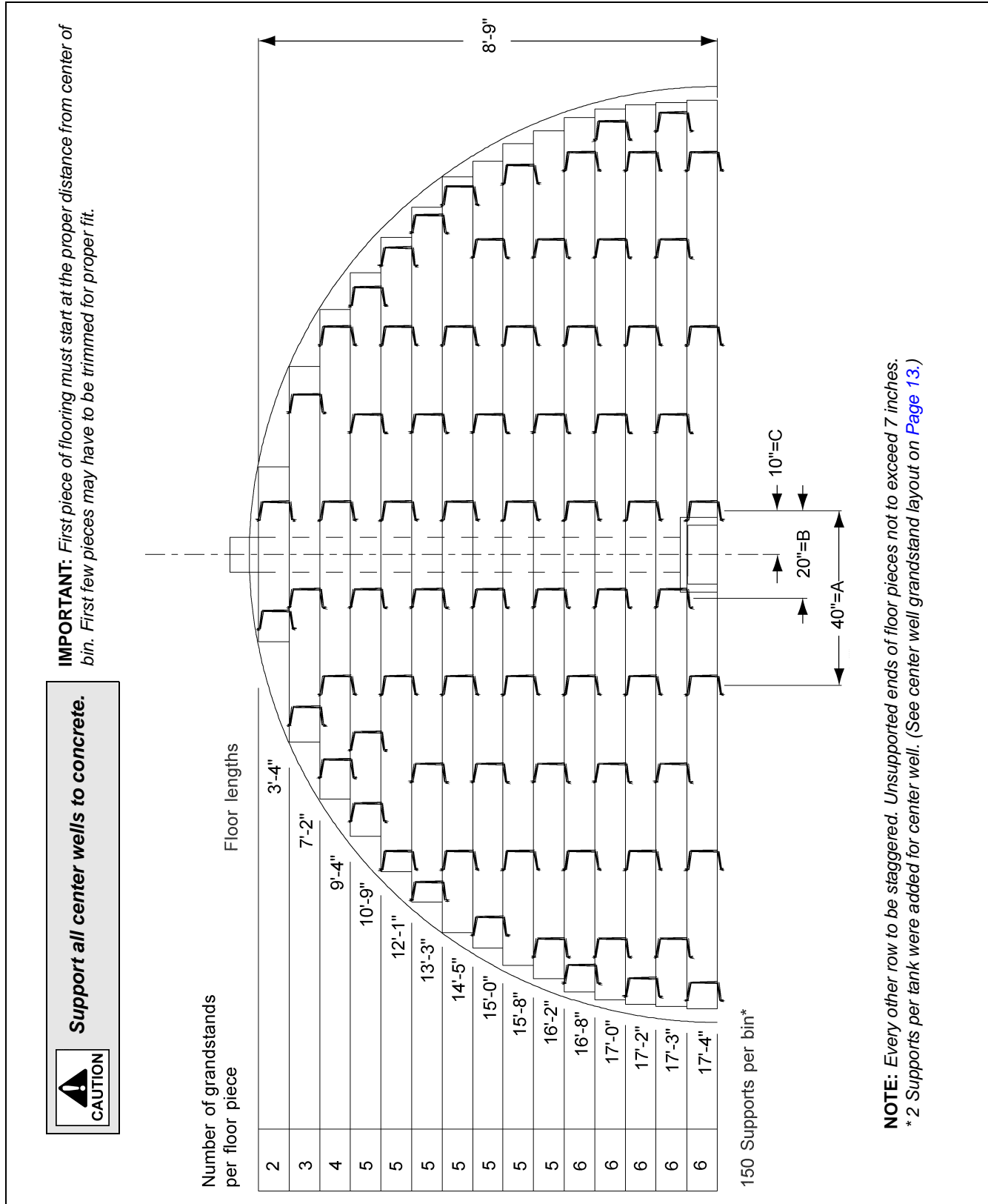

Figure 10D

18' Cor-Lok/Cut-Lok and 20 Gauge Grandstand Layout 4.00" Corrugated Bins 9 Rings

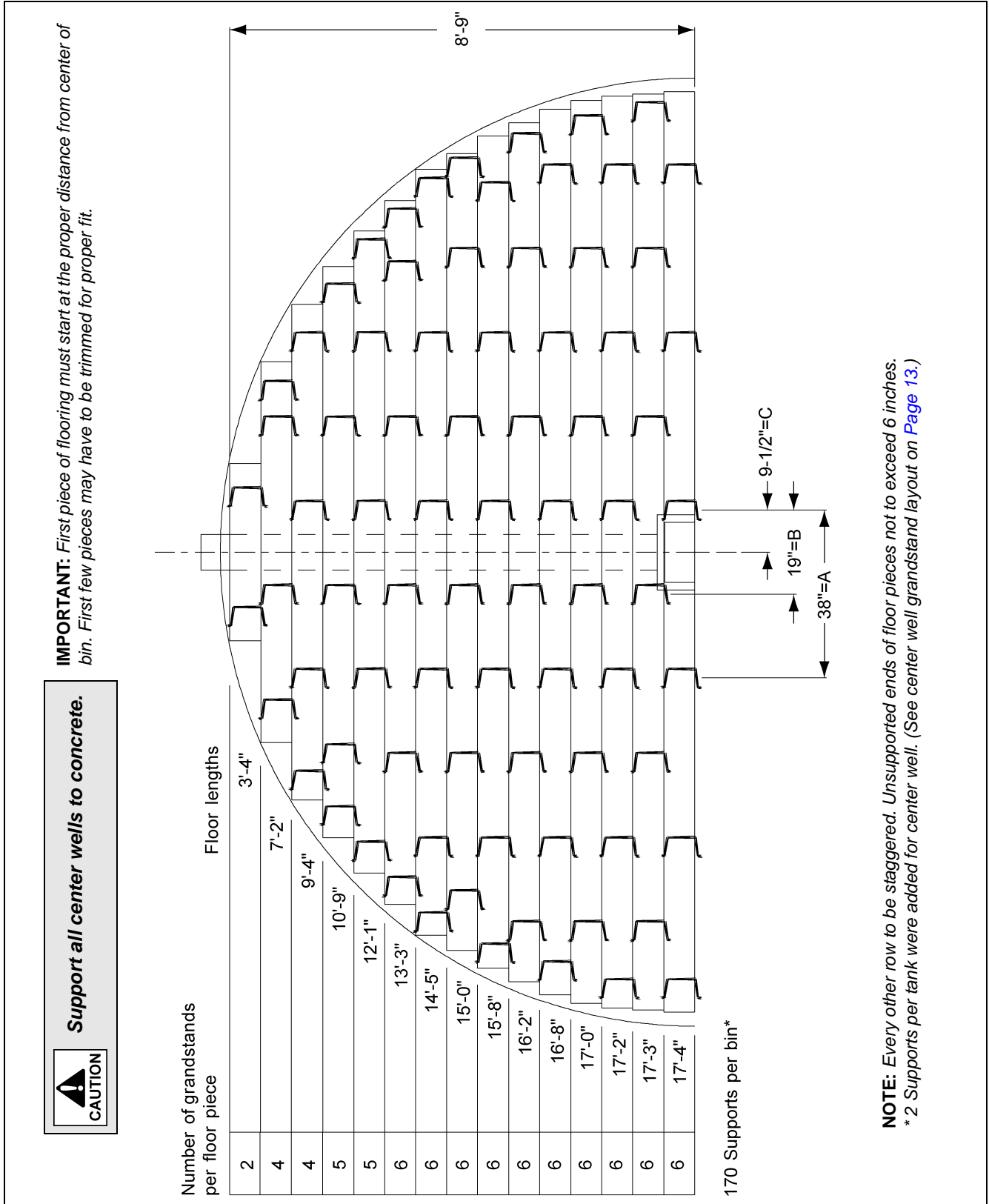

Figure 10E

20 Gauge Grandstand Chart - 2.66" Corrugation

Narrow/2.66" Corrugation - 20 Gauge Grandstand Floor Support Chart

Full Floor Supports Required for Plank Type Flooring 2.66" Corrugation (* Based upon 13.5" or taller floor heights)																				
Dia.	12	15	18	21	24	27	30	33	36	39	42	45	48	54	60	72	75	78	90	105
Rings																				
3	57/27 62																			
4	54/27 62	58/29 80	54/27 120	SUPPORT SPACING SUPPORT QUANTITY				All floor styles OK for bin sizes in upper shaded area.					Floor styles list in order of increasing strength 20 Gauge COR-LOK 18 Gauge COR-LOK CUT-LOK							
5	54/27 62	58/29 80	54/27 120	52/26 160	56/28 205	54/27 249	54/27 304	50/25 390	50/25 470	50/25 576										
6	54/27 62	54/27 88	54/27 120	52/26 160	52/26 215	48/24 275	48/24 333	50/25 390	48/24 487	48/24 586	46/23 695	46/23 806	46/23 909	44/22 1196	44/22 1430					
7	54/27 62	52/26 96	48/24 138	50/25 168	48/24 225	48/24 275	48/24 347	46/23 425	44/22 523	46/23 606	44/22 735	44/22 836	44/22 933	42/21 1236	42/21 1477					
8	48/24 70	48/24 100	48/24 144	46/23 182	46/23 230	46/23 300	44/22 363	44/22 435	44/22 523	42/21 624	42/21 750	42/21 866	42/21 977	40/20 1296	40/20 1544					
9	48/24 70	48/24 100	42/21 144	42/21 190	42/21 243	44/22 303	42/21 387	42/21 465	40/20 565	42/21 656	40/20 790	40/20 906	40/20 1019	38/19 1346	36/18 1697					
10	42/21 75	42/21 110	42/21 144	42/21 190	42/21 250	42/21 309	40/20 397	40/20 479	38/19 597	38/19 716	38/19 820	36/18 986	36/18 1109	34/17 1486	34/17 1779	18 Gauge COR-LOK or CUT-LOK if Dia. and number of rings are in middle unshaded area.				
11	42/21 75	42/21 110	42/21 144	40/20 190	40/20 265	40/20 319	38/19 417	36/18 525	36/18 620	34/17 746	34/17 900	34/17 1036	34/17 1163	32/16 1566	32/16 1883					
12	38/19 80	40/20 115	40/20 154	40/20 202	38/19 280	38/19 345	36/18 441	34/17 550	34/17 659	32/16 786	32/16 950	32/16 1096	30/15 1230	30/15 1660	30/15 1993	26/13 3300	26/13 3580	26/13 3870	24/12 5520	22/11 8110
13	38/19 80	38/19 120	38/19 166	36/18 220	36/18 290	36/18 360	34/17 470	32/16 600	32/16 710	30/15 880	30/15 1010	30/15 1160	28/14 1390	26/13 1760	26/13 2300	24/12 3540	24/12 3840	24/12 4150	22/11 5960	20/10 8820
14	34/17 90	34/17 130	34/17 180	34/17 230	34/17 300	34/17 380	32/16 500	30/15 630	30/15 750	28/14 930	28/14 1070	26/13 1310	26/13 1480	24/12 1870	24/12 2460	22/11 3820	22/11 4150	22/11 4480	20/10 6480	18/9 9680
15	32/16 95	32/16 140	32/16 190	32/16 250	32/16 320	32/16 400	30/15 520	28/14 670	28/14 790	26/13 990	26/13 1140	24/12 1400	24/12 1590	24/12 2000	22/11 2650	22/11 3820	20/10 4500	20/10 4870	18/9 7120	18/9 9680
16	30/15 100	30/15 150	30/15 205	30/15 260	28/14 360	28/14 450	28/14 550	26/13 670	26/13 840	24/12 1060	24/12 1220	24/12 1400	22/11 1710	22/11 2160	20/10 2880	20/10 4150	20/10 4500	18/9 5340	18/9 7120	16/8 10760
17	28/14 106	28/14 160	28/14 215	26/13 290	26/13 380	26/13 480	26/13 590	24/12 710	24/12 900	22/11 1060	22/11 1320	22/11 1510	20/10 1860	20/10 2350	20/10 2880	18/9 4550	18/9 4950	18/9 5340	16/8 7910	16/8 10760
18	26/13 110	26/13 170	24/12 240	24/12 310	24/12 400	24/12 510	24/12 630	24/12 760	22/11 900	22/11 1140	22/11 1320	20/10 1640	20/10 1860	18/9 2570	18/9 3170	16/8 5060	16/8 5500	16/8 5940	14/7 7910	14/7 12150
19		24/12 180	24/12 240	22/11 340	22/11 440	22/11 550	22/11 680	22/11 820	22/11 970	20/10 1140	20/10 1430	20/10 1640	18/9 2040	18/9 2570	16/8 3520	16/8 5060	16/8 5500	16/8 5940	14/7 8920	14/7 12150
20		22/11 190	22/11 260	22/11 340	22/11 440	22/11 550	20/10 740	20/10 890	20/10 1060	20/10 1240	20/10 1430	18/9 1800	18/9 2040	16/8 2860	16/8 3520	14/7 5710	14/7 6200	14/7 6710	12/6 8920	12/6 13990
21				20/10 370	20/10 470	20/10 600	20/10 740	20/10 890	20/10 1060	20/10 1240	18/9 1570	18/9 1800	16/8 2270	16/8 2860	14/7 3970	14/7 5710	14/7 6200	14/7 6710	12/6 10280	12/6 13990
22				18/9 400	18/9 520	18/9 660	18/9 810	18/9 970	18/9 1160	18/9 1360	18/9 1570	16/8 2000	16/8 2270	16/8 2860	14/7 3970	14/7 5710	14/7 6200	12/6 7140	12/6 7730	12/6 10280
23				18/9 400	18/9 520	16/8 730	16/8 900	16/8 1080	16/8 1290	16/8 1510	16/8 1740	16/8 2000	16/8 2270	14/7 3230	14/7 3970	12/6 6580	12/6 7140	12/6 7730		
24	CUT-LOK only if Dia. and number of rings are in bottom shaded area.			16/8 450	16/8 580	16/8 730	16/8 900	16/8 1080	16/8 1290	16/8 1510	16/8 1740	16/8 2000	16/8 2560	14/7 3230	14/7 4570	12/6 6580	12/6 7140	12/6 7730		
25				14/7 500	14/7 650	14/7 820	14/7 1010	14/7 1220	14/7 1450	14/7 1700	14/7 1960	14/7 2260	14/7 2560	14/7 3230	12/6 4570					
26						14/7 820	14/7 1010	14/7 1220	14/7 1450	14/7 1700	14/7 1960	14/7 2260	14/7 2560	12/6 3720	12/6 4570					
27						12/6 950	12/6 1160	12/6 1410	12/6 1670	12/6 1960	12/6 2260	12/6 2600	12/6 2950	12/6 3720	12/6 4570	Corrugated floors and monorail supports are required if Dia. and number of rings are in bottom unshaded area.				
28						12/6 950	12/6 1160	12/6 1410	12/6 1670	12/6 1960	12/6 2260	12/6 2600	12/6 2950	12/6 3720						
29						12/6 950	12/6 1160	12/6 1410	12/6 1670	12/6 1960	SUPPORT SPACING SUPPORT QUANTITY									

* For Aeration Systems recessed in the concrete, add one (1) ring for proper spacing.

When using FL-3102-3 or FL-3102-6 (3", 6") Grandstands, increase the listed quantities by 33% (Standard Quantity x 1.33).

Quantities of Grandstands are minimum required for installation - Due to varying conditions and construction techniques at floor and wall penetrations, additional supports may need to be ordered.

How to read the chart: For example, a 12' diameter bin with 7 rings would have spacing of 54/27 (the top numbers). Meaning A=54" and B=27". The number of supports needed would be 62, (the bottom number).

11. 20 Gauge Floor Support Requirements

20 Gauge Grandstand Chart - 4.00" Corrugation

Wide/4.00" Corrugation - 20 Gauge Grandstand Floor Support Chart

Full Floor Supports Required for Plank Type Flooring 4.00" Corrugation (* Based upon 13.5" or taller floor heights)																				
Rings	12	15	18	21	24	27	30	33	36	39	42	45	48	54	60	72	75	78	90	105
	SUPPORT SPACING SUPPORT QUANTITY														All floor styles OK for bin sizes in upper shaded area.					
3	54/27 62	58/29 80	54/27 120	52/26 150	56/28 202	54/27 249	50/25 333	50/25 390	50/25 470	50/25 576	46/23 695	52/26 735	48/24 869							
4	54/27 62	54/27 88	54/27 120	52/26 160	52/26 214	48/24 275	50/25 333	50/25 390	50/25 470	50/25 576	46/23 695	48/24 775	48/24 869	46/23 1156	44/22 1430					
5	54/27 62	52/26 96	48/24 138	50/25 168	48/24 224	48/24 275	48/24 347	46/23 425	44/22 523	46/23 606	46/23 695	44/22 836	44/22 933	42/21 1236	42/21 1477					
6	48/24 70	48/24 100	48/24 138	46/23 182	46/23 230	44/22 303	44/22 363	44/22 435	44/22 523	42/21 656	42/21 751	42/21 866	42/21 977	40/20 1296	38/19 1650	18 Gauge COR-LOK or CUT-LOK if Dia. and number of Rings are in middle unshaded area.				
7	42/21 75	42/21 110	42/21 144	42/21 190	42/21 249	42/21 309	42/21 387	40/20 480	40/20 565	40/20 686	38/19 821	38/19 946	38/19 1057	36/18 1416	34/17 1779					
8	42/21 75	42/21 110	42/21 144	42/21 190	40/20 265	40/20 319	38/19 417	36/18 525	36/18 620	36/18 746	34/17 900	34/17 1036	34/17 1163	32/16 1566	32/16 1883					
9	38/19 80	40/20 115	38/19 166	38/19 220	38/19 277	36/18 355	34/17 471	34/17 555	32/16 695	32/16 830	32/16 951	30/15 1156	30/15 1303	30/15 1660	28/14 2160	28/15 3550	24/12 3850	24/12 4160	22/11 5970	20/10 8820
10	36/18 90	34/17 130	34/17 180	34/17 230	34/17 300	34/17 380	32/16 500	32/16 600	30/15 750	28/14 930	30/15 1010	28/14 1230	28/14 1390	26/13 1870	24/12 2460	22/11 3820	22/11 4150	22/11 4480	20/10 6480	18/9 9680
11	32/16 95	30/15 150	32/16 190	32/16 250	32/16 320	32/16 400	30/15 520	30/15 650	28/14 790	26/13 990	26/13 1140	24/12 1400	24/12 1590	24/12 2000	22/11 2650	20/10 4150	20/10 4500	20/10 4870	18/9 7120	16/8 10760
12	28/14 100	28/14 160	28/14 210	28/14 280	28/14 360	28/14 450	28/14 550	28/14 670	26/13 840	24/12 1060	24/12 1220	22/11 1510	22/11 1710	20/10 2350	20/10 2880	18/9 4550	18/9 4950	18/9 5340	16/8 7910	16/8 10760
13	26/13 110	26/13 170	26/13 220	26/13 290	24/12 400	24/12 510	24/12 630	24/12 760	24/12 900	22/11 1140	22/11 1320	20/10 1640	20/10 1860	18/9 2570	18/9 3170	16/8 5060	16/8 5500	16/8 5940	16/8 7910	14/7 12150
14			22/11 260	22/11 340	22/11 440	22/11 550	22/11 680	22/11 820	20/10 1060	20/10 1240	20/10 1430	18/9 1800	18/9 2040	16/8 2860	16/8 3520	16/8 5060	16/8 5500	16/8 5940	14/7 8920	14/7 12150
15				20/10 370	20/10 480	20/10 600	20/10 740	20/10 890	20/10 1060	18/9 1360	18/9 1570	18/9 1800	16/8 2270	16/8 2860	16/8 3520	14/7 5710	14/7 6200	14/7 6710	14/7 8920	12/6 13990
16				18/9 400	18/9 520	18/9 660	18/9 810	18/9 970	18/9 1160	18/9 1360	18/9 1570	16/8 2000	16/8 2270	16/8 2860	14/7 3970	12/6 6580	12/6 7140	12/6 7730	12/6 10280	
17	CUT-LOK only if Dia. and number of Rings are in bottom shaded area.				16/8 580	16/8 730	16/8 900	16/8 1080	16/8 1290	16/8 1510	16/8 1750	16/8 2000	16/8 2270	14/7 3230	14/7 3970	12/6 6580	12/6 7140	12/6 7730		
18					16/8 580	16/8 730	16/8 900	16/8 1080	16/8 1290	16/8 1510	16/8 1750	16/8 2000	14/7 2560	14/7 3230	12/6 4570					
19						14/7 820	14/7 1010	14/7 1220	14/7 1450	14/7 1700	14/7 1970	14/7 2260	14/7 2560	12/6 3720	12/6 4570					
20						12/6 950	12/6 1160	12/6 1410	12/6 1670	12/6 1960	12/6 2270	12/6 2600	12/6 2950	12/6 3720						
21						12/6 950	12/6 1160	12/6 1410	12/6 1670	12/6 1960	12/6 2270	12/6 2600	12/6 2950							
22																				
23																				

* For Aeration Systems recessed in the concrete, add one (1) ring for proper spacing.

When using FL-3102-3 or FL-3102-6 (3", 6") Grandstands, increase the listed quantities by 33% (Standard Quantity x 1.33).

Quantities of Grandstands are minimum required for installation - Due to varying conditions and construction techniques at floor and wall penetrations, additional supports may need to be ordered.

How to read the chart: For example, a 12' diameter bin with 5 rings would have spacing of 54/27 (the top numbers). Meaning A=54" and B=27". The number of supports needed would be 62, (the bottom number).

Stiffener Flashing Support Instructions for Internal Universal Stiffeners

1. Install the floor and support system, cutting the floor to go around the internal stiffeners as required.
2. Break the stiffener flashing support (SS-6984) into its three (3) components.
3. Lay the flashing supports on top of the flooring and weld the flashing supports to the stiffener as close as possible. Fasten the flashing to the wall, flashing support, and floor. Seal all spaces by welding or caulking.
4. Paint all welds with good quality zinc rich paint.
5. Stiffener flashing supports (SS-6984) must be ordered separately from the standard floor and flashing.

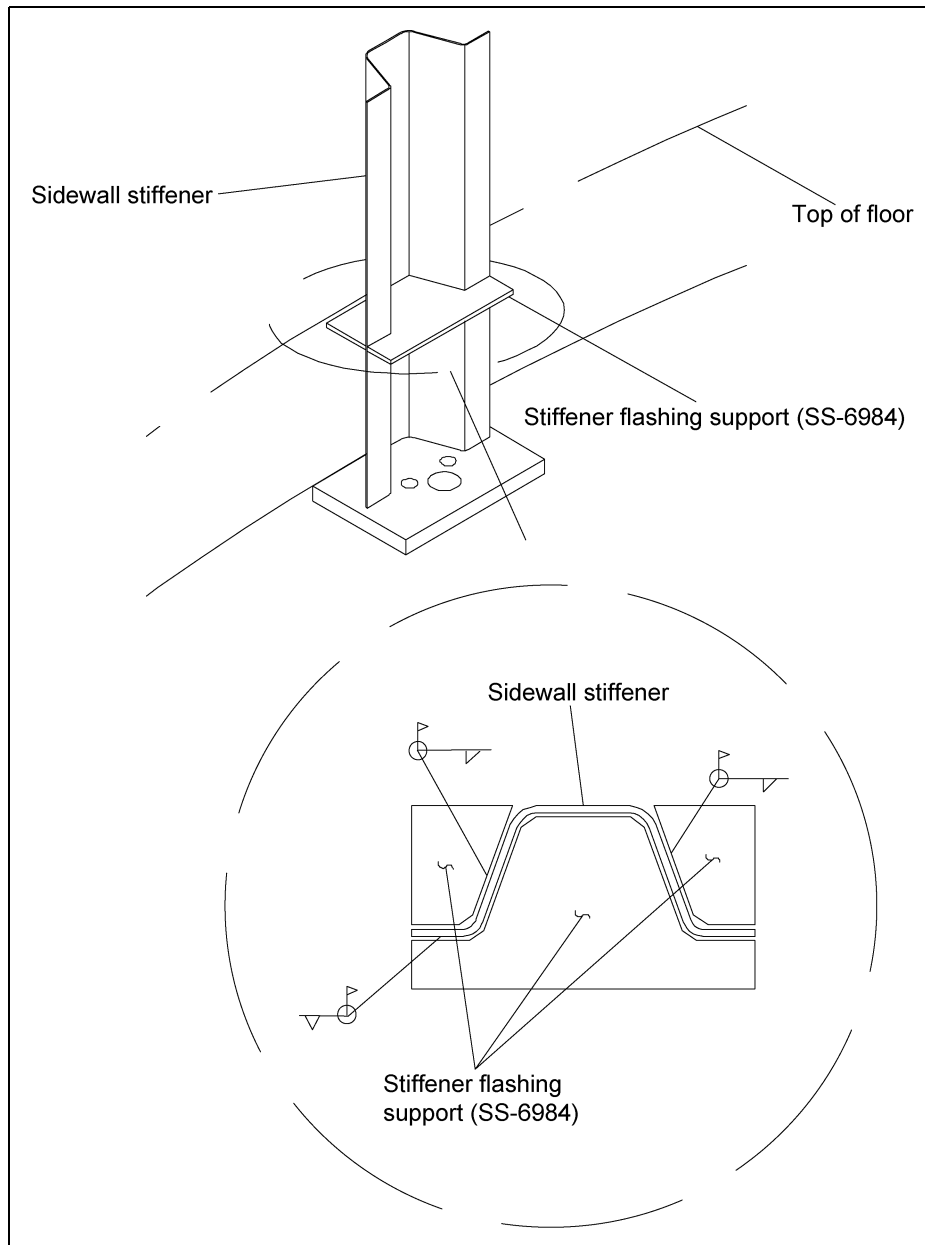

Figure 12A

Installation of Air Flow Supports

1. Determine the spacing and quantity of air flow supports required from the chart [on Page 32](#). Make sure that the correct supports have been ordered for use with the proper depth of plank (either 1-1/8" or 1-3/8" deep).
2. Mark center of bin.
3. Install discharge auger.
4. Mark spacing lines parallel to discharge auger.
5. Start on the side of the bin opposite from the discharge auger and place the first two rows of supports on the spacing lines. Note that air flow supports are installed at an angle in an overlapping pattern so the ends will overlap. See floor layouts in [Figure 13B on Page 33](#).
6. Install the channel lock flooring on the first two rows of supports and secure in place with bin wall flashing.
7. Finish placing supports on the spacing lines and installing floor planks.
 - a. Single supports are used next to the bin wall and at the ends of split floor planks in order to maintain the floor manufacturer's recommended minimum distance from the end of a plank to a support.
 - b. Double supports are used at the sump and along the sides of the discharge auger for spacing of 16" or less and for recirculating bin equipment.
 - c. Full supports may have to be overlapped or angled to provide support at walls and to maintain spacing and flashing requirements.

13. Air Flow Support Instructions

The following *Figure 13A* show methods of support placement to achieve the necessary spacing close to discharge augers and sumps.

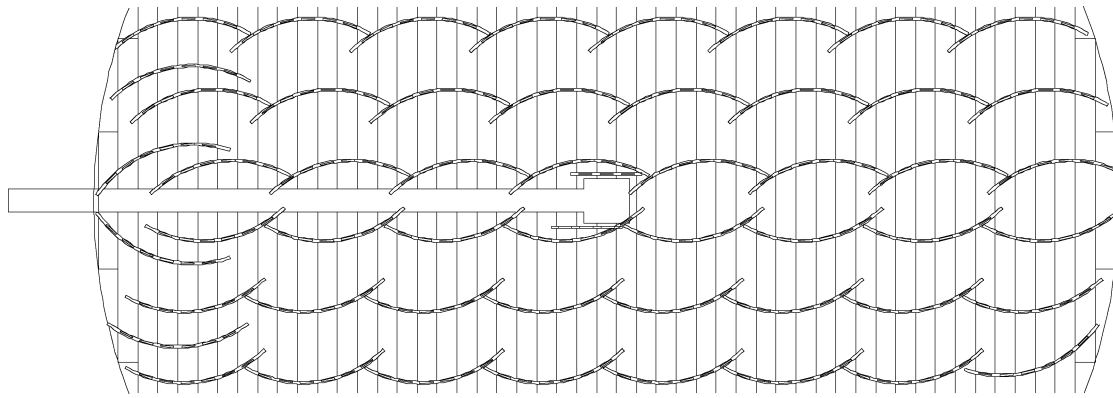

24"-30" Spacing

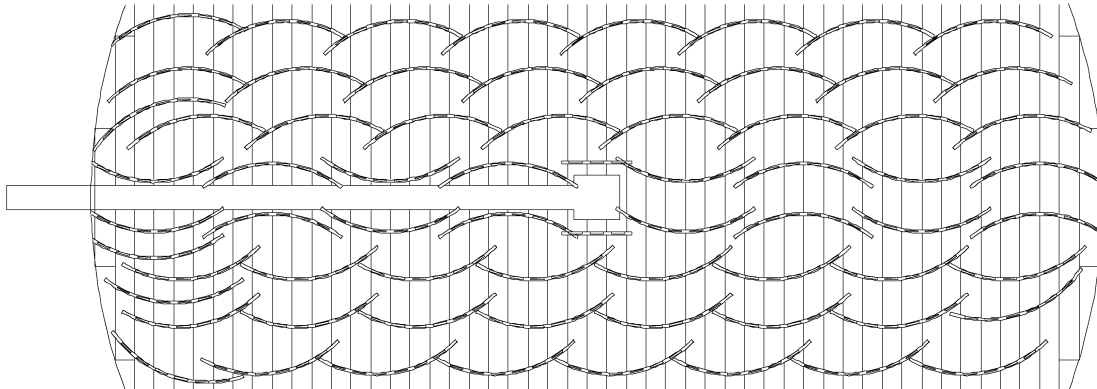

16"-24" Spacing

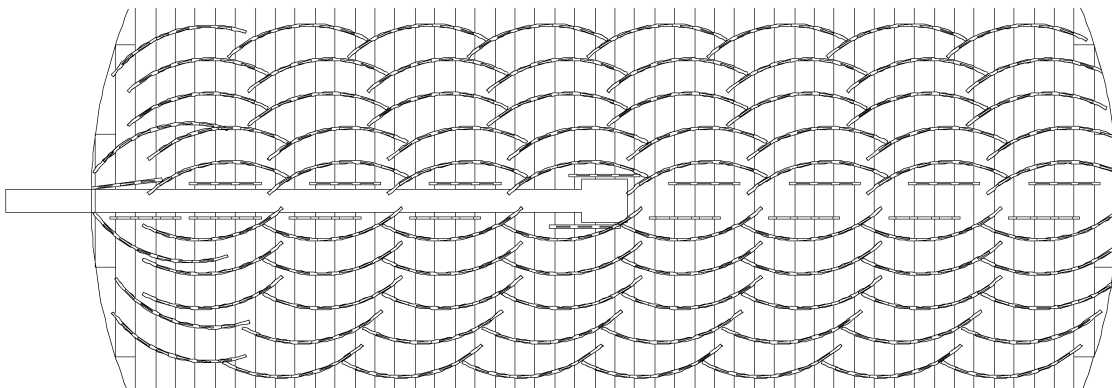

Under 16" spacing

Figure 13A

13. Air Flow Support Instructions

*** Installation, Spacing and Quantities of Air Flow Supports Under Channel Lock Floors**

Bin Diameter - Number of Supports																
Grain Depth at Bin Wall (ft.)	Spacing (in.)	18 Ft. Dia.			21 Ft. Dia.			24 Ft. Dia.			27 Ft. Dia.			30 Ft. Dia.		
		Full	Double	Single	Full	Double	Single	Full	Double	Single	Full	Double	Single	Full	Double	Single
18'	30"	34	2	8	48	2	10	60	2	12	84	2	14	88	2	14
24'	26"	36	2	8	56	2	10	74	2	12	92	2	14	104	2	14
27'	24"	44	2	8	62	2	10	76	2	12	92	2	14	112	2	14
32'	20"	54	2	10	64	2	12	84	2	14	106	2	16	130	2	18
40'	16"	58	10	14	80	12	16	104	14	18	128	16	20	160	18	22
48'	13"	72	10	16	98	12	20	126	14	22	158	16	24	190	18	28
53'	12"	76	10	18	106	12	22	140	14	24	172	16	28	210	18	30
68'	10"	86	10	22	116	12	26	156	14	28	212	16	32	250	18	36
16'	24" and 12"	68	10	8	82	12	10	104	14	12	120	16	14	140	18	14

(for Grain Flow)

Bin Diameter - Number of Supports																
Grain Depth at Bin Wall (ft.)	Spacing (in.)	33 Ft. Dia.			36 Ft. Dia.			42 Ft. Dia.			48 Ft. Dia.			60 Ft. Dia.		
		Full	Double	Single	Full	Double	Single	Full	Double	Single	Full	Double	Single	Full	Double	Single
18'	30"	116	2	16	136	2	18	172	2	20	Use 24" Spacing			Use 24" Spacing		
24'	26"	124	2	16	144	2	18	200	2	20	Use 24" Spacing			Use 24" Spacing		
27'	24"	136	2	16	154	2	18	212	2	20	274	2	22	422	2	30
32'	20"	150	2	20	184	2	22	242	2	26	326	2	28	498	2	36
40'	16"	192	20	24	234	22	28	314	24	32	410	28	36	620	34	46
48'	13"	238	20	30	278	22	34	368	24	38	488	28	44	762	34	56
53'	12"	262	20	34	306	22	36	416	24	42	534	28	48	838	34	60
68'	10"	296	20	40	356	22	44	478	24	50	652	28	58	1024	34	72
16'	24" and 12"	168	20	16	188	20	18	264	24	20	350	28	20	N/A	N/A	N/A

(for Grain Flow)

Notes:

1. Use a maximum spacing of 16" for perforated corrugated flooring.
2. The number of supports listed is based on the maximum peaked capacity of each bin.
3. Use extra single supports for split floors.
4. Extra supports are required for grain recirculating equipment. Use the manufacturer's recommendation for the number and spacing of extra supports. **NOTE:** For grain flows, air flow supports are doubled in a 14' diameter in the center of the floor.
5. Contact a representative for air flow supports required for larger bins and deeper grain depths.
6. * Increase the number of supports by 5% when used with 6-3/4" wide mfs floor planks.

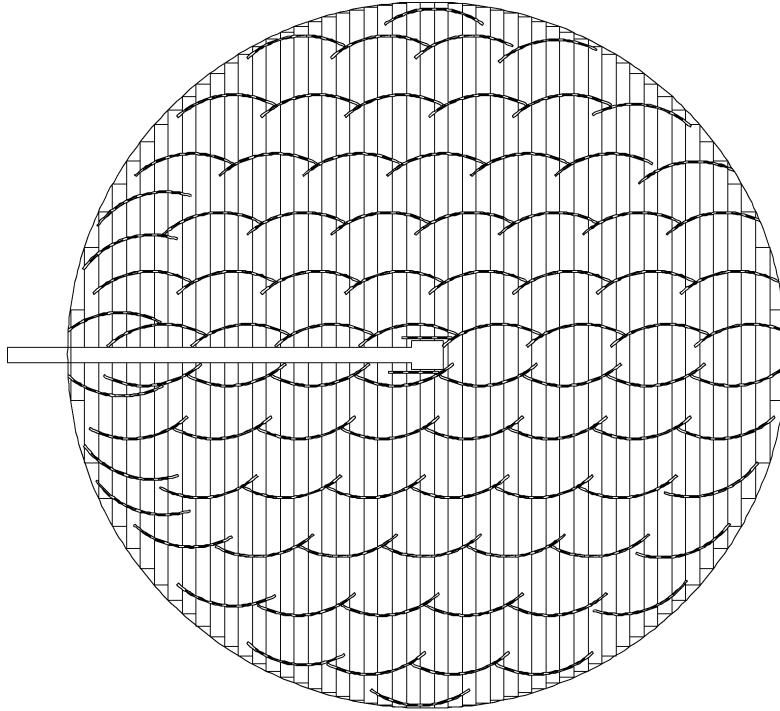

Example showing 30" spacing

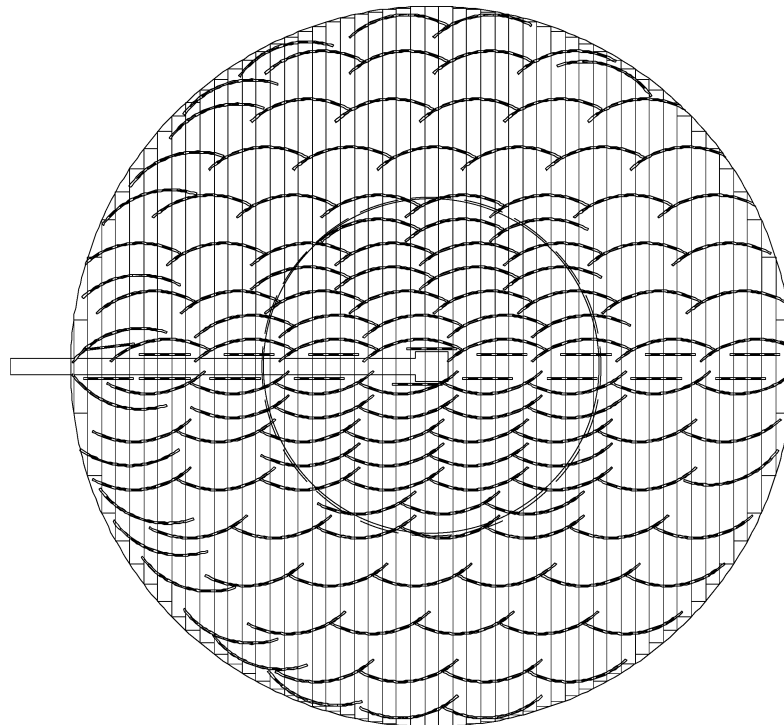

Example showing 24" spacing with supports doubled (12" spacing) in the center for recirculating equipment.

Figure 13B

13. Air Flow Support Instructions

Installation, Spacing and Quantities of Air Flow Supports Under Channel Lock Floors York and Chief Bins

Bin Diameter - Number of Supports																
Grain Depth at Bin Wall (ft.)	Spacing (in.)	15' 6"			18' 7"			21' 8"			24' 9"			27' 10"		
		Full	Double	Single	Full	Double	Single	Full	Double	Single	Full	Double	Single	Full	Double	Single
18'	30"	26	2	8	36	2	8	50	2	10	64	2	12	80	2	14
24'	26"	30	2	8	42	2	8	56	2	10	74	2	12	92	2	14
27'	24"	32	2	8	44	2	8	60	2	10	78	2	12	98	2	14
32'	20"	38	2	10	52	2	10	72	2	12	92	2	14	116	2	16
40'	16"	46	10	14	64	12	14	86	14	16	114	14	18	142	16	20
48'	13"	54	10	16	78	12	16	106	14	20	136	14	22	172	16	24
53'	12"	58	10	18	84	12	18	114	14	22	148	14	24	184	16	28
68'	10"	70	10	22	98	12	22	134	14	26	174	14	28	220	16	32
16'	24" and 12"	60	10	8	72	12	8	88	14	10	106	14	12	126	16	14

(for Grain Flow)

Bin Diameter - Number of Supports																
Grain Depth at Bin Wall (ft.)	Spacing (in.)	31'			34'			37' 1"			40' 3"			43' 4"		
		Full	Double	Single	Full	Double	Single	Full	Double	Single	Full	Double	Single	Full	Double	Single
18'	30"	98	2	14	116	2	16	136	2	18	160	2	20	182	2	22
24'	26"	112	2	14	132	2	16	154	2	18	182	2	20	208	2	22
27'	24"	120	2	14	142	2	16	166	2	18	196	2	20	224	2	22
32'	20"	140	2	18	168	2	20	198	2	22	232	2	26	260	2	26
40'	16"	174	18	22	208	20	24	244	22	28	286	24	32	330	26	32
48'	13"	210	18	28	252	20	30	298	22	34	350	24	38	402	26	38
53'	12"	228	18	30	272	20	34	316	22	36	378	24	42	434	26	42
68'	10"	270	18	36	324	20	40	384	22	44	450	24	50	520	26	50
16'	24" and 12"	148	18	14	170	20	16	194	22	18	224	24	20	252	26	22

(for Grain Flow)

Bin Diameter - Number of Supports											
Grain Depth at Bin Wall (ft.)	Spacing (in.)	49' 6"			55' 8"			61' 10"			
		Full	Double	Single	Full	Double	Single	Full	Double	Single	
18'	24"	288	2	28	362	2	32	444	2	36	
24'	20"	346	2	28	436	2	32	536	2	36	
27'	20"	346	2	28	436	2	32	536	2	36	
32'	20"	346	2	28	436	2	32	536	2	36	
40'	16"	428	28	36	540	32	42	664	36	46	
48'	13"	524	28	44	660	32	52	812	36	56	
53'	12"	566	28	48	714	32	54	878	36	60	
68'	10"	676	28	58	852	32	68	1050	36	72	

**Installation, Spacing and Quantities of Air Flow Supports
Under Channel Lock Floors Behlen Bins**

Bin Diameter - Number of Supports													
Grain Depth at Bin Wall (ft.)	Spacing (in.)	16' 5"			19' 8"			22' 11"			26' 3"		
		Full	Double	Single	Full	Double	Single	Full	Double	Single	Full	Double	Single
18'	30"	30	2	8	42	2	10	56	2	12	70	2	14
24'	26"	32	2	8	46	2	10	64	2	12	80	2	14
27'	24"	36	2	8	50	2	10	68	2	12	86	2	14
32'	20"	42	2	10	60	2	12	80	2	14	102	2	16
40'	16"	50	10	14	72	12	16	98	14	18	124	16	20
48'	13"	60	10	16	88	12	20	118	14	22	152	16	24
53'	12"	66	10	18	94	12	22	126	14	24	164	16	28
68'	10"	78	10	22	110	12	26	150	14	28	194	16	32
16'	24" and 12"	64	10	8	78	12	10	96	14	12	114	16	14

(for Grain Flow)

Bin Diameter - Number of Supports													
Grain Depth at Bin Wall (ft.)	Spacing (in.)	29' 6"			36' 1"			42' 8"			49' 3"		
		Full	Double	Single	Full	Double	Single	Full	Double	Single	Full	Double	Single
18'	30"	90	2	14	130	2	18	178	2	20	* 286	2	28
24'	26"	102	2	14	148	2	18	202	2	20	* 286	2	28
27'	24"	108	2	14	160	2	18	218	2	20	**344	2	28
32'	20"	128	2	18	188	2	22	260	2	26	344	2	28
40'	16"	158	18	22	232	22	28	320	24	32	426	28	36
48'	13"	192	18	28	282	22	34	390	24	38	520	28	44
53'	12"	206	18	30	306	22	36	422	24	42	562	28	48
68'	10"	246	18	36	364	22	44	504	24	50	670	28	58
16'	24" and 12"	136	18	14	188	22	18	246	24	20	N/A	N/A	N/A

(for Grain Flow)

* Use 24" Spacing
 ** Use 20" Spacing

NOTES

The GSI Group Warranty

THE GSI GROUP (GSI) WARRANTS ALL PRODUCTS WHICH IT MANUFACTURES TO BE FREE OF DEFECTS IN MATERIAL AND WORKMANSHIP UNDER NORMAL USAGE AND CONDITIONS FOR A PERIOD OF 12 MONTHS AFTER RETAIL SALE TO THE ORIGINAL END USER. THE PURCHASER'S SOLE REMEDY AND GSI'S ONLY OBLIGATION SHALL BE TO REPAIR OR REPLACE, AT GSI'S OPTION AND EXPENSE, PRODUCTS THAT, IN GSI'S SOLE JUDGMENT, CONTAIN A MATERIAL DEFECT DUE TO MATERIALS OR WORKMANSHIP. ALL DELIVERY AND SHIPMENT CHARGES TO AND FROM GSI'S FACTORY WILL BE PURCHASER'S RESPONSIBILITY. EXPENSES INCURRED BY OR ON BEHALF OF THE PURCHASER WITHOUT PRIOR WRITTEN AUTHORIZATION FROM AN AUTHORIZED EMPLOYEE OF GSI SHALL BE THE SOLE RESPONSIBILITY OF THE PURCHASER.

EXCEPT FOR THE LIMITED WARRANTY EXPRESSED ABOVE, GSI MAKES NO FURTHER WARRANTY OF ANY KIND, EXPRESS OR IMPLIED, INCLUDING, WITHOUT LIMITATION, WARRANTIES OF MERCHANTABILITY OR FITNESS FOR A PARTICULAR PURPOSE OR USE IN CONNECTION WITH (I) PRODUCT MANUFACTURED OR SOLD BY GSI OR (II) ANY ADVICE, INSTRUCTION, RECOMMENDATION OR SUGGESTION PROVIDED BY AN AGENT, REPRESENTATIVE OR EMPLOYEE OF GSI REGARDING OR RELATED TO THE CONFIGURATION, INSTALLATION, LAYOUT, SUITABILITY FOR A PARTICULAR PURPOSE, OR DESIGN OF SUCH PRODUCTS.

GSI SHALL NOT BE LIABLE FOR ANY DIRECT, INDIRECT, INCIDENTAL OR CONSEQUENTIAL DAMAGES, INCLUDING, WITHOUT LIMITATION, LOSS OF ANTICIPATED PROFITS OR BENEFITS. PURCHASER'S SOLE AND EXCLUSIVE REMEDY IS AS SET FORTH IN THE LIMITED WARRANTY EXPRESSED ABOVE, WHICH SHALL NOT EXCEED THE AMOUNT PAID FOR THE PRODUCT PURCHASED. THIS WARRANTY IS NOT TRANSFERABLE AND APPLIES ONLY TO THE ORIGINAL PURCHASER. GSI SHALL HAVE NO OBLIGATION OR RESPONSIBILITY FOR ANY REPRESENTATIONS OR WARRANTIES MADE BY OR ON BEHALF OF ANY DEALER, AGENT OR DISTRIBUTOR OF GSI.

GSI ASSUMES NO RESPONSIBILITY FOR CLAIMS RESULTING FROM ERECTION DEFECTS OR UNAUTHORIZED MODIFICATIONS TO PRODUCTS WHICH IT MANUFACTURED. MODIFICATIONS TO PRODUCTS NOT SPECIFICALLY DELINEATED IN THE MANUAL ACCOMPANYING THE EQUIPMENT AT INITIAL SALE WILL NULLIFY THE PRODUCT WARRANTY THAT MIGHT HAVE BEEN OTHERWISE AVAILABLE.

THE FOREGOING WARRANTY SHALL NOT EXTEND TO PRODUCTS OR PARTS WHICH HAVE BEEN DAMAGED BY NEGLIGENT USE, MISUSE, ALTERATION OR ACCIDENT. THIS WARRANTY EXTENDS SOLELY TO ONLY PRODUCTS MANUFACTURED BY GSI. THIS WARRANTY IS EXCLUSIVE AND IN LIEU OF ALL OTHER WARRANTIES EXPRESS OR IMPLIED. GSI RESERVES THE RIGHT TO MAKE DESIGN OR SPECIFICATION CHANGES AT ANY TIME.

PRIOR TO INSTALLATION, PURCHASER HAS THE RESPONSIBILITY TO COMPLY WITH ALL FEDERAL, STATE AND LOCAL CODES WHICH MAY APPLY TO THE LOCATION AND INSTALLATION OF PRODUCTS MANUFACTURED OR SOLD BY GSI.

This equipment shall be installed in accordance with the current installation codes and applicable regulations which should be carefully followed in all cases. Authorities having jurisdiction should be consulted before installations are made.

G S I G R O U P



GSI Group
1004 E. Illinois St.
Assumption, IL 62510-0020
Phone: 1-217-226-4421
Fax: 1-217-226-4420
www.gsiag.com