

USER MANUAL

RAIS Q-BIC

&

RAIS Q-BIC INSERT



We cannot be held responsible for any misprints.

RAIS Q-BIC

RAIS Q-BIC insert

Date: March 2008

Modified: C

INTRODUCTION	4
WARRANTY	4
SPECIFICATIONS.....	5
CONVECTION	6
INSTALLATION INSTRUCTIONS.....	7
CHIMNEY	8-9
INSTALLATION.....	10
INSTALLATION OF Q-BIC INSERT.....	12-19
INSTALLATION DISTANCE IN CASE OF NON-COMBUSTIBLE WALL.....	20
INSTALLATION DISTANCE IN CASE OF COMBUSTIBLE WALL	20-22
GENERAL INSTALLATION	21
(RIGHT ANGLE) SECURE BASE	21
CORNER INSTALLATION 45°	22
360° SWIVEL BASE.....	22
FOR THE INSTALLER	23
OPERATING INSTRUCTIONS.....	24
FUEL	24
DRYING AND STORAGE	25
REGULATION OF COMBUSTION AIR	25
USING THE WOOD BURNING STOVE.....	26
ADJUSTMENT OF AIR DAMPER	26-27
CONTROL	27
FIRST USAGE.....	28
LIGHTING AND FUELLING.....	29-30
CLEANING AND CARE	31
CLEANING OF THE FLUE WAYS	32
INTERRUPTION OF OPERATION.....	33
ACCESSORIES AND SPARE PARTS.....	34
SPARE PARTS DIAGRAMS Q-BIC 106.....	34-35
SPARE PARTS DIAGRAMS Q-BIC 127	36-37
SPARE PARTS DIAGRAMS Q-BIC insert	36-39

Introduction

Thank you for purchasing a RAIS wood burning stove. In the UK the stove has been approved by HETAS Ltd as an intermittent operating appliance for burning wood logs only.

A RAIS wood burning stove is more than just a heat source: it also shows that you care about design and quality in your home.

To make the most of your wood burning stove it is important that you read the manual thoroughly, before installing and using it.

In the case of warranty coverage, and for general queries regarding your wood burning stove, it is important that you know the stove's production number. We therefore recommend that you note down the number in the table below. The production number is located on the back of the stove at the bottom.

Warranty

Your RAIS wood burning stove comes with a 5 year warranty. The warranty, however, does not cover heat-insulating materials, glass and seals. Any alterations made to the stove will void the warranty.

RAIS A/S	
Industrivej 20, Vangen 9900 Frederikshavn	
○	○
Prod.nr.	<input type="text"/>

Distributor:

Date:

Specifications

	RAIS Q-BIC 106	RAIS Q-BIC 127	RAIS Q-BIC insert
Nominal output (kW):	4,5	4,5	4,5
Min./Max. output(kW):	2-6	2-6	2-6
Heating area (m ²)	ca. 80	ca. 80	ca. 80
Stove's width/depth/height (mm)	404-404-1060	404-404-1270	426-418-850
Combustion chamber's width/depth/height (mm)	288-288-500	288-288-500	288-288-500
Recommended amount of wood when fuelling (kg): (Distributed on 2-3 logs of wood of approx. 25 cm)	1,6	1,6	1,6
Min. uptake (Pascal):	-12	-12	-12
Weight (kg):	143	153	140
Smoke gas mass flow (g/s):	6,3	6,3	6,3
Smoke gas temperature (°C): with Nominal output	253	253	253
Intermittent operation:	Fuelling should be undertaken within 3 hours.		

Convection

RAIS stoves are convection stoves. This means that the stove's back and side panels are not over-heated. Convection means that there is a circulation of air, which ensures that the heat is distributed more evenly throughout the entire room. The cold air is sucked in at the base of the stove up through the convection channel, which runs along the stove's combustion chamber. The heated air pours out at the top of the stove, which ensures a circulation of warm air throughout the room.

The stoves are equipped with a "cold" lever – RAIS special feature – which means you could almost do away with gloves. Be aware, however, that all exterior surfaces become hot during use - so take extreme care.

Installation instructions

The following pages give instructions for the safe and proper installation of this heating appliance in the UK. These instructions cover the basic principles of installation, although detail may need slight modification to suit particular local site conditions. In all cases the installation must comply with current UK Building Regulations, Local Authority Byelaws and other specifications or regulations as they affect the installation of the stove. Please note that it is a legal requirement under England and Wales Building Regulations that the installation of the stove is either carried out under Local Authority Building Control approval or is installed by a Competent Person registered with a Government approved Competent Persons Scheme. HETAS Ltd operate such a Scheme and a listing of their Registered Competent Persons can be found on their website at www.hetas.co.uk.

It should be noted that the current Building Regulations requirements are given in Approved Document J. These requirements may also be met by adopting the relevant recommendations given in British Standards BS 8303, BS 6461 and BS 7566.

WARNING: Health and Safety Advice Notice

The installation of this heating appliance is governed by the Health and Safety at Work Act 1974. It is the responsibility of the installer to ensure that all requirements of this Act are met during the installation works. Attention is drawn in particular to the following:

Handling:

The appliance is a heavy item and adequate facilities must be available for loading, unloading and site handling.

Fire Cement:

Some types of fire cement are caustic and should not be allowed to come into contact with the skin. Protective gloves should be worn when handling fire cement. In case of contact with the skin wash immediately with plenty of water.

Asbestos:

This stove contains no asbestos. If there is a possibility of disturbing any asbestos in the course of installation then please seek specialist guidance and use appropriate protective equipment.

Metal Parts:

When installing or servicing this stove care should be taken to avoid the possibility of personal injury.

Important Warning –Preparatory Work and Safety Checks:

- This stove must not be installed into a chimney that serves any other heating appliance.
- There must not be an extractor fan fitted in the same room as the stove as this can cause the stove to emit fumes into the room.
- If this appliance is installed into an existing chimney, the chimney must first be swept and examined for soundness and suitability before the appliance is installed (see also section headed "Chimney").

Chimney

The chimney is the driving force which makes the stove function. In order for the stove to perform satisfactorily the chimney height must be sufficient to ensure the correct draught of 14 to 18 Pa so as to clear the products of combustion and prevent problems of smoke emanating into the room when firing.

NOTE: A chimney height of not less than 4.5 metres measured vertically from the outlet of the stove to the top of the chimney should be satisfactory. Alternatively the calculation procedure given in BS 5854:1980 may be used as the basis for deciding whether a particular chimney design will provide sufficient draught.

The outlet from the chimney should be above the roof of the building in accordance with the provisions of Building Regulations Approved Document J.

If installation is into an existing chimney then it must be sound and have no cracks or other faults which might allow fumes into the house. Older properties, especially, may have chimney faults or the cross section may be too large i.e. more than 230 mm x 230 mm. Remedial action should be taken, if required, seeking expert advice, if necessary. If it is found necessary to line the chimney then a flue liner suitable for solid fuel must be used in accordance with Building Regulations Approved Document J.

Any existing chimney must be clear of obstruction and have been swept clean immediately before installation of the stove. If the stove is fitted in place of an open fire then the chimney should be swept one month after installation to clear any soot falls which may have occurred due to the difference in combustion between the stove and the open fire.

If there is no existing chimney then either a prefabricated block chimney in accordance with Building Regulations Approved Document J or a twin walled insulated stainless steel flue to BS 4543 can be used. These chimneys must be fitted in accordance with the manufacturer's instructions and Building Regulations.

A single wall metal fluepipe is suitable for connecting the stove to the chimney but is not suitable for using for the complete chimney. The chimney and connecting fluepipe must have a minimum diameter of 150 mm and its dimension should be not less than the size of the outlet socket of the stove which is 150 mm in diameter. Any bend in the chimney or connecting fluepipe should not exceed 45°. 90°bends should not be used.

Combustible material should not be located where the heat dissipating through the walls of fireplaces or flues could ignite it. Therefore when installing the stove in the presence of combustible materials due account must be taken of the guidance on the separation of combustible material given in Building Regulations Approved Document J and also in these stove instructions.

If it is found that there is excessive draught in the chimney then either an adjustable flue damper or alternatively a draught stabiliser should be fitted. The adjustable flue damper should not close off the flue entirely but should in its closed position leave a minimum continuous opening free area of at least 20 % of the total cross sectional area of the flue or fluepipe.

Adequate provision e.g. easily accessible soot door or doors must be provided for sweeping the chimney and connecting fluepipe.

You should also familiarise yourself with the draught conditions for chimneys with 2 flues.

The flue outlet spigot is 150 mm in diameter.

For strong draughts, the chimney or flue should be fitted with a draught stabiliser. In which case, it is important to ensure that there is a free flow-through area of minimum 20 cm² when the regulating gate is shut. Otherwise, the fuel energy may not be used optimally. If, at any time, you are unsure about the condition of the chimney, you should contact a chimney sweep.

Remember that access to the access door should be kept clear.

Installation



It is prohibited to carry out unauthorised alterations to the stove.

There must be plenty of fresh air in the room where the stove is being installed, in order to ensure proper combustion. Note that any mechanical exhaust ventilation - e.g. an extraction hood - may reduce the air supply. Any air grates must be placed in such a manner, that the air supply is not blocked.



Building Regulations Approved document J gives specific guidance on the required permanent ventilation into the room for combustion air of solid fuel appliances.

The floor structure must be able to carry the weight of the wood burning stove, as well as the weight of a chimney, if necessary.

When you choose where to set up your RAIS wood burning stove, you should consider the heat distribution to the other rooms. This will enable you to get the best use out of your stove. The stove should be set up at a safe distance from inflammable materials. See the manufacturer's plate on the wood burning stove.

	
Producent RAIS A/S, Industrivej 20, 9900 Frederikshavn, Danmark 06	
EN 13240:2001+A2:2004 Anordning til intervalfyring	EC.nr. 705
Q-BIC	
Afstand til brændbart, bagvæg	: 350 mm
Afstand til brændbart, sidevæg	: 350 mm
Afstand til brændbart, drejefod : (360°)	: 750 mm
CO emission	: 0,20 %
Røggas temperatur	: 253 °C
Nominel effekt	: 4,5 kW
Virkningsgrad	: 75 %
Brændsel (Brug kun anbefalede brændsler)	: træ
Følg instrukserne i brugermanualen. Anordningen er egnet til røggassamleledning.	
	SINTEF Produktdokumentation 043-152

Manufacturer's Plate for Q-BIC

	
Producent RAIS A/S, Industrivej 20, 9900 Frederikshavn, Danmark 07	
EN 13229:2001+A2:2004 Anordning til intervalfyring	EC.nr. 707
Q-BIC INDSATS	
Anordningen må kun installeres i forbindelse med ubrændbart materiale.	
Afstand til brændbart, sidevæg	: 200 mm
Afstand til brændbart, bagvæg	: 100 mm
CO emission	: 0,20 %
Røggas temperatur	: 253 °C
Nominel effekt	: 4,5 kW
Virkningsgrad	: 75 %
Brændsel (Brug kun anbefalede brændsler)	: træ
Følg instrukserne i brugermanualen. Anordningen er egnet til røggassamleledning.	
	SINTEF Produktdokumentation 043-152

Manufacturer's Plate for Q-BIC insert

Installation instructions - Q-BIC insert

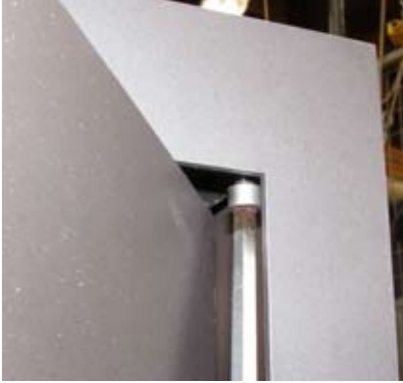

First loosen the screw in upper right corner and the screw in lower left corner (both door side) - do not unscrew entirely - now it's possible to remove the insert from the cassette.



Preparation of cassette

Disassemble the two screws keeping the stiffening rib in position.

By a panelled wall:

Assemble the cassette, the upper covering plate and the stiffening rib with the two screws.



Assembly the topplate with the following self-drilling screws.

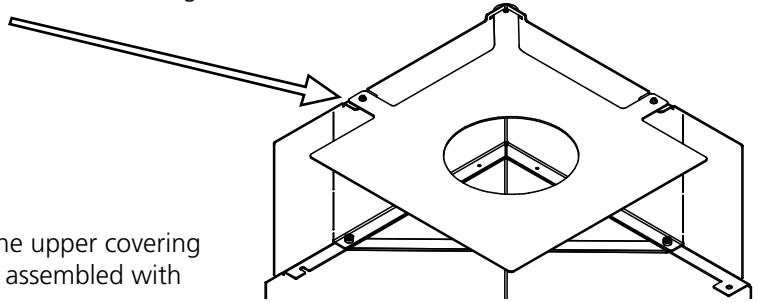

By a brick wall:

The outermost part of the upper covering is broken off before it is assembled with the two screws.

The top plate is not used

NB!!

A 30° bend must always be used for a brick wall.

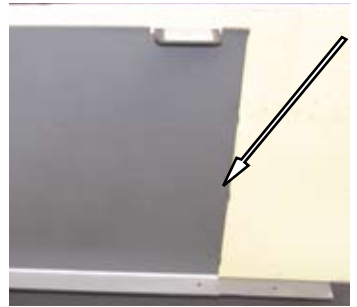

The legs are fixed onto the box and this is then placed in the desired position.

For panelled wall, all 3 legs are used and for brick wall, only the back leg is used.

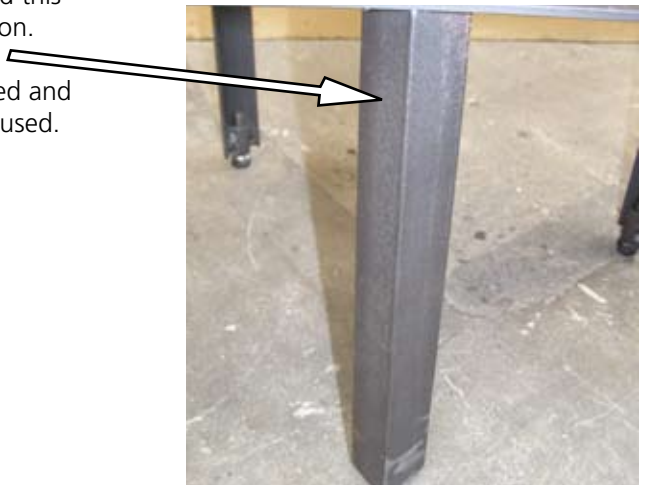

Fitting hole for brick wall

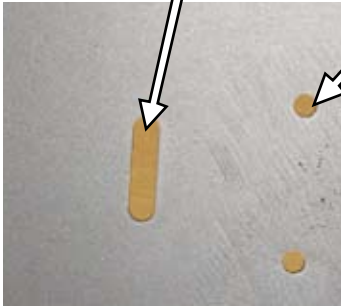

Fitting holes for angle brace for panelled wall.

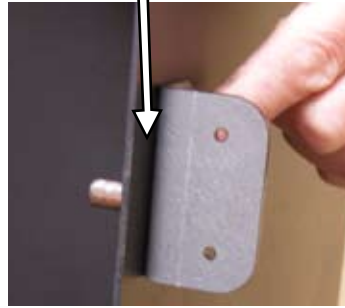

ATTENTION!!

Important that the cassette is position in 90° angel and levelled both horizontal an vertical.

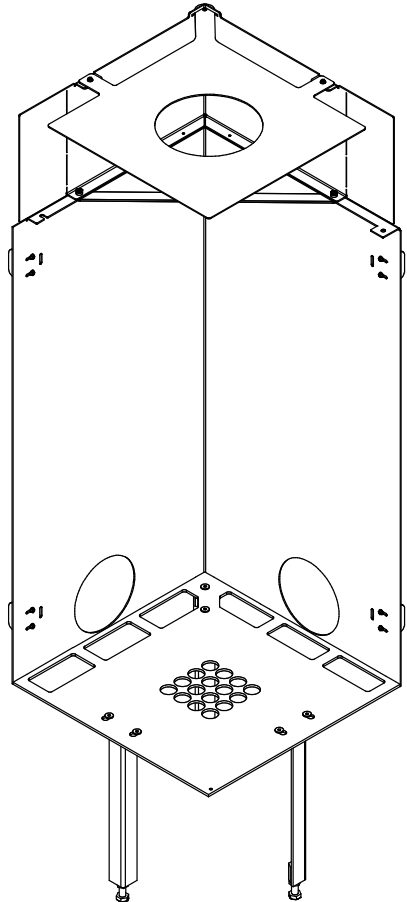

Assembly the stove in cassette

Lift the stove up onto the base plate and place it as shown in the picture on the left.

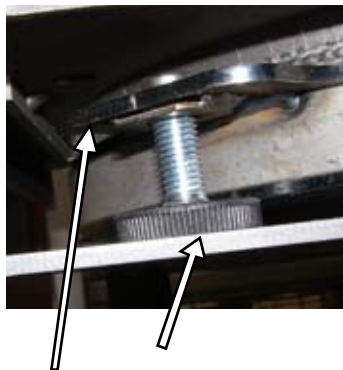

NB!!

Basic settings on the adjusting bolts are approx. 32.5 mm (between the bottom of the stove's base and the base plate on the internal box).

Please note that there may be a need for added adjustment in order for the stove to stand at a level position.

Push the insert until the front is in level with the wall.

Afterwards push the insert from the other side until it is in level with the other wall.

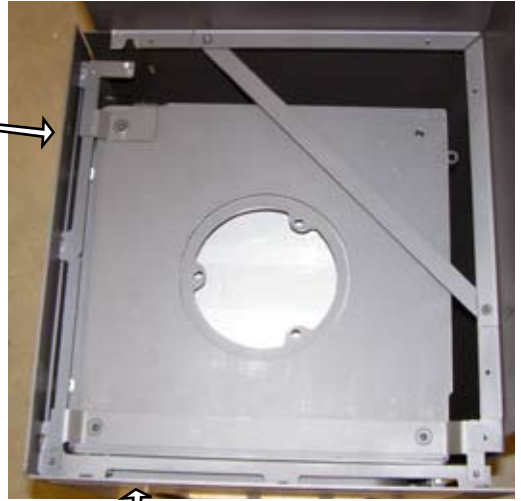

The screws - in upper right corner and lower left corner - you started loosen (page 8), is fastened.

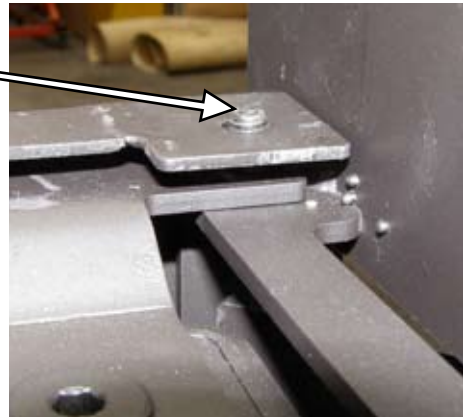
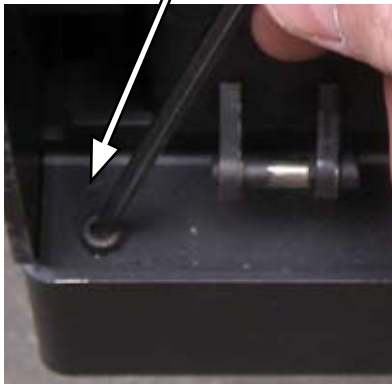
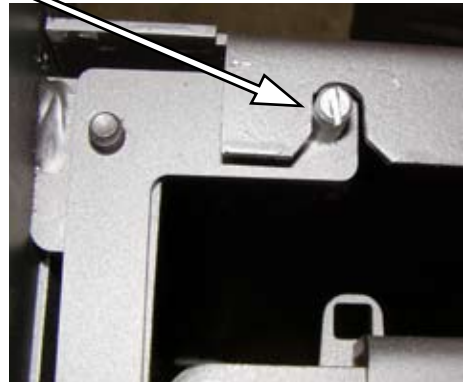



Q-BIC insert

Brick and panelled wall

Mounting distance for panelled wall
- combustible material
(insulation ability such as Aqua panel
(coefficient of thermal conductivity
0.36 W/mk) or better)

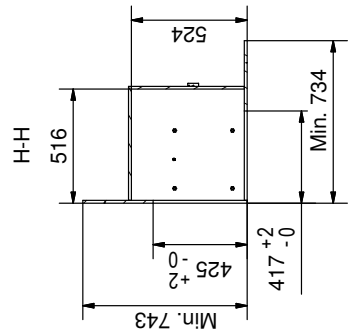
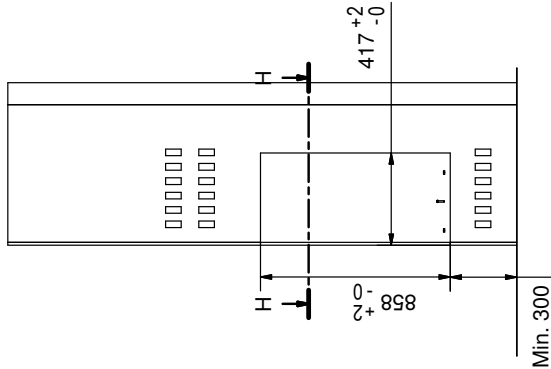
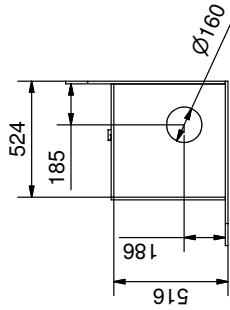
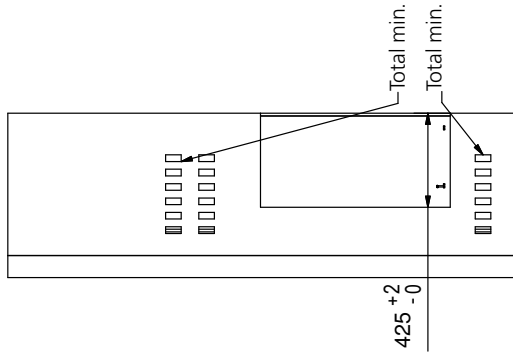
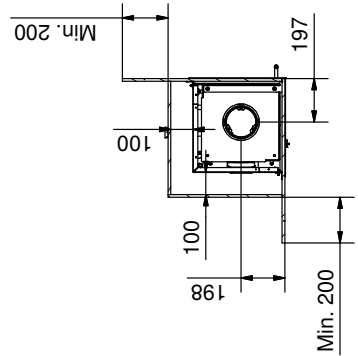
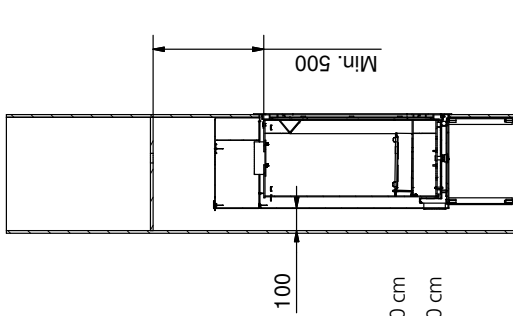
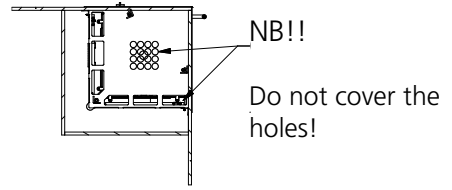

Installation distance in case of non-combustible wall

We recommend a minimum distance to non-combustible material of 50 mm (F) for cleaning considerations.

It should always be possible to access the accessdoor.

Using not insulated smoke pipe, the minimum distance to combustible wall must be 225 mm from smoke pipe.

Installation distance in case of combustible wall

To find out whether the wall next to where the stove is going to be installed is flammable, you should contact your building contractor or the local building authorities.

The hearth should be able to accommodate the weight of the stove. The chimney must be independently supported by wall brackets or a ceiling support plate. The weight of the stove is indicated in the brochure.

The stove should always be installed on a non-combustible hearth of a size and construction that is in accordance with the provisions of the current UK Building Regulations Approved Document J.

If the stove is to be installed on a wooden floor, it must be covered with a noncombustible material at least 12mm thick, in accordance with UK Building Regulations Approved Document J, to a distance of 300 mm in front of the stove and 150 mm to each side measuring from the door of the combustion chamber.

The clearance distances to combustible material beneath, surrounding or upon the hearth and walls adjacent to the hearth should comply with the guidance on the separation of combustible material given in UK Building Regulations Approved Document J and also in these stove instructions.

Normal set-up (right-angle) secure base

A. Distance to furniture 750 mm

Distance to flammable materials:

B. - in front (floor) 300 mm

C. - to the side (floor) 150 mm

D. - to the rear (floor) 350 mm

E. - to the side of the wall 350 mm

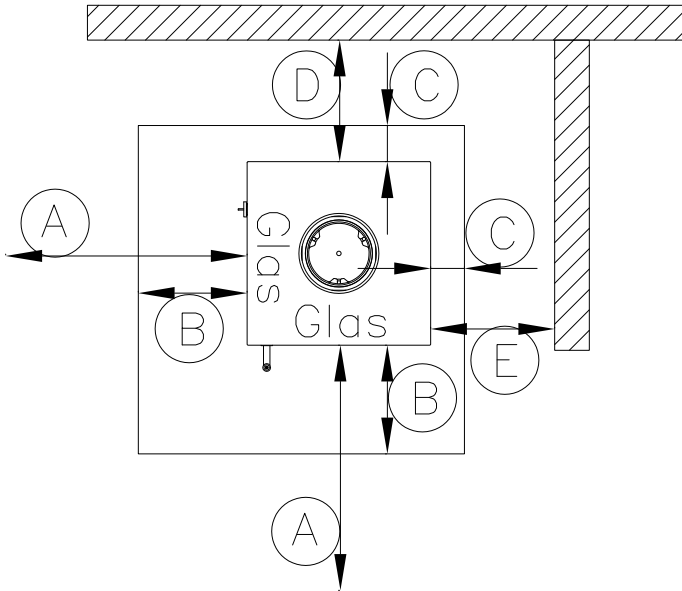

Corner set-up 45° fixed socket

A. Distance to furniture 750 mm

Distance to flammable materials:

- B. - in front (floor) 300 mm
- C. - to the side (floor) 150 mm
- D. - to the rear (wall) 200 mm
- E. - to the side of the wall 500 mm

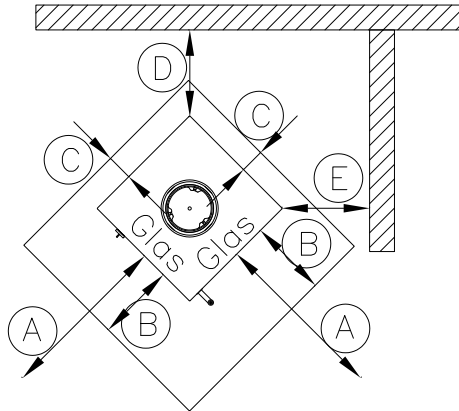

360° swivel base

A. Distance to furniture 750 mm

Distance to flammable materials:

B. - in front (wall) 300 mm

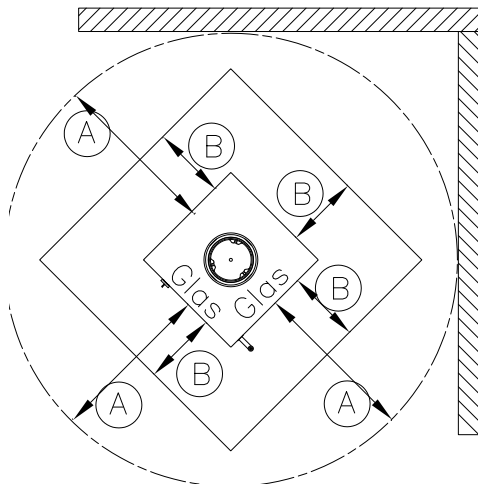

For the Installer

Finally before firing the stove for the first time a check should be made to ensure that the assembly and stove installation has been satisfactory and that there are no leaks in any seals in the appliance and appliance connections to the chimney.

Ensure that the appliance and chimney flue are functioning correctly before finally handing over to the user. If necessary read the later parts of this manual for guidance on care required when first lighting.

Inform the user that the appliance has been commissioned and ready to use and give instruction on the safe operation of the stove.

These Instructions must be left with the user and the user should be instructed to keep them in a safe place.

Operating instructions

Please note that HETAS Approval only covers the use of wood in the stove and approval does not cover the use of other fuels either alone or mixed with other fuels, nor does it cover instructions for the use of other fuels.

Fuel

The stove is designed and approved in accordance with EN 13240 and NS 3058 for stoking split, dried firewood. The firewood must have a water content of 15-22% and its max. length should be the length of the combustion chamber minus 50-60 mm.

Stoking with wet firewood causes both soot, environmental pollution and bad fuel economy. Freshly cut wood contains approx. 50-70% water and is thoroughly unsuitable for stoking. Count min. 1 year of storage time for newly cut wood before using. Wood with a diameter of more than 100 mm should be split. Regardless of wood size, it should always have at least one surface area free of bark.

We do not recommend stoking with painted, laminated or impregnated wood, wood with a synthetic surface, painted refuse wood, chipboard, plywood, domestic waste, paper briquettes and pit coal, as this will produce malodorous smoke, which could be poisonous.

When firing with the above-mentioned items and amounts larger than those recommended, the stove is subjected to a larger amount of heat, which results in a higher chimney temperature and lower efficiency. This can result in the stove and chimney becoming damaged and would void the warranty.

The calorific value of the firewood is closely connected to the moisture level of the firewood. Moist firewood has a low heat value. The more water the wood contains, the more energy it takes for this water to vaporise, resulting in this energy being lost.

ONLY USE RECOMMENDED FUELS

The following table shows the calorific value of different types of wood, which have been stored for 2 years, and which have a residual moisture of 15-17%.

Wood	Kg dry wood pr. m ³	compared to beech/oak
Hornbeam	640	110%
Beech and oak	580	100%
Ash	570	98%
Maple	540	93%
Birch	510	88%
Mountain pine	480	83%
Fir	390	67%
Poplar	380	65%

1 kg of wood yields the same heat energy irrespective of wood type. 1 kg beech merely takes up less space than 1 kg of fir.

Drying and storage

Drying wood takes time: proper air drying takes approx. 2 years.

Here are some tips:

Store the wood sawn, split and stacked in an airy, sunny place, which is protected against rain (the south side of the house is particularly suitable).

Store the firewood stacks at a hand's breadth apart, as this ensures that the air flowing through takes the moisture with it. Avoid covering the firewood stacks with plastic, as this prevents the moisture from escaping. It is a good idea to bring the firewood into the house 2-3 days before you need it.

Regulating the combustion air

All RAIS stoves are equipped with a one-handed operating lever for regulating the damper. The stove-specific regulating mechanisms can be seen on the diagrams.

Primary air is the combustion air added to the primary combustion zone, i.e. the bed of glowing embers. This air, which is cold, is only used in the lighting stage.

Secondary air is the air which is added in the gas combustion zone, i.e. air which contributes to the combustion of the pyrolysis gasses (preheated air, which is used for the cleaner glass system and combustion). This air is sucked through the damper under the combustion chamber and is pre-heated through the side channels and then emitted as hot scavenging air onto the glass. The hot air rinses the glass and keeps it soot-free.

The tertiary channel, which can be seen at the the top of the combustion chamber towards the back, serves to combust the final gas residues.

By setting the interval between position 1 and 2, the energy content in the firewood is used optimally, as there is oxygen for combustion and for the burning of the pyrolysis gasses. When the flames are a clear yellow the damper has been set correctly. Finding the correct position comes with time after you have used for stove for a while.

It is not recommended that you turn it down completely. A mistake commonly made is shutting the damper too early because it feels too hot. This results in dark smoke emanating from the chimney and in the calorific value of the firewood not being used to its fullest.

Using the wood burning stove

Adjustment of the air damper.
The damper has 3 settings.

RAIS Q-BIC

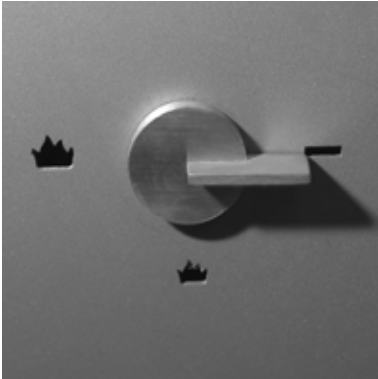

Position 1

The air damper is closed, which means no air supply.

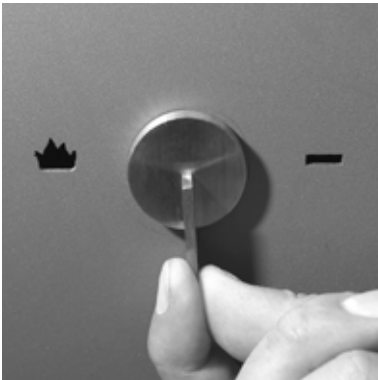

Position 2

Push the handle to the left, to where the marking is.
This position gives full secondary air.

During normal stoking the lever is set between position 1 and 2.

When the flames are clear and yellow, the damper is set correctly, i.e. resulting in a slow/optimal burning.

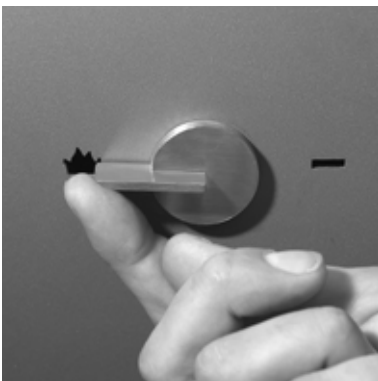

Position 3

Push the handle to the left until stop.

The air damper is completely open and gives full primary and secondary air.

The position is for the lighting stage and is not used under normal operation.

RAIS Q-BIC insert

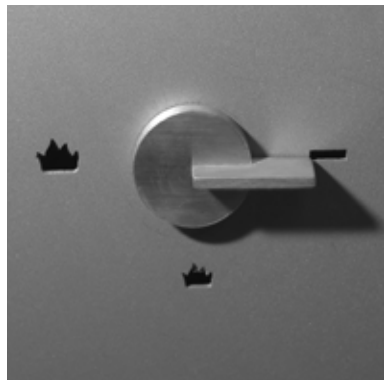

Position 1

The air damper is closed, which means no air supply.

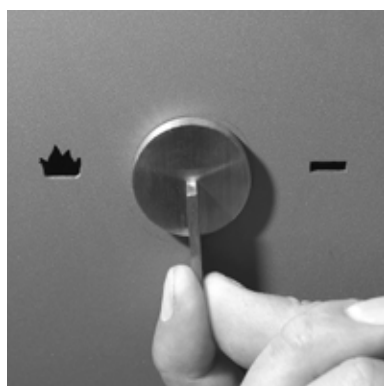

Position 2

Push the handle to the left, to where the marking is.

This position gives full secondary air.

During normal stoking the lever is set between position 1 and 2.

When the flames are clear and yellow, the damper is set correctly, i.e. resulting in a slow/optimal burning.

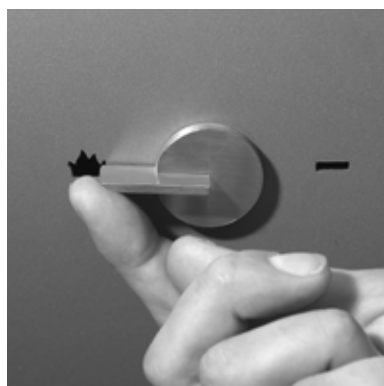

Position 3

Press the handle in, and push it to the left until stop.

The air damper is completely open and gives full primary and secondary air.

The position is for the lighting stage and is not used under normal operation.

Control

If the ash is white and the walls in the combustion chamber soot-free after the stove has been used, the air regulation was set correctly and the wood was sufficiently dry.

First usage

A careful start pays off. Start with a small fire, so that the wood burning stove can get accustomed to the high temperature. This gives the best start and any damage is avoided.

Be aware that a strange but harmless odour and smoke concoction may emanate from the surface of the stove, the first time you fire up. This is because the paint and materials need to harden. The odour disappears quickly, but you should check the ventilation and draught, if possible. See also, the IMPORTANT warning notice below about persistent fumes.

During this process you must be careful not to touch the painted surfaces, and it is recommended that you regularly open and close the door to prevent the door seal from sticking.

The stove may also produce "clicking noises" during heating and cooling, caused by the large temperature differences which the material is subjected to.

Never use any type of liquid fuel for kindling or maintaining the fire. You could be at risk of explosion.

The stove gets very hot when in use always wear protective gloves when tending the stove.

If the stove has not been used for a while, follow the steps as if you were using it for the first time.

IMPORTANT - Warning Note!

Properly installed, operated and maintained this appliance will not emit fumes into the dwelling. Occasional fumes from de-ashing and re-fuelling may occur. However, persistent fume emission is potentially dangerous and must not be tolerated. If fume emission does persist, the following immediate actions should be taken:

- (a) Open doors and windows to ventilate room.
- (b) Let the fire out or eject and safely dispose of fuel from the appliance.
- (c) Check for flue or chimney blockage, and clean if required.
- (d) Do not attempt to relight the fire until the cause of the fume emission has been identified and corrected. If necessary seek expert advice.

Lighting and fuelling



To light the stove, use alcohol briquettes or similar, as well as approx. 2 kg of firewood, split into kindling sticks. Set the air damper to the fully open position.

TIPS before firing up:

Open a door or window close to the wood burning stove.

If there is a “storm” in the stove coming from the chimney, it is advisable to place a screwed-up piece of newspaper between the upper baffle plate and the chimney, set the paper on fire, and wait until you hear a “rumbling” noise in the chimney. This means that there definitely is a draught in the chimney and you avoid smoke in the room.



Light the fire and shut the door, leaving the door ajar approx. 10-15 mm.



When the flames are clear - after approx. 5-10 min.
- close the door.

Damper - see adjustment of air damper.



After approx. 10-20 min. - when you have a good bed
of glowing embers - add 2-3 pieces of wood.
Leave the door ajar until the fire has caught on properly
- close the door.

Damper - see adjustment of air damper.



After approx. 5 min. - or when the flames are clear and
stable - close the damper gradually.

It is recommendable to have a layer of ash of approx.
20 mm, as it has an insulating effect.



Note!

During operation the
door should always
remain shut.



Cleaning and care

The wood burning stove and the chimney must be serviced by a chimney sweep once a year. During cleaning and care, the stove must be cold.

If the glass is sooty:

- Moisten a piece of paper or newspaper, dip it in the ash, and rub the sooty glass with it.
- Now rub with a piece of paper and the glass will become clean.
- As an alternative you can use glass polish, which you can buy from you RAIS distributor.

Clean the exterior with a dry sponge.

Cleaning the combustion chamber:

Scrape/shovel the ash out and store it in a non-flammable container until it has cooled down. You can dispose of ash with your normal household waste.

REMEMBER!! Never remove all the ashes from the combustion chamber - the wood will burn at its best with a layer of ashes of approx. 20 mm.

Prior to a new heating season, it should be checked that the chimney and smoke gas connector are not blocked.

Cleaning of the flue ways

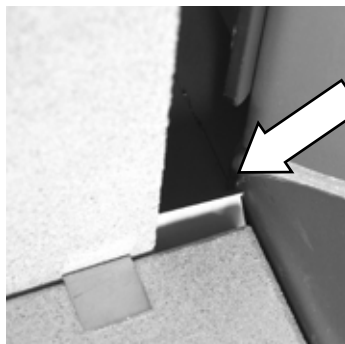

The fixing clips are pushed up and removed from the skamol on the side. The fixing clips is placed in the top right corner of the firebox.

The picture on the left is a detailed view of the top right corner of the firebox (A close-up of the area is marked by a circle in the next picture).

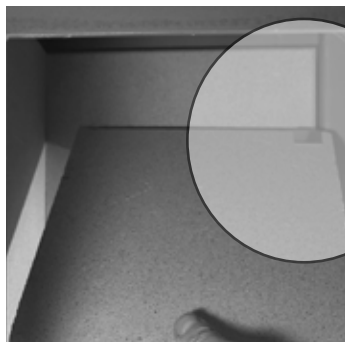

The baffle is pulled towards the front and is tipped down towards the firebox.

Note that the skamol on the sides are now loose.



The smoke connector is placed above the baffle.

The picture to the left is taken from the bottom of the firebox looking up.

The smoke connector is lifted free from the anchor bolts and lowered at a downward angle towards the firebox.

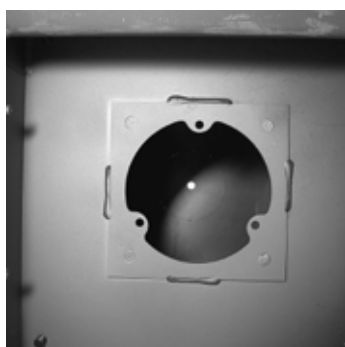

Now there is a clear view of the smoke exit.

Remove dirt and dust and put the parts back in reverse order.

Interruption of operation

Smoke spillage around door:

Could be due to too low draught in the chimney <12Pa

- Check whether the flue or chimney is blocked
- check whether the extraction hood is switched on; if it is, switch it off and open a window/door in the proximity of the stove for a short while.

Soot on glass:

Could be because the firewood is too wet.

- make sure that the stove is heated properly when firing up, prior to closing the door

Could be because the damper regulation is too low.

A stove burning too strong could be caused by:

- leak around the door seal
- chimney draught too large >22 Pa, draught control regulator should be installed.

A stove burning too weakly could be caused by:

- too little firewood
- too little air supply for room ventilation
- unclean smoke channels
- leaky chimney
- leakage between chimney and flue

If your stove continues to malfunction, we recommend that you contact your RAIS distributor or chimney sweep.

IMPORTANT!! To ensure safe burning there must be clear yellow flames or clear embers at all times. The firewood should not be smoldering. Therefore you should never completely cut off the air supply.

WARNING!!

In case of chimney fire:

- shut off all air supply on the wood burning stove
- contact the fire department
- never attempt to put out fire with water!
- afterwards, you should ask your chimney sweeper to check the stove and chimney

Accessories and spare parts

If spare parts other than those recommended by RAIS are used, the warranty is voided.

All replaceable parts can be bought as spare parts from your RAIS distributor.

See the following spare parts diagrams for the individual products.

Spare parts diagram - RAIS Q-BIC 106

Pos.	Number	Item no./description
1	1/1	706060290 / 95 Top plate
2	1	706010490 / 95 Steel back panel
3	1	706010590/95 Fixed window
4	1	706010190 / 95 Steel side panel
5	1	7061090/95 Door
6	1	7060905sv Handle for air control
7	1	7061301 Smoke connector
8	1	7062200 Set of skamol stones
9	1	7060590/95 Fixed socket
10	1	7051590/95 Swivel base
11	1	7055500 Seal set

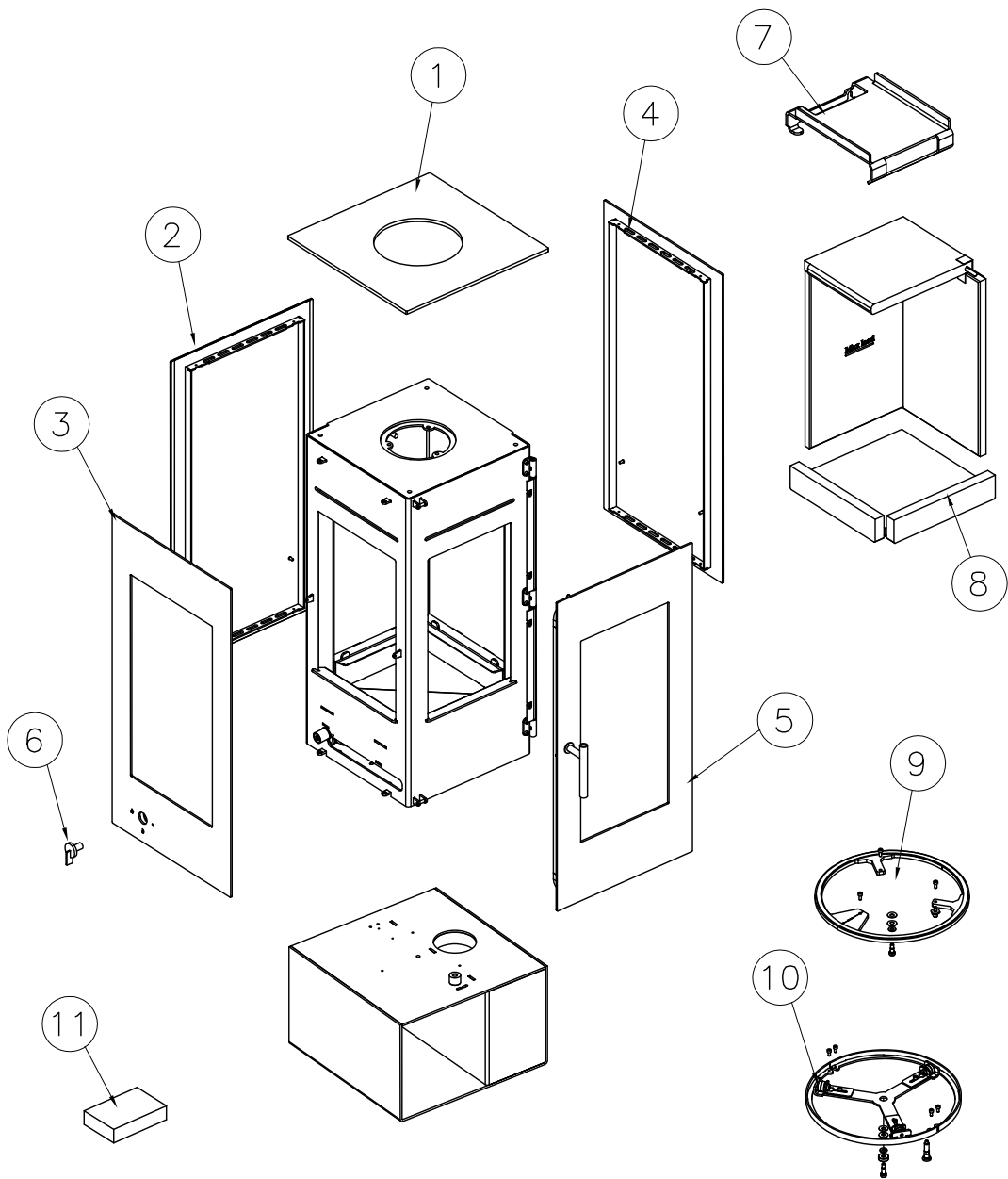

Spare parts diagram - RAIS Q-BIC 127

Pos.	Number	Item no./description
1	1/1	706060290 / 95 Top plate
2	1	706010490 / 95 Steel back panel
3	1	706010590/95 Fixed window
4	1	706010190 / 95 Steel side panel
5	1	7061090/95 Door
6	1	7060905sv Handle for air control
7	1	7061301 Smoke connector
8	1	7062200 Set of skamol stones
9	1	7060590/95 Fixed socket
10	1	7051590/95 Swivel base
11	1	7055500 Seal set

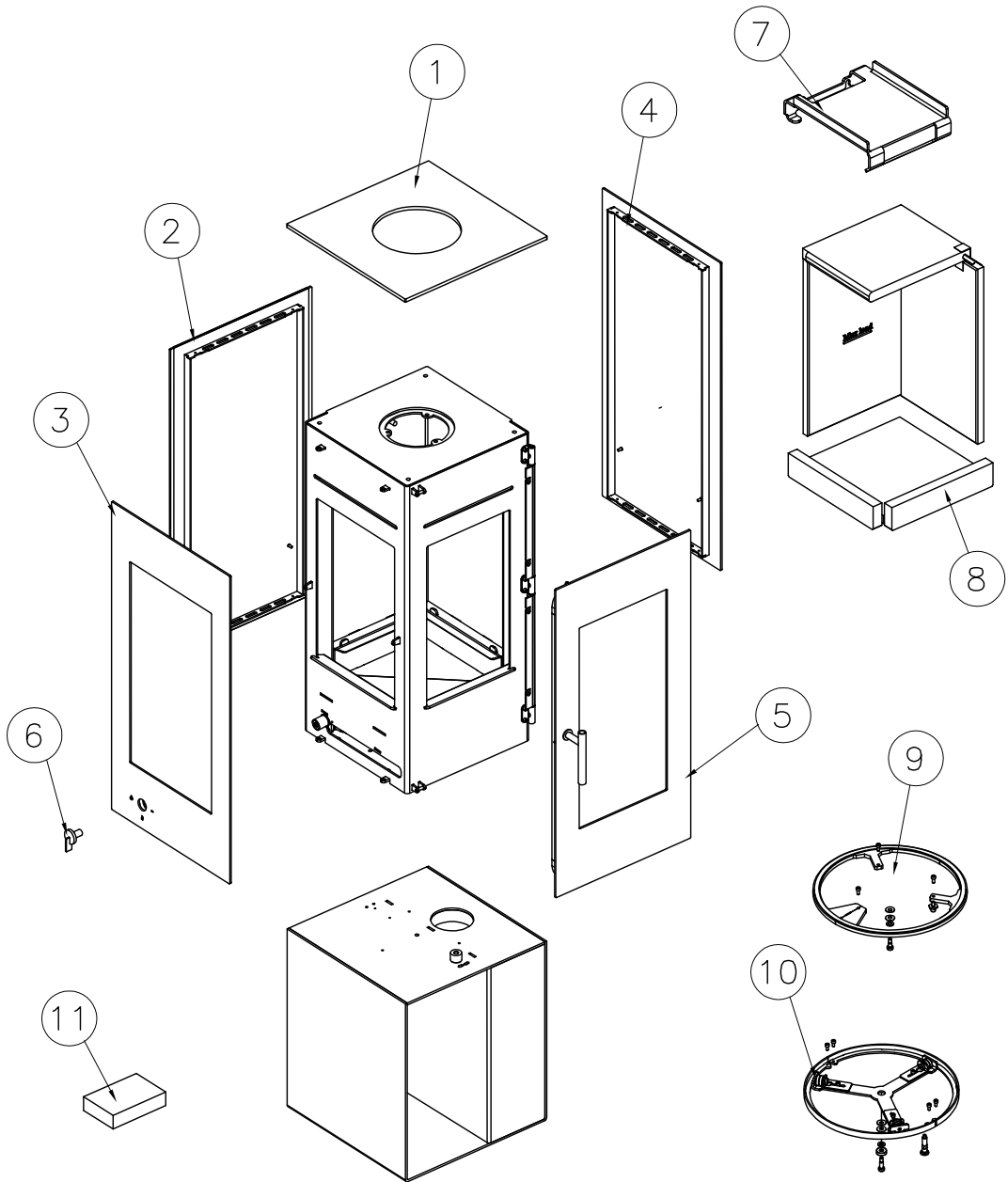

Spare parts diagram - RAIS Q-BIC insert

Pos.	Number	Item no. / description
1	1	707170190/95 Complete front
2	1	706010590/95 Fixed window
3	1	7061090/95 Door
4	1	7060905sv Handle for air control
5	1	7061301 Smoke connector
6	1	7062200 Set of skamol stones
7	1	7071301SV Complete smoke connector - 45° adapter
8	1	0006504 Complete smoke connector
9	1	707170190 Air-system
10	1	7055500 Seal set

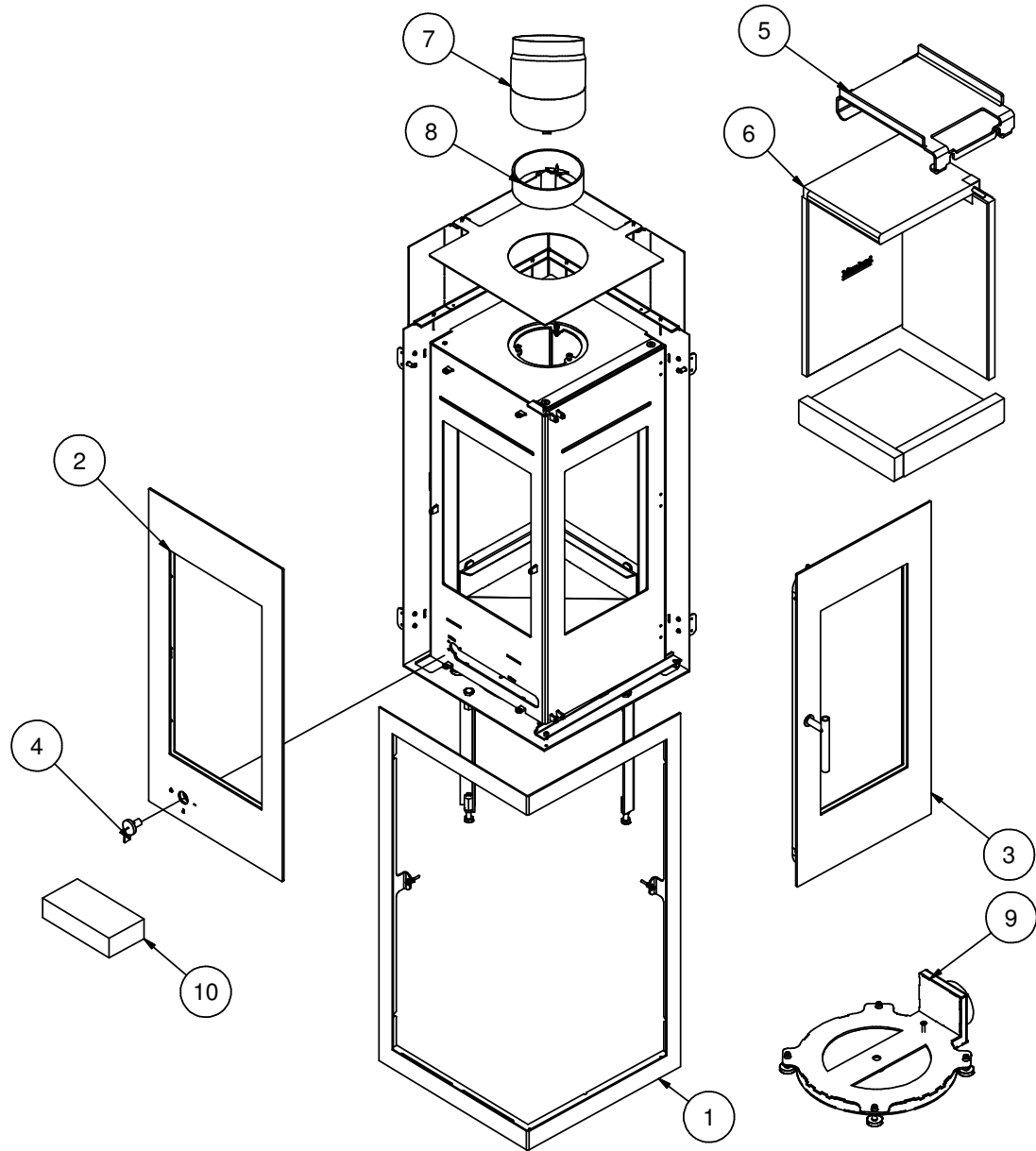



RAIS A/S
Industrivej 20
DK-9900 Frederikshavn
www.rais.dk

A thin, solid red line that starts at the bottom left and curves upwards towards the right, ending near the text "THE ORIGINAL".

THE ORIGINAL