

APC UPS Daemon

Apcupsd is a UPS control system that permits orderly shutdown of your computer in the event of a power failure.

Kern Sibbald

May 26, 2007

This manual documents apcupsd version 3.14.x
Copyright (C) 1999-2005 Kern Sibbald

Copying and distribution of this file, with or without modification, are permitted in any medium without royalty provided the name Apcupsd, the copyright notice, and this notice are preserved.

Apcupsd source code is released under the GNU General Public License version 2. Please see the file COPYING in the main source directory.

For more information on the project, please visit the main web site at <http://www.apcupsd.com>

Contents

How To Use This Manual	11
Basic User's Guide	11
Planning Your Installation	11
Quick Start for Beginners	11
Supported Operating Systems	13
Supported UPSes and Cables	14
Choosing a Configuration Type	16
Building and Installing apcupsd	30
Installation from Binary Packages	30
Installation from Source	31
Verifying a Source Installation	33
Configure Options	35
Recommended Options for most Systems	38
Compilers and Options	38
Operating System Specifics	39
After Installation	47
Checking Your Configuration File	47
Arranging for Reboot on Power-Up	48
Making sure apcupsd Is Running	49

Configuration Examples	50
Simple USB Configuration	50
Simple Configuration for a SmartUPS	50
Simple Configuration for a Simple Signaling or Dumb	51
NIS Server/Client Configuration Using the Net Driver	52
PowerChute Network Shutdown Driver (PCNET)	54
Testing Apcupsd	55
Process-Status Test	55
Logging Test	56
apcaccess Test	56
Communications Test	59
Simulated Power Fail Test	60
System Shutdown Test	62
Full Power Down Test	62
Shutdown Sequence	63
apctest	64
Troubleshooting Your Installation	66
Known Problems with USB UPSes	66
Monitoring and Tuning your UPS	67
apcaccess	67
Apcupsd Notification and Events	70
hid-ups and USB Specific Information	71
apcupsd Network Monitoring (CGI) Programs	71
Setting up and Testing the CGI Programs	72
Configuring Your EEPROM	78

Maintaining Your UPS	82
What Various People Have to Say about Batteries	82
Where Carl Suggests You Get Batteries	88
Frequently-Asked Questions	90
Apcupsd Bugs	94
Advanced topics	95
Customizing Event Handling	95
apccontrol Command Line Options	96
Controlling Multiple UPSes on one Machine	99
Configuration	99
Support for SNMP UPSes	101
Planning and Setup for SNMP Wiring	101
Planning and Setup for SNMP Configuration	102
Connecting APCUPSD to a SNMP UPS	105
Building with SNMP support	106
SNMP Trap Catching	107
Known Problems	107
Running The Network Information Server	108
apcupsd System Logging	109
Logging Types	109
Implementation Details	110
Developers Notes	111
Windows Version of apcupsd	111
Installation	112
Configuration	112

Starting Apcupsd	113
Testing	114
Upgrading	114
Post Installation	115
Problem Areas	115
Disclaimer	116
Email Notification of Events	117
Killpower under Windows	117
Power Down During Shutdown	118
Command Line Options Specific to the Windows Version	119
Building the Win32 Version from the Source	119
Installation: Serial-Line UPSes	120
Overview of Serial-Interface UPSes	120
Connecting a Serial-Line UPS to a USB Port	120
Connecting a APC USB UPS to either a PC USB or Serial Port	121
Cables	121
Smart-Custom Cable for SmartUPSes	121
Voltage-Signalling Cable for "dumb" UPSes	122
Custom-RJ45 Smart Signalling Cable for BackUPS CS Models	124
Other APC Cables that apcupsd Supports	125
Voltage Signalling Features Supported by Apcupsd for Various Cables	126
Voltage Signalling	126
Back-UPS Office 500 signals	127
Analyses of APC Cables	127
Win32 Implementation Restrictions for Simple UPSes	136

Internal Apcupsd Actions for Simple Cables	136
RS232 Wiring and Signal Conventions	137
Pin Assignment for the Serial Port (RS-232C), 25-pin and 9-pin, Female End	138
Ioctl to RS232 Correspondence	138
Testing Serial-Line UPSes	139
Establishing Serial Port Connection	140
Using apctest on Serial-Line UPSses	142
Troubleshooting Serial Line communications	145
Determining Which Voltage-Signaling Cable You Have	145
Once you have established serial communications	145
Recalibrating the UPS Runtime	145
Status Logging On Serial-Line UPSes	147
DATA Logging	147
Technical Reference	148
Configuration Directive Reference	148
General Configuration Directives	148
Configuration Directives Used by the Network Information Server	149
Configuration Directives used during Power Failures	150
Configuration Directives used to Control System Logging	154
Configuration Directives for Sharing a UPS	154
Configuration Directives Used to Set the UPS EPROM	155
apcupsd Status Logging	157
Status report format	158
Status Report Example	159
Status Report Fields	160

Logging the STATUS Information	163
Shutown Sequence and its Discontents	163
Shutdown Sequence	163
Shutdown Problems	167
Master/Slave Shutdown	167
Startup	167
Windows Considerations	168
APC smart protocol	168
Description	169
RS-232 differences	169
Diagram for cable hackers	169
Smart Protocol	170
Dip switch info	174
Status bits	175
Alert messages	175
Register 1	176
Register 2	177
Register 3	177
Interpretation of the Old Firmware Revision	178
Interpretation of the New Firmware Revision	178
EEPROM Values	179
Programming the UPS EEPROM	180
Acknowledgements	181
Apcupsd — RPM Packaging FAQ	182
Answers	182

Credits 184
Contributors 185
Disclaimer: NO WARRANTY 187

List of Figures

Configuration Types	17
Multimon Main Page	73
Multimon Statistics Display	74
Windows NT - Start Service	113
Thanks	184

List of Tables

Supported UPS Models	15
Supported Features	126
RS232 Wiring and Signal Conventions	137
Single Character Commands	170
DIP Switch Info	174
UPS Status Bits	175
Alert Messages	175
Register 1 Layout	176
Register 2 Layout	177
Register 3 Layout	177
Programming the UPS EEPROM	180

How To Use This Manual

This is the manual for `apcupsd`, a daemon for communicating with UPSes (Uninterruptible Power Supplies) made by American Power Corporation (APC). If you have an APC-made UPS, whether sold under the APC nameplate or OEMed (The HP PowerTrust 2997A UPS has been tested as a “smartups” with cable Hewlett Packard part number 5061-2575 equivalent to a custom-smart cable), and you want you get it working with a computer running Linux, Unix, or Windows NT, you are reading the right document.

This manual is divided into parts which increase in technical depth as they go. If you have just bought a state-of-the-art smart UPS with a USB or Ethernet interface, and you are running a current version of Red Hat or SUSE Linux (8.0 or later), then `apcupsd` is very nearly plug-and-play and you will have to read only the Basic User’s Guide (see Basic User’s Guide).

If your operating system is older, or if you have an old-fashioned serial-line UPS, you’ll have to read about serial installation (see Installation on Serial-Line UPSes). If you need more details about administration for unusual situations (such as a master/slave or multi-UPS setup) you’ll need to read the section on advanced topics (see Advanced topics). Finally, there is a Technical Reference (see Technical Reference) section which gives full details on things like configuration file directives and event-logging formats.

You should begin by reading the Quick Start (see Quick Start for Beginners) instructions.

Basic User’s Guide

Planning Your Installation

Quick Start for Beginners

`apcupsd` is a complex piece of software, but most of its complexities are meant for dealing with older hardware and operating systems. On current hardware and software getting it running should not be very complicated.

The following is a help guide to the steps needed to get `apcupsd` set up and running as painlessly as possible.

1. Check to see if `apcupsd` supports your UPS and cable (see Supported UPSes and Cables).
2. Check to see if `apcupsd` supports your operating system (see Supported Operating Systems).
3. Plan your configuration type (see Choosing a Configuration Type). If you have just one UPS and one computer, this is easy. If you have more than one machine being served by the same UPS, or more than one UPS supplying power to computers that are on the same local network, you have more choices to make.
4. Figure out if you have one of the easy setups. If you have a USB UPS, and a supported operating system and you want to use one UPS with one computer, that's an easy setup. APC supplies the cable needed to talk with that UPS along with the UPS. All you need to do is check that your USB subsystem is working (see USB Configuration); if so, you can go to the build and install step.
5. If you have a UPS designed to communicate via SNMP over Ethernet, that is also a relatively easy installation. It's in Advanced Topics (see Advanced topics) mainly because it's an unusual situation.
6. If you have a UPS that communicates via an RS232C serial interface and it is a SmartUPS, then things are relatively simple, otherwise, your life is about to get interesting.
 - (a) If you have a vendor-supplied cable, find out what cable type you have by looking on the flat ends of the cable for a number, such as 940-0020A, stamped in the plastic. Check the cables column of the table of types (see `type_table`) to see if it's a supported type.
 - (b) If you don't have a vendor-supplied cable, or your type is not supported, you may have to build one yourself (see Cables). Here is hoping you are good with a soldering iron!
7. Now you are ready to read the Building and Installing (see Building and Installing `apcupsd`) section of the manual and follow those directions. If you are installing from an RPM or some other form of binary package, this step will probably consist of executing a single command.
8. Tweak your `/etc/apcupsd/apcupd.conf` file as necessary. Often it will not be.

9. Change the BIOS settings (see Arranging for Reboot on Power-Up) on your computer so that boots up every time it gets power. (This is not the default on most systems.)
10. To verify that your UPS is communicating with your computer and will do the right thing when the power goes out, read and follow the instructions in the Testing (see Testing Apcupsd) section.
11. If you run into problems, read the Troubleshooting (see Troubleshooting Your Installation) section of this manual.
12. If you still need help, send a message to the developer's email list `apcupsd-users` at `lists.sourceforge.net` describing your problem, what version of `apcupsd` you are using, what operating system you are using, and anything else you think might be helpful.
13. Read the manual sections on monitoring and maintaining your UPS.

Supported Operating Systems

Please note that due to the lack of Unix USB API standards, the USB code in `apcupsd` works only on Linux and *BSD systems. In addition, at the current release (3.10.17) the USB support for *BSD systems can at best be considered BETA due to fragile kernel drivers. Drivers for other OSes can be written, but it requires someone with a knowledge of the OS and the USB to do so. (This lack of a Unix USB API interface is one of the big failings of Unix. It occurs in other areas such as the GUI. Many people tout the diversity as an advantage, but it is in fact a weakness.)

The `apcupsd` maintainers develop it under Fedora (Red Hat); that port is, accordingly, the most up to date and best tested. There are enough Debian Linux users that that port is also generally pretty fresh. Slackware Linux is also fully supported.

`apcupsd` has also been ported to FreeBSD, NetBSD, OpenBSD, HP/UX, Solaris, Alpha Unix and the Cygwin Unix emulation under Windows. It is quite likely to work on those systems, though the port may occasionally get stale and require minor tweaking. `apcupsd` can also work on Unix-like systems, but without USB mode. `apcupsd` has been ported to OS X/darwin with this limitation.

In Operating System Specifics you'll find operating-system-specific tips for building and configuring `apcupsd`.

Supported UPSes and Cables

You can generally count on your UPS being supported if it has either an Ethernet-connected SNMP interface or a USB interface with an APC-supplied cable.

The “UPSTYPE Keyword” field is the value you will put in your `/etc/apcupsd/apcupd.conf` file to tell `apcupsd` what type of UPS you have. We’ll describe the possible values here, because they’re a good way to explain your UPS’s single most important interface property – the kind of protocol it uses to talk with its computer.

apcsmart An APCSmart UPS and its computer communicate through an RS232C serial connection. They use it as a character channel (2400bps, 8 data bits, 1 stop bit, no parity) and pass commands back and forth in a primitive language (see APC smart protocol) resembling modem-control codes. The different APC UPSes all use closely related firmware, so the language doesn’t vary much (later versions add more commands). This class of UPS is in decline, rapidly being replaced in APC’s product line by USB UPSes.

usb A USB UPS speaks a universal well defined control language over a USB wire. Most of APC’s lineup now uses this method as of late 2003, and it seems likely to completely take over in their low- and middle range. Other manufacturers (Belkin, Tripp-Lite, etc.) are moving the same way, though with a different control protocol for each manufacturer. As long as USB hardware can be mass-produced more cheaply than an Ethernet card, most UPSes are likely to go this design route. Please note that even if you have a USB UPS, if you use a serial cable with it (as can be supplied by APC), you will need to configure your UPS as **apcsmart** rather than **usb**.

net This is the keyword to specify if you are using your UPS in Slave mode (i.e. the machine is not directly connected to the UPS, but to another machine which is), and it is connected to the Master via an ethernet connection. You must have `apcupsd`’s Network Information Services NIS turned on for this mode to work. It is a much simpler form of running a Slave than the old Master/Slave code.

snmp SNMP UPSes communicate via an Ethernet NIC and firmware that speaks Simple Network Management Protocol.

dumb A dumb or voltage-signaling UPS and its computer communicate through the signal lines on an RS232C serial connection. Not much

can actually be conveyed this way other than an order to shut down. Voltage-signaling UPSes are obsolete; you are unlikely to encounter one other than as legacy hardware. If you have a choice, we recommend you avoid simple signalling UPSes.

pcnet PCNET is an alternative for SNMP available on APC's AP9617 family of smart slot modules. The protocol is much simpler and potentially more secure than SNMP.

The table shown below lists the APC model supported, and the possible keywords that you would use in the configuration with the listed cables. See below for more details on the keywords. Some of the models, particularly USB enabled models, can be run in multiple modes, so they may appear more than once in the table. APC is putting out new models at a furious rate, and so it is very likely that your model is not listed in the table. If it is USB enabled, it will probably work in USB mode. Please note that some of these new models are extremely inexpensive, so they are stripped down versions of more expensive units, and as such they do not offer as many features, so some of the example output you see elsewhere in this manual may not be available with your unit.

APC Model	<i>UPSTYPE</i> Keyword	<i>UPSCABLE</i> keywords for Cable
BackUPS CS/ES (serial mode)	apcsmart	smart (note: using Smart Custom RJ45) the new BackUPS RS 500 models are reported NOT to work with this cable.
BackUPS Pro, Smarter BackUPS Pro	apcsmart	940-0095A
SmartUPS, SmartUPS VS (It has not been confirmed that the cable shipped with the VS is a 940-0095.), PowerStack 450, Matrix UPS, ShareUPS Advanced Port	apcsmart	smart (note: using Smart-Custom), 940-0024C
BackUPS CS USB, Pro USB, ES USB, RS/XS 1000, RS/XS 1500, and probably other USB models	usb	usb (note: using APC cables 940-0127A/B/C)
SmartUPS USB, BackUPS Office USB, and any other USB UPS	usb	usb (note: using APC cable, no number)

All SNMP-capable models	snmp	ether
BackUPS	dumb	simple (note: using Simple-Custom (This cable is not an APC product. You have to build it yourself using the instructions in Cables.), 940-0020B, 940-0020C, 940-0119A, 940-0023A
BackUPS Office, BackUPS ES	dumb	940-0119A
BackUPS CS and possibly ES models (serial mode)	dumb	940-0128A
ShareUPS Basic Port	dumb	940-0020B, 940-0020C, 940-0023A

Choosing a Configuration Type

There are three major ways of running `apcupsd` on your system. The first is a standalone configuration where `apcupsd` controls a single UPS, which powers a single computer. This is the most common configuration. If you're working with just one machine and one UPS, skip the rest of this section.

Your choices become more interesting if you are running a small cluster or a big server farm. Under those circumstances, it may not be possible or even desirable to pair a UPS with every single machine. `apcupsd` supports some alternate arrangements.

The second type of configuration is the NIS (Network Information Server) server and client. In this configuration, where one UPS powers several computers, a copy of `apcupsd` running on one computer will act as a server while the other(s) will act as network clients which poll the server for information about the UPS. Note that "NIS" is *not* related to Sun's directory service also called "NIS" or "Yellow Pages".

The third configuration (new with version 3.8.3), is where a single computer controls multiple UPSes. In this case, there are several copies of `apcupsd` on the same computer, each controlling a different UPS. One copy of `apcupsd` will run in standalone mode, and the other copy or copies will normally run in master/slave mode. This type of configuration may be appropriate for large server farms that use one dedicated machine for monitoring and diagnostics

Here is a diagram that summarizes the possibilities:

Configuration types.

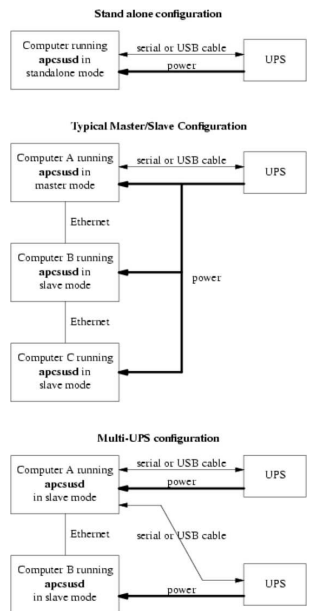

If you decide to set up one of these more complex configurations, see the Advanced Topics (see Advanced topics) section for details.

USB Configuration

`Apcupsd` supports USB connections on all major operating systems: Linux, FreeBSD, OpenBSD, NetBSD, Windows, Solaris, and Mac OS X Darwin. If you plan to use a USB connection, please read the appropriate subsection in its entirety. You can skip this section if your UPS has a serial (RS232-C) or Ethernet interface or if you are not running one of the platforms listed above.

Linux USB Configuration

Known Linux USB Issues

Problem Linux 2.4 series kernels older than 2.4.22 (RH 9, RHEL 3) do not bind the USB device to the proper driver. This is evidenced by `/proc/bus/usb/devices` listing the UPS correctly but it will have “`driver=(none)`” instead of “`driver=(hid)`”. This affects RHEL3, among others.

Workaround Upgrade linux kernel to 2.4.22 or higher. Alternately, you apply the `linux-2.4.20-killpower.patch` and `linux-2.4.20-USB-reject.patch` patches to your kernel and rebuild it. These patches can be found in the `examples/` directory in the `apcupsd` source distribution.

Problem Mandrake 10.0 and 10.1 systems with high security mode enabled (running kernel-secure kernel) use static device nodes but still assign USB minor numbers dynamically. This is evidenced by **hiddev0: USB HID v1.10 Device [...]** instead of **hiddev96: ...** in `dmesg` log.

Workaround Boot standard kernel instead of kernel-secure or disable `CONFIG_USB_DYNAMIC_MINORS` and rebuild kernel-secure.

Problem USB driver `linux-usb.c` fails to compile, reporting errors about **HID_MAX_USAGES undefined**. This is due to a defect in the linux kernel `hiddev.h` header file on 2.6.5 and higher kernels.

Workaround Upgrade to `apcupsd-3.10.14` or higher. These versions contain a workaround for the defect.

Problem On some systems such as Slackware 10.0, no USB devices will show up (see the next section).

Workaround Add the following to `rc.local`

```
mount -t usbdevfs none /proc/bus/usb
```

Problem 2.6 kernels use `udev` and some distributions do not configure it to automatically create `/dev/usb/hiddev??` as they should, causing `apcupsd` to fail to locate the UPS.

Workaround Edit the file `/etc/udev/rules.d/50-udev.rules`, and add the following:

```
KERNEL="hiddev*", NAME="usb/hiddev%n"
```

More details are provided in the following section ...

Checking Out Your Linux USB Subsystem

You need to check three things:

1. That your USB subsystem can see the UPS
2. That the kernel has bound the correct driver
3. That the correct device nodes are available in /dev

Verifying Device Detection and Driver

To make sure that your USB subsystem can see the UPS, just do this from a shell prompt:

```
cat /proc/bus/usb/devices
```

This information is updated by the kernel whenever a device is plugged in or unplugged, irrespective of whether apcupsd is running or not. It contains details on all the USB devices in your system including hubs (internal and external), input devices, and UPSes.

You should get some output back that includes something like this, featuring a BackUPS RS 1000:

```
T: Bus=02 Lev=01 Prnt=01 Port=00 Cnt=01 Dev#= 3 Spd=1.5 MxCh= 0
D: Ver= 1.10 Cls=00(>ifc ) Sub=00 Prot=00 MxPS= 8 #Cfgs= 1
P: Vendor=051d ProdID=0002 Rev= 1.06
S: Manufacturer=American Power Conversion
S: Product=Back-UPS RS 1000 FW:7.g3 .D USB FW:g3
S: SerialNumber=JB0308036505
C:* #Ifs= 1 Cfg#= 1 Atr=a0 MxPwr= 24mA
I: If#= 0 Alt= 0 #EPs= 1 Cls=03(HID ) Sub=00 Prot=00 Driver=hid
```

The important things to check for are the **S:** lines describing your UPS and and the **I:** line showing what driver is handling it. If on the **I:** line, **Driver** is listed as **Driver=none** then you do not have the HID driver loaded or the driver did not attach to the UPS. One common cause is having a Linux kernel older than 2.4.22 (such as a stock RedHat 9 or RHEL 3 kernel). If this is the case for your system, please upgrade to at least kernel version

2.4.22 and try again. If you are already running a 2.4.22 or higher kernel, please read further for instructions for other possible courses of action.

For a detailed description of the contents of the `/proc/bus/usb` files, see `Interpreting /proc/bus/usb (linux-2.4)` or `Interpreting /proc/bus/usb (linux-2.6)` as appropriate for your kernel version.

Here is another example, this time featuring a Back-UPS 350:

```
T: Bus=01 Lev=01 Prnt=01 Port=00 Cnt=01 Dev#= 2 Spd=1.5 MxCh= 0
D: Ver= 1.10 Cls=00(>ifc ) Sub=00 Prot=00 MxPS= 8 #Cfgs= 1
P: Vendor=051d ProdID=0002 Rev= 1.00
S: Manufacturer=American Power Conversion
S: Product=Back-UPS 350 FW: 5.2.I USB FW: c1
S: SerialNumber=BB0115017954
C:* #Ifs= 1 Cfg#= 1 Atr=a0 MxPwr= 30mA
I: If#= 0 Alt= 0 #EPs= 1 Cls=03(HID ) Sub=00 Prot=00 Driver=hid
E: Ad=81(I) Atr=03(Int.) MxPS= 8 Iv1= 10ms
```

In general, if you see your UPS model in the **S:** field, which means **Manufacturer=**, **Product=**, and **SerialNumber=**, and you see **Driver=hid** in the **I:** field, you know the UPS has been recognized and is bound to the correct driver.

If your UPS doesn't appear in the list at all, check the obvious things: The UPS must be powered on, and a cable must be properly seated in both the data port of the UPS and one of your machine's USB ports. Many UPSes have phone ports to provide surge protection for phones or modems – make sure you haven't plugged your USB cable into one of those rather than the data port (which will usually be near the top edge of the case.)

Also, ensure that the correct drivers are loaded. Under Linux-2.4.x, you can check this out easily by examining the `/proc/bus/usb/drivers` file. Here's how you can do that:

```
cat /proc/bus/usb/drivers
```

...and you should get:

```
usbdevfs
hub
```

```
96-111: hiddev
      hid
```

On Linux-2.6.x, make sure the sysfs filesystem is mounted on /sys and do:

```
ls -l /sys/bus/usb/drivers/
```

...where you should get:

```
total 0
drwxr-xr-x  2 root  root          0 May  1 18:55 hid
drwxr-xr-x  2 root  root          0 May  1 18:55 hiddev
drwxr-xr-x  2 root  root          0 May  1 18:55 hub
drwxr-xr-x  2 root  root          0 May  1 18:55 usb
drwxr-xr-x  2 root  root          0 May  1 18:55 usbfs
```

...or perhaps something like:

```
total 0
drwxr-xr-x  2 root  root  0 Jan  6 15:27 hiddev
drwxr-xr-x  2 root  root  0 Jan  6 15:28 hub
drwxr-xr-x  2 root  root  0 Jan  6 15:28 usb
drwxr-xr-x  2 root  root  0 Jan  6 15:27 usbfs
drwxr-xr-x  2 root  root  0 Jan  6 15:28 usbhid
```

If your 2.6.x system does not have the /sys/bus/usb directory, either you do not have sysfs mounted on /sys or the USB module(s) have not been loaded. (Check /proc/mounts to make sure sysfs is mounted.)

A USB UPS needs all of these drivers – the USB device filesystem, the USB hub, the Human Interface Device subsystem driver, and the Human Interface Device driver. If you are compiling your own kernel, you want to enable

```
CONFIG_USB
CONFIG_USB_HID
CONFIG_USB_HIDDEV
CONFIG_USB_DEVICEFS
```

...as well as at least one USB Host Controller Driver...

```
CONFIG_USB_UHCI_HCD (linux-2.6.x)
CONFIG_USB_OHCI_HCD (linux-2.6.x)
CONFIG_USB_UHCI      (linux-2.4.x)
CONFIG_USB_OHCI      (linux-2.4.x)
```

For a typical USB section of a kernel .config file, please see Typical Linux Kernel Config

Device Nodes

Apcupsd accesses USB UPSes via the hiddev device nodes. Typically these are located in /dev/hiddev*N*, /dev/usb/hiddev*N* or /dev/usb/hiddev/hiddev*N* (where *N* is a digit 0 thru 9). Some distributions (some Debian releases, possibly others) do not provide these device nodes for you, so you will have to make them yourself. Check /dev, /dev/usb, and /dev/usb/hiddev and if you cannot find the hiddev*N* nodes, run (as root) the examples/make-hiddev script from the apcupsd source distribution.

To complicate things more, many Linux flavors running 2.6 kernels such as Fedora FC3 use the udev utility, which dynamically creates the devices in /dev on the fly as they are needed. It is basically a hotplug system, giving a lot more power to the user to determine what happens when a device is probed or opened. It is also a lot more complicated.

Some default udev rule sets do not include rules for creating hiddev nodes. The bottom line for apcupsd on such a system is that if the hiddev*N* is not created when you plug in your UPS, apcupsd will terminate with an error. The solution to the problem is to add a rule to the udev rules file. On Fedora FC3, this file is found in /etc/udev/rules.d/50-udev.rules. Start by adding the following line:

```
BUS="usb", SYSFS{idVendor}="051d", NAME="usb/hiddev%n"
```

Then either reboot your system, or unplug and replug your UPS and then restart apcupsd. At that point a /dev/usb/hiddev*N* node should appear and apcupsd should work fine. You can use:

```
udevinfo -a -p /sys/class/usb/hiddev0/
```

to get more information on the fields that can be matched.

You can also create a more generic rule that creates nodes for any device using the hiddev driver, not just APC UPSes:

```
KERNEL="hiddev*", NAME="usb/hiddev%n"
```

If you have several UPSes or you just want to give your UPS a fixed name, you can use:

```
BUS="usb", SYSFS{serial}="AS0123456789", NAME="usb/ups0"
```

where you replace the serial number in quotes with the one that corresponds to your UPS. Then whenever you plug in your UPS it will be given a device node called usb/ups0.

An additional device-node-related problem is the use of dynamic minors. Some distributions, such as Mandrake 10, ship with a kernel having CONFIG_USB_DYNAMIC_MINORS turned on. This is not ideal for running with apcupsd, and the easiest solution is to turn CONFIG_USB_DYNAMIC_MINORS off and rebuild your kernel, or find a pre-built kernel with it off. For a kernel with CONFIG_USB_DYNAMIC_MINORS turned on to work with apcupsd, you must enable **devfs**. The following will tell you if devfs is enabled:

```
$ ps ax | grep devfs
```

...which should give something like the following:

```
533 ?          S          0:00 devfsd /dev
```

What complicates the situation much more on Mandrake kernels is their security level since CONFIG_DYNAMIC_USB_MINORS is turned on, but on higher security levels devfs is turned off. The net result, is that in those situations hiddev is completely unusable so apcupsd will not work. So, in these cases, the choices are:

1. Reduce the security level setting of the system (not sure if this is possible after the initial install).
2. Custom build a high security kernel with devfs enabled and make sure devfs is mounted and devfsd is running.
3. Custom build a high security kernel with dynamic minors disabled
4. Use udev

Miscellaneous

If all these things check out and you still can't see the UPS, something is more seriously wrong than this manual can cover – find expert help. If you are unable to list USB devices or drivers, your kernel may not be USB-capable and that needs to be fixed.

BSD USB Configuration

Known BSD USB Issues

Problem FreeBSD lockups: Some users have experienced lockups (apcupsd stops responding) on FreeBSD systems.

Solution Recent versions of Apcupsd have addressed this issue. Please upgrade to apcupsd-3.10.18 or higher.

Problem FreeBSD kernel panics if USB cable is unplugged while apcupsd is running.

Solution This is a kernel bug and is most easily worked around by not hot-unplugging the UPS while apcupsd is running. This issue may be fixed in recent FreeBSD kernels.

Platforms and Versions

The BSD USB driver supports FreeBSD, OpenBSD and NetBSD. (Thanks go to the BSD developers who kept a nearly identical interface across all three platforms.)

Kernel Configuration

Users of OpenBSD, NetBSD, and some versions of FreeBSD will need to rebuild the kernel in order to **enable the ugen driver** and **disable the uhid driver**. uhid is not sufficient for apcupsd at this time and we need to prevent it from grabbing the UPS device. You should **make the following changes** to your kernel config file:

FreeBSD (v5.4 and below, v6.0) (you **will not** lose use of USB keyboard and mouse):

Disable: uhid

Enable: ugen

FreeBSD (v5.5, v6.1 and above) (you **will not** lose use of USB keyboard and mouse):

Disable: (nothing)

Enable: ugen

This is the default configuration for a GENERIC kernel on many platforms so you most likely will not need to recompile.

NetBSD (v3.x and below) (you **will** lose use of USB keyboard and mouse):

Disable: uhidev, ums, wsmouse, ukbd, wskbd, uhid

Enable: ugen

NetBSD (v4.0 and above) You can use apcupsd on single USB port without disabling the USB keyboard and mouse on other ports, though all other devices will be disabled on the port you pick for your UPS.

First, decide which hub and port you wish to use. You can find out the hub and port numbers for any particular physical connector by plugging a USB device into it and looking at the messages printed by the kernel; you should see messages something like this:

```
uxx0 at uhub0 port 1
uxx0: <some device name>
```

To use your APC UPS on this port, configure the kernel to prefer attachment of the ugen driver over other drivers on this hub and port only, by adding a line like this to your kernel config file:

```
ugen*   at uhub0 port 1 flags 1
```

(The "flags 1" forces the ugen to attach instead of anything else detected there.)

Configure and build that kernel as per the references below, and your UPS will now attach as a ugen device when plugged into that port.

Don't forget to cd to /dev and ". /MAKEDEV ugen1" (and 2 and so on) if you have more than one generic usb device on your system.

OpenBSD (you **will** lose use of USB keyboard and mouse):

Disable: uhidev, ums, wsmouse, ukbd, wskbd, uhid

Enable: ugen

For detailed information on rebuilding your kernel, consult these references:

FreeBSD http://www.freebsd.org/doc/en_US.ISO8859-1/books/handbook/kernelconfig.html

NetBSD <http://www.netbsd.org/guide/en/chap-kernel.html>

OpenBSD <http://www.openbsd.org/faq/faq5.html#Building>

Verifying Device Detection and Driver

After building a properly configured kernel, reboot into that kernel and plug in your UPS USB cable. You should see a dmesg log message like the following:

```
ugen0: American Power Conversion Back-UPS RS 1500 FW:8.g6 .D USB FW:g6, rev 1.10/1
```

Note that the **ugen** driver is called out. If you see **uhid** instead, it probably means you did not properly disable the uhid driver when you compiled your kernel or perhaps you're not running the new kernel.

You can also check with 'usbdevs -d' to get a list of USB devices recognized by the system as well as the drivers they are associated with. For example:

```
# usbdevs -d
addr 1: UHCI root hub, VIA
  uhub0
addr 2: Back-UPS RS 1500 FW:8.g6 .D USB FW:g6, American Power Conversion
  ugen0
```

Device Nodes

Apcupsd communicates with the UPS through the USB generic device, **ugen**. You may or may not need to manually make **ugen** device nodes in /dev, depending on what OS you are using.

FreeBSD No manual intervention needed. FreeBSD automatically creates the ugen nodes on demand.

NetBSD By default, NetBSD only creates nodes for the first ugen device, **ugen0**. Check "usbdevs -d" to see which device your UPS was

bound to and then create the appropriate node by running "`cd /dev ; ./MAKEDEV ugenN`", where `ugenN` is the ugen device name shown by `usbdevs`. It is probably a good idea to create several sets of ugen nodes in case you add more USB devices.

OpenBSD Similar to NetBSD, OpenBSD creates nodes for `ugen0` and `ugen1`. Check "`usbdevs -d`" to see which device your UPS was bound to and then create the appropriate node by running "`cd /dev ; ./MAKEDEV ugenN`", where `ugenN` is the ugen device name shown by `usbdevs`. It is probably a good idea to create several sets of ugen nodes in case you add more USB devices.

Windows USB Configuration

Platforms and Versions

Apcupsd supports USB UPSes on Windows 98, Windows ME (untested, but expected to work), Windows NT 4.0, Windows 2000, Windows XP, and Windows Server 2003. Windows Vista is untested at this time. 64-bit platforms (x64) are also supported.

USB Driver Installation

USB connected UPSes on Windows require a special driver. In most cases, this driver is automatically installed when you install Apcupsd. However, if you unchecked the "USB Driver" package during installation or if you're running Windows 98 or ME, you will need to install the driver manually.

For detailed instructions, please see the `install.txt` file located in the driver folder of your Apcupsd install.

Verifying Device Detection and Driver

After installing Apcupsd (and the Apcupsd USB driver, if necessary), plug in your UPS USB cable and open the Windows Device Manager. You should see a "LibUSB-Win32 Devices" section, under which is listed "American Power Conversion USB UPS (Apcupsd)". You should **NOT** see "HID UPS Battery" under the "Batteries" section.

If the "LibUSB-Win32 Devices" section does not appear, check that your UPS is powered on and that the USB cable is connected at both ends.

Reinstall the driver as directed above if needed.

Solaris USB Configuration

Platforms and Versions

Apcupsd supports USB UPSes on Solaris 10 and higher. Both x86 and SPARC platforms are supported.

Building Apcupsd with USB

Some specific packages are necessary when building Apcupsd with USB support on Solaris. You must install the SUNWlibusb and SUNWlibusbgen packages **BEFORE** attempting to build Apcupsd. These packages can be found on the Solaris installation CDROMs and should be installed with the **pkgadd** utility.

You also should build using the gcc compiler and ccs make, not Sun's compiler. The appropriate make utility can be found in /usr/ccs/bin. gcc can be installed from packages included on the Solaris installation CDROMs.

Configure and build Apcupsd normally, as described in Building and Installing Apcupsd. Be sure to include the `---enable-usb` flag to `configure`.

After building, install Apcupsd as root using `'make install'`, then **perform a reconfigure boot** (`'reboot --- -r'`). During installation, Apcupsd will automatically configure your USB subsystem to attach APC USB devices to the `ugen` driver. This is a critical step and must be completed by a reconfigure boot. Note that the USB config changes will be reversed if you remove Apcupsd using `'make uninstall'`.

Verifying Device Detection and Driver

After installing Apcupsd as described above and performing a reconfigure boot, plug in your UPS USB cable. You should see a series of `dmesg` log messages similar to the following:

```
Dec  5 17:50:50 sunblade usba: [ID 912658 kern.info] USB 1.10 device (usb51d,2) operat
Dec  5 17:50:50 sunblade usba: [ID 349649 kern.info]      American Power Conversion Smart
```

```
Dec  5 17:50:50 sunblade genunix: [ID 936769 kern.info] ugen0 is /pci@1f,0/usb@c,3/inp
Dec  5 17:50:50 sunblade genunix: [ID 408114 kern.info] /pci@1f,0/usb@c,3/input@4 (ugen
```

Note that the **ugen** driver is called out. If you do not see any dmesg entries related to your UPS, ensure that it is turned on and that the USB cable is connected at both ends. Also verify that you installed Apcupsd as root using the 'make install' command and that you performed a reconfigure boot afterward.

Device Nodes

Apcupsd communicates with the UPS through the USB generic device, **ugen**. The reconfigure boot performed after Apcupsd installation will ensure the correct device nodes are created. Once your UPS has been recognized in dmesg as shown above, you can check /dev/usb to see if the device nodes have appeared:

```
[user@sunblade /]$ ls /dev/usb/51d.2/*
cntrl0      cntrl0stat  devstat     if0in1      if0in1stat
```

(51d.2 is the vendor/product id for APC UPSes.)

Mac OS X (Darwin) USB Configuration

Platforms and Versions

Apcupsd supports USB UPSes on Mac OS X (Darwin) 10.3.x and higher. Both Intel and PowerPC platforms are supported.

Building Apcupsd with USB

Some specific packages are necessary when building Apcupsd with USB support on Darwin. You must install libusb-0.1.12 or higher which can be obtained from MacPorts (formerly DarwinPorts) or Fink. Note that Apcupsd is sensitive to the install location of libusb, so beware if you change it from the default.

Apcupsd should be built using gcc, preferably from the XCode development tools. Currently the maintainer is using gcc-4.0.1 from XCode 2.4. Other version of gcc from other sources may also work.

Configure and build Apcupsd normally, as described in Building and Installing Apcupsd. Be sure to include the `---enable-usb` flag to configure.

After building, install Apcupsd as root using `'make install'` and then reboot. During installation, Apcupsd will automatically install a simple dummy kext driver designed to prevent Apple's monitoring software from taking over the UPS. It is necessary to reboot in order to activate the kext. Note that this kext will be automatically removed if you uninstall Apcupsd using `'make uninstall'`, allowing Apple's monitoring tool to once again access the UPS.

Verifying Device Detection and Driver

After installing Apcupsd as described above and rebooting, plug in your UPS USB cable. You should notice that Darwin does **NOT** display the battery monitor tool in the menu bar. You can also check Apple Menu -> About This Mac -> More Info... -> USB to ensure that your UPS appears in the list of USB devices.

Building and Installing apcupsd

Installation from Binary Packages

Red Hat Linux:

For Red Hat systems, apcupsd is available in binary RPM format. This is the simplest way to install. If you have no previous version of apcupsd on your machine and are creating a standalone configuration, simply install the RPM with a normal `rpm -ihv` command. You're done, and can now skip the rest of this chapter and go straight to tweaking your run-time configuration file. (see After Installation)

If you have a previous installation, you can upgrade with a normal `rpm -Uhv`, but this may not upgrade the halt script. It may be better to do the upgrade as a remove (`rpm -e`) followed by a fresh install (`rpm -ihv`).

After installation of the binary RPM, please verify carefully that `/etc/rc.d/init.d/halt` was properly updated and contains new script lines flagged with *****APCUPSD*****.

Since there is no standard location for cgi-bin, the rpm will place the binary CGI programs in the directory `/etc/apcupsd/cgi`. To actually use them, you must copy or move them to your actual cgi-bin directory, which on many systems is located in `/home/httpd/cgi-bin`.

Microsoft Windows:

If you have a binary release of the Win32 apcupsd, please see the section describing the Windows version of Apcupsd.

Installation from Source

Installation from source might have to be done different ways depending on what system you are running. The basic procedure involves getting a source distribution, running the configuration, rebuilding, and installing.

The basic installation from a tar source file is rather simple:

1. Unpack the source code from its tar archive.
2. Go into the directory containing the source code.
3. Run `./configure` (with appropriate options as described below)
4. `make`
5. `su` (i.e. become root)
6. Stop any running instance of apcupsd. The command to do this will look like `<system-dependent-path>/apcupsd stop`
7. `uninstall` any old apcupsd This is important since the default install locations may have changed.
8. `make install`
9. edit your `/etc/apcupsd/apcupsd.conf` file if necessary
10. ensure that your halt script is properly updated
11. Start the new apcupsd with: `<system-dependent-path>/apcupsd start`

If all goes well, the `./configure` will correctly determine which operating system you are running and configure the source code appropriately. `configure` currently recognizes the systems listed below in the Operating System Specifics section of this chapter and adapts the configuration appropriately. Check that the configuration report printed at the end of the `configure` process corresponds to your choice of directories, options, and that it has correctly detected your operating system. If not, redo the `configure` with the appropriate options until your configuration is correct.

Please note that a number of the `configure` options preset `apcupsd.conf` directive values in an attempt to automatically adapt `apcupsd` as best possible to your system. You can change the values in `apcupsd.conf` at a later time without redoing the configuration process by simply editing the `apcupsd.conf` file.

Other configuration options can be used to set up the installation of HTML documentation and optional modules, notably the CGI interface that enables the UPS state to be queried via the Web and the optional powerflute curses-based control panel. Still others enable features such as thread support. You will find a complete reference later in this chapter.

In general, you will probably want to supply a more elaborate `configure` statement to ensure that the modules you want are built and that everything is placed into the correct directories.

On Red Hat, a fairly typical configuration command would look like the following:

```
CFLAGS="-g -O2" LDFLAGS="-g" ./configure \
  --enable-usb \
  --with-upstype=usb \
  --with-upscable=usb \
  --prefix=/usr \
  --sbindir=/sbin \
  --with-cgi-bin=/var/www/cgi-bin \
  --enable-cgi \
  --with-css-dir=/var/www/docs/css \
  --with-log-dir=/etc/apcupsd \
  --enable-powerflute
```

By default, `make install` will install the executable files in `/sbin`, the manuals in `/usr/man`, and the configuration and script files in `/etc/apcupsd`. In addition, if your system is recognized, certain files such as the startup script and the system halt script will be placed in appropriate system directories (usually subdirectories of `/etc/rc.d`).

Installing on OS X/Darwin

On OS X (Darwin), `apcupsd` can be built with `configure` defaults. The USB driver can be enabled, as per the directions on Darwin USB Configuration. `Apcupsd` *may* be usable on OS X with a smart serial device, but certainly *does* work as a NIS client or using a USB interface.

The startup information will be installed in `/Library/StartupItems/apcupsd` which is part of Darwin's System-Startup.

Verifying a Source Installation

There are a number of things that you can do to check if the installation (make install) went well. The first is to check where the system has installed `apcupsd` using `which` and `whereis`. On my Red Hat system, you should get the following (lines preceded with a `$` indicate what you type):

```
$ which apcupsd
/sbin/apcupsd
$ whereis apcupsd
apcupsd: /sbin/apcupsd /etc/apcupsd /etc/apcupsd.conf
/etc/apcupsd.status /usr/man/man8/apcupsd.8.gz
/usr/man/man8/apcupsd.8
```

If you find an `apcupsd` in `/usr/sbin`, `/usr/local/sbin`, `/usr/lib`, or another such directory, it is probably a piece of an old version of `apcupsd` that you can delete. If you are in doubt, delete it, then rerun the `make install` to ensure that you haven't deleted anything needed by the new `apcupsd`. Please note that the files specified above assume the default installation locations.

As a final check that the `make install` went well, you should check your halt script (in `/etc/rc.d` on SUSE systems, and in `/etc/rc.d/init.d` on Red Hat systems) to see that the appropriate lines have been inserted in the correct place. Modification of the halt script is important so that at the end of the shutdown procedure, `apcupsd` will be called again to command the UPS to turn off the power. This should only be done in a power failure situation as indicated by the presence of the `/etc/powerfail` file, and is necessary if you want your machine to automatically be restarted when the power returns. On a Red Hat system, the lines containing the `# ***apcupsd***` should be inserted just before the final halt command:

```
# Remount read only anything that's left mounted.
```

Configure Options

All the available `configure` options can be printed by entering:

```
./configure --help
```

When specifying options for `./configure`, if in doubt, don't put anything, since normally the configuration process will determine the proper settings for your system. The advantage of these options is that it permits you to customize your version of `apcupsd`. If you save the `./configure` command that you use to create `apcupsd`, you can quickly reset the same customization in the next version of `apcupsd` by simply re-using the same `./configure` command.

The following command line options are available for `configure` to customize your installation.

- prefix=<path>** This defines the directory for the non-executable files such as the manuals. The default is `/usr`.
- sbindir=<path>** This defines the directory for the executable files such as `apcupsd`. The default is `/sbin`. You may be tempted to place the executable files in `/usr/sbin` or `/usr/local/sbin`. Please use caution here as these directories may be unmounted during a shutdown and thus may prevent the `halt` script from calling `apcupsd` to turn off the UPS power. Though your data will be protected, in this case, your system will probably not be automatically rebooted when the power returns.
- enable-powerflute** This option enables the building of the powerflute executable, which is a ncurses based program to monitor the UPS. This program is not necessary for the proper execution of `apcupsd`.
- enable-cgi** This enables the building of the CGI programs that permit Web browser access to `apcupsd` data. This option is not necessary for the proper execution of `apcupsd`.
- with-cgi-bin=<path>** The `with-cgi-bin` configuration option allows you to define the directory where the CGI programs will be installed. The default is `/etc/apcupsd`, which is probably not what you want.
- with-css-dir=<path>** This option allows you to specify where you want `apcupsd` to put the Cascading Style Sheet that goes with the `multimoncss.cgi` CGI program.

- enable-apcsmart** Turns on generation of the APC Smart driver (default).
- enable-dumb** Turns on generation of the dumb signalling driver code (default).
- enable-usb** Turns on generation of the USB driver code. By default this is disabled.
- enable-net** Turns on generation of the NIS network driver for slaves. For each slave, this is the only driver needed. This driver works by reading the information from the the configured master using the NIS (Network Information Services) interface.
- enable-snmp** Turns on generation of the SNMP driver. This driver accesses the UPS over the network using SNMP. This is compatible only with UPSes equipped with an SNMP or Web/SNMP management card. By default this is disabled.
- enable-pcnet** Turns on generation of the PCNET (PowerChute Network Shutdown) driver. This driver accesses the UPS over the network using APC's custom protocol. This driver can be used as an alternative to SNMP for UPSes equipped with a modern Web/SNMP management card.
- enable-test** This turns on a test driver that is used only for debugging. By default it is disabled.
- with-libwrap=<path>** This option when enabled causes apcupsd to be built with the TCP WRAPPER library for enhanced security. In most cases, the <path> is optional since configure will determine where the libraries are on most systems.
- with-nologin=<path>** This option allows you to specify where apcupsd will create the nologin file when logins are prohibited. The default is /etc
- with-pid-dir=<path>** This option allows you to specify where apcupsd will create the process id (PID) file to prevent multiple copies from running. The default is system dependent but usually /var/run.
- with-log-dir=<path>** This option allows you to specify where apcupsd will create the EVENTS and STATUS log files. The default is /etc/apcupsd. This option simply sets the default of the appropriate path in the apcupsd.conf file, which can be changed at any later time.

- with-lock-dir**=<path> This option allows you to specify where apcupsd will create the serial port lock file. The default is system dependent but usually /var/lock. This option simply sets the appropriate path in the apcupsd.conf file, which can be changed at any later time.
- with-pwrfail-dir**=<path> This option allows you to specify where apcupsd will create the powerfail file when a power failure occurs. The default is system dependent but usually /etc.
- with-serial-dev**=<device-name> This option allows you to specify where apcupsd will look for the serial device that talks to the UPS. The default is system dependent, but often /dev/ttyS0. This option simply sets the appropriate device name in the apcupsd.conf file, which can be changed at any later time.
- with-nis-port**=<port> This option allows you to specify what port apcupsd will use for the Network Information Server (the CGI programs). The default is system dependent but usually 3551 because that port has been officially assigned to apcupsd by the IANA. This option simply sets the appropriate port in the apcupsd.conf file, which can be changed at any later time.
- with-nisip**=<IP-Address> This option allows you to specify the value that will be placed on then NISIP directive in the configuration file. The default is 0.0.0.0. No checking is done on the value entered, so you must ensure that it is a valid IP address.
- with-net-port**=<port> This option allows you to specify what port apcupsd will use for Master and Slave communications. The default is system dependent but usually 6666. This option simply sets the appropriate port in the apcupsd.conf file, which can be changed at any later time.
- with-upstype**=<type> This option allows you to specify the type of UPS that will be connected to your computer. The default is: smartups. This option simply sets the appropriate UPS type in the apcupsd.conf file, which can be changed at any later time.
- with-upscable**=<path> This option allows you to specify what cable you are using to connect to the UPS. The default is: smart. This option simply sets the appropriate UPS cable in the apcupsd.conf file, which can be changed at any later time.
- disable-install-distdir** This option modifies the apcupsd Makefiles disable installation of the distribution (platform) directory. Generally, this used to do a full installation of apcupsd except the final modification of the operating system files (normally /etc/rc.d/halt, etc.). This

is useful if your operating system is not directly supported by apcupsd or if you want to run two copies of apcupsd on the same system. This option can also be used by those of you who prefer to manually reboot your system after a power failure or who do not want to modify your system halt files.

Recommended Options for most Systems

For most systems, we recommend the following options:

```
./configure --prefix=/usr --sbindir=/sbin --enable-usb
```

and you can optionally build and install the CGI programs as follows:

```
./configure --prefix=/usr --sbindir=/sbin --enable-usb \  
--enable-cgi --with-cgi-bin=/home/httpd/cgi-bin
```

Compilers and Options

Some systems require unusual options for compilation or linking that the `./configure` script does not know about. You can specify initial values for variables by setting them in the environment. Using a Bourne-compatible shell, you can do that on the command line like this:

```
CFLAGS="-O2 -Wall" LDFLAGS= ./configure
```

Or on systems that have the `env` program, you can do it like this:

```
env CPPFLAGS=-I/usr/local/include LDFLAGS=-s ./configure
```

Or for example on the Sun Solaris system, you can use:

```
setenv CFLAGS -O2  
setenv LDFLAGS -O  
./configure
```

You can get a listing of all available options by doing:

```
./configure --help
```

or simply see the previous section of this manual.

Operating System Specifics

With the exception of Linux SUSE and Linux Red Hat systems used by the developers, we rely on users to help create installation scripts and instructions as well as to test that `apcupsd` runs correctly on their system. As you can imagine, most of these people are system administrators rather than developers so they are very busy and don't always have time to test the latest releases. With that in mind, we believe that you will find that a lot of very valuable work has been already done to make your installation much easier (and probably totally automatic).

Below, you will find a list of operating systems for which we have received installation files:

- Alpha (see Alpha)
- Debian (see Debian)
- FreeBSD (see FreeBSD)
- HPUX (see HPUX)
- NetBSD (see NetBSD)
- OpenBSD (see OpenBSD)
- Red Hat (see Red Hat Systems)
- Slackware (see Slackware)
- SUSE (see SUSE)
- Solaris (see Sun Solaris)
- unknown (see Unknown System)
- Win32 (see Windows Systems)

Alpha:

The Alpha V4.0 version of apcupsd builds without compiler errors with gcc version 2.95.2. It is unlikely that the native Alpha compiler will work because of varargs differences. Unless you are a system guru, we recommend that you connect your UPS to the second serial port `/dev/tty01` to avoid conflicts with the console device.

```
DEVICE /dev/tty01
```

In addition, you should ensure serial port lock file in `apcupsd.conf` is defined as:

```
LOCKFILE /var/spool/locks
```

Unlike the Linux systems, the system halt routine is located in `/sbin/rc0`, so after the `make install`, please check that this file has been correctly updated.

The start/stop script can be found in:

```
/sbin/init.d/apcupsd
```

Debian:

This port is complete and is operation by several users. Since Debian build and install procedures are somewhat particular, we have put the extra Debian information into the following two subdirectories: `<src>/distributions/debian/examples/` and `<src>/distributions/debian/packageinfo`

You can also find the official Debian packages on the Debian site at:

- <http://packages.debian.org/stable/admin/apcupsd.html>
- <http://packages.debian.org/testing/admin/apcupsd.html>
- <http://packages.debian.org/unstable/admin/apcupsd.html>

FreeBSD:

This port is complete and is being used by several users.

On the FreeBSD OS, there is no known way for a user program to get control when all the disks are synced. This is needed for apcupsd to be able to issue the killpower command to the UPS so that the UPS shuts off the power. To accomplish the same thing on FreeBSD systems, make sure you have a SmartUPS and that your UPS shutdown grace period is set sufficiently long so that your system will power down (usually 2 minutes), then use the `kill-on-powerfail` option on the apcupsd command line.

HPUX:

We have no reports from testing this yet on version 3.8.4, but worked fine on 3.8.1

NetBSD:

Submitted during development of 3.8.2, this should be a complete distribution.

OpenBSD:

Ensure that you read the `distributions/openbsd/README` file before running apcupsd. There are some critical differences in how the OpenBSD implementation operates when the UPS batteries are exhausted. Failure to take this into account may result in the system not being fully halted when power is lost.

Red Hat Systems:

Red Hat systems are fully supported, and by following the standard installation instructions given above, you should experience few or no problems.

Slackware:

Slackware systems are fully supported, and by following the standard installation instructions given above, you should experience few or no problems.

SUSE:

SUSE systems are fully supported, and by following the standard installation instructions given above, you should experience few or no problems.

Sun Solaris:

Please read this before attempting to compile or install the beta software. It contains important information that will make your efforts easier.

If you find bugs, or run into problems that seem to be related to the version of Solaris that you run, please feel free to contact the maintainers by email, or through the development mailing list. We'll attempt to help with problems getting the beta running, although we can't promise a quick response.

As always, remember testing UPSes can be hazardous to you system, and, *apcupsd may contain bugs that can damage your system and data files!* You must accept all responsibility for running this software. An unexpected power-off of a running system can be a disaster. As always, make backups of any critical information before you install this software.

Remember, we told you. we'll listen sympathetically if you lose data, but there will be nothing we can do to help you.

Please read the general installation instructions given above before continuing on with these Solaris-specific instructions. Then come back and read this section before attempting to build the package.

For building the system, we suggest that you run the `configure` and `make` processes as your normal UNIX user ID. The `make install` must be run as root. But if your normal ID has an environment setup for using the C compiler, it's simpler to do that than to set up root to have the correct environment.

Normally, we support the GCC compiler, but we have also attempted to support the Solaris workshop compilers and EGCS compilers. Please be aware that if you do not use GCC, you may experience a few problems.

Whichever compiler you do have, please insure that you can execute the compiler from the command line before running `configure`. If you do not have an environment setup to run the compiler first, `configure` will fail.

Before running `./configure`, please be sure that you do not have `/usr/ucb` on your path. This may cause the `./configure` to choose the wrong shutdown program. If `./configure` detects that `/usr/usb` is on your path, it will print a warning message. Please follow the advice to avoid shutdown problems.

Your normal UNIX user ID must own the source tree directories, and you must have the normal development tools in your path. This includes `make`, the compiler, the M4 preprocessor, the linker, and `ar` or `ranlib`. If the user you are logged in as can compile and link a C program from a source file, then you have all the required tools available.

You will want to install the executables in a directory that remains mounted during the shutdown. Solaris will unmount almost everything except the root directories. Since the ability to power the UPS off requires access to the executable programs, they need to be in a directory that will never be unmounted. And since they should also be in a directory that normal users cannot get into, `/sbin` is the default. However, please be aware that if you want to follow Sun's filesystem conventions you would use the following:

```
./configure \  
  --prefix=/opt/apcupsd \  
  --sbindir=/etc/opt/apcupsd/sbin \  
  --sysconfdir=/etc/opt/apcupsd \  
  --with-cgi-bin=/opt/apcupsd/cgi-bin
```

The way to setup the `/sbin` directory as the executables directory is to pass `configure` the `sbindir=/sbin` option. No other arguments should be required, and your setup and platform should be detected automatically by `configure`.

Once you have run `configure`, you will need to do a `make`. Once the `make` has completed with no errors, you must `su` to root to complete the install. After the `su`, you may not have a path to the `make` program anymore. In that case, you should do the `make install` step as:

```
/usr/ccs/bin/make install
```

Once the install completes, you must edit the `/sbin/rc0` script as detailed below, then exit from the `su`'ed shell.

In order to support unattended operation and shutdown during a power failure, it's important that the UPS remove power after the shutdown completes. This allows the unattended UPS to reboot the system when power returns by re-powering the system. Of course, you need autoboot enabled for your system to do this, but all Solaris systems have this by default. If you have disabled this on your system, please re-enable it.

To get the UPS to remove power from the system at the correct time during shutdown, i.e., after the disks have done their final sync, we need to modify a system script. This script is `/sbin/rc0`.

We do not have access to every version of Solaris, but we believe this file will be almost identical on every version. Please let us know if this is not true.

At the very end of the `/sbin/rc0` script, you should find lines just like the following:

```
# unmount file systems. /usr, /var and /var/adm are not unmounted by umountall
# because they are mounted by rcS (for single user mode) rather than
# mountall.
# If this is changed, mountall, umountall and rcS should also change.
/sbin/umountall
/sbin/umount /var/adm >/dev/null 2>\&1
/sbin/umount /var >/dev/null 2>\&1
/sbin/umount /usr >/dev/null 2>\&1

echo 'The system is down.'
```

We need to insert the following lines just before the last 'echo':

```
#see if this is a powerfail situation
if [ -f /etc/apcupsd/powerfail ]; then
    echo
    echo "APCUPSD will power off the UPS"
    echo
    /etc/apcupsd/apccontrol killpower
    echo
    echo "Please ensure that the UPS has powered off before rebooting"
    echo "Otherwise, the UPS may cut the power during the reboot!!!"
    echo
fi
```

We have included these lines in a file called `rc0.solaris` in the `distributions/sun` subdirectory of the source tree. You can cut and paste them into the `/sbin/rc0` file at the correct place, or yank and put them using `vi` or any other editor. Note that you must be root to edit this file.

You must be absolutely sure you have them in the right place. If your `/sbin/rc0` file does not look like the lines shown above, do not modify the file. Instead, email a copy of the file to the maintainers, and we will attempt to figure out what you should do. If you mess up this file, the system will not shut down cleanly, and you could lose data. Don't take the chance.

This feature has only been tested with APC SmartUPS models. If you do not have a SmartUPS, you will be one of the first testers to try this feature. Please send email to let us know if it works with your UPS model, what model you have, and if possible, the event logs located in `/etc/apcupsd`. We'd be very interested in your results, and would be glad to work with you to get this feature working correctly with all the APC models. A detailed description of the screen output during the shutdown would be very helpful if you see problems.

You will then need to make the normal changes to the `/etc/apcupsd/apcupsd.conf` file. This file contains the configuration settings for the package. It is important that you set the values to match your UPS model and cable type, and the serial port that you have attached the UPS to. People have used both `/dev/ttya` and `/dev/ttyb` with no problems. You should be sure that logins are disabled on the port you are going to use, otherwise you will not be able to communicate with the UPS. If you are not sure that logins are disabled for the port, run the 'admintool' program as root, and disable the port. The 'admintool' program is a GUI administration program, and required that you are running CDE, OpenWindows, or another XWindows program such as KDE.

Solaris probes the serial ports during boot, and during this process, it toggles some handshaking lines used by dumb UPSes. As a result, particularly for simple signalling "dumb" UPSes it seems to kick it into a mode that makes the UPS think it's either in a calibration run, or some self-test mode. Since at this point we are really not communicating with the UPS, it's pretty hard to tell what happened. But it's easy to prevent this, and you should. Disconnect the UPS, and boot the system. When you get to a login prompt, log in as root. Type the following command:

```
eeeprom com1-noprobe=true
```

or

```
eeeprom com2-noprobe=true
```

depending on which com port your UPS is attached to. Then sync and shutdown the system normally, reattach the UPS, and reboot. This should

solve the problem. However, we have some reports that recent versions of Solaris (7 & 8) appear to have removed this eeprom option and there seems to be no way to suppress the serial port probing during boot.

At this point, you should have a complete installation. The daemon will load automatically at the next boot. Watch for any error messages during boot, and check the event logs in `/etc/apcupsd`. If everything looks OK, you can try testing the package by removing power from the UPS. NOTE! if you have a voltage-signalling UPS, please run the first power tests with your computer plugged into the wall rather than into the UPS. This is because dumb serial-port UPSes have a tendency to power off if your configuration or cable are not correct.

As a user, your input is very helpful in solving problems with the package, and providing suggestions and future directions for the development of the package. We are striving to provide a useful package that works across all platforms, and welcome your feedback.

Best regards, and thanks for your interest and help, The Apcupsd Development Team.

Unknown System:

During the `./configure`, if `apcupsd` does not find one of the systems for which it has specific installation programs, it will set the Operating System to **unknown** and will use the incomplete installation scripts that are in `<src>/distributions/unknown/`. You will be on your own, or you can ask the developers list (`apcupsd-users` at `lists.sourceforge.net`) for installation instructions. This directory also contains a hint file for *Linux From Scratch*, which could be helpful for other systems as well.

Windows Systems:

Appropriate scripts (actually Windows batch files) are included with the Apcupsd Win32 installer package.

After Installation

Checking Your Configuration File

Once you have installed `apcupsd`, either from a binary package or by building from source, your next step should be to inspect your `/etc/apcupsd/apcupsd.conf` file to make sure it is valid.

You can read the complete reference on configuration directives (see Configuration Directive Reference), but if you are setting up a normal standalone configuration you should only need to check (and possibly fix) the first three items listed below.

Your `UPSTYPE` should be the UPS's protocol type: `dumb`, `apcsmart`, `usb`, `net`, `snmp`, or `ether`. Your `UPSCABLE` should be the type of cable you are using. You should have gotten both from the table of types (see `type_table`); usually they will both be the string `"usb"`.

If you have a USB device, it is better not to specify a `DEVICE` directive by commenting it out. `Apcupsd` will automatically search for your device in the standard places. If you specify a `DEVICE`, it should be the name of the device (or device range) that `apcupsd` is to use to communicate with the UPS. If you're using a USB UPS under Linux, you may leave the device name field blank and `apcupsd` will search all the standard locations for the UPS. You may also explicitly specify the device location as either `/dev/usb/hid/hiddev[0-15]` (on non-Red-Hat systems) or `/dev/usb/hiddev[0-15]` (on Red Hat systems), but this is not recommended.

Note that you should enter `"/dev/usb/hiddev[0-15]"` literally as shown. The `"[0-15]"` expression tells `apcupsd` to search all `hiddev` devices until it finds a UPS. You can restrict the search to a subset of devices by using something like `"[0-4]"`, but keep in mind this will limit `apcupsd`'s ability to locate the UPS if the kernel relocates it to a different device node, which happens occasionally during short power failures. Again, it is highly recommended to leave the `DEVICE` directive blank and let `apcupsd` find your device automatically.

If the first time you execute `apcupsd`, you get a message to the effect that the `Apcupsd` USB driver is missing, it means that you most likely forgot to put `—enable-usb` on your `./configure` command line. If you loaded `apcupsd` from an rpm file, you may have selected the wrong one — please ensure that the word `usb` appears in the rpm package name.

The next chapter (see Configuration Examples) of this manual provides you

with the essential characteristics of each main type of configuration file. After those elements are correct, apcupsd should run, and then it is only a matter of customization of your setup.

Arranging for Reboot on Power-Up

The final consideration for a automatic reboot after a full power down is to ensure that your computer will automatically reboot when the power is restored.

This is not the normal behavior of most computers as shipped from the factory. Normally after the power is cut and restored, you must explicitly press a button for the power to actually be turned on. You can test your computer by powering it down; shutting off the power (pull the plug); then plugging the cord back in. If your computer immediately starts up, good. There is nothing more to do.

If your computer does not start up, manually turn on the power (by pressing the power on button) and enter your computer's SETUP program (often by pressing DEL during the power up sequence; sometimes by pressing F10). You must then find and change the appropriate configuration parameter to permit instant power on.

Normally, this is located under the **BOOT** menu item, and will be called something such as **Restore on AC/Power Loss** or **Full-On**. The exact words will vary according to the ROM BIOS provider. Generally you will have three options: **Last State**, **Power On**, and **Power Off**. Although **Last State** should normally work, we recommend setting your computers to **Power On**. This means that whenever the power is applied they are on. The only way to shut them off is to pull the plug or to have a special program that powers them off (`/sbin/poweroff` on Linux systems).

If after making all the changes suggested above, you cannot get your computer to automatically reboot, you might examine your halt script (`/etc/rc.d/init.d/halt` in the case of Red Hat Linux) and see if the final line that performs the halt or reboot contains the `-p` option for powering down the computer. It should not with the logic used by apcupsd, but if it does, the `-p` option could cause your computer to power off while the UPS is still supplying power (i.e. before the UPS kills the power). Depending on the setting of your BIOS, it may prevent your computer from restarting when the power returns. As already mentioned, this should not apply, but in case of problems it is worth a try.

Making sure apcupsd Is Running

The simplest way to invoke apcupsd is from the command line by entering:

```
/sbin/apcupsd
```

To do so, you must be root. However, normally, you will want apcupsd started automatically when your system boots. On some systems with installation support (e.g. SUSE and Red Hat), the installation procedure will create a script file that you will be automatically invoked when your system reboots. On other systems, you will have to invoke apcupsd from your rc.local script.

On Red Hat systems, this script file that automatically invokes apcupsd on system start and stops is: `/etc/rc.d/init.d/apcupsd`

To start apcupsd manually (as you will probably do immediately following the installation), enter the following:

```
/etc/rc.d/init.d/apcupsd start
```

To understand how this file is automatically invoked at system startup and shutdown, see the man pages for `chkconfig(8)`.

On SUSE systems, the script file that automatically invokes apcupsd on system start and stops is `/etc/rc.d/apcupsd`

To start apcupsd manually (as you will probably do immediately following the installation), enter the following:

```
/etc/rc.d/apcupsd start
```

Normally, when properly installed, apcupsd will be started and stopped automatically by your system. Unfortunately, the details are different for each system. Below, we give the commands for selected systems. Alternatively, there are simple `stopapcupsd` and `startapcupsd` scripts in the `examples` directory, or you can modify one of the scripts in the `distributions` directory to meet your needs.

To stop apcupsd you can do the following:

On Red Hat systems:

```
/etc/rc.d/init.d/apcupsd stop
```

On SUSE systems:

```
/etc/rc.d/apcupsd stop
```

Please see the Testing Apcupsd (see Testing Apcupsd) chapter for more details on insuring that apcupsd is running properly.

Configuration Examples

A Simple USB Configuration

If you have a USB UPS, and you have apcupsd version 3.10.7 (3.10.17a for *BSD) or higher, the essential elements of your apcupsd.conf file should look like the following:

```
## apcupsd.conf v1.1 ##
UPSCABLE usb
UPSTYPE usb
DEVICE
LOCKFILE /var/lock
UPSCCLASS standalone
UPSMODE disable
```

Notice that we have not specified a device. In doing so, apcupsd will try all the well known USB ports. We strongly recommend you use this (empty device address) form unless you have a good reason to do otherwise.

Please use the explicit specifications of a device only if you know exactly what you are doing. In general, it is much easier to let apcupsd find the device itself.

Please see USB Configuration for detailed help on setting up your system to work with a USB UPS.

A Simple Configuration for a SmartUPS

If you have a Smart UPS using the cable supplied by APC, or you build a CUSTOM SMART cable outlined in the cables chapter, a very simple configuration file would look like the following:

```
## apcupsd.conf v1.1 ##
UPSCABLE smart
UPSTYPE smartups
DEVICE /dev/ttyS0
LOCKFILE /var/lock
UPSCCLASS standalone
UPSMODE disable
```

Normally you would have many more configuration directives to completely customize your installation, but this example shows you the minimum required.

A Simple Configuration for a Simple Signaling or Dumb

If you have a simple signaling or dumb UPS such as a BackUPS, you will need to know exactly what cable you have and specify it on the UPSCABLE directive. Please see the list of UPSes versus cables in the beginning of this document for more information. The cable number is normally stamped in the plastic at one end of the cable. If you specify the wrong cable, it is very likely that at the first power failure, your computer will be immediately shut-down. This is an unfortunate consequence of the dumb signaling mode. To avoid this, first replace `/etc/apcupsd/apccontrol` with `safe.apccontrol` found in the examples directory, then test until everything works correctly. Once you have the correct cable, be sure to remember to reinstall the correct apccontrol file and test that your computer is correctly shutdown during a power failure.

```
## apcupsd.conf v1.1 ##
UPSCABLE (number of cable you have)
UPSTYPE dumb
DEVICE /dev/ttyS0
LOCKFILE /var/lock
UPSCCLASS standalone
UPSMODE disable
```

If your cable does not have low battery detection, as is the case with some older models, you will also need to define `TIMEOUT nnn` where you set `nn` to be the number of seconds on a power failure after which a shutdown is effected.

Normally you would have many more configuration directives to completely customize your installation, but this example shows you the minimum required.

NIS Server/Client Configuration Using the Net Driver

NIS (Network Information Server) mode allows for communication between instances of `apcupsd` running on different hosts. Only one of those hosts, the server, needs to talk to the UPS directly. The others, clients, obtain information about the state of the UPS by querying the server. NIS is *not* related to Sun's NIS/YP services.

NIS clients and servers require that `apcupsd` be compiled with the Net Driver `---enable-net`. This is typically enabled by default.

The NIS server is connected to the UPS and should be configured exactly as a standalone configuration, but with **NETSERVER** on. In all other respects, the server should be configured in standalone mode. You may also set the NIS server specific options **NISIP** to restrict which IP address of the server which `apcupsd` listens on. The default, 0.0.0.0, means to listen on all of the server host's IP addresses; **NISPORT** (default 3551) to set which TCP port the server listens on; and **EVENTSFILE** and **EVENTSFILEMAX** to provide information about the last few events to clients. You may also need to modify your firewall rules on the server's host to allow traffic to the **NISPORT**.

For the NIS client computer, you will have a configuration that looks something like what follows. What is important is that you get the information from an **ether UPSCABLE** with **UPSTYPE** set as **net** over the network and you must specify the address of a NIS server using **DEVICE**. The client `apcupsd` will then poll the NIS server specified in **DEVICE** every **NETTIME** seconds.

```
## apcupsd.conf v1.1 ##
UPSCABLE ether
UPSTYPE net
LOCKFILE /var/lock
DEVICE server-network-address:3551
UPSCCLASS standalone
UPSMODE disable
NETTIME 10
```

The **DEVICE** is set to `server-address:port`, where `server-address` is the fully qualified domain name or IP address of the `apcupsd` NIS server, and TCP port is the **NISPORT** that the server is listening on. The default is 3551, but older versions of `apcupsd` used port 7000.

If you set **NETTIME** too large, your slave may not see the change in state of the NIS server before the server has shutdown. Normally, you have at

least 30 seconds of grace time between the time the NIS server decides to shutdown and the time it no longer responds. Your slave must poll during this interval.

Any client run using the Net driver will shutdown when its own timers expire or when the NIS server shuts down, whichever occurs first. This means that if you want the slave to shutdown before the server, you need only set **BATTERYLEVEL**, **MINUTES** or **TIMEOUT** on the client for a faster shutdown than the values defined on the NIS server. This can often be useful if the slave is less important than the master and you wish to reduce battery power consumption so that the master can remain up longer during a power outage.

NIS clients work principally by reading the STATFLAG record that is sent by the NIS server (present in the output of `apcaccess`). The low 16 bits are the standard APC status flag, and the upper 16 bits represent the internal state of `apcupsd`, so the slave can see when the power fails and know when to shutdown.

It would be possible to have a client also work as a server, but that would increase the delay of information getting from the UPS to the secondary client.

Differences between NIS Client/Server and the old (now removed) Master/Slave modes

The difference between the NIS mode and the removed master/slave mode is that the NIS server has no explicit knowledge of the slaves. The NIS server makes its information available via the net (NIS), and the NIS slaves read it. When the NIS server is going to shutdown, it makes the information available to any NIS slave that polls it, but the NIS server does not explicitly call each NIS slave as is the case in the Master/Slave networking described several sections above.

Think of the difference as push (Master/Slave) vs. pull (NIS-based). In the case of M/S, the master makes all the shutdown decisions and notifies the slaves when they are to shut down or when some other interesting event happens. The slaves just do whatever the master says, whenever the master says to. On the other hand, with the NIS-based network config you basically “publish” the UPS status from one server and then your clients view that status and make their own decisions.

PowerChute Network Shutdown Driver (PCNET)

As of 3.14, Apcupsd supports the PowerChute Network Shutdown protocol. This is an alternative to SNMP for use with APC's AP9617 family of network smartslot modules. Note that the older AP9606 modules do **not** support PCNET.

To enable PCNET support, configure with the `---enable-pcnet` flag. This is typically enabled by default.

The required `apcupsd.conf` settings are straightforward:

```
## apcupsd.conf v1.1 ##
UPSCABLE ether
UPSTYPE pcnet
LOCKFILE /var/lock
DEVICE ipaddr:user:passphrase
UPSCLASS standalone
UPSMODE disable
```

The **DEVICE** setting specifies the IP address of the UPS as well as the username and authentication passphrase to use. Note that the username and passphrase are **not** the Web/SNMP login credentials. They are separate settings. The default username on a new card is "admin" and the default passphrase is "admin user phrase". To change the passphrase, log in to the Web UI and go to the UPS tab, then to PowerChute -> Configuration. (This assumes firmware v3.3.1. Other versions may place the setting elsewhere.)

Note that you may leave **DEVICE** blank and Apcupsd will accept information from any PCNET UPS on the network, **however it will be very insecure since an attacker could easily send packets crafted to cause your server to shut down**. Using the `ipaddr`, `user`, and `passphrase` will prevent this behavior.

You may need to take steps to ensure networking stays active during your OS's shutdown sequence in order for the PCNET driver to power off the UPS (the so-called "killpower" operation). On a Linux distro, you can use commands such as...

```
chkconfig --level 0 network on
chkconfig --level 0 iptables on
```

...to make sure networking stays up.

Testing Apcupsd

The following testing procedures apply for the most part to apcsmart UPSes, whether USB or serial. If you have a dumb voltage-signalling UPS, your testing procedures will be somewhat different, and you should see the section on Testing Serial UPSes (see Testing Serial-Line UPSes).

Process-Status Test

After you start apcupsd, execute the following command:

```
ps fax
```

or the equivalent for your system. You should see something similar to the following output.

```
632 ?      S      0:00 /sbin/apcupsd -f /etc/apcupsd/apcupsd.conf
841 ?      S      0:00  \_ /sbin/apcupsd -f /etc/apcupsd/apcupsd.conf
842 ?      S      0:00      \_ /sbin/apcupsd -f /etc/apcupsd/apcupsd.conf
```

This indicates that apcupsd is up and running and has started the two standard threads in addition to the main thread.

If you see only one instance of apcupsd running, don't worry about it as this is normal on most non-Linux systems, and on Linux 2.6.x kernels.

If you do not find that apcupsd is in the above list, the most likely problem is a configuration file glitch. If no messages were printed, you should check your system log (normally /var/log/messages where you will find one or messages indicating the nature of the problem.

There are three threads in apcupsd that serve the following purposes:

apcmmain is the main thread that waits until it receives a termination signal (SIGTERM) or one of the child processes dies.

apcsr is the thread that manages the serial port and takes any actions (generates events) that are necessary as a result of a change of state of the UPS.

apcnis is the Network information server thread that provides EVENTS and STATUS information over the network. This information is used by the CGI programs and the NIS client/server networking mode.

Logging Test

Once you have established that the proper processes are running, do a tail of the system log file, normally `/var/log/messages`:

```
tail /var/log/messages
```

You should see output that looks similar to the following:

```
Dec 5 17:01:05 matou apcupsd[5917]: apcupsd 3.7.2
startup succeeded
```

And if you have configured the network information server, you should also see:

```
Dec 5 17:01:05 polymatou apcupsd[5975]: apcserver
startup succeeded
```

These messages should also appear in the temporary file (`/etc/apcupsd/apcupsd.events`) if you are using the default configuration file. If you have installed the RPM, they will probably be in `/var/log/apcupsd.events`.

apcaccess Test

This test consists of running `apcaccess` to see if `apcupsd` is properly updating its internal variables. Please note that you must enable the `apcupsd` Network Information Server in your configuration file for `apcaccess` to work. This is done by setting:

```
NETSERVER on
NISPORT 3551
```

in your `apcupsd.conf` file.

To run the `apcaccess` test, use the following command:

```
apcaccess status
```

Depending on the type of UPS you have, you will get slightly different output, but an example For a Smart-UPS is as follows:

```
APC      : 001,048,1088
DATE     : Fri Dec 03 16:49:24 EST 1999
HOSTNAME : daughter
RELEASE  : 3.7.2
CABLE    : APC Cable 940-0024C
MODEL    : APC Smart-UPS 600
UPSMODE  : Stand Alone
UPSNAME  : SU600
LINEV    : 122.1 Volts
MAXLINEV : 123.3 Volts
MINLINEV : 122.1 Volts
LINEFREQ : 60.0 Hz
OUTPUTV  : 122.1 Volts
LOADPCT  : 32.7 Percent Load Capacity
BATTV    : 26.6 Volts
BCHARGE  : 095.0 Percent
MBATTCHG : 15 Percent
TIMELEFT : 19.0 Minutes
MINTIMEL : 3 Minutes
SENSE    : Medium
DWAKE    : 000 Seconds
DSHUTD   : 020 Seconds
LOTRANS  : 106.0 Volts
HITRANS  : 129.0 Volts
RETPCT   : 010.0 Percent
STATFLAG : 0x08 Status Flag
STATUS   : ONLINE
ITEMP    : 34.6 C Internal
ALARMDEL : Low Battery
LASTXFER : Unacceptable Utility Voltage Change
SELFTEST : NO
STESTI   : 336
DLOWBATT : 05 Minutes
DIPSW    : 0x00 Dip Switch
REG1     : N/A
REG2     : N/A
REG3     : 0x00 Register 3
MANDATE  : 03/30/95
SERIALNO : 13035861
BATTDATA : 05/05/98
NOMOUTV  : 115.0
NOMBATTV : 24.0
HUMIDITY : N/A
AMBTEMP  : N/A
EXTBATTS : N/A
BADBATTS : N/A
FIRMWARE : N/A
APCMODEL : 6TD
END APC  : Fri Dec 03 16:49:25 EST 1999
```

For a simple signaling or dumb UPS such as BackUPS, your output will be very minimal as follows:

```
APC      : 001,012,0319
DATE     : Mon Feb 18 09:11:50 CST 2002
RELEASE  : 3.8.5
UPSNAME  : UPS_IDEN
CABLE    : APC Cable 940-0128A
MODEL    : BackUPS
UPSMODE  : Stand Alone
STARTTIME: Mon Feb 18 09:11:45 CST 2002
LINEFAIL : OK
BATTSTAT : OK
STATFLAG : 0x008 Status Flag
END APC  : Mon Feb 18 09:15:01 CST 2002
```

If you see the above output, it is a good sign that apcupsd is working. Assuming that the output looks reasonable, check the following variables:

A very disturbing tendency is for some of the newer (Mar 2004) RS and ES UPSes to have no Voltage information. This is annoying bug not serious. On the other hand, some of those UPSes now have no battery charge information (BCHARGE). If BCHARGE is zero in your listing and you are running a Smart or a USB UPS, then you will have to set the BATTERYLEVEL directive in your apcupsd.conf file to -1.

LINEV This is the line voltage and it should be a value that is appropriate for your equipment. In the USA, it is typically about 120 Volts while in Europe, it is about 220 Volts.

BATTV Unless you have additional battery packs, this should be near 24 Volts plus or minus 5 Volts.

STATUS This is the status of the UPS and it should normally be **ON-LINE**.

If you see a message to the effect of:

```
attach_shmarea: shared memory version mismatch (or UPS not yet ready to report)
```

or if all the displayed values are zero, you have not waited long enough. Wait a bit longer and then re-execute the `apcaccess status` command.

If you see a message to the effect of:

```
APCACCESS FATAL ERROR in apcaccess.c at line 336
tcp_open: cannot connect to server localhost on port 3551.
```

It means that you have probably not enabled the Network Information Server in your configuration file for **apcaccess** to work. This is done by setting:

```
NETSERVER on
NISPORT 3551
```

in your **apcupsd.conf** file.

Communications Test

At this point, you should ensure that **apcupsd** is handling the connection to the UPS correctly. This test assumes you have a UPS that speaks **apcsmart** protocol, over either USB or a serial port. If you have an old-style voltage-signaling UPS, please skip to the next section (Simulated Power Fail Test).

When **apcupsd** detects a problem, it generates an **EVENT**, which consists of sending a message to the system log then invoking the **apccontrol** script (normally in `/etc/apcupsd/apccontrol`) to handle the event.

In order to create an event, remove the serial port plug from the back of your computer or from the back of the UPS. Within 6 seconds, **apcupsd** should detect the lack of serial port communications and broadcast a **wall** message indicating that the serial port communications was lost:

```
Warning communications lost with UPS lost.
```

At the same time, it sends the same message to the system log and to the temporary **EVENTS** file (`/etc/apcupsd/apcupsd.events`).

Plug the serial port plug back into your computer, and within about 12 seconds, **apcupsd** should reestablish communications and broadcast and log the following message:

```
Communications with UPS restored.
```

If these messages are logged but not broadcast, either you have your **mesg** permission set to *no* (see **man wall** or **man mesg**), or there is a problem with **apccontrol**. If you are running a window manager such as **GNOME** and don't have a console window open, you may not receive the **wall** messages. However, you should find them in your system

log file (normally `/var/log/messages` and in the temporary `EVENTS` file, `/etc/apcupsd/apcupsd.events`. For example, to observe these events in the temporary `EVENTS` file, you might do a

```
tail -f /etc/apcupsd/apcupsd.events
```

Note, if you have installed from the RPM, the proper events file may be `/var/log/apcupsd.events`. You can find the actual filename by checking your `apcupsd.conf` file.

before running the test.

If you do not observe these messages, you should correct this problem before proceeding with additional tests.

Simulated Power Fail Test

At this point, you should verify that in the event of a power fail `apcupsd` properly calls `apccontrol`. This test is appropriate for all models of UPSes (smart or dumb).

To avoid the possibility that `apcupsd` might shut down your system, locate where `apccontrol` resides on your system (normally, `/etc/apcupsd/apccontrol`. Move this script to another location e.g. `apccontrol.save` and replace it with the script found in `examples/safe.apccontrol`. When that is done, ensure that your UPS battery is fully charged and that you have at least 5 minutes of remaining runtime on the batteries. This can be done by examining the values of the **BATTCHG** and **TIMELEFT** variables in the printout of `apcaccess status`.

Although this should not be necessary, as an extra precaution, you can shut-down your machine, remove the plug from the UPS you are testing, and plug your machine into another UPS or directly into the wall. Doing so, will ensure that the UPS doesn't cut the power to your machine at a bad time. Remember at the end of the testing to plug your machine back into the UPS.

You can also minimize the risk from an unexpected shutdown by using a journaling filesystem such as Linux's `EXT3`. All modern disk drives park themselves safely when they power down, rather than ploughing up oxide on your disk's recording surface. Thus, unexpected power loss has to hit very narrow timing windows in order to trash an `EXT3` transaction.

To begin the test, pull the power plug from the UPS. The first time that you do this, psychologically it won't be easy, but after you have pulled the plug a few times, you may even come to enjoy it. If all goes well, `apcupsd` should detect the power failure and print several warning messages. The first should appear after 5 to 6 seconds and read:

```
Warning power loss detected.
```

Then generally 6 seconds later, `apcupsd` is sure that it isn't a transient effect, so it sends:

```
Power failure. Running on UPS batteries.
```

After a few more seconds (total around 15 seconds), plug the power cord back in and ensure that `apcupsd` is aware that the power has returned. It should print:

```
Power has returned...
```

If you do not observe the above messages, please correct the situation before proceeding. The most likely cause of problems are:

- `apcupsd` doesn't recognize the power failure because the configuration directives are not correct. E.g. wrong cable.
- The file `/etc/apcupsd/apccontrol` doesn't exist or is not marked as executable.

At this point, we recommend that you do a simulated power down of your system. If you are adventuresome or have been through this before, skip to the next section in this manual and do the real power fail shutdown. If you continue with the simulated power down and if all goes well, `apcupsd` will go through all the motions without actually shutting down the system. Continue using the safe `apccontrol` that you installed. Edit the configuration file `apcupsd` and change the value of **TIMEOUT** from 0 to something like 30. Doing so will cause `apcupsd` to attempt to shutdown the system 30 seconds after it detects a power failure. Once this change has been made, you must stop and restart `apcupsd` for the new configuration value to take effect.

Once again, pull the power plug, and if all goes as expected, apcupsd should attempt to shutdown the system about 30 seconds after it detects the power failure. All the messages should be displayed by `wall` or by the `tail -f` command. The precise message is determined by what is printed in `/etc/apcupsd/apccontrol` for the **doshutdown** event. Though it varies from system to system, it will generally be something like:

```
Beginning Shutdown Sequence
```

When apcupsd this message prints, reconnect the power. apcupsd should detect that the power has been restored and attempt to cancel the shutdown.

IMPORTANT after this test, please replace the changed `apccontrol` and `apcupsd.conf` with the original files.

System Shutdown Test

This is an intermediate test that you can do, for all UPS models before doing the Full Power Down Test. First modify the `/etc/apcupsd/apccontrol` file so that in the **killpower** case, the line that re-executes apcupsd with the `--killpower` option is commented out. The original line probably looks something like:

```
`${APCUPSD} --killpower
```

when it is commented out, it looks like:

```
##`${APCUPSD}--killpower
```

Now when you pull the power plug, and either the timer expires or the batteries are exhausted (see the next section for more details), the system should be fully shutdown.

After performing this test, please be sure to restore `/etc/apcupsd/apccontrol` to its previous state.

Full Power Down Test

To complete the testing, you should do a power fail shutdown of your system. This test is applicable to all UPS models. Please do a backup of your system

or take other precautions before attempting this to avoid the possibility of lost data due to a problem (I have been through this at least 10 times and never once had problems, but we all know that someday something will go wrong).

Before proceeding, please ensure that your halt script or the equivalent has been properly updated by the install process to contain the logic to call `apcupsd --killpower` when it detects a power failure situation (the presence of a `/etc/powerfail` file). See the Building and Installing `apcupsd` of this manual, or the README files for additional details about the halt modifications necessary.

When you are ready to do the test, either simply pull the plug and wait for the batteries to become exhausted, or set the **TIMEOUT** configuration directive to something like 60 so that the system will shutdown before the batteries are exhausted. We recommend doing the full shutdown without using **TIMEOUT** to correctly simulate a real power failure, but the choice is yours (I did it once here, but now use `TIMEOUT 30`).

If all goes well, your system should be shutdown before the batteries are completely exhausted and the UPS should be powered off by `apcupsd`. Please be aware that if you do the full power down, you must ensure that your UPS is totally powered off. Otherwise, it may have been given the command to power off, but due to a long grace period it is still waiting. If you were to reboot your computer during the grace period, the UPS could then suddenly turn off the power (this happened to me). To avoid this problem, always wait for your UPS to power itself off, or power if off manually before restarting your computer. On my system, the UPS is configured as at the factory to have a 180 second grace period before shutting off the power. During this type of testing, 180 seconds **seems** like an eternity, so please take care to either wait or manually power off your UPS. To determine what grace period is programmed into your UPS EEPROM, run `apcaccess eprom` and look at the “Shutdown grace delay”.

Shutdown Sequence

If you experienced so problems with the above testing procedures, or if you are porting `apcupsd` to another system, or you are simply curious, you may want to know exactly what is going on during the shutdown process. If so, please see the Shutdown Sequence (see Shutdown Sequence <1>) section of this manual.

apctest

apctest is a program that allows you to talk directly to your UPS and run certain low-level tests, display all known values from the UPS's EEPROM, perform a battery runtime calibration, program the EEPROM (serial connection only), and enter in TTY mode with the UPS. Here we describe how to use it for a USB or apcsmart UPS; see Using apctest on Serial-Line UPSes for a description of how to use it with a voltage-signalling UPS.

Shutdown apcupsd if it is running. Make sure your `/etc/apcupsd/apcupsd.conf` file has **UPSTYPE smart** and **UPSCABLE** has one of the smart cables that are supported.

Normally apctest will have been built but not installed, so you must execute it from the `<apcupsd-source>/src` directory. You can explicitly build it on Unix with:

```
cd <apcupsd-source-directory>
make apctest
./apctest
```

or on Windows systems with:

```
make apctestwin32
./apctest
```

It will read your installed `apcupsd.conf` configuration (so it knows where to find the UPS) and then it will present you with the following output:

```
2003-07-07 11:19:21 apctest 3.10.6 (07 July 2003) redhat
Checking configuration ...
Attached to driver: apcsmart
sharenet.type = DISABLE
cable.type = CUSTOM_SMART

You are using a SMART cable type, so I'm entering SMART test mode
mode.type = SMART
Setting up serial port ...
Creating serial port lock file ...
Hello, this is the apcupsd Cable Test program.
This part of apctest is for testing Smart UPSes.
Please select the function you want to perform.

1) Query the UPS for all known values
2) Perform a Battery Runtime Calibration
```

- 3) Abort Battery Calibration
- 4) Monitor Battery Calibration progress
- 5) Program EEPROM
- 6) Enter TTY mode communicating with UPS
- 7) Quit

Select function number: 1

Item 1 will probe the UPS for all values known to apcupsd and present them in rather raw format. This output can be useful for providing technical support if you are having problems with your UPS.

Item 2 will perform a Battery Runtime Calibration. This test will only be performed if your battery is 100% charged. Running the test will cause the batteries to be discharged to approximately 30% of capacity. The exact number depends on the UPS model. In any case, apctest will abort the test if it detects that the battery charge is 20% or less.

The advantage of doing this test is that the UPS will be able to recalibrate the remaining runtime counter that it maintains in its firmware. As your batteries age, they tend to hold less of a charge, so the runtime calibration may not be accurate after several years.

We recommend that perform a Battery Calibration about once a year. You should not perform this calibration too often since discharging the batteries tends to shorten their lifespan.

Item 3 can be used to abort a Battery Calibration in progress, if you somehow became disconnected.

Item 4 can be used to restart the monitoring of a Battery Calibration if you should somehow become disconnected during the test.

Item 5 is used to program the EEPROM. Please see the Configuration Directives Used to Set the UPS EPROM chapter of this manual for the details.

Item 6 will initiate a direct communication between your terminal and the UPS at which point, you can enter raw UPS commands. Please be aware that you should be careful what commands you enter because you can cause your UPS to suddenly shutdown, or you can modify the EEPROM in a way to disable your UPS. The details of the raw Smart mode UPS commands can be found in the UPS Bible (see APC smart protocol) chapter of this manual.

Item 7 will terminate apctest.

Troubleshooting Your Installation

Known Problems with USB UPSes

Some Cheaper Models Do Not Have Battery Charge:

Unfortunately, some cheaper USB models do not seem to report BCHARGE in the apcaccess output listing, which means with a standard conf file, your system will be immediately shutdown. To correct this, set the BATTERYLEVEL directive in your apcupsd.conf file to -1.

Some of these cheaper USB UPSes also do not report the Voltage. This is annoying but does not cause the unit to malfunction.

Reconnection does not clean up the lockfile:

If either you disconnect the UPS or it disconnects because of some electrical problem, it will most certainly reconnect with a different device number. Apcupsd will detect this and reconnect properly. However, apcupsd does not release the old device (USB port) lock file and create a new one. This is not too serious.

Power Off (killpower) of UPS Does Not Work:

Currently (as of 3.10.6) the code to power off the UPS works only if you have a Linux kernel version 2.4.22 or greater, or you have applied the patches in the examples directory to your kernel.

apcupsd Cannot Reconnect After a Reboot:

If apcupsd does not connect to the USB port when you reboot, it is probably the appropriate kernel modules are not getting loaded correctly.

You can check this by bringing up your system, fiddling around until you get apcupsd to work with the UPS, then doing `cat /proc/modules` and save the output some place. Then reboot your computer and before you do anything else, do the `cat /proc/modules` again. Most likely you will find some of the usb modules are missing in the second listing.

There are two solutions:

- Ensure that you have the hotplug program loaded. It should fix the problem. This is a bit of magic, so we are not exactly sure how it works. The rpm I (Kern) have loaded is: hotplug-2001_02_14-15

You might want to read the man page on hotplug, and it might be necessary to `cp /etc/hotplug/usb.rc /etc/init.d/hotplug` to get it fully working.

- You can explicitly force the appropriate usb modules to be loaded by adding:

```
/sbin/modprobe <missing-module-name>
```

in the `/etc/rc.d/init.d/apcupsd` script just after the **start**) case (at about line 17). This will force the modules to be loaded before `apcupsd` is invoked.

Monitoring and Tuning your UPS

After you have verified that your UPS is working correctly, you will probably want to query the state of its health occasionally. The tools `apcupsd` gives you to do this include one command-line utility (`apcaccess`) and a GUI you can use through a Web browser. You can also use `apctest` to tune some parameters of the UPS itself.

apcaccess

`apcaccess` is a program (normally found in `/sbin/apcaccess`) that permits you to print out the complete status of your UPS. Although there are a number of command line arguments (**eprom**, **reconfig**, **status**, **slave**, **shutdown**), all except **eprom** and **status** are under development and hence do not work reliably.

`apcaccess` will use the Network Information Server to obtain the necessary information for the **status** and **eprom** commands. You can specify a second optional argument to `apcaccess` in the form of `host:port` where the `:port` is optional. The default is **localhost:3551**. Please note that in versions prior to 3.10.6, the default NIS port was 7000, so if you are mixing versions, you will need to take a lot of care to ensure that all components are using the same port.

To enable the apcupsd Network Information Server, which is normally the default, you set:

```
NETSERVER on
NISPORT 3551
```

in your **apcupsd.conf** file.

apcaccess status:

As mentioned above, the full form of the command is:

```
apcaccess status localhost:3551
```

where only apcaccess status should normally be needed. localhost may be replaced by any machine name, fully qualified domain name, or IP address, which means that apcaccess can access any UPS on the network running the Network Information Server.

The **status** command line option of apcaccess will produce a full printout of all the **STATUS** variables used by apcupsd. This can be very helpful for checking the condition of your UPS and to know whether or not apcupsd is properly connected to it. For a complete description of the variables and their meanings, please read the Status Format (see apcupsd Status Logging) section of the Technical Reference.

Please note that if you invoke apcaccess within the first 30 seconds of launching apcupsd, you will likely get an error message such as:

```
APCACCESS FATAL ERROR in apcipc.c at line 325
attach_shmarea: shared memory version mismatch
```

This is because apcupsd is still in the process of initializing the shared memory segment used to communicate between the two processes. There is also a small window of time after which the memory segment is properly initialized but before the UPS has been completely polled. If you invoke apcaccess during this period, you will get the STATUS output, but with many of the values zero. The solution is to wait at least 30 seconds after starting apcupsd before launching apcaccess.

To invoke apcaccess, enter:

apcaccess status

For a SmartUPS 1000 apcaccess will emit the following output:

```
DATE       : Fri Dec 03 12:34:26 CET 1999
HOSTNAME   : matou
RELEASE    : 3.7.0-beta-1
CABLE      : Custom Cable Smart
MODEL      : SMART-UPS 1000
UPSMODE    : Stand Alone
UPSNAME    : UPS_IDEN
LINEV      : 232.7 Volts
MAXLINEV   : 236.6 Volts
MINLINEV   : 231.4 Volts
LINEFREQ   : 50.0 Hz
OUTPUTV    : 232.7 Volts
LOADPCT    : 11.4 Percent Load Capacity
BATTV      : 27.7 Volts
BCHARGE    : 100.0 Percent
MBATTCHG   : 5 Percent
TIMELEFT   : 112.0 Minutes
MINTIMEL   : 3 Minutes
SENSE      : Low
DWAKE      : 060 Seconds
DSHUTD     : 180 Seconds
LOTRANS    : 204.0 Volts
HITRANS    : 253.0 Volts
RETPCT     : 050.0 Percent
STATFLAG   : 0x08 Status Flag
STATUS     : ONLINE
ITEMP      : 29.2 C Internal
ALARMDEL   : Low Battery
LASTXFER   : U command or Self Test
SELFTEST   : NO
STESTI     : 336
DLOWBATT   : 02 Minutes
DIPSW      : 0x00 Dip Switch
REG1       : 0x00 Register 1
REG2       : 0x00 Register 2
REG3       : 0x00 Register 3
MANDATE    : 01/05/99
SERIALNO   : GS9902009459
BATTDATE   : 01/05/99
NOMOUTV    : 230.0
NOMBATTV   : 24.0
HUMIDITY   : N/A
AMBTEMP    : N/A
EXTBATTS   : 0
BADBATTS   : N/A
FIRMWARE   : 60.11.I
APCMODEL   : IWI
END APC    : Fri Dec 03 12:34:33 CET 1999
```

For the various smaller, cheaper APC USB UPSes, such as the CS, ES, ..., you will get much of the information that is presented above, but not all of it. For example, you will not get MAXLINEV, MINLINEV, LINEFREQ, ... and in particular, the LOADPCT will be zero when you are running on mains. LOADPCT will display when the UPS is on batteries. You must remember that the non-SmartUPSes are much simpler (and less expensive) and therefore produce less information.

apcaccess eprom:

The **eprom** command line option for apcaccess allows you to examine the current values of your UPS' EPROM as well as to know the permitted values that can be set in the EPROM. For information about changing these values, see the section on tuning EEPROM parameters (see Configuring Your EEPROM).

A typical output from apcaccess eprom is:

Valid EPROM values for the SMART-UPS 1000

Description	Config Directive	Current Value	Permitted Values
Upper transfer voltage	HITRANSFER	253	253 264 271 280
Lower transfer voltage	LOTRANSFER	208	196 188 208 204
Return threshold	RETURNCHARGE	15	00 15 50 90
Output voltage on batts	OUTPUTVOLTS	230	230 240 220 225
Sensitivity	SENSITIVITY	H	H M L L
Low battery warning	LOWBATT	2	02 05 07 10
Shutdown grace delay	SLEEP	180	020 180 300 600
Alarm delay	BEEPSTATE	T	0 T L N
Wakeup delay	WAKEUP	60	000 060 180 300
Self test interval	SELFTTEST	336	336 168 ON OFF

Apcupsd Notification and Events

When a major event is generated within apcupsd, control is passed to the script apccontrol normally found in /etc/apcupsd/apccontrol. The event name, and a number of other important parameters are passed to the script.

The major function of the apccontrol script is to perform a shutdown of the system (as well as the killpower operation). In addition, another major task for this script is to notify you by email when certain events such as powerfail occur.

Since apccontrol is a script, you can customize it to your own needs using any text editor. To do so, you must have a minimal knowledge of Unix shell programming. In addition, another feature is that you can write your own scripts that will be automatically called by apccontrol before any of its own code is executed. Details of the events and how to program them are contained in the Advanced topics section entitled Customizing Event Handling (see Customizing Event Handling).

hid-ups and USB Specific Information

The UPS has an internal set of timers and remaining capacity counters, which it uses to determine when to shutdown. These are in addition to the apcupsd counters BATTERYLEVEL and MINUTES. As a consequence, apcupsd will shutdown on the first limit that triggers (either an apcupsd limit, or a UPS limit). The UPS internal counter equivalent to BATTERYLEVEL can be found in the hid-ups report as RemainingCapacityLimit, which is typically factory set to 10 percent. In addition, the Low Battery signal is normally given by the UPS when less than 2 minutes of run time remain.

apcupsd Network Monitoring (CGI) Programs

With this release, there are four CGI programs (multimon.cgi, upsstats.cgi, upsfstats.cgi, and upsimage.cgi). To have them properly installed, you must run the `./configure` command with `--enable-cgi` and you should specify an installation directory with `--with-cgi-bin=` or load them manually. The default directory for installation of the CGI programs is `/etc/apcupsd`, which is not really where you want them if you are going to use them. Normally, they should go in the `cgi-bin` of your Web server.

Once built and loaded, they will give you the status of your UPS or UPSes over the network.

Normally only `multimon.cgi` is directly invoked by the user. However, it is possible to directly invoke `upsstats.cgi` and `upsfstats.cgi`. `upsimage.cgi` should never be directly invoked as it is used by `upsstats.cgi` to produce the bar charts.

Setting up and Testing the CGI Programs

Before using `multimon` and the other CGI programs, first ensure that `apcupsd` is configured to run the Network Information Server. This is done by setting **NETSERVER on** in `/etc/apcupsd/apcupsd.conf`. This switch is on by default. If you are unsure of its state, see the section at the end of this chapter concerning the Client test program.

Next you must edit the hosts file `/etc/apcupsd/hosts.conf` and at the end, add the name of the hosts you want to monitor and a label string for them. Kern Sibbald uses `multimon.conf` unmodified from what is on the source distribution. However, he has modified the `hosts.conf` file to contain the following three lines:

```
MONITOR matou "Server"
MONITOR polymatou "Backup server"
MONITOR deuter "Disk server"
```

`matou`, `polymatou`, and `deuter` are the network names of the three machines currently running `apcupsd`. Please note that the network names may either be IP addresses or fully qualified domain names. The network name (or IP address) may optionally be followed by `:<port>`, where the port is the NIS port address you wish to use. This is useful if you are running multiple copies of `apcupsd` on the same system or if you are running in a mixed vendor environment where the NIS port assignments differ. An example could be the following:

```
MONITOR matou "Server"
MONITOR polymatou "Backup server"
MONITOR deuter "Disk server"
MONITOR polymatou:7001 "APC USB UPS"
```

where the USB copy of `apcupsd` has been configured to use port 7001 (with `--with-nis-port=7001` on the `./configure` or by modifying `apcupsd.conf`). Note, the default NIS port is 3551 on most platforms.

To test `multimon.cgi`, you can execute it as non-root directly from the source cgi build directory. To do so, enter at a shell prompt:

```
./multimon.cgi
```

If everything is set up correctly, it will print a bunch of HTML with the values of the machines that you have put in the `hosts.conf` file. It should

look something like the following (note, only a small portion of the output is reproduced here):

```
Content-type: text/html

<!DOCTYPE HTML PUBLIC "-//W3C//DTD HTML 4.0 Transitional//EN"
    "http://www.w3.org/TR/REC-html40/loose.dtd">
<HTML>
<HEAD><TITLE>Multimon: UPS Status Page</TITLE></HEAD>
<BODY BGCOLOR="#FFFFFF">
<TABLE BGCOLOR="#50A0A0" ALIGN=CENTER>
<TR><TD>
<TABLE CELLPADDING=5>
<TR>
<TH COLSPAN=10 BGCOLOR="#60B0B0">
<FONT SIZE="+2">APCUPSD UPS Network Monitor</FONT>
<BR>Sun Jan 16 12:07:27 CET 2000</TH>
</TR>
<TR BGCOLOR="#60B0B0">
<TH COLSPAN=1>System</TH>
<TH COLSPAN=1>Model</TH>
<TH COLSPAN=1>Status</TH>
...

```

If you do not get similar output, check the permissions of the `/etc/apcupsd` directory and of those of `/etc/apcupsd/hosts.conf` to ensure that your web server can access it. At many sites such as mine, the Apache server is not running as root, so you must be careful to ensure that that `/etc/apcupsd/hosts.conf` and `/etc/apcupsd/multimon.conf` are world readable.

To invoke multimon in your Web browser, enter:

```
http://<your-site>/cgi-bin/multimon.cgi
```

You should get something similar to the screen shot shown below.

If you wish additional control over the colors, type faces, and sizes of the multimon output, you may simply edit the `apcupsd.css` file to specify the styles you prefer.

multimon.cgi:

This program monitors multiple UPSes at the same time. A typical output of `multimon.cgi` as displayed in your Web browser might look like the following:

APCUPSD UPS Network Monitor								
Thu Dec 02 17:08:27 CET 1999								
System	Model	Status	Battery Chg	Utility	UPS Load	UPS Temp	Batt. Run Time	Data
Server	SMART-UPS 1000	ONLINE	100.0 %	228.8 VAC	6.2 %	35.1 °C	167.0 mm.	All data
Backup server	SMART-UPS 1000	ONLINE	100.0 %	228.8 VAC	11.4 %	29.2 °C	112.0 mm.	All data
Disk server	SMART-UPS 1000	ONLINE	100.0 %	230.1 VAC	6.2 %	35.1 °C	167.0 mm.	All data

The machines monitored as well as the values and their column headings are all configurable (see `/etc/apcupsd/hosts.conf` and `/etc/apcupsd/multimon.conf`)

upsstats.cgi:

By clicking on the **system** name in the **multimon.cgi** display, you will invoke `upsstats.cgi` for the specified system, which will produce a bar graph display of three of the monitored values. For example,

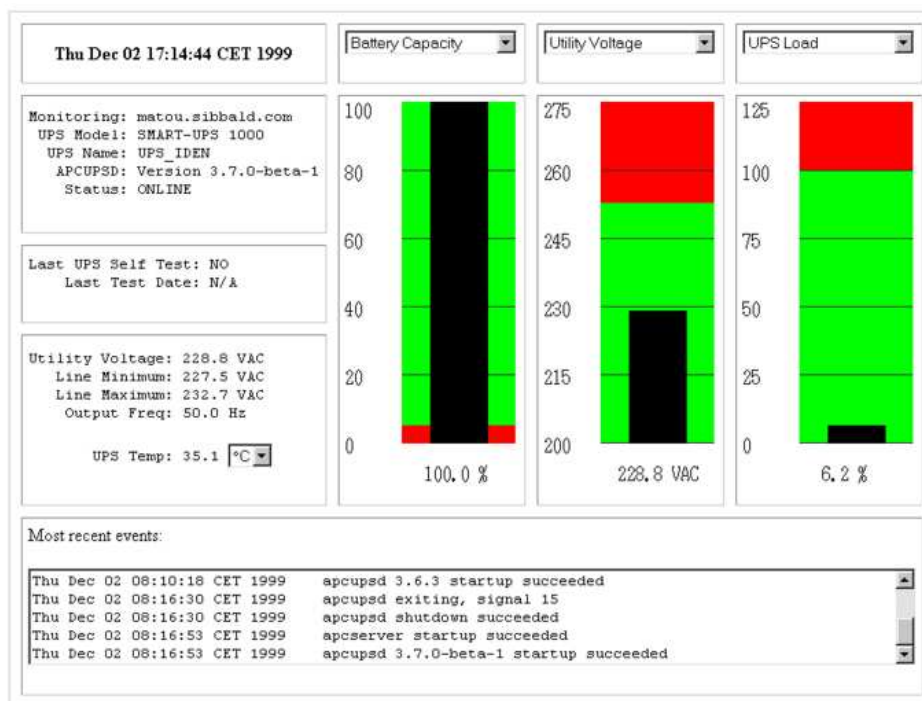

You can display different bar graphs by selecting different variables from the drop down menus at the top of each of the three bar graphs.

As with `multimon`, if you have your local host configured in the `/etc/apcupsd/hosts.conf` file, you can execute it from a Unix shell from the

source cgi directory as follows:

```
./upsstats.cgi
```

As with multimon, quite a few lines of html should then be displayed.

upsfstatus.cgi:

If you would like to see all of the STATUS variables available over the network, click on the **Data** field of the desired system, and your browser will display something like the following:

```
APC      : 001,048,1109
DATE     : Thu Dec 02 17:27:21 CET 1999
HOSTNAME : matou.sibbald.com
RELEASE  : 3.7.0-beta-1
CABLE    : Custom Cable Smart
MODEL    : SMART-UPS 1000
UPSMODE  : Stand Alone
UPSNAME  : UPS_IDEN
LINEV    : 223.6 Volts
MAXLINEV : 224.9 Volts
MINLINEV : 222.3 Volts
LINEFREQ : 50.0 Hz
OUTPUTV  : 223.6 Volts
LOADPCT  : 6.2 Percent Load Capacity
BATTV    : 27.9 Volts
BCHARGE  : 100.0 Percent
MBATTCHG : 5 Percent
TIMELEFT : 167.0 Minutes
MINTIMEL : 3 Minutes
SENSE    : High
DWAKE    : 060 Seconds
DSHUTD   : 020 Seconds
LOTRANS  : 196.0 Volts
HITRANS  : 253.0 Volts
RETPCT   : 050.0 Percent
STATFLAG : 0x08 Status Flag
STATUS   : ONLINE
ITEMP    : 35.1 C Internal
ALARMDEL : Low Battery
LASTXFER : U command or Self Test
SELFTEST : NO
STESTI   : 336
DLOWBATT : 02 Minutes
DIPSW    : 0x00 Dip Switch
REG1     : 0x00 Register 1
REG2     : 0x00 Register 2
```

```
REG3      : 0x00 Register 3
MANDATE   : 01/11/99
SERIALNO  : GS9903001147
BATTDATA  : 01/11/99
NOMOUTV   : 230.0
NOMBATTV  : 24.0
HUMIDITY  : N/A
AMBTEMP   : N/A
EXTBATTS  : 0
BADBATTS  : N/A
FIRMWARE  : 60.11.I
APCMODEL  : IWI
END APC   : Thu Dec 02 17:27:25 CET 1999
```

You should get pretty much the same output mixed in with html if you execute `upsfstats.cgi` directly from a Unix shell in the `cgi` subdirectory as explained above for `upsfstats.cgi` and `multimon.cgi`.

Working Example:

To see a working example of the above programs, visit <http://www.apcupsd.com/cgi-bin/multimon.cgi>.

Client Test Program:

When your Network Information Server is up and running, you can test it using a simple program before attempting to access the server via your Web server. The test program is called `client.c` and can be found in the `examples` subdirectory of the source distribution. To build the program, when in the `examples` directory, use something like the following:

```
cc client.c ../lib/libapc.a -o client
```

Then execute it:

```
./client <host>[:<port>] [<command>]
```

Where **host** is the name of the host or the IP address of the host running the Network Information Server. The default is the local host. You may optionally specify a port address separated from the host name with a colon. You may also optionally specify a single command to be executed. If you

specify a command, that command will be executed and the client program will exit. This is a very simple and useful way of pulling the **status** or **events** data into another program such as Perl.

If no error messages are printed, it has most likely established contact with your server. Anything that you type as standard input will be passed to the server, and anything the server sends back will be printed to standard output. There are currently two commands recognized by the server: **events** and **status**. Hence the following commands:

```
./client
status
events
xyz
^D
```

should produce the status listing (the same as produced by **apcaccess status**), followed by the list of the last 10 events (in response to the **events** command), and finally **Invalid command** in response to the **xyz** input, which is not a valid command. The control-D terminates the **client** program.

The purpose of this program is to show you how to write your own program that can determine the status of **apcupsd** and act any way you want (e.g. send you email messages on certain events like line voltage boost, ...).

A Tip from Carl Erhorn for Sun Systems:

It is possible to run the CGI code to monitor your UPS using the answerbook HTTP server that runs on Solaris. As long as your server has the Answerbook2 web server installed and running, you can insert the cgi scripts into the cgi directory of the web server, and access the cgi using something like:

```
http://hostname:8888/cgi/multimon.cgi
```

Credits:

Many thanks go to Russell Kroll <rkroll at exploits.org> who wrote the CGI programs to work with his UPS Monitoring system named Network UPS Tools (NUT). Thanks also to Jonathan Benson <jbenson at technologist.com> for initially adapting the **upsstatus.cgi** program to work with **apcupsd**.

We have enhanced the bar graph program and hope that our changes can be useful to the original author in his project.

Security Issues:

- **apcupsd** runs as root.
- If you have **NETSERVER ON** in your `apcupsd.conf` file (which is the default), be aware that anyone on the network can read the status of your UPS. This may or may not pose a problem. If you don't consider this information privileged, as is the case for many, there is little risk. In addition, if you have a perimeter firewall or NATting router with typical settings only users on your local network access to your UPS information. You may also restrict access using using firewall settings (see below) or TCP Wrappers (see below).

Firewall Settings

If you are running `apcupsd` as an NIS server, you will need to ensure that the clients can reach it by opening up **NISPORT** (default: TCP 3551) on any firewall running on the server. You may wish to configure your firewall(s) to *only* allow connections from your local network or specifically from the masters, slaves, and servers as needed.

TCP Wrappers

If your operating system does not support a host based firewall (a firewall running on the local machine) then you may try to get some of the functionality of such a firewall with TCP Wrappers. As of `apcupsd` version 3.8.2, TCP Wrappers are implemented if you turn them on when configuring (`./configure --with-libwrap`). With this code enabled, you may control who may access your `apcupsd` via TCP connections (the Network Information Server). This control is done by modifying the file: `/etc/hosts.allow`. This code is implemented but untested. If you use it, please send us some feedback.

Configuring Your EEPROM

If you have a SmartUPS, there are depending on the UPS at least 12 different values stored in the EEPROM that determine how the UPS reacts to various

conditions such as high line voltage, low line voltage, power down grace periods, etc.

In general, for the moment, we do not recommend that you change your EEPROM values unless absolutely necessary. There have been several reported cases of problems setting the Low Transfer Voltage. Consequently, if at all possible, do not attempt to change this value.

If despite these warnings, you must change your EEPROM, we recommend connecting your UPS to a Windows or NT machine running PowerChute and making the changes.

apcupsd No Longer Configures EEPROM:

Unlike version 3.8.6, apcupsd version 3.10.x no longer has code to program the EEPROM. Instead we have implemented interactive EEPROM modification code in the apctest program. EEPROM programming must be done with apcupsd stopped so that apctest can access the UPS. In addition, EEPROM programming is currently implemented only for UPSes using the Smart protocol running in serial mode. Perhaps at a later time when the appropriate kernel modifications are standard, we will extend EEPROM programming to USB models.

Before changing your EEPROM, you should make a printed copy of the current state of your UPS before any EEPROM changes so that you can check the changes that you have made. Do so by printing a copy of the output from `apcaccess status` and also print a copy of the output from `apcaccess eeprom`.

Once this is done, choose which values of the EEPROM you want to change. Typical output from `apcaccess` should look like the following:

```
apcaccess eeprom

Valid EPROM values for the SMART-UPS 1000

Description                Config      Current  Permitted
                           Directive   Value    Values
=====
Upper transfer voltage     HITRANSFER  253      253 264 271 280
Lower transfer voltage     LOTRANSFER  196      196 188 208 204
Return threshold           RETURNCHARGE  0        00 15 50 90
Output voltage on batts    OUTPUTVOLTS 230      230 240 220 225
Sensitivity                SENSITIVITY H         H M L L
Low battery warning        LOWBATT     2        02 05 07 10
Shutdown grace delay       SLEEP      20       020 180 300 600
```

Alarm delay	BEEPSTATE	0	0 T L N
Wakeup delay	WAKEUP	0	000 060 180 300
Self test interval	SELFTEST	336	336 168 ON OFF

where the Current Value will depend on how your UPS is configured, and the Permitted Values will depend on what UPS model you have.

Using apctest to Configure Your EEPROM:

To make the EEPROM changes with apctest you must first stop the apcupsd daemon

apctest is not installed during the installation process, so to use it you will need to do the following after having built apcupsd:

```
cd <apcupsd-source>/src
su
<root-password>
./apctest
```

At that point, you should get output similar to the following:

```
2003-07-07 11:19:21 apctest 3.10.6 (07 July 2003) redhat
Checking configuration ...
Attached to driver: apcsmart
sharenet.type = DISABLE
cable.type = CUSTOM_SMART
```

```
You are using a SMART cable type, so I'm entering SMART test mode
mode.type = SMART
Setting up serial port ...
Creating serial port lock file ...
Hello, this is the apcupsd Cable Test program.
This part of apctest is for testing Smart UPSes.
Please select the function you want to perform.
```

- 1) Query the UPS for all known values
- 2) Perform a Battery Runtime Calibration
- 3) Abort Battery Calibration
- 4) Monitor Battery Calibration progress
- 5) Program EEPROM
- 6) Enter TTY mode communicating with UPS
- 7) Quit

Select function number:

You might want to run option 1) just to ensure that apctest is properly talking to your UPS. It will produce quite about 70 lines of output.

To program the EEPROM, select option 5), and you will get the EEPROM menu as follows:

```
This is the EEPROM programming section of apctest.  
Please select the function you want to perform.
```

- 1) Print EEPROM values
- 2) Change Battery date
- 3) Change UPS name
- 4) Change sensitivity
- 5) Change alarm delay
- 6) Change low battery warning delay
- 7) Change wakeup delay
- 8) Change shutdown delay
- 9) Change low transfer voltage
- 10) Change high transfer voltage
- 11) Change battery return threshold percent
- 12) Change output voltage when on batteries
- 13) Change the self test interval
- 14) Set EEPROM with conf file values
- 15) Quit

```
Select function number:
```

If you wish to use the old pre-3.10.x method of EEPROM programming with values specified in the apcupsd.conf file, select option 14). However, we recommend that you start with item 1) to see what EEPROM values apctest finds. This command can take a few minutes to run, so be patient. The values printed should be the same as what you got using apcaccess, but in addition, the EEPROM battery date and UPS Name should be displayed. For example:

```
Select function number: 1
```

```
Doing prep_device() ...
```

```
Valid EEPROM values for the SMART-UPS 1000
```

Description	Config Directive	Current Value	Permitted Values
Upper transfer voltage	HITRANSFER	253	253 264 271 280
Lower transfer voltage	LOTRANSFER	196	196 188 208 204
Return threshold	RETURNCHARGE	0	00 15 50 90
Output voltage on batts	OUTPUTVOLTS	230	230 240 220 225
Sensitivity	SENSITIVITY	H	H M L L

Low battery warning	LOWBATT	2	02 05 07 10
Shutdown grace delay	SLEEP	20	020 180 300 600
Alarm delay	BEEPSTATE	0	0 T L N
Wakeup delay	WAKEUP	0	000 060 180 300
Self test interval	SELFTEST	336	336 168 ON OFF

```

=====
Battery date: 07/31/99
UPS Name      : UPS_IDEN

```

At this point, you can select any item from 2) to 13) to modify the appropriate value. You will shown the existing value and prompted for the new values.

We recommend that you change the EEPROM as little as is absolutely necessary since it is a somewhat delicate process that has occasionally produced problems (i.e. improper EEPROM values are displayed after the update). Fortunately this seems to be quite rare and was much more likely to occur with the old “batch” like process especially if incorrect values were supplied.

Maintaining Your UPS

If you have your UPS long enough, you will probably have battery problems. Below, you will find some suggestions for replacing batteries. One *important* note of caution: at least one user purchased one of the non-APC batteries noted below and found out that they would not fit into his unit. This required cutting and soldering and other very undesirable things, so be extremely careful in measuring the batteries including every millimeter of the terminal connections which can cause problems.

Although you can do a hot swap of your batteries while the computer is running, it may not be very satisfactory because the unit will not know that the batteries have been swapped and apcupsd will continue to show Low Battery. To correct this situation, you must do a discharge and recharge of the battery followed by a battery recalibration using apctest. At that point the battery should be calibrated better. As noted below, Carl has found that it takes several discharge/charges before the runtime calibration is accurate. Take care not to discharge your battery too much as it tends to shorten the battery life.

What Various People Have to Say about Batteries

Here is what John Walker has to say about APC UPS batteries:

I thought I'd pass on some information I've obtained which you'll probably eventually need. Besides, by writing it down I'll be able to find it the next time. I started installing mine in 1995-1996. Lead-acid batteries have a finite life even if not subjected to deep discharge cycles. For the batteries used by APC, this is typically four to six years. As part of the self-test cycle, the UPS measures the voltage of the battery at full charge (which falls as the battery ages), and if it's below about 90% of the value for a new battery, it sets off the "Replace battery" alarm, which it repeats every day. [on apcupsd versions prior to 3.8.0, this message is sent once, on version 3.8.0, it is sent every 9 hours - KES]. You will occasionally get a false alarm. It's a good idea if you get an alarm to repeat the self-test the next day and see if the alarm goes away. If the alarm is persistent, you need to replace the batteries, which can be done without powering down the UPS or load-you just open up the battery door, take out the old batteries, and hook up the new ones.

APC makes "Replacement Battery Units" for each of the SmartUPS models, but they sell them directly only in the U.S.

It's best to wait until the low battery alarm before ordering a replacement-keeping batteries on the shelf reduces their life unless you keep them fully charged.

And Andre Hendrick says:

[For replacement batteries] You need to goto you your local Yamaha SeaDoo shop. There are 35 AMP Hour deep cycle marine batteries that are direct replacements. These are gel-cel and will double the runtime and/or cut your recharge time in half.

Jet Works
1587 Monrovia Ave.
Newport Beach CA 92667
Tel: +1 714 548-5259

J-W Batteries, Inc.
Tel: +1 714 548-4017

WPS 49-1200
GEL-CELL KB-35 BATTERY

For those that do not know what this means..... I found the best battery for APCC UPS products that use In the two systems below:

```
SMART-UPS 3000 10.9% is running at 327W runs for 47.0 min.
Smart-UPS 1250 22.3% is running at 279W runs for 54.0 min.
```

```
APCUPSD UPS Network Monitor
Thu Jan 18 21:55:36 PST 2001
System Model Status Battery Chg Utility UPS Load UPS Temp Batt. Run Time Data
Linux ATA Development SMART-UPS 3000 ONLINE
      100.0 % 120.2 VAC 10.9 % 36.9 C 47.0 min. All data
Linux ATA Development II APC Smart-UPS 1250 ONLINE
      100.0 % 119.6 VAC 22.3 % 45.9 C 54.0 min. All data
```

Look at the numbers and see that these batteries are better and have more total running energy than standard ones.

```
SMART-UPS 3000 10.9% is running at 327W runs for 47.0 min.
Smart-UPS 1250 22.3% is running at 279W runs for 54.0 min.
```

```
APCUPSD UPS Network Monitor
Thu Jan 18 22:00:45 PST 2001
System Model Status Battery Chg Utility UPS Load UPS Temp Batt. Run Time Data
Linux ATA Development SMART-UPS 3000 ONLINE
      100.0 % 120.2 VAC 19.2 % 36.9 C 27.0 min. All data
Linux ATA Development II APC Smart-UPS 1250 ONLINE
      100.0 % 119.6 VAC 21.8 % 45.9 C 55.0 min. All data
```

```
SMART-UPS 3000 19.2% is running at 576W runs for 27.0 min.
Smart-UPS 1250 21.8% is running at 273W runs for 55.0 min.
Smart-UPS 1250 46.1% is running at 576W runs for 26.0 min.
```

Kind of cool.

The 1250 can outrun the 3000 by a factor of two under identical percentages, or run head to head for the same time.

SMART-UPS 3000 is a 48V based or 4 batteries. Smart-UPS 1250 is a 24V based or 2 batteries.

Cheers,

```
Andre Hedrick
Linux ATA Development
```

Finally, here is what Carl Erhorn has to say about batteries:

Hi, Folks.

Well, Kern was absolutely right. The problem with my UPS was batteries. It was unexpected though, because there was no indication of a bad battery right up until the UPS failed entirely. For those who might encounter the same thing, and don't know what's happening (I didn't either), here's what happened.

A week or so ago, I turned on one of my SmartUPS 700-NET models. The load is a small dual P-III unix server (Solaris 8, X86) and a 4MM tape drive. During the normal selftest that runs when you first turn on any APC UPS, the UPS 'freaked out'. The alarm stuttered at about 4 or 5 beeps per second, and all the panel lights flashed spasmodically, as if something was loose inside the UPS.

I turned off the UPS and it's load, then turned the UPS on again. This time, everything seemed fine. I booted the system that was attached, and there were no problems. The status monitor showed 9 minutes runtime (which indicates fairly low capacity), but the batteries showed fully charged. I began to suspect a bad inverter in the UPS.

However, Kern told me that he suspected the batteries. So I took the UPS offline, put an old SU-600 in it's place (just barely big enough to handle the startup peaks - I get an 'overload' lamp lit for about 2 seconds during boot), and checked out the batteries. They did indicate that they were near the end of life, so I ordered a replacement set. Those came in on Friday, and after the initial charge, a complete charge/discharge cycle to recalibrate the UPS, and some testing, I put it back in service.

Surprise! (Or maybe not?) Kern was right - there is nothing wrong with the inverter or the charging circuit, and the new cells fixed everything.

What confused me is that there was no 'replace battery' indication from the UPS, even when it failed, plus a fair amount of runtime indicated with a full charge. So if you see such behavior on one of your UPS models, it makes sense to replace the batteries, even if there is no indication that the batteries have failed yet.

One of the things I learned during this process is that the UPS internal calibration will lose accuracy over the life of the battery. I always do a recalibrate when I install new cells, but rarely do it after that, as it's time-consuming, and you really can't use the system attached to the UPS while doing it. Since my systems are almost constantly in use, it's a pain to schedule a recal, and I tend to put it off. This time it bit me. I'd suggest that folks do

a recal at least once every six months. It will make your runtime estimates much more accurate, and also allows you to keep track of the state of your batteries.

For those who don't know how to do this, here's what you do. This procedure should not be confused with the 'Recalibrate' feature in the APC PowerchutePlus software. They do not do the same thing.

>From APC's web site:

Perform a Runtime Calibration. This is a manual procedure and should not be confused with the runtime calibration performed through PowerChute plus. The batteries inside of the Smart-UPS are controlled by a microprocessor within the UPS. Sometimes it is necessary to reset this microprocessor, especially after the installation of new batteries. Stop the PowerChute plus software from running and disconnect the serial cable. There must be at least a 30% load attached to the UPS during this procedure, but the process will cause the UPS to shut off and cut power to its outlets. Therefore, attach a non-critical load to the UPS and then force the UPS on battery by disconnecting it from utility power. Allow the unit to run on battery until it turns off completely. Make sure a 30% load is present! Plug the UPS back into the wall outlet and allow it to recharge (it will recharge more quickly turned off and with no load present). Once the unit has recharged, the "runtime remaining" calculation should be more accurate. Remember that if the unit is an older model, then the runtime will not improve significantly.

Background:

An APC Smart-UPS has a microprocessor which calculates runtime primarily based on the load attached to the UPS and on its battery capacity. On the right side of the front display panel there is a vertical graph of five LEDs. Each LED is an indication of battery charge in increments of twenty percent: 20, 40, 60, 80, 100% (bottom to top). For example, if the battery charge is 99%, then only four of the five LEDs are illuminated.

To ensure that an operating system receives a graceful shutdown when using PowerChute plus or a SmartSlot accessory, an alert is generated by the Smart-UPS indicating that the UPS has reached a low battery condition. The alert is audible (rapid beeping), visual (flashing battery LED or LEDs), and readable through the graphical interface of PowerChute plus software (or a native UPS shutdown program within a particular operating system.) In order to calculate this "low battery condition," all

Smart-UPS products have a preconfigured low battery signal warning time of two minutes (this is the factory default setting). There are a total of four user-changeable settings: 2, 5, 7, or 10 minutes. If the low battery signal warning time is set for 2 minutes, then the alerts will activate simultaneously two minutes prior to shutdown. Similarly, if the total runtime for a particular UPS is 30 minutes with a low battery signal warning time set at 10 minutes, then the UPS will run on battery for 20 minutes before the low battery alert begins.

Total runtime is primarily based on two factors, battery capacity and UPS load. UPS load and runtime on battery are inversely proportional: as load increases, battery runtime decreases and vice versa. When utility power is lost, the UPS begins discharging the battery in order to support the attached load. Once power returns, the Smart-UPS will automatically begin to recharge its battery.

My comments on this procedure:

I believe this procedure works for all APC models that calculate runtime, not just the SmartUPS. It's important that you load the UPS to 30% of the UPS capacity, as reported by apcupsd or another UPS monitor program. I've found that normal house lamps of different wattages allow me to adjust the load to almost exactly what I want, which is between 30% and 35% of the UPS capacity. This is critical to getting an accurate reading (according to the APC web documents). Always bring the UPS to 100% charge first, as indicated by the front panel lamps, or your UPS monitoring software.

Set the UPS shutdown time to 2 minutes, all other settings to nominal, and disconnect the serial port cable from the UPS before running the recalibration. If you leave a monitoring program running through the serial port, it will turn the UPS off early, and you don't want to do that during a recalibration run. When the run is complete, and the UPS turns off, you can reattach the serial cable, and the normal loads, and recharge the batteries normally. If you think you might have a power outage during the recharge time, allow the UPS to recharge to 20% or so (indicated by the panel lamps) before trying to use the computer system. This will allow the UPS to handle short dropouts while it recharges. Of course, if you can leave the computer off during the recharge time, the UPS will recharge much faster.

As an aside, when the batteries failed, my total runtime at 100% charge and an idle state was 9 minutes, which is pretty

bad. I replaced the batteries with extended capacity cells, which add about 15% to the stock capacity. Now, after two complete charge/ discharge cycles, 100% charge shows the available runtime to be 42 minutes on the system when it's idle, and 33 minutes when the system is very busy. The differences are due to the load of the computer, when the disks are busy, and the cpus are not in a halted state (my system halts the cpus when they are idle, to save power and lower heat, as do other OS like Linux), when compared to an idle state. Apcupsd indicates the load is about 27% when idle, and as much as 37% when heavily loaded.

I've found that two charge/discharge cycles result in a more accurate recalibration when installing new cells. It appears that some batteries need to be put through a couple of complete cycles before they reach their full capacity. I've also noticed that the full-charge voltage is different for each battery until they have been through two cycles. On the initial charge of my new batteries, the 100% charge voltage on the two cells was almost .5 VDC apart. After two complete cycles, the batteries measure within .01 VDC of each other!

I hope this information helps anyone who might encounter the problem I saw, and also shows folks how to recal their batteries. If you haven't done a complete recalibration in a year or two, I'd recommend it, so that you have warning of a low battery instead of what happened to me.

Regards,
—Carl

Where Carl Suggests You Get Batteries

Hi, Folks.

I'm just replacing the batteries in one of my SmartUPS models, and it occurs to me that some of you may not know about the place I get them from. I have no relationship with this company, other than as a customer, but I feel they know what they are doing, their prices are fair, and they have some interesting batteries available that you can't obtain from APC.

These are the reasons I use them, and I thought this information might be useful to the US list members. They will ship outside of the US. If you have questions, you can contact them through

the email address listed on their web pages. They have always responded pretty quickly to my questions.

The company is called Battery Wholesale Distributors, and they are located in Georgetown, Texas. If you have questions, you can reach them by phone at (800) 365-8444, 9:00AM to 5:00PM (their local time), Monday through Friday. I've gotten email from them on the weekends, although the office is not open then.

I won't post prices, as you can get current pricing from their web site. They have an entire section dedicated to APC replacement batteries, and it's easy to find what you need. You can order over the web, or by phone. They accept all the usual credit cards.

The web site (as you might guess) is: www.batterywholesale.com

The thing I really like is that they have found manufacturers who make batteries in the standard case sizes, but have additional capacity over the original batteries shipped with the APC UPS models. Often, the difference is as much as 15% or so, and this can result in additional runtime. It's a nice upgrade for a minor increase in price.

They are also 'green-aware', in that they encourage you to recycle your old batteries, and will accept the old batteries back from you if you cannot find a local place that recycles them. You pay the shipping, but I think other than that, there is no charge. I've never done this, as I have a battery retailer just down the street who will accept my old batteries.

Anyway, if you didn't know about these folks, put the info aside where you can find it when you need replacement batteries. I won't make any guarantees, but I've been very pleased with their products, service, and pricing. I hope you find them as helpful to you as I do. I've been dealing with them since about 1994, and have never been disappointed. The owner of the place also is very good on technical issues, so if you have questions on their products, he can get as technical as you need to go.

Regards,
--Carl

Here is a link to the APC Battery Store.

Frequently-Asked Questions

See the bugs section of this document for a list of known bugs and solutions.

Q: Why all the craziness with custom serial cables?

A: It was nothing more nor less than a form of customer control. For a long time APC wanted to keep other people from talking to its UPSes so it could lock out potential competition for its PowerChute software. Scrambling the leads on its serial cables was a cheap way to accomplish this – in fact, they tended to be wired so that if you tried a straight-through cable, opening a serial link to the UPS would be interpreted as a shutdown command!

(Hardware companies often think like this – they lock up interfaces by instinct, cornering a small market rather than growing a bigger one. It's fundamentally stupid and self-defeating, but it's the kind of stupid that tends to sound good at an executive meeting.)

Fortunately, APC has lost a lot of this attitude since about 2000; nowadays they even release technical information to the apcupsd maintainers.

Q: What UPS brands does apcupsd support?

A: Currently apcupsd supports only APC UPSes. However, some companies such as Hewlett Packard put their own brand name on APC manufactured UPSes. Thus even if you do not have an APC branded UPS, it may work with apcupsd. You will need to know the corresponding APC model number. apcupsd supports all the popular APC models. See the installation and configurations sections of this document for more details.

Q: Does apcupsd support Windows?

A: With release 3.8.0, apcupsd now runs on Win95/98, WinMe, WinNT, and Win2000 machines. All features of the Unix versions of apcupsd are implemented. The UPS EEPROM programming features of apcupsd have not been tested under Windows. Version 3.8.0 does not support simple signaling UPSes (BackUPS, etc). Version 3.8.1 does support most simple signaling UPSes, but not all cables (due to deficiencies in the Windows serial port API). Please note that we have had reports that apcupsd does not work properly on the WinXP system. If you have any information on this, please email us.

Q: I don't have a cable, which one should I build?

A: First you must know if you have an apcsmart UPS or a voltage-signalling UPS. See the table of supported UPSes (see `type_table`). If you have a apcsmart UPS, we recommend building a Custom Smart (see Smart-Custom Cable for SmartUPSes) cable. If you have a voltage-signaling UPS, we recommend that you build a Custom Simple (see Voltage-Signalling Cable for "dumb" UPSes) cable.

Q: How much CPU resources does apcupsd use?

A: Depending on your CPU speed, you may see more or less of the CPU consumed by apcupsd. On a 400MHz Unix system, the CPU usage should fall well below 0.1%. On slower systems, the percentage will increase proportionally to the decrease in the CPU speed. On a 400Mhz Win98 machine, the CPU usage will be on the order of 0.5-1.0%. This is higher than for Unix systems. However, compared to the 30% CPU usage by APC's PowerChute (the version on the CDROM shipped with my UPS), apcupsd's 0.5-1.0% is very modest.

Q: What language is apcupsd written in?

A: It is written entirely in C.

Q: We are using apcupsd-3.8.1-1 in RedHat 6.2. The slave, when shutting down, is reporting an error at line 436 of apcupsd.c. The error is initiated by `apcupsd --killpower!` What can we do to fix this, and is it critical?

A: No, the error is not serious. Unfortunately, the documentation in the area of master/slaves is not very detailed, and for that reason, your slave setup is not totally correct as explained below.

On master machines, we modify `/etc/rc.d/init.d/halt` to re-invoke apcupsd with the `--killpower` option (actually the script `apcontrol` is called). This causes the UPS to send the codes to the UPS to make it power off.

On slave machines, these modifications should not be made to the `/etc/rc.d/init.d/halt` script since the slave has no connection to the UPS.

To eliminate the problem, on all your slave machines, either restore the original halt file, or simply delete all the lines containing `***apcupsd***`, which were inserted by the apcupsd installation process.

Q: To test apcupsd, I unplugged the UPS to simulate a power outage. After the machine went into the shutdown process I plugged the UPS back into the commercial power source. This caused the shutdown process

to hang after the daemon tried to shut-off the ups. Have you run into this problem, and if so do you have a remedy?

A: Normally, once the shutdown process has begun, we cannot stop it, though there *is* some code that tries to do so, we don't consider it a very good idea – how do you stop a shutdown that has killed off half of the daemons running on your system? Most likely you will be left with an unusable system. In addition, when `apcupsd` is re-executed in the halt script after the disks are synced, it tries to shut off the UPS power, but the UPS will generally refuse to do so if the AC power is on. Since we cannot be 100% sure whether or not the UPS will shut off the power, we don't attempt to reboot the system if we detect that the power is back as it might then get caught by a delayed power off (at least for Smart UPSes).

Q: After running `apcupsd` for a while, I get the following error: “Serial communications with UPS lost.” What is the problem?

A: We use standard Unix serial port `read()` and `write()` calls so once a connection is made, we generally have few problems. However, there have been reports that APC's SNMP Management Card can cause serial port problems. If you have such a card, we suggest that you remove it and see if the problem goes away. It is also possible that some other process such as a `getty` is reading the serial port.

Q: When `apcupsd` starts, I get the following error: “attach_shmarea: cannot get shm area: Identifier removed.” What is the problem?

A: This problem and the problem of **cannot create shm area** are due to the fact that the shared memory key that `apcupsd` wants to use is already in use. This happens most frequently when there is an old zombie `apcupsd` process still in the system. The solution is to remove the old process. You can often see what is going on by doing a: `ipcs` command as root when `apcupsd` is not running. If you see a segment with the key `0x10feed01`, you can be sure there is some old `apcupsd` process still using it. If you cannot kill the old process, you can try using `ipcrm` (see the man pages). Recent versions of `apcupsd` starting with `apcupsd-3.8.2Beta6` should no longer have this problem as they will automatically try using a different key.

Q: I get the following error: “Starting `apcupsd` power management. Mar 20 21:19:40 box `apcupsd`[297]: `apcupsd` FATAL ERROR in `apcserial.c` at line 83. Cannot open UPS tty `/dev/cua01`: No such file or directory.” What is the problem?

A: The two most likely causes of your problem are: 1. You have the wrong serial port device name in the `apcupsd.conf` file. 2. The device name

is not defined on your system. Suggestions for proceeding: For the first item, check what your serial port device should be named. You might be able to find the name with an:

```
ls /dev
```

Normally there will be hundreds or even thousands of names that print. If that doesn't produce anything useful, you can try step 2. Perhaps your device is not defined. To get more information on your devices try `man MAKEDEV` or `find / -name MAKEDEV`. It is often located in `/dev/MAKEDEV`. Looking at the documentation may tell you what the correct name is, or at least allow you to create the device.

Q: How do I ensure that the slaves shutdown before the master?

A: There are several strategies for getting the slaves properly shutdown before shutting down the master. The first is to make the master wait a period of time for the slaves to shutdown before doing its own shutdown. Currently, the master always waits 30 seconds before starting its own shutdown. If this is insufficient, you can add additional time by putting an appropriate **sleep** shell command in the `/etc/apcupsd/apccontrol` file just before the actual system shutdown command is executed (there are something like 3 places). The second strategy is to put a `TIMEOUT` value in the `apcupsd.conf` file on the slave that is sufficiently short that you are sure that the slave will shutdown before the master. If the shutdown is done with a `poweroff`, this will also save power so that the master can stay up longer.

Q: How do I ensure that my database server is correctly shutdown?

A: You simply add whatever commands are necessary in the appropriate case statements in `/etc/apcupsd/apccontrol`, which is a standard script file that is called to actually do the shutdown. Alternatively, you can add your own script file that will be called before doing the commands in `apccontrol`. Your script file must have the same name as the appropriate case statement in `apccontrol`; it must be executable; and it must be in the same directory as `apccontrol`.

Q: I have Win2k Advanced server, and when starting the service, get: Could not start the Apcupsd Server service on Local Computer. Error 1067: The process terminated unexpectedly

A: The most common error causing your problem is an incorrect serial port specification on your `DEVICE` directive. It should be:

DEVICE /dev/com2

On WinNT machines, and probably Win2000 machines you **MUST** use /dev/com2 unless you modify the behavior of the boot process to prevent Windows from probing the port. This is documented in our manual for WinNT. Although I imagine it is the same for Win2000, I am not sure.

The second most common problem is bad placement of the files i.e. you did not install them in c:\apcupsd Unfortunately for the current release, this path is “hard coded” into the binaries.

The third most common problem is that you did not run the setup.bat script after loading the files. This is necessary to install apcupsd as a service.

If all the above fails, try starting apcupsd by hand inside a CYGWIN rxvt window if you use an rxvt window rather than a DOS window, you will see many more of the error messages.

In addition, most of the apcupsd startup errors are reported in: c:\apcupsd\etc\apcupsd\apcupsd.events

Many error messages associated with Windows services will be reported in the Windows System Log.

Q: When using USB, I get the following log messages: usb-uhci.c: interrupt, status 3, frame# 826. What does it mean?

A: It means one transfer worked (bit 0 in status) and another one (after that) failed (bit 1) at time frame 826. This kind of soft error is common on USB and if everything seems to be working, you can ignore it.

Apcupsd Bugs

Unfortunately, it seems that every program has some bugs. We do our best to keep the bugs to a minimum by extensive testing. However, because of our inherent nature to occasionally overlook things and the fact that we don't have all the UPS models nor the APC documentation on those models, apcupsd will have some bugs.

As the bugs become known to us, we will post them on the bug tracking system at SourceForge.

Advanced topics

Customizing Event Handling

When `apcupsd` detects anomalies from your UPS device, it will make some decisions that usually result in one or more calls to the script located in `/etc/apcupsd/apccontrol`. The **apccontrol** file is a shell script that acts on the first argument that `apcupsd` passes to it. These actions are set up by default to sane behavior for all psituations `apcupsd` is likely to detect from the UPS. However, you can change the `apccontrol` behavior for every single action.

To customize, so create a file with the same name as the action, which is passed as a command line argument. Put your script in the `/etc/apcupsd` directory.

These events are sent to the system log, optionally sent to the temporary events file (`/etc/apcupsd/apcupsd.events`), and they also generate a call to `/etc/apcupsd/apccontrol` which in turn will call any scripts you have placed in the `/etc/apcupsd` directory.

Normally, `/etc/apcupsd/apccontrol` is called only by `apcupsd`. Consequently, you should not invoke it directly. However, it is important to understand how it functions, and in some cases, you may want to change the messages that it prints using `wall`. We recommend that you do so by writing your own script to be invoked by **apccontrol** rather than by modifying `apccontrol` directly. This makes it easier for you to upgrade to the next version of `apcupsd`.

In other case, you may want to write your own shell scripts that will be invoked by `apccontrol`. For example, when a power fail occurs, you may want to send an email message to root. At present the arguments that `apccontrol` recognizes are:

When `apcupsd` detects an event, it calls the `apccontrol` script with four arguments as:

```
apccontrol <event> <ups-name> <connected> <powered>
```

where:

event is the event that occurred and it may be any one of the values described in the next section.

ups-name is the name of the UPS as specified in the configuration file (not the name in the EEPROM). For version 3.8.2, this is always set to **Default**

connected is 1 if apcupsd is connected to the UPS via a serial port (or a USB port). In most configurations, this will be the case. In the case of a Slave machine where apcupsd is not directly connected to the UPS, this value will be 0.

powered is 1 if the computer on which apcupsd is running is powered by the UPS and 0 if not. At the moment, this value is unimplemented and always 0.

apccontrol Command Line Options

apccontrol accepts the following command line options:

annoyme When a shutdown is scheduled, and the time specified on the ANNOYME directive in the apcupsd.conf file expires, this event is generated.

Default — does a `printf ‘‘Power problems please logoff.’’ | wall` then exits.

changeme When apcupsd detects that the mains are on, but the battery is not functioning correctly, this event is generated. It is repeated every x hours.

Default — does a `printf ‘‘Emergency! UPS batteries have failed\nChange them NOW’’ | wall` then exits.

commfailure This event is generated each time the communications line with the computer is severed. This event is not detected on dumb signaling UPSes.

Default -does a `printf ‘‘Warning serial port communications with UPS lost.’’ | wall` then exits.

commok After a commfailure event is issued, when the communications to the computer is re-established, this event will be generated.

Default — does a `printf ‘‘Serial communications with UPS restored.’’ | wall` then exits.

doreboot This event is depreciated and should not be used.

Default - does a reboot of the system by calling `shutdown -h now`

doshutdown When the UPS is running on batteries and one of the limits expires (time, run, load), this event is generated to cause the machine to shutdown.

Default does a shutdown of the system by calling `shutdown -h now`

emergency Does an emergency shutdown of the system by calling `shutdown -h now`

failing This event is generated when the UPS is running on batteries and the battery power is exhausted. The event following this one will be a shutdown.

Default — does a `printf ‘‘UPS battery power exhausted. Doing shutdown.\n’’ | wall` then exits.

loadlimit This event is generated when the battery charge is below the low limit specified in the `apcupsd.conf` file.

Default — does a `printf ‘‘UPS battery discharge limit reached. Doing shutdown.\n’’ | wall` then exits. After completing this event, `apcupsd` will immediately initiate a `doshutdown` event.

mainsback This event is generated when the mains power returns after a powerout condition. The shutdown event may or may not have been generated depending on the parameters you have defined and the length of the power outage. A cancel of a shutdown should never be attempted as it is very unlikely to succeed and will almost surely leave your machine in an indeterminate state.

Default — attempts to cancel the shutdown with a `shutdown -c` (not sure about that!!!!)

onbattery This event is generated 5 or 6 seconds after an initial powerfailure is detected. It means that `apcupsd` definitely considers the UPS to be on batteries. The onset of this event can be delayed by the `ONBATTERYDELAY` `apcupsd.conf` configuration directive.

Default — does a `printf ‘‘Power failure. Running on UPS batteries.’’ | wall` then exits.

offbattery This event is generated when the mains return only if the `onbattery` event has been generated.

Default — does nothing.

powerout This event is generated immediately when `apcupsd` detects that the UPS has switched to batteries. It may be due to a short powerfailure, an automatic selftest of the UPS, or a longer powerfailure. In

many cases, you may want to inhibit the normal message sent/emailed by this event to avoid being annoyed by short power failures.

Default — does a `printf ‘Warning power loss detected.’ | wall` then exits.

remotedown This event is generated on a slave machine when it detects either that the master has shutdown, or that a onbattery situation exists and the communications line has been severed.

Does a `shutdown -h now`

restartme This event is depreciated and should not be used.

Terminates the currently running `apcupsd` and then restarts it.

runlimit This event is generated when the MINUTES value defined in the `apcupsd.conf` file expires while in a power fail condition. The MINUTES is the remaining runtime as internally calculated by the UPS and monitored by `apcupsd`.

Does a `printf ‘UPS battery runtime percent reached. Doing shutdown.\n’ | wall` then exits. After completing this event, `apcupsd` will immediately initiate a `doshutdown` event.

timeout This event is generated when the TIMEOUT value defined in the `apcupsd.conf` file expires while in a power fail condition. It indicates that the total time in a power failure has been exceeded and the machine should be shutdown. Normally, with smart UPSes, this value is not used, but rather one relies on the remaining runtime (MINUTES) or the battery level (BATTERYLEVEL) values specified in the conf file.

Does a `printf ‘UPS battery runtime limit exceeded. Doing shutdown.\n’ | wall` then exits. After completing this event, `apcupsd` will immediately initiate a `doshutdown` event.

startselftest This event is generated when `apcupsd` detects a self test by the UPS. Normally due to the 6 second onbattery delay default time, self test events are not detected.

This is called when `apcupsd` detects that the UPS is doing a self test. No action is taken.

endselftest This event is generated when the end of a self test is detected.

This is called when `apcupsd` determines that a self test has been completed. No action is taken.

battdetach This event is generated when `apcupsd` detects that the UPS battery has been disconnected.

battattach This event is generated when apcupsd detects that the UPS battery has been reconnected after a battdetach event.

To write your own routine for the **powerout** action, you create shell script named **powerout** and put it in the lib directory (normally /etc/apcupsd). When the **powerout** action is invoked by apcupsd, apccontrol will first give control to your script. If you want apccontrol to continue with the default action, simply exit your script with an exit status of zero. If you do not want apccontrol to continue with the default action, your script should exit with the special exit code of **99**. However, in this case, please be aware that you must ensure proper shutdown of your machine if necessary.

Some sample scripts (onbattery and mainsback) that email power failure messages can be found in /etc/apcupsd after an install or in the platforms/etc directory of the source code.

Controlling Multiple UPSes on one Machine

You may want to use your server to control multiple UPSes. This is possible by proper configuration and by running one copy of apcupsd for each UPS to be controlled (recall the Configuration types.).

Configuration

The way to accomplish the above is to ensure that none of the critical files used by each of the two copies of apcupsd are the same. By using suitable configuration options, this is possible.

The First Copy of apcupsd:

For example, assuming you have SmartUPSes in both cases, to configure and install the first copy of apcupsd, which controls a UPS and Computer A, one could use the following configuration:

```
./configure \  
  --prefix=/usr \  
  --sbindir=/sbin \  
  --with-cgi-bin=/home/http/cgi-bin \  
  --enable-cgi \  
  --with-css-dir=/home/http/css \  
  \
```

```
--with-log-dir=/etc/apcupsd \  
--with-serial-dev=/dev/ttyS0 \  
--with-nis-port=3551 \  
--enable-powerflute
```

This is pretty much a “normal” installation using many of the defaults. Once built and installed, this would control the first UPS and cause a shutdown of the system when the batteries are low. This copy of apcupsd will be started and stopped automatically when the system is booted and halted.

The Second Copy of apcupsd:

To configure and install the second copy of apcupsd, which controls the second UPS and Computer B, you could use the following configuration:

```
./configure \  
--prefix=$HOME/apcupsd/bin \  
--sbindir=$HOME/apcupsd/bin \  
--enable-cgi \  
--with-cgi-bin=$HOME/apcupsd/bin \  
--with-log-dir=$HOME/apcupsd/bin \  
--with-pid-dir=$HOME/apcupsd/bin \  
--sysconfdir=$HOME/apcupsd/bin \  
--with-lock-dir=$HOME/apcupsd/bin \  
--with-pwrfail-dir=$HOME/apcupsd/bin \  
--with-serial-dev=/dev/ttyS1 \  
--with-nis-port=7001 \  
--disable-install-distdir
```

Note, in this case, we use considerably more configuration options to ensure that the system files are placed in a different directory (\$HOME/apcupsd/bin). We have also selected a different serial port and a different NIS (Network Information Server) port. And finally, we have used the `--disable-install-distdir` option, which prevents `make install` from doing the final system installation (i.e. the modification of the halt script) since this was previously done.

Important Steps after Installation of the Second Copy:

After the `make install` of the second copy of apcupsd there are a number important steps to complete. You must either remove or modify the file \$HOME/apcupsd/bin/apccontrol, so that it will not shutdown Computer

A when the battery of UPS 2 is low. One suggestion is to copy examples/safe.apccontrol into \$HOME/apcupsd/bin/apccontrol. Alternatively, you could edit the \$HOME/apcupsd/bin/apccontrol and delete all statements that attempt to shutdown the machine. Another important step is to find a way to shutdown Computer B when UPS 2's battery is low. Probably the simplest way to do this is to edit \$HOME/apcupsd/bin/apcupsd.conf on Computer A so that this second copy of apcupsd becomes a network master. Then install a standard slave configuration on Computer B. Please remember that if UPS 1's batteries are exhausted before UPS 2's batteries, Computer B may not be properly shutdown. And at the current time, there is no simple means to make the two copies of apcupsd running on Computer A communicate. Thus there are certain risks in such a configuration. However, these configurations can be very useful for powering electronic equipment and such.

If Computer B is vitally important, it would probably be better to purchase a serial port card for it, or perhaps use a USB UPS. To ensure that it is properly shutdown if Computer A goes down, you could run a second copy of apcupsd on Computer B as a slave connected to the main copy of apcupsd on Computer A. Thus Computer B would be running two slaves, one driven by the master controlling UPS 1 and the other by the master controlling UPS 2, and Computer B could be shutdown by the first master that signaled it to do so.

Support for SNMP UPSes

To run apcupsd with a SNMP UPS, you need the following things:

- An SNMP UPS, for example a Web/SNMP (AP9716) or PowerNet SNMP (AP9605) card installed into the SmartSlot.
- apcupsd version 3.10.0 or higher
- Net-SNMP library (previously known as ucd-snmp) installed

Planning and Setup for SNMP Wiring

SNMP packet requests are relayed to the UPS from monitoring APCUPSD servers over Ethernet via a switch, hub, or router. Protecting these Ethernet devices with UPS supplied power is necessary to ensure reliable SNMP

communication during power failures. Servers may fail to shutdown quietly during power failures if SNMP communication is lost.

Planning and Setup for SNMP Configuration

To establish communication to the UPS SNMP card installed in the UPS, the SNMP card will need the following:

- Assign SNMP card IP Address
- Set SNMP card General Parameters
- Set SNMP card Shutdown Parameters
- Set SNMP card Event Trap Receivers (apcupsd-3.12.0 and later)

Assign SNMP Card IP Address

The following instructions come from the APC knowledge base:

The Network Management Card (AP9617, AP9618, AP9619) must be configured with network settings before it can communicate on the network. Once the cards have been configured with an IP address, Subnet Mask, and Default Gateway the cards can be access, managed, and controlled from other computers on the network.

There are two ways to configure the Network Management Card (NMC) with its initial settings: the (windows) Wizard and Address Resolution Protocol (ARP).

1. The wizard is included on the CD that comes with the card. The wizard must run on a Windows operating system. You can configure the card using the wizard over the network via FTP. If using the wizard please note, the un-configured NMC must be on the same subnet as the computer running the wizard.
2. Address resolution protocol (arp) can also be used to configure the NMC. The MAC Address of the NMC is needed for this method of configuration. The MAC address is located on the quality assurance slip that is shipped with the NMC, and is also located on the white sticker on the NMC itself. From a computer on the same subnet as the un-configured NMC, follow the instructions:

Open up a command prompt and type the following (replacing `iIPAddressi` and `iMacAddressi` with the actual values):

```
arp -s iIPAddressi iMacAddressi
```

Next, use Ping with a size of 113 bytes to assign the IP address defined by the ARP command.

- Linux command format: **ping** `iIPAddressi` -s 113
- Windows command format: **ping** `iIPAddressi` -l 113

Set SNMP card General Parameters

After the SNMP Network Management Card is configured with an IP address, the SNMP Card is ready for general configuration. This is accomplished by telneting to the SNMP Card.

```
~$ telnet <IPAddress>
```

Login using "apc" for both the username and password and the following menu will display:

```
*****
American Power Conversion          Network Management Card AOS      v2.6.4
(c) Copyright 2004 All Rights Reserved Smart-UPS & Matrix-UPS APP      v2.6.1
-----
Name      :                               Date : 07/03/2006
Contact   :                               Time : 04:43:33
Location  :                               User  : Administrator
Up Time   : 0 Days 01 Hours 57 Minutes      Stat  : P+ N+ A+

Smart-UPS 1000 named : On Line, No Alarms Present

----- Control Console -----

1- Device Manager
2- Network
3- System
4- Logout

<ESC>- Main Menu, <ENTER>- Refresh, <CTRL-L>- Event Log
>
*****
```

Select **Option 2** for Network. Next select **Option 1** for TCP/IP settings.

At this point the following settings will be to be specified:

- Verify System IP: `¡IPAddress¿`
- Specify Subnet Mask: i.e. "225.225.225.0"
- Specify Default Gateway
- Specify Host Name
- Specify Domain Name

Specifying these parameters will complete the General Parameters setup. Additionally the SNMP Network Management Card can now be connected to from a web browser for monitoring and additional configuration.

Set SNMP card Shutdown Parameters

There are two shutdown parameters that must be set in the SNMP card to ensure that connected servers shutdown quietly. These parameters can be set via the telnet terminal or the web browser interface.

- Shutdown Delay (sec)
- Return Battery Capacity (%)

One of the draw-backs of SNMP communication to the UPS is that the Stand-alone or Primary server must issue the power down command to the UPS early in server halt procedure. This server must issue an early command to the SNMP UPS to power down before its ethernet service is halted. This creates a potential problem where the UPS may kill power to any connected servers before these affected servers' halt scripts complete a successful shutdown.

The SNMP **Shutdown Delay** parameter is used to delay the UPS from killing power to its load by a prescribed period of seconds. The delay should be long enough to ensure that the Stand-alone or Primary server has enough time to successfully halt. The prescribed time should at least be 180 seconds. Any additional computers connected to the SNMP UPS must not be configured to issue the command to initiate UPS power down. These servers can be thought of as secondary stand-alone server. The APCUPSD

daemons of secondary servers should be configured to initiate server halt a prescribed period of time before the Primary server issues the UPS power down command.

The **Return on Battery Capacity** is useful during intermittent sequential power failures. This parameter insures that the UPS will not restore power to its loads until it has recharged its battery to a prescribed percentage. This parameter should be set to a value greater than value that the APCUPSD daemons configured "BATTERYLEVEL" shutdown of any connected servers. This will ensure that when the UPS restores power, any additional power failures will successfully re-trigger a server shutdown.

Configure Event Trap Receivers (apcupsd-3.12.0 and later)

By default, APCUPSD will poll the SNMP UPS card once per minute. In this case, server notification of UPS alarms could potentially be delayed one minute. Event trap catching mitigates this shortcoming. Any UPS alarms are instantly sent to prescribe servers connected SNMP UPS. These servers are referred to as Event Trap Receivers. The SNMP UPS card can be configured to send event traps to a maximum of four receivers that will "catch" these events.

Event trap receivers IP address can be set using a telnet terminal or web browser interface.

Also, be aware that servers configured to be Event Trap Receivers should have static IP set. Servers obtaining IPs from DHCP server will not catch instantaneous Events if the IP address changes from the address set in the SNMP UPS.

Connecting APCUPSD to a SNMP UPS

The previous sections describe configuration of the actual SNMP card. The remaining sections describe configuration of the APCUPSD to communicate using SNMP Protocol.

The Simple Network Management Protocol provides an interface to connect to remote devices through the network. apcupsd is now capable of using the SNMP interface of an SNMP-enabled UPS to communicate with an UPS. Currently apcupsd supports only APC's PowerNet MIB. To enable the SNMP support it is enough to configure the correct device in your apcupsd.conf configuration file. The directive needed for this configuration

is:

```
DEVICE 192.168.100.2:161:APC:private
```

Where the directive is made by four parts:

- **host:** IP address of the remote UPS
- **port:** Remote SNMP port, normally 161
- **vendor:** Kind of remote SNMP agent: “APC” for APC’s PowerNet MIB, “APC_NOTRAP” for the PowerNet MIB with SNMP trap catching disabled, or ”RFC” for the IETF’s rfc1628 UPS-MIB. (Note that APC_NOTRAP is only accepted by apcupsd-3.12.0 and higher. See below for trap catching details.)
- **community:** The read-write community string, usually “private”

If more than one server is connected to the UPS the following configuration types still apply to SNMP enable UPS. (see Choosing a Configuration Type). A NIS Server/Client (Master/Slave) configuration with multiple servers is still applicable.

However, an alternative configuration is possible with an SNMP enabled UPS. In this arrangement, all connected servers will be configured as a standalone server. Each will independently communicate to the UPS. One (primary) server will be chosen to manage the task of commanding the UPS to power down. All remaining (secondary) servers will be configured to quietly power down before the primary server issues the UPS power down command.

Building with SNMP support

Follow the instructions in Building and Installing apcupsd, being sure to include the following options (in addition to any others you need) on the **./configure** line:

```
./configure \  
--with-serial-dev=<your-SNMP-device> \  
--with-upstype=snmp \  
--with-upscable=smart \  
--enable-snmp
```

SNMP Trap Catching

apcupsd-3.11.14 introduces support for SNMP trap catching with the APC PowerNet MIB driver. Previous versions polled the UPS status once per minute, leading to significant delays before UPS state changes were recognized. With SNMP trap handling, apcupsd monitors the SNMP trap port and will re-poll the UPS whenever a trap is received. This happens, for example, when the UPS switches on or off battery.

In order for this feature to work, you must configure your UPS to deliver traps to the server running apcupsd. This is generally done by connecting to your SNMP card via a web browser or telnet connection. You will need to enter your server's IP address as a trap receiver and make sure trap delivery is enabled.

Trap catching can lead to problems if you are already running another SNMP trap daemon on your server. Only one daemon can listen to the trap port, so whichever one is started first will succeed and the others will fail. Apcupsd will fall back to polling behavior if it is unable to open the trap port. You can also forcibly disable trap catching by setting your vendor string in the **apcupsd.conf** **DEVICE** directive to "APC_NOTRAP".

Known Problems

Currently (as of 3.10.0) the code to power off the UPS needs special configuration. The killpower command for SNMP UPSes can not be issued during shutdown as typically at some time during shutdown operations the network stack is stopped. To overcome this problem it is needed to modify the /etc/rc.d/apcupsd system control script to tell apcupsd to issue the power down command (killpower) to the UPS immediately before apcupsd initiates the system shutdown. For this reason it is paramount to set your UPS grace time to a value greater than 120 seconds to allow for clean shutdown operations before the UPS removes the power from its plugs. To enable correct shutdown operation during powerdown do the following:

- Connect to your Web/SNMP card using your favorite web browser, go to the UPS configuration menu and change the "Shutdown Delay" parameter to 180 seconds or more, depending on how much time your system shutdown requires to unmount all the filesystems.
- **Option 1 (non-windows)** Edit the server halt script. Relocate the ups_kill_power() function higher in the shutdown sequence, primarily before the command to bring down the ethernet service. This is the

preferred method for shutting down the UPS. The UPS will power down after the prescribed "Shut Down Delay" time (in seconds) has elapsed.

- **Option 2** Change `/etc/rc.d/apcupsd` script adding the `'—kill-on-powerfail'` to the `apcupsd` invocation. This method is not preferred because the UPS is commanded to power down without delay. This creates the potential for UPS powering down before the server calling for UPS power down completes its shutdown. However, in the case of Microsoft Windows OS, this is the only method available for powering down the UPS.
- Restart your `apcupsd`

With this setup your UPS operations should be safe.

Running The Network Information Server

`apcupsd` maintains STATUS and EVENTS data concerning the UPS and its operation. This information can be obtained over the network using either `apcnisd` or `apcupsd`'s internal network information server, which is essentially the same code as `apcnisd` but compiled into `apcupsd`. Clients on the network make a connection to the information server and send requests for status or events data, which the server then transmits to them.

As of `apcupsd 3.12.x`, the NIS server runs only as a child of `apcupsd`. It cannot be run standalone or from `INETD`.

This is probably the simplest way to run the network information server. To do so, you simply make sure the **NETSERVER** directive in `/etc/apcupsd/apcupsd.conf` is **on**, and then stop and restart `apcupsd`. It will automatically create the server thread to handle network clients. Note, the above modification should not be necessary if you use the default `apcupsd.conf`, since it is already turned on.

Although this method is simple, it affords no protection from the outside world accessing your network server unless you are behind a firewall. In addition, if there is a bug in the network server code, or if a malicious user sends bad data, it may be possible for `apcnisd` to die, in which case, though it is not supposed to, `apcupsd` may also exit, thus leaving your machine without shutdown protection. In addition, since `apcupsd` is running at root level, all threads or any child process will do so also. That being said, most of us prefer to run the server this way.

With apcupsd version 3.8.2 and later, you may enable the TCP Libwrap subroutines to add additional security. In this case, access to the network server will be controlled by the statements you put in `/etc/hosts.allow`.

apcupsd System Logging

The apcupsd philosophy is that all logging should be done through the **syslog** facility (see: `man syslog`). This is now implemented with the exceptions that **STATUS** logging, for compatibility, with prior versions is still done to a file, and **EVENTS** logging can be directed to a “temporary” file so that it can be reported by the network information server.

Logging Types

apcupsd splits its logging into four separate types called:

1. DEBUG
2. DATA
3. STATUS
4. EVENTS

Debug logging consists of debug messages. Normally these are turned on only by developers, and currently there exist very few of these debug messages.

DATA Logging

Data logging consists of periodically logging important data concerning the operation of the UPS. See the Data Logging (see DATA Logging) section of this manual for more details.

STATUS Logging

Status logging consists of logging all available information known about your UPS as a series of ASCII records. This information is also made available by the apcupsd network information server.

For more details on STATUS logging, see the Status (see apcupsd Status Logging) section of the Technical Reference.

EVENTS Logging

Events logging consists of logging events as they happen. For example, successful startup, power fail, battery failure, system shutdown, ...

See the manual section on customizing event handling (see Customizing Event Handling) for more details.

Implementation Details

In order to ensure that the data logged to `syslog()` can be directed to different files, I have assigned `syslog()` levels to each of our four types of data as follows:

1. 1. DEBUG logging has level `LOG_DEBUG`
2. 2. DATA logging has level `LOG_INFO`
3. 3. STATUS logging has level `LOG_NOTICE`
4. 4. EVENTS logging has levels `LOG_WARNING`, `LOG_ERR`, `LOG_CRIT`, and `LOG_ALERT`

It should be noted that more work needs to be done on the precise definitions of each of the levels for EVENTS logging. Currently, it is roughly broken down as follows:

`LOG_WARNING` general information such as startup, etc.

`LOG_ERR` an error condition detected, e.g. communications problem with the UPS.

`LOG_CRIT` a serious problem has occurred such as power failure, running on UPS batteries, ...

`LOG_ALERT` a condition that needs immediate attention such as pending system shutdown, ...

The default Facility for `syslog()` logging is `DAEMON`, although this can be changed with the `FACILITY` directive in `apcupsd.conf`. In the following example, we should the facility as `local0`.

More work needs to be done to the code to ensure that it corresponds to the above levels.

As a practical example of how to setup your `syslog()` to use the new logging feature, suppose you wish to direct all DATA logging to a file named `/var/log/apcupsd.data`, all EVENTS to the standard `/var/log/messages` file (to be mixed with other system messages), and at the same time send all EVENTS to `/var/log/apcupsd.events`, and finally, you want to send all STATUS logging to the named pipe `/var/log/apcupsd.status`

First as root, you create the named pipe:

```
mkfifo /var/log/apcupsd.status
```

Change its permissions as necessary or use the -m option to set them when creating the pipe.

Then you modify your /etc/syslog.conf file to direct the appropriate levels of messages where you want them. To accomplish the above, my syslog.conf file looks like:

```
# exclude all apcupsd info by default
*.info;local0.none                /var/log/messages

# Everything for apcupsd goes here
local0.info;local0.!notice        /var/log/apcupsd.data
local0.notice;local0.!warn        /var/log/apcupsd.status
local0.warn                        /var/log/apcupsd.events
local0.warn                        /var/log/messages
```

Developers Notes

All logging functions and all error reporting are now done through the log_event() subroutine call. Exceptions to this are: initialization code where printf's are done, and writing to the status file. Once the initialization code has completed and the fork() to become a daemon is done, no printf's are used. log_event() has exactly the same format as syslog(). In fact, the subroutine consists of only a syslog() call. If anyone really wishes to log to a file, the code to do so can easily be done by adding code to log_event() in apclog.c.

The Windows Version of apcupsd

The Windows version of apcupsd has been tested on Win95, Win98, WinMe, WinNT, WinXP, and Win2000 systems. This version of apcupsd has been built to run natively on Windows (no Cygwin or other emulation layer needed). Even though the Win32 version of apcupsd is a port that relies on many Unix features, it is just the same a true Windows program. When running, it is perfectly integrated with Windows and displays its icon in the system icon tray, and provides a system tray menu to obtain additional information on how apcupsd is running (status and events dialogue boxes). If so desired, it can also be stopped by using the system tray menu, though this should normally never be necessary.

Once installed apcupsd normally runs as a system service. This means that it is immediately started by the operating system when the system is booted, and runs in the background even if there is no user logged into the system.

Installation

Normally, you will install the Windows version of apcupsd from the binaries. Starting with version 3.11.15, the Windows binaries are distributed with a full GUI installer (driven by NSIS, the Nullsoft Scriptable Install System).

Installation is very simple and straight-forward: Simply double-click the installer executable and follow the instructions.

Configuration

If you are installing Apcupsd for the first time, the installer will give you an opportunity to edit the apcupsd.conf configuration file to contain the values appropriate for your site. (Subsequent installations will maintain your existing apcupsd.conf, so you need not edit it again unless there are new features or syntax changes that must be accounted for.)

The default configuration calls for a USB connected UPS. This is the most common connection for modern UPSes, especially those used with Windows computers. All other apcupsd drivers are available (apcsmart, dumb, net, snmp, pcnet) and can be used simply by editing the configuration file UPSCABLE, UPSTYPE, and DEVICE settings as described elsewhere in this manual.

Note that on Windows, serial ports are specified using COM1, COM2, etc. notation instead of the UNIX-style /dev/tty* notation.

Note also if you are using WinNT or Win2000, the operating system may probe the serial port attempting to attach a serial mouse. This will cause apcupsd to be unable to communicate with the serial port. If this happens, or out of precaution, you can edit the c:\boot.ini file. Find the line that looks something like the following:

```
multi(0)disk(0)rdisk(0)partition(1)\WINNT="Windows NT Workstation Version 4.00"
```

and add the following to the end of the line: /NoSerialMice:COM1 (or COM2 depending on what you want to use). The new line should look similar to...

```
multi(0)disk(0)rdisk(0)partition(1)\WINNT="Windows NT Workstation Version 4.00" /NO
```

...where the only thing you have changed is to append to the end of the line. This addition will prevent the operating system from interfering with apcupsd

Starting Apcupsd

The installer will give you an opportunity start the Apcupsd service immediately. If you choose to start it manually, you may do so by selecting the "Start Apcupsd" link from the Start ->Programs -> Apcupsd folder.

On Windows NT/2000/XP, you may alternatively go to the Control Panel, open the Services folder, select Apcupsd UPS Server, and then click on the **Start** button as shown below:

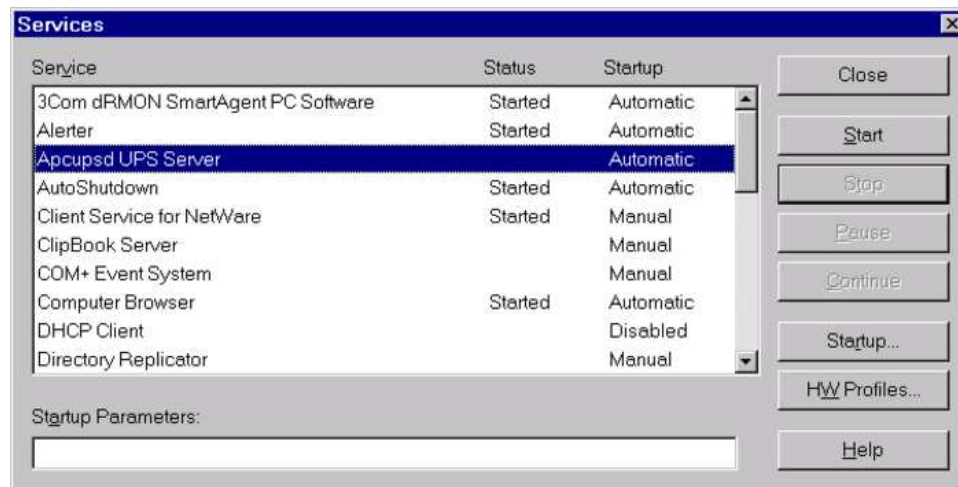





If the Services dialog reports a problem, it is normally because your DEVICE statement does not contain the correct serial port name.

You probably should also click on the **Startup...** button to ensure that the correct defaults are set. The dialogue box that appears should have **Startup Type** set to **Automatic** and **Logon** should be set to **System Account**

with **Allow Service to Interact with Desktop** checked. If these values are not set correctly by default, please change them otherwise apcupsd will not work.

For WinXP and Win2K systems, the dialogs are a bit different from those shown here for WinNT, but the concept is the same. You get to the Services dialog by clicking on: **Control Panel -> Administrative Tools -> Component Services**. The apcupsd service should appear in the right hand window when you click on **Services (Local)** in the left hand menu window.

That should complete the installation process. When the system tray icon turns from a question mark  into a plug , right click on it and a menu will appear. Select the **Events** item, and the Events dialogue box should appear. There should be no error messages. By right clicking again on the system tray plug and selecting the **Status** item, you can verify that all the values for your UPS are correct.

When the UPS switches to the battery, the battery icon  will appear in the system tray. While the UPS is online, if the battery is not at least 99% charged, the plug icon will become a plug with a lightning bolt in the middle  to indicate that the battery is charging.

Testing

It would be hard to overemphasize the need to do a full testing of your installation of apcupsd as there are a number of reasons why it may not behave properly in a real power failure situation.

Please read Testing Apcupsd of this document for general instructions on testing the Win32 version. However, on Win32 systems, there is no Unix system log file, so if something goes wrong, look in the file `c:\apcupsd\etc\apcupsd\apcupsd.events` where apcupsd normally logs its events, and you will generally find more detailed information on why the program is not working. The most common cause of problems is either improper configuration of the cable type, or an incorrect address for the serial port.

Upgrading

An upgrade may be accomplished by uninstalling the old version (using the Add/Remove Programs Control Panel or clicking the "Uninstall Apcupsd"

link from Start -> Programs -> Apcupsd. Near the end of the uninstall you will be prompted about removing configuration and event files. You should answer "No" in order to preserve your existing apcupsd.conf file.

After the uninstall completes you may install the new version of Apcupsd as described above. If you preserved your existing apcupsd.conf file, the new apcupsd.conf will be installed as apcupsd.conf.new.

Post Installation

After installing apcupsd and before running it, you should check the contents of two files to ensure that it is configured properly for your system. The first is c:\apcupsd\etc\apcupsd\apcupsd.conf. You will probably need to change your UPSCABLE directive, your UPSTYPE and possibly your DEVICE directives. Please refer to the configuration section of this manual for more details.

The second file that you should examine is c:\apcupsd\etc\apcupsd\apcontrol. This file is called by apcupsd when events (power loss, etc) are generated. It permits the user to program handling the event. In particular, it permits the user to be notified of the events. For the Win32 version, each event is programmed to display a Windows popup dialogue box. If your machine is mostly unattended, you may want to comment out some of these popup dialogue boxes by putting a pound sign (#) in column one of the appropriate line.

Problem Areas

On some Windows systems, the domain resolution does not seem to work if you have not configured a DNS server in the Network section of the Control Panel. This problem should be apparent only when running a master or a slave configuration. In this case, when you specify the name of the master or the slave machine(s) in your apcupsd.conf file, apcupsd will be unable to resolve the name to a valid IP address. To circumvent this problem, simply enter all machine addresses as an IP address rather than a domain name, or alternatively, ensure that you have a valid DNS server configured on your system (often not the case on Win32 systems).

On WinNT, WinXP, and Win2K systems, you can examine the System Applications log to which apcupsd writes Windows error messages during startup.

Regardless of which Windows system you are running, apcupsd logs most error messages to `c:\apcupsd\etc\apcupsd\apcupsd.events`. This type error messages such as configuration file not found, etc are written to this file. Note that on some systems (WinXP, possibly others) Apcupsd is unable to write to this file when running as a service.

Disclaimer

Some of the features such as EEPROM programming have not been exhaustively tested on Win32 systems. If at all possible, we recommend not to use it as a network master on Win95, Win98, and WinMe due to the instability of those operating systems.

Some items to note:

- This version of apcupsd will not attempt to shut off the UPS power when the battery is exhausted. Thus if the power returns before the UPS completely shuts down, your computer may not reboot automatically. This is because we do not know how to regain control after the disks have been synced in order to shut off the UPS power.

Nevertheless, it is possible to use the `--kill-on-powerfail` option on the apcupsd command line, but the use of this option could cause the power to be cut off while your machine is still running. See Shutdown Sequence of this document for a more complete discussion of this subject. If you are still interested in trying to get this to work, please look at the code that is commented out in `c:\apcupsd\etc\apcupsd\apcontrol` under the **doshutdown** case.

An alternative to the `--kill-on-powerfail` option is to use the `KILLDELAY` (see `KILLDELAY <time in seconds>`) configuration directive.

This configuration directive is appropriate on Windows machines where apcupsd continues to run even when the machine is halted (as is the case on most NT machines).

- When apcupsd detects important events, it calls `c:\apcupsd\etc\apcupsd\apcontrol`, which is a Unix shell script. You may modify this script to suit your particular needs. Currently, it puts a Windows dialogue on the screen with a brief explanation of the event. If these dialogues annoy you, you can remove or comment out the calls to **popup** from this file.

Email Notification of Events

On Win95/98 systems, it is possible to receive notification of apcupsd events that are passed to apccontrol. This is possible using a simple email program that unfortunately is not functioning 100% correctly. In addition, I (Kern) was not able to make this program work on WinNT while apcupsd is running as a service under the system account (it works fine with any user account).

If you wish to try this program on Win95/98 systems, look at the files named **changeme**, **commfailure**, **commok**, **onbattery**, and **mains-back** in the directory `c:\apcupsd\examples`. To use them, you must modify the `SYSADMIN` variable to have a valid email address, then copy the files into the directory `c:\apcupsd\etc\apcupsd`.

Killpower under Windows

If your batteries become exhausted during a power failure and you want your machine to automatically reboot when the power comes back, it is useful to implement the killpower feature of the UPS where apcupsd sends the UPS the command to shut off the power. In doing so, the power will be cut to your PC and if your BIOS is properly setup, the machine will automatically reboot when the power comes back. This is important for servers.

This feature is implemented on Unix systems by first requesting a system shutdown. As a part of the shutdown, apcupsd is terminated by the system, but the shutdown process executes a script where apcupsd is recalled after the disks are synced and the machine is idle. Apcupsd then requests the UPS to shut off the power (killpower).

Unfortunately on Windows, there is no such shutdown script that we are aware of and no way for apcupsd to get control after the machine is idled. If this feature is important to you, it is possible to do it by telling apcupsd to immediately issue the killpower command after issuing the shutdown request. The danger in doing so is that if the machine is not sufficiently idled when the killpower takes place, the disks will need to be rescanned (and there is a possibility of lost data however small). Generally, UPSes have a shutdown grace period which gives sufficient time for the OS to shutdown before the power is cut.

To implement this feature, you need to add the `-p` option to the apcupsd command line that is executed by the system. Currently the procedure is manual. You do so by editing the registry and changing the line:

```
c:\apcupsd\apcupsd.exe /service
```

found under the key:

```
HKEY_LOCAL_MACHINE Software\Microsoft\Windows\CurrentVersion\RunServices
```

to

```
c:\apcupsd\apcupsd.exe /service -p
```

If you have a Smart UPS, you can configure the kill power grace period, and you might want to set it to 3 minutes. If you have a dumb UPS, there is no grace period and you should not use this procedure. If you have a Back-UPS CS or ES, these UPSes generally have a fixed grace period of 2 minutes, which is probably sufficient.

Power Down During Shutdown

Our philosophy is to shutdown a computer but not to power it down itself (as opposed to having the UPS cut the power as described above). That is we prefer to idle a computer but leave it running. This has the advantage that in a power fail situation, if the killpower function described above does not work, the computer will continue to draw down the batteries and the UPS will hopefully shutoff before the power is restore thus permitting an automatic reboot.

Nevertheless some people prefer to do a full power down. To do so, you might want to get a copy of PsShutdown, which does have a power down option. You can find it and a lot more useful software at: <http://www.sysinternals.com/ntw2k/freeware/pstools.shtml>. to use their shutdown program rather than the apcupsd supplied version, you simply edit:

```
c:\apcupsd\etc\apcupsd\apcontrol
```

with any text editor and change our calls to shutdown to psshutdown.

Command Line Options Specific to the Windows Version

These options are not normally seen or used by the user, and are documented here only for information purposes. At the current time, to change the default options, you must either manually run `apcupsd` or you must manually edit the system registry and modify the appropriate entries.

In order to avoid option clashes between the options necessary for `apcupsd` to run on Windows and the standard `apcupsd` options, all Windows specific options are signaled with a forward slash character (`/`), while as usual, the standard `apcupsd` options are signaled with a minus (`-`), or a minus minus (`--`). All the standard `apcupsd` options can be used on the Windows version. In addition, the following Windows only options are implemented:

- `/servicehelper` Run the service helper application
- `/service` Start `apcupsd` as a service
- `/run` Run the `apcupsd` application
- `/install` Install `apcupsd` as a service in the system registry
- `/remove` Uninstall `apcupsd` from the system registry
- `/about` Show the `apcupsd` about dialogue box
- `/status` Show the `apcupsd` status dialogue box
- `/events` Show the `apcupsd` events dialogue box
- `/kill` Stop any running `apcupsd`
- `/help` Show the `apcupsd` help dialogue box

It is important to note that under normal circumstances the user should never need to use these options as they are normally handled by the system automatically once `apcupsd` is installed. However, you may note these options in some of the `.pif` files that have been created for your use.

Building the Win32 Version from the Source

If you have the source code, follow the standard procedures for building `apcupsd` on Unix in Building and Installing `apcupsd` of this manual. Please don't forget to look at the system specifics for CYGWIN.

Installation: Serial-Line UPSes

Overview of Serial-Interface UPSes

If you have a UPS that communicates via serial port, you need to do two things before you can even think about configuring the software. First, you need to figure out whether it's a dumb (voltage-signalling) UPS or speaks the apcsmart protocol (see this discussion (see upstypes)). Second, if you have an interface cable from APC, you need to figure out what kind it is. If you don't have such a cable, you need to build one. A straight-through serial cable won't work (see crazy).

According to Bill Marr the Belkin F5U109, also sold as F5U409 also works with apcupsd for kernel versions 2.4.25 or higher and kernels 2.6.1 and higher. These newer kernels are needed to have the patch that makes the mct_u232 (Magic Control Technology) module and other adapters work with RS-232 devices that do not assert the CTS signal.

Connecting a Serial-Line UPS to a USB Port

By using a special adaptor, you can connect your serial-line UPS to a USB port. If you would like to free up your serial port and connect your existing serial port UPS to a USB port, it is possible if you have one of the later kernels. You simply get a serial to USB adapter that is supported by the kernel, plug it in and make one minor change to your apcupsd.conf file and away you go. (Kern adds: Thanks to Joe Acosta for pointing this out to me.)

The device that Joe Acosta and Kern are using is IOgear GUC232A USB 2 serial adapter. Bill Marr informs us that it also works with a Back-UPS Pro 650 and the 940-0095B cable.

At Kern's site, running Red Hat 7.1 with kernel 2.4.9-12, he simply changed his `/etc/apcupsd/apcupsd.conf` configuration line to be:

```
DEVICE /dev/ttyUSB0
```

Depending on whether or not you have **hotplug** working, you may need to explicitly load the kernel modules **usbserial** and **pl2303**. In Kern's case, this was not necessary.

Connecting a APC USB UPS to either a PC USB or Serial Port

An interesting fact is that the USB ports (actually an RJ45 connector) on APC UPSes not only speak USB, but also serial apcsmart and dumb voltage-signalling as well! This is something that one of our users discovered by accident. With the Custom RJ45 cable (actually a RJ45 to serial cable) described below plugged into the APC UPS USB socket at one end and the other end plugged into a serial port on your PC, any APC USB UPS (except some of the newer really low cost models) will act as a serial-line device.

Cables

You can either use the cable that came with your UPS (the easiest if we support it) or you can make your own cable. We recommend that you obtain a supported cable directly from APC.

If you already have an APC cable, you can determine what kind it is by examining the flat sides of the two connectors where you will find the cable number embossed into the plastic. It is generally on one side of the male connector.

To make your own cable you must first know whether you have a UPS that speaks the apcsmart protocol or a “dumb” UPS that uses serial port line voltage signalling.

If you have a smart UPS, and you build your own cable, build a *Smart-Custom* cable. If you have a voltage-signalling or dumb UPS, build a *Simple-Custom* cable. If you have a BackUPS CS with a RJ45 connector, you can build your own *Custom-RJ45* cable.

Smart-Custom Cable for SmartUPSes

SMART-CUSTOM CABLE					
Signal	Computer		UPS		
	DB9F		DB9M		
RxD	2	-----	2	TxD	Send
TxD	3	-----	1	RxD	Receive
GND	5	-----	9	Ground	

When using this cable with apcupsd specify the following in apcupsd.conf:

```
UPSCABLE smart
UPSTYPE apcsmart
DEVICE /dev/ttyS0 (or whatever your serial port is)
```

If you have an OS that requires DCD or RTS to be set before you can receive input, you might try building the standard APC Smart 940-0024C cable listed below.

Simple-Custom Voltage-Signalling Cable for “dumb” UPSes

NOTE: YOU DO NOT HAVE THIS CABLE UNLESS YOU BUILT IT YOURSELF. THE SIMPLE-CUSTOM CABLE IS NOT AN APC PRODUCT.

For “dumb” UPSes using voltage signalling, if you are going to build your own cable, we recommend to make the cable designed by the apcupsd team as follows:

SIMPLE-CUSTOM CABLE				
Signal	Computer		UPS	
	DB9F	4.7K ohm	DB9M	
DTR	4	--[####]--*		DTR set to +5V by Apcupsd
CTS	8	-----*-----	5	Low Battery
GND	5	-----	4	Ground
DCD	1	-----	2	On Battery
RTS	7	-----	1	Kill UPS Power

List of components one needs to make the Simple cable:

1. One (1) male DB9 connector, use solder type connector only.
 2. One (1) female DB9/25F connector, use solder type connector only.
 3. One (1) 4.7K ohm 1/4 watt 5% resistor.
 4. resin core solder.
 5. three (3) to five (5) feet of 22AWG multi-stranded four or more conductor cable.
1. Solder the resistor into pin 4 of the female DB9 connector.

2. Next bend the resistor so that it connects to pin 8 of the female DB9 connector.
3. Pin 8 on the female connector is also wired to pin 5 on the male DB9 connector. Solder both ends.
4. Solder the other pins, pin 5 on the female DB9 to pin 4 on the male connector; pin 1 on the female connector to pin 2 on the male connector; and pin 7 on the female connector to pin 1 on the male connector.
5. Double check your work.

We use the DTR (pin 4 on the female connector) as our +5 volts power for the circuit. It is used as the Vcc pull-up voltage for testing the outputs on any “UPS by APC” in voltage-signalling mode. This cable may not work on a BackUPS Pro if the default communications are in apcsmart mode. This cable is also valid for “ShareUPS” BASIC Port mode and is also reported to work on SmartUPSes. However, the Smart Cable described above is much simpler. To have a better idea of what is going on inside apcupsd, for the SIMPLE cable apcupsd reads three signals and sets three:

Reads:

CD, which apcupsd uses for the On Battery signal when high.

CTS, which apcupsd uses for the Battery Low signal when high.

RxD (SR), which apcupsd uses for the Line Down signal when high. This signal isn't used for much.

Sets:

DTR, which apcupsd sets when it detects a power failure (generally 5 to 10 seconds after the CD signal goes high). It clears this signal if the CD signal subsequently goes low -- i.e. power is restored.

TxD (ST), which apcupsd clears when it detects that the CD signal has gone low after having gone high - i.e. power is restored.

RTS, which apcupsd sets for the killpower signal -- to cause the UPS to shut off the power.

Please note that these actions apply only to the SIMPLE cable, the signals used on the other cables are different.

Finally, here is another way of looking at the CUSTOM-SIMPLE cable:

APCUPSD SIMPLE-CUSTOM CABLE

Computer Side		Description of Cable	UPS Side	
DB9f	DB25f		DB9m	DB25m
4	20	DTR (5vcc) *below	n/c	
8	5	CTS (low battery) *below	<- 5	7
2	3	RxD (no line voltage) *below	<- 3	2
5	7	Ground (Signal)	4	20
1	8	CD (on battery from UPS)	<- 2	3
7	4	RTS (kill UPS power)	-> 1	8
n/c	1	Frame/Case Gnd (optional)	9	22

Note: the <- and -> indicate the signal direction.

When using this cable with apcupsd specify the following in apcupsd.conf:

```
UPSCABLE simple
UPSTYPE dumb
DEVICE /dev/ttyS0 (or whatever your serial port is)
```

Custom-RJ45 Smart Signalling Cable for BackUPS CS Models

If you have a BackUPS CS, you are probably either using it with the USB cable that is supplied or with the 940-0128A supplied by APC, which permits running the UPS in dumb mode. By building your own cable, you can now run the BackUPS CS models (and perhaps also the ES models) using smart signalling and have all the same information that is available as running it in USB mode.

The jack in the UPS is actually a 10 pin RJ45. However, you can just as easily use a 8 pin RJ45 connector, which is more standard (ethernet TX, and ISDN connector). It is easy to construct the cable by cutting off one end of a standard RJ45-8 ethernet cable and wiring the other end (three wires) into a standard DB9F female serial port connector.

Below, you will find a diagram for the CUSTOM-RJ45 cable:

CUSTOM-RJ45 CABLE

Signal	Computer		UPS		UPS	
	DB9F		RJ45-8	RJ45-10		
RxD	2	-----	1	2	TxD	Send
TxD	3	-----	7	8	RxD	Receive
GND	5	-----	6	7	Ground	
FG	Shield	-----	3	4	Frame	Ground

The RJ45-8 pins are: looking at the end of the connector:

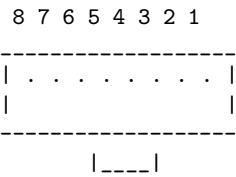

The RJ45-10 pins are: looking at the end of the connector:

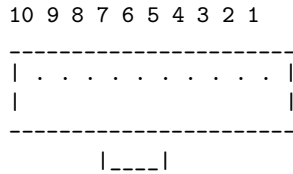

For the serial port DB9F connector, the pin numbers are stamped in the plastic near each pin. In addition, there is a diagram near the end of this chapter.

Note, one user, Martin, has found that if the shield is not connected to the Frame Ground in the above diagram (not in our original schematic), the UPS (a BackUPS CS 500 EI) will be unstable and likely to rapidly switch from power to batteries (i.e. chatter).

When using this cable with apcupsd specify the following in apcupsd.conf:

```
UPSCABLE smart
UPSTYPE apcsmart
DEVICE /dev/ttyS0 (or whatever your serial port is)
```

The information for constructing this cable was discovered and transmitted to us by slither_man. Many thanks!

Other APC Cables that apcupsd Supports

apcupsd will also support the following off the shelf cables that are supplied by APC

- 940-0020[B/C] Simple Signal Only, all models.
- 940-0023A Simple Signal Only, all models.
- 940-0119A Simple Signal Only, Back-UPS Office, and BackUPS ES.

- 940-0024[B/C/G] SmartMode Only, SU and BKPro only.
- 940-0095[A/B/C] PnP (Plug and Play), all models.
- 940-1524C SmartMode Only
- 940-0127[A/B] USB Cables
- 940-0128A Simple Signal Only, Back-UPS CS in serial mode.

Voltage Signalling Features Supported by Apcupsd for Various Cables

The following table shows the features supported by the current version of apcupsd for various cables running the UPS in voltage-signalling mode.

Cable	Power Loss	Low Battery	Kill Power	Cable Disconnected
940-0020B	Yes	No	Yes	No
940-0020C	Yes	Yes	Yes	No
940-0023A	Yes	No	No	No
940-0119A	Yes	Yes	Yes	No
940-0127A	Yes	Yes	Yes	No
940-0128A	Yes	Yes	Yes	No
940-0095A/B/C	Yes	Yes	Yes	No
simple	Yes	Yes	Yes	No

Voltage Signalling

Apparently, all APC voltage-signalling UPSes with DB9 serial ports have the same signals on the output pins of the UPS. The difference at the computer end is due to different cable configurations. Thus, by measuring the connectivity of a cable, one can determine how to program the UPS.

The signals presented or accepted by the UPS on its DB9 connector using the numbering scheme listed above is:

UPS Pin	Signal meaning
1 <-	Shutdown when set by computer for 1-5 seconds.
2 ->	On battery power (this signal is normally low but goes high when the UPS switches to batteries).
3 ->	Mains down (line fail) See Note 1 below.
5 ->	Low battery. See Note 1 below.

```

6   ->   Inverse of mains down signal. See Note 2 below.
7   <-   Turn on/off power (only on advanced UPSes only)

```

Note 1: these two lines are normally open, but close when the appropriate signal is triggered. In fact, they are open collector outputs which are rated for a maximum of +40VDC and 25 mA. Thus the 4.7K ohm resistor used in the Custom Simple cable works quite well.

Note 2: the same as note 1 except that the line is normally closed, and opens when the line voltage fails.

The Back-UPS Office 500 signals

The Back-UPS Office UPS has a telephone type jack as output, which looks like the following:

Looking at the end of the connector:

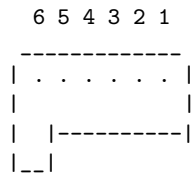

It appears that the signals work as follows:

UPS		Signal meaning
1 (brown)	<-	Shutdown when set by computer for 1-5 seconds.
2 (black)	->	On battery power
3 (blue)	->	Low battery
4 (red)		Signal ground
5 (yellow)	<-	Begin signalling on other pins
6 (none)		none

Analyses of APC Cables

940-0020B Cable Wiring:

- **Supported Models:** Simple Signaling such as BackUPS
- **Contributed by:** Lazar M. Fleysher

Although we do not know what the black box semi-conductor contains, we believe that we understand its operation (many thanks to Lazar M. Fleysher for working this out).

This cable can only be used on voltage-signalling UPSes, and provides the On Battery signal as well as kill UPS power. Most recent evidence (Lazar's analysis) indicates that this cable under the right conditions may provide the Low Battery signal. This is yet to be confirmed.

This diagram is for informational purposes and may not be complete, we don't recommend that use it to build you build one yourself.

APC Part# - 940-0020B

Signal	Computer DB9F		UPS DB9M	
CTS	8	-----	2	On Battery
DTR	4	-----	1	Kill power
GND	5	-----*	4	Ground
		---	*----	9 Common
DCD	1	---- /// -----	5	Low Battery
		\\		
RTS	7	---- /// (probably a --- semi-conductor)		

940-0020C Cable Wiring:

- **Supported Models:** Simple Signaling such as BackUPS

This cable can only be used on voltage-signalling UPSes, and provides the On Battery signal, the Low Battery signal as well as kill UPS power. You may specify **UPSCABLE 940-0020C**.

This diagram is for informational purposes and may not be complete, we don't recommend that use it to build you build one yourself.

APC Part# - 940-0020C

Signal	Computer DB9F		UPS DB9M	
CTS	8	-----	2	On Battery
DTR	4	-----	1	Kill power
GND	5	-----*	4	Ground
			*----	9 Common
RTS	7	----[93.5K ohm]----- or semi-conductor	5	Low Battery

940-0023A Cable Wiring:

- **Supported Models:** Simple Signaling such as BackUPS

This cable can only be used on voltage-signalling UPSes, and apparently only provides the On Battery signal. As a consequence, this cable is pretty much useless, and we recommend that you find a better cable because all APC UPSes support more than just On Battery. Please note that we are not sure the following diagram is correct.

This diagram is for informational purposes and may not be complete, we don't recommend that use it to build you build one yourself.

APC Part# - 940-0023A

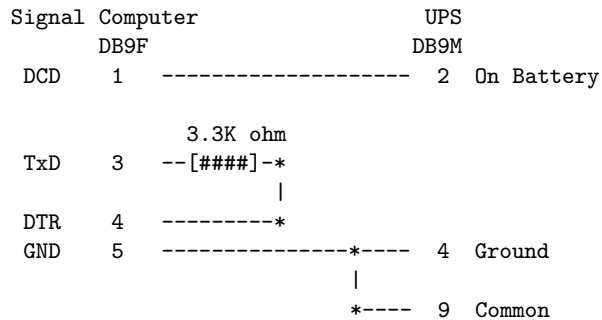

940-0024C Cable Wiring:

- **Supported Models:** SmartUPS (all models with DB9 serial port)

If you wish to build the standard cable furnished by APC (940-0024C), use the following diagram.

APC Part# - 940-0024C

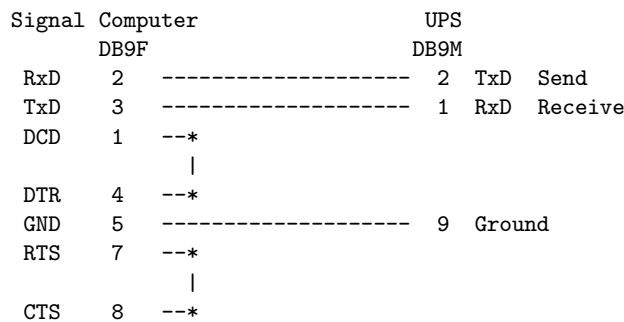

940-0095A Cable Wiring:

- **Supported Models:** APC BackUPS Pro PNP
- **Contributed by:** Chris Hanson <cph at zurich.ai.mit.edu>

This is the definitive wiring diagram for the 940-0095A cable submitted by Chris Hanson, who disassembled the original cable, destroying it in the process. He then built one from his diagram and it works perfectly.

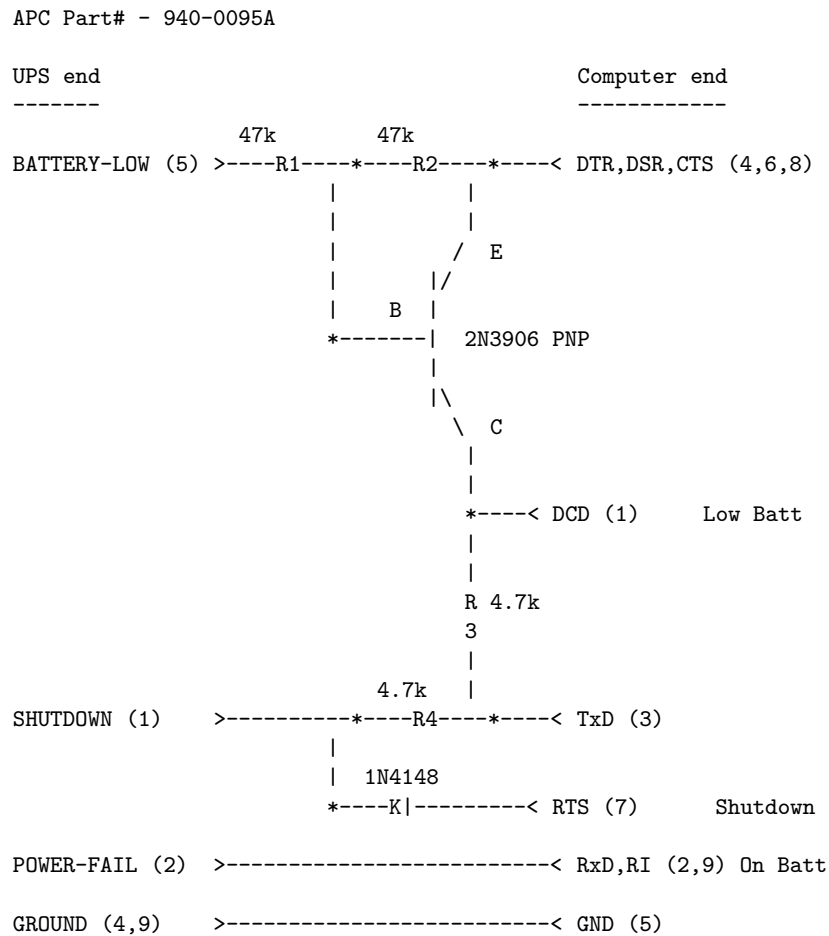

Operation:

- DTR is "cable power" and must be held at SPACE. DSR or CTS may be used as a loopback input to determine if the cable is plugged in.

- DCD is the "battery low" signal to the computer. A SPACE on this line means the battery is low. This is signalled by BATTERY-LOW being pulled down (it is probably open circuit normally).

Normally, the transistor is turned off, and DCD is held at the MARK voltage by TxD. When BATTERY-LOW is pulled down, the voltage divider R2/R1 biases the transistor so that it is turned on, causing DCD to be pulled up to the SPACE voltage.

- TxD must be held at MARK; this is the default state when no data is being transmitted. This sets the default bias for both DCD and SHUTDOWN. If this line is an open circuit, then when BATTERY-LOW is signalled, SHUTDOWN will be automatically signalled; this would be true if the cable were plugged in to the UPS and not the computer, or if the computer were turned off.
- RTS is the "shutdown" signal from the computer. A SPACE on this line tells the UPS to shut down.
- RxD and RI are both the "power-fail" signals to the computer. A MARK on this line means the power has failed.
- SPACE is a positive voltage, typically +12V. MARK is a negative voltage, typically -12V. Linux appears to translate SPACE to a 1 and MARK to a 0.

940-0095B Cable Wiring:

- **Supported Models:** Many simple-signaling (aka voltage signaling) models such as BackUPS

This diagram is for informational purposes and may not be complete, we don't recommend that use it to build you build one yourself.

APC Part# - 940-0095B

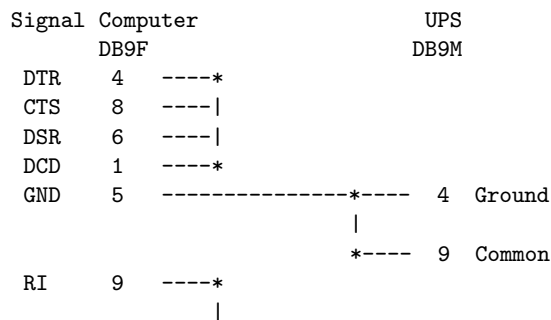

```

Rx/D  2  -----*-----  2  On Battery
Tx/D  3  -----[####]----  1  Kill UPS Power
                               4.7K ohm

```

940-0119A Cable Wiring:

- **Supported Models:** Older BackUPS Office

This diagram is for informational purposes and may not be complete, we don't recommend that use it to build you build one yourself.

APC Part# - 940-0119A

UPS pins	Computer pins	Signal		Signal meaning
1 (brown)	4,6	DSR DTR	<-	Shutdown when set by computer for 1-5 seconds.
2 (black)	8,9	RI CTS	->	On battery power
3 (blue)	1,2	CD RxD	->	Low battery
4 (red)	5	Ground		
5 (yellow)	7	RTS	<-	Begin signalling on other pins
6 (none)	none			

Serial BackUPS ES Wiring:

- **Supported Models:** Older Serial BackUPS ES
- **Contributed by:** William Stock

The BackUPS ES has a straight through serial cable with no identification on the plugs. To make it work with apcupsd, specify the **UPSCABLE 940-0119A** and **UPSTYPE backups**. The equivalent of cable 940-0119A is done on a PCB inside the unit.

```

computer          ----- BackUPS-ES -----
DB9-M            DB-9F
pin  signal      pin
4    DSR  ->    4  --+
                   | diode  resistor
6    DTR  ->    6  --+---->|----/\/\\----o kill power
1    DCD  <-    1  --+
                   |
2    RxD  <-    2  --+-----+---o low battery
                   |
7    RTS  ->    7  -----+---/\/\\---+

```

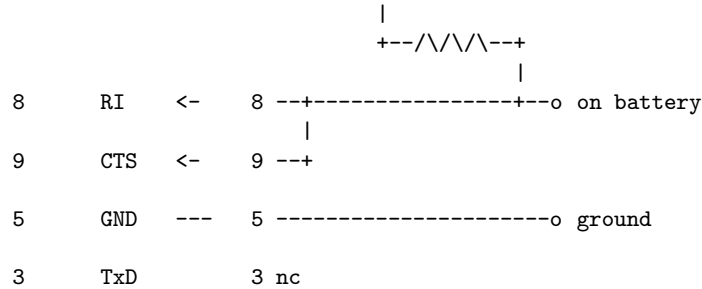

940-0128A Cable Wiring:

- **Supported Models:** Older USB BackUPS ES and CS
- **Contributed by:** Many, thanks to all for your help!

Though these UPSes are USB UPSes, APC supplies a serial cable (typically with a green DB9 F connector) that has 940-0128A stamped into one side of the plastic serial port connector. The other end of the cable is a 10 pin RJ45 connector that plugs into the UPS (thanks to Dean Waldow for sending a cable!). Apcupsd version 3.8.5 and later supports this cable when specified as **UPSCABLE 940-0128A** and **UPSTYPE dumb**. However, running in this mode much of the information that would be available in USB mode is lost. In addition, when apcupsd attempts to instruct the UPS to kill the power, it begins cycling about 4 times a second between battery and line. The solution to the problem (thanks to Tom Suzda) is to unplug the UPS and while it is still chattering, press the power button (on the front of the unit) until the unit beeps and the chattering stops. After that the UPS should behave normally and power down 1-2 minutes after requested to do so.

Thanks to all the people who have helped test this and have provided information on the cable wiring, our best guess for the cable schematic is the following:

APC Part# - 940-0128A

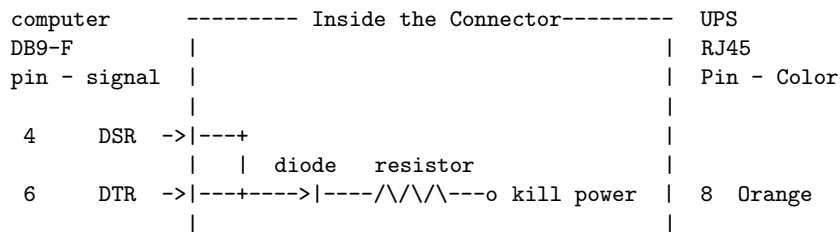

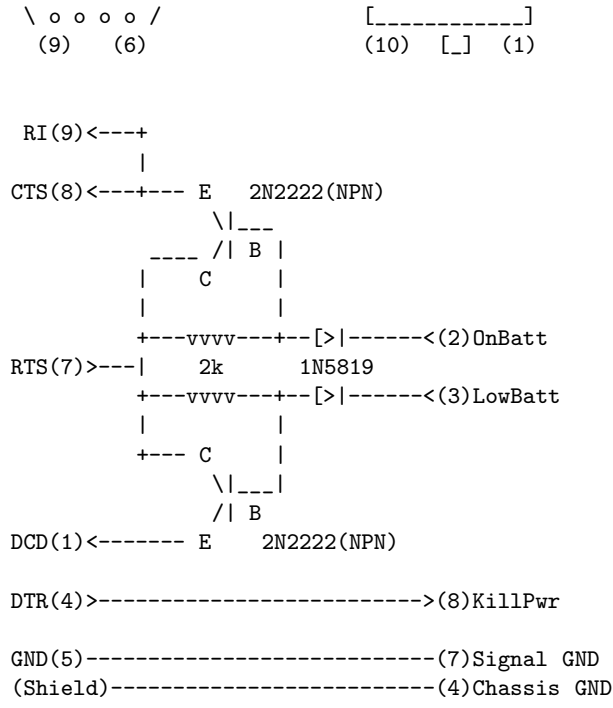

940-0127B Cable Wiring:

- **Supported Models:** BackUPS XS1000(BX-1000), Possibly other USB models
- **Contributed by:** Jan Babinski <jbabinsk at pulsarbeacon dot com>

Standard USB cable for USB-capable models with 10-pin RJ45 connector.

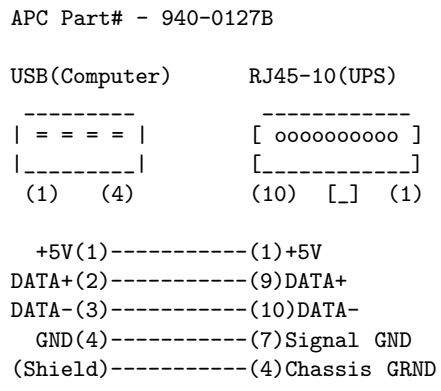

Win32 Implementation Restrictions for Simple UPSes

Due to inadequacies in the Win32 API, it is not possible to set/clear/get all the serial port line signals. apcupsd can detect: CTS, DSR, RNG, and CD. It can set and clear: RTS and DTR.

This imposes a few minor restrictions on the functionality of some of the cables. In particular, LineDown on the Custom Simple cable, and Low Battery on the 0023A cable are not implemented.

Internal Apcupsd Actions for Simple Cables

This section describes how apcupsd 3.8.5 (March 2002) treats the serial port line signals for simple cables.

```
apcaction.c:
condition = power failure detected
cable = CUSTOM_SIMPLE
action = ioctl(TIOCMBSIS, DTR)      set DTR (enable power bit?)

apcaction.c:
condition = power back
cable = CUSTOM_SIMPLE
action = ioctl(TIOCMBSIS, DTR)      clear DTR (clear power bit)
action = ioctl(TIOCMBSIS, ST)       clear ST (TxD)

apcserial.c:
condition = serial port initialization
cable = 0095A, 0095B, 0095C
action = ioctl(TIOMBIC, RTS)        clear RTS (set PnP mode)

cable = 0119A, 0127A, 0128A
action = ioctl(TIOMBIC, DTR)        clear DTR (killpower)
action = ioctl(TIOMBIS, RTS)        set   RTS (ready to receive)

apcserial.c:
condition = save_dumb_status
cable = CUSTOM_SIMPLE
action = ioctl(TIOMBIC, DTR)        clear DTR (power bit?)
action = ioctl(TIOMBIC, RTS)        clear RTS (killpower)

cable = 0020B, 0020C, 0119A, 0127A, 0128A
action = ioctl(TIOMBIC, DTR)        clear DTR (killpower)

cable = 0095A, 0095B, 0095C
action = ioctl(TIOMBIC, RTS)        clear RTS (killpower)
action = ioctl(TIOMBIC, CD)         clear DCD (low batt)
action = ioctl(TIOMBIC, RTS)        clear RTS (killpower) a second time!
```

```

apcserial.c:
condition = check_serial

cable = CUSTOM_SIMPLE
action = OnBatt = CD
action = BattLow = CTS
action = LineDown = SR

cable = 0020B, 0020C, 0119A, 0127A, 0128A
action = OnBatt = CTS
action = BattLow = CD
action = LineDown = 0

cable = 0023A
action = Onbatt = CD
action = BattLow = SR
action = LineDown = 0

cable = 0095A, 0095B, 0095C
action = OnBatt = RNG
action = BattLow = CD
action = LineDown = 0

apcserial.c
condition = killpower

cable = CUSTOM_SIMPLE, 0095A, 0095B, 0095C
action = ioctl(TIOMCBIS, RTS)      set RTS (kills power)
action = ioctl(TIOMCBIS, ST)      set TxD

cable = 0020B, 020C, 0119A, 0127A, 0128A
action = ioctl(TIOMCBIS, DTR)      set DTR (kills power)

```

RS232 Wiring and Signal Conventions

DB-25 Pin #	DB-9 Pin #	Name	DTE-DCE Description
1	—	FG	– Frame Ground/Chassis GND
2	3	TD	–> Transmitted Data, TxD
3	2	RD	<– Received Data, RxD
4	7	RTS	–> Request To Send
5	8	CTS	<– Clear To Send
6	6	DSR	<– Data Set Ready
7	5	SG	— Signal Ground, GND
8	1	DCD	<– Data Carrier Detect
9	—	—	– Positive DC test voltage
10	—	—	– Negative DC test voltage

11	—	QM	<- Equalizer mode
12	—	SDCD	<- Secondary Data Carrier Detect
13	—	SCTS	<- Secondary Clear To Send
14	—	STD	-> Secondary Transmitted Data
15	—	TC	<- Transmitter (signal) Clock
16	—	SRD	<- Secondary Receiver Clock
17	—	RC	-> Receiver (signal) Clock
18	—	DCR	<- Divided Clock Receiver
19	—	SRTS	-> Secondary Request To Send
20	4	DTR	-> Data Terminal Ready
21	—	SQ	<- Signal Quality Detect
22	9	RI	<- Ring Indicator
23	—	—	-> Data rate selector
24	—	—	<- Data rate selector
25	—	TC	<- Transmitted Clock

Pin Assignment for the Serial Port (RS-232C), 25-pin and 9-pin, Female End

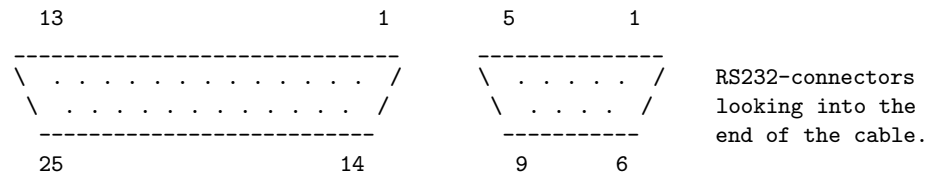

The diagram above represents the Female end of the cable. The male end is the same, but looking from inside the cable.

- DTE : Data Terminal Equipment (i.e. computer)
- DCE : Data Communications Equipment (i.e. UPS)
- RxD : Data received; 1 is transmitted "low", 0 as "high"
- TxD : Data sent; 1 is transmitted "low", 0 as "high"
- DTR : DTE announces that it is powered up and ready to communicate
- DSR : DCE announces that it is ready to communicate; low=modem hang-up
- RTS : DTE asks DCE for permission to send data
- CTS : DCE agrees on RTS
- RI : DCE signals the DTE that an establishment of a connection is attempted
- DCD : DCE announces that a connection is established

Ioctl to RS232 Correspondence

```
#define TIOCM_LE      0x001
```

```

#define TIOCM_DTR      0x002
#define TIOCM_RTS      0x004
#define TIOCM_ST       0x008
#define TIOCM_SR       0x010
#define TIOCM_CTS      0x020
#define TIOCM_CAR      0x040
#define TIOCM_RNG      0x080
#define TIOCM_DSR      0x100
#define TIOCM_CD       TIOCM_CAR
#define TIOCM_RI       TIOCM_RNG
#define TIOCM_OUT1     0x2000
#define TIOCM_OUT2     0x4000

```

Testing Serial-Line UPSes

If you have a serial-line UPS, there are some tests you should run before the general ones described in the Testing (see Testing Apcupsd) section.

To test your computer's connection with a serial-line UPS, you first need to establish that the serial line is functioning, and then that the UPS is responding to commands. This can be a bit tricky, especially with a dumb voltage-signalling interface, because it is completely quiescent when there are no commands being passed, and the command repertoire doesn't include any self-tests.

Because it is easy to configure a serial cable incorrectly in such a way as to cause premature shutdowns of the UPS power, we *strongly* recommend, especially for voltage- signaling (dumb) UPSes, that you do most of the initial testing with your computer plugged into the wall rather than your UPS. Thus if the UPS power is suddenly shut off, your computer will continue to run. We also recommend using safe-apccontrol as described below, until you are sure that the signaling is correct.

Also note that if you launch the execution of apcupsd while your voltage-signaling UPS is on battery power, it is very likely that your UPS will immediately shut off the power. This is due to the initialization of the serial port line signals, which often looks to the UPS like a shutdown command.

Finally, double-check the state of your cabling and UPS indicator lights frequently during testing. For voltage-signaling UPSes, apcupsd is not currently able to detect whether or not the serial cable is connected. In addition, some simple signaling UPSes with certain cable combinations are not able to detect the low battery condition. For more details please see Voltage Signalling Features Supported by Apcupsd for Various Cables.

Establishing Serial Port Connection

Once you have compiled, installed, and invoked `apcupsd`, you should wait to allow `apcupsd` to configure itself and establish contact with the UPS.

If you see the following message about 30 seconds after starting `apcupsd`:

```
apcupsd FATAL ERROR in apcserial.c at line 156
PANIC! Cannot communicate with UPS via serial port.
```

it means that `apcupsd` tried for about 30 seconds to establish contact with the UPS via the serial port, but was unable to do so. Before continuing, you must correct this problem. Some of the possible sources of the problem are:

- You have not configured the correct serial port name on the `DEVICE` directive in your `apcupsd` configuration file.
- The serial port that you have chosen has logins enabled. You must disable logins on that port, otherwise, the system prevents `apcupsd` from using it. Normally, the file `/etc/inittab` specifies the ports for which a `getty` process is started (on Sun machines, the serial port program equivalent to `getty` is called `ttymon`). You must disable this for the port that you wish to use.
- Make sure you are doing your testing as **root** otherwise, you may have permissions problems accessing the serial port.
- You may have cabling problems, either with an incorrect cable, or the incorrect cable specification directive in the configuration file.
- You may have a problem with the `/etc/apcupsd/acpupsd.conf` file. For example, check that you have specified the correct type of UPS and the correct networking directives. For more details, see the *After Installation*.
- If you have a SmartUPS 5000 RM 15U or similar model, that comes with a “Web/SNMP management card” in one of the “Smart Slots”, this card may interfere with the serial port operation. If you are having problems, please remove this card and try again. Supposedly V3.0 of the card firmware has been corrected to properly release the serial port.
- Ensure that you have no other programs that are using the serial port. One user reported that he had problems because the serial port mouse (`gpm`) was using the same port as `apcupsd`. This causes intermittent seemingly random problems.

- If you are using a WinNT or Win2000 machine, the OS is probably attempting to attach a serial mouse to the port you are using (COM1 or COM2). To prevent this, edit your `c:\boot.ini` file, and you will find a line that looks something like the following:

```
multi(0)disk(0)rdisk(0)partition(1)\WINNT="Windows NT Workstation Version 4.00"
```

Add the following to the end of the line: `/NoSerialMice:COM1` (or `COM2`) so that the new line looks like:

```
multi(0)disk(0)rdisk(0)partition(1)\WINNT="Windows NT Workstation Version 4.00" /NoSerialMice:COM1
```

- If you are using a WinNT or Win2000 machine, try connecting `apcupsd` to COM2 rather than COM1 (be sure to change your `c:\apcupsd\etc\apcupsd\apcupsd.conf` to reflect the change).
- If you are using a Solaris machine, you may have similar problems as described above for the WinNT machine. A possible fix is documented in the Sun section of the Configuration chapter of this manual.
- Try connecting your UPS to another machine. If it works, then you probably have a bad serial port card. As unlikely as this may sound, at least two of our users have had to replace bad serial port cards.
- Try doing an `lsof /dev/ttyS0` where you replace the `/dev/ttyS0` with your serial port name. If you get no output, the port is free (or there is no physical port). If you get output, then another program is using the port, and you should see which one.
- Try doing a `dmesg | grep tty`. This may show you if a program has grabbed the port. (Thanks to Joe Acosta for the suggestion.)
- If all else fails, make sure your system is configured for serial port support.
- If you are running Linux, check your `/proc` file system. For example: `cat /proc/devices` should print something like `4 ttyS` if you have a serial port. If your serial port is working, a `cat /proc/interrupts` should show the serial port usage (e.g. **4: 294553 XT-PIC serial**). Also, `cat /proc/ioports` should show up something like **03f8-03ff : serial(auto)**. Or, `cat /proc/tty` should print a line like **serial /dev/ttyS 4 64-127 serial**. Finally, a `cat /proc/tty/driver/serial` should print something like the following:

```
serinfo:1.0 driver:5.05c revision:2001-07-08
0: uart:16550A port:3F8 irq:4 baud:9600 tx:1503168 rx:1461721 fe:8
```

The first thing to do is to look at your log file, usually `/var/log/messages` because `apcupsd` writes more detailed information to the log file whenever there is an error.

If you have a UPS that uses `apcsmart` protocol (see table of types (see `type_table`) for a list of the UPSes using these protocols), you can manually test the serial communications with the UPS by starting a serial port communications program (such as `minicom`, `tip`, or `cu`) with the settings 2400 8N1 (2400 baud, 8 bits, no parity, 1 stop bit). Be extremely careful what you send to your UPS as certain characters may cause it to power down or may even cause damage to the UPS. Try sending an upper case `Y` to the UPS (without a return at the end). It should respond with `SM`. If this is not the case, review the possible problems listed above. If you fat finger the `Y` and enter `y` instead, no cause for alarm, you will simply get the APC copyright notice.

Once you are sure that serial port communications is working, proceed to the next test.

Using `apctest` on Serial-Line UPSses

On an `apcsmart` serial-line UPS, `apctest` will give you access to the battery of low-level tests we described in `apctest`. If you have a voltage-signalling UPS, it enables a different test repertoire which is described here, Among other things, if you are uncertain about what kind of cable you have, you may be able to use `apctest` to figure that out.

Shutdown `apcupsd` if it is running. Make sure your `/etc/apcupsd/apcupsd.conf` file has **UPSTYPE backups** and **UP-SCABLE simple** Normally `apctest` will have been built and installed by default, otherwise, you can explicitly build it on Unix with:

```
cd <apcupsd-source-directory>
make apctest
./apctest
```

on Win32 systems, use:

```
make apctestwin32
./apctest
```

It will present you with the following output

```
2001-02-07 04:08:26 apctest 3.8.5 (3 January 2002) redhat
Checking configuration ...
sharenet.type = DISABLE
cable.type = CUSTOM_SIMPLE
mode.type = BK
Setting up serial port ...
Creating serial port lock file ...
Doing prep_serial() ...
Hello, this is the apcupsd Cable Test program.
This part of apctest is for testing dumb UPSes (ones that uses signaling rather than commands.
Most tests enter a loop polling every second for 10 seconds.
```

Then it will present you with the following list of choices:

- 1) Test 1 - normal mode
- 2) Test 2 - no cable
- 3) Test 3 - no power
- 4) Test 4 - low battery (requires test 3 first)
- 5) Test 5 - battery exhausted
- 6) Test 6 - kill UPS power
- 7) Test 7 - run tests 1 through 5
- 8) Guess which is the appropriate cable
- 9) quit

Select test number:

Run tests 1, 2, and 3. Note, none of the currently supported cables will indicate a change for test 2. You can then run test 8 to see what cable it thinks you should be using. Finally run test 4.

apctest can also be run for Smart UPSes.

The print out of your testing will be written to the file apctest.output. If you are unable to solve your problem, you can try posting that file to the development mailing list, and perhaps we can help you. In this case, please also include information on your operating system, which version of apcupsd you are using, your UPS model, and also your apcupsd.conf file.

Expected apctest Signals for a UPS:

If you have configured your UPS as:

```
UPSTYPE backups
```



```
UPSCABLE APC_940_0119A
  or APC_940_0127A
  or APC_940_0128A
  or APC_940_0020B
  or APC_940_0020C
```

here are typical signals you would expect to see in the output from the various tests of apctest:

```
Test 1 normal:           RTS for cables (0119A 0127A 0128A)
Test 2 no serial cable:  not important
Test 3 no AC power:     CTS for all cables
Test 4 batteries exhausted: CTS and CD for all cables
```

Note: **RTS** if set in Test 1 will probably also be set in all the other tests. This is not important, what counts is the appearance of **CTS** when the power fails and additionally **CD** when the batteries are low.

Expected apctest Signals for a BackUPS Pro:

If you have configured your UPS as:

```
UPSTYPE backupspro
UPSCABLE APC_940_0095A
  or APC_940_0095C
```

here are the typical signals you would expect to see in the output from the various tests of apctest:

```
Test 1 normal:           RTS not set
Test 2 no serial cable:  not important
Test 3 no AC power:     RNG
Test 4 batteries exhausted: RNG and CD
```

Note: **RTS** should never be set in any of the tests as it is the killpower signal. What is important is the appearance of **RNG** when the power fails and additionally **CD** when the batteries are low.

Troubleshooting Serial Line communications

Determining Which Voltage-Signaling Cable You Have

The most frequently encountered problem with voltage-signalling UPSes (e.g. BackUPS 650) is that you have incorrectly specified which cable is being used. All cables furnished by APC have the cable number stamped on the side of the computer connector end of the cable. Using this number with apcupsd will normally work fine. If you do not know what cable you have, you can use the apctest program to determine the type of the cable.

For simple signaling UPSes, you should *not* use **simple** in the cable specification (i.e. **UPSCABLE simple**) unless you have made the cable yourself according to the wiring diagram given in the cables chapter of this manual.

Once you have established serial communications

Once you have established that apcupsd can talk to the UPS over the serial part, go do the series of functional tests described in the main Testing (see Testing Apcupsd) section.

One additional note applies:

Bizarre Intermittent Behavior:

In one case, a user reported that he received random incorrect values from the UPS in the status output. It turned out that gpm, the mouse control program for command windows, was using the serial port without using the standard Unix locking mechanism. As a consequence, both apcupsd and gpm were reading the serial port. Please ensure that if you are running gpm that it is not configured with a serial port mouse on the same serial port.

Recalibrating the UPS Runtime

Note: In a future release of apcupsd this procedure will be replaced by a daemon operation that can be performed on all types of UPS.

This section does not apply to voltage-signalling or dumb UPSes such as the older BackUPS models.

Smart UPSes internally compute the remaining runtime, and `apcupsd` uses the value supplied by the UPS. As the batteries age (after say two or three years), the runtime computation may no longer be accurate since the batteries no longer hold the same charge. As a consequence, in the event of a power failure, the UPS and thus `apcupsd` can report a runtime of 5 minutes remaining when in fact only one minute remains. This can lead to a shutdown before you might expect it, because regardless of the runtime remaining that is reported, the UPS will always correctly detect low batteries and report it, thus causing `apcupsd` to correctly shutdown your computer.

If you wish to have the UPS recalibrate the remaining runtime calculations, you can do so manually as the current version of `apcupsd` does not support this feature. To do so,

- Shutdown `apcupsd`
- contact your UPS directly using some terminal program such as `minicom`, `tip`, or `cu` with the settings 2400 8N1 (2400 baud, 8 bits, no parity, 1 stop bit). Be extremely careful what you send to your UPS as certain characters may cause it to power down or may even cause damage to the UPS. Try sending an upper case Y to the UPS (without a return at the end). It should respond with SM. If this is not the case, read the chapter on testing. If you fat finger the Y and enter y instead, no cause for alarm, you will simply get the APC copyright notice.
- when you are sure you are properly connected send an upper case D (no cr). This will put the UPS into calibration mode, and it will drain the battery down to 25% capacity (35% for a Matrix) at which point it will go back on the mains. In doing so, it will recompute the runtime calibration.
- If you wish to abort the calibration, enter a second D command.
- When you are done, restart `apcupsd`.

In principle, you should be able to do this with the computer powered by the UPS, but if you wish to be completely safe, you should plug your computer into the wall prior to performing the runtime calibration. In that case, you will need to artificially load the UPS with light bulbs or other means. You should supply a load of about 30 to 35% but not more than 50%. You can determine the load by looking at the output of the `apcaccess status` command while `apcupsd` is running.

You should not run the recalibration command more than once or twice per year as discharging these kinds of batteries tends to shorten their life span.

Status Logging On Serial-Line UPSes

Serial-line UPSes that speak the apcsmart protocol log all of the events described in the Status Format (see apcupsd Status Logging) section of the Technical Reference. Voltage-signalling UPSes, on the other hand, have a much narrower data channel. They can only report a small handful of conditions.

The following summarizes (rather sketchily, sorry) the data you can expect to get from this obsolete hardware. All corrections and additions will be welcome.

From BackUPS Pro and SmartUPS v/s:

```
LINEFAIL : OnlineStatus
BATTSTAT : BatteryStatus
MAINS    : LineVoltageState
LASTEVNT : LastEventObserved
```

BackUPS and NetUPS Simple Signals

```
LINEFAIL : OnlineStatus
BATTSTAT : BatteryStatus
```

DATA Logging

This feature is somewhat outdated and not often used.

Data logging consists of periodically logging important data concerning the operation of the UPS. For the definitive definition of the format, see `log_data()` in `apcreports.c`. The format varies according to the UPS model and the information available from the UPS.

For UPS models, NBKPRO, SMART, SHARESMT, and MATRIX, the output is written in a format very similar to what PowerChute writes. That is:

```
MinLineVoltage,      MaxLineVoltage,      OutputVoltage,      Bat-
teryVoltage,        LineFrequency,      LoadPercent,        UPSTempera-
ture,AmbientTemperature,Humidity,LineVoltage, BatteryCharge,toggle
```

Any value that is not supported by your UPS such as `AmbientTemperature` and `Humidity` will be blank or possibly as 0.0. In any case the commas

before and after that field will still be output. The toggle value alternates from 0 to 1 on each line. This was added at user request so that no two adjacent samples are identical.

An actual example from the log file is:

```
Nov  2 12:43:05 matou apcupsd[23439]: 224.9,227.5,226.2,27.74,50.00,100.0,30.6,,226.2,50.0,1
```

Technical Reference

Configuration Directive Reference

Configuration directives in `/etc/apcupsd/apcupsd.conf` control the behavior of the `apcupsd` daemon. For most installations it is only necessary to set a handful of general directives. The rest can be left at their defaults unless you have an exotic configuration.

General Configuration Directives

In general, each of these directives is required (except that the `DEVICE` directive is ignored for `UPSCABLE` ether).

UPSTYPE `<type of APC UPS you have>` The name of a driver. Should be one of `dumb`, `apcsmart`, `net`, `usb`, `snmp`, or `test`. This describes your interface type.

The `UPSTYPE` directive can be defined during installation by using the `--with-upstype=` option of the `./configure` program.

UPSCABLE `<type of cable you are using>>` [`simple` | 940-0020B | 940-0023A]
[`smart` | 940-0024B | 940-0024C]
[940-1524C | 940-0024G | 940-0095A | 940-0095B | 940-0095C | 940-0119A]
[`ether` | `usb`]

The `--with-upscable=` option of `./configure` can be used to set a default for this directive during the your build.

DEVICE `<name of device>` Specify which device is used for UPS communications. For serial ports, it is usually something like `/dev/ttyS0`.

For USB ports, you may leave the name of the device blank (no specification) and `apcupsd` will automatically search the standard locations for the UPS.

Normally, the `./configure` program will set an appropriate default value. You may also specify the `--with-serial-dev=` option of the `./configure` program to set this directive at build time.

If you have specified **UPSTYPE net**, then the device name to be specified consists of **hostname:port** where the hostname is the fully qualified name or IP address of the host (NIS server) and the port (optional) is the port to use to contact the server.

If you specified **UPSTYPE snmp**, then the device name becomes **hostname:vendor:community**. Please see the SNMP chapter (see Support for SNMP UPSes) in this manual for more details.

LOCKFILE <path to lockfile> This option tells `apcupsd` where to create a lockfile for the USB or serial port in the specified directory. This is important to keep two programs from reading or writing the port at the same time. Please note that although the directive name is **LOCKFILE**, you are actually specifying the lock file path. `apcupsd` automatically appends the name of the device when creating the file. On most systems, this directive is automatically set by the `./configure` program. You may also explicitly set it during the build process by using the `--with-lock-dir=` option of the `./configure` program.

Configuration Directives Used by the Network Information Server

None of these directives are required for proper operation of `apcupsd`.

NETSERVER [**on** — **off**] This configuration directive turns the network information server on or off. If it is on, `apcupsd` will spawn a child process that serves **STATUS** and **EVENTS** information over the network. This information is currently used by the Web-based CGI programs. The default is on. In some cases, for added security, you may want to invoke a separate information server daemon from the `inetd` daemon. In that case, *NETSERVER* should be *off*.

NISIP <IP-address> This directive specifies the IP address of the network interface on which the NIS server will listen for incoming connections. Default value is 0.0.0.0 which means the NIS will listen for connections on all network interfaces. If your machine has more

than one interface, you can specify the IP of a single interface to limit connections to only that interface. Furthermore, you can specify the loopback address (127.0.0.1) to accept connections only from the local machine. You may also use the `--with-nisip=` option of the `./configure` program to set this directive during the build.

This directive does not work on Win32 machines because `inet_lpton()` is not implemented there.

NISPORT <port> This configuration directive specifies the port to be used by the apcupsd Network Information Server. The default is platform dependent, but typically 3551, which we have received from IANA as the official apcupsd networking port. If you change this port, you must manually change the `#define SERV_TCP_PORT` in `cgi/upsfetch.c` and rebuild the CGI programs. An alternative is to use the `--with-nis-port=` option of the `./configure` program during the build. In this case, all the appropriate locations will be automatically changed.

EVENTSFILE <filename> If you want the apcupsd network information server to provide the last 10 events via the network, you must specify a file where apcupsd will save these events. The default is: `/etc/apcupsd/apcupsd.events`. Currently, apcupsd will save at most the last 50 events. Periodically (once an hour by default), apcupsd will check the size of this file. When more than 50 events are recorded, apcupsd will truncate the file to the most recent 10 events. Consequently this file will not grow indefinitely. Although we do not recommend it, you may change these values by editing `apcevents.c` and changing the appropriate defines. Be aware that if you set these values to very large numbers, apcupsd may make excessive memory demands on the system during the data access and file truncation operations.

This filename may also be specified at build time by using the `--with-log-dir=` option of the `./configure` program.

Configuration Directives used during Power Failures

In general, none of these directives are required. However, if you have a voltage-signalling (dumb) UPS with a cable that does not support the Low Battery signal, you must set the `TIMEOUT` directive to force a shutdown. Please see the Cables (see Cables) section of this manual for more details.

BATTERYLEVEL <percent of battery> If `BATTERYLEVEL` is specified, during a power failure, apcupsd will halt the system

when the remaining battery charge falls below the specified percentage. The default is 5 percent. This directive is ignored for dumb (voltage-signalling) UPSes. To totally disable this counter, set **BATTERYLEVEL -1** in your `apcupsd.conf` file.

MINUTES <**battery runtime in minutes**> If **MINUTES** is specified, during a power failure, `apcupsd` will shutdown the system when the remaining runtime on batteries as internally calculated by the UPS falls below the time specified. The default is 3. This directive is ignored for dumb (voltage-signalling) UPSes. It should be noted that some UPSes report an incorrect value for remaining runtime when the battery is fully charged. This can be checked by examining the **TIMELEFT** value as printed in the output of an `apcaccess status` command. If the value is zero or otherwise unreasonable, your UPS is probably broken. In this case, we recommend that you disable this timer by setting **MINUTES -1** in your `apcupsd.conf` file.

TIMEOUT <**time in seconds**> After a power failure, `apcupsd` will halt the system when **TIMEOUT** seconds have expired. A value of zero disables this timer. Normally for all Smart UPS models and dumb UPSes with cables that support low battery detection, this should be zero so that the shutdown time will be determined by the battery level and/or remaining runtime (see above) or in the case of a voltage-signalling UPS, when the battery is exhausted. This command is required for dumb UPSes that do not provide a battery exhausted signal (only testing can determine this point). For more information, see the Testing (see

Testing `Apcupsd`) section of this manual. This timer can also be useful if you want some slave machines to shutdown before other machines to conserve battery power. It is also useful for testing `apcupsd` because you can force a rapid shutdown by setting a small value (e.g. 60) and pulling the plug to the UPS.

TIMEOUT, **BATTERYLEVEL**, and **MINUTES** can be set together without problems. `apcupsd` will react to the first case or test that is valid. Normally SmartUPS users will set **TIMEOUT** to zero so that the system is shutdown depending on the percentage battery charge remaining (**BATTERYLEVEL**) or the remaining battery runtime (**MINUTES**).

ANNOY <**time in seconds**> Specify the time in seconds between messages requesting logged in users to get off the system during a power failure. This timer starts only when the UPS is running on batteries. The default is 300 seconds (5 minutes). `apcupsd` sends the annoy messages by invoking the `apccontrol` script with the `annoyme` argument.

The default is to send a wall message on Unix systems and a popup message in Windows.

The value of **ANNOYDELAY** must be greater than the value of **ANNOY** in order to receive annoy messages (this doesn't make sense, and means that the default values do not generate annoy messages: KES).

Note that if **NOLOGON** is set to **disable** the annoy messages will also be disabled.

ANNOYDELAY <**time in seconds**> Specify delay time in seconds before apcupsd begins requesting logged in users to get off the system during a power failure. This timer starts only after the UPS is running on batteries. This timer is reset when the power returns. The default is 60 seconds. Thus, the first warning to log off the system occurs after 60 seconds on batteries, assuming that **NOLOGON** is not set to **disable**.

NOLOGON <**specifies when apcupsd should prevent user logins**> [**disable** — **timeout** — **percent** — **minutes** — **always**] are valid types.

The type specified allows you define the point when apcupsd will create the 'nologin' file and thus when user logins are prohibited. Once the 'nologin' file is created, normal users are prevented from logging in. Control of when this file is created is important for allowing systems with big UPSes to run as normally until the system administrator determines the need for preventing user logins. The feature also allows the system administrator to hold the "ANNOY" factor until the 'nologin' file is created. The default is always **disable** if no **NOLOGON** directive is specified.

The 'nologin' file will be created in the directory specified by the **NOLOGINDIR** directive described below.

As far as I can tell, the only useful types are **disable** and **always** since the difference in the time when the logout warning is given and shutdown occurs for the other types is very short (KES).

disable prevents apcupsd from creating the nologin file. Consequently, any user can login during a power failure condition. Also, the **ANNOY** feature is disabled so users will not be warned to logoff the system.

timeout specifies that apcupsd should prohibit logins after the UPS is on batteries for 90% of the time specified on the **TIMEOUT** configuration directive. Note! Normally you don't want to specify a **TIMEOUT** value, so this option is probably not too useful (KES).

percent specifies that apcupsd should prohibit logins when the remaining battery charge percentage reaches 110% or less than the value specified on the **BATTERYLEVEL** configuration directive. Thus if the **BATTERYLEVEL** is specified as 15, apcupsd will prohibit logins when the battery charge drops below 16% ($15\% \times 110\% = 16\%$).

minutes specifies that apcupsd should prohibit logins when the remaining runtime in minutes reaches 110% or less than the value specified on the **MINUTES** configuration directive. Thus if **MINUTES** is set to 3, apcupsd will prohibit logins when the remaining runtime is less than 3 minutes ($3 \times 110\% = 3$).

always causes apcupsd to immediately prohibit logins when a power failure occurs. This will also enable the ANNOY feature.

NOLOGINDIR <path to nologin dir> This directive configures the directory into which apcupsd will write the nologin file, as described above for the NOLOGON directive.

Normally, the `./configure` program will set an appropriate default value for your platform, often `/etc`. You may also specify the `--with-nologdir=` option of the `./configure` program to change the default at compile time.

KILLDELAY <time in seconds> If `killdelay` is set, apcupsd will continue running after a shutdown has been requested, and after the specified time in seconds, apcupsd will attempt to shut off the UPS the power. This directive should normally be disabled by setting the value to zero, but on some systems such as Win32 systems apcupsd cannot regain control after a shutdown to force the UPS to shut off the power. In this case, with proper consideration for the timing, the **KILLDELAY** directive can be useful. Please be aware, if you cause apcupsd to kill the power to your computer too early, the system and the disks may not have been properly prepared. In addition, apcupsd must continue running after the shutdown is requested, and on Unix systems, this is not normally the case as the system will terminate all processes during the shutdown.

SCRIPTDIR <path to apcontrol dir> This option configures the directory in which `apcontrol` and other event scripts are located.

Normally, the `./configure` program will set an appropriate default value for your platform, often `/etc/apcupsd`.

PWRFAILDIR <path to powerfail dir> When apcupsd shuts down your system, it creates a temporary "flag file" which is used by the operating system halt scripts to know if this shutdown is due to a

power failure. This directive configures which directory the flag file will be written into. The chosen directory must be writable by the user `apcupsd` is running as (normally `root`) and must not be cleared or unmounted early in the shutdown sequence.

Normally, the `./configure` program will set an appropriate default value for your platform, often `/etc/apcupsd`. You may also specify the `--with-pwrfaildir=` option of the `./configure` program to change the default at compile time.

Configuration Directives used to Control System Logging

STATTIME<**time**> This directive supplies the time interval between writes to the `STATUS` file. If set to zero, the `STATUS` file will not be written. Please note that in a future version of `apcupsd` the `STATUS` file code will disappear since its functionality has been replaced by the Network Information Server and by **`apcaccess status`**, as a consequence, it is normally disabled by setting it to zero.

STATFILE <**file**> This directive specifies the file to be used when writing the `STATUS` information. The default is `/etc/apcupsd/apcupsd.status`.

DATETIME<**time**> This directives supplies the time interval between writes of PowerChute™ like data information to the log file. See the Data (see `DATA Logging`) section of this manual for additional details.

FACILITY<**log-facility**> The facility directive can be used to change the system logging class or facility. The default is **`DAEMON`**. This parameter can be useful if you wish to direct the `apcupsd` system logging information to other than your system default files. See the `Logging` section of this manual for additional details.

Configuration Directives for Sharing a UPS

The following directives apply to sharing an UPS using a `ShareUPS` hardware module. Most users will not use this mode.

UPSCLASS <**class of operation**> [`standalone` — `shareslave` — `sharemaster`] are valid types.

The default is **standalone** and should be used for all machines powered by the UPS and having a serial port or other direct connection to the UPS. This is the normal case.

Use **shareslave** if and only if you are using a ShareUPS and connected to a BASIC Port with Simple Signal. This code is not fully tested.

Use **sharemaster**, if and only if you are using a ShareUPS and connected to the ADVANCED Port Smart Signal control. This code is not fully tested.

UPSMODE <**mode of operation**> [disable — share] are valid modes.

For normal standalone operations, you will set UPSMODE to disable to indicate that you are disabling the ShareUPS support.

Use share for two or seven (2/7) additional simple signal ports on a SmartAccessories(tm) (internal/external box) for SmartUPSes. The share and sharenet code is not fully tested.

NETTIME <**time in seconds**> The interval in seconds that the master uses to send information to slave machines. This rate is automatically set to 1 second if the UPS goes on batteries and reset to your specified value when the mains power returns. A typical value might be 60 seconds.

Configuration Directives Used to Set the UPS EPROM

NOTE. THESE ARE DEPRECATED AND NO LONGER WORK IN APCUPSD PLEASE USE APCTEST

The values specified with the following directives are only used if the **--configure** option is specified on the apcupsd command line, and the UPS is capable of internal EPROM programming. In that case, apcupsd attempts to set the values into the UPSes EPROM.

Under normal operations, the values for these parameters specified in the configuration file are not used. Instead, they are read from the UPS EPROM by apcupsd. See Configuration Directives Used to Set the UPS EPROM of this manual for further details before attempting to reprogram your EEPROM.

SENSITIVITY <**sets sensitivity level**> (H)igh, (M)edium, (L)ow

This value determine how sensitive the UPS is to the mains quality and voltage fluctuations. The more sensitive it is, the quicker the

UPS will switch to battery power when the mains line quality is bad. Normally, this should be set to H, but if you find your UPS switching to batteries frequently, you might want to try a less sensitive setting, providing that your computer equipment tolerates the poor quality mains. This value is written to the UPS EPROM when the configure option is specified.

Under normal apcupsd operations (no `--configure` option), apcupsd will read the value stored in the UPS and display it in the STATUS output.

WAKEUP <set wakeup delay> The UPS power restart delay value in [0,60,180,300] in seconds after the UPS has shut down during a power failure. This is to prevent the power from coming back on too quickly after a power down, and is important for those who have high rpm drives that need to spin down before powering them up again. Some older SCSI models are very sensitive to this problem. Default is zero. This value is written to the UPS EPROM when the `--configure` option is specified.

Under normal apcupsd operations (no `--configure` option), apcupsd will read the value stored in the UPS and display it in the STATUS output.

SLEEP <set sleep delay> The UPS delay or grace period in [20,180,300,600] seconds before the UPS cuts the power to your equipment. The default is 20 seconds. This value is written to the UPS EPROM when the `--configure` option is specified.

Under normal apcupsd operations (no `--configure` option), apcupsd will read the value stored in the UPS and display it in the STATUS output.

LOTRANSFER <lower limit of ups batt. transfer> This sets the low line voltage point at which to switch over to batteries. Different values are permitted based on the UPS model, classification, and manufacture date. Use `apcaccess eeprom` to show you which values are permitted. This value is written to the UPS EPROM when the `--configure` option is specified.

Under normal apcupsd operations (no `--configure` option), apcupsd will read the value stored in the UPS and display it in the STATUS output.

HITRANSFER <upper limit of ups batt. transfer> This sets the high line voltage point to switch over to batteries. Different values are permitted based on the UPS model, classification, and manufacture

date. Use `apcaccess eeprom` to show you which values are permitted. This value is written to the UPS EPROM when the `--configure` option is specified.

Under normal `apcupsd` operations (no `--configure` option), `apcupsd` will read the value stored in the UPS and display it in the STATUS output.

RETURNCHARGE <min. batt. charge level> This parameter specifies what battery percentage charge is necessary before the UPS will supply power to your equipment after a power down. Different values are permitted based on the UPS model, classification, and manufacture date. Use `apcaccess eeprom` to show you which values are permitted. This value is written to the UPS EPROM when the `--configure` option is specified.

Under normal `apcupsd` operations (no `--configure` option), `apcupsd` will read the value stored in the UPS and display it in the STATUS output.

BEEPSTATE <alarm beep state> This parameter tells the UPS when it can sound its audio alarm. These settings are based on discrete events related to the remaining capacity of the UPS.

0 immediately upon power failure

T power failure + 30 seconds

L low battery power

N never

UPSNAME <string> This is an eight character string. This is the UPS name that will be stored in the UPS EPROM.

BATTDATE <string> This is an eight character string that is the last date the batteries were changed.

apcupsd Status Logging

There is a good deal of information available about the UPS and `apcupsd`'s status. This document describes the format of that information. Normally you will get at it via `apcaccess`, but there are other ways as well.

Status report format

The STATUS output is in ASCII format with a single data value or piece of information on each line output. Because not all UPSes supply the same information, the output varies based on the type of UPS that you are using. In general, if the information is not available for your UPS, the data portion of the output record will contain an **N/A** indicating that the information is not available.

Status logging consists of periodically logging ALL available information concerning the UPS. Since the volume of data is rather large (over 1000 bytes per status), the STATUS data is not automatically sent to the system log file, instead, it is written as a series of data records to a specific file (normally `/etc/apcupsd/apcupsd.status`).

After each write, the file is rewound so that the size of the file remains constant. At the current time, this file is 1135 bytes. The format of this file is very similar to the old `apcupsd.procfs` file. The STATUS file is kept for backward compatibility and will be eliminated in a future version of `apcupsd`. The preferred method for obtaining this information is from `apcaccess` or by using the CGI interface (see `apcupsd` Network Monitoring [CGI] Programs).

To make reading the status data reliable via a named pipe, the first record written contains a version number, the number of records that follow the first record, and the total number of bytes in those subsequent records. An actual example of such a status file (`/etc/apcupsd/apcupsd.status`) is:

Consequently, the first record always consists of 24 bytes (23 characters followed by a newline). This record starts with APC and as indicated in the example above is followed by 28 records consisting of 675 bytes. The last record begins with END APC and contains the date and time matching the DATE record.

Documentation of each record needs to be written. In the coming weeks, I plan to add additional records and possibly change the names of some of the fields.

When this data is written to a file, it is written as two records, the first record, and all the other records together. In reading the file, it can be either be read a record at a time, or in one big read.

When this data is written to `syslog()`, it is written a record at a time. The first record is the first 24 bytes. By having the number of records and the size in the first record, the complete status can be reliably reassembled.

Status Report Example

An example of output from an international SmartUPS 1000 follows:

```
DATE      : Wed Sep 27 17:30:23 CEST 2000
HOSTNAME  : polymatou.sibbald.com
RELEASE  : 3.7.3-20000925
CABLE    : Custom Cable Smart
MODEL    : SMART-UPS 1000
UPSMODE  : Stand Alone
STARTTIME: Wed Sep 27 10:39:23 CEST 2000
UPSNAME  : UPS_IDEN
STATUS   : ONLINE
LINEV    : 235.3 Volts
LOADPCT  : 9.3 Percent Load Capacity
BCHARGE  : 100.0 Percent
TIMELEFT : 130.0 Minutes
MBATTCHG : 5 Percent
MINTIMEL : 3 Minutes
MAXTIME  : 0 Seconds
MAXLINEV : 239.2 Volts
MINLINEV : 234.0 Volts
OUTPUTV  : 236.6 Volts
SENSE    : High
DWAKE    : 000 Seconds
DSHUTD   : 020 Seconds
DLOWBATT : 02 Minutes
LOTRANS  : 196.0 Volts
HITRANS  : 253.0 Volts
RETPCT   : 000.0 Percent
ITEMP    : 32.8 C Internal
ALARMDEL : 5 seconds
BATTV    : 27.9 Volts
LINEFREQ : 50.0 Hz
LASTXFER : Line voltage notch or spike
NUMXFERS : 0
XONBATT  : N/A
TONBATT  : 0 seconds
CUMONBATT: 0 seconds
XOFFBATT : N/A
SELFTEST : NO
STESTI   : 336
STATFLAG : 0x08 Status Flag
DIPSW    : 0x00 Dip Switch
REG1     : 0x00 Register 1
REG2     : 0x00 Register 2
REG3     : 0x00 Register 3
MANDATE  : 07/31/99
SERIALNO : QS9931125245
BATTDATA : 07/31/99
NOMOUTV  : 230
NOMBATTV : 24.0
```

HUMIDITY : N/A
AMBTEMP : N/A
EXTBATTs : 0
BADBATTs : N/A
FIRMWARE : 60.11.I
APCMODEL : IWI
END APC : Wed Sep 27 17:30:31 CEST 2000

Status Report Fields

The meaning of the above variables are:

APC is the header record indicating the STATUS format revision level, the number of records that follow the APC statement, and the number of bytes that follow the record.

DATE is the date and time that the information was last obtained from the UPS.

HOSTNAME is the name of the machine that collected the UPS data.

RELEASE is the apcupsd release number.

CABLE is the cable as specified in the configuration file.

MODEL is the UPS model as derived from information from the UPS.

UPSMODE is the mode in which apcupsd is operating.

STARTTIME is the time/date that apcupsd was started.

UPSNAME is the name of the UPS as stored in the EEPROM.

STATUS is the current status of the UPS (ONLINE, CHARGING, ON-BATT,...)

MASTERUPD is the last time the master sent an update to the slave.
This value is present only in slave configurations.

LINEV is the current line voltage as returned by the UPS.

LOADPCT is the percentage of load capacity as estimated by the UPS.

BCHARGE is the percentage charge on the batteries.

TIMELEFT is the remaining runtime left on batteries as estimated by the UPS.

MBATTCHG if the battery charge percentage (BCHARGE) drops below this value, apcupsd will shutdown your system.

MINTIMEL apcupsd will shutdown your system if the remaining runtime equals or is below this point.

MAXTIME apcupsd will shutdown your system if the time on batteries exceeds this value. A value of zero disables the feature.

MAXLINEV is the maximum line voltage since the last STATUS as returned by the UPS.

MINLINEV is the minimum line voltage since the last STATUS as returned by the UPS.

OUTPUTV is the voltage the UPS is supplying to your equipment.

SENSE is the sensitivity level of the UPS to line voltage fluctuations.

DWAKE is the amount of time the UPS will wait after a power off condition when the power is restored.

DSHUTD is the grace delay that the UPS gives after receiving a power down command from apcupsd before it powers off your equipment.

DLOWBATT is the remaining runtime below which the UPS sends the low battery signal. At this point apcupsd will force an immediate emergency shutdown.

LOTRANS is the line voltage below which the UPS will switch to batteries.

HITRANS is the line voltage above which the UPS will switch to batteries.

RETPCT is the percentage charge that the batteries must have after a power off condition before the UPS will restore power to your equipment.

STATFLAG is a status flag indicating the UPS status. See STATUS.

ITEMP is the internal UPS temperature as supplied by the UPS.

ALARMDEL is the delay period for the UPS alarm.

BATTV is the battery voltage as supplied by the UPS.

LINEFREQ is the line frequency in Hertz as given by the UPS.

LASTXFER is the reason for the last transfer to batteries.

NUMXFERS the number of transfers to batteries since apcupsd startup.

XONBATT time and date of last transfer to batteries, or N/A.

TONBATT time in seconds currently on batteries, or 0.

CUMONBATT total (cumulative) time on batteries in seconds since apcupsd startup.

XOFFBATT time and date of last transfer from batteries, or N/A.

SELFTTEST is the results of the last self test, and may have the following values: OK - self test indicates good battery BT - self test failed due to insufficient battery capacity NG - self test failed due to overload NO - No results (i.e. no self test performed in the last 5 minutes).

STESTI is the interval in hours between automatic self tests.

STATFLAG status flag. English version is given by STATUS.

DIPSW is the dip switch settings.

REG1 is the value from the UPS fault register 1.

REG2 is the value from the UPS fault register 2.

REG3 is the value from the UPS fault register 3.

MANDATE is the date the UPS was manufactured.

SERIALNO is the UPS serial number.

BATTDATE is the date that batteries were last replaced.

NOMOUTV is the output voltage that the UPS will attempt to supply when on battery power.

NOMBATTV is the nominal battery voltage.

HUMIDITY is the humidity as measured by the UPS.

AMBTEMP is the ambient temperature as measured by the UPS.

EXTBATT is the number of external batteries as defined by the user.
A correct number here helps the UPS compute the remaining runtime more accurately.

BADBATT is the number of bad battery packs.

FIRMWARE is the firmware revision number.

APCMODEL is the old APC model identification code.

END APC is the time and date that the STATUS record was written.

Logging the STATUS Information

If specified in the configuration file, the STATUS data will also be written to the system log file. Please note, that it would not normally be wise to write this data to a normal system log file as there is no mechanism in `syslog()` to rewind the file and hence the log file would quickly become enormous. However, in two cases, it can be very useful to use `syslog()` to write this information.

The first case is to set up your `syslog.conf` file so that the data is written to a named pipe. In this case, normally not more than about 8192 bytes of data will be kept before it is discarded by the system.

The second case is to setup your `syslog.conf` file so that the status data is sent to another machine, which presumably then writes it to a named pipe. Consequently, with this mechanism, provides a simple means of networking `apcupsd` STATUS information.

Although we mention system logging of STATUS information, we strongly recommend that you use `apcaccess` or the CGI interface to get this information.

The Shutown Sequence and its Discontents

Shutdown Sequence

If you experienced so problems with the testing procedures, or if you are porting `apcupsd` to another system, or you are simply curious, you may want to know exactly what is going on during the shutdown process.

The shutdown sequence is as follows:

- `apcupsd` detects that there is a power problem and it calls `/etc/apcupsd/apccontrol powerout`, which normally sends a message to all users informing them of a potential problem.
- After approximately 5 seconds in the power problem mode, `apcupsd` calls `/etc/apcupsd/apccontrol onbattery`, which normally sends a message to all users informing them that the UPS is on batteries.
- When one of the conditions listed below occurs, `apcupsd` issues a shutdown command by calling `/etc/apcupsd/apccontrol doshutdown`, which should perform a shutdown of your system using the system

`shutdown(8)` command. You can modify the behavior by editing the `/etc/apcupsd/apccontrol` script, but doing so will make it more complicated to upgrade to the next `apcupsd` version.

The conditions that trigger the shutdown can be: running time on batteries have expired (`TIMEOUT`), the battery runtime remaining is below the configured value (`BATTERYLEVEL`), the estimated remaining runtime is below the configured value (`MINUTES`), or the UPS signals that the batteries are exhausted.

A shutdown could also be initiated if `apcupsd` detects that the batteries are no longer functioning correctly. This case, though very unusual, can happen at any time even if there is proper mains voltage, and `/etc/apcupsd/apccontrol emergency` is called.

Just before initiating any shutdown through the `apccontrol` script, `apcupsd` will create the file `/etc/apcupsd/powerfail`. This file will be used later in the shutdown sequence to recall `apcupsd` after syncing of the disks to initiate a power off of the UPS.

If the `/etc/nologin` file has not already been created, it will normally be created during the shutdown sequence to prevent additional users from logging in (see the `NOLOGIN` configuration directive).

Even though `apcupsd` has requested the system to perform a shutdown, it continues running.

- When the system signals `apcupsd` to do exit, it does so. This is part of the normal system shutdown (at least on Unix and Linux systems) and the exact time that `apcupsd` receives the termination signal depends on how the shutdown links (usually in `/etc/rc.d`) are set.

Note that on Windows NT systems, `apcupsd` apparently continues to run as a Service even though the machine is “shutdown”.

- During the shutdown of the system after `apcupsd` has been forced to exit, one of the last things done by the system shutdown is to call the halt script, which is usually in `/etc/rc.d/halt` or `/etc/rc.d/init.d/halt`, or possibly in `/sbin/init.d/rc.0` depending on your system. If `apcupsd` was properly installed, this standard halt script was modified to include a bit of new logic just before the final halt of the system. It first tests if the file `/etc/apcupsd/powerfail` exists, and if it does, it executes `/etc/apcupsd/apccontrol killpower`. It is this last step that will cause `apcupsd` to be re-executed with the `--killpower` option on the command line. This option tells `apcupsd` to inform the UPS to kill the power.

This final step is important if you want to ensure that your system will automatically reboot when the power comes back on. The actual code used on the Red Hat version is:

Valid EPROM values for the SMART-UPS 1000

Description	Config Directive	Current Value	Permitted Values
Upper transfer voltage	HITRANSFER	253	253 264 271 280
Lower transfer voltage	LOTRANSFER	196	196 188 208 204
Return threshold	RETURNCHARGE	0	00 15 50 90
Output voltage on batts	OUTPUTVOLTS	230	230 240 220 225
Sensitivity	SENSITIVITY	H	H M L L
Low battery warning	LOWBATT	2	02 05 07 10
Shutdown grace delay	SLEEP	20	020 180 300 600
Alarm delay	BEEPSTATE	0	0 T L N
Wakeup delay	WAKEUP	0	000 060 180 300
Self test interval	SELFTTEST	336	336 168 ON OFF

The line of interest for you is the **Shutdown grace delay**, which can be changed using the SLEEP (see SLEEP <set sleep delay>) directive in your **apcupsd.conf** file. The default value is 20 seconds, but generally, you can set it to 180, 300, or 600 seconds depending on your UPS. See the EEPROM (see Configuring Your EEPROM) this manual for further details on how to change this EPROM value.

If you use the **---kill-on-powerfail** option, you run the risk of having the computer power cut before the system has shutdown. Even if the grace period is rather long, if something goes wrong in the shutdown, well, it is up to you to decide.

If apcupsd has successfully shutdown your computer and powered off the UPS during a power outage, you can control whether or not your computer is automatically rebooted when the power returns.

The UPS contains two internal EPROM values that determine when it will restore power to your computer after a full power shutdown. They are the RETURNCHARGE (see RETURNCHARGE <min_ batt_ charge level>) percentage and the WAKEUP (see WAKEUP <set wakeup delay>) delay. Briefly, the **RETURNCHARGE** specifies what percentage charge the battery must have before the power is restored. Higher values are recommended in regions where the power goes up and down frequently. The **WAKEUP** delay is a simple time delay. Most sites will have both of these at zero, or perhaps the **RETURNCHARGE** set to 15. Please follow the links to the **Configuration** section of this manual for more information. See the EEPROM (see Configuring Your EEPROM) of this manual for further details on how to change these EPROM values.

Shutdown Problems

Obviously if your halt script is not properly modified, apcupsd will not be able to shut off the power to the UPS, and if the power returns before the batteries are exhausted your system will not automatically reboot. In any case, your machine should have been cleanly shut down.

Master/Slave Shutdown

In master/slave configurations, however, the master cannot be 100 percent sure that the slaves have all shutdown before it performs the power off. As a consequence, it is possible that the master will shut off the power before the slave has finished shutdown. If this is the case, the best procedure is to put an appropriate sleep command in the `/etc/apcupsd/apccontrol` file on the master. For example to give the slaves 30 additional seconds to shutdown, one would add:

```
sleep 30
```

just after the line that reads

```
doshutdown)
```

in the `apccontrol` file (approximately line 79 – depending on your system version).

Also, on a slave machine, you do not want to use the modified halt script since it will recall `apcupsd`, which will detect that it is a slave (i.e. no connection to the UPS) and will complain that it cannot do the killpower. This situation is not harmful just annoying and possibly confusing.

One possible problem during shutdown can be caused by remnants of old versions. Please be sure to delete or rename all prior versions (`/usr/local/sbin/apcupsd` or `/sbin/powersec`).

Startup

Normally, `apcupsd` is automatically started when your system is rebooted. This normally occurs because the startup script `apcupsd` is linked into the appropriate places in `/etc/rc.d`. On most Linux systems, there is a program

called `chkconfig(8)` that will automatically link the startup script. This program is invoked by the `make install` scripts, or it is explicitly done for those systems that do not have `chkconfig(8)`. If this is not the case, you can either link it in appropriately yourself or explicitly call it from your `rc.local` file. The appropriate manual way to startup `apcupsd` is by executing:

```
<path>/apcupsd start
```

where `<path>` is normally `/etc/rc.d` or `/etc/rc.d/init.d` depending on your system (isn't Unix wonderful? :-)). Using this script is important so that any files remaining around after a power failure are removed. Likewise, shutting down `apcupsd` should be done with the same script:

```
<path>/apcupsd stop
```

Windows Considerations

Please see the end of Windows chapter (see Installation on Windows) of this manual for conderations pertaining to shutdown and killpower on Windows.

APC smart protocol

The APC UPS protocol was originally analyzed by Pavel Korensky with additions from Andre H. Hendrick beginning in 1995, and we want to give credit for good, hard work, where credit is due. After having said that, you will see that Steven Freed built much of the original `apcupsd` information file. [Comment inserted by Riccardo Facchetti]

The start of this chapter of the `apcupsd` manual in HTML format was pulled from the Network UPS Tools (NUT) site. It has been an invaluable tool in improving `apcupsd`, and I consider it the **Bible** of APC UPS programming. In the course of using it, I have added information gleaned from `apcupsd` and information graciously supplied by APC. Hopefully, the additions made herein can benefit the original author and his programming project, and maybe some day, the `apcupsd` project and the **NUT** project can join forces.

Description

Here's the information on the elusive APC smart signaling protocol used by their higher end units (Back-UPS Pro, Smart-UPS, Matrix-UPS, etc). What you see here has been collected from a variety of sources. Some people analyzed the chatter between PowerChute and their hardware. Others sent various characters to the UPS and figured out what the results meant.

RS-232 differences

Normal 9 pin serial connections have TxD on 3 and RxD on 2. APC's smart serial ports put TxD on pin 1 and RxD on pin 2. This means you go nowhere if you use a normal straight through serial cable. In fact, you might even power down the load if you plug one of those cables in. This is due to the odd routing of pins - DTR and RTS from the PC usually wind up driving the on/off line. So, when you open the port, they go high and *poof* your computer dies.

Originally this evil hack was used to connect the UPS to the PC when this page was first being built. As you can see, I cheated and neglected the ground (only 2 wires!) and it still worked. This method can be used for playing around, but for professional systems this is obviously not a viable option.

That hack didn't work out so well (damned cats), so it was retired quite awhile back. The most practical solution was to go out and BUY the DOS/Win version of PowerChute just for the black (smart) cable. I recommend doing the same thing if you actually care about this thing working properly. Of course, if you have one of the newer packages that came with PowerChute, you already have the cable you need.

Diagram for cable hackers

If you are handy with cable creation tools, check out the 940-0024C clone diagram. That's the black "smart" cable normally provided with APC models sold after 1996. The loopback pins on that diagram are used to keep PowerChute happy by allowing cable detection. If you use the NUT apcsmart driver, those pins don't matter.

Many thanks to Steve Draper for providing this scan.

For additional information on cables, see the section on custom cables (see

Cables) in this manual.

The Smart Protocol

Despite the lack of official information from APC, this table has been constructed. It's standard RS-232 serial communications at 2400 bps/8N1. Don't rush the UPS while transmitting or it may stop talking to you. This isn't a problem with the normal single character queries, but it really does matter for multi-char things like "@000". Sprinkle a few calls to `usleep()` in your code and everything will work a lot better.

The following table describes the single character **Code** or command that you can send to the UPS, its meaning, and what sort of response the UPS will provide. Typically, the response shown below is followed by a newline (`\n` in C) and a carriage return (`\r` in C). If you send the UPS a command that it does not recognize or that is not available on your UPS, it will normally respond by "NA" for not available, otherwise the response is given in the "Typical results" column. >

Code	Meaning	Typical results
<code>^A</code>	Model string	SMART-UPS 700
<code>^N</code>	Turn on UPS (send twice, with > 1.5s delay between chars) Only on 3rd gen SmartUPS and Black Back-UPS Pros	n/a
<code>^Z</code>	Permitted EEPROM Values	A large string (254 chars) that gives the EEPROM permitted values for your model. For details see below.
A	Front panel test	Light show + "OK" (and 2s beep)
B	Battery voltage	Ranges - typical "27.87"
C	Internal temperature (degrees C)	Ranges - typical "036.0"
D	Runtime calibration - runs until battery is below 25% (35% for Matrix) This updates the 'j' values - only works at 100% battery charge. Can be aborted with a second "D"	! when on battery, \$ on line
E	Automatic self test intervals	Default = 336 (336 hours = 14 days) (336=14 days, 168=7 days, ON=power on, OFF=never)
F	Line frequency, Hz	60.00 (50.0 in Europe)

G	Cause of transfer	R = unacceptable utility voltage rate of change, H = high utility voltage, L = low utility voltage, T = line voltage notch or spike, O = no transfers yet (since turnon), S = transfer due to serial port U command or activation of UPS test from front panel, NA = transfer reason still not available (read again).
K—K	Shutdown with grace period (set with 'p') - need > 1.5s between first and second K	Matrix/3rd gen SmartUPS/Black Back-UPS Pros: "OK", all others: "*"
L	Input line voltage	Ranges - typical "118.3" or "228.8" in Europe
M	Maximum line voltage received since last M query	Ranges - typical "118.9" or "230.1" in Europe
N	Minimum line voltage received since last N query	Ranges - typical "118.9" or "226.2" in Europe
O	Output voltage	Ranges - typical "118.3" or "228.8" in Europe
P	Power load %	Ranges - typical "011.4" depends on what you have plugged in.
Q	Status flags	Bitmapped, see below
R	Turn dumb Only on 3rd gen SmartUPS, SmartUPS v/s, BackUPS Pro	"BYE"
S	Soft shutdown after 'p' delay, return online when power returns Only works when UPS is on battery	OK
U	Simulate power failure	!! when switching to battery, then \$ when back on line
V	Old firmware revision	"GWD" or "IWI" The last character indicates the locale (Domestic, International).
W	Self test (battery), results stored in "X"	"OK"
X	Results of last self test	"OK" - good battery, "BT" - failed due to insufficient capacity, "NG" - failed due to overload, "NO" - no results available (no test performed in last 5 minutes)
Y	Enter smart mode	"SM"

Z—Z	Shutdown immediately (no delay) - need > 1.5s between first and second Z	N/A
a	Show protocol version.alert messages.valid commands (delimited by periods)	“3.!\$%+?=#—. ^A ^N ^Z+- 789<@ABCDEFGHJKLMNOPSUVWXYZ’abcfe g jklm - Link-Level.alert-messages.commands
b	Firmware revision	“50.9.D” - 50 = SKU (variable length), 9 = firmware revision, D = country code (D=USA, I=International, A=Asia, J=Japan, M=Canada)
c	UPS local id	UPS_IDEN (you can program any 8 characters here)
e	Return threshold	% battery charge threshold for return (00=00%, 01=15%, 02=25%, 03=90%)
f	Battery level %	Ranges - typical “100.0” when fully charged as should normally be the case
g	Nominal battery voltage (not actual voltage - see B)	“012” or “024” or “048”.
h	Measure-UPS: ambient humidity (%)	“nnn.n” - percentage
i	Measure-UPS: dry contacts	10 = contact 1, 20 = 2, 40 = 3, 80 = 4
j	Estimated runtime at current load (minutes)	“0112:” (note, it is terminated with a colon)
k	Alarm delay	0(zero) = 5 second delay after fail, T = 30 second delay, L = alarm at low battery only, N = no alarm
l	Low transfer voltage	Default “103” or “208” in Europe
m	Manufacturing date	Unique within groups of UPSes (production runs)
n	Serial number	Unique for each UPS
o	Nominal Output Voltage	The Nominal Output Voltage when running on batteries. Default “115” or “230” in Europe.
p	Shutdown grace delay, seconds	Default “020” (020/180/300/600)
q	Low battery warning, minutes	Default “02”
r	Wakeup delay (time) - seconds	Default “000” (000/060/180/300)
s	Sensitivity	“H” - highest, “M” - medium, “L” - lowest, “A” - autoadjust (Matrix only)

u	Upper transfer voltage	Default "132" or "253" in Europe
t	Measure-UPS: ambient temperature (degrees C)	"nn.nn"
x	Last battery change	Eight characters. Varies typically dd/mm/yy - 31/12/99
y	Copyright notice	"(C) APCC" - only works if firmware letter (from "V") is later than O
z	Reset the EEPROM to factory settings (but not ident or batt replacement date) Not on SmartUPS v/s or BackUPS Pro	"CLEAR"
+	Capability cycle	Cycle forward through possible values ("—" from UPS afterward to confirm change). Do not use this unless you know how to program your UPS EEPROM or you may damage your UPS.
-	Capability cycle	Cycle backward through possible values ("—" from UPS afterward to confirm change)Do not use this unless you know how to program your UPS EEPROM or you may damage your UPS.
@nnn	Shutdown (after delay 'p') with delayed wakeup of nnn tenths of an hour (after 'r' time)	Matrix/3rd gen UPS: "OK", others "*"
0x7f (DEL key)	Abort shutdown - use to abort @, S, K—K	"OK"
~	Register #1	See below
,	Register #2	See below
0	Battery constant	Set to A0 on SmartUPS 1000 with new battery
4	???	Prints 35 on SmartUPS 1000
5	???	Prints EF on SmartUPS 1000
6	???	Prints F9 on SmartUPS 1000
7	Dip switch positions (if applicable)	See below
8	Register #3	See below
9	Line quality	"FF" acceptable, "00" unacceptable

>	Number of external battery packs attached	SmartCell models: "nnn" where nnn is how many external packs are connected Non-SmartCell units: whatever has been set with >+ and >- by the user
Matrix UPS (and possibly Symmetra) specific commands		
^	Run in bypass mode	If online, "BYP" is received as bypass mode starts If already in bypass, "INV" is received and UPS goes online "ERR" received if UPS is unable to transfer
<	Number of bad battery packs	"nnn" - count of bad packs connected to the UPS
/	Load current	"nn.nn" - true RMS load current drawn by UPS
\	Apparent load power	"nnn.nn" - output load as percentage of full rated load in VA.
^V	Output voltage selection (editable)	"A" - automatic according to input tap, "M" - 208 VAC, "I" - 240 VAC
^L	Front panel language	"E" - English, "F" - French, "G" - German, "S" - Spanish, "1" "2" "3" "4" - ?
w	Run time conservation	"NO" (disabled) or "02" "05" "08" - minutes of runtime to leave in battery (UPS shuts down "early")

Dip switch info

Bit	Switch	Option when bit=1
0	4	Low battery alarm changed from 2 to 5 mins. Autostartup disabled on SU370ci and 400

1	3	Audible alarm delayed 30 seconds
2	2	Output transfer set to 115 VAC (from 120 VAC) or to 240 VAC (from 230 VAC)
3	1	UPS desensitized - input voltage range expanded
4-7	-	Unused at this time

Status bits

This is probably the most important register of the UPS, which indicates the overall UPS status. Some common things you'll see:

- 08 = On line, battery OK
- 10 = On battery, battery OK
- 50 = On battery, battery low
- SM = Status bit is still not available (retry reading)

Bit	Hex Bit	Meaning
0	0x01	1 = Runtime calibration occurring Not reported by SmartUPS v/s and BackUPS Pro
1	0x02	1 = SmartTrim Not reported by 1st and 2nd generation SmartUPS models
2	0x04	1 = SmartBoost
3	0x08	1 = On line (this is the normal condition)
4	0x10	1 = On battery
5	0x20	1 = Overloaded output
6	0x40	1 = Battery low
7	0x80	1 = Replace battery

Alert messages

These single character messages are sent by the UPS any time there is an Alert condition. All other responses indicated above are sent by the UPS only in response to a query or action command.

Character	Description
-----------	-------------

!	Line Fail - sent when the UPS goes on-battery, repeated every 30 seconds until low battery condition reached. Sometimes occurs more than once in the first 30 seconds.
\$	Return from line fail - UPS back on line power, only sent if a ! has been sent.
%	Low battery - Sent to indicate low battery, but not on SmartUPS v/s or BackUPS Pro models
+	Return from low battery - Sent when the battery has been recharged to some level only if a % has been sent previously
?	Abnormal condition - sent for conditions such as “shutdown due to overload” or “shutdown due to low battery capacity”. Also occurs within 10 minutes of turnon.
=	Return from abnormal condition - Sent when the UPS returns from an abnormal condition where ? was sent, but not a turn-on. Not implemented on SmartUPS v/s or BackUPS Pro models.
*	About to turn off - Sent when the UPS is about to switch off the load. No commands are processed after this character is sent. Not implemented on SmartUPS v/s, BackUPS Pro, or 3rd generation SmartUPS models.
#	Replace battery - Sent when the UPS detects that the battery needs to be replaced. Sent every 5 hours until a new battery test is run or the UPS is shut off. Not implemented on SmartUPS v/s or BackUPS Pro models.
&	Check alarm register for fault (Measure-UPS) - sent to signal that temp or humidity out of set limits. Also sent when one of the contact closures changes states. Sent every 2 minutes, stops when the alarm conditions are reset. Only sent for alarms enabled with I. Cause of alarm may be determined with J. Not on SmartUPS v/s or BackUPS Pro.
—	Variable change in EEPROM - Sent whenever any EEPROM variable is changed. Only supported on Matrix UPS and 3rd generation SmartUPS models.

Register 1

All bits are valid on the Matrix UPS. SmartUPS models only support bits 6 and 7. Other models do not respond.

Bit	Hex	Meaning
0	0x01	In wakeup mode (typically lasts < 2s)

1	0x02	In bypass mode due to internal fault - see register 2 or 3
2	0x04	Going to bypass mode due to command
3	0x08	In bypass mode due to command
4	0x10	Returning from bypass mode
5	0x20	In bypass mode due to manual bypass control
6	0x40	Ready to power load on user command
7	0x80	Ready to power load on user command or return of line power

Register 2

Matrix UPS models report bits 0-5. SmartUPS models only support bits 4 and 6. SmartUPS v/s and BackUPS Pro report bits 4, 6, 7. Unused bits are set to 0. Other models do not respond.

Bit	Meaning
0	Fan failure in electronics, UPS in bypass
1	Fan failure in isolation unit
2	Bypass supply failure
3	Output voltage select failure, UPS in bypass
4	DC imbalance, UPS in bypass
5	Command sent to stop bypass with no battery connected - UPS still in bypass
6	Relay fault in SmartTrim or SmartBoost
7	Bad output voltage

Register 3

All bits are valid on the Matrix UPS and 3rd generation SmartUPS models. SmartUPS v/s and BackUPS Pro models report bits 0-5. All others report 0-4. State change of bits 1,2,5,6,7 are reported asynchronously with ? and = messages.

Bit	Meaning
0	Output unpowered due to shutdown by low battery
1	Unable to transfer to battery due to overload
2	Main relay malfunction - UPS turned off
3	In sleep mode from @ (maybe others)
4	In shutdown mode from S

- 5 Battery charger failure
- 6 Bypass relay malfunction
- 7 Normal operating temperature exceeded

Interpretation of the Old Firmware Revision

The Old Firmware Revision is obtained with the “V” command, which gives a typical response such as “GWD” or “IWI”, and can be interpreted as follows:

Old Firmware revision and model ID String for SmartUPS \& MatrixUPS

This is a three character string XYZ

where X == Smart-UPS or Matrix-UPS ID Code.

range 0-9 and A-P

1 == unknown

0 == Matrix 3000

5 == Matrix 5000

the rest are Smart-UPS and Smart-UPS-XL

2 == 250 3 == 400 4 == 400

6 == 600 7 == 900 8 == 1250

9 == 2000 A == 1400 B == 1000

C == 650 D == 420 E == 280

F == 450 G == 700 H == 700XL

I == 1000 J == 1000XL K == 1400

L == 1400XL M == 2200 N == 2200XL

O == 3000 P == 5000

where Y == Possible Level of Smart Features, unknown???

G == Stand Alone

T == Stand Alone

V == ???

W == Rack Mount

where Z == National Model Use Only Codes

D == Domestic 115 Volts

I == International 230 Volts

A == Asia ?? 100 Volts

J == Japan ?? 100 Volts

Interpretation of the New Firmware Revision

New Firmware revision and model ID String in NN.M.L is the format

```

where NN == UPS ID Code.
  12 == Back-UPS Pro 650
  13 == Back-UPS Pro 1000
  52 == Smart-UPS 700
  60 == SmartUPS 1000
  72 == Smart-UPS 1400

where NN now Nn has possible meanings.
  N == Class of UPS
  1n == Back-UPS Pro
  5n == Smart-UPS
  7n == Smart-UPS NET

  n == Level of intelligence
  N1 == Simple Signal, if detectable WAG(*)
  N2 == Full Set of Smart Signals
  N3 == Micro Subset of Smart Signals

where M == Possible Level of Smart Features, unknown???
  1 == Stand Alone
  8 == Rack Mount
  9 == Rack Mount

where L == National Model Use Only Codes
  D == Domestic      115 Volts
  I == International 230 Volts
  A == Asia ??       100 Volts
  J == Japan ??      100 Volts
  M == North America 208 Volts (Servers)

```

EEPROM Values

Upon sending a ^Z, your UPS will probably spit back approximately 254 characters something like the following (truncated here for the example):

```
#uD43132135138129uM43229234239224uA43110112114108 ....
```

It looks bizarre and ugly, but is easily parsed. The # is some kind of marker/ident character. Skip it. The rest fits this form:

- Command character - use this to select the value
- Locale - use 'b' to find out what yours is (the last character), '4' applies to all
- Number of choices - '4' means there are 4 possibilities coming up
- Choice length - '3' means they are all 3 chars long

Matrix-UPS models have ## between each grouping for some reason.

Here is an example broken out to be more readable:

```
CMD DFO RSP FSZ FVL
u  D  4  3  127 130 133 136
u  M  4  3  229 234 239 224
u  A  4  3  108 110 112 114
u  I  4  3  253 257 261 265
l  D  4  3  106 103 100 097
l  M  4  3  177 172 168 182
l  A  4  3  092 090 088 086
l  I  4  3  208 204 200 196
e  4  4  2  00  15  50  90
o  D  1  3  115
o  J  1  3  100
o  I  1  3  230 240 220 225
o  M  1  3  208
s  4  4  1   H   M   L   L
q  4  4  2   02  05  07  10
p  4  4  3  020 180 300 600
k  4  4  1   0   T   L   N
r  4  4  3  000 060 180 300
E  4  4  3  336 168 0N 0FF
```

CMD == UPSlink Command.

u = upper transfer voltage
l = lower transfer voltage
e = return threshold
o = output voltage
s = sensitivity
p = shutdown grace delay
q = low battery warning
k = alarm delay
r = wakeup delay
E = self test interval

DFO == (4)-all-countries (D)omestic (I)nternational (A)sia (J)apan
(M) North America - servers.

RSP == Total number possible answers returned by a given CMD.

FSZ == Max. number of field positions to be filled.

FVL == Values that are returned and legal.

Programming the UPS EEPROM

There are at this time a maximum of 12 different values that can be programmed into the UPS EEPROM. They are:

Item	Command	Meaning
------	---------	---------

1.	c	The UPS Id or name
2.	x	The last date the batteries were replaced
3.	u	The Upper Transfer Voltage
4.	l	The Lower Transfer Voltage
5.	e	The Return Battery Charge Percentage
6.	o	The Output Voltage when on Batteries
7.	s	The Sensitivity to Line Quality
8.	p	The Shutdown Grace Delay
9.	q	The Low Battery Warning Delay
10.	k	The Alarm Delay
11.	r	The Wakeup Delay
12.	E	The Automatic Self Test Interval

The first two cases (Ident and Batt date) are somewhat special in that you tell the UPS you want to change the value, then you supply 8 characters that are saved in the EEPROM. The last ten items are programmed by telling the UPS that you want it to cycle to the next permitted value.

In each case, you indicate to the UPS that you want to change the EEPROM by first sending the appropriate query command (e.g. “c” for the UPS ID or “u” for the Upper Transfer voltage. This command is then immediately followed by the cycle EEPROM command or “-”. In the case of the UPS ID or the battery date, you follow the cycle command by the eight characters that you want to put in the EEPROM. In the case of the other ten items, there is nothing more to enter.

The UPS will respond by “OK” and approximately 5 seconds later by a vertical bar (—) to indicate that the EEPROM was changed.

Acknowledgements

The apcupsd has a rather long and tormented history. Many thanks to the guys that, with time, contributed to the general public knowledge.

Pavel Korensky <pavelk at dator3.anet.cz>, Andre M. Hedrick <hedrick at suse.de>, Christopher J. Reimer <reimer at doe.carleton.ca>, Kevin D. Smolkowski <kevins at trigger.oslc.org>, Werner Panocha <wpanocha at t-online.de>, Steven Freed, Russell Kroll.

additions by: Kern Sibbald <apcupsd-users at lists.sourceforge.net>

Apcupsd — RPM Packaging FAQ

Answers

How do I build Apcupsd for platform xxx? The `apcupsd` spec file contains defines to build for several platforms: RedHat 7.x (`rh7`), RedHat 8.0 (`rh8`), RedHat 9 (`rh9`), Fedora Core (`fedora_core`), RedHat Enterprise Linux and clones (`rhel3` and `rhel4`), SuSE 9 & 10 (`suse`), and Mandrake (`mdk`). The package build is controlled by a define set at the beginning of the file. These defines basically just control the dependancy information that gets coded into the finished rpm package. So while you could technically build a package without defining a platform, or with an incorrect platform, and have it install and run it would not contain correct dependancy information for the rpm database. The platform define may be edited in the spec file directly (by default all defines are set to 0 or “not set”). For example, to build the RedHat 7.x package find the line in the spec file which reads

```
%define rh7 0
```

and edit it to read

```
%define rh7 1
```

Alternately you may pass the define on the command line when calling `rpmbuild`:

```
rpmbuild -ba --define "build_rh7 1" apcupsd.spec  
rpmbuild --rebuild --define build_rh7 1" apcupsd-x.x.x-x.src.rpm
```

How do I control whether usb support gets built? Up through version 3.12, by default standard serial port support was built and the `apcupsd-std` package was produced. The usb package pre-configured the configuration files for usb devices and installed a couple additional tools in `/etc/apcupsd` but the usb driver was built regardless. To get the usb package and support in those versions either set the

```
%define usb 0
```

to

```
%define usb 1
```

in the spec file directly or pass it to rpmbuild on the command line:

```
rpmbuild -ba --define "build_rh7 1" --define "build_usb 1" apcupsd.spec
```

With the release of 3.14 USB support is now considered standard and the apcupsd-std and apcupsd-usb packages are obsoleted in favor of a single apcupsd package configured for usb connected UPS's. The serial port driver is still built and can be configured accordingly after installation. If you are performing an upgrade it will of course not replace your current config file.

The build directive:

```
--define "build_usb 1"
```

is no longer recognized.

What other defines are used? There is a define for the initdir for the daemon control script. On RedHat or Mandrake systems this is set to /etc/rc.d/init.d/. On SuSE systems this is set to /etc/rc.d. You would only need to edit this if packaging for a platform that uses a different directory.

A second define controls whether the Gnome monitoring application, new in the 3.14 release, is built. This application requires the Gtk2 version to be ≥ 2.4 . If you want to build the apcupsd-gapcmon package add:

```
--define "build_gapcmon 1"
```

A third define controls whether the SNMP driver is built. If you want to build the net-snmp driver add:

```
--define "build_snmp 1"
```

Can I supply packages for other platforms you do not publish?

Yes, there are tools provided for contributors to supply rpm packages for platforms for which support is provided in the spec file but for which the development team chooses not to release binary packages, usually due to lack of interest or lack of an available platform. Please see platforms/contrib/README in the source package.

I'm getting errors about not having permission when I try to build the packages. Do I need to be root? No, you do not need to be root and, in fact, it is better practice to build rpm packages as a non-root user. Apcupds packages are designed to be built by a regular user but you must make a few changes on your system to do this. If you are building on your own system then the simplest method is to add write permissions for all to the build directory (/usr/src/redhat/). To accomplish this execute one of the following commands as root depending on your distribution, RedHat, SuSE or Mandriva, respectively:

```
chmod -R 777 /usr/src/redhat
chmod -R 777 /usr/src/packages
chmod -R 777 /usr/src/RPM
```

If you are working on a shared system where you can not use the method above then you need to recreate the /usr/src/redhat (or other) directory tree with all of it's subdirectories inside your home directory. Then create a file named

```
.rpmmacros
```

in your home directory (or edit the file if it already exists) and add the following line:

```
%_topdir /home/myuser/redhat
```

Credits



The success of apcupsd is due to the many people that helped in development, testing and in many other ways.

Thank all the developers that worked hard to make APCUPSDone of the best piece of software for UPSmanagement.

Contributors

Current Code Maintainer and Project Manager: Kern Sibbald
(kern at sibbald dot com)

RPM Packager: D. Scott Barninger (barninger at fairfieldcomputers dot com)

Super USB bug fixer: Adam Kropelin (akropell1 at rochester dot rr dot com)

CGI and HTML fixer: William King (wrking at dadaboom dot com)

Project Starter and Former Code Maintainer: Andre Hedrick (andre at linux-ide.org)

Former Code Maintainer and Project Manager: Riccardo Facchetti
(riccardo at master.oasi.gpa.it)

Serial Communications: Andre Hedrick (andre at linux-ide.org)

2.0 User's Manual: Eric S. Raymond (esr at thyrsus.com)

Alpha Port: Kern Sibbald (kern at sibbald dot com)
J. Rochate (jrochate at ualg.pt) testing and machine loan

Caldera: John Pinner (john at clocksoft.com)

HP-UX Port Carl Erhorn (Carl_Erhorn at hyperion.com)
Robert K Nelson (rnelson at airflowsciences.com)

SOLARIS Port: Carl Erhorn (Carl_Erhorn at hyperion.com)

OpenBSD Port: Devin Reade (gdr at gno.org)

NetBSD Port: Neil Darlow (neil at darlow.co.uk)

Win32 Port: Kern Sibbald (kern at sibbald dot com)
Paul Z. Stagner (paul.stagner at charterco.com) testing

WEB Interfaces: Kern Sibbald (kern at sibbald dot com)
Joseph Acosta (joeja at mindspring.com)

Apcupsd Support and Knowledge Base: Brian Schau (Brian.Schau at compaq.com)

Hard Core Coders: Riccardo Facchetti (riccardo at master.oasi.gpa.it)
Kern Sibbald (kern at sibbald dot com)

Part Time Coders: Jonathan H N Chin (jc254 at newton.cam.ac.uk)

Andre Hedrick (andre at linux-ide.org)

Brian Schau (Brian.Schau at compaq.com)

Carl Erhorn (Carl.Erhorn at hyperion.com)

Distribution Maintainers: Alpha: Kern Sibbald (kern at sibbald dot com) temp

Debian: Leon Breedt (ljb at debian.org)

FreeBSD/BSDi: Jeff Palmer (scorpio at drkshdw.org)

NetBSD: Neil Darlow (neil at darlow.co.uk)

HP-UX: Carl Erhorn (Carl.Erhorn at hyperion.com), Robert K Nelson (rnelson at airflowsciences.com)

OpenBSD: Devin Reade (gdr at gno.org)

RedHat: Kern Sibbald (kern at sibbald dot com)

Slackware: Devin Reade (gdr at gno.org)

Sparc Solaris: Carl Erhorn (Carl.Erhorn at hyperion.com)

SUSE: Riccardo Facchetti (riccardo at master.oasi.gpa.it)

Win32: Kern Sibbald (kern at sibbald dot com)

Project Discussions: APCUPSD Mailing List

Thanks to American Power Conversion (APC) who helped in giving technical information on their UPSes.

A special thanks to APC who gave me (Riccardo) a Smart UPS1400 INET when my old Back UPS v/s 650's battery died. Thank you guys, your help has been invaluable.

Thanks to all the users that send bug reports and suggestions:we need your help.

Thanks to every one I forgot here. If you feel I have forgot your name, please don't hesitate to tell me.

Miquel van Smoorenburg, The Doctor What, Pavel Korensky, and Russell Kroll <rkroll at exploits.org> for the CGI programs. Jonathan Benson <jbenson at technologist.com> for adapting the upsstatus.cgi program to work with apcupsd

The gd 1.2 Image Library used in our CGI programs is copyright 1994, 1995, Quest Protein Database Center, Cold Spring Harbor Labs. Permission

granted to copy and distribute this work provided that this notice remains intact. Credit for the library must be given to the Quest Protein Database Center, Cold Spring Harbor Labs, in all derived works. This does not affect your ownership of the derived work itself, and the intent is to assure proper credit for Quest, not to interfere with your use of gd.

gd 1.2 was written by Thomas Boutell and is currently distributed by boutell.com, Inc.

Parts of the VNC project by ATT (cool code) were used as templates for our Win32 code, see: <http://www.uk.research.att.com/vnc>

Disclaimer: NO WARRANTY

BECAUSE THE PROGRAM IS LICENSED FREE OF CHARGE, THERE IS NO WARRANTY FOR THE PROGRAM, TO THE EXTENT PERMITTED BY APPLICABLE LAW. EXCEPT WHEN OTHERWISE STATED IN WRITING THE COPYRIGHT HOLDERS AND/OR OTHER PARTIES PROVIDE THE PROGRAM "AS IS" WITHOUT WARRANTY OF ANY KIND, EITHER EXPRESSED OR IMPLIED, INCLUDING, BUT NOT LIMITED TO, THE IMPLIED WARRANTIES OF MERCHANTABILITY AND FITNESS FOR A PARTICULAR PURPOSE. THE ENTIRE RISK AS TO THE QUALITY AND PERFORMANCE OF THE PROGRAM IS WITH YOU. SHOULD THE PROGRAM PROVE DEFECTIVE, YOU ASSUME THE COST OF ALL NECESSARY SERVICING, REPAIR OR CORRECTION.

IN NO EVENT UNLESS REQUIRED BY APPLICABLE LAW OR AGREED TO IN WRITING WILL ANY COPYRIGHT HOLDER, OR ANY OTHER PARTY WHO MAY MODIFY AND/OR REDISTRIBUTE THE PROGRAM AS PERMITTED ABOVE, BE LIABLE TO YOU FOR DAMAGES, INCLUDING ANY GENERAL, SPECIAL, INCIDENTAL OR CONSEQUENTIAL DAMAGES ARISING OUT OF THE USE OR INABILITY TO USE THE PROGRAM (INCLUDING BUT NOT LIMITED TO LOSS OF DATA OR DATA BEING RENDERED INACCURATE OR LOSSES SUSTAINED BY YOU OR THIRD PARTIES OR A FAILURE OF THE PROGRAM TO OPERATE WITH ANY OTHER PROGRAMS), EVEN IF SUCH HOLDER OR OTHER PARTY HAS BEEN ADVISED OF THE POSSIBILITY OF SUCH DAMAGES.

Linux-Kernel-Info

Linux Kernel Config

A typical USB section of a .config file might be:

```
#
# USB support
#
CONFIG_USB=m
CONFIG_USB_DEBUG=y

#
# Miscellaneous USB options
#
CONFIG_USB_DEVICEFS=y
# CONFIG_USB_BANDWIDTH is not set
# CONFIG_USB_DYNAMIC_MINORS is not set

#
# USB Host Controller Drivers
#
# CONFIG_USB_EHCI_HCD is not set
# CONFIG_USB_OHCI_HCD is not set
CONFIG_USB_UHCI_HCD=m

#
# USB Device Class drivers
#
# CONFIG_USB_BLUETOOTH_TTY is not set
# CONFIG_USB_ACM is not set
# CONFIG_USB_PRINTER is not set
CONFIG_USB_STORAGE=m
# CONFIG_USB_STORAGE_DEBUG is not set
# CONFIG_USB_STORAGE_DATAFAB is not set
# CONFIG_USB_STORAGE_FREECOM is not set
# CONFIG_USB_STORAGE_ISD200 is not set
# CONFIG_USB_STORAGE_DPCM is not set
# CONFIG_USB_STORAGE_HP8200e is not set
# CONFIG_USB_STORAGE_SDDR09 is not set
# CONFIG_USB_STORAGE_SDDR55 is not set
# CONFIG_USB_STORAGE_JUMPSHOT is not set

#
# USB Human Interface Devices (HID)
#
CONFIG_USB_HID=m
CONFIG_USB_HIDINPUT=y
# CONFIG_HID_FF is not set
CONFIG_USB_HIDDEV=y
```

```
#
# USB HID Boot Protocol drivers
#
# CONFIG_USB_KBD is not set
# CONFIG_USB_MOUSE is not set
# CONFIG_USB_AIPTEK is not set
# CONFIG_USB_WACOM is not set
# CONFIG_USB_KBTAB is not set
# CONFIG_USB_POWERMATE is not set
# CONFIG_USB_MTOUCH is not set
# CONFIG_USB_XPAD is not set
# CONFIG_USB_ATI_REMOTE is not set

#
# USB Imaging devices
#
# CONFIG_USB_MDC800 is not set
# CONFIG_USB_MICROTEK is not set
# CONFIG_USB_HPUSBSCSI is not set

#
# USB Multimedia devices
#
# CONFIG_USB_DABUSB is not set

#
# Video4Linux support is needed for USB Multimedia device support
#

#
# USB Network adaptors
#
# CONFIG_USB_CATC is not set
# CONFIG_USB_KAWETH is not set
# CONFIG_USB_PEGASUS is not set
# CONFIG_USB_RTL8150 is not set
# CONFIG_USB_USBNET is not set

#
# USB port drivers
#
# CONFIG_USB_USS720 is not set

#
# USB Serial Converter support
#
# CONFIG_USB_SERIAL is not set

#
# USB Miscellaneous drivers
#
# CONFIG_USB_EMI62 is not set
# CONFIG_USB_EMI26 is not set
# CONFIG_USB_TIGL is not set
```

```
# CONFIG_USB_AUERSWALD is not set
# CONFIG_USB_RIO500 is not set
# CONFIG_USB_LEGOTOWER is not set
# CONFIG_USB_LCD is not set
# CONFIG_USB_LED is not set
# CONFIG_USB_CYTHERM is not set
# CONFIG_USB_TEST is not set

#
# USB Gadget Support
#
# CONFIG_USB_GADGET is not set
```

Interpreting /proc/bus/usb (linux-2.4)

Interpretation of /proc/bus/usb info on 2.4 kernels:

```
/proc/bus/usb filesystem output
=====
(version 2002.03.18)
```

The /proc filesystem for USB devices provides /proc/bus/usb/drivers and /proc/bus/usb/devices, as well as /proc/bus/usb/BBB/DDD files.

****NOTE**:** If /proc/bus/usb appears empty, and a host controller driver has been linked, then you need to mount the filesystem. Issue the command (as root):

```
mount -t usbfs none /proc/bus/usb
```

An alternative and more permanent method would be to add

```
none /proc/bus/usb usbfs defaults 0 0
```

to /etc/fstab. This will mount usbfs at each reboot. You can then issue 'cat /proc/bus/usb/devices' to extract USB device information, and user mode drivers can use usbfs to interact with USB devices.

There are a number of mount options supported by usbfs. Consult the source code (linux/drivers/usb/inode.c) for information about those options.

****NOTE**:** The filesystem has been renamed from "usbdevfs" to "usbfs", to reduce confusion with "devfs". You may still see references to the older "usbdevfs" name.

For more information on mounting the usbfs file system, see the

"USB Device Filesystem" section of the USB Guide. The latest copy of the USB Guide can be found at <http://www.linux-usb.org/>

THE /proc/bus/usb/BBB/DDD FILES:

Each connected USB device has one file. The BBB indicates the bus number. The DDD indicates the device address on that bus. Both of these numbers are assigned sequentially, and can be reused, so you can't rely on them for stable access to devices. For example, it's relatively common for devices to re-enumerate while they are still connected (perhaps someone jostled their power supply, hub, or USB cable), so a device might be 002/027 when you first connect it and 002/048 sometime later.

These files can be read as binary data. The binary data consists of first the device descriptor, then the descriptors for each configuration of the device. That information is also shown in text form by the /proc/bus/usb/devices file, described later.

These files may also be used to write user-level drivers for the USB devices. You would open the /proc/bus/usb/BBB/DDD file read/write, read its descriptors to make sure it's the device you expect, and then bind to an interface (or perhaps several) using an ioctl call. You would issue more ioctls to the device to communicate to it using control, bulk, or other kinds of USB transfers. The IOCTLS are listed in the linux/usbdevice_fs.h file, and at this writing the source code (linux/drivers/usb/devio.c) is the primary reference for how to access devices through those files.

Note that since by default these BBB/DDD files are writable only by root, only root can write such user mode drivers. You can selectively grant read/write permissions to other users by using "chmod". Also, usbfs mount options such as "devmode=0666" may be helpful.

THE /proc/bus/usb/drivers FILE:

Each of the USB device drivers linked into your kernel (statically, or dynamically using "modprobe") is listed in the "drivers" file. Here's an example from one system:

```
usbdevfs
hub
0- 15: usblp
usbnet
serial
usb-storage
pegasus
```

If you see this file, "usbdevfs" and "hub" will always be listed, since those are part of the "usbcore" framework.

Drivers that use the USB major number (180) to provide character devices will include a range of minor numbers, as shown above for the "usb1p" (actually "printer.o") module. USB device drivers can of course use any major number, but it's easy to use the USB range since there's explicit support for subdividing it in the USB device driver framework.

THE /proc/bus/usb/devices FILE:

 In /proc/bus/usb/devices, each device's output has multiple lines of ASCII output.
 I made it ASCII instead of binary on purpose, so that someone can obtain some useful data from it without the use of an auxiliary program. However, with an auxiliary program, the numbers in the first 4 columns of each "T:" line (topology info: Lev, Prnt, Port, Cnt) can be used to build a USB topology diagram.

Each line is tagged with a one-character ID for that line:

- T = Topology (etc.)
- B = Bandwidth (applies only to USB host controllers, which are virtualized as root hubs)
- D = Device descriptor info.
- P = Product ID info. (from Device descriptor, but they won't fit together on one line)
- S = String descriptors.
- C = Configuration descriptor info. (* = active configuration)
- I = Interface descriptor info.
- E = Endpoint descriptor info.

=====

/proc/bus/usb/devices output format:

Legend:

- d = decimal number (may have leading spaces or 0's)
- x = hexadecimal number (may have leading spaces or 0's)
- s = string

Topology info:

```
T: Bus=dd Lev=dd Prnt=dd Port=dd Cnt=dd Dev#=ddd Spd=ddd MxCh=dd
| | | | | | | | |__MaxChildren
| | | | | | | | |__Device Speed in Mbps
| | | | | | | | |__DeviceNumber
| | | | | | | | |__Count of devices at this level
| | | | | | | | |__Connector/Port on Parent for this device
| | | | | | | | |__Parent DeviceNumber
| | | | | | | | |__Level in topology for this bus
| | | | | | | | |__Bus number
| | | | | | | | |__Topology info tag
```

Speed may be:

The Configuration lines could be used to list maximum power (in milliamps) that a system's USB devices are using. For example, "grep ^C: /proc/bus/usb/devices".

Here's an example, from a system which has a UHCI root hub, an external hub connected to the root hub, and a mouse and a serial converter connected to the external hub.

```
T: Bus=00 Lev=00 Prnt=00 Port=00 Cnt=00 Dev#= 1 Spd=12 MxCh= 2
B: Alloc= 28/900 us ( 3%), #Int= 2, #Iso= 0
D: Ver= 1.00 Cls=09(hub ) Sub=00 Prot=00 MxPS= 8 #Cfgs= 1
P: Vendor=0000 ProdID=0000 Rev= 0.00
S: Product=USB UHCI Root Hub
S: SerialNumber=dce0
C:* #Ifs= 1 Cfg#= 1 Atr=40 MxPwr= 0mA
I: If#= 0 Alt= 0 #EPs= 1 Cls=09(hub ) Sub=00 Prot=00 Driver=hub
E: Ad=81(I) Atr=03(Int.) MxPS= 8 Iv1=255ms
T: Bus=00 Lev=01 Prnt=01 Port=00 Cnt=01 Dev#= 2 Spd=12 MxCh= 4
D: Ver= 1.00 Cls=09(hub ) Sub=00 Prot=00 MxPS= 8 #Cfgs= 1
P: Vendor=0451 ProdID=1446 Rev= 1.00
C:* #Ifs= 1 Cfg#= 1 Atr=e0 MxPwr=100mA
I: If#= 0 Alt= 0 #EPs= 1 Cls=09(hub ) Sub=00 Prot=00 Driver=hub
E: Ad=81(I) Atr=03(Int.) MxPS= 1 Iv1=255ms
T: Bus=00 Lev=02 Prnt=02 Port=00 Cnt=01 Dev#= 3 Spd=1.5 MxCh= 0
D: Ver= 1.00 Cls=00(>ifc ) Sub=00 Prot=00 MxPS= 8 #Cfgs= 1
P: Vendor=04b4 ProdID=0001 Rev= 0.00
C:* #Ifs= 1 Cfg#= 1 Atr=80 MxPwr=100mA
I: If#= 0 Alt= 0 #EPs= 1 Cls=03(HID ) Sub=01 Prot=02 Driver=mouse
E: Ad=81(I) Atr=03(Int.) MxPS= 3 Iv1= 10ms
T: Bus=00 Lev=02 Prnt=02 Port=02 Cnt=02 Dev#= 4 Spd=12 MxCh= 0
D: Ver= 1.00 Cls=00(>ifc ) Sub=00 Prot=00 MxPS= 8 #Cfgs= 1
P: Vendor=0565 ProdID=0001 Rev= 1.08
S: Manufacturer=Peracom Networks, Inc.
S: Product=Peracom USB to Serial Converter
C:* #Ifs= 1 Cfg#= 1 Atr=a0 MxPwr=100mA
I: If#= 0 Alt= 0 #EPs= 3 Cls=00(>ifc ) Sub=00 Prot=00 Driver=serial
E: Ad=81(I) Atr=02(Bulk) MxPS= 64 Iv1= 16ms
E: Ad=01(O) Atr=02(Bulk) MxPS= 16 Iv1= 16ms
E: Ad=82(I) Atr=03(Int.) MxPS= 8 Iv1= 8ms
```

Selecting only the "T:" and "I:" lines from this (for example, by using "procusb ti"), we have:

```
T: Bus=00 Lev=00 Prnt=00 Port=00 Cnt=00 Dev#= 1 Spd=12 MxCh= 2
T: Bus=00 Lev=01 Prnt=01 Port=00 Cnt=01 Dev#= 2 Spd=12 MxCh= 4
I: If#= 0 Alt= 0 #EPs= 1 Cls=09(hub ) Sub=00 Prot=00 Driver=hub
T: Bus=00 Lev=02 Prnt=02 Port=00 Cnt=01 Dev#= 3 Spd=1.5 MxCh= 0
I: If#= 0 Alt= 0 #EPs= 1 Cls=03(HID ) Sub=01 Prot=02 Driver=mouse
T: Bus=00 Lev=02 Prnt=02 Port=02 Cnt=02 Dev#= 4 Spd=12 MxCh= 0
I: If#= 0 Alt= 0 #EPs= 3 Cls=00(>ifc ) Sub=00 Prot=00 Driver=serial
```

Physically this looks like (or could be converted to):

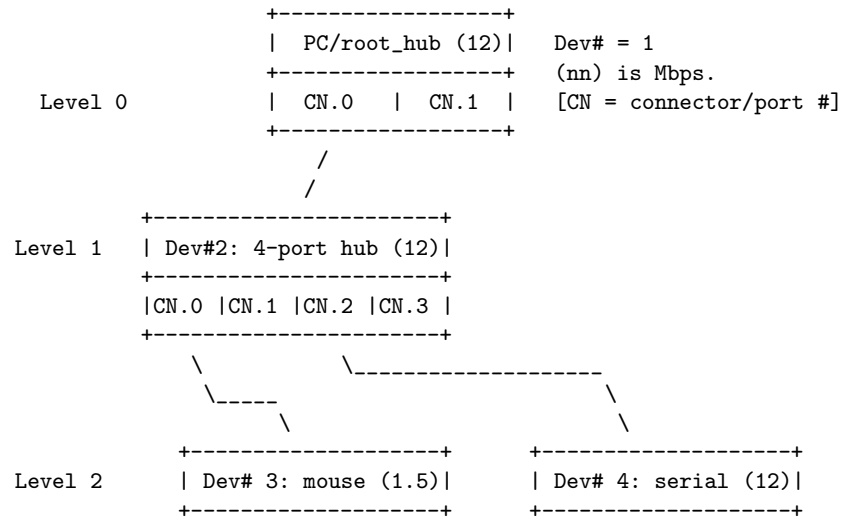

Or, in a more tree-like structure (ports [Connectors] without connections could be omitted):

```

PC: Dev# 1, root hub, 2 ports, 12 Mbps
|_ CN.0: Dev# 2, hub, 4 ports, 12 Mbps
    |_ CN.0: Dev #3, mouse, 1.5 Mbps
    |_ CN.1:
    |_ CN.2: Dev #4, serial, 12 Mbps
    |_ CN.3:
|_ CN.1:
  
```

END

Interpreting /proc/bus/usb (linux-2.6)

Interpretation of /proc/bus/usb info on 2.6 kernels:

```

/proc/bus/usb filesystem output
=====
(version 2003.05.30)
  
```

The usbfs filesystem for USB devices is traditionally mounted at /proc/bus/usb. It provides the /proc/bus/usb/devices file, as well as the /proc/bus/usb/BBB/DDD files.

****NOTE**:** If `/proc/bus/usb` appears empty, and a host controller driver has been linked, then you need to mount the filesystem. Issue the command (as root):

```
mount -t usbfs none /proc/bus/usb
```

An alternative and more permanent method would be to add

```
none /proc/bus/usb usbfs defaults 0 0
```

to `/etc/fstab`. This will mount `usbfs` at each reboot. You can then issue `'cat /proc/bus/usb/devices'` to extract USB device information, and user mode drivers can use `usbfs` to interact with USB devices.

There are a number of mount options supported by `usbfs`. Consult the source code (`linux/drivers/usb/core/inode.c`) for information about those options.

****NOTE**:** The filesystem has been renamed from "usbdevfs" to "usbfs", to reduce confusion with "devfs". You may still see references to the older "usbdevfs" name.

For more information on mounting the `usbfs` file system, see the "USB Device Filesystem" section of the USB Guide. The latest copy of the USB Guide can be found at <http://www.linux-usb.org/>

THE `/proc/bus/usb/BBB/DDD` FILES:

Each connected USB device has one file. The BBB indicates the bus number. The DDD indicates the device address on that bus. Both of these numbers are assigned sequentially, and can be reused, so you can't rely on them for stable access to devices. For example, it's relatively common for devices to re-enumerate while they are still connected (perhaps someone jostled their power supply, hub, or USB cable), so a device might be 002/027 when you first connect it and 002/048 sometime later.

These files can be read as binary data. The binary data consists of first the device descriptor, then the descriptors for each configuration of the device. That information is also shown in text form by the `/proc/bus/usb/devices` file, described later.

These files may also be used to write user-level drivers for the USB devices. You would open the `/proc/bus/usb/BBB/DDD` file read/write, read its descriptors to make sure it's the device you expect, and then bind to an interface (or perhaps several) using an `ioctl` call. You would issue more `ioctls` to the device to communicate to it using control, bulk, or other kinds of USB transfers. The `IOCTLs` are listed in the `linux/usbdevice_fs.h` file, and at this writing the source code (`linux/drivers/usb/devio.c`) is the primary reference

for how to access devices through those files.

Note that since by default these BBB/DDD files are writable only by root, only root can write such user mode drivers. You can selectively grant read/write permissions to other users by using "chmod". Also, usbfs mount options such as "devmode=0666" may be helpful.

THE /proc/bus/usb/devices FILE:

In /proc/bus/usb/devices, each device's output has multiple lines of ASCII output.

I made it ASCII instead of binary on purpose, so that someone can obtain some useful data from it without the use of an auxiliary program. However, with an auxiliary program, the numbers in the first 4 columns of each "T:" line (topology info: Lev, Prnt, Port, Cnt) can be used to build a USB topology diagram.

Each line is tagged with a one-character ID for that line:

T = Topology (etc.)
B = Bandwidth (applies only to USB host controllers, which are virtualized as root hubs)
D = Device descriptor info.
P = Product ID info. (from Device descriptor, but they won't fit together on one line)
S = String descriptors.
C = Configuration descriptor info. (* = active configuration)
I = Interface descriptor info.
E = Endpoint descriptor info.

=====

/proc/bus/usb/devices output format:

Legend:

d = decimal number (may have leading spaces or 0's)
x = hexadecimal number (may have leading spaces or 0's)
s = string

Topology info:

```
T: Bus=dd Lev=dd Prnt=dd Port=dd Cnt=dd Dev#=ddd Spd=ddd MxCh=dd
| | | | | | | | |__MaxChildren
| | | | | | | | |__Device Speed in Mbps
| | | | | | | | |__DeviceNumber
| | | | | | | | |__Count of devices at this level
| | | | | | | | |__Connector/Port on Parent for this device
| | | | | | | | |__Parent DeviceNumber
| | | | | | | | |__Level in topology for this bus
| | | | | | | | |__Bus number
|__Topology info tag
```



```

|         be omitted, or (for newer drivers) will identify the kernel
|         version and the driver which provides this hub emulation.
|__String info tag

S: Product=ssss
| |__Product description of this device as read from the device.
|         For older USB host controller drivers (virtual root hubs) this
|         indicates the driver; for newer ones, it's a product (and vendor)
|         description that often comes from the kernel's PCI ID database.
|__String info tag

```

```

S: SerialNumber=ssss
| |__Serial Number of this device as read from the device.
|         For USB host controller drivers (virtual root hubs) this is
|         some unique ID, normally a bus ID (address or slot name) that
|         can't be shared with any other device.
|__String info tag

```

Configuration descriptor info:

```

C:* #Ifs=dd Cfg#=dd Atr=xx MPwr=dddmA
| | |         |         |         |__MaxPower in mA
| | |         |         |__Attributes
| | |         |__ConfigurationNumber
| | |__NumberOfInterfaces
| |__ "*" indicates the active configuration (others are " ")
|__Config info tag

```

USB devices may have multiple configurations, each of which act rather differently. For example, a bus-powered configuration might be much less capable than one that is self-powered. Only one device configuration can be active at a time; most devices have only one configuration.

Each configuration consists of one or more interfaces. Each interface serves a distinct "function", which is typically bound to a different USB device driver. One common example is a USB speaker with an audio interface for playback, and a HID interface for use with software volume control.

Interface descriptor info (can be multiple per Config):

```

I: If#=dd Alt=dd #EPs=dd Cls=xx(sssss) Sub=xx Prot=xx Driver=ssss
| | |         |         |         |         |         |         |__Driver name
| | |         |         |         |         |         |         |         or "(none)"
| | |         |         |         |         |         |         |__InterfaceProtocol
| | |         |         |         |         |         |         |__InterfaceSubClass
| | |         |         |         |         |         |         |__InterfaceClass
| | |         |         |         |         |         |         |__NumberOfEndpoints
| | |         |         |         |         |         |         |__AlternateSettingNumber
| | |         |         |         |         |         |         |__InterfaceNumber

```

|__Interface info tag

A given interface may have one or more "alternate" settings. For example, default settings may not use more than a small amount of periodic bandwidth. To use significant fractions of bus bandwidth, drivers must select a non-default altsetting.

Only one setting for an interface may be active at a time, and only one driver may bind to an interface at a time. Most devices have only one alternate setting per interface.

Endpoint descriptor info (can be multiple per Interface):

```
E: Ad=xx(s) Atr=xx(ssss) MxPS=dddd Ivl=dddss
| |           |           |           |__Interval (max) between transfers
| |           |           |__EndpointMaxPacketSize
| |           |__Attributes(EndpointType)
| |__EndpointAddress(I=In,0=Out)
|__Endpoint info tag
```

The interval is nonzero for all periodic (interrupt or isochronous) endpoints. For high speed endpoints the transfer interval may be measured in microseconds rather than milliseconds.

For high speed periodic endpoints, the "MaxPacketSize" reflects the per-microframe data transfer size. For "high bandwidth" endpoints, that can reflect two or three packets (for up to 3KBytes every 125 usec) per endpoint.

With the Linux-USB stack, periodic bandwidth reservations use the transfer intervals and sizes provided by URBs, which can be less than those found in endpoint descriptor.

=====

If a user or script is interested only in Topology info, for example, use something like "grep ^T: /proc/bus/usb/devices" for only the Topology lines. A command like "grep -i ^[tdp]: /proc/bus/usb/devices" can be used to list only the lines that begin with the characters in square brackets, where the valid characters are TDPCIE. With a slightly more able script, it can display any selected lines (for example, only T, D, and P lines) and change their output format. (The "procusb" Perl script is the beginning of this idea. It will list only selected lines [selected from TBDPSCIE] or "All" lines from /proc/bus/usb/devices.)

The Topology lines can be used to generate a graphic/pictorial of the USB devices on a system's root hub. (See more below on how to do this.)

The Interface lines can be used to determine what driver is being used for each device.

The Configuration lines could be used to list maximum power (in milliamps) that a system's USB devices are using. For example, "grep ^C: /proc/bus/usb/devices".

Here's an example, from a system which has a UHCI root hub, an external hub connected to the root hub, and a mouse and a serial converter connected to the external hub.

```
T: Bus=00 Lev=00 Prnt=00 Port=00 Cnt=00 Dev#= 1 Spd=12 MxCh= 2
B: Alloc= 28/900 us ( 3%), #Int= 2, #Iso= 0
D: Ver= 1.00 Cls=09(hub ) Sub=00 Prot=00 MxPS= 8 #Cfgs= 1
P: Vendor=0000 ProdID=0000 Rev= 0.00
S: Product=USB UHCI Root Hub
S: SerialNumber=dce0
C:* #Ifs= 1 Cfg#= 1 Atr=40 MxPwr= 0mA
I: If#= 0 Alt= 0 #EPs= 1 Cls=09(hub ) Sub=00 Prot=00 Driver=hub
E: Ad=81(I) Atr=03(Int.) MxPS= 8 Iv1=255ms
T: Bus=00 Lev=01 Prnt=01 Port=00 Cnt=01 Dev#= 2 Spd=12 MxCh= 4
D: Ver= 1.00 Cls=09(hub ) Sub=00 Prot=00 MxPS= 8 #Cfgs= 1
P: Vendor=0451 ProdID=1446 Rev= 1.00
C:* #Ifs= 1 Cfg#= 1 Atr=e0 MxPwr=100mA
I: If#= 0 Alt= 0 #EPs= 1 Cls=09(hub ) Sub=00 Prot=00 Driver=hub
E: Ad=81(I) Atr=03(Int.) MxPS= 1 Iv1=255ms
T: Bus=00 Lev=02 Prnt=02 Port=00 Cnt=01 Dev#= 3 Spd=1.5 MxCh= 0
D: Ver= 1.00 Cls=00(>ifc ) Sub=00 Prot=00 MxPS= 8 #Cfgs= 1
P: Vendor=04b4 ProdID=0001 Rev= 0.00
C:* #Ifs= 1 Cfg#= 1 Atr=80 MxPwr=100mA
I: If#= 0 Alt= 0 #EPs= 1 Cls=03(HID ) Sub=01 Prot=02 Driver=mouse
E: Ad=81(I) Atr=03(Int.) MxPS= 3 Iv1= 10ms
T: Bus=00 Lev=02 Prnt=02 Port=02 Cnt=02 Dev#= 4 Spd=12 MxCh= 0
D: Ver= 1.00 Cls=00(>ifc ) Sub=00 Prot=00 MxPS= 8 #Cfgs= 1
P: Vendor=0565 ProdID=0001 Rev= 1.08
S: Manufacturer=Peracom Networks, Inc.
S: Product=Peracom USB to Serial Converter
C:* #Ifs= 1 Cfg#= 1 Atr=a0 MxPwr=100mA
I: If#= 0 Alt= 0 #EPs= 3 Cls=00(>ifc ) Sub=00 Prot=00 Driver=serial
E: Ad=81(I) Atr=02(Bulk) MxPS= 64 Iv1= 16ms
E: Ad=01(O) Atr=02(Bulk) MxPS= 16 Iv1= 16ms
E: Ad=82(I) Atr=03(Int.) MxPS= 8 Iv1= 8ms
```

Selecting only the "T:" and "I:" lines from this (for example, by using "procusb ti"), we have:

```
T: Bus=00 Lev=00 Prnt=00 Port=00 Cnt=00 Dev#= 1 Spd=12 MxCh= 2
T: Bus=00 Lev=01 Prnt=01 Port=00 Cnt=01 Dev#= 2 Spd=12 MxCh= 4
I: If#= 0 Alt= 0 #EPs= 1 Cls=09(hub ) Sub=00 Prot=00 Driver=hub
T: Bus=00 Lev=02 Prnt=02 Port=00 Cnt=01 Dev#= 3 Spd=1.5 MxCh= 0
I: If#= 0 Alt= 0 #EPs= 1 Cls=03(HID ) Sub=01 Prot=02 Driver=mouse
T: Bus=00 Lev=02 Prnt=02 Port=02 Cnt=02 Dev#= 4 Spd=12 MxCh= 0
```

I: If#= 0 Alt= 0 #EPs= 3 Cls=00(>ifc) Sub=00 Prot=00 Driver=serial

Physically this looks like (or could be converted to):

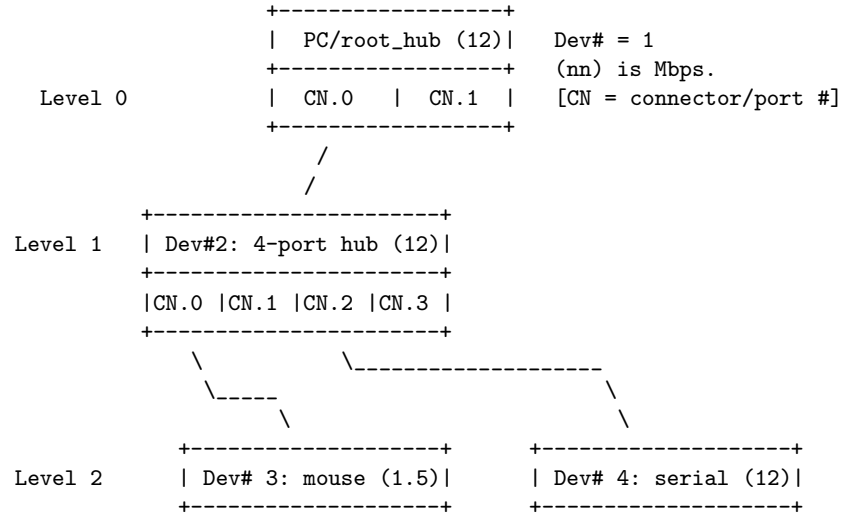

Or, in a more tree-like structure (ports [Connectors] without connections could be omitted):

```

PC: Dev# 1, root hub, 2 ports, 12 Mbps
|_ CN.0: Dev# 2, hub, 4 ports, 12 Mbps
    |_ CN.0: Dev #3, mouse, 1.5 Mbps
    |_ CN.1:
    |_ CN.2: Dev #4, serial, 12 Mbps
    |_ CN.3:
|_ CN.1:

```

END

Index

- /about , 119
- /events , 119
- /help , 119
- /install , 119
- /kill , 119
- /remove , 119
- /run , 119
- /service , 119
- /servicehelper , 119
- /status , 119
- disable-install-distdir , 37
- enable-apcsmart , 36
- enable-cgi , 35
- enable-dumb , 36
- enable-net , 36
- enable-pcnet , 36
- enable-powerflute , 35
- enable-snmp , 36
- enable-test , 36
- enable-usb , 36
- prefix , 35
- sbindir , 35
- with-cgi-bin , 35
- with-css-dir , 35
- with-libwrap , 36
- with-lock-dir , 37
- with-log-dir , 36
- with-net-port , 37
- with-nis-port , 37
- with-nisip , 37
- with-nologin , 36
- with-pid-dir , 36
- with-pwrfail-dir , 37
- with-serial-dev , 37
- with-upscable , 37
- with-upstype , 37
- 2.0 User's Manual: , 185
- A: , 90–94
- Q: , 90–94
- a name , 90
- Acknowledgements , 181
- Advanced topics , 95
- After Installation , 47
- ALARMDEL , 161
- Alert messages , 175
- Alpha Port: , 185
- always , 153
- AMBTEMP , 162
- Analyses of APC Cables , 127
- ANNOY <time in seconds> , 151
- ANNOYDELAY <time in seconds> , 152
- annoyme , 96
- Answers , 182
- APC , 160
- APC smart protocol , 168
- Apcaccess , 67
- Apcaccess Test , 56
- Apccontrol Command Line Options , 96
- apcmain , 55
- APCMODEL , 162
- apcnis , 55
- apcser , 55
- apcsmart , 14
- Apctest , 64
- Apcupsd
 - Building and Installing , 30
 - Testing , 55
- Apcupsd Bugs , 94

- Apcupsd Network Monitoring (CGI) Programs , 71
- Apcupsd Notification and Events , 70
- Apcupsd Status Logging , 157
- Apcupsd Support and Knowledge Base: , 185
- Apcupsd System Logging , 109
- Apcupsd — RPM Packaging FAQ , 182
- Areas
 - Problem , 115
- Arranging for Reboot on Power-Up , 48
- Back-UPS Office 500 signals , 127
- BADBATTS , 162
- Basic User's Guide , 11
- battattach, 99
- BATTDATE , 162
- BATTDATE <string> , 157
- battdetach, 98
- Batteries
 - What Various People Have to Say about , 82
 - Where Carl Suggests You Get , 88
- BATTERYLEVEL <percent of battery> , 150
- BATTV , 58, 161
- BCHARGE , 160
- BEEPSTATE <alarm beep state> , 157
- Beginners
 - Quick Start for , 11
- Bits
 - Status , 175
- BSD
 - Known USB Issues, 24
 - USB Configuration, 24
 - USB Device Nodes, 26
 - USB Kernel Configuration, 24
 - USB Platforms and Versions, 24
 - Verifying USB Device Detection and Driver, 26
- BSD USB Configuration, 24
- Bugs
 - Apcupsd , 94
- Building and Installing apcupsd , 30
- Building the Win32 Version from the Source , 119
- Building with SNMP support, 106
- CABLE , 160
- Cables
 - Analyses of APC , 127
 - Internal Apcupsd Actions for Simple , 136
 - Supported, 14
 - Voltage Signalling Features Supported by Apcupsd for Various , 126
- Cables , 121
- Caldera: , 185
- Can I supply packages for other platforms you do not publish? , 183
- CGI and HTML fixer: , 185
- changeme , 96
- Checking Out Your Linux USB Subsystem, 19
- Checking Your Configuration File , 47
- Choosing a Configuration Type, 16
- Command Line Options Specific to the Windows Version , 119
- commfailure , 96
- commok , 96
- Communications
 - Once you have established serial , 145
 - Troubleshooting Serial Line , 145
- Communications Test , 59

- Compilers and Options , 38
- Config
 - Linux Kernel, 188
- Configuration, 112
 - Simple USB , 50
 - USB, 17
- Configuration , 99
- Configuration Directive Reference , 148
- Configuration Directives for Sharing a UPS , 154
- Configuration Directives Used by the Network Information Server , 149
- Configuration Directives used during Power Failures , 150
- Configuration Directives used to Control System Logging , 154
- Configuration Directives Used to Set the UPS EPROM , 155
- Configuration Examples , 50
- Configuration Types, 16
- Configure Options , 35
- Configuring Your EEPROM , 78
- connected , 96
- Connecting a APC USB UPS to either a PC USB or Serial Port , 121
- Connecting a Serial-Line UPS to a USB Port , 120
- Connecting APCUPSD to a SNMP UPS , 105
- Connection
 - Establishing Serial Port , 140
- Considerations
 - Windows , 168
- Contributors , 185
- Controlling Multiple UPSes on one Machine , 99
- Conventions
 - RS232 Wiring and Signal , 137
- Correspondence
 - Ioctl to RS232 , 138
- Credits , 184
- CUMONBATT , 162
- Current Code Maintainer and Project Manager: , 185
- Custom-RJ45 Smart Signalling Cable for BackUPS CS Models, 124
- Customizing Event Handling , 95
- Darwin
 - Building Apcupsd with USB, 29
 - USB Configuration, 29
 - USB Platforms and Versions, 29
 - Verifying USB Device Detection and Driver, 30
- DATA Logging , 109, 147
- DATETIME<time> , 154
- DATE , 160
- Description , 169
- Details
 - Implementation , 110
- Determining Which Voltage-Signaling Cable You Have , 145
- Developers Notes , 111
- DEVICE <name of device> , 148
- Diagram for cable hackers , 169
- Differences
 - RS-232 , 169
- Dip switch info , 174
- DIPSW , 162
- Directives
 - General Configuration , 148
- disable , 152
- Disclaimer , 116
- Disclaimer: NO WARRANTY , 187
- Discontents
 - Shutdown Sequence and its , 163
- Distribution Maintainers: , 186

DLOWBATT , 161
doreboot , 96
doshutdown , 97
Driver
 Sample NIS Server/Client
 Configuration Using the
 Net , 52
DSHUTD , 161
Dumb
 Simple Configuration for a
 Simple Signaling or , 51
dumb , 14
DWAKE , 161
EEPROM
 Configuring Your , 78
 Programming the UPS , 180
EEPROM Values , 179
Email Notification of Events , 117
emergency , 97
End
 Pin Assignment for the Serial
 Port RS-232C 25-pin and
 9-pin Female , 138
END APC , 162
endselftest , 98
EPROM
 Configuration Directives Used
 to Set the UPS , 155
Establishing Serial Port Con-
 nection , 140
event , 95
Events
 Apcupsd Notification and , 70
 Email Notification of , 117
EVENTS Logging , 109
EVENTSFILE <filename> , 150
Example
 Status Report , 159
Examples
 Configuration , 50
EXTBATTs , 162
FACILITY<log-facility> , 154
failing , 97
Failures
 Configuration Directives used
 during Power , 150
FAQ
 Apcupsd — RPM Packaging ,
 182
Fields
 Status Report , 160
File
 Checking Your Configuration
 , 47
Firewall Settings, 78
FIRMWARE , 162
Format
 Status report , 158
Former Code Maintainer and
 Project Manager: , 185
Frequently-Asked Questions , 90
Full Power Down Test , 62
General Configuration Directives ,
 148
Guide
 Basic User's , 11
Hackers
 Diagram for cable , 169
Handling
 Customizing Event , 95
Hard Core Coders: , 185
Have
 Determining Which Voltage-
 Signaling Cable You , 145
Hid-ups and USB Specific Infor-
 mation , 71
HITRANS , 161
HITRANSFER <upper limit of
 ups batt. transfer> , 156
HOSTNAME , 160
How do I build Apcupsd for plat-
 form xxx? , 182
How do I control whether usb sup-
 port gets built? , 182

- How To Use This Manual , 11
- HP-UX Port , 185
- HUMIDITY , 162
- I'm getting errors about not having permission when , 184
- Implementation Details , 110
- Info
 - Dip switch , 174
- Information
 - hid-ups and USB Specific , 71
 - Logging the STATUS , 163
- Installation
 - After , 47
 - OS X, 33
 - Planning Your , 11
 - Post , 115
 - Troubleshooting Your , 66
 - Verifying a Source , 33
- Installation , 112
- Installation from Binary Packages , 30
- Installation from Source , 31
- Installation: Serial-Line UPSes , 120
- Internal Apcupsd Actions for Simple Cables , 136
- Interpretation of the New Firmware Revision , 178
- Interpretation of the Old Firmware Revision , 178
- Ioctl to RS232 Correspondence , 138
- Issues
 - Known BSD USB, 24
 - Known Linux USB, 18
- ITEMP , 161
- KILLDELAY <time in seconds> , 153
- Killpower under Windows , 117
- Known Problems with USB UPSes , 66
- LASTXFER , 161
- LINEFREQ , 161
- LINEV , 58, 160
- Linux
 - Known USB Issues, 18
 - USB Configuration, 18
 - USB Device Nodes, 22
 - USB Miscellaneous, 24
 - Verifying USB Device Detection and Driver, 19
- Linux Kernel Config, 188
- Linux USB Configuration, 18
- loadlimit , 97
- LOADPCT , 160
- LOCKFILE <path to lockfile> , 149
- Logging
 - apcupsd Status , 157
 - apcupsd System , 109
 - Configuration Directives used to Control System , 154
 - DATA , 109, 147
 - EVENTS , 109
 - STATUS , 109
- Logging Test , 56
- Logging the STATUS Information , 163
- Logging Types , 109
- LOTRANS , 161
- LOTRANSFER <lower limit of ups batt. transfer> , 156
- Mac OS X
 - Building Apcupsd with USB, 29
 - USB Configuration, 29
 - Verifying USB Device Detection and Driver, 30
- Mac OS X (Darwin) USB Configuration, 29
- Machine

- Controlling Multiple UPSes
 - on one , 99
- mainsback , 97
- Maintaining Your UPS , 82
- Making sure apcupsd Is Running , 49
- MANDATE , 162
- Manual
 - How To Use This , 11
- Master/Slave Shutdown , 167
- MASTERUPD , 160
- MAXLINEV , 161
- MAXTIME , 161
- MBATTCHG , 161
- Messages
 - Alert , 175
- MINLINEV , 161
- MINTIMEL , 161
- minutes , 153
- MINUTES <battery runtime in minutes> , 151
- MODEL , 160
- Monitoring and Tuning your UPS , 67
- net , 14
- NetBSD Port: , 185
- NETSERVER [on , off] 149
- NETTIME <time in seconds> , 155
- NIS Server/Client Configuration
 - Using the Net Driver , 52
- NISIP <IP-address> , 149
- NISPORT <port> , 150
- NOLOGINDIR <path to nologin dir> , 153
- NOLOGON <specifies when apcupsd should prevent user logins> , 152
- NOMBATTV , 162
- NOMOUTV , 162
- Notes
 - Developers , 111
- NUMXFERS , 161
- offbattery , 97
- onbattery , 97
- Once you have established serial communications , 145
- OpenBSD Port: , 185
- Operating System Specifics , 39
- Operating Systems, 13
- Options
 - apccontrol Command Line , 96
 - Compilers and , 38
 - Configure , 35
- OS X
 - Installation, 33
- Other APC Cables that apcupsd Supports , 125
- OUTPUTV , 161
- Overview of Serial-Interface UPSes , 120
- Packages
 - Installation from Binary , 30
- Part Time Coders: , 186
- PCNET
 - PowerChute Network Shutdown Driver (PCNET), 54
- pcnet, 15
- percent , 153
- Pin Assignment for the Serial Port (RS-232C), 25-pin and 9-pin, Female End , 138
- Planning Your Installation , 11
- Port
 - Connecting a APC USB UPS to either a PC USB or Serial , 121
 - Connecting a Serial-Line UPS to a USB , 120
- Post Installation , 115
- Power Down During Shutdown , 118
- PowerChute Network Shutdown Driver (PCNET), 54

- powered , 96
- powerout , 97
- Problem Areas , 115
- Problems
 - Known , 107
 - Shutdown , 167
- Process-Status Test , 55
- Programming the UPS EEPROM , 180
- Programs
 - apcupsd Network Monitoring CGI , 71
 - Setting up and Testing the CGI , 72
- Project Discussions: , 186
- Project Starter and Former Code Maintainer: , 185
- Protocol
 - APC smart , 168
 - Smart , 170
- PWRFAILDIR <path to power-fail dir> , 153
- Questions
 - Frequently-Asked , 90
- Quick Start for Beginners , 11
- Recalibrating the UPS Runtime , 145
- Recommended Options for most Systems , 38
- Reference
 - Configuration Directive , 148
 - Technical , 148
- REG1 , 162
- REG2 , 162
- REG3 , 162
- Register 1 , 176
- Register 2 , 177
- Register 3 , 177
- RELEASE , 160
- remotedown , 98
- restartme , 98
- RETPCT , 161
- RETURNCHARGE <min. batt. charge level> , 157
- Revision
 - Interpretation of the New Firmware , 178
 - Interpretation of the Old Firmware , 178
- RPM Packager: , 185
- RS-232 differences , 169
- RS232 Wiring and Signal Conventions , 137
- runlimit , 98
- Running
 - Making sure apcupsd Is , 49
- Running The Network Information Server , 108
- Runtime
 - Recalibrating the UPS , 145
- SCRIPTDIR <path to apccontrol dir> , 153
- SELFTEST , 162
- SENSE , 161
- SENSITIVITY <sets sensitivity level> , 155
- Sequence
 - Shutdown , 63, 163
- Serial Communications: , 185
- SERIALNO , 162
- Server
 - Configuration Directives Used by the Network Information , 149
 - Running The Network Information , 108
- Setting up and Testing the CGI Programs , 72
- Shutdown
 - Master/Slave , 167
 - Power Down During , 118
- Shutdown Problems , 167
- Shutdown Sequence , 63, 163
- Shutdown Sequence and its Discontents , 163

- Signalling
 - Voltage , 126
- Signals
 - Back-UPS Office 500 , 127
- Simple Configuration for a Simple Signaling or Dumb , 51
- Simple Configuration for a SmartUPS , 50
- Simple USB Configuration , 50
- Simple-Custom Voltage-Signalling Cable for dumb UPSes , 122
- Simulated Power Fail Test , 60
- SLEEP <set sleep delay> , 156
- Smart Protocol , 170
- Smart-Custom Cable for SmartUPSes , 121
- SmartUPS
 - Simple Configuration for a , 50
- SmartUPSes
 - Smart-Custom Cable for , 121
- SNMP
 - Building with support for, 106
- snmp , 14
- SNMP Configuration Setup, 102
- SNMP Configure Event Trap Receivers, 105
- SNMP Configure General Parameters, 103
- SNMP Configure IP Address, 102
- SNMP Configure Shutdown Parameters, 104
- SNMP Trap Catching, 107
- SNMP Wiring Setup, 101
- Solaris
 - Building Apcupsd with USB, 28
 - USB Configuration, 28
 - USB Device Nodes, 29
 - USB Platforms and Versions, 28
 - Verifying USB Device Detection and Driver, 28
- SOLARIS Port: , 185
- Solaris USB Configuration, 28
- Source
 - Building the Win32 Version from the , 119
 - Installation from , 31
- Specifics
 - Operating System , 39
- Starting Apcupsd, 113
- startselftest , 98
- STARTTIME , 160
- Startup , 167
- STATFILE <file> , 154
- STATFLAG , 161, 162
- STATTIME<time> , 154
- STATUS , 58, 160
- Status bits , 175
- STATUS Logging , 109
- Status Logging On Serial-Line UPSes , 147
- Status Report Example , 159
- Status Report Fields , 160
- Status report format , 158
- STESTI , 162
- Subsystem
 - Checking Out Your Linux USB, 19
- Super USB bug fixer: , 185
- Support for SNMP UPSes , 101
- Supported Operating Systems, 13
- Supported UPSes and Cables, 14
- Supports
 - Other APC Cables that apcupsd , 125
- System Shutdown Test , 62
- Systems
 - Recommended Options for most , 38
- TCP Wrappers , 78
- Technical Reference , 148
- Test
 - apcaccess , 56
 - Communications , 59

- Full Power Down , 62
- Logging , 56
- Process-Status , 55
- Simulated Power Fail , 60
- System Shutdown , 62
- Testing , 114
- Testing Apcupsd , 55
- Testing Serial-Line UPSes , 139
- TIMELEFT , 160
- timeout , 98, 152
- TIMEOUT <time in seconds> , 151
- TONBATT , 162
- Topics
 - Advanced , 95
- Traps
 - SNMP, 107
- Troubleshooting Serial Line communications , 145
- Troubleshooting Your Installation , 66
- Types
 - Logging , 109
- Upgrading , 114
- UPS
 - Configuration Directives for Sharing a , 154
 - Connecting APCUPSD to a SNMP , 105
 - Maintaining Your , 82
 - Monitoring and Tuning your , 67
- ups-name , 95
- UPSCABLE <type of cable you are using>> , 148
- UPSCCLASS <class of operation> , 154
- UPSes
 - Installation: Serial-Line , 120
 - Known Problems with USB , 66
 - Overview of Serial-Interface , 120
 - Status Logging On Serial-Line , 147
 - Support for SNMP , 101
 - Supported, 14
 - Testing Serial-Line , 139
 - Voltage-Signalling Cable for dumb , 122
 - Win32 Implementation Restrictions for Simple , 136
- UPSMODE , 160
- UPSMODE <mode of operation>, 155
- UPSNAME , 160
- UPSNAME <string> , 157
- UPSses
 - Using apctest on Serial-Line , 142
- UPSTYPE <type of APC UPS you have> , 148
- USB
 - BSD Configuration, 24
 - BSD Device Nodes, 26
 - BSD Kernel Configuration, 24
 - BSD Platforms and Versions, 24
 - Darwin Building Apcupsd, 29
 - Darwin Platforms and Versions, 29
 - Known BSD USB Issues, 24
 - Known Linux USB Issues, 18
 - Linux Configuration, 18
 - Linux Device Nodes, 22
 - Linux Miscellaneous, 24
 - Mac OS X (Darwin) Configuration, 29
 - Solaris Building Apcupsd, 28
 - Solaris Configuration, 28
 - Solaris Device Nodes, 29
 - Solaris Platforms and Versions, 28
 - Verifying BSD Device Detection and Driver, 26
 - Verifying Darwin Device Detection and Driver, 30

- Verifying Linux Device Detection and Driver, 19
- Verifying Solaris Device Detection and Driver, 28
- Verifying Windows Device Detection and Driver, 27
- Windows Configuration, 27
- Windows Driver Installation, 27
- Windows Platforms and Versions, 27
- usb , 14
- USB Configuration, 17
- Using apctest on Serial-Line UPSes , 142

- Values
 - EEPROM , 179
- Verifying a Source Installation , 33
- Version
 - Command Line Options Specific to the Windows , 119
- Voltage Signalling , 126
- Voltage Signalling Features Supported by Apcupsd for Various Cables , 126

- WAKEUP <set wakeup delay> , 156
- WARRANTY
 - Disclaimer: NO , 187
- WEB Interfaces: , 185
- What other defines are used? , 183
- What Various People Have to Say about Batteries , 82
- Where Carl Suggests You Get Batteries , 88
- Win32 Implementation Restrictions for Simple UPSes , 136
- Win32 Port: , 185
- Windows
 - Killpower under , 117
 - USB Configuration, 27
 - USB Driver Installation, 27
 - USB Platforms and Versions, 27
 - Verifying USB Device Detection and Driver, 27
 - Windows Considerations , 168
 - Windows USB Configuration, 27
 - Windows Version of apcupsd, 111
 - Wrappers
 - TCP , 78
 - XOFFBATT , 162
 - XONBATT , 162