

# XJ-300 FR

2 Channel or Monoblock Class “J” Amplifier

# User’s Manual

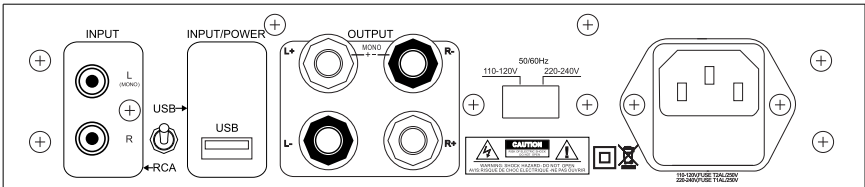
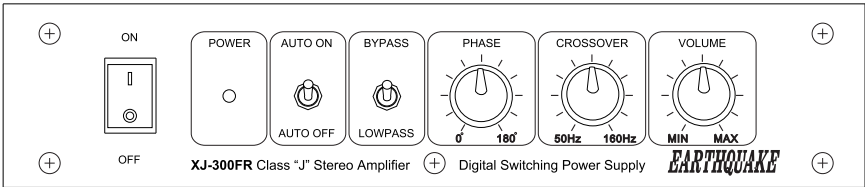

Earthquake Europe  
Mogensensvej 29  
5000 Odense C  
Tel: +45 2043 8007



Customer Support  
E-mail: [support@earthquakesound.dk](mailto:support@earthquakesound.dk)  
Web: [www.earthquakesound.eu](http://www.earthquakesound.eu)  
[www.earthquakesound.dk](http://www.earthquakesound.dk)

© 2011 Earthquake Sound Corporation. All rights reserved.

This document should not be construed as a commitment on the part of Earthquake Sound Corporation. The information is subject to change without notice. Earthquake Sound Corporation assumes no responsibility for errors that may appear within this document.

## Safety Instructions

### Safety First

This documentation contains general safety, installation, and operating instructions for XJ-300FR. It is important to read this user's manual before attempting to use these products. Pay particular attention to the safety instructions.

### Symbols Explained:



Appears on the component to indicate the presence of uninsulated, dangerous voltage inside the enclosure – voltage that may be sufficient to constitute a risk of shock.

**CAUTION**

Calls attention to a procedure, practice, condition or the like that, if not correctly performed or adhered to, could result in injury or death.

**WARNING**

Calls attention to a procedure, practice, condition or the like that, if not correctly performed or adhered to, could result in damage to or destruction of part or all of the product.

### Note:

Calls attention to information that is essential to highlight.

## Safety Instructions

- 1) Read these instructions in their entirety.
- 2) Store this manual and packaging in a safe place.
- 3) Heed all warnings.
- 4) Follow instructions (do not take short cuts).
- 5) Do not use this apparatus near water.
- 6) Clean only with a dry cloth.
- 7) Do not block any ventilation openings. Install in accordance with the manufacturer's instructions.
- 8) Do not install near any heat sources such as radiators, heat registers, stoves, or other apparatuses that produce heat.
- 9) Do not defeat the safety purpose of the polarized or grounding-type plug. A polarized plug has two blades with one wider than the other. A grounding-type plug has two blades and a third grounding prong. The wide blade or the third prong is provided for your safety. If the provided plug does not fit into your outlet, consult an electrician for replacement of the obsolete outlet.
- 10) Protect the power cord from being walked on or pinched, particularly at plugs, convenience receptacles, and the point where they exit from the apparatus.
- 11) Only use attachments & accessories specified by the manufacturer.
- 12) Use only compatible rack or cart for final resting position.
- 13) Unplug this apparatus during lightening storm or when unused for a long period of time.
- 14) Refer all servicing to qualified service personnel. Servicing is required when the apparatus has been damaged in anyway, such as: power-supply cord or plug is damaged, liquid has been spilled or objects have fallen into the apparatus, the apparatus has been exposed to rain or moisture, does not operate normally, or has been dropped.
- 15) To reduce the risk of fire or electric shock, do not expose this apparatus to rain or moisture.

---

## Unpacking System Components

- Keep the original carton and packing materials for future shipment or storage.
- Check for any visual signs of damage. If you encounter any concealed damage, consult your Earthquake Sound dealer before proceeding with unit installation.
- Retain the sales receipt as it establishes the duration of the limited warranty and provides information for insurance purposes.

## System Installation Considerations

There are several factors to consider before installing Earthquake Sound's **XJ-300FR**.

- What are the intended listening zones?
- What system options and accessories might be required for features such as local sources, etc.?
- From where in each zone will the listener prefer to control the system? Where will the remote gains be located? Where will the speakers be located?
- Where will the source equipment be located?

## Connection Tips

- Keep all power cords away from all signal cables to prevent humming from induced noise.
- Choose reliable signal cable cords (Earthquake Sound also specializes in high-performance RCA cables and patches).
- All speaker wires that are ran through the walls should be twisted to reduce potential hum noise pick up.
- Label both ends of all wires with the corresponding room location.
- It is best to use a grounded electrical outlet to power the amplifier. Lack of input ground reference could be unsafe. Consult your electrical contractor about proper grounding.

## Introduction

The XJ-300FR amplifier is an extremely versatile and modular amplifier. It can be used as a two channel, 2.1 channel, or bridged as a 1 channel amplifier. The XJ-300FR runs completely cool while outputting twice the power of most amplifiers its size. Therefore, it is extremely flexible and can be used in many different applications.

### Multiple Mounting Options

The XJ-300FR is only one rack space tall and has a half-rack width chassis. This smart design features a patented interlocking design so two XJ-300FRs can be connected side by side and be rack mountable. Other amplifiers of the same size run too hot to mount them near anything else which defeats the purpose of their size. Because the XJ-300FRs run completely cool, you can comfortably mount other components directly above or below them in the rack. This means ultimate convenience for the installer. There are also additional mounting holes on the sides of the amplifier so that short brackets can be attached and the amp can be mounted directly to a wall or inside a cabinet.

### Speaker Set-up Options

One or two XJ-300FRs can power a 2.1 channel system. This depends on how much power you want to output to your speakers. One XJ-300FR can be used for two speakers while the other can be bridged as a monoblock. Alternatively, you can use two linked XJ-300FRs as a 4 channel system. For a more high powered system, bridge both of them and designate one speaker or sub to one amplifier and another speaker or sub for the other. The installer is completely in charge of how the amplifier's power is distributed.

### Applications

The XJ-300FR has countless applications because of how customizable the channel set-up is. If you need to install in-ceiling speakers in the kitchen, tower speakers in the living room, or rock speakers outside, the XJ-300FR can perform accurately in every situation.

## Included in the Box

- 1 XJ-300FR Stereo Class "J" Amplifier
- 4 Short Mounting Ears
- 1 Bracket
- 4 Screws for the Bracket
- 1 Power Cord

## Front Features

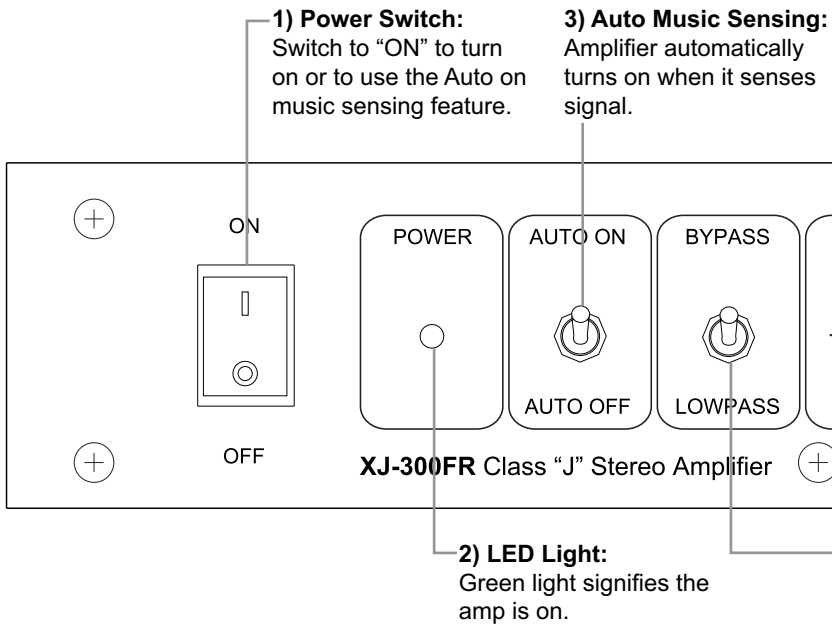

### 1) Power Switch:

In order to enable the auto on music sensing feature, please see 3.

### 3) To Enable Auto Music Sensing:

- Back toggle switch must be set to "RCA" (the down position).
- Front toggle switch must be set to "AUTO ON".
- Power switch must be set to "ON".
- With signal, amplifier comes on right away.
- When there is no signal for three minutes, the amplifier shuts off.

### 4) Bypass/Lowpass Toggle Switch:

When set to Bypass, it overrides the phase and crossover controls. They are only to control low frequencies.

### 5) Phase Setting:

If you are using the XJ-300FR to power a subwoofer, you will need to set the arrival time of the subwoofer's frequencies to that of your speakers. To do this with the highest accuracy, you will need an SPL meter supplied at most electronics stores.

To set the phase:

- Send a 50Hz continuous tone signal through the speakers and the subwoofer at the same time.

**5) Phase Setting:**

Use to correct subwoofer frequency arrival times. Can only use when in "Low Pass" setting.

**7) Volume Setting:**

Set based on the input level and power rating of your load.

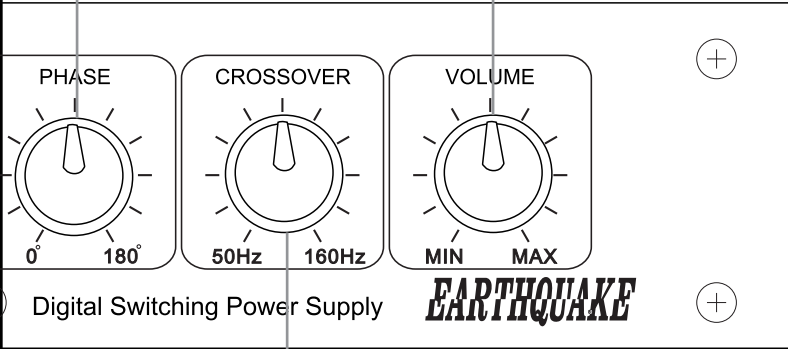

**4) Bypass/Lowpass:**

Set to Bypass to use as a 2 channel or 2.1 channel amplifier. Set to Lowpass to use as a 1 channel or subwoofer amplifier.

**6) Crossover Setting:**

Room equalization for subwoofer frequencies. Can only use when in "Low Pass" setting.

- B) Turn the phase knob to zero and place the meter in the listening position.
- C) While the system is playing the 50Hz tone, read the meter.
- D) Rotate the phase knob until the meter reads the highest possible.
- E) Take note of the position for future reference.

**6) Crossover Setting:**

As a rule of thumb:

- A) If you are powering the THOR In-Wall SUB10, the Q10B tactile transducer, or a large subwoofer (12" - 18"), set the crossover to 50Hz - 100Hz.
- B) If you are powering a MQB-1 tactile transducer, a 10" subwoofer, or small front speakers, set the crossover to 70Hz, or the 9 o'clock position.
- C) If you powering a small subwoofer (8") or small speakers, set the crossover to 100Hz, or the 12 - 2 o'clock position.

# Back Features

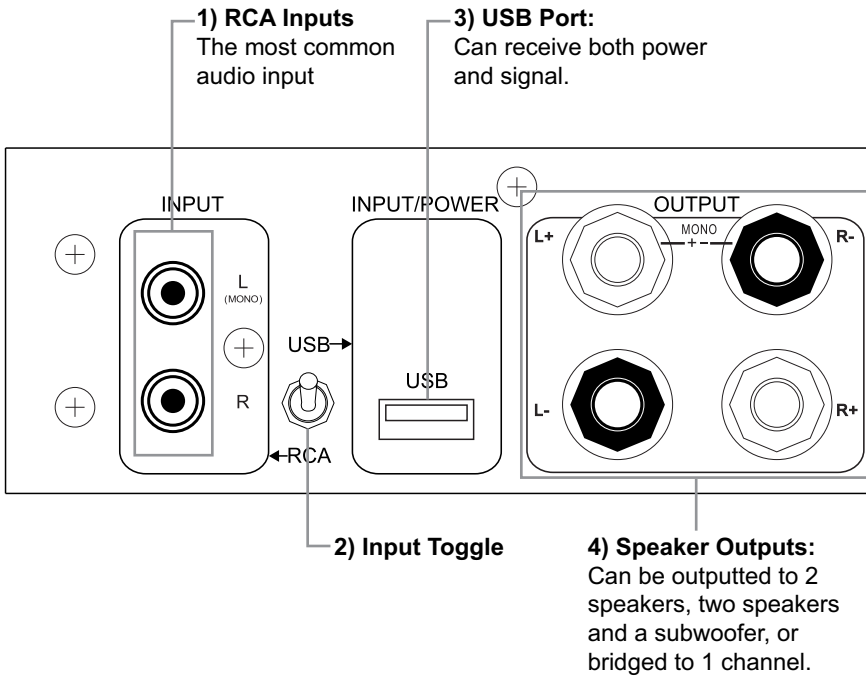

## 1) RCA Inputs:

If you are using the XJ-300FR as a mono block (1 channel amplifier), connect only the left (white) RCA terminal. Be sure the toggle switch is set to "RCA" in order to use this input.

## 2) Input Toggle:

The XJ-300FR is capable of receiving signal through either the RCA or USB input. Please note that the Auto-on music sensing feature is only supported by the RCA input.

## 3) USB Port:

Capable of receiving power and signal, the USB port is optimized for use with the SWAT 2.4 Wireless Transceiver. It uses the standard USB 5.5V. Be sure the toggle switch is set to "USB" in order to use this input.

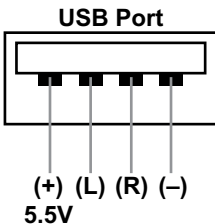

The four metal contacts enable the USB to be used for both power and signal. The outer metal contacts receive the **positive** and **negative** currents while the inner metal contacts receive the **left** and **right** audio.



#### 5) 110V/220V Option:

Should already be set to the correct voltage depending on your region.



**CAUTION**

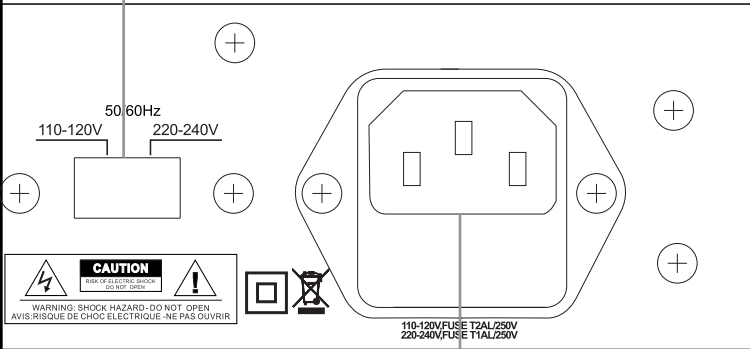

#### 6) Power Supply:

Comes with a replacement fuse directly under power inlet.

#### 4) Speaker Outputs:

- To use the XJ-300FR as a two channel amplifier, connect the right speaker to the R+ and R- terminals and the left speaker to the L+ and L- terminals.
- To bridge the XJ-300FR as a one channel amplifier (or monoblock), connect the positive speaker wire to the L+ terminal and connect the negative speaker wire to the R- terminal. Do not connect anything to the two lower black terminals.
- To use the XJ-300FR as a 2.1 channel amplifier, connect the right speaker to the R+ and R- terminals and the left speaker to the L+ and L- terminals. Then, connect the subwoofer positive to the L+ terminal and the subwoofer negative to the R- terminal.

#### 5) 110V/220V:

Do not attempt to change the voltage setting. The amplifier should already be set to the correct voltage depending on your region. If not, please contact your local Earthquake Sound dealer.

#### 6) Power Supply:

To access the 250V replacement fuse, use a flat head screwdriver to pry off the plastic cover.

## Mounting Options for 1 XJ-300FR

### Wall (or Anywhere) Mountable

The XJ-300FR can uniquely be mounted to a wall or inside a cabinet. Simply screw in the four short ears to the matching holes on the sides of the amplifier chassis.



Then bolt to any vertical or horizontal surface.

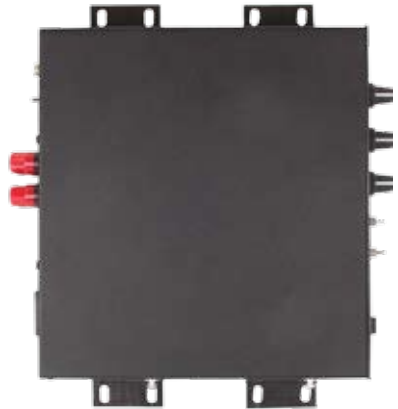

The XJ-300FR also comes with four rubber feet to not damage the bottom in the instance that it simply sits on a shelf or cabinet.

## Linking 2 XJ-300FRs

The XJ-300FR's ingenious design lets the user link two amplifiers together depending on the desired channel set-up.

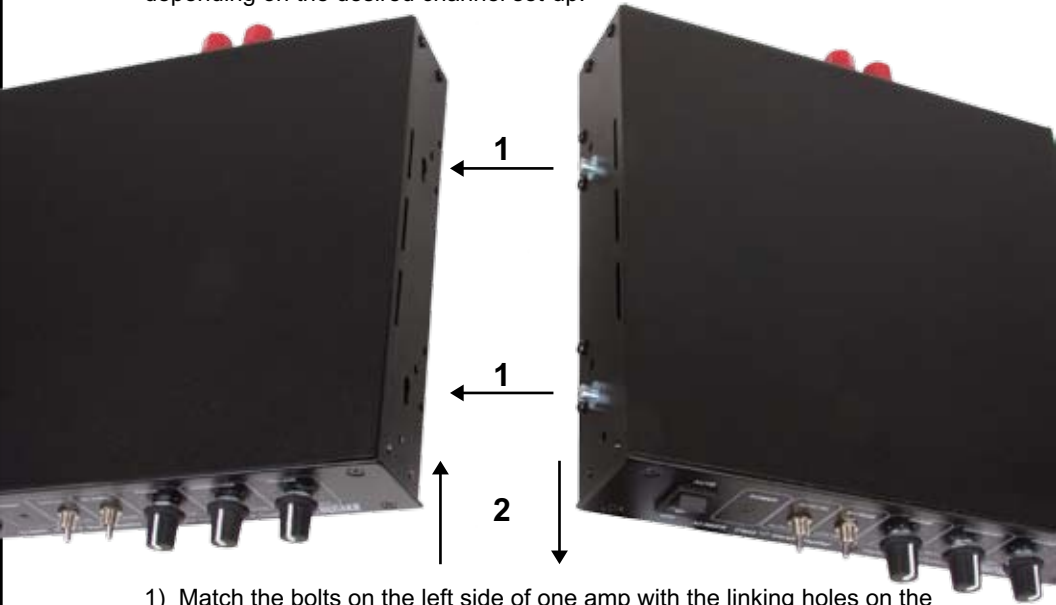

- 1) Match the bolts on the left side of one amp with the linking holes on the right side of the other amp.
- 2) Once they are connected, push the right amp forward while pushing the left amp backwards until they are locked together. They are linked correctly when the faceplates are flush.
- 3) Bracket the backplates of the amps together for added reinforcement.

### WARNING

**WHEN LINKING THE AMPS, DO NOT APPLY PRESSURE ONTO THE FRONTPLATES OR BACKPLATES. THIS COULD DAMAGE THE TERMINALS, KNOBS, OR TOGGLE SWITCHES. AMPS DAMAGED IN THIS WAY ARE NOT COVERED BY THE WARRANTY.**

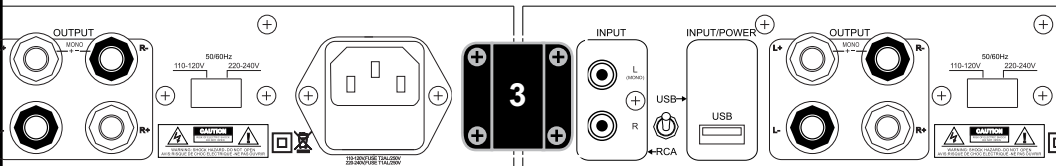

## Mounting 2 XJ-300FRs

Screw short mounting arms to the outer sides of the amplifiers so they are rack mountable.



Or screw two mounting arms on each side so the set is wall mountable.

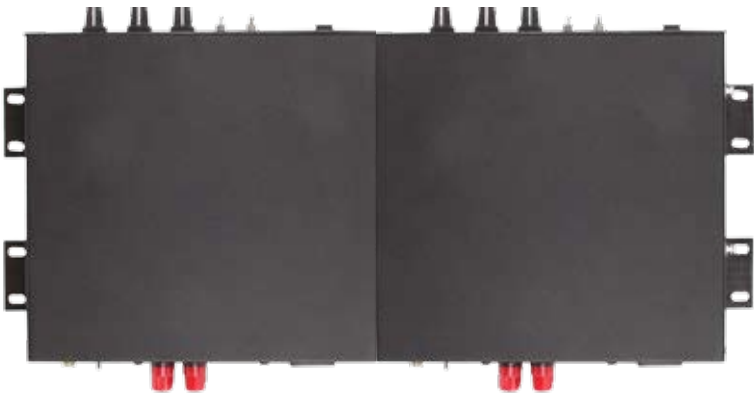

## Connecting to a Subwoofer/Tactile Transducer

**Note:** Make sure the front toggle switch is set to “Low Pass” if connecting to a subwoofer or tactile transducer.

### Wiring with the THOR In-Wall Subwoofer

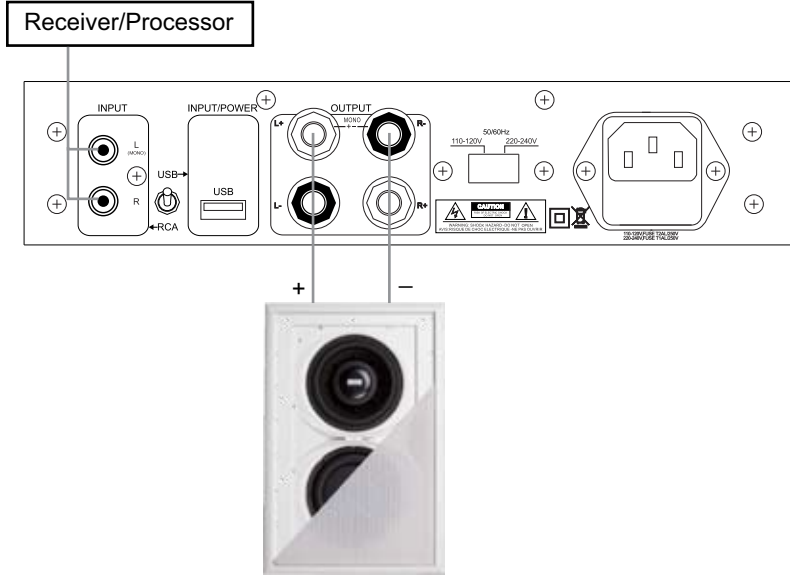

### Wiring with the Q10B Tactile Transducer

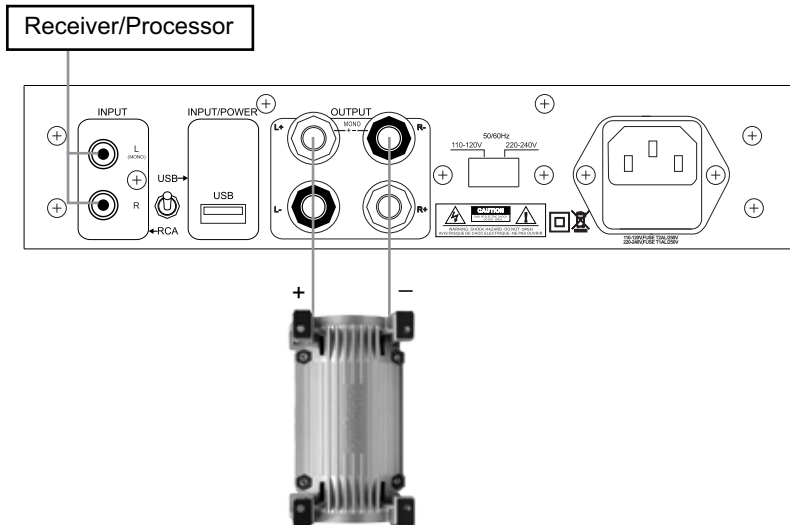

## Connecting to Tactile Transducers

**Note:** Make sure the front toggle switch is set to “Low Pass” if connecting to a subwoofer or tactile transducer.

### Wiring with 2 MQB-1 Tactile Transducers

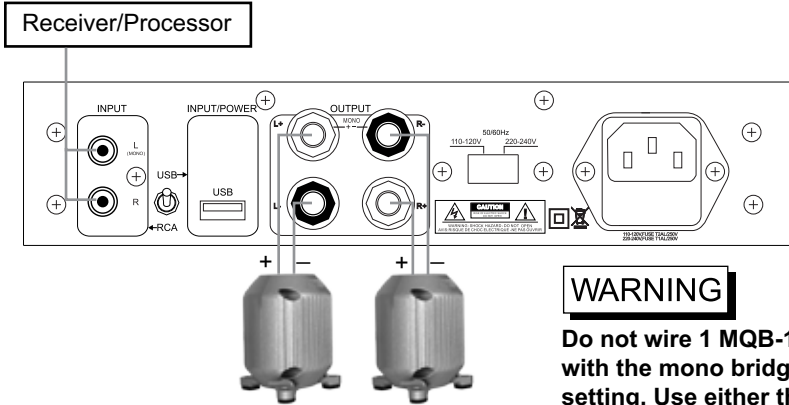

**Do not wire 1 MQB-1 with the mono bridge setting. Use either the left or right speaker output.**

## Connecting to Outdoor Speakers

**Note:** Make sure the front toggle switch is set to “Bypass” if connecting to speakers or a 2.1 channel system.

### Wiring with AWS All Weather Speakers

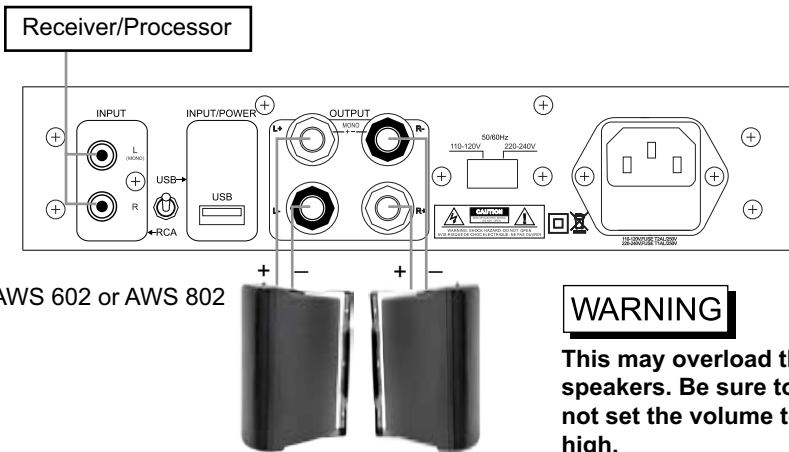

**This may overload the speakers. Be sure to not set the volume too high.**

## Connecting to Outdoor Speakers (cont.)

### Wiring with the ROCK-on 2.1 channel system Series Wiring

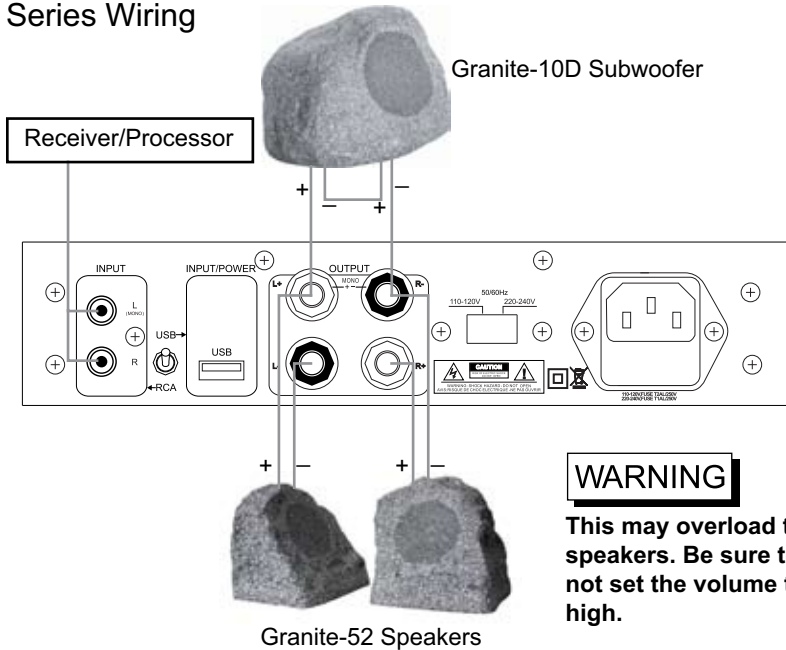

### Option 2

Though 1 XJ-300FR is capable of powering the Granite 2.1 system, you can use 2 linked XJ-300FRs for more power. Set the bridged amplifier to “Low Pass” to power the subwoofer and set the other amp to “Bypass” to power the speakers.

**WARNING**

This may overload the speakers. Be sure to not set the volume too high.

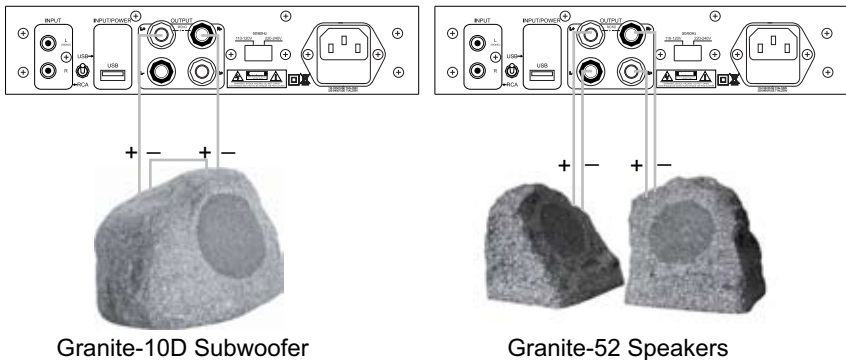

## Connecting to SWAT 2.4 Wireless Transceiver

**Note:** Make sure the back input toggle switch is set to “RCA” if connecting to the SWAT 2.4 Version 1.

The XJ-300FR is optimized for use with the SWAT 2.4 Wireless Transceiver. After the amplifier is wired to the speakers, connect the SWAT 2.4 Receiver to the RCA inputs on the XJ-300FR using a mini-jack to RCA Y adaptor. To power the SWAT 2.4, connect a USB cable from the SWAT to the amplifier.



SWAT 2.4 Wireless Receiver

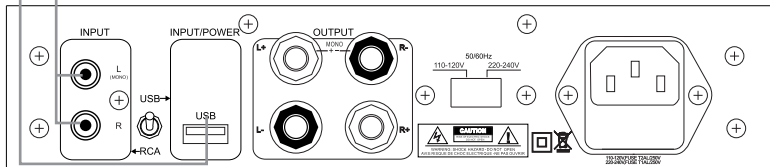

Connect the SWAT 2.4 Transmitter to your music source, processor, or computer with an RCA or mini-jack output. Be sure to power the SWAT with either the supplied wall wart or through the USB port. Now you can wirelessly transmit audio to the XJ-300FR.

SWAT 2.4 Wireless Transmitter



Music Source with audio output

**Note:** SWAT 2.4 Version 2 will be able to transmit both signal and power through its USB port, thus eliminating the need for any RCA connection.



## Specifications

<b>Model No.</b>	<b>XJ-300FR</b>
<b>Output Power</b>	2 X 110 WRMS ( <b>8-Ohm Stereo</b> ) 2 x 170 WRMS ( <b>4-Ohm Stereo</b> ) <b>Mono Bridged:</b> 170 WRMS @ 110 volt AC ( <b>8-Ohm</b> ) 210 WRMS @ 230 volt AC ( <b>8-Ohm</b> ) 320 W-IHF (dynamic power) @ 230 volt AC ( <b>4-Ohm</b> )
<b>Frequency Response</b>	20Hz - 20kHz
<b>THD</b>	0.08%
<b>Damping Factor</b>	>400
<b>Signal to Noise Ratio</b>	>97dB
<b>Power Line Voltage</b>	110 - 120C ~ AC/60Hz/180W (110/220V)
<b>Input Sensitivity for Full Output</b>	max/min: 0 - 5V
<b>Input Impedance</b>	10Kohm
<b>Weight</b>	3.8lbs/1.7kg

## Dimensions



## 5 Year Limited Warranty

Earthquake warrants the original purchaser that the speaker or amplifier (product) is free from defects in material and workmanship, under normal and proper use, for a period of five (5) years from the date of purchase (as shown on the original bill of sale with the serial number affixed/written on it).

The five (5) years warranty period is valid only if the product is properly installed by an Earthquake authorized party, and the warranty registration card is properly filled out and sent to Earthquake Sound Corporation. **If the product is installed by a non-authorized party, a thirty (30) days warranty period applies.**

(A) Five (5) years limited warranty plan coverage guidelines (If installed by an authorized Earthquake dealer):

- First year: Earthquake pays for labor, parts, and ground freight **(only in the U.S. mainland, not including Alaska and Hawaii)** back to the customer.
- Second year: Earthquake pays for labor and parts only, customer must pay freight both ways.
- Third, fourth, and fifth year: Earthquake pays for labor only. Customer must pay for parts and freight both ways.

(B) Warning:

- Products (sent for repair) that are tested by Earthquake technicians and deemed to have no problem, will not be covered by the five (5) years limited warranty. Customer will be charged a minimum of one (1) hour of labor (ongoing rates) plus shipping back to the customer.
- Each product sent for repair must be packaged in its original packaging. Otherwise, **there will be a repackaging charge in addition to labor, parts, and shipping charges.**

(C) Earthquake agrees to repair or replace, at our option, all such defective products/parts subject to the following provisions:

- Defective products/parts have not been altered or repaired by other than an Earthquake factory approved technician.
- Products/parts are not subjected to negligence, misuse, improper use, or accident, damaged by improper line voltage, used with incompatible products, or have its serial number or any part of it altered, defaced, removed, or have been used in anyway that is contrary to Earthquake's written instructions.

(D) Warranty Limitations:

Earthquake warranty does not cover products that have been modified and/or abused, including but not limited to the following:

- Damages to unit cover and finish due to misuse, abuse, or improper use of cleaning materials/methods.

## 5 Year Limited Warranty (cont.)

- Bent casing, damaged finish on casing due to abuse, misuse, or improper frame or broken connections.
- Fading, deterioration of components and finish due to improper exposure to elements.
- Burnt tracers of PCB.
- Product/part damaged due to poor packaging or abusive shipping conditions.
- Subsequent damage to other products.

A warranty claim will not be valid if the warranty registration card is not properly filled and returned to Earthquake with a copy of the sales invoice.

### (E) Service Request:

To receive product(s) service, contact Earthquake Sound's service department at (510) 732-1000 and request an RMA number (Return Material Authorization), item(s) shipped without a valid RMA number will be refused. Make sure you provide us with your complete and correct shipping address, a valid phone number, and a brief description of the problem you are experiencing with the product. In most cases, our technicians might be able to resolve the problem over the phone, thus eliminating the need to ship the product.

### (F) Shipping Instructions:

Product(s) must be packaged in its original protective box(es) to minimize transport damage. Shipper claims regarding item(s) damaged in transit must be presented to the carrier. Earthquake Sound Corporation reserves the right to refuse improperly packed product(s). A copy of original sales receipt must accompany product(s) returned for service. We encourage you to include a written description of the problem inside the package. Ship product to:

**Earthquake Sound Corp.**  
**2727 McCone Avenue**  
**Hayward, CA 94545 USA**  
**Ph: (510) 732-1000**

You are responsible for the cost of shipping the product to Earthquake Sound Corporation.

### (G) Disputes Resolution:

All disputes, between clients and Earthquake Sound Corporation, resulting from the five (5) years limited warranty policy must be resolved according to the laws and regulations of the county of Alameda, California.



**The Sound That Will *Move* You.**

Earthquake Sound reserves the right to amend details of the specifications without notice.

© Copyright Earthquake Sound Corporation  
Earthquake Europe

Mogensensvej 29 , 5000 Odense C, Denmark

Phone: +45 2043 8007 E-mail: [support@earthquakesound.dk](mailto:support@earthquakesound.dk)