

To our customers,

Old Company Name in Catalogs and Other Documents

On April 1st, 2010, NEC Electronics Corporation merged with Renesas Technology Corporation, and Renesas Electronics Corporation took over all the business of both companies. Therefore, although the old company name remains in this document, it is a valid Renesas Electronics document. We appreciate your understanding.

Renesas Electronics website: <http://www.renesas.com>

April 1st, 2010
Renesas Electronics Corporation

Issued by: Renesas Electronics Corporation (<http://www.renesas.com>)

Send any inquiries to <http://www.renesas.com/inquiry>.

Notice

1. All information included in this document is current as of the date this document is issued. Such information, however, is subject to change without any prior notice. Before purchasing or using any Renesas Electronics products listed herein, please confirm the latest product information with a Renesas Electronics sales office. Also, please pay regular and careful attention to additional and different information to be disclosed by Renesas Electronics such as that disclosed through our website.
2. Renesas Electronics does not assume any liability for infringement of patents, copyrights, or other intellectual property rights of third parties by or arising from the use of Renesas Electronics products or technical information described in this document. No license, express, implied or otherwise, is granted hereby under any patents, copyrights or other intellectual property rights of Renesas Electronics or others.
3. You should not alter, modify, copy, or otherwise misappropriate any Renesas Electronics product, whether in whole or in part.
4. Descriptions of circuits, software and other related information in this document are provided only to illustrate the operation of semiconductor products and application examples. You are fully responsible for the incorporation of these circuits, software, and information in the design of your equipment. Renesas Electronics assumes no responsibility for any losses incurred by you or third parties arising from the use of these circuits, software, or information.
5. When exporting the products or technology described in this document, you should comply with the applicable export control laws and regulations and follow the procedures required by such laws and regulations. You should not use Renesas Electronics products or the technology described in this document for any purpose relating to military applications or use by the military, including but not limited to the development of weapons of mass destruction. Renesas Electronics products and technology may not be used for or incorporated into any products or systems whose manufacture, use, or sale is prohibited under any applicable domestic or foreign laws or regulations.
6. Renesas Electronics has used reasonable care in preparing the information included in this document, but Renesas Electronics does not warrant that such information is error free. Renesas Electronics assumes no liability whatsoever for any damages incurred by you resulting from errors in or omissions from the information included herein.
7. Renesas Electronics products are classified according to the following three quality grades: “Standard”, “High Quality”, and “Specific”. The recommended applications for each Renesas Electronics product depends on the product’s quality grade, as indicated below. You must check the quality grade of each Renesas Electronics product before using it in a particular application. You may not use any Renesas Electronics product for any application categorized as “Specific” without the prior written consent of Renesas Electronics. Further, you may not use any Renesas Electronics product for any application for which it is not intended without the prior written consent of Renesas Electronics. Renesas Electronics shall not be in any way liable for any damages or losses incurred by you or third parties arising from the use of any Renesas Electronics product for an application categorized as “Specific” or for which the product is not intended where you have failed to obtain the prior written consent of Renesas Electronics. The quality grade of each Renesas Electronics product is “Standard” unless otherwise expressly specified in a Renesas Electronics data sheets or data books, etc.
 - “Standard”: Computers; office equipment; communications equipment; test and measurement equipment; audio and visual equipment; home electronic appliances; machine tools; personal electronic equipment; and industrial robots.
 - “High Quality”: Transportation equipment (automobiles, trains, ships, etc.); traffic control systems; anti-disaster systems; anti-crime systems; safety equipment; and medical equipment not specifically designed for life support.
 - “Specific”: Aircraft; aerospace equipment; submersible repeaters; nuclear reactor control systems; medical equipment or systems for life support (e.g. artificial life support devices or systems), surgical implantations, or healthcare intervention (e.g. excision, etc.), and any other applications or purposes that pose a direct threat to human life.
8. You should use the Renesas Electronics products described in this document within the range specified by Renesas Electronics, especially with respect to the maximum rating, operating supply voltage range, movement power voltage range, heat radiation characteristics, installation and other product characteristics. Renesas Electronics shall have no liability for malfunctions or damages arising out of the use of Renesas Electronics products beyond such specified ranges.
9. Although Renesas Electronics endeavors to improve the quality and reliability of its products, semiconductor products have specific characteristics such as the occurrence of failure at a certain rate and malfunctions under certain use conditions. Further, Renesas Electronics products are not subject to radiation resistance design. Please be sure to implement safety measures to guard them against the possibility of physical injury, and injury or damage caused by fire in the event of the failure of a Renesas Electronics product, such as safety design for hardware and software including but not limited to redundancy, fire control and malfunction prevention, appropriate treatment for aging degradation or any other appropriate measures. Because the evaluation of microcomputer software alone is very difficult, please evaluate the safety of the final products or system manufactured by you.
10. Please contact a Renesas Electronics sales office for details as to environmental matters such as the environmental compatibility of each Renesas Electronics product. Please use Renesas Electronics products in compliance with all applicable laws and regulations that regulate the inclusion or use of controlled substances, including without limitation, the EU RoHS Directive. Renesas Electronics assumes no liability for damages or losses occurring as a result of your noncompliance with applicable laws and regulations.
11. This document may not be reproduced or duplicated, in any form, in whole or in part, without prior written consent of Renesas Electronics.
12. Please contact a Renesas Electronics sales office if you have any questions regarding the information contained in this document or Renesas Electronics products, or if you have any other inquiries.

(Note 1) “Renesas Electronics” as used in this document means Renesas Electronics Corporation and also includes its majority-owned subsidiaries.

(Note 2) “Renesas Electronics product(s)” means any product developed or manufactured by or for Renesas Electronics.

IE-784928-NS-EM1

Emulation Board

IE-784928-NS-EM1
EP-784928GF-NS

Target device

μ PD784915 Subseries μ PD784928 Subseries
 μ PD784928Y Subseries

[MEMO]

Windows is either a registered trademark or a trademark of Microsoft Corporation in the United States and/or other countries.

PC/AT is a trademark of International Business Machines Corporation.

The information in this document is subject to change without notice.

No part of this document may be copied or reproduced in any form or by any means without the prior written consent of NEC Corporation. NEC Corporation assumes no responsibility for any errors which may appear in this document.

NEC Corporation does not assume any liability for infringement of patents, copyrights or other intellectual property rights of third parties by or arising from use of a device described herein or any other liability arising from use of such device. No license, either express, implied or otherwise, is granted under any patents, copyrights or other intellectual property rights of NEC Corporation or of others.

Regional Information

Some information contained in this document may vary from country to country. Before using any NEC product in your application, please contact the NEC office in your country to obtain a list of authorized representatives and distributors. They will verify:

- Device availability
- Ordering information
- Product release schedule
- Availability of related technical literature
- Development environment specifications (for example, specifications for third-party tools and components, host computers, power plugs, AC supply voltages, and so forth)
- Network requirements

In addition, trademarks, registered trademarks, export restrictions, and other legal issues may also vary from country to country.

NEC Electronics Inc. (U.S.)

Santa Clara, California
Tel: 408-588-6000
800-366-9782
Fax: 408-588-6130
800-729-9288

NEC Electronics (Germany) GmbH

Duesseldorf, Germany
Tel: 0211-65 03 02
Fax: 0211-65 03 490

NEC Electronics (UK) Ltd.

Milton Keynes, UK
Tel: 01908-691-133
Fax: 01908-670-290

NEC Electronics Italiana s.r.l.

Milano, Italy
Tel: 02-66 75 41
Fax: 02-66 75 42 99

NEC Electronics (Germany) GmbH

Benelux Office
Eindhoven, The Netherlands
Tel: 040-2445845
Fax: 040-2444580

NEC Electronics (France) S.A.

Velizy-Villacoublay, France
Tel: 01-30-67 58 00
Fax: 01-30-67 58 99

NEC Electronics (France) S.A.

Spain Office
Madrid, Spain
Tel: 91-504-2787
Fax: 91-504-2860

NEC Electronics (Germany) GmbH

Scandinavia Office
Taeby, Sweden
Tel: 08-63 80 820
Fax: 08-63 80 388

NEC Electronics Hong Kong Ltd.

Hong Kong
Tel: 2886-9318
Fax: 2886-9022/9044

NEC Electronics Hong Kong Ltd.

Seoul Branch
Seoul, Korea
Tel: 02-528-0303
Fax: 02-528-4411

NEC Electronics Singapore Pte. Ltd.

United Square, Singapore 1130
Tel: 65-253-8311
Fax: 65-250-3583

NEC Electronics Taiwan Ltd.

Taipei, Taiwan
Tel: 02-2719-2377
Fax: 02-2719-5951

NEC do Brasil S.A.

Electron Devices Division
Rodovia Presidente Dutra, Km 214
07210-902-Guarulhos-SP Brasil
Tel: 55-11-6465-6810
Fax: 55-11-6465-6829

J99.1

INTRODUCTION

Product Overview

The IE-784928-NS-EM1 is designed to be used with the IE-78K4-NS and dedicated emulation probe to debug the following target devices that belong to the 78K/IV Series of 16-bit single-chip microcontrollers.

- μ PD784915 Subseries: μ PD784915, 784915A, 784915B, 784916A, 784916B, 78P4916
- μ PD784928 Subseries: μ PD784927, 78F4928
- μ PD784928Y Subseries: μ PD784927Y, 78F4928Y

Target Readers

This manual is intended for engineers who will use the IE-784928-NS-EM1 with the IE-78K4-NS to perform system debugging.

Engineers who use this manual are expected to be thoroughly familiar with the target device's functions and use methods and to be knowledgeable about debugging.

Organization

When using the IE-784928-NS-EM1, refer to not only this manual (supplied with the IE-784928-NS-EM1) but also the manual that is supplied with the IE-78K4-NS.

IE-78K4-NS User's Manual

- Basic specifications
- System configuration
- External interface functions

IE-784928-NS-EM1 User's Manual

- General
- Part names
- Installation
- Differences between target devices and target interface circuits

Purpose

This manual's purpose is to explain various debugging functions that can be performed when using the IE-784928-NS-EM1.

Terminology

The meanings of certain terms used in this manual are listed below.

Term	Meaning
Emulation device	This is a general term that refers to the device in the emulator that is used to emulate the target device. It includes the emulation CPU.
Emulation CPU	This is the CPU block in the emulator that is used to execute user-generated programs.
Target device	This is the device (a real chip) that is the target for emulation.
Target system	The device that is targeted for debugging. This includes the target program and the hardware provided by the user. When defined narrowly, it includes only the hardware.
IE system	This refers to the combination of the IE-78K4-NS and the IE-784928-NS-EM1.

Conventions

Data significance: Higher digits on the left and lower digits on the right

Note: Footnote for item marked with **Note** in the text

Caution: Information requiring particular attention

Remark: Supplementary information

Related Documents

The related documents (user's manuals) indicated in this publication may include preliminary versions. However, preliminary versions are not marked as such.

Document Name	Document Number	
	English	Japanese
IE-78K4-NS	U13356E	U13356J
IE-784928-NS-EM1	This manual	U13819J
ID78K4-NS Integrated Debugger Reference Windows™ Based	U12796E	U12796J
μPD784915 Subseries Hardware	U10444E	U10444J
μPD784928 Subseries Hardware	U12648E	U12648J

Caution The documents listed above are subject to change without notice. Be sure to use the latest documents when designing.

CONTENTS

CHAPTER 1 GENERAL	11
1.1 System Configuration	12
1.2 Hardware Configuration	14
1.3 Basic Specifications	15
CHAPTER 2 PART NAMES	17
2.1 Parts of Emulation Board	18
2.2 Chipset Board Part Names	19
CHAPTER 3 INSTALLATION	21
3.1 Connection	22
3.2 Target Device Setting	22
3.3 Clock Settings	23
3.3.1 Overview of clock settings.....	23
3.3.2 Main system clock settings.....	25
3.3.3 Subsystem clock settings	29
3.4 Pin Mask Function Settings	30
3.5 Low-Voltage Emulation Setting	30
3.6 External Trigger	31
CHAPTER 4 EMULATION PROBE (EP-784928GF-NS)	33
4.1 Configuration of EP-784928GF-NS	33
4.2 Connection Procedure	34
4.2.1 Emulation probe and target system connection (when using the 100-pin GF package)	34
4.2.2 Emulation probe and target system connection (when using the 100-pin GC package).....	35
CHAPTER 5 DIFFERENCES BETWEEN TARGET DEVICES AND TARGET INTERFACE CIRCUITS	37

LIST OF FIGURES

Figure No.	Title	Page
Figure 1-1.	System Configuration	12
Figure 1-2.	Basic Hardware Configuration	14
Figure 2-1.	IE-784928-NS-EM1 Part Names	18
Figure 2-2.	Chipset Board Part Names.....	19
Figure 3-1.	Mounting of Chipset Board.....	22
Figure 3-2.	External Circuits Used as System Clock Oscillator	23
Figure 3-3.	When Using Clock That Is Already Mounted on Emulation Board	24
Figure 3-4.	When Using User-Mounted Clock	24
Figure 3-5.	When Using an External Clock	25
Figure 3-6.	Connections on Parts Board (When Using Main System Clock or User-Mounted Clock)	26
Figure 3-7.	Crystal Oscillator (When Using Main System Clock or User-Mounted Clock)	28
Figure 3-8.	Pin Alignment of Crystal Oscillator and Socket.....	28
Figure 3-9.	External Trigger Input Position	31
Figure 4-1.	EP-784928GF-NS Configuration Diagram	33
Figure 4-2.	Emulation Probe and Target System Connection (When Using the 100-Pin GF Package)	34
Figure 4-3.	EP-784928GF-NS and Target System Connection (When Using the 100-Pin GC Package).....	35
Figure 5-1.	Equivalent Circuit 1 of Emulation Circuit	38
Figure 5-2.	Equivalent Circuit 2 of Emulation Circuit	39
Figure 5-3.	Equivalent Circuit 3 of Emulation Circuit	40

LIST OF TABLES

Table No.	Title	Page
Table 1-1.	Basic Specifications	15
Table 3-1.	Main System Clock Settings.....	25
Table 3-2.	Slide Switch Setting for NMI Interrupt Mask Function	30

[MEMO]

CHAPTER 1 GENERAL

The IE-784928-NS-EM1 is a development tool for efficient debugging of hardware or software when using one of the following target devices that belong to the 78K/IV Series of 16-bit single-chip microcontrollers.

This chapter describes the IE-784928-NS-EM1's system configuration and basic specifications.

- Target device
 - μ PD784915 Subseries
 - μ PD784928 Subseries
 - μ PD784928Y Subseries

1.1 System Configuration

Figure 1-1 illustrates the IE-784928-NS-EM1's system configuration.

Figure 1-1. System Configuration

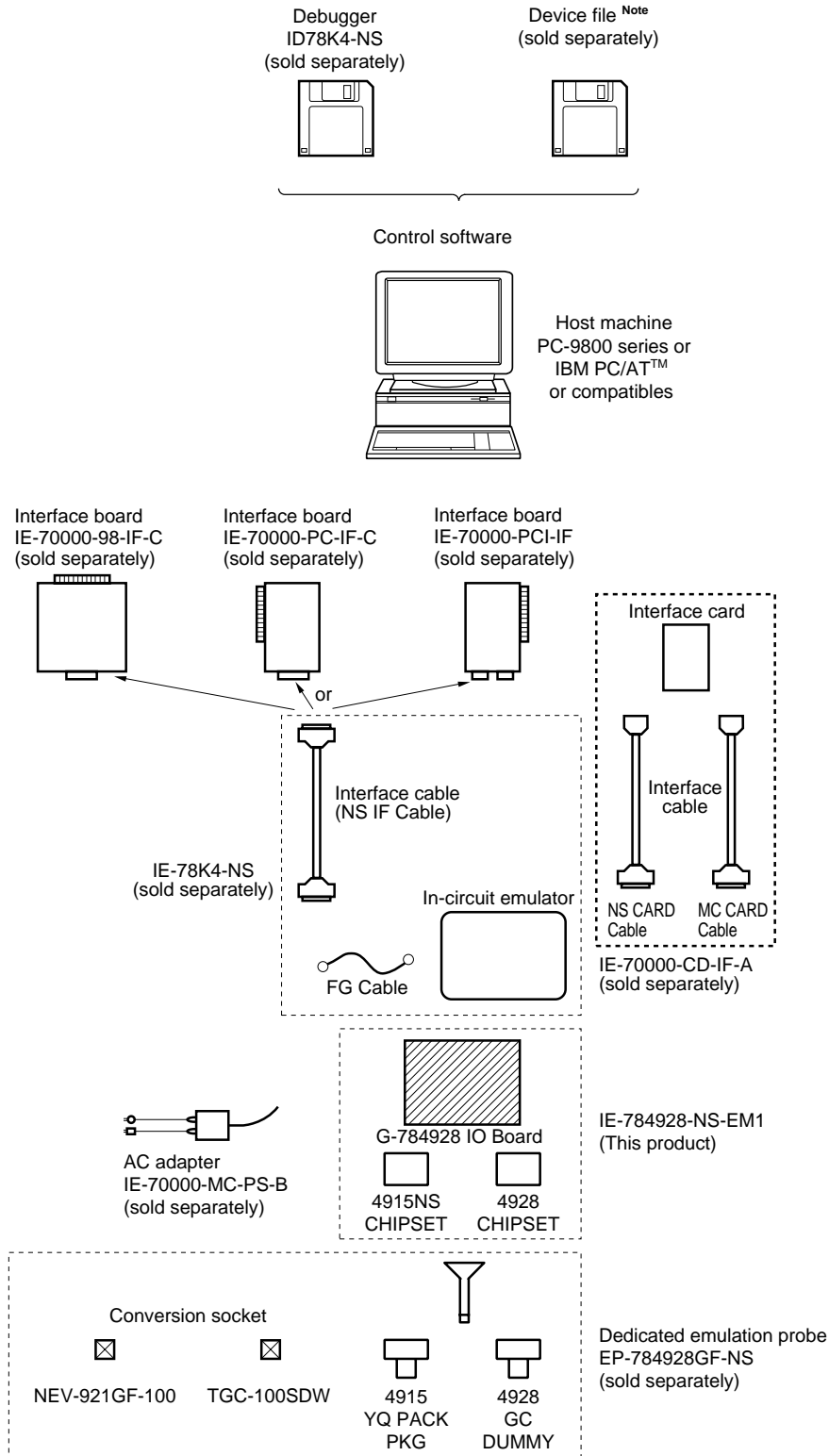

Note The device file is as follows, in accordance with the subseries.

μ SxxxxDF784915: μ PD784915 Subseries

μ SxxxxDF784928: μ PD784928, 784928Y Subseries

1.2 Hardware Configuration

Figure 1-2 shows the IE-784928-NS-EM1's position in the basic hardware configuration.

Figure 1-2. Basic Hardware Configuration

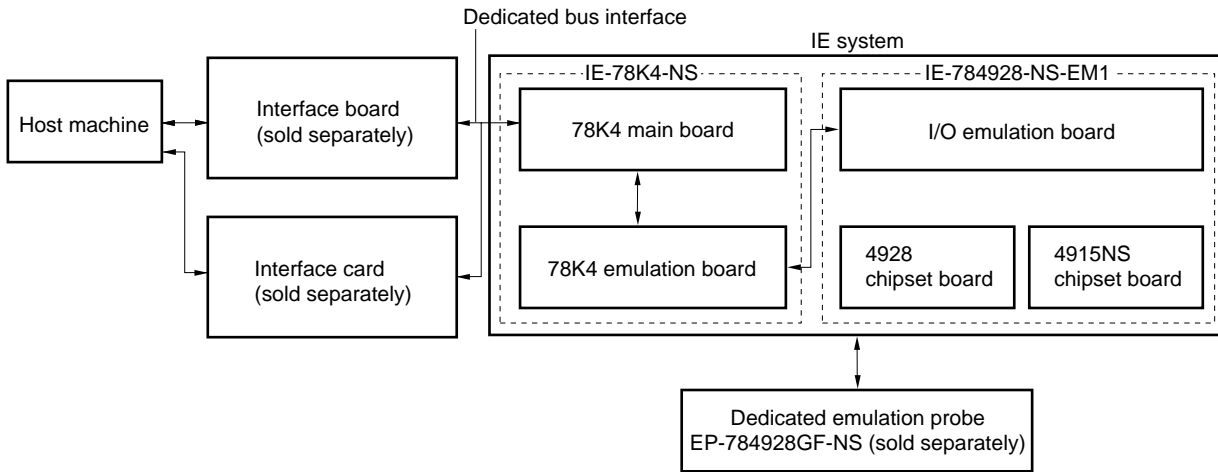

1.3 Basic Specifications

The IE-784928-NS-EM1's basic specifications are listed in Table 1-1.

Table 1-1. Basic Specifications

Parameter	Description
Target device	μ PD784915, 784928, 784928Y Subseries
System clock	Main system clock: 8 MHz Subsystem clock: 32.768 kHz
Main clock supply	External: Input via an emulation probe from the target system Internal: Mounted on emulation board (16 MHz), or mounted on the board by the user
Subsystem clock supply	Internal: Mounted on emulation board (32.768 kHz)
Low-voltage support	2.7 V or higher (same as target device)

[MEMO]

CHAPTER 2 PART NAMES

This chapter introduces the parts of the IE-784928-NS-EM1 main unit and the chipset boards.

The packing box contains the emulation board (IE-784928-NS-EM1), and two chipset boards (4915NS CHIPSET, 4928 CHIPSET).

If there are any missing or damaged items, please contact an NEC sales representative.

Fill out and return the guarantee document that comes with the main unit.

2.1 Parts of Emulation Board

Figure 2-1. IE-784928-NS-EM1 Part Names

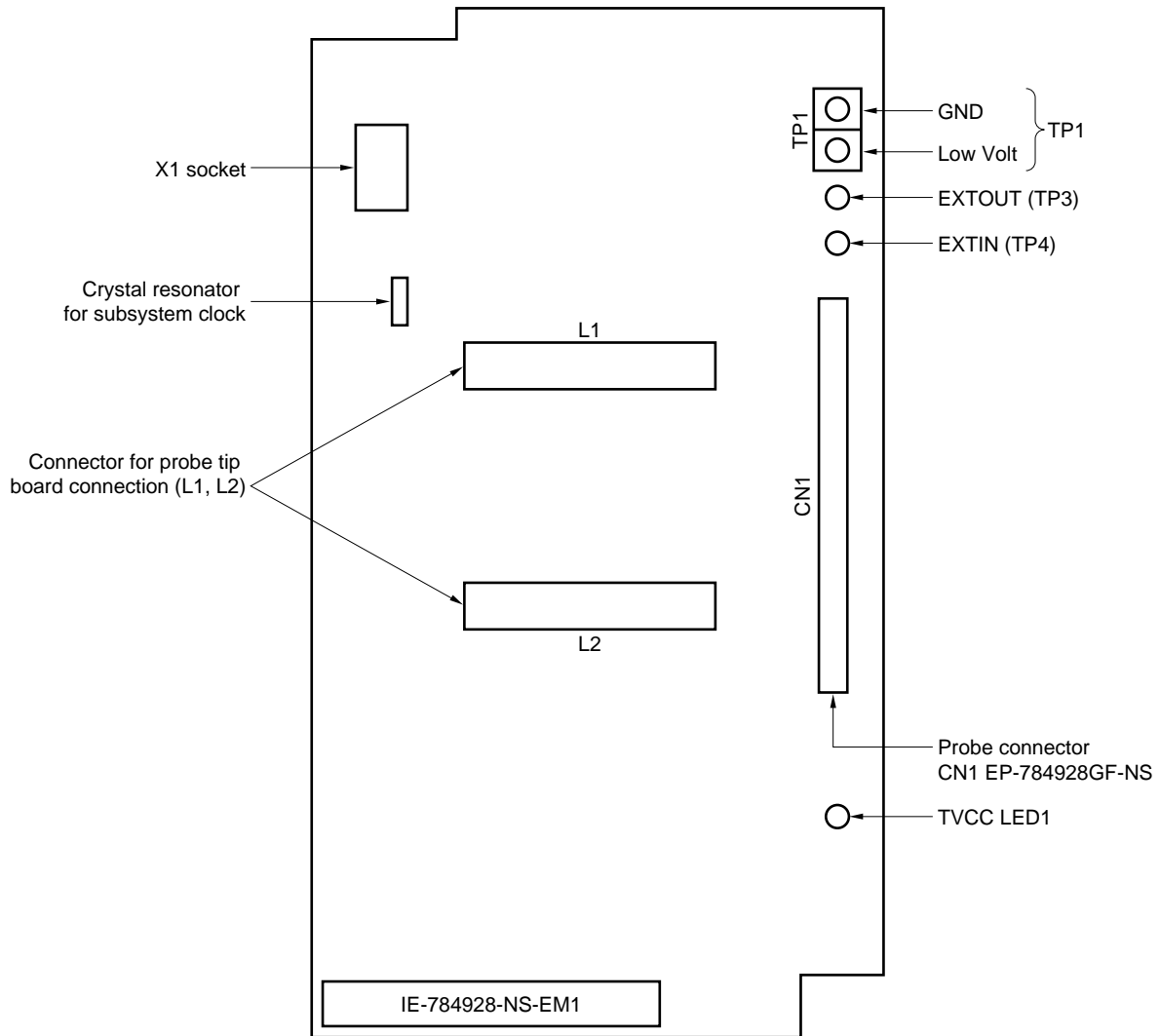

2.2 Chipset Board Part Names

Figure 2-2. Chipset Board Part Names

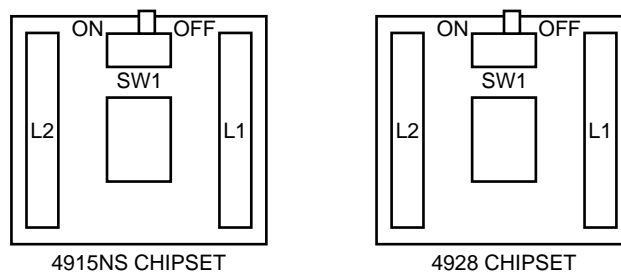

The IE-784928-NS-EM1 includes the 4915NS CHIPSET and the 4928 CHIPSET.

- (1) When the 4915NS CHIPSET is used to emulate the μ PD784915 Subseries, use the 4928 CHIPSET to emulate the μ PD784928 and 784928Y Subseries.
- (2) When using an emulation probe, connect the 4915NS CHIPSET or the 4928 CHIPSET to the probe tip.
- (3) When not using an emulation probe, connect the 4915NS CHIPSET or the 4928 CHIPSET to the L1 and L2 connectors on the IE-784928-NS-EM1.

Caution Do not connect the chipset boards to both the emulation probe tip and the L1 and L2 connectors on the IE-784928-NS-EM1 at the same time.

[MEMO]

CHAPTER 3 INSTALLATION

This chapter describes methods for connecting the IE-784928-NS-EM1 to the IE-78K4-NS, emulation probe, or chipset boards. Mode setting methods are also described.

Caution Connecting or removing components to or from the target system, or making switch or other setting changes must be carried out after the power supply to both the IE system and the target system has been switched OFF.

3.1 Connection

(1) Connection to chipset board

Connect the 4915NS CHIPSET or the 4928 CHIPSET to the L1 and L2 connectors on the IE-784928-NS-EM1.

Figure 3-1. Mounting of Chipset Board

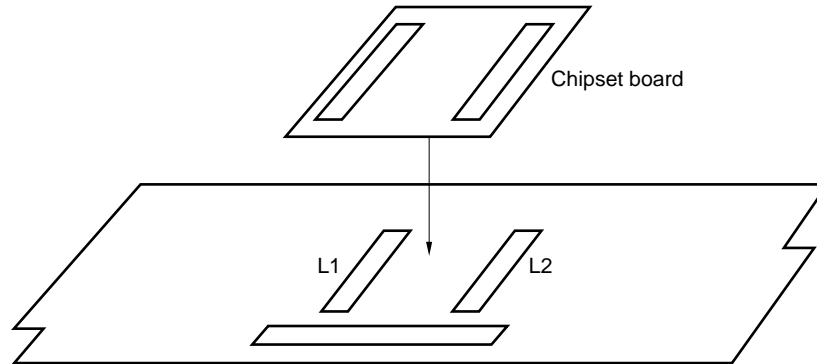

Caution Do not connect the chipset board while the emulation probe is in use.

(2) Connection with IE-78K4-NS main unit

See the IE-78K4-NS User's Manual (U13356E) for a description of how to connect the IE-784928-NS-EM1 to the IE-78K4-NS.

(3) Connection with emulation probe

See **CHAPTER 4 EMULATION PROBE (EP-784928GF-NS)** for a description of how to connect an emulation probe to the IE-784928-NS-EM1.

On this board, connect the emulation probe to CN1.

Caution A clock cannot be supplied to the emulation device from the oscillation clock in the target system. When operating at a frequency other than 16 MHz, attach a clock device of the same oscillation frequency as that supplied to the target device to X1.

3.2 Target Device Setting

When emulating the μ PD784915 Subseries, connect the 4915NS CHIPSET to L1 and L2.

When emulating the μ PD784928 and μ PD784928Y Subseries, connect the 4928 CHIPSET to L1 and L2.

3.3 Clock Settings

3.3.1 Overview of clock settings

The main system clock to be used during debugging can be selected from (1) to (3) below.

- (1) Clock that is already mounted on emulation board
- (2) Clock that is mounted by user
- (3) External clock

Caution Use “clock that is already mounted on emulation board” for the subsystem clock.

If the target system includes an internal clock, select either “(1) Clock that is already mounted on emulation board” or “(2) Clock that is mounted by user”. For an internal clock, the target device is connected to a resonator and the target device’s internal oscillator is used. An example of the external circuit is shown in part (a) of Figure 3-2. During emulation, the resonator that is mounted on the target system is not used. Instead, the clock that is mounted on the emulation board, which is installed for the IE-78K4-NS is used.

If the target system includes an external clock, select “(3) External clock”.

For an external clock, a clock signal is supplied from outside of the target device and the target device’s internal oscillator is not used. An example of the external circuit is shown in part (b) of Figure 3-2.

Figure 3-2. External Circuits Used as System Clock Oscillator

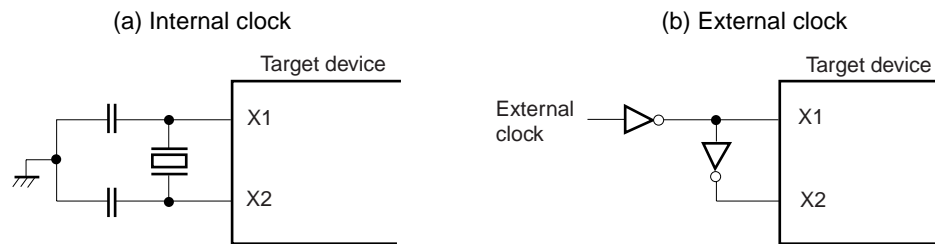

(1) Clock that is already mounted on emulation board

A crystal oscillator is already mounted on the emulation board. Its frequency is 16 MHz.

Figure 3-3. When Using Clock That Is Already Mounted on Emulation Board

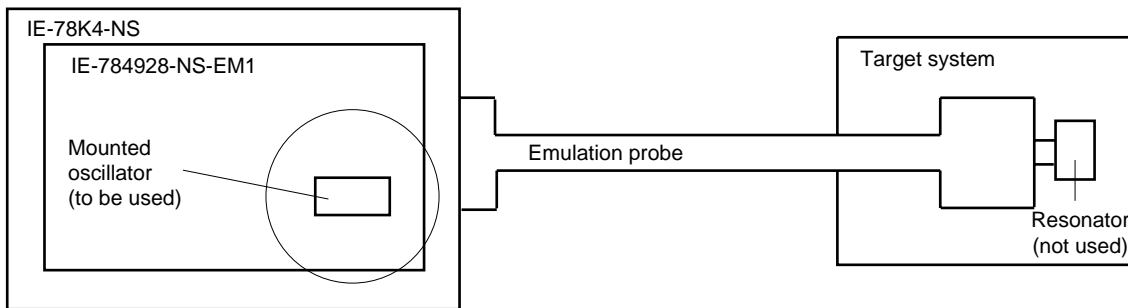

Remark The clock that is supplied by the IE-784928-NS-EM1's oscillator (encircled in the figure) is used.

(2) Clock that is mounted by user

The user is able to mount any clock supported by the set specifications on the IE-784928-NS-EM1. First mount the resonator on the parts board, then attach the parts board to the IE-784928-NS-EM1. This method is useful when using a different frequency from that of the pre-mounted clock.

Figure 3-4. When Using User-Mounted Clock

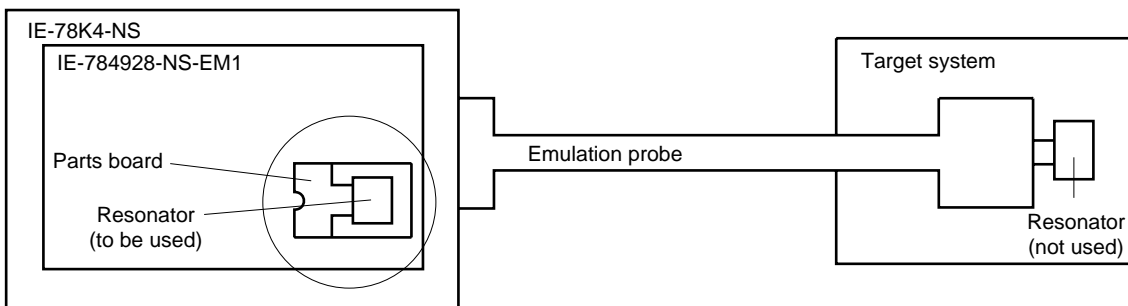

Remark The clock that is supplied by the IE-784928-NS-EM1's resonator (encircled in the figure) is used.

(3) External clock

An external clock connected to the target system can be used via an emulation probe.

Figure 3-5. When Using an External Clock

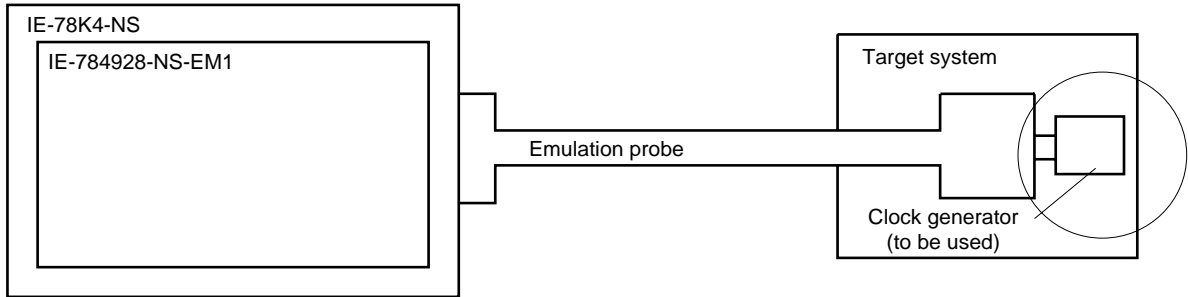

Remark The clock supplied by the target system’s clock generator (encircled in the figure) is used.

3.3.2 Main system clock settings

Table 3-1. Main System Clock Settings

Frequency of Main System Clock		IE-784928-NS-EM1	CPU Clock Source Selection (ID)
		Parts Board (X1)	
When using clock that is already mounted on emulation board	16 MHz	Oscillator used	Internal
When using clock mounted by user	Other than 16 MHz	Oscillator assembled by user	
When using external clock			Oscillator not used

Caution When using an external clock, open the configuration dialog box when starting the integrated debugger (ID78K4-NS) and select “External” in the area (Clock) for selecting the CPU’s clock source (this selects the user’s clock).

Remark The IE-784928-NS-EM1’s factory settings are those listed above under “when using clock that is already mounted on emulation board”.

(1) When using clock that is already mounted on emulation board

When the IE-784928-NS-EM1 is shipped, a 16-MHz crystal oscillator is already mounted in the IE-784928-NS-EM1’s X1 socket. When using the factory-set mode settings, there is no need to make any other hardware settings.

When starting the integrated debugger (ID78K4-NS), open the configuration dialog box and select “Internal” in the area (Clock) for selecting the CPU’s clock source (this selects the emulator’s internal clock).

(2) When using clock mounted by user

The settings described under either (a) or (b) are required, depending on the type of clock to be used. When starting the integrated debugger (ID78K4-NS), open the configuration dialog box and select "Internal" in the area (Clock) for selecting the CPU's clock source (this selects the emulator's internal clock).

(a) When using a ceramic resonator or crystal resonator

- Items to be prepared
 - Parts board (supplied with IE-78K4-NS)
 - Ceramic resonator or crystal resonator
 - Resistor Rx
- Capacitor CA
- Capacitor CB
- Solder kit

<Steps>

- <1> Solder the target ceramic resonator or crystal resonator, resistor Rx, capacitor CA, and capacitor CB (all with suitable oscillation frequency) onto the supplied parts board (as shown below).

Figure 3-6. Connections on Parts Board (When Using Main System Clock or User-Mounted Clock)

Parts board (X1)

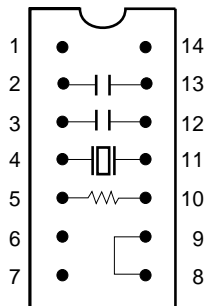

Pin No.	Connection
2-13	Capacitor CB
3-12	Capacitor CA
4-11	Ceramic resonator or crystal resonator
5-10	Resistor Rx
8-9	Short

Circuit diagram

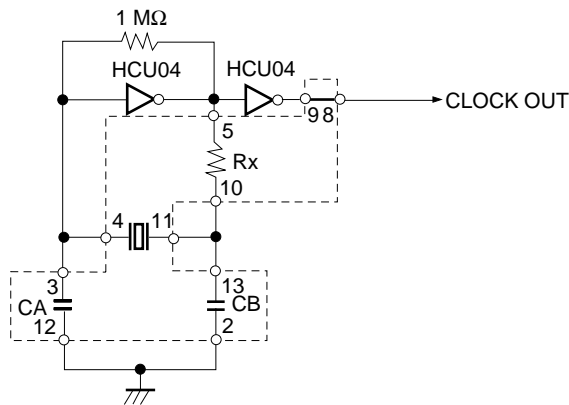

Remark The sections enclosed in broken lines indicate parts that are attached to the parts board.

- <2> Prepare the IE-784928-NS-EM1.
- <3> Remove the crystal oscillator that is mounted in the IE-784928-NS-EM1's socket (the socket marked as X1).
- <4> Connect the parts board (from <1> above) to the socket (X1) from which the crystal oscillator was removed. Check the pin 1 mark to make sure the board is mounted in the correct direction.
- <5> Make sure that the parts board mounted in the X1 socket on the emulation board is wired as shown in Figure 3-6 above.
- <6> Install the IE-784928-NS-EM1 in the IE-78K4-NS.

The above steps configure the following circuit and enable supply of the clock from the mounted resonator to the emulation device.

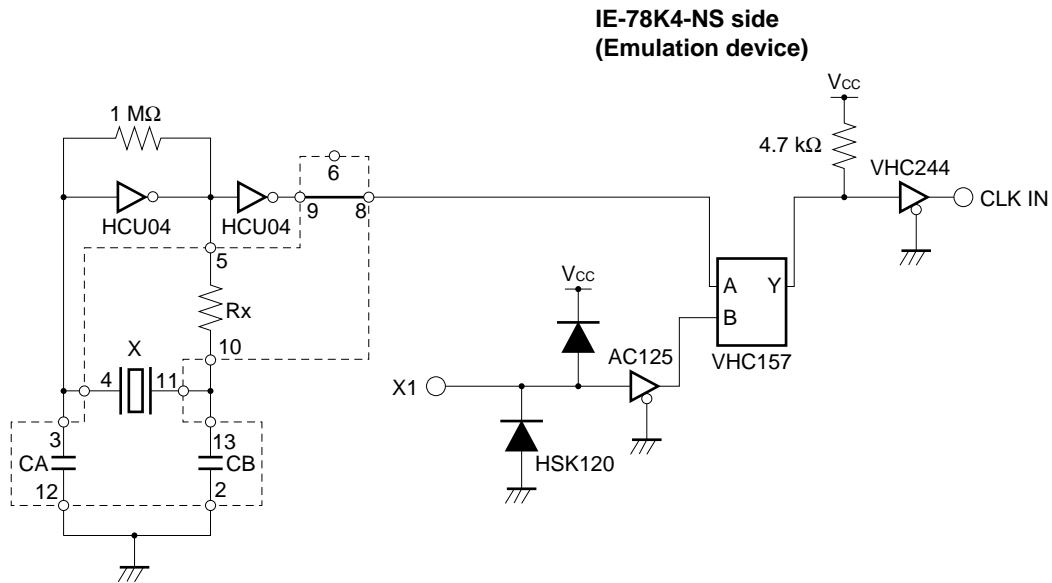

Remark The sections enclosed in broken lines indicate parts that are attached to the parts board.

(b) When using a crystal oscillator

- Items to be prepared
 - Crystal oscillator (see pinouts shown in Figure 3-7)

Figure 3-7. Crystal Oscillator (When Using Main System Clock or User-Mounted Clock)

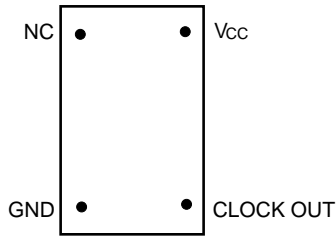

<Steps>

- <1> Prepare the IE-784928-NS-EM1.
- <2> Remove the crystal oscillator that is mounted in the IE-784928-NS-EM1's socket (the socket marked as X1).
- <3> Connect the crystal oscillator (from <2> above) to the socket (X1) from which the crystal oscillator was removed. Insert the crystal oscillator pin into the socket aligning the pins as shown in the figure below.

Figure 3-8. Pin Alignment of Crystal Oscillator and Socket

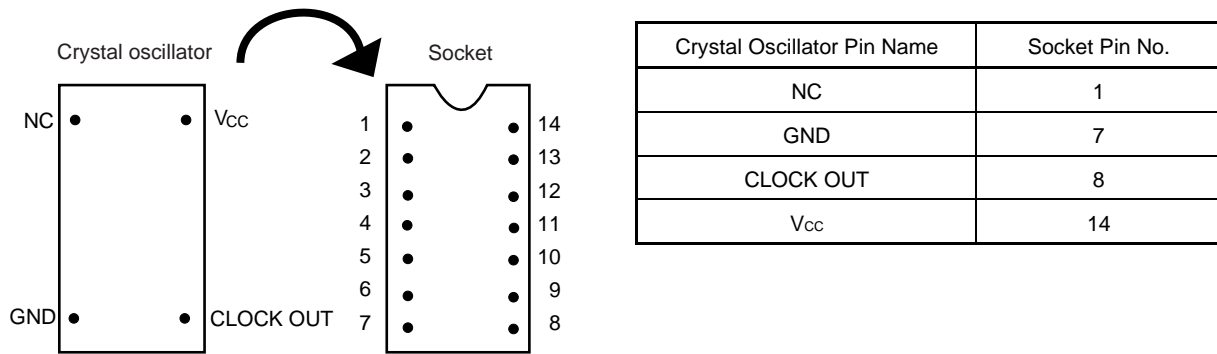

- <4> Install the IE-784928-NS-EM1 in the IE-78K4-NS.

The above steps configure the following circuit and enable supply of the clock from the mounted resonator to the emulation device.

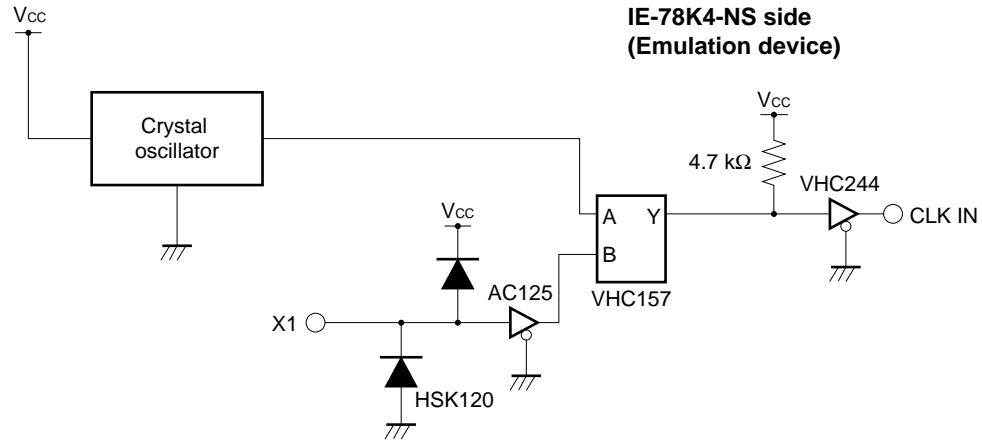

(3) When using external clock

No hardware settings are required for this situation.

When starting the integrated debugger (ID78K4-NS), open the configuration dialog box and select "External" in the area (Clock) for selecting the CPU's clock source (this selects the user's clock).

3.3.3 Subsystem clock settings

When the IE-784928-NS-EM1 is shipped, a 32.768-kHz crystal resonator is already mounted in the IE-784928-NS-EM1.

The system clock cannot be changed.

3.4 Pin Mask Function Settings

- **NMI interrupt mask setting**

By setting a switch (SW1) on the 4915NS CHIPSET, or 4928 CHIPSET in the IE-784928-NS-EM1, it is possible to mask the NMI interrupt, which is the alternate function of the P20 pin.

Table 3-2. Slide Switch Setting for NMI Interrupt Mask Function

Status	Slide Switch Setting
	SW1
No NMI mask (initial setting)	OFF
NMI masked	ON

Caution Because the NMI interrupt is the alternate function of the P02/INTP2 pin, this pin cannot operate as the P02/INTP2 pin when the NMI mask status has been set.

3.5 Low-Voltage Emulation Setting

Low-voltage emulation is possible in the IE system.

When the target system is operating on low voltage, supply the same voltage as the target system to the TP1 terminal pin of the IE-784928-NS-EM1 (this is unnecessary when TP1 is 5 V). Set the target voltage between 2.7 and 5 V.

- Maximum current consumption of TP1

5 V	300 mA
⋮	⋮
2.7 V	150 mA

3.6 External Trigger

To set up an external trigger, connect it to the IE-784928-NS-EM1's check pin, EXTOUT pin, and EXTIN pin as shown below.

See the integrated debugger (ID-78K4-NS) User's Manual (U12796E) for descriptions of related use methods and pin characteristics.

Figure 3-9. External Trigger Input Position

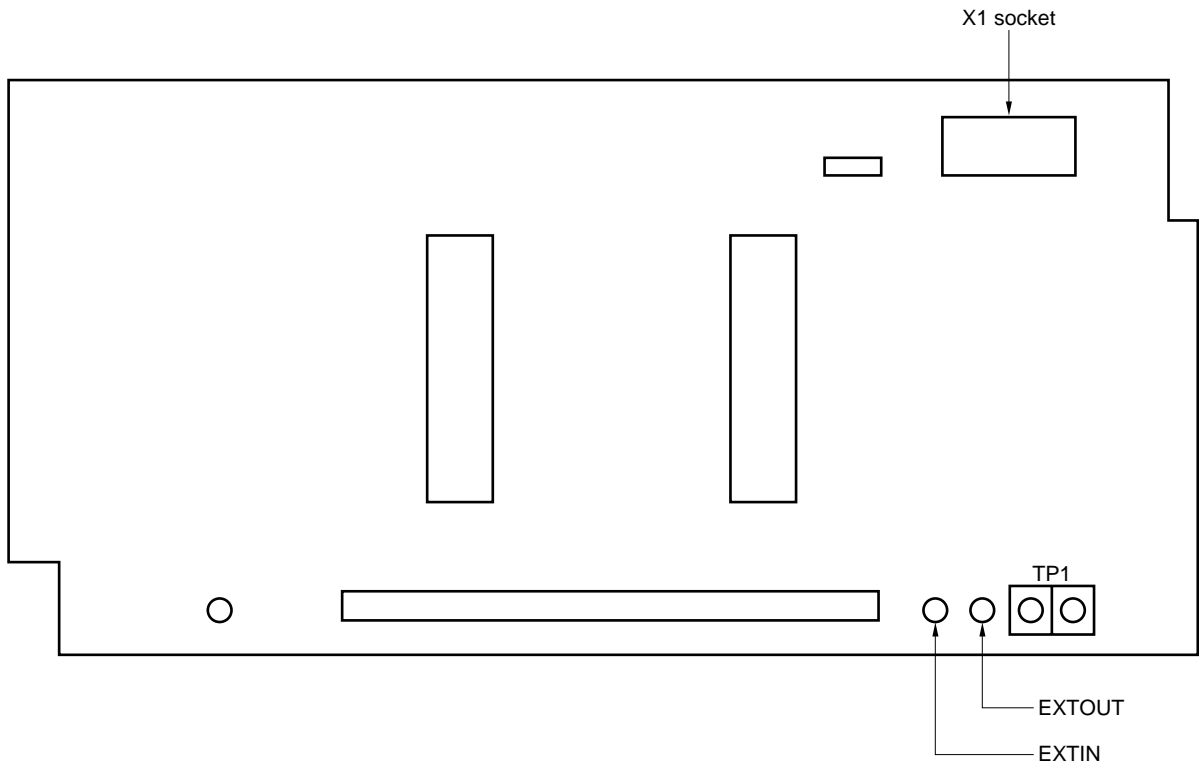

[MEMO]

CHAPTER 4 EMULATION PROBE (EP-784928GF-NS)

When using the IE-784928-NS-EM1 connected to the target system, a dedicated emulation probe (EP-784928GF-NS: sold separately) is needed.

Using the EP-784928GF-NS for connection enables debugging of the hardware and software of the target system in which the μ PD784915, μ PD784928, or μ PD784928Y Subseries are employed. For connection details, refer to **4.2 Connection Procedure**.

4.1 Configuration of EP-784928GF-NS

The configuration of the EP-784928GF-NS is described below.

- EP-784928GF-NS
- Probe tip board (DUMMY BOARD): 4915 YQ PACK PKG (100GF)
- Probe tip board (DUMMY BOARD): 4928 GC DUMMY (100GC)
- Conversion socket: NEV921GF-100
- Conversion socket: TGC-100SDW

Caution Chipset boards are not included with the EP-784928GF-NS, so use the 4915 NS CHIPSET and 4928 CHIPSET included with the IE-784928-NS-EM1.

Figure 4-1. EP-784928GF-NS Configuration Diagram

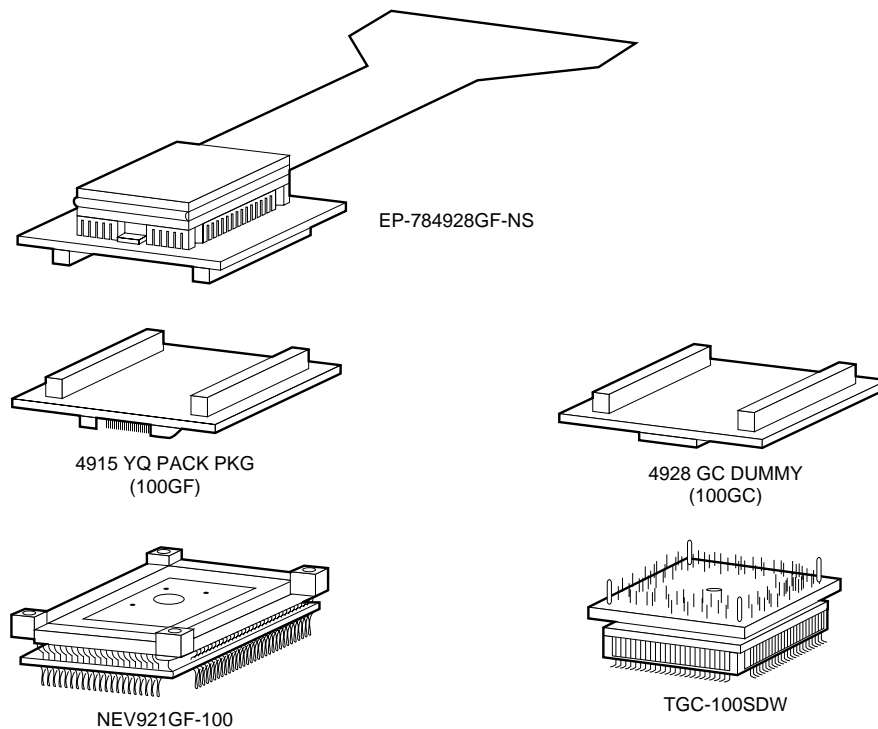

4.2 Connection Procedure

4.2.1 Emulation probe and target system connection (when using the 100-pin GF package)

- (1) Solder the accompanying conversion socket (NEV921GF-100) to the target system.
- (2) Connect the 4915 YQ PACK PKG (DUMMY BOARD) to the soldered conversion socket (NEV921GF-100), and fix with screws.
- (3) Plug the emulation probe tip into the 4915 YQ PACK PKG (DUMMY BOARD).

Figure 4-2. Emulation Probe and Target System Connection (When Using the 100-Pin GF Package)

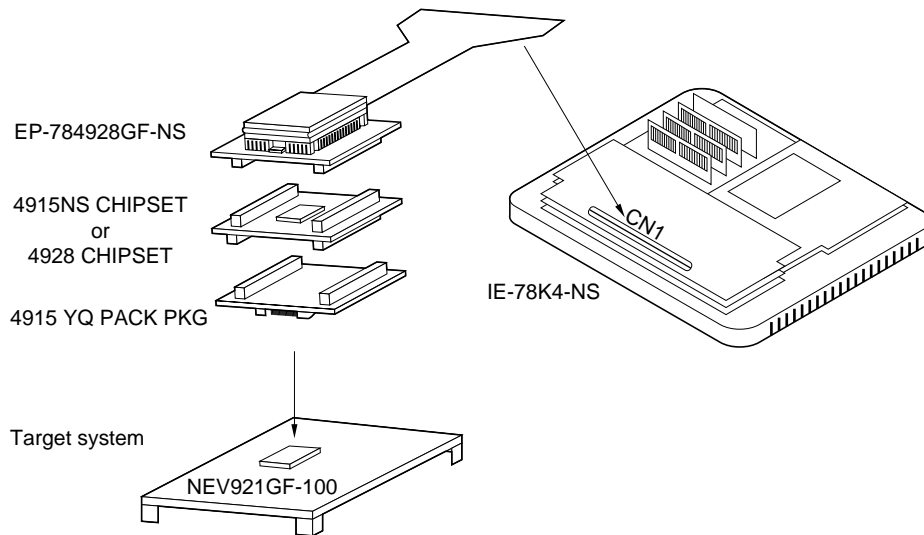

4.2.2 Emulation probe and target system connection (when using the 100-pin GC package)

- (1) Solder the accompanying conversion socket (TGC-100SDW) to the target system.
- (2) Connect the 4928 GC DUMMY (DUMMY BOARD) to the soldered conversion socket (TGC-100SDW), and fix with screws.
- (3) Plug the emulation probe tip into the 4928 GC DUMMY (DUMMY BOARD).

Figure 4-3. EP-784928GF-NS and Target System Connection (When Using the 100-Pin GC Package)

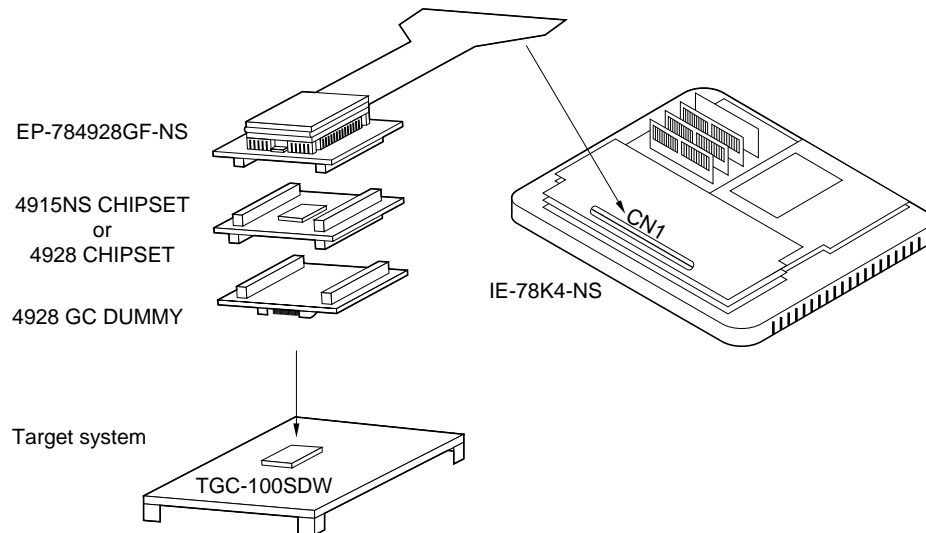

[MEMO]

CHAPTER 5 DIFFERENCES BETWEEN TARGET DEVICES AND TARGET INTERFACE CIRCUITS

This chapter describes differences between the target device's signal lines and the signal lines of the IE-784928-NS-EM1's target interface circuit.

Although the target device is a CMOS circuit, the IE-784928-NS-EM1's target interface circuit consists of an emulation CPU, TTL, CMOS-IC, and other emulation circuits.

When the IE system is connected with the target system for debugging, the IE system performs emulation so as to operate as the actual target device would operate in the target system.

However, some minor differences exist since the operations are performed via the IE system's emulation.

- (1) Signals directly input/output to/from the emulation CPU
- (2) Signals input from the target system via a gate
- (3) Other signals

The IE system's circuit is used as follows for signals listed in (1) to (3) above.

(1) Signals directly input/output to/from the emulation CPU

The following signals perform the same operations as in the μ PD784915, 784928 Subseries. For the signals related to ports 0, 4, and 5, a 22- Ω resistor is inserted in series. The NMI performs mask control by means of SW1 on the chipset board.

- Signals related to port 0
- Signals related to port 4
- Signals related to port 5
- Signals related to port 6
- Signals related to port 7 (A/D converter input)
- Signals related to port 8
- Signals related to port 9
- Signals related to external input (INTP0 to INTP2)
- Signals related to timer output (PT00 to PT02)
- Signals related to serial communication ($\overline{\text{SCK2}}$, SO2, SI2/BUSY)
- Signals related to A/D converter (ANI08 to ANI11)
- NMI

Figure 5-1. Equivalent Circuit 1 of Emulation Circuit

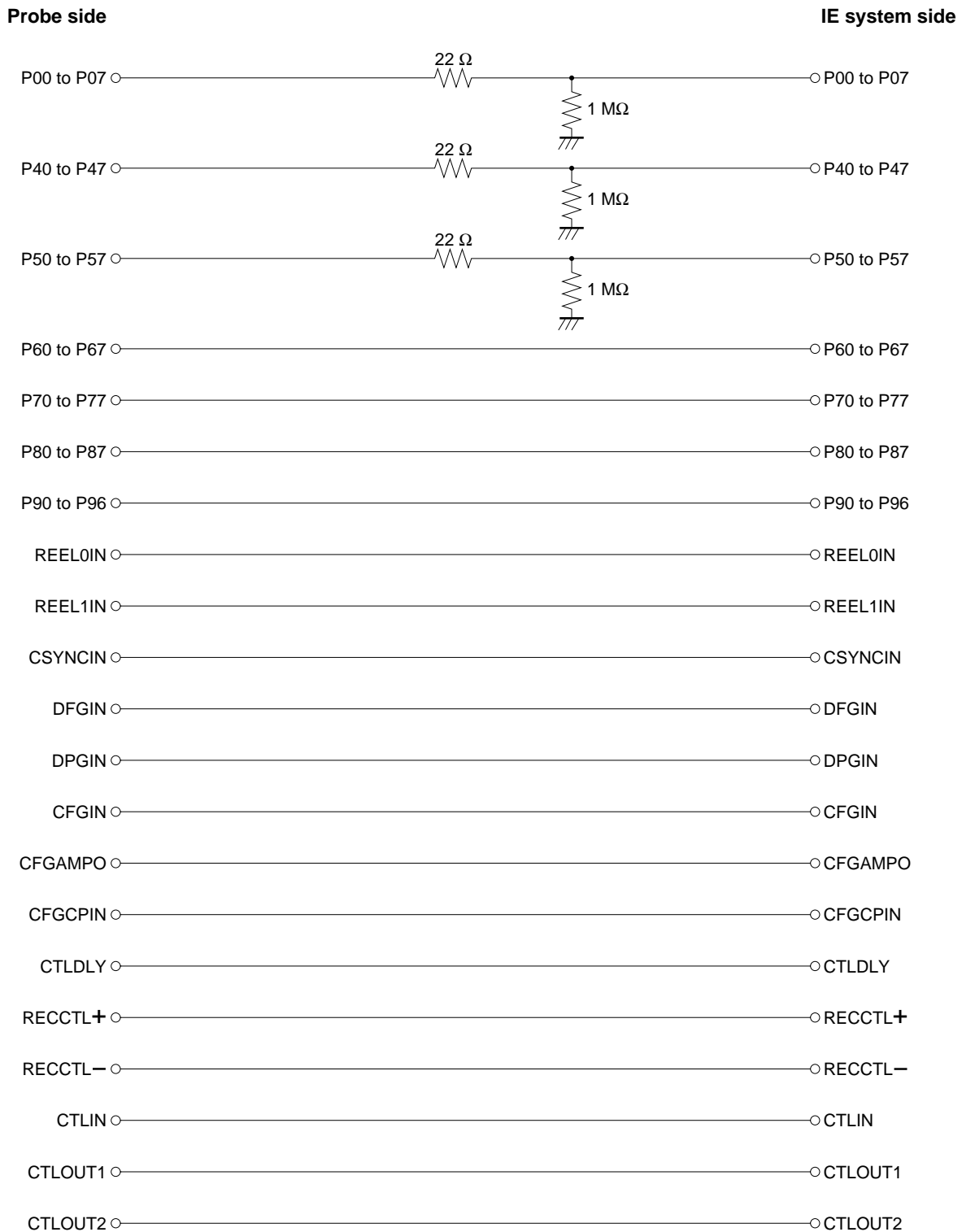
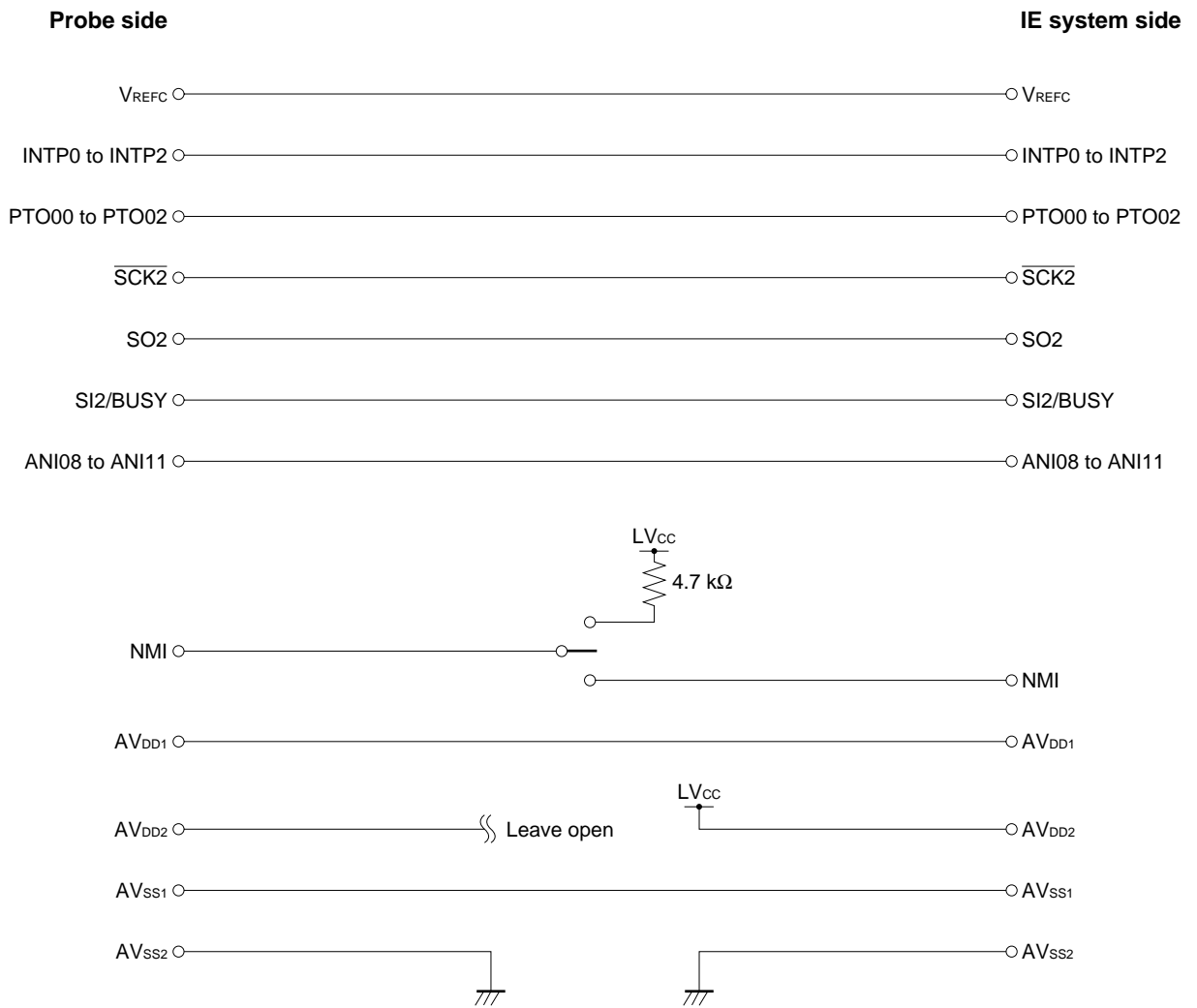

Figure 5-2. Equivalent Circuit 2 of Emulation Circuit



(2) Signals input from the target system via a gate

Since the following signals are input via a gate, their timing shows a delay compared to that of the μ PD784915, 784928 Subseries. Their AC characteristics and DC characteristics are therefore different from the μ PD784928 Subseries, making it necessary to observe a stricter timing design than in the case of the μ PD784915, 784928 Subseries.

- PWM0, PWM1
- $\overline{\text{RESET}}$ signal

Figure 5-3. Equivalent Circuit 3 of Emulation Circuit

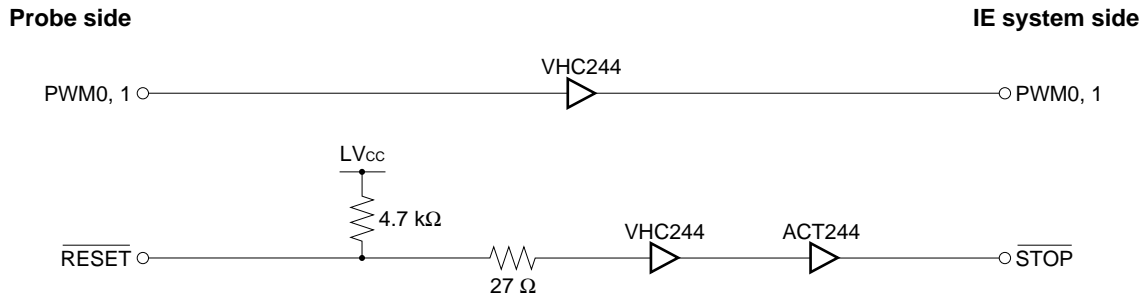
**(3) Other signals**

- V_{DD} pin

When the emulation CPU is operating at 5 V, its power is supplied from the internal IE system, but when operating at low voltage, its power is supplied from the low-voltage pin (TP1). The V_{DD} pin of the target system is only used to control the LED (USERV_{DD}) in the IE system that monitors the input of the target system's power supply.

- V_{SS} pin

The V_{SS} pin is connected to GND inside the IE system.

[MEMO]

[MEMO]

Facsimile Message

Although NEC has taken all possible steps to ensure that the documentation supplied to our customers is complete, bug free and up-to-date, we readily accept that errors may occur. Despite all the care and precautions we've taken, you may encounter problems in the documentation. Please complete this form whenever you'd like to report errors or suggest improvements to us.

From:

Name

Company

Tel.

FAX

Address

Thank you for your kind support.

North America

NEC Electronics Inc.
Corporate Communications Dept.
Fax: 1-800-729-9288
1-408-588-6130

Hong Kong, Philippines, Oceania

NEC Electronics Hong Kong Ltd.
Fax: +852-2886-9022/9044

Asian Nations except Philippines

NEC Electronics Singapore Pte. Ltd.
Fax: +65-250-3583

Europe

NEC Electronics (Europe) GmbH
Technical Documentation Dept.
Fax: +49-211-6503-274

Korea

NEC Electronics Hong Kong Ltd.
Seoul Branch
Fax: 02-528-4411

Japan

NEC Semiconductor Technical Hotline
Fax: 044-548-7900

South America

NEC do Brasil S.A.
Fax: +55-11-6465-6829

Taiwan

NEC Electronics Taiwan Ltd.
Fax: 02-2719-5951

I would like to report the following error/make the following suggestion:

Document title: _____

Document number: _____ Page number: _____

If possible, please fax the referenced page or drawing.

Document Rating	Excellent	Good	Acceptable	Poor
Clarity	<input type="checkbox"/>	<input type="checkbox"/>	<input type="checkbox"/>	<input type="checkbox"/>
Technical Accuracy	<input type="checkbox"/>	<input type="checkbox"/>	<input type="checkbox"/>	<input type="checkbox"/>
Organization	<input type="checkbox"/>	<input type="checkbox"/>	<input type="checkbox"/>	<input type="checkbox"/>