

The Radio-Kits Digital SWR meter kit

Construction and user manual

Author - Steve Drury G6ALU

List of contents

Section	Page no.
1. Features and specifications	2
2. Introduction	2
3. Construction	3
4. General construction practice	3
5. Component placement	3
6. Initial testing	7
7. Testing and calibration	8
8. Boxing up	9
9. Component Identification	11
10. Fault finding	12
11. Block diagram and circuit description	-
12. Circuit diagram	14
13. Operating instructions	16
14. PCB overlay	17
15. Change log	18

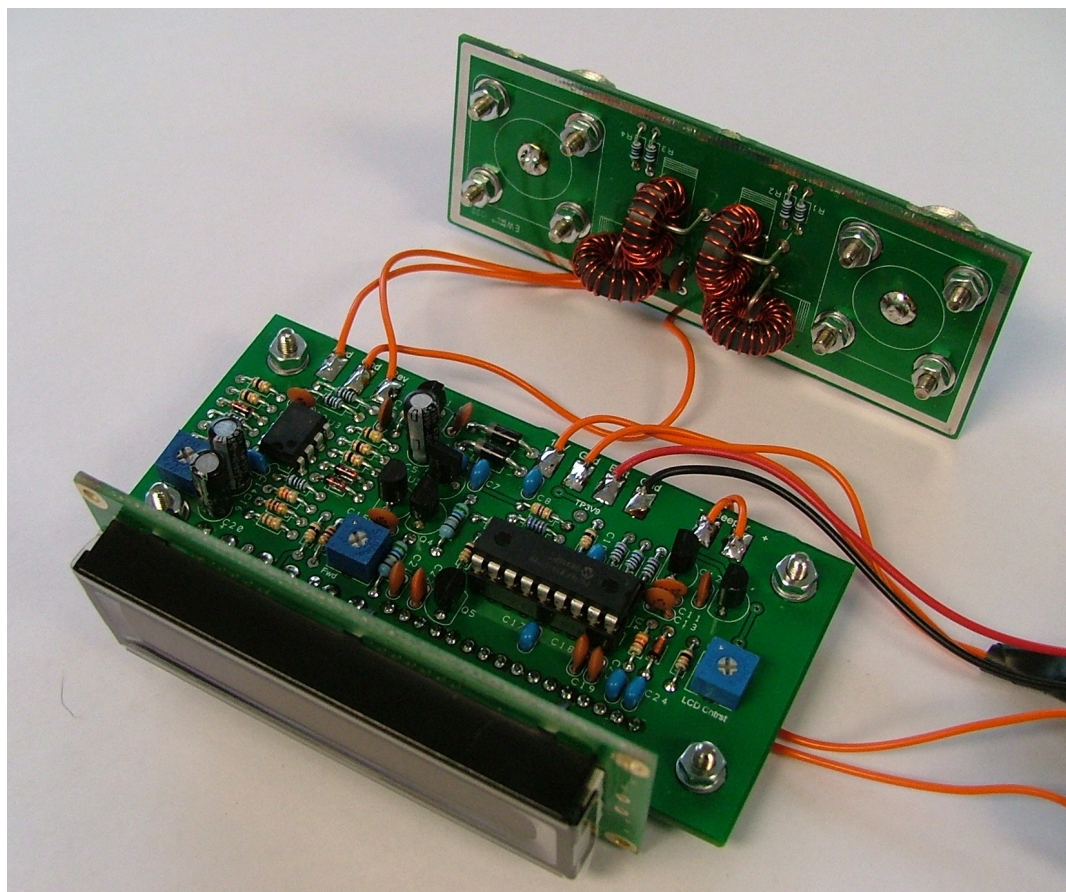

Features

- Displays SWR, forward power, reverse power and supply voltage
- Peak reading power meter
- Bar graph or numerical format
- Reverse power alarm with adjustable threshold
- Auto turn on in presence of RF – sensitivity about 1 Watt
- Optional turn off after preset time – 10-240 Seconds
- Backlit LCD display with variable brightness
- Reverse polarity protection

Typical Specifications (13.8V supply)

Power handling	-	QRP – > 100W
Operating frequency	-	HF (1.8 – 30MHz)
Supply voltage	-	7 – 16V
Current consumption	-	About 28mA but depending on supply voltage and backlight level
Through loss	-	0.2dB typical (small signal)

Introduction

An SWR meter is an essential requirement for any radio shack; this is a design for a general-purpose instrument that will read SWR and power. Being digital it is easy to incorporate several functions that are not only useful but in the case of the reverse power alarm could avoid an expensive repair bill.

For input power below about 20W the unit can be powered from a PP3 type battery, for >20W a power source of 13.8V will be required as the op. amp needs this to achieve the required output voltage swing.

Two backlit display options are offered; the first is grey writing on a yellow / green background the other is white writing on a deep blue background; note the backlight must be functional to see characters on the blue version.

The detector “head” has been designed as a separate PCB allowing it to be remote mounted if required, alternatively it may be mounted in the same box as the display PCB. Provision has been made to fit a screen over the back of the transformers; this will allow the detector PCB to be placed in close proximity to the display board without interaction.

Construction

These instructions have been targeted at those with some construction experience and who can identify the different components. Where out of the ordinary parts have been used a short description follows the component value.

All components except for the display, its socket and tact (short for tactile) switches are mounted on the component side of the board. The PCB silk-screen gives the component locations; in cases where this is difficult to read please refer to the printed overlay that is larger than actual size. Note that components are numbered from left to right then top to bottom of the board. If you have difficulty in locating a component position place a straight edge across the overlay and look along its length, in this way components will be easy to locate.

The PCB has been designed to accommodate the components supplied so if it doesn't easily fit ask yourself if it belongs there!

General construction practice

Leaded or lead-free cored solder may be used, the solder must be designed for electronics – do not use plumbers solder or additional flux as the flux is very corrosive. I use 22SWG (0.7mm) multi-core type solder that seems most suitable for this type of work. A double sided plated through hole (PTH) PCB has been used which provides screening and allows for a small design; however incorrectly fitted components can be very difficult to remove so it's important to fit them in the right place first time! If a component is inadvertently fitted incorrectly it is easiest to cut off its leads, apply the soldering iron and pull them out from the topside. A small solder sucker or de-solder braid can be used to clear the holes out ready for a replacement component to be fitted. When soldering the component leads it will

be noticed that the solder “wicks” up the hole through to the top surface, this is normal.

For a start place just a few components in place before soldering them, as experience grows you may find it more productive to fit a larger number at a time. As *each* component is fitted put a mark in the box provided, it's very easy to forget the last component fitted especially if you are distracted. If you make use of the component overlay you will find it helpful if components are highlighted as they are fitted. Components are taken from one bag at a time keeping the others sealed. Everyone has their preferred method of retaining components prior to soldering; I pull the leads through with long nose pliers and put a bend in the component lead to stop it falling out of the board. A good policy is not to crop leads until they have been soldered, this should stop you from missing any soldered joints. Only crop **ONE** lead at a time, by cropping several leads its possible to “crack” pads off the print which can be a very difficult fault to find.

Note that if cleaning the PCB with solvents make sure it doesn't enter the preset resistors or they may get contaminated and fail when adjusted.

Where possible fit the components so their values are easily readable. Some components **MUST** be fitted in the correct orientation as they are polarised; this will be indicated in the text.

The components are packed in four bags; each bag contains a list of contents that will show any substitutions that have been made.

Component placement

Both detector and main PCBs are supplied as one panel, it is suggested to leave these as a single panel until PCB construction is completed.

From bag 1 fit the following components:

Resistors are identified by four or five colour bands; if in doubt use a multi-meter to confirm their value.

Positions L1 and L2 have resistors fitted.

100R 1% Resistor (Brown, Black, Black, Black, Brown)							
R1		R2		R3		R4	
R21		L1		L2			

10k Resistor (Brown, Black, Orange, Gold)							
R5		R6		R7		R9	
R17		R19		R22		R24	

100k Resistor (Brown, Black, Yellow, Gold)							
R8							

1k Resistor (Brown, Black, Red, Gold)							
R28		R30					

27k 1% Resistor (Red, Violet, Black, Red, Brown)							
R11							

8K2 1% (Grey, Red, Black, Brown, Brown)							
R13		R15					

470R (Yellow, Violet, Brown, Gold)							
R10							

4k7 1% (Yellow, Violet, Black, Brown, Brown)							
R14							

220R Resistor (Red, Red, Brown, Gold)							
R18		R32					

3k3 Resistor (Orange, Orange, Red, Gold)							
R20		R23		R27		R34	
						R35	

18k Resistor (Brown, Grey, Orange, Gold)							
R33							

10k Preset resistor (Marked 103)							
R25							

1k Preset resistor (Marked 102)							
R26		R31					

10nF Capacitor (Marked 103)							
C1		C2		C3		C4	
C12		C13		C15		C18	
C21							

100nF Capacitor (Marked 104)							
C6		C7		C8		C10	
C17		C23		C24			

1nF Capacitor (marked 102)							
C11		C22					

Diodes are polarised devices so can only be fitted one way round, match the band on one end of the encapsulation with the bar printed on the PCB.

BAT85 Diode (Small glass diodes)							
D1		D2		D5		D6	D7
D8		D9					

1N4001 Diode		
D3		D4

From bag 2 fit the following components:

Transistors should be fitted so their outline matches that printed on the PCB, their type number is marked in small lettering on the flat surface. Don't confuse transistors (prefix Q) with ICs prefix U).

BC327 Transistor	
Q1	

BC547B Transistor			
Q2		Q3	Q4

BC337 Transistor	
Q5	

U1 and U2 have 3 legs and look like similar to the transistors.

TL431CLP Integrated Circuit	
U1	

78L05 Integrated circuit	
U2	

U3, Ensure the notch is aligned with that printed on the PCB

LM358 Integrated Circuit	
U3	

Fit the socket as indicated on PCB overlay

18 Pin socket in position U4	
U4	

Electrolytic capacitors are polarised so may only be fitted one way round. By convention the PCB is marked with a + symbol, the + lead of a capacitor is longest; the capacitor sleeve is also normally marked -. Fit the capacitors against the PCB with zero lead length but don't put excessive force on the leads as this can make the electrolyte leak out.

1uF 63V Electrolytic capacitor		
C16		C20

47uF 25V Electrolytic capacitor	
C5	

The display socket is fitted from the underside of the PCB and soldered on the topside. Hold it flat to the PCB whilst soldering.

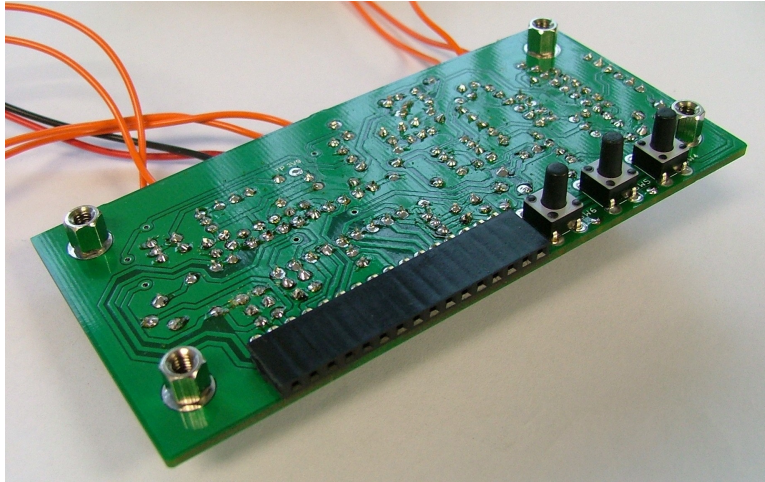

16 pin 90° inline socket	
Disp	<input type="checkbox"/>

The tact switches are fitted from the underside of the PCB and soldered to the top.

Tact switch			
SW4	<input type="checkbox"/>	SW5	<input type="checkbox"/>
SW6	<input type="checkbox"/>		<input type="checkbox"/>

T1 to T4 are wound on toroid cores, T2 is wound in the opposite direction to T1, T3 and T4; see sketch below. The ident for these transformers isn't marked on the PCB, use the overlay to identify their positions.

Cut approximately 500mm of 27SWG enameled copper wire and wind 23 turns around a FT50-61 toroidal core, every time the wire passes through the center of the core counts as a turn. Clean the enamel from the ends of wire and "tin" with the soldering iron.

Note that for correct operation it is important that exactly 23 turns are wound through the toroid – to be clear, the wire is passed through the toroid centre 23 times.

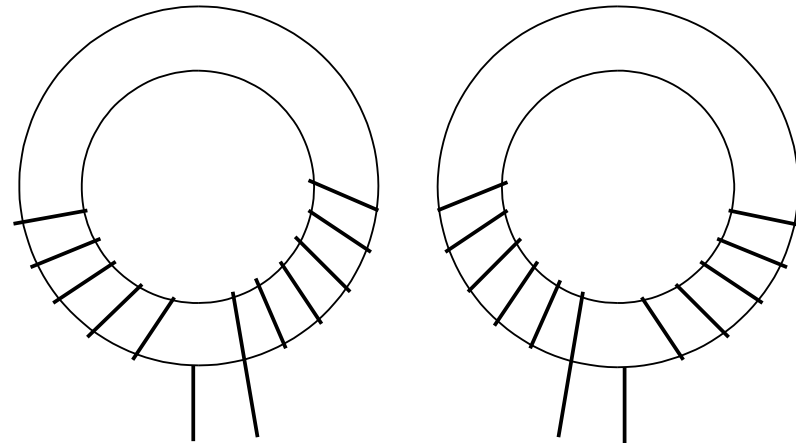

T1, T3 and T4

T2

For clarity these sketches show a reduced number of turns.

PHOTO SHOWING TINNED LEADS.

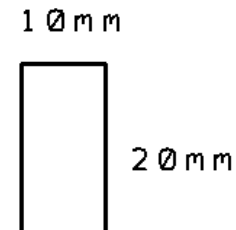

Cut 50mm from the 20SWG tinned copper wire and bend into a "hairpin" similar to the sketch – note the 10mm dimension is internal but in any case isn't critical.

Pass the hairpin through the center of the toroid and solder all 4 wires to the PCB, make sure the hairpin passes exactly through the center of the toroid; see photo. Fit the toroid so the windings are about 1mm from the PCB.

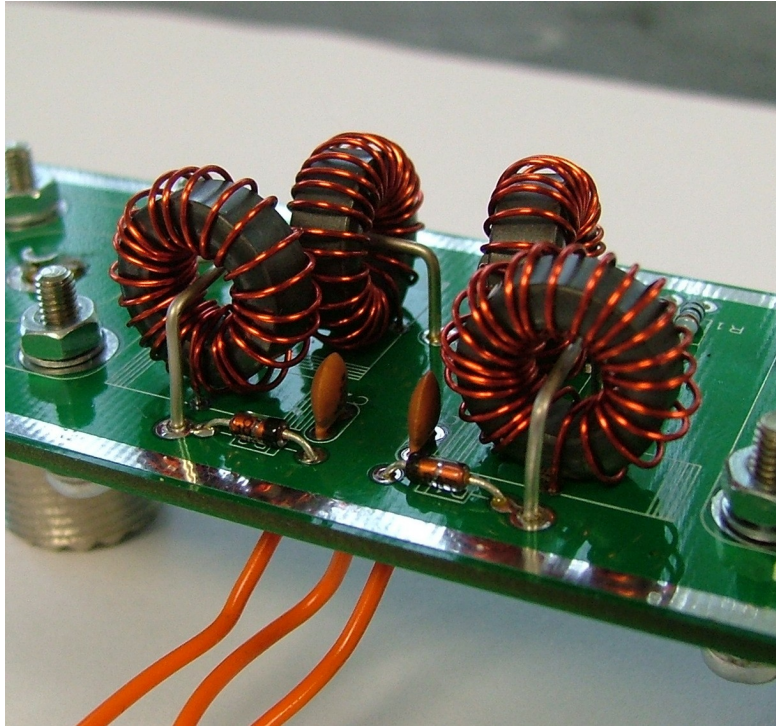

FT50-61 23T of 27SWG Enameled wire				
T1		T3		T4

FT50-61 23T of 27SWG Enameled wire	
T2	

The following components are fitted from bag 3.
Solder the battery connector to pads marked “Batt” and “Gnd” on PCB.

PP3 Battrey connector	
SK5	

Initial testing

Before connecting power make a careful inspection of soldered joints especially for any solder splashes etc. At this point the micro-controller and display should not be fitted as wrong voltages applied to their pins will cause damage. Measure between supply positive and ground with a multi-meter on Ohms range to ensure there is not a short circuit

For safety it's suggested to power the unit by battery during initial testing.

Connect the battery; whilst pressing the power switch (left most button viewed from the front) measure the voltage on pin 14 of U4 (PIC16F819), this should read about 5V. If significantly different investigate the cause before proceeding.

Disconnect the battery.

Fit the 16 way header plug from the back of the display and solder on the front side. Solder one pin first and check that the pins are square to the display PCB before soldering the remaining pins.

16 Pin Header	
PL1	

Fit the microcontroller, note that pin one end is identified by a notch on the socket; refer to PCB overlay.

PIC16F819 I/P Integrated Circuit	
U4	

Fit 4 hex spacers to the main PCB; pass the threads through PCB from the switch side and secure on the component side with a shake-proof washer and nut.

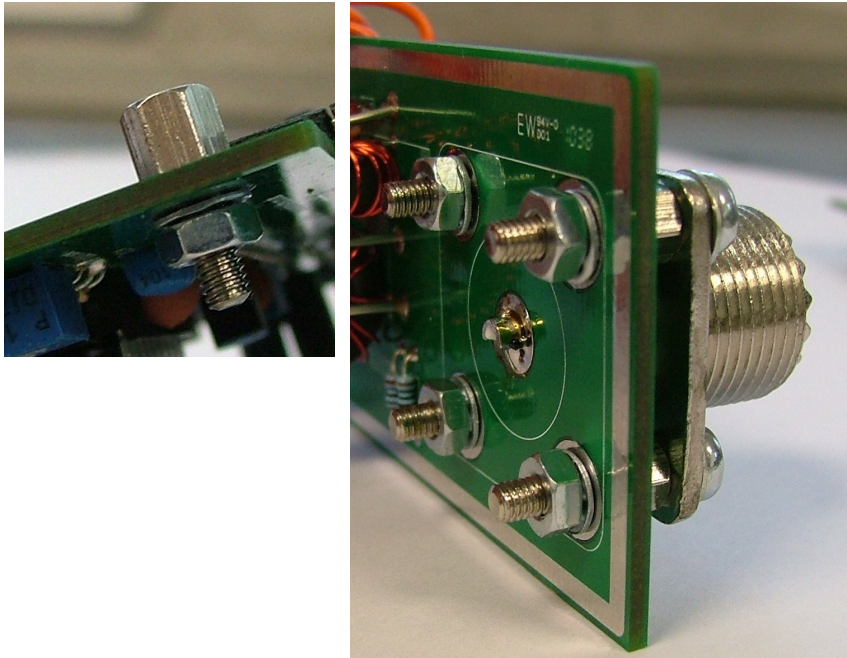

Fit the 8 hex spacers to detector PCB in RF socket fixing positions, note that the thread passes through the PCB and is fixed by a nut and shake-proof washer on the component side of board. Only tighten them “finger” tight at this stage. Temporarily hold the RF connectors in place with 3mm screws and solder the center terminal on the component side of the PCB, straighten the connectors and tighten the 8 fixing nuts.

S0239 RF Socket			
SK1	SK2		

Plug the display into the 90° socket, see photo.

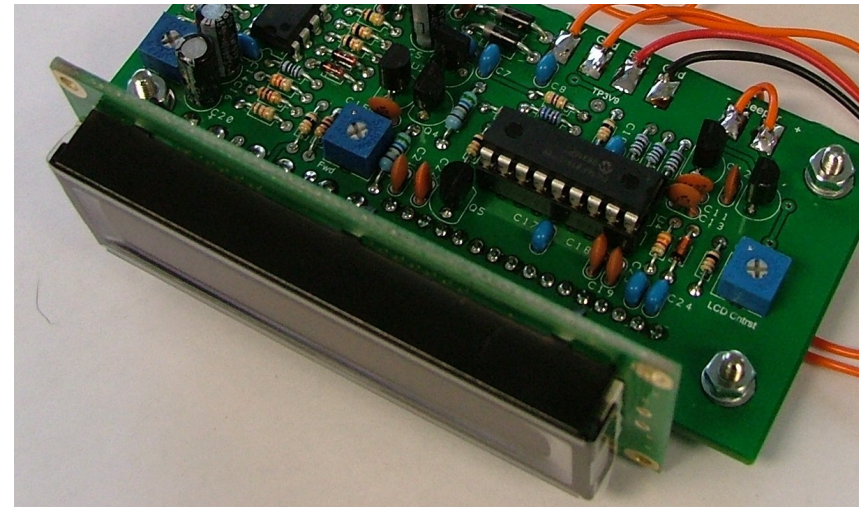

Using 3 short pieces of hook up wire connect the detector PCB with the main board: Connect points RE to REV, GND to GND and FWD to FWD.

Testing and calibration

- Turn R25 (LCD) contrast fully clockwise.
- Turn R26 and R31 (forward and reverse adjust) fully counterclockwise.
- Reconnect the battery.
- Press the power button; the meter should now power up and will probably show 16 squares.
- Adjust R25 anti clockwise until the display shows correct contrast.

It's possible to make a reasonable calibration using the internal voltage reference.

- Connect together pads REV, FWD and TP3V9 (detector PCB may be left connected).
- Power up and using the push buttons select FWD on the display top line and REV on bottom line (see operating instructions).
- Adjust R26 and R31 clockwise to set forward power to read 23.1 Watts.
- **Note:** With REV and FWD connected to TP3V9 it will not be possible to turn the unit off using the Menu button – power down before disconnecting the links by removing the power source.

Check that the meter is functioning correctly either by fitting between a transmitter and dummy load or transmitter and antenna.

If a known accurate power meter is available it can be placed in line with the transmitter, this meter and a dummy load. Using moderate power (20 – 50W) adjust the forward power reading to match that of the reference meter, reverse power is adjusted by reversing the meters connections.

Whilst making these adjustment make sure the auto power off feature is switched off (default setting).

Boxing up

The meter hasn't been designed to fit any particular enclosure; the choice is left to the constructor.

As previously mentioned the detector head can be used remote of the meter, interconnections should be made by screened cable and can either be permanently fixed or plugged; a standard 3 or 5 pin DIN type plug is suitable. The meter enclosure (and that for the detector) should be metallic to stop any unwanted noise pickup or radiation.

A template has been provided to help with drilling case holes accurately.

Print out the drilling template and confirm the size is correct by measuring the printed dimensions, they should be printed with “Page scaling” set to none in the print menu.

Stick the drilling templates to the outside of the case aligning the reference edges with the INSIDE surfaces of the box, this is important; for the templates to be universal no account has been made for case thickness, instructions are printed on the templates. Drill all holes to the sizes indicated on the template, use good engineering practice; start with a small drill and work up in size.

The template doesn't include positions for the DC connector or alarm sounder, find suitable positions for these before drilling any holes! The volume of the sounder can be adjusted by varying the outlet hole; start with a small one (2mm suggested), it can be enlarged if necessary. The DC socket requires a 8mm hole.

To cut the display I would recommend drilling many holes close to each other just on the inside of the window then using a pair of side cutters join them up. The window can then be squared up using a file.

Fit the main PCB to case, it is secured by 4 M3 x 6mm screws with flat washers under the heads.

Fit the detector PCB to case using 8 M3 screws and plain washers, refer to photo.

Fit the power socket and wire to the PCB; the center contact is the + terminal.

2.1mm DC socket	
SK3	

The sounder is “glued” to the inside of the case using superglue™ or similar, using hookup wire connect to the pads on PCB noting the polarity.

Piezo Sounder	
SK3	

I have catered for two methods of fitting a front panel; with a little thought I’m sure there are many more. For those wanting to design their own front panel critical hole dimensions and spacing are given on the drilling template.

1. A PDF file of a front panel is provided, this may be printed and glued (double sided tape perhaps) to the front and then covered with a sheet of acetate / overhead projector film trapped under the four fixings screws.
2. A negative image is provided, this can be printed on to acetate or a bubble jet transparency, by reversing the image the non-printed side is nearest the user so protecting the writing.

The builder is encouraged to personalise the front to his or her own taste to add some individuality.

Component identification

Components have been packed in to 4 bags, the contents of these bags and order of assembly have carefully been chosen so similar components shouldn't become confused.

For fault finding it will be necessary to correctly identify components and their values after the radio has been built; methods of marking component values are given.

Capacitors

The ceramic capacitors used in this kit are marked numerically, based in Pico farads. The first two digits are the value and the third is the multiplier, for example 1nF (1000pF) is marked 102 (1, 0 and two zeroes), 10nF is marked 103 (1, 0 and three zeros).

Electrolytic capacitors are marked directly with their value.

Resistors

Values on all the resistors in this kit use a colour code to indicate value.

Several resistors are 1% tolerance types and are therefore marked with 5 coloured bands; all other types have standard 4 band markings.

Colour	Value	Tolerance
Black	0 ×1	
Brown	1 ×10	1%
Red	2 ×100	2%
Orange	3 ×1000	
Yellow	4 ×10000	
Green	5 ×100000	
Blue	6 ×1000000	
Violet	7	
Grey	8	
White	9	
Silver	Divide by 100	10%
Gold	Divide by 10	5%

Examples:

1kΩ 5% (1000Ω) = Brown (1) Black (0) Red (×100) Gold (5% tolerance)

2R2 5% (2.2Ω) = Red (2) Red (2) Gold (divide by 10) Gold (5% tolerance)

Note that 1000Ω = 1k, 1000000Ω = 1M, 2K2 = 2200Ω, 2R2 = 2.2Ω etc.

Diodes

All diodes used are axial and have their cathode end marked by a "band" on the encapsulation.

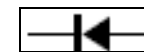
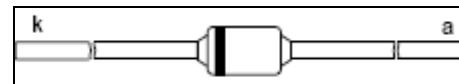

Values are marked on the bodies although for the small glass diodes (BAT85) they will be hard to read without a magnifying glass.

Transistors and Ics

TO92 and terminal identification			
Component	Lead identification		
	1	2	3
BC327	Emitter	Base	Collector
BC337	Emitter	Base	Collector
BC547	Emitter	Base	Collector
78L05	Input	Gnd	Output
TL431CLP	Cathode	Gnd	Reference

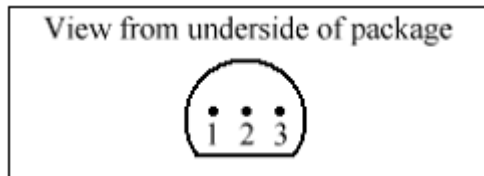
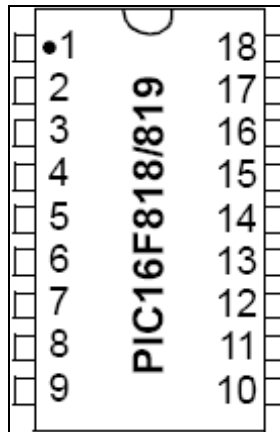

LM386 is similar to PIC16F819 but only has 8 pins.

Fault finding

Most faults are due to poor soldered connections or components misplaced; it is very rare to be supplied with a faulty component. Before making any measurements look carefully for any poor soldered joints, short circuits or incorrectly fitted components.

Should fault finding be necessary a table of voltages is given below, voltages were measured with both inputs from the bridge connected to TP3V9.

Voltage tables

Transistor	Emitter	Base	Collector
Q1	13	12.3	13
Q2	0	0	5
Q3	0	0.6	0
Q4	0	0.7	0
Q5	0	0.7	0.1

IC	Pin Number									
	1	2	3	4	5	6	7	8		
U1	3.9	0	2.49							
U2	13.1	0	5							
U3	4.4	3.9	3.9	0	3.9	3.9	4.4	13.1		
U4	Pin Number									
	1	2	3	4	5	6	7	8	9	
	0.16	3.9	3	0	0	0	0	5	5	
	Pin Number									
	10	11	12	13	14	15	16	17	18	
	5	5	5	5	5	5	5	5	1.3	1.3

Block diagram and circuit description

To Follow

Note: R18 and R32 now 220R for all display types

Circuit Diagram

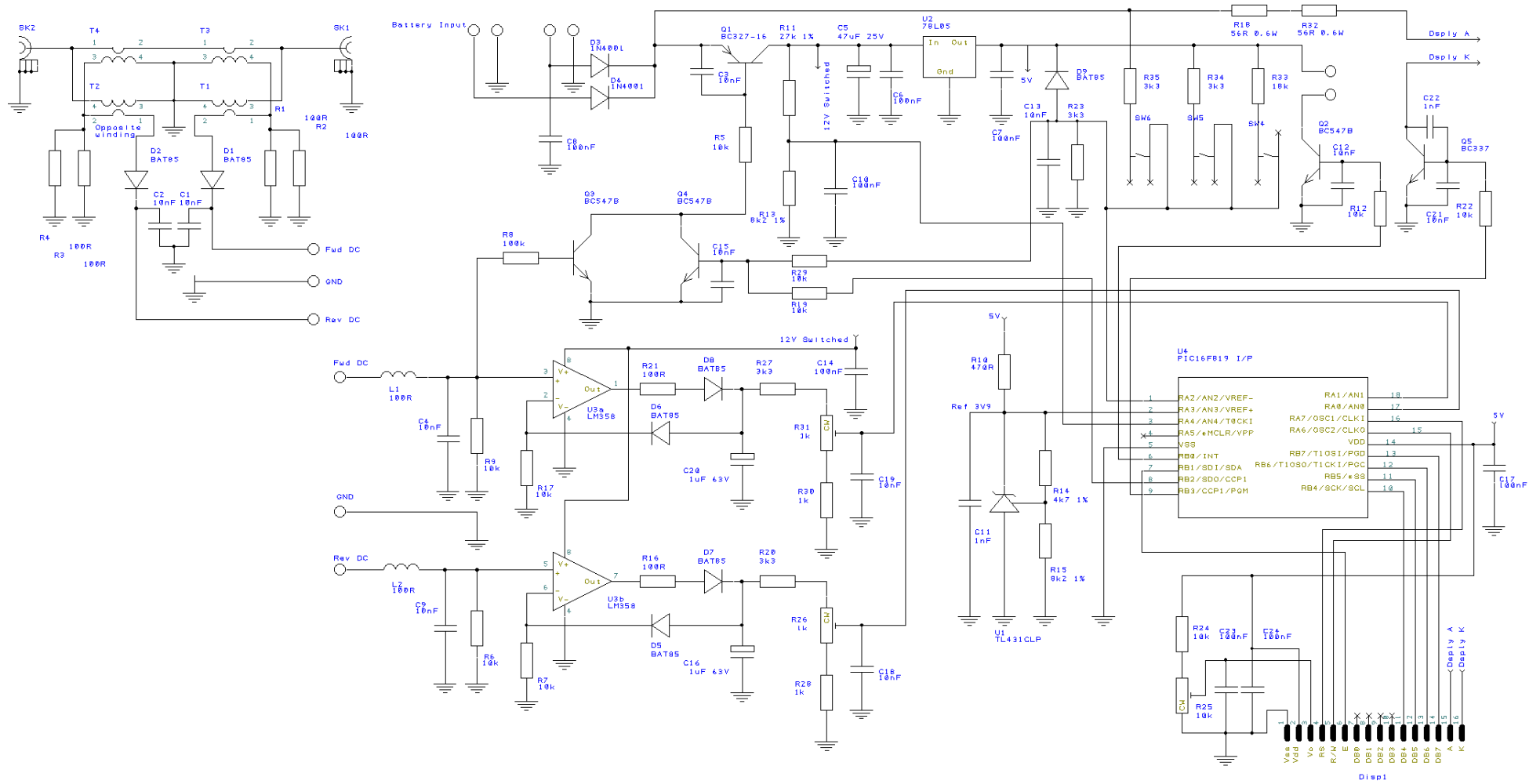

Note: R18 and R32 now 220R for all display types

PCB overlay

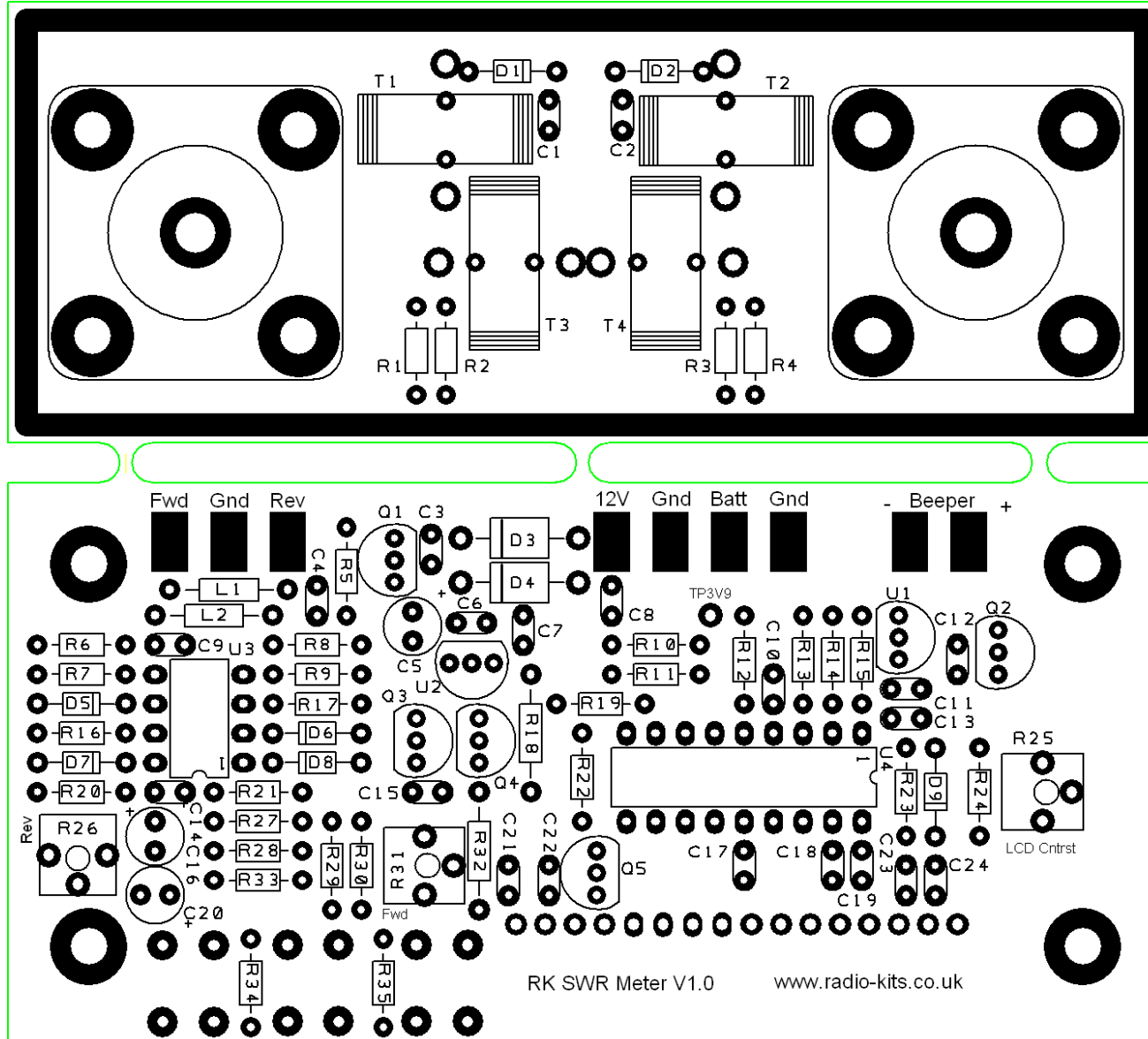

Operating instructions

Push buttons function

Menu

Each sequential press advances to the next menu function.

Pressing the menu button in the off mode will turn the unit on. To turn the unit off press and hold the menu button until “Power Off” is displayed, then release button. The unit can not power off if RF is being sensed on the transceiver input – in this case “Power Off” will not be displayed.

Backlight

There are 5 backlight levels selected by the up and down buttons: Off to 5

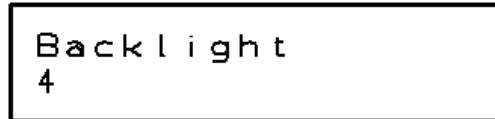

Reverse power alarm

If there is reverse power above the threshold set an alarm will sound. The threshold is adjustable by the up and down buttons in 1 Watt steps with a maximum of 50W

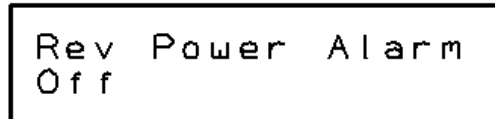

Time to auto off

The SWR meter can be made to automatically turn off after a preset period of no operation. The limit is adjustable in 10 second steps up to a maximum of 60 second. This function may also be turned off.

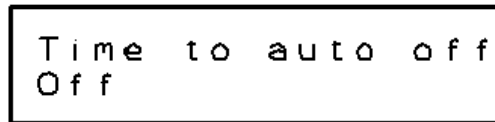

Up

The function for the top line of the display sequentially changes on each push of the button.

Functions are:

SWR – Numerical	SWR 1.0:1
Forward power – Numerical	FWD 0.00 Watts
SWR – Bar graph	SWR
Forward power – Bar graph	FWD

Down

The function for the bottom line of the display sequentially changes on each push of the button.

Functions are:

Forward power – Numerical	FWD 0.00 Watts
Reverse power – Numerical	REV 0.00 Watts
Forward power – Bar graph	FWD
Reverse power – Bar graph	REV
Supply voltage	Supply 13.8V

The bar graphs are calibrated as follows:

SWR

BAR	Value
1	1:1
2	1.1:1
3	1.2:1
4	1.3:1
5	1.4:1
6	2:1
7	2.5:1
8	3:1
9	5:1
10	10:1
11	15:1

Power:

12	>20:1
1	0.5
2	1
3	2
4	4
5	8
6	16
7	32
8	64
9	128
10	200
11	Not used
12	Not Used

