

PWS4205, PWS4305, PWS4323, PWS4602, and PWS4721 Linear DC Power Supplies User Manual



**PWS4205, PWS4305, PWS4323, PWS4602, and PWS4721
Linear DC Power Supplies**

User Manual

Warranty

Tektronix warrants that the product will be free from defects in materials and workmanship for a period of three (3) years from the date of original purchase from an authorized Tektronix distributor. If the product proves defective during this warranty period, Tektronix, at its option, either will repair the defective product without charge for parts and labor, or will provide a replacement in exchange for the defective product. Batteries are excluded from this warranty. Parts, modules and replacement products used by Tektronix for warranty work may be new or reconditioned to like new performance. All replaced parts, modules and products become the property of Tektronix.

In order to obtain service under this warranty, Customer must notify Tektronix of the defect before the expiration of the warranty period and make suitable arrangements for the performance of service. Customer shall be responsible for packaging and shipping the defective product to the service center designated by Tektronix, shipping charges prepaid, and with a copy of customer proof of purchase. Tektronix shall pay for the return of the product to Customer if the shipment is to a location within the country in which the Tektronix service center is located. Customer shall be responsible for paying all shipping charges, duties, taxes, and any other charges for products returned to any other locations.

This warranty shall not apply to any defect, failure or damage caused by improper use or improper or inadequate maintenance and care. Tektronix shall not be obligated to furnish service under this warranty a) to repair damage resulting from attempts by personnel other than Tektronix representatives to install, repair or service the product; b) to repair damage resulting from improper use or connection to incompatible equipment; c) to repair any damage or malfunction caused by the use of non-Tektronix supplies; or d) to service a product that has been modified or integrated with other products when the effect of such modification or integration increases the time or difficulty of servicing the product.

THIS WARRANTY IS GIVEN BY TEKTRONIX WITH RESPECT TO THE PRODUCT IN LIEU OF ANY OTHER WARRANTIES, EXPRESS OR IMPLIED. TEKTRONIX AND ITS VENDORS DISCLAIM ANY IMPLIED WARRANTIES OF MERCHANTABILITY OR FITNESS FOR A PARTICULAR PURPOSE. TEKTRONIX' RESPONSIBILITY TO REPAIR OR REPLACE DEFECTIVE PRODUCTS IS THE SOLE AND EXCLUSIVE REMEDY PROVIDED TO THE CUSTOMER FOR BREACH OF THIS WARRANTY. TEKTRONIX AND ITS VENDORS WILL NOT BE LIABLE FOR ANY INDIRECT, SPECIAL, INCIDENTAL, OR CONSEQUENTIAL DAMAGES IRRESPECTIVE OF WHETHER TEKTRONIX OR THE VENDOR HAS ADVANCE NOTICE OF THE POSSIBILITY OF SUCH DAMAGES.

[W16 – 15AUG04]

Table of Contents

General Safety Summary	iii
Compliance Information	v
EMC Compliance.....	v
Safety Compliance	vii
Environmental Considerations.....	ix
Preface.....	x
Key Features	x
Getting Started.....	1
Standard Accessories.....	1
Options and Optional Accessories	1
Specifications.....	2
Operating Requirements.....	3
Installing the System.....	4
Cleaning	6
Operating Basics	7
Front Panel at a Glance.....	7
Rear Panel at a Glance	11
Front-panel Operation.....	12
Index	

General Safety Summary

Review the following safety precautions to avoid injury and prevent damage to this product or any products connected to it.

To avoid potential hazards, use this product only as specified.

Only qualified personnel should perform service procedures.

To Avoid Fire or Personal Injury

Use proper power cord. Use only the power cord specified for this product and certified for the country of use.

Use proper voltage setting. Before applying power, ensure that the line selector is in the proper position for the source being used.

Ground the product. This product is grounded through the grounding conductor of the power cord. To avoid electric shock, the grounding conductor must be connected to earth ground. Before making connections to the input or output terminals of the product, ensure that the product is properly grounded.

Observe all terminal ratings. To avoid fire or shock hazard, observe all ratings and markings on the product. Consult the product manual for further ratings information before making connections to the product.

Power disconnect. The power switch disconnects the product from the power source. See instructions for the location. Do not block the power switch; it must remain accessible to the user at all times.

Do not operate without covers. Do not operate this product with covers or panels removed.

Do not operate with suspected failures. If you suspect that there is damage to this product, have it inspected by qualified service personnel.

Avoid exposed circuitry. Do not touch exposed connections and components when power is present.

Use proper fuse. Use only the fuse type and rating specified for this product.

Do not operate in wet/damp conditions.

Do not operate in an explosive atmosphere.

Keep product surfaces clean and dry.

Provide proper ventilation. Refer to the manual's installation instructions for details on installing the product so it has proper ventilation.

Terms in This Manual

These terms may appear in this manual:



WARNING. *Warning statements identify conditions or practices that could result in injury or loss of life.*



CAUTION. *Caution statements identify conditions or practices that could result in damage to this product or other property.*

Symbols and Terms on the Product

These terms may appear on the product:

- DANGER indicates an injury hazard immediately accessible as you read the marking.
- WARNING indicates an injury hazard not immediately accessible as you read the marking.
- CAUTION indicates a hazard to property including the product.

The following symbol(s) may appear on the product:

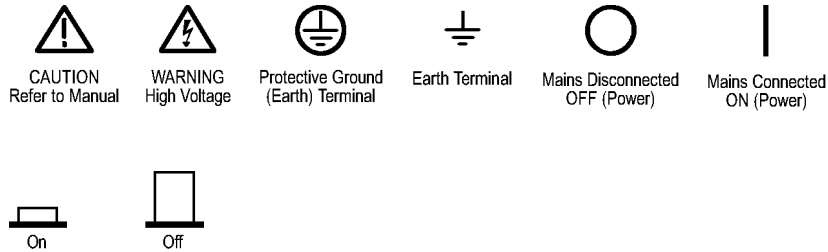

Compliance Information

This section lists the EMC (electromagnetic compliance), safety, and environmental standards with which the instrument complies.

EMC Compliance

EC Declaration of Conformity – EMC

Meets intent of Directive 2004/108/EC for Electromagnetic Compatibility. Compliance was demonstrated to the following specifications as listed in the Official Journal of the European Communities:

EN 61326-1 2006. EMC requirements for electrical equipment for measurement, control, and laboratory use. ^{1 2 3}

- CISPR 11:2003. Radiated and conducted emissions, Group 1, Class A
- IEC 61000-4-2:2001. Electrostatic discharge immunity
- IEC 61000-4-3:2002. RF electromagnetic field immunity
- IEC 61000-4-4:2004. Electrical fast transient / burst immunity
- IEC 61000-4-5:2001. Power line surge immunity
- IEC 61000-4-6:2003. Conducted RF immunity
- IEC 61000-4-11:2004. Voltage dips and interruptions immunity⁴

EN 61000-3-2:2006. AC power line harmonic emissions

EN 61000-3-3:1995. Voltage changes, fluctuations, and flicker

European contact.

Tektronix UK, Ltd.
Western Peninsula
Western Road
Bracknell, RG12 1RF
United Kingdom

- ¹ **This product is intended for use in nonresidential areas only. Use in residential areas may cause electromagnetic interference.**
- ² **Emissions which exceed the levels required by this standard may occur when this equipment is connected to a test object.**
- ³ **For compliance with the EMC standards listed here, high quality shielded interface cables should be used.**
- ⁴ **Output voltage, current limit, and output state upon restoration of AC input power after a power interruption are determined by user preference settings. Under the factory default settings, output voltage and current limit values will be restored to the previous settings, but output state will be set to off. Change the user preferences if restoration of previous output state upon restoration of AC input power is desired.**

Australia / New Zealand Declaration of Conformity – EMC

Complies with the EMC provision of the Radiocommunications Act per the following standard, in accordance with ACMA:

- CISPR 11:2003. Radiated and Conducted Emissions, Group 1, Class A, in accordance with EN 61326-1:2006.

Australia / New Zealand contact.

Baker & McKenzie
Level 27, AMP Centre
50 Bridge Street
Sydney NSW 2000, Australia

Safety Compliance

EC Declaration of Conformity – Low Voltage

Compliance was demonstrated to the following specification as listed in the Official Journal of the European Communities:

Low Voltage Directive 2006/95/EC.

- EN 61010-1: 2001. Safety requirements for electrical equipment for measurement control and laboratory use.

U.S. Nationally Recognized Testing Laboratory Listing

- UL 61010-1:2004, 2nd Edition. Standard for electrical measuring and test equipment.

Canadian Certification

- CAN/CSA-C22.2 No. 61010-1:2004. Safety requirements for electrical equipment for measurement, control, and laboratory use. Part 1.

Additional Compliances

- IEC 61010-1: 2001. Safety requirements for electrical equipment for measurement, control, and laboratory use.

Equipment Type

Test and measuring equipment.

Safety Class

Class 1 – grounded product.

Pollution Degree Description

A measure of the contaminants that could occur in the environment around and within a product. Typically the internal environment inside a product is considered to be the same as the external. Products should be used only in the environment for which they are rated.

- Pollution Degree 1. No pollution or only dry, nonconductive pollution occurs. Products in this category are generally encapsulated, hermetically sealed, or located in clean rooms.
- Pollution Degree 2. Normally only dry, nonconductive pollution occurs. Occasionally a temporary conductivity that is caused by condensation must be expected. This location is a typical office/home environment. Temporary condensation occurs only when the product is out of service.
- Pollution Degree 3. Conductive pollution, or dry, nonconductive pollution that becomes conductive due to condensation. These are sheltered locations where neither temperature nor humidity is controlled. The area is protected from direct sunshine, rain, or direct wind.
- Pollution Degree 4. Pollution that generates persistent conductivity through conductive dust, rain, or snow. Typical outdoor locations.

Pollution Degree

Pollution Degree 2 (as defined in IEC 61010-1). Note: Rated for indoor use only.

Installation (Overvoltage) Category Descriptions

Terminals on this product may have different installation (overvoltage) category designations. The installation categories are:

- Measurement Category IV. For measurements performed at the source of low-voltage installation.
- Measurement Category III. For measurements performed in the building installation.
- Measurement Category II. For measurements performed on circuits directly connected to the low-voltage installation.
- Measurement Category I. For measurements performed on circuits not directly connected to MAINS.

Overvoltage Category

Overvoltage Category II (as defined in IEC 61010-1)

Environmental Considerations

This section provides information about the environmental impact of the product.

Product End-of-Life Handling

Observe the following guidelines when recycling an instrument or component:

Equipment recycling. Production of this equipment required the extraction and use of natural resources. The equipment may contain substances that could be harmful to the environment or human health if improperly handled at the product's end of life. To avoid release of such substances into the environment and to reduce the use of natural resources, we encourage you to recycle this product in an appropriate system that will ensure that most of the materials are reused or recycled appropriately.



This symbol indicates that this product complies with the applicable European Union requirements according to Directives 2002/96/EC and 2006/66/EC on waste electrical and electronic equipment (WEEE) and batteries. For information about recycling options, check the Support/Service section of the Tektronix Web site (www.tektronix.com).

Restriction of Hazardous Substances

This product is classified as Monitoring and Control equipment, and is outside the scope of the 2002/95/EC RoHS Directive.

Preface

Key Features

The PWS4000 Series offer:

- Single-output, DC power
- 3-year warranty
- Linear regulation
- 0.03% Basic voltage accuracy
- 0.05% Basic current accuracy
- Less than 5 mV_{pp} ripple and noise
- 40 user-defined setup memories
- USB Device port on rear panel for PC connectivity and remote programming
- National Instruments LabVIEW SignalExpress™ TE Limited Edition Software for connecting your bench instruments together

Model	Description
PWS4205	Programmable DC power supply. 20 V, 5 A, 1 channel, USB
PWS4305	Programmable DC power supply. 30 V, 5 A, 1 channel, USB
PWS4323	Programmable DC power supply. 32 V, 3 A, 1 channel, USB
PWS4602	Programmable DC power supply. 60 V, 2.5 A, 1 channel, USB
PWS4721	Programmable DC power supply. 72 V, 1.2 A, 1 channel, USB

Getting Started

Standard Accessories

Accessory	Tektronix part number
<i>PWS4205, PWS4305, PWS4323, PWS4602, and PWS4721 Power Supply User Manual (available in 10 languages)</i> Contains safety and installation information.	071-2761-XX to 071-2770-XX
Power Cord: based upon the international power option	(See page 1, <i>Options and Optional Accessories</i> .)
Certificate of calibration	
PWS4000 Linear Power Supplies Documentation Browser CD	063-4282-XX
National Instruments LabVIEW SignalExpress, Tektronix Limited Edition Communications Software CD, Version 2.5.1	063-4253-00

Options and Optional Accessories

For the current list of accessories, upgrades, and options available for your PWS4000 Series Power Supply, visit the Tektronix Web site, www.tektronix.com.

Table 1: Standard accessories

Accessory	Tektronix part number
<i>PWS4205, PWS4305, PWS4323, PWS4602, and PWS4721 Power Supply Technical Reference</i> , in English. Contains detailed information about the instrument, including specifications and how to verify performance. Available for download from www.tektronix.com/manuals .	077-0480-XX
<i>PWS4205, PWS4305, PWS4323, PWS4602, and PWS4721 Programmer Manual</i> , in English. Contains detailed information about remote control of the instrument. Available for download from www.tektronix.com/manuals .	077-0481-XX

Table 1: Standard accessories (cont.)

Accessory	Tektronix part number
Power Cord	<i>One of the following:</i>
	North America (Option A0). The factory sets the 110V/220V selector switch to 110 V.
	Universal Euro (Option A1). The factory sets the 110V/220V selector switch to 220 V.
	United Kingdom (Option A2). The factory sets the 110V/220V selector switch to 220 V.
	Australia (Option A3). The factory sets the 110V/220V selector switch to 220 V.
	Switzerland (Option A5). The factory sets the 110V/220V selector switch to 220 V.
	China (Option A10). The factory sets the 110V/220V selector switch to 220 V.
	India (Option A11). The factory sets the 110V/220V selector switch to 220 V.
	Brazil (Option A12). The factory sets the 110V/220V selector switch to 220 V.
<i>Tektronix GPIB to USB Adapter</i> . Enables GPIB control of Tektronix instruments through the USB port of Tektronix instruments	TEK-USB-488

Specifications

For more specifications, refer to the PWS4205, PWS4305, PWS4323, PWS4602, and PWS4721 Technical Reference.

Table 2: Electrical ratings for the power connection

Model	Line Selector Switch Setting	Frequency	Fuse Rating	Max Power
PWS4205	110 V / 220 V	50 / 60 Hz	For 110 V: 5 A TH, 250 V For 220 V: 2.5 A TH, 250 V	350 VA
PWS4305	110 V / 220 V	50 / 60 Hz	For 110 V: 5 A TH, 250 V For 220 V: 2.5 A TH, 250 V	500 VA
PWS4323	110 V / 220 V	50 / 60 Hz	For 110 V: 5 A TH, 250 V For 220 V: 2.5 A TH, 250 V	350 VA
PWS4602	110 V / 220 V	50 / 60 Hz	For 110 V: 5 A TH, 250 V For 220 V: 2.5 A TH, 250 V	500 VA
PWS4721	110 V / 220 V	50 / 60 Hz	For 110 V: 5 A TH, 250 V For 220 V: 2.5 A TH, 250 V	350 VA

Table 3: Environmental performance

Parameter	PWS4205	PWS4305	PWS4323	PWS4602	PWS4721
Temperature	Operating: +0 °C to +40 °C				

Table 3: Environmental performance (cont.)

Parameter	PWS4205	PWS4305	PWS4323	PWS4602	PWS4721
Humidity	Operating: 5% to 95% relative humidity (% RH) at up to 40 °C, non-condensing				
Altitude	Operating: 100% capability up to 2,000 meters.				
Pollution Degree 2, For indoor use only					

Nominal Voltage Ratings

There are two ranges for all models, selectable by the line-voltage selector switch. Check the voltage select switch on the bottom of the power supply before turning it on: 110 V setting, 110 / 115 / 120 VAC; 220 V setting, 220 / 230 / 240 VAC. Fluctuations must not exceed 10% of the nominal rated voltage.

Float Voltage Rating

Float voltage rating: up to 100 V (DC + peak AC) between earth ground and any output terminal.

Operating Requirements

1. Place the instrument on a bench or similar surface.
2. Before operating, ensure that the ambient temperature is between +0 °C and +40 °C (+32 °F to +104 °F).



WARNING. To ensure proper cooling, keep the front, sides, and rear of the instrument clear of obstructions.



WARNING. Observe all safety precautions listed in this manual before using this product and any associated instruments. Although some instruments and accessories would be used with non-hazardous voltages, there are situations where hazardous conditions may be present. This product is intended for use by qualified personnel who recognize shock hazards and are familiar with the safety precautions required to avoid possible injury. Read and follow all installation, operation, and maintenance information carefully before using the product. Refer to this manual for complete product specifications. Before performing any maintenance, disconnect the line cord and all test cables. Operators of this instrument must be protected from electric shock at all times. The responsible body must ensure that operators are prevented access and/or insulated from every connection point. In some cases, connections must be exposed to potential human contact. Product operators in these circumstances must be trained to protect themselves from the risk of electric shock. If the circuit is capable of operating at or above 1000 volts, no conductive part of the circuit may be exposed.



WARNING. Use properly rated load wires. All load wires must be heavy enough not to overheat when carrying the maximum short-circuit output current of the power supply. If there is more than one load, then any pair of load wires must be capable of safely carrying the full-rated short-circuit output current of the power supply.



WARNING. Do not loosen any screw on this product, except those in the rear connector, which are intended to retain attached external wires to the connector. There are no user serviceable components inside.



WARNING. To reduce risk of fire and shock, ensure the mains supply voltage fluctuations do not exceed 10% of the operating voltage range.

Installing the System

This section contains information on how to install your PWS4000 power supply.

- Unpack the instrument and check that you received all the items listed as standard accessories.
- Check that you also received any other accessories that you ordered with your instrument.
- Check the Tektronix Web site (www.tektronix.com) for the most current information.

To verify that the power supply is ready to use, follow these procedures:

Powering the Instrument On and Off

To power on the instrument follow these steps:

1. Make all the connections.
2. Properly set the 110 V / 220 V selector switch on the bottom of the instrument.

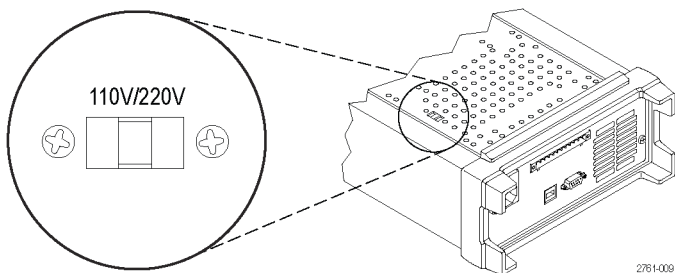

3. Connect the power cord that was provided with the instrument to the power connector on the rear panel. Connect the power cord plug to a properly grounded electrical outlet.
4. Push the power button on the front panel.

To power off the instrument, push the front-panel power button.



WARNING. To satisfy safety requirements, always use load wires heavy enough not to overheat when carrying the maximum short-circuit output current of the power supply. If there is more than one load, then every pair of load wires must be capable of safely carrying the full-rated current of the power supply.

What to Do if the Power Supply Does Not Turn On

To solve problems you might encounter when turning on the instrument, follow these steps:

1. Verify that there is AC power to the power supply.

First, check that the AC power cord is firmly plugged into the power connector on the rear panel of the power supply. You should also make sure that the AC power source you plugged the power supply into is energized. Then, check that the power supply is turned on.

2. Verify the power-line voltage settings.

Check that the line voltage selector switch on the bottom of the instrument is set to the proper value for your country (110 V_{AC} or 220 V_{AC}). Change the voltage setting if it is not correct.

NOTE. Under certain circumstances, powering the instrument from a mains voltage for which it is not configured can cause the mains fuse to open.

3. Verify that the correct power-line fuse is installed.

If the fuse is damaged, replace the fuse for your power supply.

If you set the line selection to 110 V, use a 5 A, TH 250 V fuse.

If you set the line selection to 220 V, use a 2.5 A, TH 250 V fuse.

4. If you need more help, contact Tektronix.

Check the Output

The following procedures check that the power supply develops its rated outputs and properly responds to operation from the front panel.

Voltage output check. To verify basic voltage functions without a load, follow these steps.

1. Remove all leads from the output connectors.
2. Turn on the power supply.
3. Push **Shift** and **Menu (1)**. **>Default Set** should appear on the display.
4. Push **Enter** to bring up the default settings menu. **No** and **Yes** should appear on the display.
5. Push the right arrow button to select **Yes**. Push **Enter** to enable the default settings.
6. Push the front-panel **On/Off** button to enable the output. The **OFF** message in the display should turn off and the **CV** display should turn on. The upper line of the display should show the actual output voltage and current. The lower line should show the settings.
7. Check that the front-panel voltmeter properly responds to the number keys.

Push **V-set**, use the number keys to set the voltage value to 0 and push **Enter**. Check if the displayed voltage value is approximately 0 V and check if the displayed current value is approximately 0 A. You can confirm the 0 V setting with a voltmeter.

8. Push **V-set** and use the numeric keys and **Enter** button to set the voltage value to the maximum allowable for your power supply, as indicated on the unit's front panel.
9. Check if the displayed voltage value is approximately the same value as the voltage setting.

Current output check. To verify the basic current functions with a short across the power supply output, follow these steps:

1. Remove all leads from the output connectors.
2. Turn on the power supply.
3. Push **Shift** and **Menu (1)**. **>Default Set** should appear on the display.
4. Push **Enter** to bring up the default settings menu. **No** and **Yes** should appear on the display.
5. Push the right arrow button to select **Yes**. Push **Enter** to enable the default settings.
6. Ensure that the output is disabled and the display **OFF** message is turned on. If needed, push the **On/Off** button to ensure that the output is disabled and the **OFF** message is turned on.
7. Use an insulated test lead to connect a short across the (+) and (-) output terminals.

Use a wire size sufficient to handle the maximum current. You should use at least a 22 gauge wire.



WARNING. *To satisfy safety requirements, always use load wires heavy enough not to overheat when carrying the maximum short-circuit output current of the power supply. If there is more than one load, then every pair of load wires must be capable of safely carrying the full-rated current of the power supply.*

8. Push the **On/Off** button to enable the output. The **CC** message should be lit.
9. Push **I-set** and use the numeric keys and **Enter** button to set the current value to 0 A. Check if the displayed current value is approximately 0 A.
10. Push **I-set** and use the numeric keys and **Enter** button to set the current value to the maximum allowable for your current supply. Check if the displayed current value is approximately the same value as the maximum allowable.
11. Turn off the power supply and remove the short wire from the (+) and (-) output terminals.

Cleaning

Inspect the power supply as often as operating conditions require. To clean the exterior surface, perform the following steps:

1. Remove loose dust on the outside of the power supply with a lint-free cloth. Use care to avoid scratching the display.
2. Use a soft cloth dampened with water to clean the power supply. Use an aqueous solution of 75% isopropyl alcohol for more efficient cleaning.



CAUTION. *To avoid damage to the surface of the power supply, do not use any abrasive or chemical cleaning agents.*



CAUTION. *Avoid getting moisture inside the unit during external cleaning. Use only enough cleaning solution to dampen the cloth or swab.*

Operating Basics

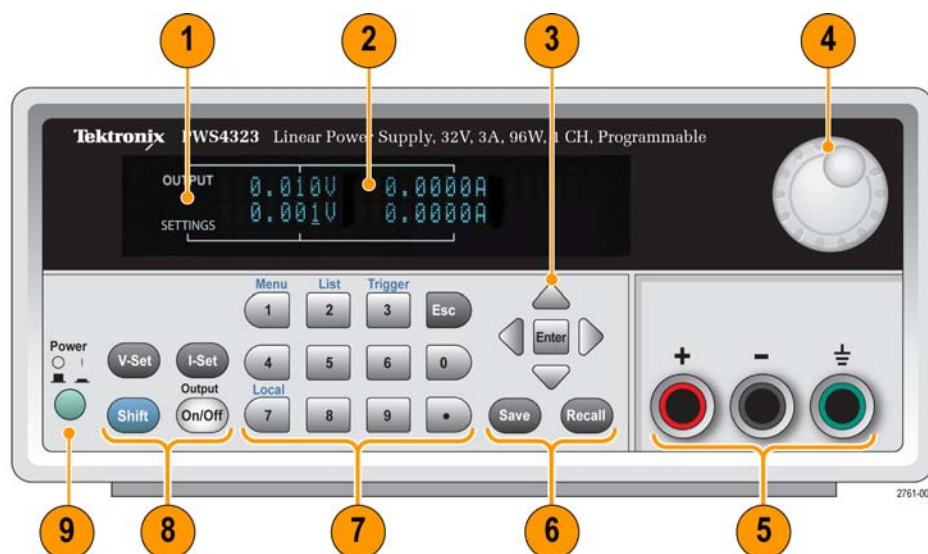

Front Panel at a Glance

Controls and display elements are shown in the following illustrations and tables.







1. Display
2. Information about the output (top row) and settings (bottom row) for volts (left column) and current (right column)
3. Up, down, right, and left arrow keys (▲ and ▼) and **Enter** button
4. Multipurpose knob. Rotate to increase or decrease digits or to select menu items
5. Output connectors
6. **Save** and **Recall** function buttons
7. Number keys (**0** to **9** and **Esc**) for direct numeric entry
8. **V-Set**, **I-Set**, **Shift**, and **Output On/Off** function buttons
9. Power switch



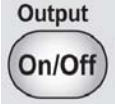

Function button descriptions

Button	Description
	Sets the voltage limit
	Sets the current limit

Function button descriptions (cont.)

Button	Description
	Saves the present settings to a specified setup memory location (1 to 40). Select the memory location with the multipurpose knob, the up or down arrow keys, or the numeric keypad. The power supply saves the settings after you push Enter .
	Recalls a saved setting from a specified setup memory location (1 to 40). Select the memory location with the multipurpose knob, the up or down arrow keys, or the numeric keypad. The power supply recalls the settings after you push Enter .
	Used to access secondary functions of the numeric keys. For example, when used with the "1" (Menu) button, invokes the settings menu. Navigate the settings menu with the up and down keys. Push Enter to select the displayed menu item.
	Turns on or off the output channel of the power supply. The regulation mode, constant voltage (CV) or constant current (CC), is shown on the display when the output is turned on.
	Backs out of the selected function. If the instrument's focus is in a menu, pushing Esc will back up one menu level.

Shift button descriptions

Button	Keypad	Description
	1	Brings up the operation menus. Turn the multipurpose knob or push the up or down buttons to scroll through the list of menus. Push the Enter button to select which menu to use.
	2	Brings up the list selection. Turn the multipurpose knob or push the up or down buttons to scroll through the various lists you can run.
	3	Generates a manual trigger event.
	7	Returns control from remote operation to local front panel control. This operation generate a return to local message.

Menu descriptions

Primary Menu	Secondary Menu	Description
>Default Set		Returns the instrument to the factory default setup values. This does not change the setup memory or lists

Menu descriptions (cont.)

Primary Menu	Secondary Menu	Description
>Protect	>Reset Protect	Resets items in the Protect menu
	>Max Volt Set	Sets the maximum output voltage value to which you can set the instrument
	>OVP Set	Turns the over-voltage protection "On" or "Off". After you select "On", you can set the voltage threshold.
	>Out Time Set	After you select "On", you can set a time period after which the power supply output will turn off
	>Key Lock	When activated, this feature locks the front panel controls and prompts for a password to enable settings changes. This feature does not lock the power switch or the output on/off switch.
>Edit List	Recall 1-7	Recalls a list. You can recall up to seven lists, each with up to 80 steps. Each step may contain a voltage value, a current value, and a time duration value. You can then edit the list and save it in any of the seven locations
>User	>Reset User	Resets items in the User menu
	>Output Recall	Sets the power output On/Off state after power up. "On" restores the state to that which was in use before the power was last turned off. "Off" disables this function and configures the output channel to power up on the off state. NOTE. Wait 3 seconds after changing the settings to allow the settings to be completely stored before powering off the instrument
	>Save Last	Recalls the operating parameters of the power supply after power up. It does this by saving the last setting of operating parameters before you turn the instrument off and then restoring the saved setting when you turn the instrument back on. NOTE. Wait 3 seconds after changing the settings to allow the settings to be completely stored before powering off the instrument
	>Key Beep	Turns on or off a beeper sound when you push a button or press a key. "On" enables the key sound. "Off" disables it.
	>Knob Lock	Locks the multipurpose knob

Menu descriptions (cont.)

Primary Menu	Secondary Menu	Description
>System	>Reset System	Resets items in the System menu
	>Port Mode	Select "Trigger", "RI/DFI", or "Digital" to select a type of digital port mode. This uses the Control pins on the right side of the rear-panel terminal strip.
		<i>Port Mode</i> <i>In</i> <i>Out</i> <i>Also set these menu items</i>
		Trig Trigger In N/A Trigger source
		RI/DFI RI DFI >RI mode >DFI source
		Digital I/O DI DO N/A. Use programmable interface commands.
		>Trig Source Select either "Manual", "External", "Bus", or "Immediat" to select a trigger mode using the rear panel port mode. Use "Trigger" to step through steps in List Mode.
	>RI Mode Select either "Off", "Latching", or "Live" to configure the Remote Inhibit (RI) mode. In "Latching" mode, a high-to-low transition (5 V to 0 V) on the RI input will turn the output channel off. In "Live" mode the output channel will turn off when the RI input is low (0 V) and on when the RI input is high (5 V)	
	>DFI Source Select the source of the Discrete Fault Indicator. Select either "Off", "QUES" (Question), "OPER" (Operation), "ESB" (Error Status Byte), or "RQS" (Request service). If the power supply finds the selected condition, it will generate a TTL high (5 V) on the DFI output.	
	>Address Select a GPIB address for use with the Tektronix GPIB to USB Adapter (TEK-USB-488).	

Upper display messages

Symbol	Description
OFF	The power supply output is off
CV	Constant voltage mode
CC	Constant current mode
OVP (upper)	OVP has tripped
RI	Output has been turned off by the remote inhibit (RI) input

Lower display messages

OVP (lower)	Overvoltage protection (OVP) is set. Flashes when OVP has tripped
--------------------	---

Rear Panel at a Glance

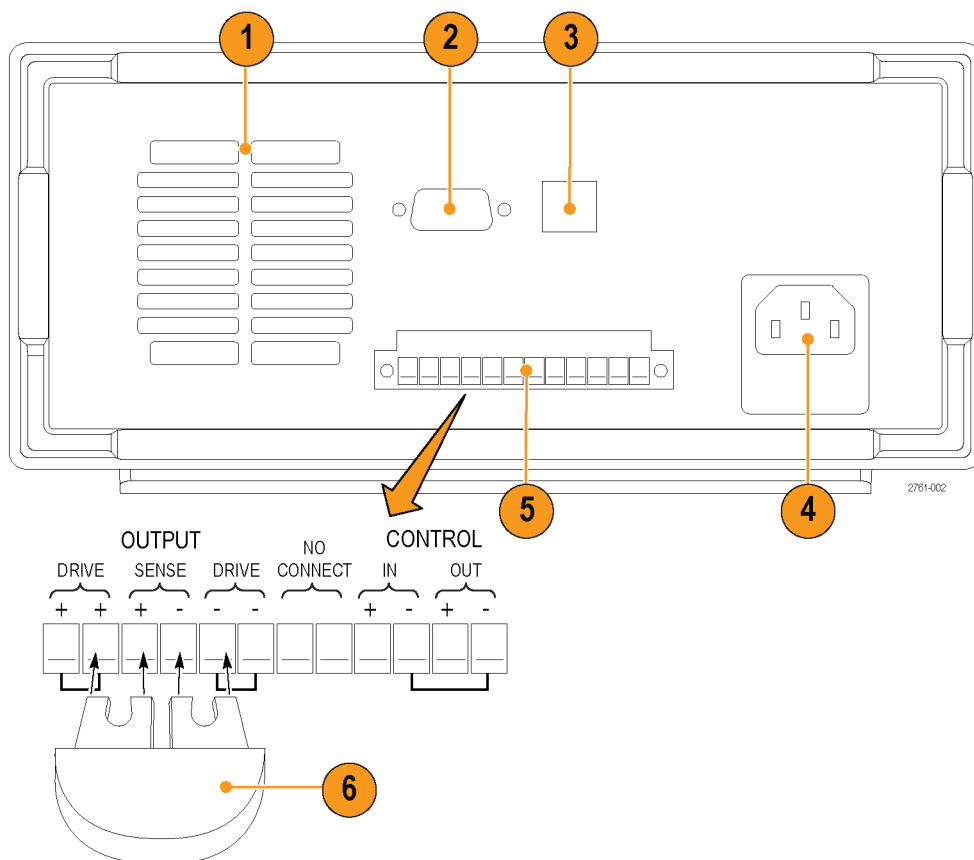

1. Cooling vents
2. Factory test port



CAUTION. *Unauthorized use of the factory test port could damage this product.*

3. USB Device port
4. 110 V/220 V power connector
5. 12-pin connector. Includes remote sense.

The two **Output Drive +** connectors are equivalent to the front-panel output + connector

The two **Output Drive -** connectors are equivalent to the front-panel output - connector

The two **Output Sense + and -** connectors are used for remote sensing

The two **No Connect** connectors on the rear panel terminal strip are unused

The four **Control In + -** and **Control Out + -** connectors on the rear panel terminal strip are configured by the port mode controls. They support the trigger, RI/DFI, and digital I/O functions.

6. Shorting clip. Use this for proper regulation when not using remote sense. This connector comes installed. It shorts the + drive to the + sense and the - drive to the - sense. To use remote sense, remove the clip.
7. 110 V/220 V selector switch

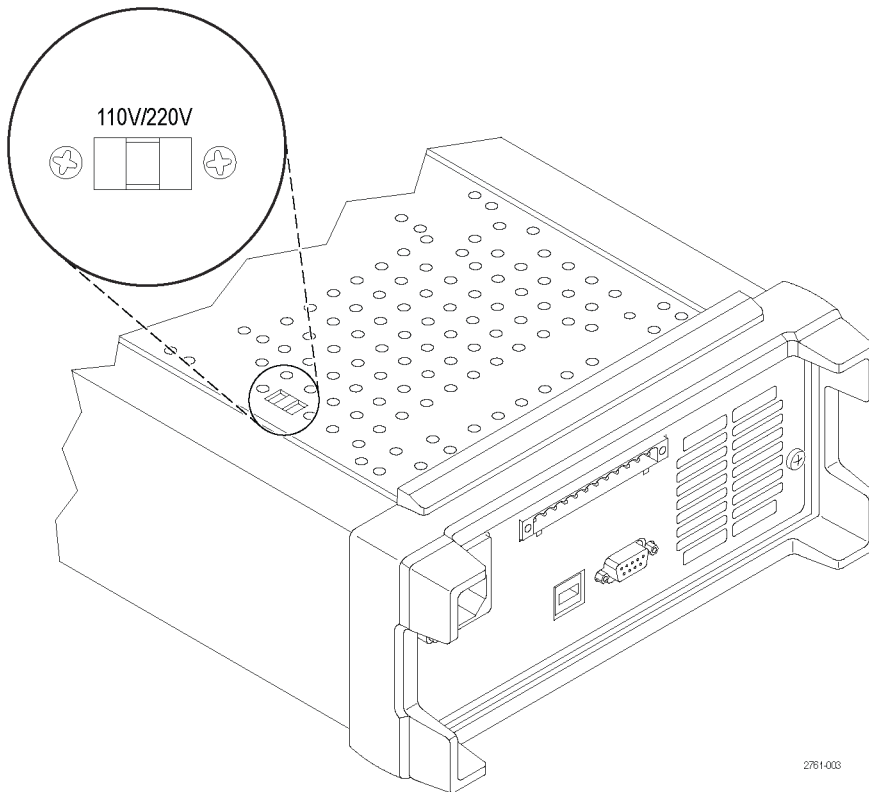

2761-003

Front-panel Operation

Within a few seconds after powering on, the power supply displays the actual voltage and current output value on the display's top line and the voltage and current settings on the bottom line.

You can enable or disable the output of the power supply from the front panel by pushing the **Output On/Off** button. When the output is off, the **OFF** message will appear on the display to the right of the current and voltage values.

The display shows the present operating status of the power supply with display messages. When the power supply operates in constant voltage mode, the **CV** message displays. When it operates in the constant current mode, the **CC** message displays.

NOTE. If the front panel was locked with a password, enter the correct password after you push the function buttons (**V-set**, **I-set**, **Save**, **Recall**, or **Shift**), then you can change the settings.

NOTE. To cancel a function operation (**V-set**, **I-set**, **Save**, **Recall**, or **Shift**), push the **Esc** button.

Configuring the Instrument for Your Application

The menu system includes settings, like **OVP** and **Max Volt**, that determine the maximum voltage output of the power supply and settings, like **Save Last** and **Output Recall**, that determine how the instrument initializes itself upon power-up.

This power supply features a constant voltage/constant current automatic crossover. This feature permits continuous operation in the transition from constant-voltage mode to constant-current mode as the load changes. The intersection of the constant-current and constant-voltage modes is called the crossover point.

For example, if the load is such that the power supply is operating in constant-voltage mode, the power supply provides a regulated output voltage. The output voltage remains constant as the load increases until the preset current limit is reached. Then the crossover occurs. At that point, the output current becomes constant and the output voltage drops in proportion to further load increases.

Crossover is indicated by the front panel **CC** and **CV** messages. If the **CV** message appears, the instrument is operating in constant-voltage mode. If the **CC** message appears, the instrument is operating in constant-current mode.

Crossover from the constant-current mode to the constant-voltage mode also occurs automatically in response to a decrease in load. For example, suppose you are charging a 12 V battery. Initially, the open circuit voltage of the power supply is preset for 13.8 V. A low-battery places a heavy load on the power supply, and it operates in constant-current mode. You adjust the instrument to charge the battery at the rate of 1 A. As the battery becomes charged and its voltage approaches 13.8 V, the load decreases to the point where the battery no longer demands the full 1 A charging rate. The power supply then crosses over to constant-voltage mode.

Initializing to the Default Setup

Use the default setup to get the power supply into a default initial state.

1. Remove all leads from the output connectors.
2. Turn on the power supply.
3. Push **Shift** and **Menu (1)**. **>Default Set** should appear on the display.
4. Push **Enter** to bring up the default settings menu. **No** and **Yes** should appear on the display.
5. Push the right arrow button to select **Yes**. Push **Enter** to enable the default settings.

The default settings are:

- **Output On/Off = OFF**
- **V-Set = 1.000V**
- **I-Set = 0.1000A**
- **Knob Lock = Off**
- **Trig Source = Manual**
- **OVP Set = Off**
- **Max Volt Set = Off**
- **Out Time Set = Off**
- **Output Recall = Off**
- **Save Last = On**
- **Key Beep = Off**

- **Port Mode = Trigger**
- **RI Mode = Off**
- **DFI Source = Off**
- **Address = 1**

Setting the Current Limit

You may set the current limit from 0 A to the maximum current value of each model. The maximum current rating is shown on the instrument name plate.

1. Push **I-set**.
2. Use the numeric keys and push **Enter** to set the current limit. You can also use the up, down, right and left arrow keys or the multipurpose knob.

Setting the Voltage Limit

You may set the voltage limit from 0 V to the maximum voltage rating shown on the instrument nameplate.

1. Push **V-set**.
2. Use the numeric keys and push **Enter** to set the voltage limit. You can also use the up, down, right and left arrow keys or the multipurpose knob.

Save and Recall Setups

You can store up to 40 different setups in setup memory locations (1 to 40). Each setup includes the set voltage limit, the set current limit, and the protection menu settings. When shipped from the factory, setup memories 1 through 40 are empty. Save and recall setups as follows:

Saving setups.

1. After you set up the power supply, (voltage and current limits and the protection menu settings), push the **Save** button.
2. Use the number keys or the arrow keys to select the setup memory (1 to 40) that you want to store the values in.
3. Push **Enter** to confirm the memory location.

Recalling setups.

1. Push **Recall**.
2. Use the number keys or the arrow keys to select the setup memory that you want to recall from.
3. Push **Enter**.

Set the Maximum Voltage

This control determines the maximum voltage that you can set using the **V-set** control. This can help keep accidental over-voltage from being applied to sensitive loads. To set the maximum voltage, follow these steps:

1. Push **Shift** and **Menu** (1).
2. Use the arrow keys to select **>Protect**.
3. Push **Enter** and turn the multipurpose knob one click clockwise. **>Max Volt Set** should appear on the display.
4. Push **Enter**. **Off (default)** should appear.
5. Use the up and down arrows to select **On**.
6. Push **Enter** to turn on the maximum voltage feature.
7. Use the numeric keys or the arrow keys or multipurpose knob to change the voltage value. The value must be less than the maximum voltage output noted on the nameplate of the power supply.
8. Push **Enter**.
9. Push **Esc** to exit the menu system.

NOTE. *The default maximum voltage is the full voltage range of the particular power supply being used.*

NOTE. *When you adjust the voltage value being set up to the maximum voltage limit, the voltage setting flashes back at you.*

Set the Over Voltage Protection

Over Voltage Protection (OVP) will turn off the output and clamp the voltage on the output to below one volt if the instrument senses a voltage level above the threshold set for Over Voltage Protection.

1. Push **Shift** and **Menu** (1).
2. Use the arrow keys to select **>Protect**.
3. Push **Enter**.
4. Use the up or down arrow keys to select **>OVP Set**.
5. Push **Enter**.
6. Select **On**.
7. Push **Enter**.
8. Enter the desired OVP value with the numeric keypad, arrow keys, or multipurpose knob.
9. Push **Enter**.

NOTE. *The lower display shows **OVP** when the over voltage protection feature is activated. The **OVP** indicator will flash on and off when the over voltage protection feature has tripped.*

Resetting the Power Supply after an Over Voltage Trip

1. Determine and remove the source of the over voltage. Over voltage may be caused by setting the voltage limit too high, external voltage sources, or equipment failure.
2. Push the **Output On/Off** button to clear the OVP status. This will put the power supply output in the off state.

Recall the Power Supply ON/OFF Output State at Power On

This parameter determines the On or Off output state after the power supply is powered on. If you select **On**, the power supply will restore the state of the output to that which was in use before the power was last turned off. If the output was turned **On** when the power supply is turned off or loses power then the output will return to the **On** state when the power supply is turned back on or power is restored. **Off** will disable this function and the output channel will always be set to **Off** after the power supply is powered on.

To enable or disable this control,

1. Push the **Shift** and then the **Menu (1)** button.
2. Use the up and down arrow keys to select **>User**.
3. Push **Enter**.
4. Use the up and down arrow keys to select **Output Recall**.
5. Push **Enter**.
6. Use the up or down arrow keys to select **On** or **Off**.
7. Push **Enter**.
8. Push **Esc** to exit the menu system.

NOTE. The default selection is set to *Off*.

Recall the Power Supply Operating Parameters at Power On

This parameter determines whether the power supply saves its most recent settings, such as voltage and current, and restores these settings at power on. If you set this parameter to **Off** then the power supply returns to the default settings at power on. If you select **On**, the power supply will restore the state to that which was in use before the power was last turned off.

To enable or disable this control,

1. Push **Shift** and then **Menu (1)**.
2. Use the arrow keys to select **>User**.
3. Push **Enter**.
4. Use the arrow keys to select **Save Last**.
5. Push **Enter**.
6. Use the arrow keys to select **On** or **Off**.
7. Push **Enter**.
8. Push **Esc** to exit the menu system.

NOTE. The default selection is set to On.

Set the Key Sound

This control can switch on or off the beeper that sounds when you push any button or press any key. To enable or disable this feature,

1. Push **Shift** and **Menu (1)**.
2. Use the arrow keys to select **>User**.
3. Push **Enter**.
4. Use the arrow keys to select **>Key Beep**.
5. Push **Enter**.
6. Use the arrow keys to select **On** or **Off**.
7. Push **Enter**.
8. Push **Esc** to exit the menu system.

NOTE. The default selection is set to Off.

Lock the Multipurpose Knob

To lock the multipurpose knob so it cannot be used to change settings or to select menu items,

1. Push **Shift** and **Menu (1)**.
2. Use the arrow keys to select **>User**.
3. Push **Enter**.
4. Use the arrow keys to select **Knob Lock**.
5. Push **Enter**.
6. Use the arrow keys to select **On** or **Off**.
7. Push **Enter**.
8. Push **Esc** to exit the menu system.

Using Local Sense

Configuring the power supply for local sense allows connection to the device under test with two lead wires, but does not compensate for voltage drop in the leads.

1. On the rear panel terminal strip, install wires between DRIVE + and SENSE +, and between DRIVE - and SENSE -. You may also use the included shorting clip as shown earlier. (See page 11, *Rear Panel at a Glance*.)
2. Connect to your device under test using two wires from either the front panel binding posts or the rear panel DRIVE + and DRIVE - terminals.

Using Remote Sense

Use remote sensing to regulate the output voltage at the device under test. This feature lets you compensate for the voltage drop in the leads between the power supply front-end terminals and the device-under-test. To set the remote sensing mode:

1. Remove any jumpers or shorting clip on the rear panel terminal strip connectors between DRIVE + and SENSE + and between DRIVE - and SENSE -.
2. Connect a pair of sense leads from SENSE + and SENSE - to the device under test.



CAUTION. To assure system stability, use a jacketed, twisted-pair cable between the remote sense terminals of the PWS4000 and the load.

3. Connect a pair of drive leads from the DRIVE + and DRIVE - to the device under test.

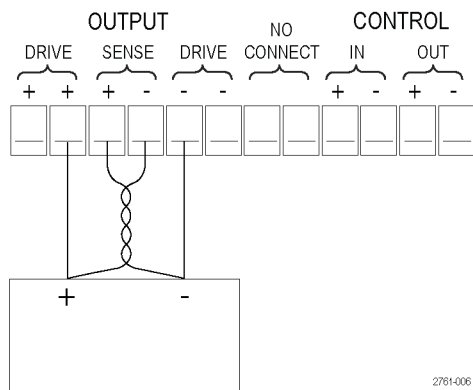

Load (Device Under Test)

Define a List of Voltage and Current Steps

The list feature lets you create up to seven sequences of steps, each with a voltage level, current level, and time duration.

To define and save a sequence, do the following:

Your actions	The instrument displays
1. Push Shift and Menu (1) .	>Default Set
2. Use the arrow keys to select >Edit List	>Edit List
3. Push Enter .	Recall 1
4. Rotate the multipurpose knob to select the number of the list to define or edit. You can choose from 1 to 7.	Recall 1
5. Push Enter .	Continuous

- Use the up and down arrow keys to select **Step** or **Continuous**.

In continuous mode, the supply will execute the entire sequence of steps as soon as it receives the next trigger signal. The trigger source is determined by the system menu's trigger source item.

Continuous

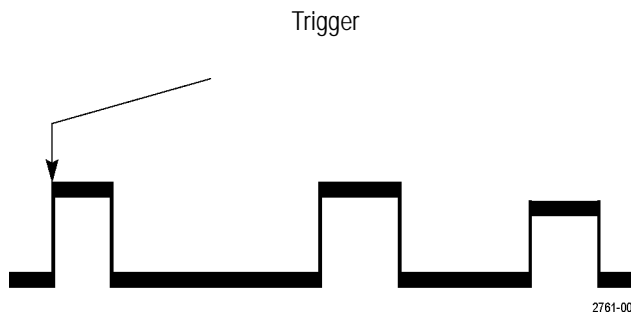

In step mode, the supply will advance to each step only after it receives a trigger signal.

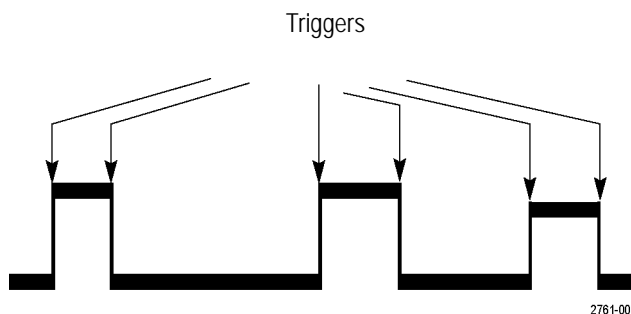

- Push **Enter**.
- Use the keypad or multipurpose knob to select the number of times to repeat the list. In the example to the right, **2** is used. This means that the instruction will run through the list of steps two times before stopping.
- Push **Enter**.
- Rotate the multipurpose knob to select the number of steps in the list. In the example to the right, **3** is used.
- Push **Enter**.
- Use the keypad to set the voltage for this step. In the example to the right, the voltage is set to 4.00 volts.
- Push **Enter**.

Repeat 1

Repeat 2

List Steps 4

List Steps 3

S 001 = 4.800V

S 001 = 4.00V

S 001 = 0.1000A

- 14. Use the keypad to set the current for this step. In the example to the right, the current is set to 1.500 amps. **S 001 = 1.500A**

- 15. Push **Enter**. **S 001 = 0.250 S**

- 16. Use the keypad to set the time duration for this step. In the example to the right, the duration is set to 0.100 seconds. **S 001 = 0.100 S**

- 17. Push **Enter**. **S 002 = 4.500 V**

- 18. Repeat steps 11 through 17 for each of the number of steps selected in step 10 above. **Save List 1**

19. Push the up or down arrow buttons to select the number of the list to save the current list to. In step 4 of this example, you started by selecting list 1. Now, you can save it in any of the 7 lists available to you.

>Edit List

20. Push **Enter** to save the list.

NOTE. *Running a list does not turn the output channel on. Before running a list, be sure to set the appropriate voltage and current and turn the output on.*

21. Push **Esc** to exit the menu structure.

NOTE. *See the Programmer's Manual for instructions on programming the List Mode Function.*

Run a List of Voltage and Current Steps

To run a defined list of voltage and current steps, do the following:

1. Set the output voltage to what you want it to be set at before running the list and push the **Output On/Off** button to turn the output on.
2. Select the list to run. Push **Shift** and **List (2)**. Select the list to use with the arrow keys, keypad, or multipurpose knob. Push **Enter**. The power supply will wait for a trigger to start executing the list. The trigger source depends on the setting of the Trigger Source control.
3. To run the selected list with a manual trigger, push **Shift** and **Trigger (3)**.
4. To stop the list from running any more and to turn the output to off, push **Esc**.

NOTE. *See the Programmer's Manual for instructions on programming the List Mode Function.*

Connect to an External Computer with USB

1. Load VISA on your computer. You can do this with the national Instruments LabVIEW SignalExpress CD that accompanies your power supply.



2. Connect the instrument to the computer with a USB cable. The computer will then recognize the power supply as a USB device. If National Instruments SignalExpress is installed, the computer will also give you the option of running that program.

For more information on loading and running SignalExpress, see the Connectivity Installation Manual on the PWS4000 Series Documentation Browser CD that accompanies your power supply. You can also download a copy of this manual from www.tektronix.com/manuals.

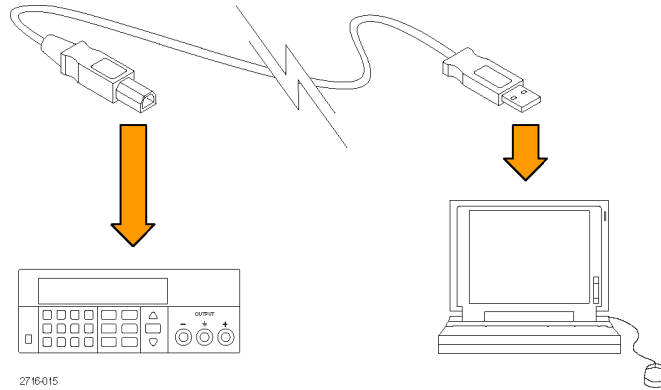

2716-015

Connect to an External Computer with GPIB

Follow these steps to connect the USB device port on your PWS4000 power supply to a GPIB (IEEE488) controller by using a Tektronix TEK-USB-488 GPIB-to-USB Adapter.

1. Apply power to your TEK-USB-488 Adapter by connecting the host end of the USB cable to the USB Host port on the power supply and the device end of the USB cable to the USB Device port on the rear panel of the TEK-USB-488 adapter.

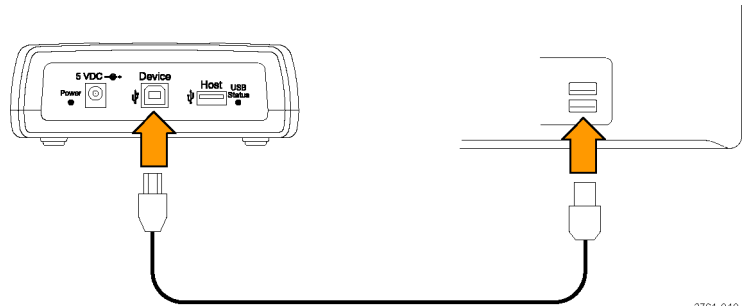

2761-010

Alternatively, connect the output power cable from an optional AC power unit to the 5 VDC connector on the rear panel of the adapter.

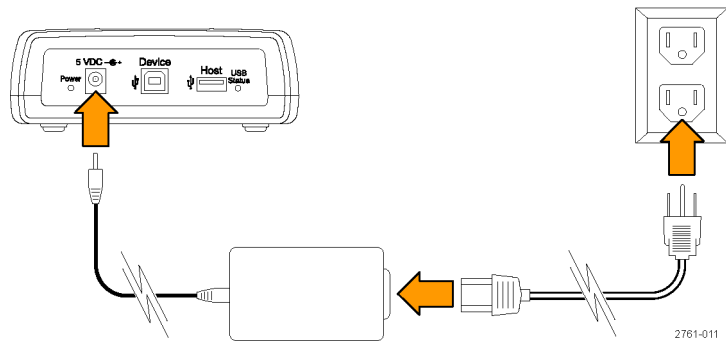

2761-011

2. Verify that the TEK-USB-488 Adapter's Power LED lights and the USB and Adapter Status LEDs turn on and then off.

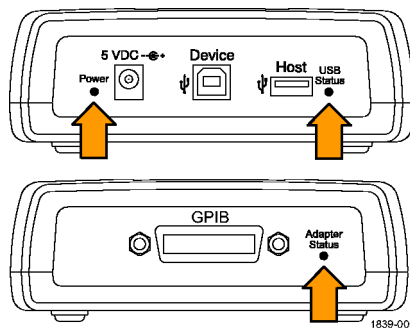

3. Connect a GPIB cable from the GPIB controller to the GPIB port on the adapter

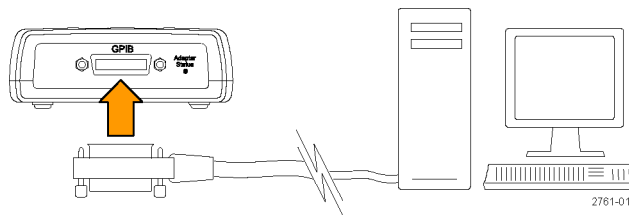

4. Connect a USB cable from the Device port on the instrument to the Host port on the adapter.

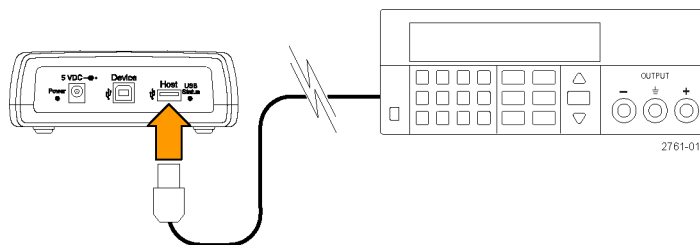

The resulting configuration should resemble that shown to the right.

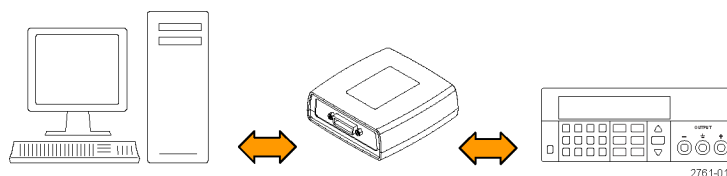

5. Set the GPIB address on the power supply. To do this, first, push **Shift** and then **Menu (1)**.
6. Use the up and down arrow keys to select **>System**
7. Push **Enter**.
8. Use the up and down arrow keys to select **>Address**.
9. Push **Enter**.

10. Use the up and down arrow keys to select the desired GPIB address for the power supply.
11. Push **Esc** to exit the menu system.

Index

Symbols and Numbers

110 V/220 V selector switch, 12
12-pin connector, 11

A

Accessories
 optional, 1
 standard, 1

B

Button
 I-set, 7
 Menu, 8
 On/off, 8
 Recall, 8
 Save, 8
 V-set, 7

C

Checkout
 current, 6
 no power, 5
 voltage, 5
Connectivity
 GPIB, 22
 USB, 21
Connector, 12-pin, 11
Connectors, 7
Crossover, 13
Current display, 7
Current limit adjustment, 14

D

Display, 7
 Lower messages, 10
 Upper messages, 10

F

Features, x
Front panel, 12
Front panel indicators and buttons, 7

Function button
 I-set, 7
 Menu, 8
 On/off, 8
 Recall, 8
 Save, 8
 V-set, 7

I

I-set button, 7
Installation, 4

K

Key
 arrow, 7
 function, 7
 number, 7
 Save and Recall, 7
Key Sound, 17
Knob
 Lock Set, 17
 Multipurpose, 7

L

List
 Define, 18
 Run, 21
Local sense, 17

M

Max Volt Set, 15
Menu button, 8
Messages, 10
Multipurpose
 Knob, 7
 Knob lock, 17

N

No power, 5

O

On/off button, 8
Operating requirements, 3

Operation

 current limit adjustment, 14
 recalling setups, 14
 saving setups, 14
 voltage limit adjustment, 14
Optional accessories, 1
Options, 1
Output
 Display, 7
 Recall, 16
Over Voltage Protection, 15
OVP, 15

P

Power
 off, 4
 on, 4
 socket, 11
 switch, 7

R

Rear panel, 11
Recall button, 8
Remote sense, 12, 18
Requirements
 operating, 3

S

Safety Summary, iii
Save
 Button, 8
 Last, 16
Saving and recalling setups, 14
Setting
 current limit, 14
 voltage limit, 14
Settings display, 7
Shorting clip, 12
Specifications, 2
Standard accessories, 1

T

TEK-USB-488 Adapter, 22
Troubleshooting, 5

U

USB Device port, 11

V

V-set button, 7

Voltage limit adjustment, 14

Volts display, 7