

UPS

Pure Sinewave Inverter

USER'S MANUAL

1.2K / 2.4K / 3.6KVA
6.6K / 10K / 13KVA



Power Tech International Group
sales@powertech-group.com
www.powertech-group.com

CONTENTS

1. INTRODUCTION	1
2. SAFETY INSTRUCTION.....	2
3. CABLE CONNECTION.....	4
4. SYSTEM DESCRIPTION.....	4
5. UPS OPERATION	9
6. TROUBLE SHOOTING GUIDE.....	15
7. OPERATION MODES OF THE UPS	17
8. SPECIFICATION OF UPS.....	19



1. INTRODUCTION

1.1 General Description

This UPS, a powerful all-in-one solution, delivers unsurpassed clean true sine wave output power and combines this with a selectable multistage battery charging current. Applicable for any kind of loads such as air conditioner, home appliances, consumer electronic and office equipments. This series features a durable & continuous 24 operation.

The built-in intelligent charger automatically charges any type of batteries without the risk of overcharge. The compact & modular design makes utility interactive installations easier and more cost effective. It is a high quality product that offers the best price/performance ratio in the industry.

1.2 Key features

1. Multiple microprocessor design base.
2. Compatible with both linear & non-linear load.
3. Stronger charger to support batteries of 500AH up.
4. 24 hours operation on the inverter.
5. DC start and automatic self-diagnostic function.
6. THD less than 3%.
7. High efficiency design to save electricity.
8. Low heat dissipation in long time operation
9. Design to operate under harsh environment
10. WALL Mounted design

1.3 Important Notices

1. Read instructions carefully before operating the UPS.
2. UPS power connect instruction should be followed.
3. Please don't open the case to prevent danger.
5. Retain the load within the rating of UPS to prevent faults.
6. Keep the UPS clean and dry.

2. SAFETY INSTRUCTION

2.1 Transporting

1. Disconnect all power cables if necessary.
2. Be careful not to damage the UPS while transporting.
3. Don't move the UPS upside down.
4. Please transport the UPS system only in the original packaging (to protect against shock and impact).

2.2 Positioning

1. Do not put the UPS on rugged or declined surface.
2. Do not install the UPS system near water or in damp environments.
3. Do not install the UPS system where it would be exposed to direct sunlight or near heat.
4. Do not block off ventilation openings in the UPS system's housing and don't leave objects on the top of the UPS.
5. Keep the UPS far away from heat emitting sources.
6. Do not expose it to corrosive gas.
7. Ambient temperature : 0°C - 40°C

2.3 Caution - risk of electric shock.

Even after the unit is disconnected from the mains power supply (building wiring socket outlet), components inside the UPS system are still connected to the battery and are still electrically live and dangerous. Before carrying out any kind of servicing and/or maintenance, disconnect the batteries and verify that no current is present.

Batteries may cause electric shock and have a high short-circuit current. Please take the precautionary measures specified below and any other measures necessary when working with batteries:

- remove wristwatches, rings and other metal objects
- use only tools with insulated grips and handles.

3. CABLE CONNECTION

3.1 Inspection

1. The system may be installed and wired only by qualified electricians in accordance with applicable safety regulations.
2. When installing the electrical wiring, please note the nominal amperage of your incoming feeder.
3. Inspect the packaging carton and its contents for damage. Please inform the transport agency immediately should you find signs of damage. Please keep the packaging in a safe place for future use.
4. Please ensure that the incoming feeder is isolated and secured to prevent it from being switched back on again.

4. SYSTEM DESCRIPTION

4-1 Front Panel Description

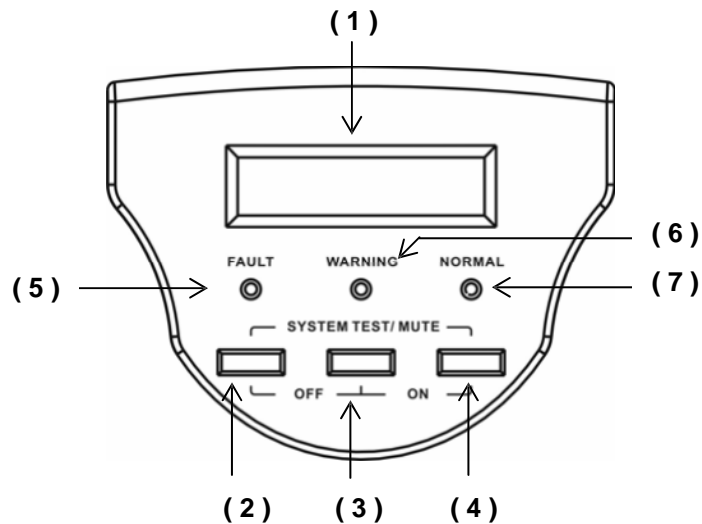

status, input/output voltage, input/output frequency, battery voltage, battery capacity left, output load, inside temperature, and the times of history events.

2. Up-key: Use to select upward the UPS status on LCD Display.
3. Down-key: Use to select downward the UPS status on LCD Display. Beside, press it simultaneously with the Up-key to switch off the UPS.
4. Enter-Key: It is pressed with the Down-key to turn on the UPS. In battery operation mode, press it with Up-key at the same time to disable the buzzer. Beside, it is pressed to confirm and enter the item selected.
5. Fault LED (red): To indicate the UPS is in fault condition because of inverter shutdown or over-temperature.
6. Warning LED (yellow): To indicate the UPS is in the status of overload, bypass and battery back-up.
7. Normal LED (green): To indicate the UPS is operating normally.
8. ON/TEST/MUTE key: It should be pressed with the control key simultaneously to switch on UPS, do UPS auto-test in normal AC mode and turn off the buzzer in battery operation.

1. LCD Display: This indicates the UPS operation information, including UPS

4-2 Outline Description

1.2KVA Wall Mounted 1\pe

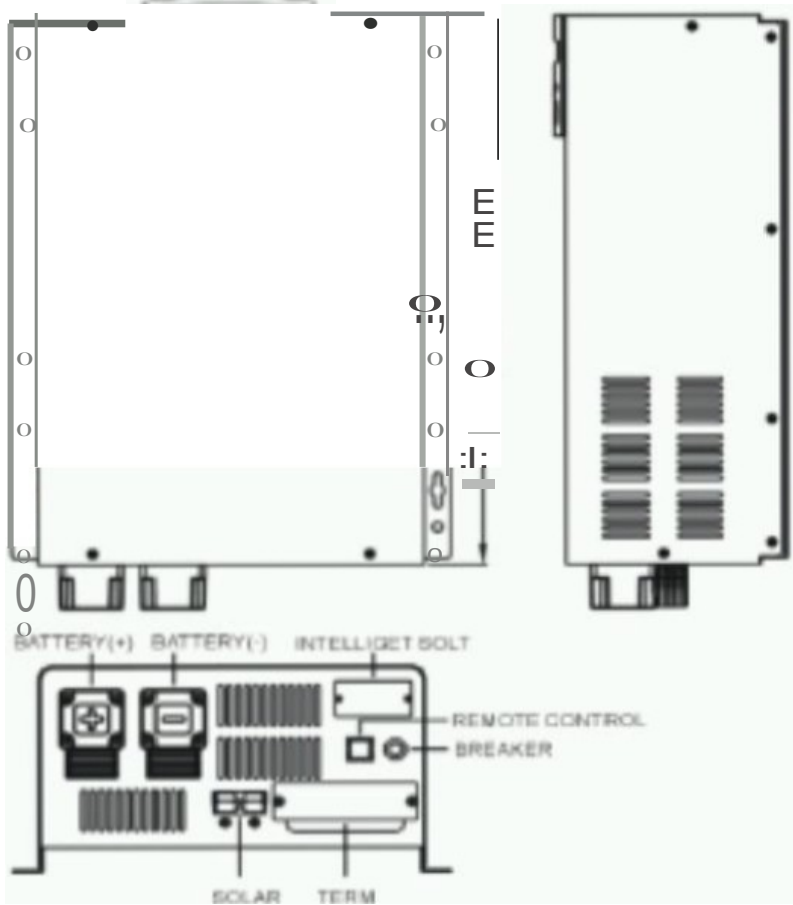
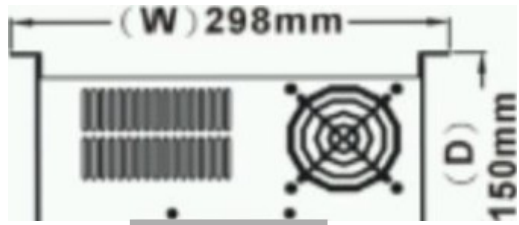

KVA /3.6KVA Wall Mounted Two

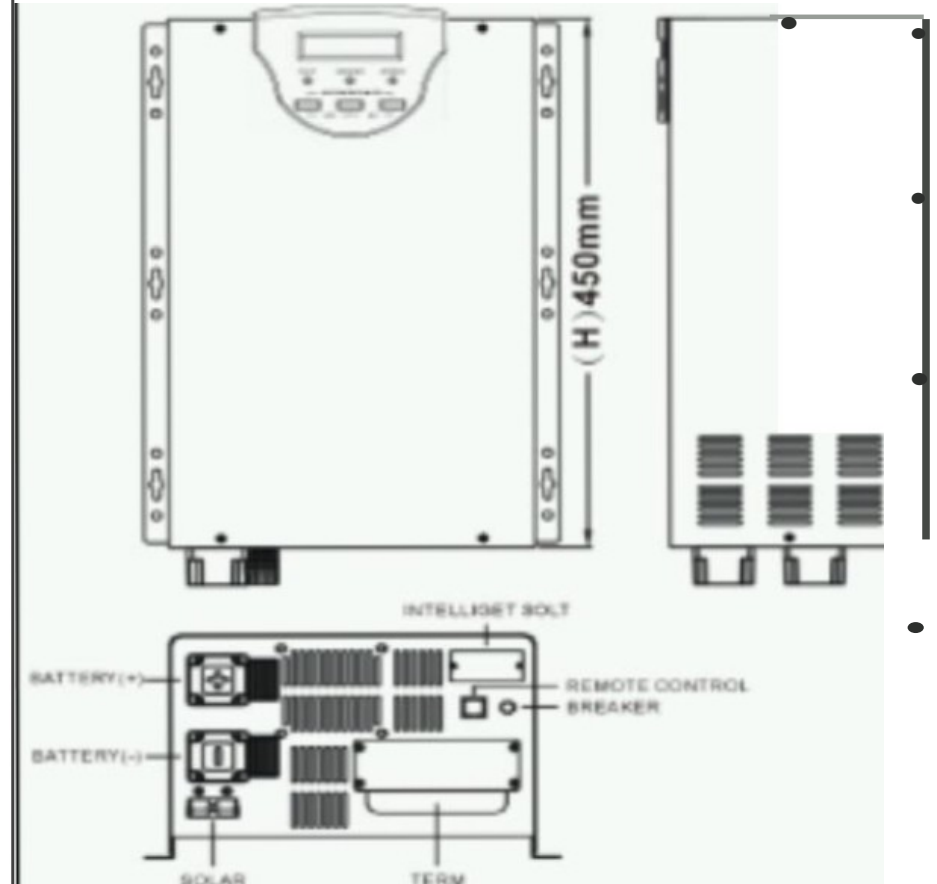
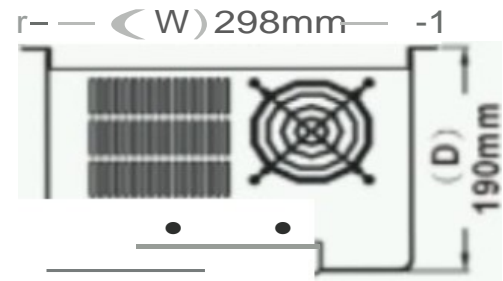

6.6KVA / 10KVA / 13KVA Wall Mounted Type

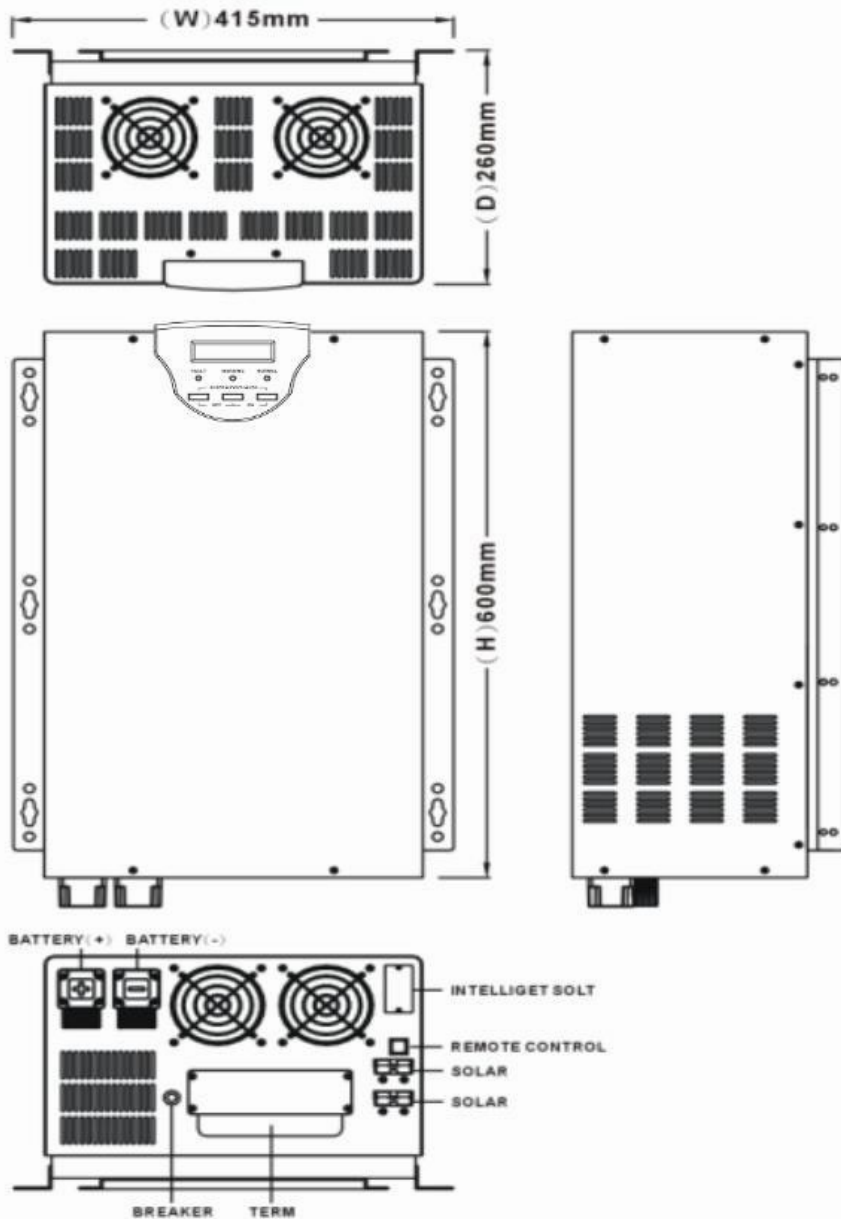

5. UPS OPERATION

5.1 Check Prior to Start Up

1. Ensure the UPS is in a suitable positioning.
2. Check input connection is secured.
3. Make sure the load is disconnected or in the "OFF" position.
4. Check if input voltage meets the UPS rating required.

5.2 Operation Procedure for LCD Model

Please follow the instructions below for UPS operation.



1. Once the AC source is connected, the LCD Display shall light up immediately to display first the main menu of greeting context and the Normal LED is blinking to indicate ready to switch on the inverter.
2. By pressing the Enter-key and the Down-key simultaneously for 3 seconds, the UPS will start up after two beeps and Normal LED lights up to indicate the power is from its inverter to the load.
3. When the Down-key and the Up-key are pressed simultaneously for 3 seconds, the inverter will be turned off after two beeps and the UPS is on the standby status (LCD display illuminates and Normal LED is blinking) until AC source is disconnected.

4. LCD Display Menu

Use Up/Down key to select menu-displays of the LCD described below. This screen will refresh once the system power is enabled.

Rated Spec



Status

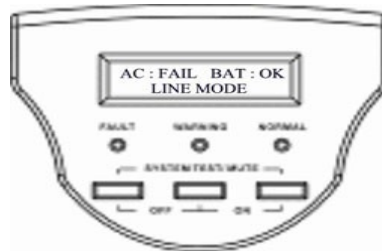

Voltage

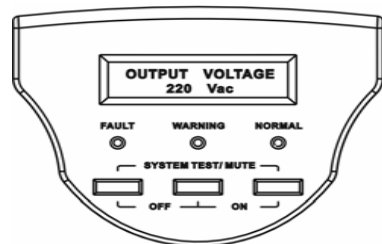
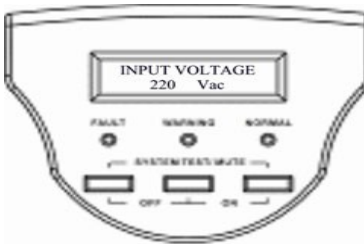

Frequency

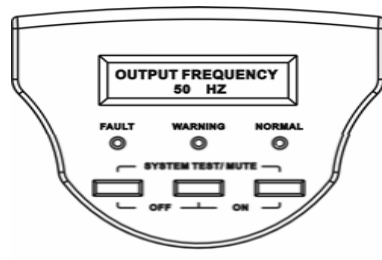
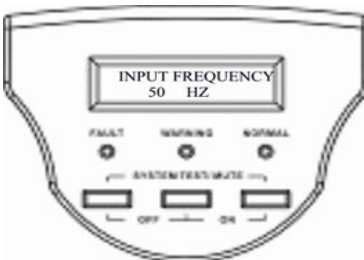

Battery Status

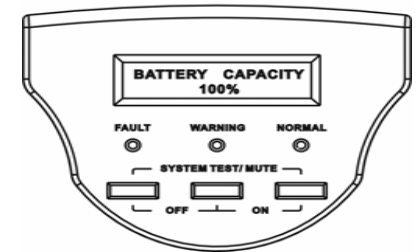
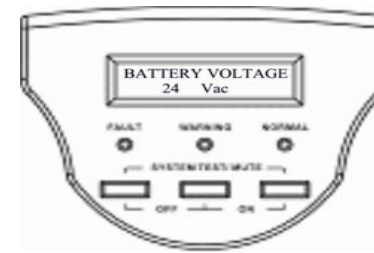

Output Power

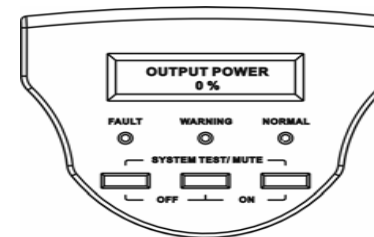

Temperature

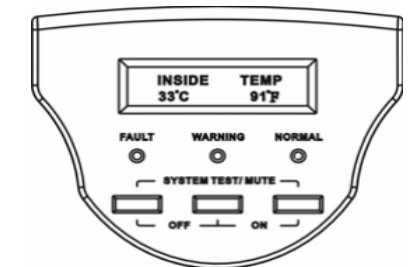

History Record

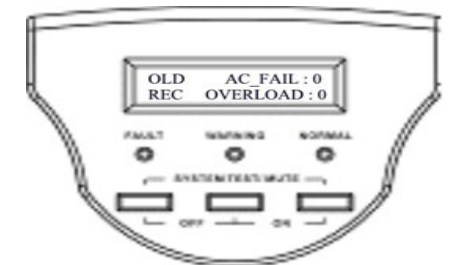

Input / Output Voltage & Frequency Adjust

A. In this screen, press Enter-key to enter the following steps for input/output voltage and frequency adjustment.



B. The cursor (→) will pop up to indicate the output voltage and frequency newly selected.



C. Use Up or Down-key to adjust the output voltage (if 220V configure, 220V, 230V, and 240V is selectable; if 110V configure, 110V, 115V, and 120V is selectable). Press Enter-key to confirm voltage and then the cursor will move to frequency selection. The output frequency (50Hz or 60Hz) can be adjusted by the same key operation.



D. Once the correct voltage is selected, press Enter-key again to save the selection.

Charging Current Adjust

A. In this screen, press Enter-key to enter the following steps for general battery current adjustment.

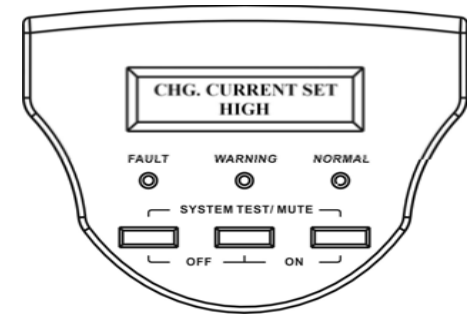

B. The cursor (→) will pop up to select the charging level.

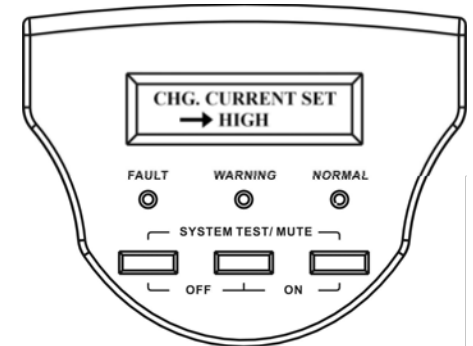

C. Use Up or Down-key to select the charging level (HIGH / MIDDLE / LOW selectable). Press Enter-key to confirm.

D. Once the correct charging level is selected, press Enter-key again to save the selection.

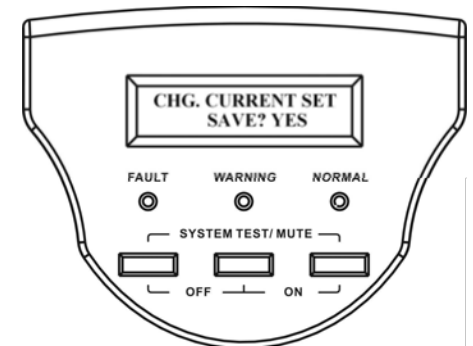

Battery Shutdown Voltage Setting

A. In this screen, press Enter-key to enter the following steps for general battery shutdown voltage adjustment.

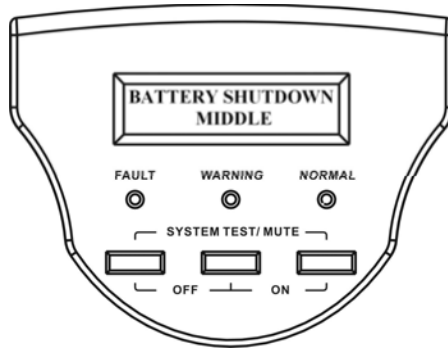

B. The cursor (→) will pop up to select the voltage level.

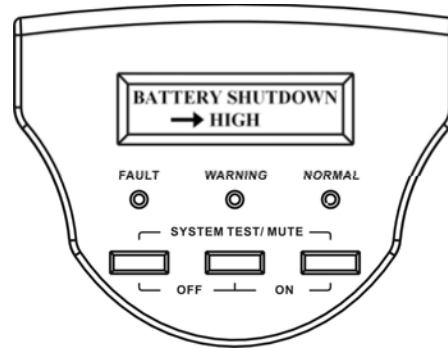

C. Use Up or Down-key to select the voltage level*. Press Enter-key to confirm.

D. Once the voltage level is selected, press Enter-key again to save the selection.

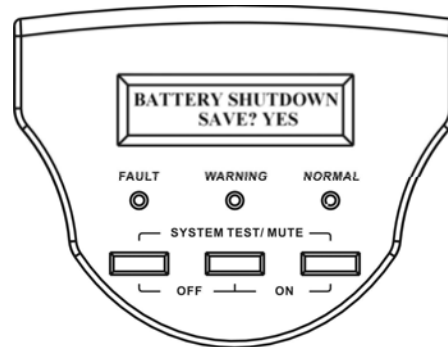

*** Voltage Level**

For 24VDC Models:
High: 21V
Middle: 20V (default)
Low: 19V

For 48VDC Models:
High: 42V
Middle: 40V (default)
Low: 38V

6. TROUBLE SHOOTING GUIDE

6.1 For LCD Model

The following guideline may be helpful for basic problem solving.

No.	UPS STATUS	POSSIBLE CAUSE	ACTION
1	AC utility power is normal. UPS is running normally, but fault LED lits up. Buzzer beeps continuously.	1. Charger PCB is damaged. 2. Fan is damaged. 3. Unknown	1. Replace the charger PCB. 2. Replace the fan. 3. Restart UPS
3	AC utility power is normal but UPS is overloaded. Warning LED lits up and buzzer beeps per second.	Overload 100%< load< 125%	Please reduce the critical load to <100%.
4	AC utility power is normal. Warning LED does not fade out and buzzer beeps per 0.5 second.	Overload 125%< load<150%	Please reduce the critical load to <100%.
5	AC utility power is normal. Warning LED lits up and buzzer beeps continuously.	Overload 150%< load	Please reduce the critical load to <100%.

No.	UPS STATUS	POSSIBLE CAUSE	ACTION
6	AC utility power fails .The load is supplied by battery power. Buzzer alarm sounds every 4 seconds.	<ol style="list-style-type: none"> 1. AC utility power failure. 2. AC input connection may be not correct. 	<ol style="list-style-type: none"> 1. Reduce the less critical load in order to extend backup time. 2. Please check the rated input or connected line.
7	AC utility fails. UPS is in battery backup mode. Buzzer alarm beeps every second.	Battery power is approaching low level.	UPS will shut down automatically. Please save data or turn off the loads soon.
8	AC utility power fails. UPS has shut down automatically.	Battery runs out	UPS will restart up when AC utility power is restored.

7. OPERATION MODES OF THE UPS

7.1 UPS System Block Diagram

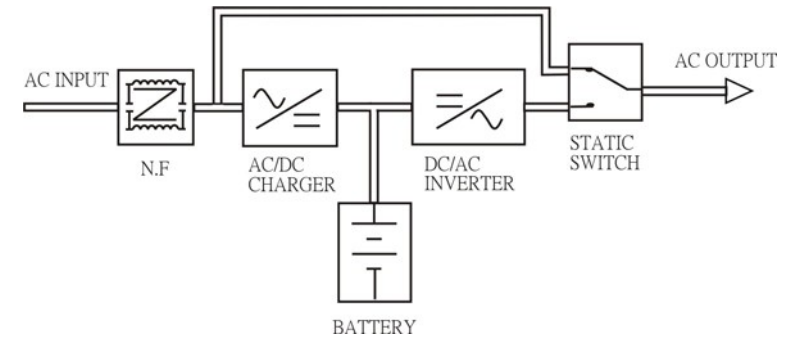

7.2 Normal Operation

There are two main loops when AC utility is normal: the AC loop and the battery charging loop. The AC output power comes from AC utility input and passes through static switch to support power to load. The battery charging voltage comes from AC utility input and converted by AC/DC charger to support battery-charging power.

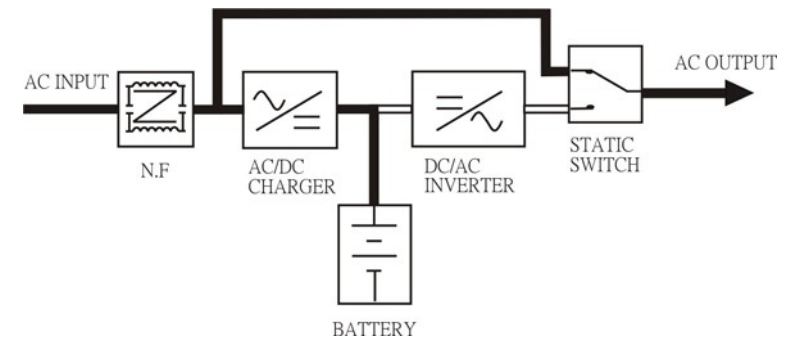

7.3 AC Utility Failure (Battery Mode)

The AC output comes from battery, passing through DC/AC inverter and static switch within the battery backup time.

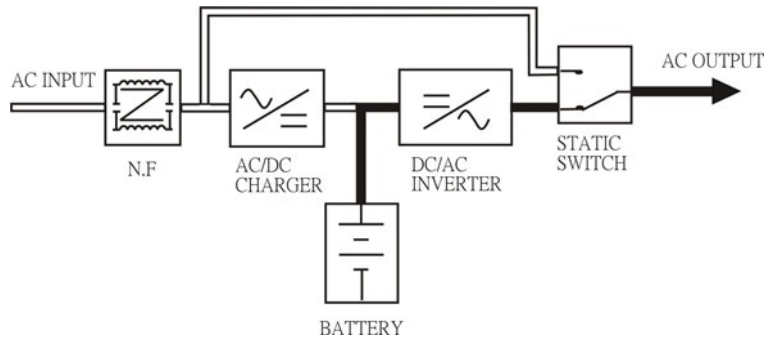

8. SPECIFICATION OF UPS

Capacity	VA / Watt	1.2KVA / 800W	2.4KVA / 1600W	3.6KVA / 2400W	
Input	Nominal Voltage	220Vac; 110Vac			
	Voltage Range	Acceptable Voltage Range	120-275Vac ; 60-135Vac		
		Frequency	50Hz / 60Hz (45Hz - 70Hz)		
		Line Low Transfer	120VAC \pm 2% ; 60VAC \pm 2%		
		Line Low Return	130VAC \pm 2% ; 65VAC \pm 2%		
		Line High Transfer	275VAC \pm 2% ; 135VAC \pm 2%		
		Line High Return	260VAC \pm 2% ; 130VAC \pm 2%		
Output	Voltage	220Vac (230V or 240VAC re-settable via LCD panel); 110Vac (115V or 120VAC re-settable via LCD panel)			
	Voltage Regulation (Batt. Mode)	< 3% RMS for entire battery voltage range			
	Frequency	50Hz or 60Hz			
	Frequency Regulation (Batt. Mode)	\pm 0.1Hz			
	Power Factor	0.67			
	Waveform	Pure Sinewave			
	Efficiency	> 75%	> 80%		
	Overload Protection	Line Mode	Circuit Breaker		
Battery Mode		110% ~ 150% for 30 sec. , >150% for 200ms			
Transfer Time	Typical	< 8 ms.			

Capacity	VA / Watt	1.2KVA / 800W	2.4KVA / 1600W	3.6KVA / 2400W
Battery	Battery Voltage	12Vdc	24Vdc	24Vdc
	Backup Time (at full load)	long time available		
	Max. Charging Current (5 steps selectable)	> 40A	> 50A	
Display LCD	LCD	UPS status, I/P&O/P Voltage Frequency, Load%, Battery Voltage & %, Charge current, Temperature, Model		
	LED	Normal (Green), Warning (Yellow), Fault (Red)		
Audible Alarm	Battery Mode	Beeping every 4 seconds		
	Low Battery	Beeping every second		
	UPS Fault	Beeping Continuously		
	Overload	Beeping twice per second		
Environment	Operation Temperature	0-40 degree C; 32-104 degree F		
	Relative Humidity	0-95% non-condensing		
	Audible Noise	Less than 55dBA (at 1M)		
Physical	Net Weigh (Kgs)	12	24	31.50
	(WxHxD)mm Rack Mount	440*132*290	440*132*360	440*132*360
	(WxHxD)mm Wall Mounted	298*400*150	298*450*190	298*450*190

- Specifications are subjected to change without prior notice.

Capacity	VA / Watt	6.6KVA/4000W	10KVA/6000W	13KVA/8000W	
Input	Nominal Voltage	220Vac; 110Vac		220Vac only	
	Voltage Range	Acceptable Voltage Range	120-275Vac ; 60-135Vac		120-275Vac
		Frequency	50Hz / 60Hz (45Hz - 70Hz)		50Hz / 60Hz (45Hz - 70Hz)
		Line Low Transfer	120VAC ± 2% ; 60VAC ± 2%		120VAC ± 2%
		Line Low Return	130VAC ± 2% ; 65VAC ± 2%		130VAC ± 2%
		Line High Transfer	275VAC ± 2% ; 135VAC ± 2%		275VAC ± 2%
		Line High Return	260VAC ± 2% ; 130VAC ± 2%		260VAC ± 2%
Output	Voltage	220Vac (230V or 240VAC re-settable via LCD panel); 110Vac (115V or 120VAC re-settable via LCD panel)			
	Voltage Regulation (Batt. Mode)	< 3% RMS for entire battery voltage range			
	Frequency	50Hz or 60Hz			
	Frequency Regulation (Batt. Mode)	±0.1Hz			
	Power Factor	0.6	0.6		
	Waveform	Pure Sinewave			
	Efficiency	> 80%			
	Overload Protection	Line Mode	Circuit Breaker		
Battery Mode		110% ~ 150% for 30 sec. , >150% for 200ms			
Transfer Time	Typical	< 8 ms.			

Capacity		6.6KVA/4000W	10KVA/6000W	13KVA/8000W
Battery	Battery Voltage	24Vdc	48Vdc	
	Backup Time (at full load)	long time available		
	Max. Charging Current (5 steps selectable)	> 40A	> 60A	
Display LCD	LCD	UPS status, I/P&O/P Voltage Frequency, Load%, Battery Voltage & %, Charge current, Temperature, Model		
	LED	Normal (Green), Warning (Yellow), Fault (Red)		
Audible Alarm	Battery Mode	Beeping every 4 seconds		
	Low Battery	Beeping every second		
	UPS Fault	Beeping Continuously		
	Overload	Beeping twice per second		
Environment	Operation Temperature	0-40 degree C; 32-104 degree F		
	Relative Humidity	0-95% non-dondensing		
	Audible Noise	Less than 55dBA (at 1M)		
Physical	Net Weigh (Kgs)	49.2Kg	51.4Kg	55Kg
	(WxHxD)mm Wall Mounted	415*600*260	415*600*260	415*600*260

- Specifications are subjected to change without prior notice.



Power Tech International Group

sales@powertech-group.com

www.powertech-group.com