



We Focus • We Deliver

IP PHONE SYSTEM CooVox Series-UI00

For Small and Medium Business

Quick Installation Guide

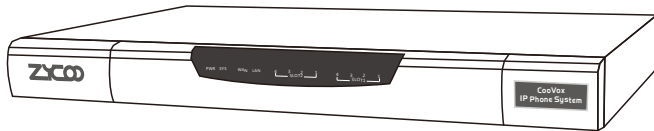

Table of Contents

1 Package Contents	03
2 Hardware Installation	04
2.1 Safety Precautions	04
2.2 Installation Tools	07
2.3 Product Installation	07
2.4 Physical Connection	11
2.5 LED Definitions	11
3 Basic System Configuration	12
3.1 Web Login	12
3.2 Network Configuration	13
3.3 Choose the Module	14
3.4 Reset to factory	15
4 Further Configuration	15

1 Package Contents

Thank you for purchasing ZYCOO IP Phone System. These are the items included with your IP Phone System purchase:



IP PBX



Power Cord



Quick Installation Guide



Antenna (only for GSM Module)



Warranty Card

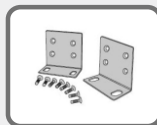

Two mounting brackets and fittings

2 Hardware Installation

The followings are instructions for setting up ZYCOO Coovox-U100 IP PBX. Please refer to the illustration and follow the simple steps below to quickly install your IP phone system.

2.1 Safety Precautions

Notes:

To avoid any device damage and bodily injury caused by improper use, please observe the following rules.

- Keep the power off during the installation.
- Wear an ESD-preventive wrist strap, and make sure that the wrist strap has a good skin contact and is well grounded.
- Use only the power cord provided with IP PBX .
- Make sure that the supply voltage matches the specifications indicated on the rear panel of IP PBX.
- Confirm not to bring about the overload of power circuit before turning on the power of IP PBX, to avoid the unnecessary damage.
- To avoid the electric accident, do not open or remove the cover of IP PBX when it is working as well as off the power.
- Before cleaning the device, cut off the power supply. Do not clean it by the waterish cloth, and never use any other liquid cleaning method.

Site Requirements

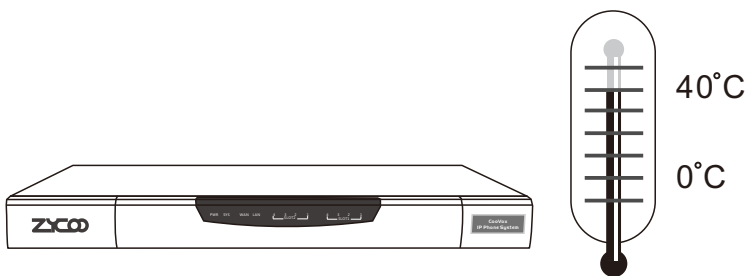

To ensure normal operation and long service life of the device, please install it in an environment that meets the requirements described in the following subsection. Please keep a proper temperature and humidity in the equipment room. Too high/low humidity may lead to bad insulation, electricity leakage, mechanical property changes and corrosions. Too high temperature may accelerate aging of the insulation materials and can thus significantly shorten the service life of the device. For normal temperature and humidity of the device, please check the following table.

Environment	Temperature	Humidity
Operating	0°C~40°C	10%~90% Non-condensing
Storage	-20°C~55°C	5%~95% Non-condensing

Clearness

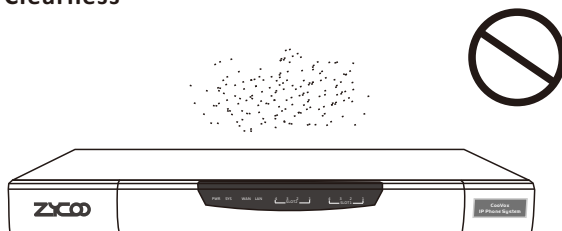

The dust accumulated on IP PBX can be absorbed by static electricity and result in poor contact of metal contact points. Some measures have been taken for the device to prevent static electricity, but too strong static electricity can cause deadly damage to the electronic elements on the internal circuit board. To avoid the effect of static electricity on the operation of IP PBX, please attach much importance to the following items:

- Dust the device regularly, and keep the indoor air clean.
- Keep the device well grounded and ensure static electricity has been transferred.

Electromagnetic Interference

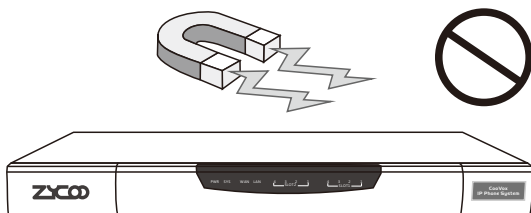

Electronic elements including capacitance and inductance on the device can be affected by external interferences, such as conducted emission by capacitance coupling, inductance coupling, and impedance coupling. To decrease the interferences, please make sure to take the following measures:

- Use the power supply that can effectively filter interference from the power grid.
- Keep the devices far from high-frequency, strong-current devices, such as radio transmitting station.
- Use electromagnetic shielding when necessary.

Lightening Protection

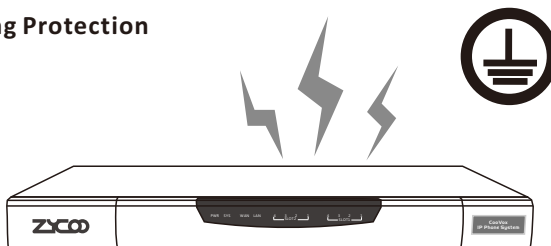

Extremely high voltage currents can be produced instantly when lightning occurs and the air in the electric discharge path can be instantly heated up to 20,000°C. As this instant current is strong enough to damage electronic devices, more effective lightning protection measures should be taken:

-
- Ensure the rack and devices are well earthed.
 - Make sure the power socket has a good contact with the ground.
 - Keep a reasonable cabling system and avoid induced lightning.
 - Use the signal SPD (Surge Protective Device) when wiring outdoor.

Note: the device is specially designed for the usage of communication operators' computer room; please obey the following requirements for installation and maintenance.

2.2 Installation Tools

- Phillips screwdriver
- ESD-preventive wrist wrap
- Cables

2.3 Product Installation

Module Installation

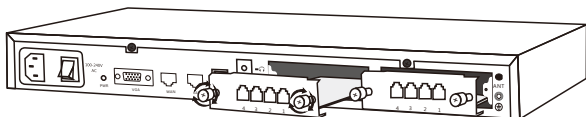

This IP PBX can support installing two extension modules at the same time.

Optional modules are as follows.

- 4FXS Module
- 2GSM Module
- 1PRI Module
- 4FXO Module
- 4GSM Module
- 4BRI Module
- 2FXOS Module

1. Check if the module is clean and intact.
2. Please ensure power of IP PBX is cut off.

3. Please ensure the direction of the module is correct (ZYCOO-logo side up).
4. Push the module into the module slot through the guide rail.
5. Tighten the locking screws on the both ends of the module.

Notes:

- Do not touch any device on the module, just to prevent the module from being damaged by static electricity.
- This operation must be done with power cut off. The module does not support hot-plugging.

Rack Installation

To install the device in an EIA standard-sized, 19-inch rack, follow the instructions described below:

1. Check the grounding and stability of the rack.
2. Secure the supplied rack-mounting brackets to each side of the device with supplied screws as illustrated in the following figure.

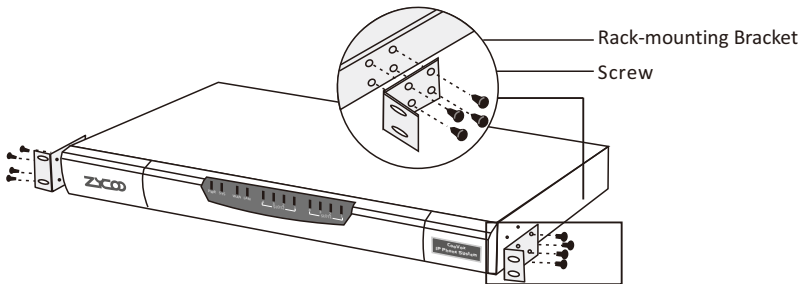

3. Install IP PBX to the right place in the rack, and then attach the brackets to the device.

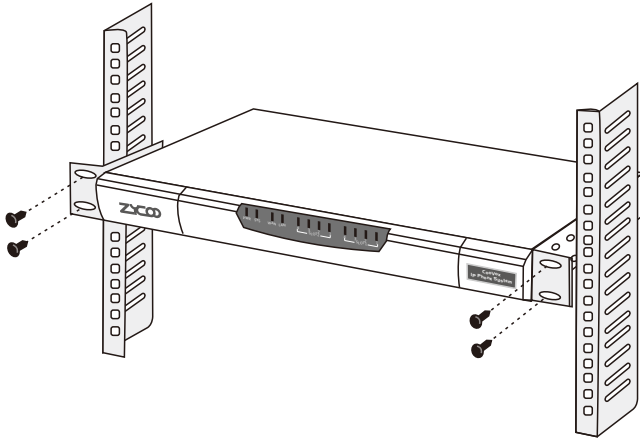

4. After the brackets are attached to the device, use suitable screws (not provided) to secure the brackets to the rack, as illustrated in the following figure.

Notes:

- Please ensure the correct installation for the grounding of the rack, which is the most important guarantee of avoiding ESD, electricity leakage, lightning, and electromagnetic interference;
- Please mount devices in sequence from the bottom to top of the rack to avoid overloading;
- Please avoid any heavy thing placed on the device to avoid any unexpected accidents;
- Please ensure heat dissipation and air circulation.

Connect to Ground

Connecting the device to ground is to quickly release the lightning over-voltage and over-current of the device, which is also a necessary measure to protect the body from electric shock.

In different environments, the device may be grounded differently. Two measures are given in the following, of which the Grounding bar is better for the protection of lightning. Users can try to choose the most appropriate measure according to different situation.

- If Coovox-U100 IP PBX is installed in the computer room, and the room has dedicated Grounding bar, then the using of ground wire to connect the device with the Grounding bar is put to the first consideration as shown in the following figure.

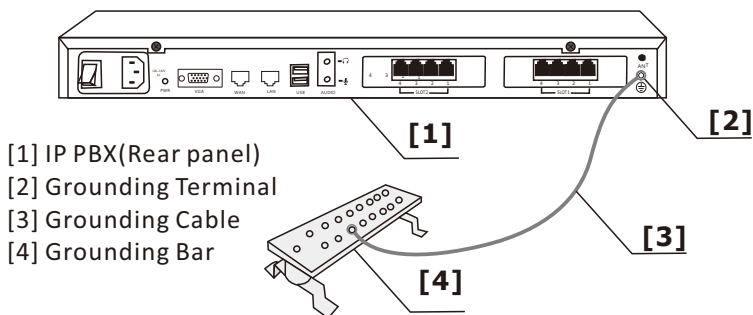

- If the device is installed in the normal environment, the device can be grounded via the PE (Protecting Earth) cable of the AC power supply as shown in the following figure.

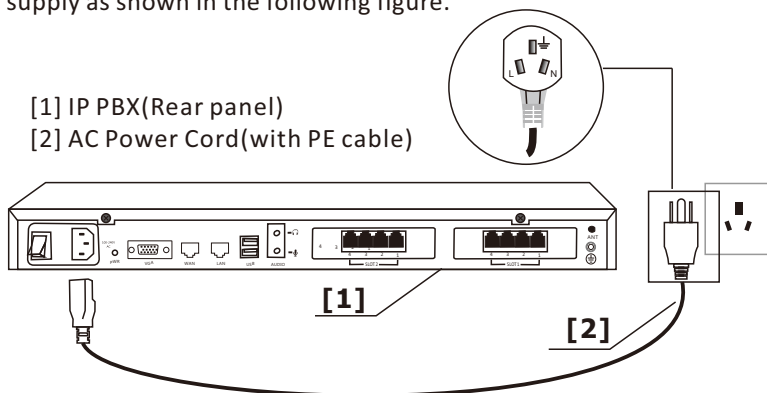

Notes:

If you intend to connect the device to the ground via the PE (Protecting Earth) cable of AC power cord, please make sure the PE (Protecting Earth) cable in the electrical outlet is well grounded in advance.

2.4 Physical Connection

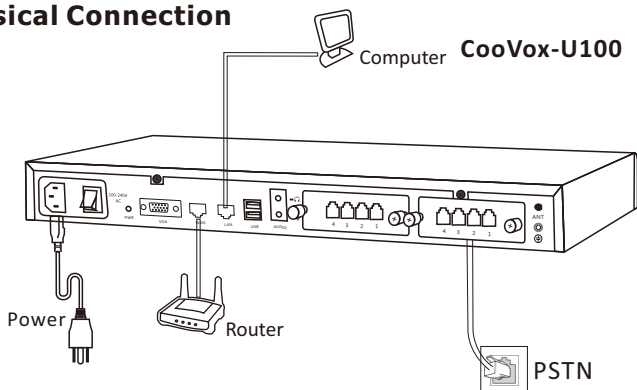

2.5 LED Definitions

Indication	Function	Status	Explanation		
PWR	Power Status	On	Power On		
		Off	Power Off		
SYS	System Status	Blink	System Works		
		Off	System Fails		
ETH	Data Status	Blink	Data Transport		
		Off	No Data Transport		
1-4(SLOT1/2)	SLOT1/2 Status	FXS	Green	Channel Loading Success	
			Blink	Channel Ringing	
			Off	Channel Loading Failure	
		FXO	Red	Channel Loading Success	
			Blink	Channel Ringing	
			Off	Channel Loading Failure	
		GSM	Red	Channel Loading Success	
			Blink	Channel Ringing	
			Off	Channel Loading Failure	
		E1/T1	L1	Red	Module Loading Success
				Off	Module Loading Failure
			L2	Red	CPE signal
				Green	NET signal
				Off	No signal
			L3	Red	SS7 signal
				Green	MFCR2 signal
Off	No signal				
L4	Red	Disconnected/ Alarm			
	Green	Connected/ No Alarm			
BRI	Red	TE Mode			
	Green	NT Mode			
	Off	Module Loading Failure			

3 Basic System Configuration

3.1 Web Login

- Step 1. Connect a computer and the CooVox device in the same network. IP address is usually in the 192.168.10.X segment.
- Step 2. Start a web browser. To use the user interface, you need a PC with Internet Explorer (version 7.0 or higher), Firefox, Chrome.
- Step 3. Enter the default address “http://192.168.10.100:9999” of the CooVox device into the URL address box.
- Step 4. Enter the default username (admin) and password (admin). Then click “Login” to enter the Web-based user interface.

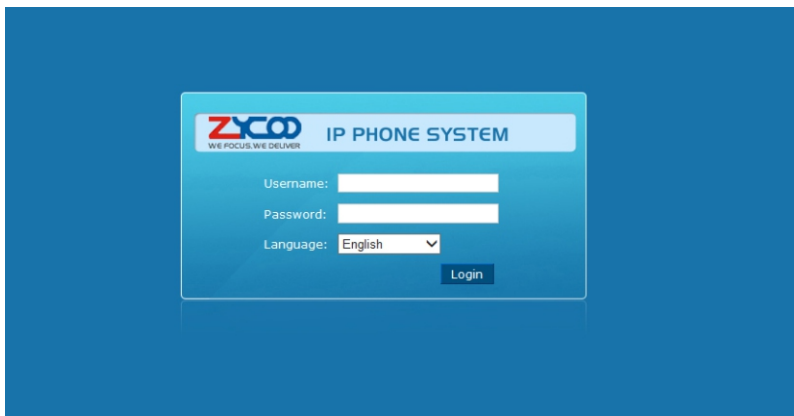

Default WAN IP address: 192.168.1.100
Default LAN IP address: 192.168.10.100
Default Username: admin
Default Password: admin

3.2 Network Configuration

Step 1. Go to Network Settings → Network

The screenshot shows a web-based configuration interface. On the left is a navigation menu with categories: Home, Operator, Basic, Inbound Control, Advanced, Network Settings (selected), Security, Report, and System. Under Network Settings, 'Network' is selected. The main content area is titled 'Network' and has three tabs: 'IPv4 Settings' (active), 'IPv6 Settings', and 'VLAN Settings'. The 'WAN Port Setup' section is expanded, showing the following fields: IP Assign: Static (dropdown), Hostname: CooVox-U100, IP Address: 192.168.1.100, Subnet Mask: 255.255.255.0, Gateway: 192.168.1.1, Primary DNS: 8.8.8.8, and Alternate DNS: (empty). Below this is the 'LAN Port Setup' section with fields for IP Address (192.168.10.100), Subnet Mask (255.255.255.0), and checkboxes for IP AddressV1 and IP AddressV2. At the bottom are 'Save' and 'Cancel' buttons.

Step 2. Configure the network information

There are three types of network connection. They are Static, DHCP, PPPoE(Point-to-Point Protocol over Ethernet). You can find detail settings in the user manual.

This is a close-up of the 'WAN Port Setup' section, specifically the 'IP Assign' dropdown menu. The dropdown is open, showing three options: 'Static' (highlighted in blue), 'DHCP', and 'PPPoE'. The other fields in the form are visible in the background: Hostname: CooVox-U100, IP Address: 192.168.1.100, Subnet Mask: 255.255.255.0, Gateway: 192.168.1.1, Primary DNS: 8.8.8.8, and Alternate DNS: (empty).

3.3 Choose the Module

Go to System → Module Settings

When using the module except FXO/FXS/GSM, you need to set the module parameters with the below page.

SLOT 1

Module Type:

Module Type: Select the module type of the device slot.

- FXS/FXO/GSM module Default type. You don't need set anything for these modules.

- E1/T1 module

SLOT 1

Module Type:

E1/T1 Settings:

Mode:

Signalling:

Framing:

Coding:

CRC4:

- ISDN BRI module

SLOT 1

Module Type:

BRI Settings:

Type of Port 1:

Type of Port 2:

Type of Port 3:

Type of Port 4:

3.4 Reset to factory

To reset the IP address to the default IP Address “192.168.1.100” (ETH) or reset the login password to default value, press the hardware reset button at the front panel more than 5 seconds. After the device is rebooted, you can login the management WEB interface within the same subnet of 192.168.1.x.

Press the “Reset” button, and all the system data will be reset to default; so if possible, back up the configuration file before reset.

4 Further Configuration

Thank you for purchasing ZYCOO products. The above steps introduce simple configuration for CooVox – U100. For further configuration, please refer to the user manual. If you have other questions, please contact the local dealer or distributor from which you purchased this product.

You can also browse our online FAQ resource at ZYCOO website first to check if it could solve your issue. If you need more support, please contact ZYCOO support team.

ZYCOO online FAQ:

www.zycoo.com/html/Knowledge_Base.html

Support team email address:

support@zycoo.com

Copyright © ZYCOO Co., Ltd. 2014

The logo for ZYCOO, featuring the letters ZYCOO in a bold, stylized, sans-serif font. The letters are interconnected, with the 'Y' and 'C' sharing a vertical stroke, and the 'O's being circular and touching each other and the 'C'.

We Focus • We Deliver