

Content

1. Description.....	3
1.1 USR-WP3.....	3
1.2 USR-WIFIIO-MINI.....	4
1.3 USR-WIFIIO-83.....	6
2. Webpage configuration.....	7
3. Software Instructions.....	11
3.1 Windows software.....	11
4. Appendix.....	17
5. Contact.....	18

1. Description

IOT series is designed and developed for terminal equipment in the field of smart home, Internet of Things, etc. Matched with our Windows/IOS/Android/MAC platform software and our back-end server, an ideal choice to realize remote control.

This series product is suitable for family use to build smart home for more comfortable life. Also it can be used in industry, and agriculture for low production cost, high efficiency by fulfilling the intelligence of the production control. Then, users will own more effective cost control and more strong profitability.

This WIFI-IOT control terminal series quits traditional wired connection, can work with WIFI connection so as to rapid deployment, for mobile use. There's no big changes and upgrading of original equipments under wireless remote control, it can make full use of your original product , no more cost for you.

1.1 USR-WP3

USR-WP3 is IOT wireless control smart socket.

It supports 110v/220v power, 3 channel power output, 2 plugs for each channel; support AP+STA work mode, can work as an AP, so pc/phone/tablet can join it, at the same time, can be used as STA to join your router.



USR-WP3

Hardware:

Power on, 3s later, the socket will turn to normal working mode. Then you can switch on/off the 3 rows (2 plugs each row) by WiFi. Also, you can use the 3 hardware switches to make it (see hardware diagram).

If the socket don't work properly or you set wrong parameter, pls restore to factory defaults: Press the 3 buttons at the same time for more than 3s.

Parameters:

- ◆Dimensions: (L*W*H)200*98*34(mm)
- ◆Working voltage: AC 110V/220V
- ◆Standby power consumption: 2W, Max: 3W
- ◆Working temperature: -25~75°C
- ◆Storage temperature: -40~85°C
- ◆Storage Humidity: 5%~95%RH
- ◆One channel (two plugs) maximum output current/voltage:10A 250VAC, 2000W
- ◆Socket maximum output power: 3000W
- ◆Packing list: USR-WP3*1, CD*1

1.2 USR-WIFIIO-MINI

USR-WIFIIO-MINI

This is a core remote control module, developers can use this to make there own products. The WIFI socket is one of our applications.

Hardware:

Power on, 3s later, it will turn to normal working mode. Then you can switch on/off the 3 rows by WiFi. Also, can use the 3 hardware switches.

If the panel don't work properly or you set wrong parameter, pls restore to factory defaults: Press the 3 buttons at the same time for more than 3s.

Parameter:

- ◆ Dimension: (L*W*H)80.4*60.3*25(mm)
- ◆ Working voltage: AC 110V/220V
- ◆ Standby power consumption: 2W, Max 3W
- ◆ Working temperature: -25~75°C
- ◆ Storage temperature: -40~85°C
- ◆ Storage Humidity: 5%~95%RH
- ◆ One channel maximum output current/voltage:10A 250VAC, 2000W
- ◆ Packing list: USR-WIFIIO-MINI*1, CD*1
- ◆ Customized service is available for VIP customers

Diagram:

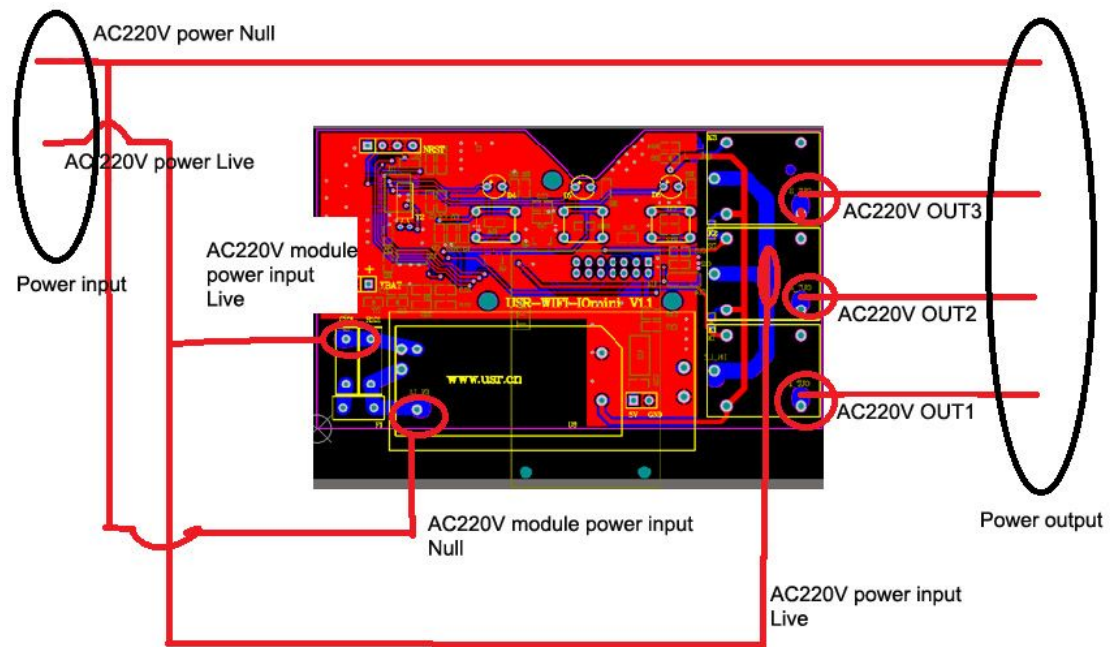

1.3 USR-WIFIIO-83



USR-WIFIIO-83

USR-WIFIIO-83 is designed to industrial usage.

Power on with matched 12v power adapter. After 3-5s, the relay will begin to work.

To restore factory defaults: open the shell, find the jumper hole near Reload, connect to GND more than 3s.

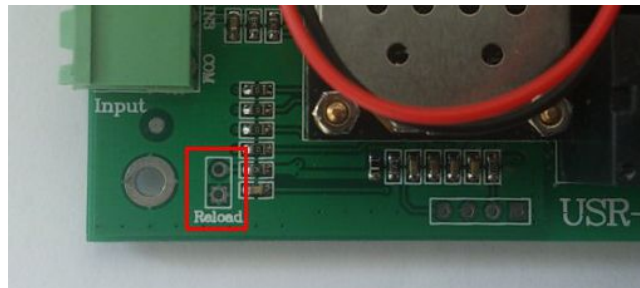

Parameters:

- ◆ Dimension: (L×W×H) 104.5*83*28.7mm, (antenna, external terminals and fixed edge on both sides not included are not included)
- ◆ Input voltage: DC 12V
- ◆ Number of Ports: 8 outputs, 3 inputs, No 1 and 10 in the output is public port
- ◆ Standby power consumption: 3W, Max 6W
- ◆ Input port work: Passive switch
- ◆ Port maximum current/voltage output: AC 250V/10A
- ◆ Working temperature: -25~75°C
- ◆ Storage temperature: -40~85°C
- ◆ Storage humidity: 5%~95%RH
- ◆ Packing list: antenna*1, USR-WIFIIO-83*1, CD*1, 12v power adapter*1

Diagram:

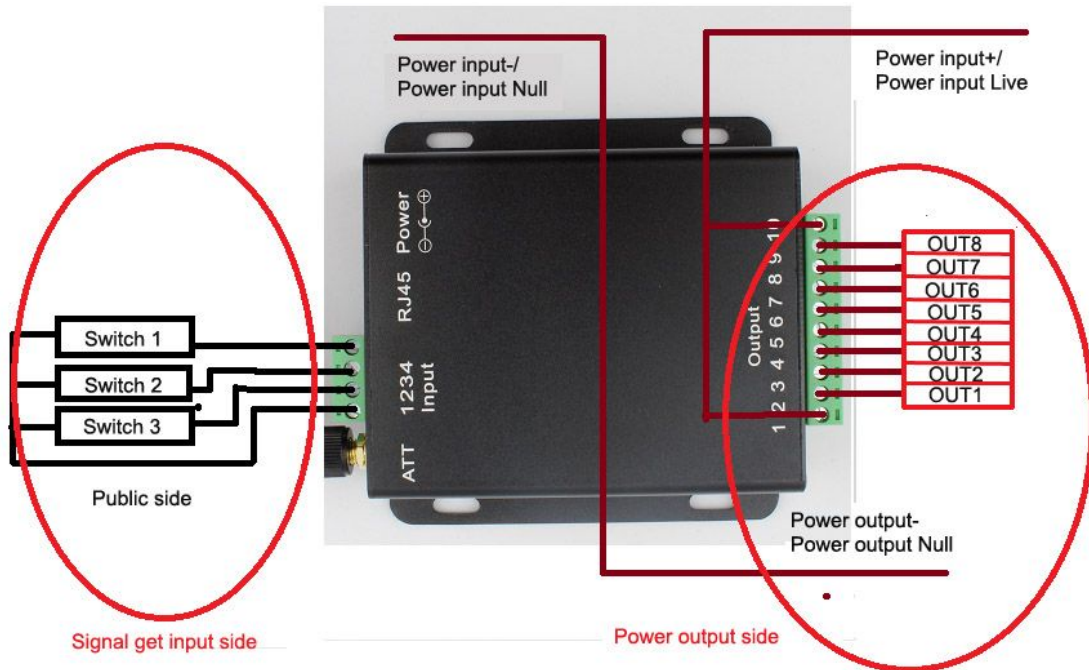

2. Webpage configuration

This chapter tells how to join the device to your local router network.

IOT series products default in AP mode, terminal webpage configuration are the same, the only difference is device name when you search or setup the wireless network, respectively “USR-WP3” and “USR-WIFIIO-83”. Take example of “USR-WIFIIO-83+ Windows XP” as below:

USR-WIFIIO-83+Windows XP configuration



1. Right click the network icon in the right bottom corner of PC
2. Choose “view available wireless networks”



3. Click refresh network list, choose USR-WIFIIO-83, connect, it will show connected on right side.



4. Open your browser, input default IP address "10.10.100.254", username and password default "admin", click OK



5. It will show some Chinese characters, don't worry, click OK twice until they disappear. Then choose English, will turn to below interface. Click OK to join the USR-WIFIIO-83 to your router.

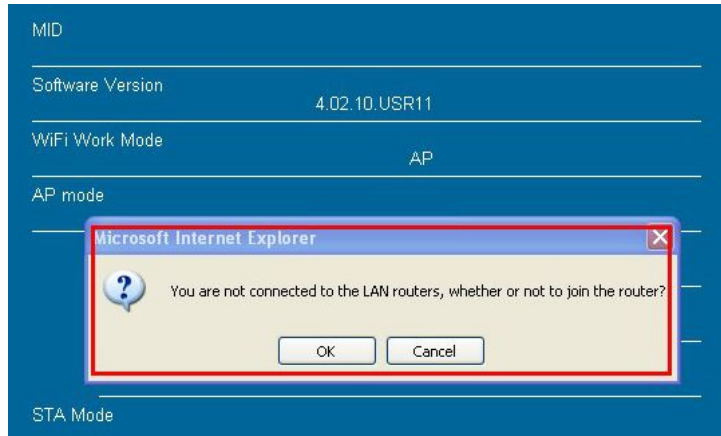

6. When it show "Click on the Search to choose near the ap!", click OK. Then click Scan.

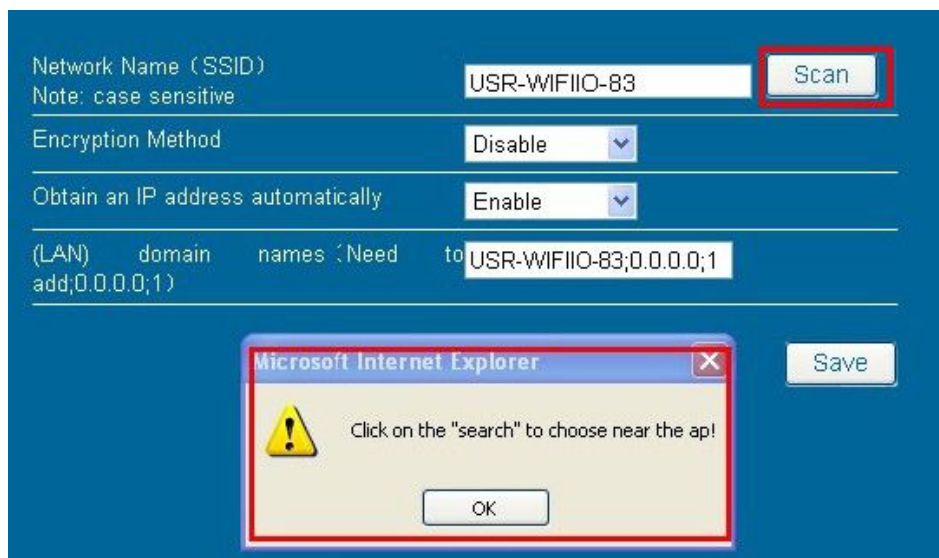

7. Choose your router and click OK.

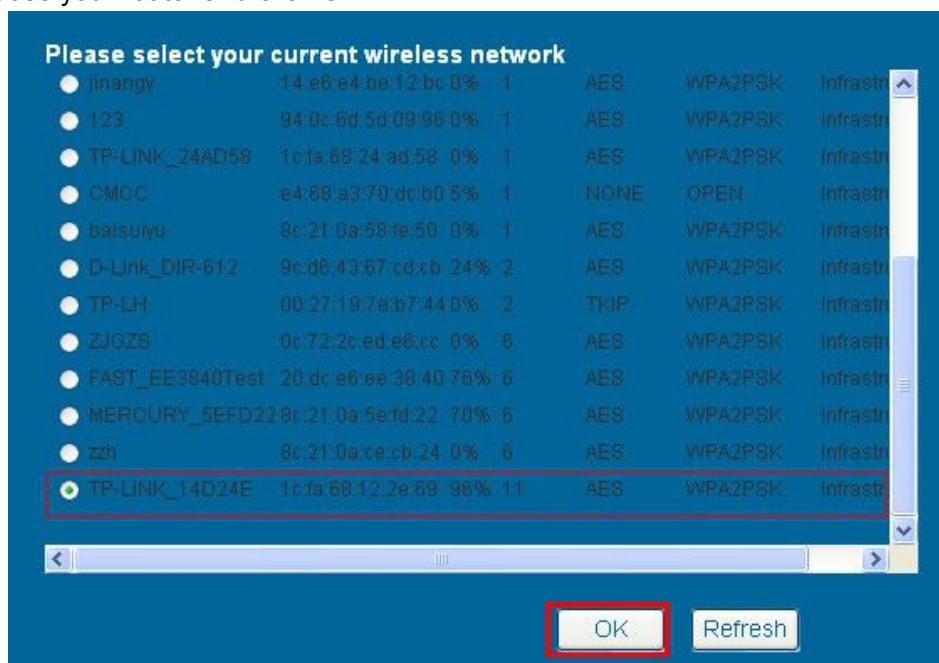

8. Encryption Method and Encryption Algorithm will show automatically. Input your router password and click Save.



The screenshot shows a configuration page with the following fields:

- Network Name (SSID): TP-LINK_14D24E (Note: case sensitive) with a Scan button.
- Encryption Method: WPA2PSK (dropdown).
- Encryption Algorithm: AES (dropdown).
- Password: A field with 12 dots, highlighted with a red box, and a Show passwords checkbox.
- Obtain an IP address automatically: Enable (dropdown).
- (LAN) domain names (Need add:0.0.0.0;1) to: USR-WIFIIO-83;0.0.0.0;1
- A Save button is highlighted with a red box at the bottom right.

9. Click Restart, wait for a while, when restart finished, you can close browser.

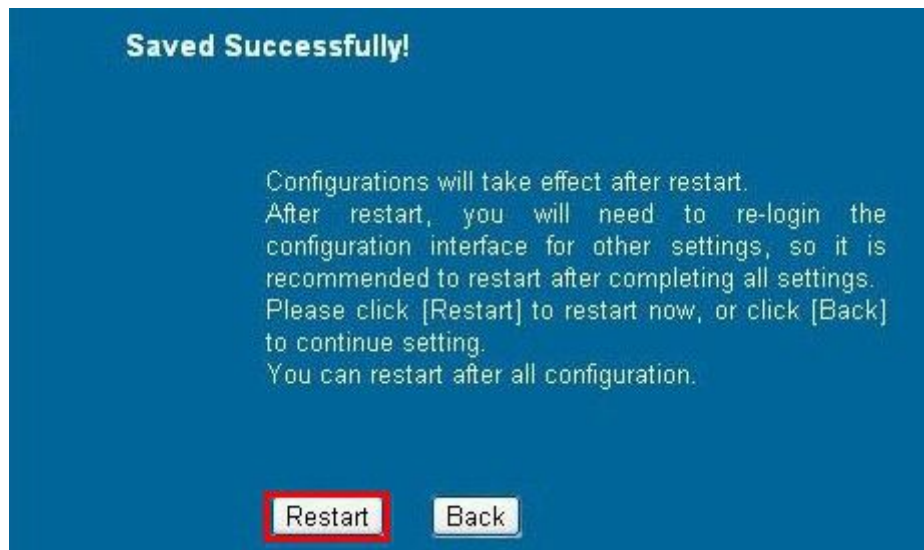

The screenshot shows a blue background with the following text:

Saved Successfully!

Configurations will take effect after restart.
After restart, you will need to re-login the configuration interface for other settings, so it is recommended to restart after completing all settings.
Please click [Restart] to restart now, or click [Back] to continue setting.
You can restart after all configuration.

At the bottom, there are two buttons: Restart (highlighted with a red box) and Back.

After configuration, the relay is in your LAN now. You can control relay by our software.

3. Software Instructions

3.1 Windows software

1. After webpage configuration, open the software in Windows



2. See the main interface below. Mainly include Device and User part. You can choose EN to English language.

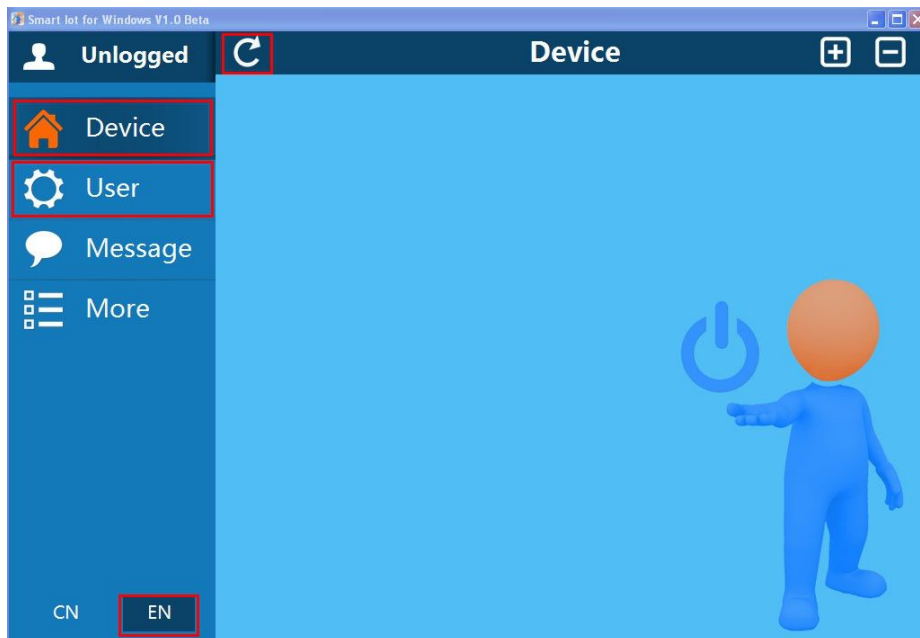

3. Click User part, here you can log in your account. First to Register

Login

Account:

Password:

Remember password

Auto Login

Login

Register

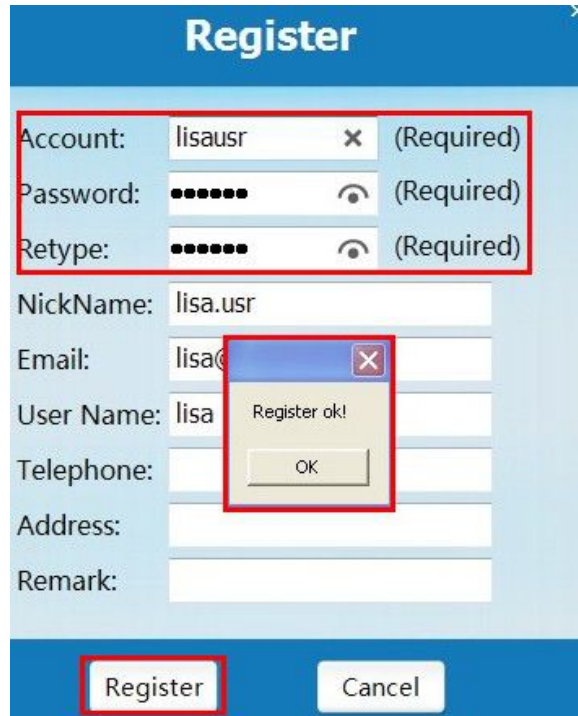

The image shows a 'Register' dialog box with the following fields and values:

- Account: lisausr (Required)
- Password: [masked] (Required)
- Retype: [masked] (Required)
- NickName: lisa.usr
- Email: lisa@ [masked]
- User Name: lisa
- Telephone: [empty]
- Address: [empty]
- Remark: [empty]

Buttons: Register, Cancel

A small 'Register ok!' dialog box is overlaid on the main form, with an 'OK' button.

Account, Password and Retype is required, click Register, it will show OK. Get back and log in the account you registered just now.

4. Click Device part, you can see all devices in LAN or remote.



Instructions:

1) USR-WIFIIO-83 is relay default name, D8-B0-4C-F2-25-D0 is the MAC address.

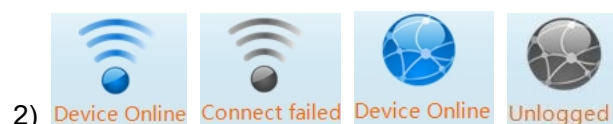

2) Blue means online, gray means offline; Signal icon means LAN, earth means remote.

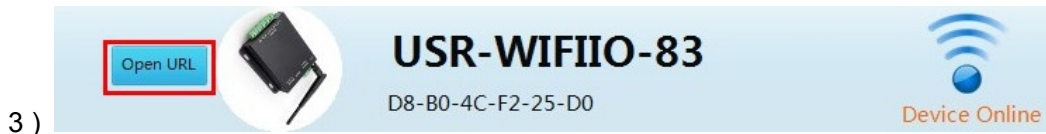

3)

Click the device Icon, it will show “Open URL”, you will open relay built-in webpage. This IP address is the one that router assigned to relay.

5. Click the device you want to control, will shown as below, number 1~8 means 1~8 channel, you can control each channel by these buttons:



Instructions:

- (1) Click this part to choose each channel icon.
- (2) Click this clock to timing function, you can add task and manage the exist tasks

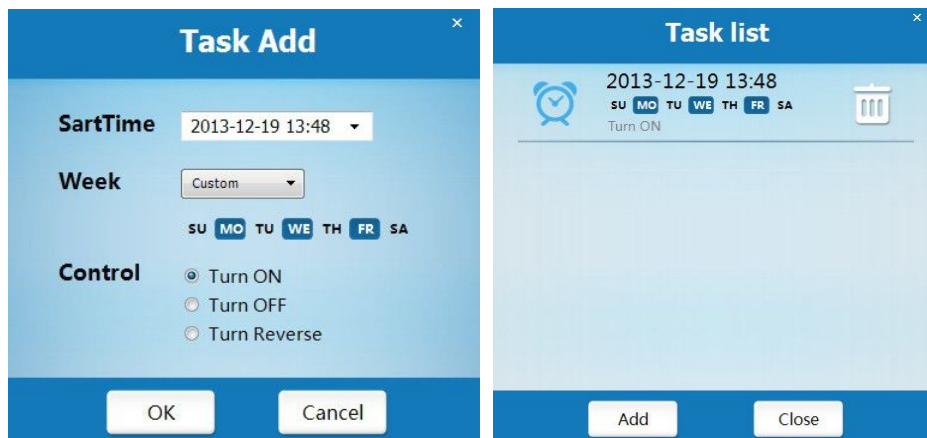

(3) Click this button to clock this channel, show this , you will not able to turn this channel on/off until unlock it.



(4) Relay status: yellow means on, gray means off

(5) This is used to set the whole relay. Click this, we can see:



All ON: turn all channels on All OFF: turn all channels off

Touch mode: in this mode, if you turn on the channel, it will keep on status, when you turn off, the channel is off. Click it to switch to Jog mode: in this mode, you need to keep pressing on, when you release, the channel will be off.

Start mode: click this to save status, next time when you power on relay, it will work in the status that you set

(6) This is also used to set the whole relay, here is the device setting interface:

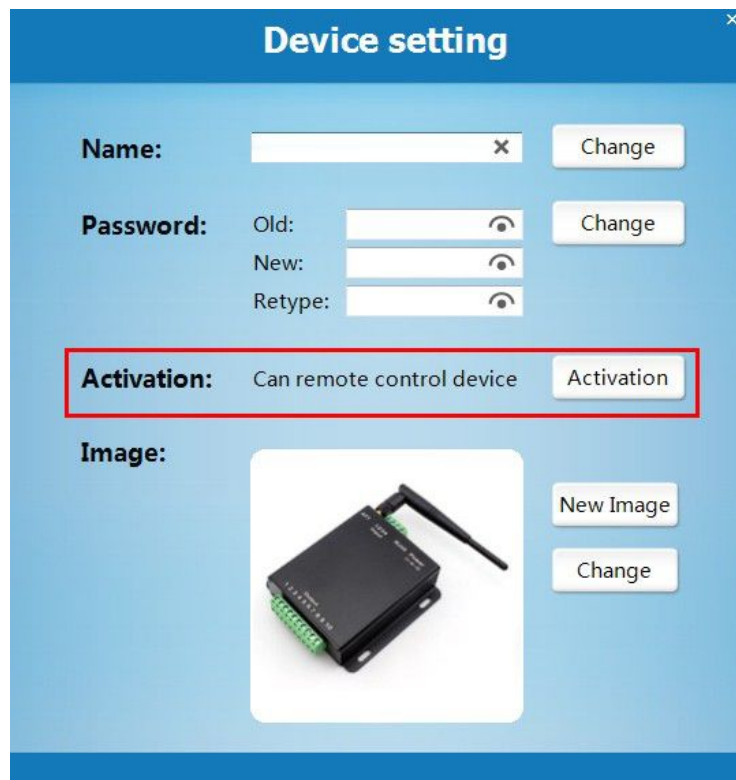

In the middle of the page, we can see Activation, with this, we can remote control the relay. (Log your account first) Click Activation, will show:

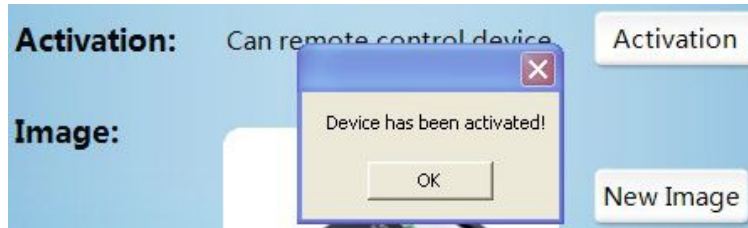

Device can be activated once, if has been activated, click again, it will show: 2,|*****r

You can also change device Name, and image here, click Change to save settings.

The Password is device password, default “admin”, module will restart after this setting. Refresh again and other PC in LAN want to control this device will need input password.

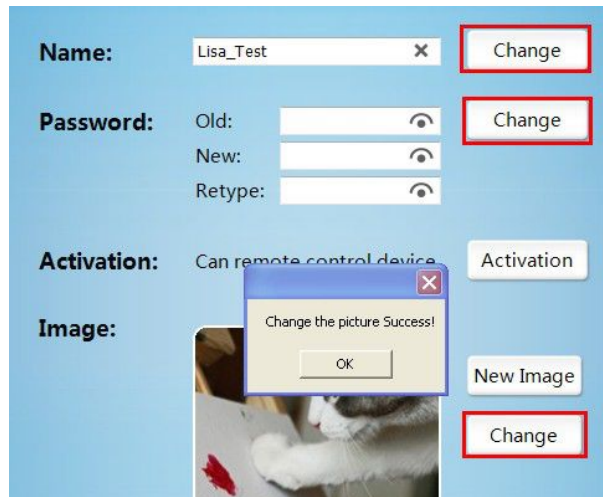

Get back to Device page, we can see the settings saved.



6. In User part, we can see below interface:

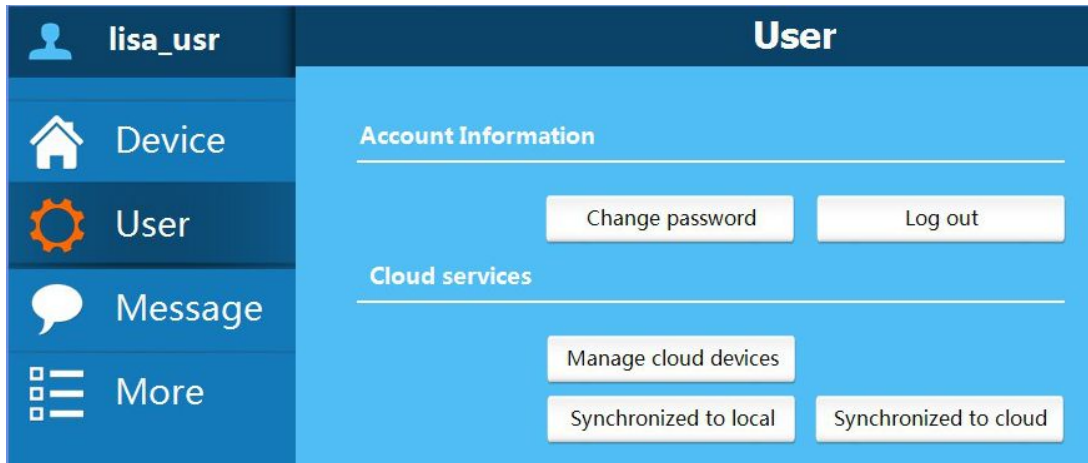

Account information: to change password and log out

Cloud Services instructions: This part is important in remote control.

1) Click Manage cloud devices, we can check the devices under your account. Only after log in your account, activation, can you see these devices



2) Synchronized to local: Synchronize your devices from cloud to local, this is used when you use other network/app, that is to control remotely, click this and devices under your account will show in your new network/app.

3) Synchronized to cloud: Synchronize your devices from local to cloud, this is used when you change some setting on local devices, click this, the cloud server will save your new settings

7. Now you can control the relay remotely:

Log in your device in other network---->open the app---->select User part---->log in your account---->click Synchronized to local---->select Device part and refresh

8. If you followed all above steps but still can not remote control, pls check this points:

1) Log in relay built-in webpage:



2) Socket Setting page, see Server Address, here should be “www.zhangkongbao.com” or “42.96.196.194”

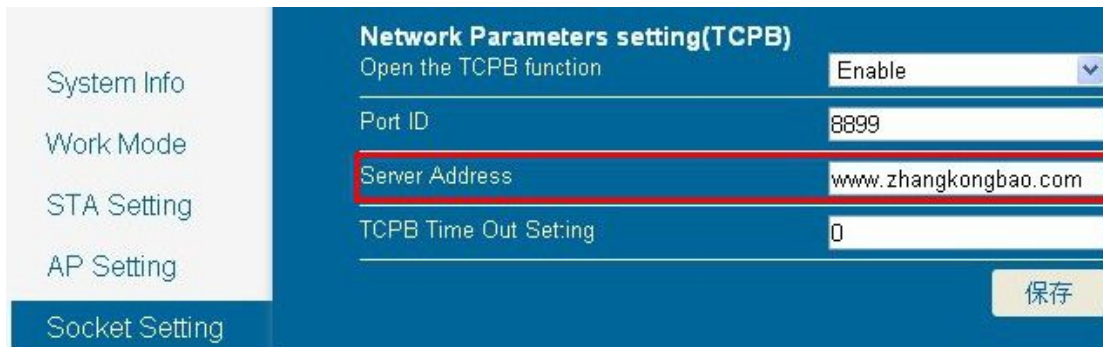

Change to this, click Save, in module admin page, choose Restart module.

4. Appendix

A. Triple protection make your control more safety

1. Built-in webpage need user name and password to log in.
2. Can set independent password for each device.
3. For remote control, user can register an account to manage cloud devices.

B. The essential steps of remote control

1. Register and log in your account
2. Activate the device
3. Synchronize to and from cloud

5. Contact

Company: Jinan USR IOT Technology Limited

Address: 1-728, Huizhan Guoji Cheng, Gaoxin Qu, Jinan, Shandong, China

Tel: 86-531-55507297 86-531-88826739

Web: www.tcp232.net

Email: freda@usr.so