

Infrared Mobile HD Digital Trail Camera

HC-300



User's Manual

Table of Contents

1	Instructions.....	1
1.1	General Description	1
1.2	Camera Body Interfaces	1
1.3	Camera Components And Features.....	2
1.4	Remote Control.....	3
1.4.1	Navigating	4
1.4.2	Characters.....	4
1.5	Shooting Information Display	4
1.6	MMS function.....	5
1.7	Supported Format.....	5
2	Cautions.....	6
3	Easy Operations.....	7
3.1	Power Supply.....	7
3.2	Insert the SD-card and the SIM-card.....	7
3.3	Power on and Enter into the ON Mode	8
3.4	Enter into the TEST Mode.....	8
3.4.1	Custom Settings.....	9
3.4.2	Manual Capturing.....	9
3.4.3	View Images or Videos.....	9
3.4.4	Send MMS.....	9
3.5	Power Off	9
4	Advanced Operations.....	10
4.1	Settings Menu	10
4.1.1	Camera setting.....	11
4.1.2	Video setting.....	11
4.1.3	System settings.....	12
4.1.4	Default Settings	13
4.1.5	General Settings.....	13
4.1.6	Set Camera Mode.....	13
4.1.7	Format SD-Card.....	14
4.1.8	Set Photo Size.....	14
4.1.9	Set Video Size.....	14

4.1.10 Set Date and Time	15
4.1.11 Set Photo Burst.....	15
4.1.12 Set Video Length	16
4.1.13 Set Video Sound.....	16
4.1.14 Set PIR Triggering Interval Time.....	16
4.1.15 Set PIR Sensitivity.....	17
4.1.16 Set Timer.....	17
4.1.17 MMS Settings.....	18
4.1.18 Set GSM Mode.....	18
4.1.19 Enter Password.....	19
4.2 Playback.....	19
4.2.1 Viewing Photo or Video	19
4.2.2 Delete Photo or Video	20
4.3 Laser Pointer.....	20
4.4 File Numbering.....	20
4.5 Firmware Upgrade.....	21
Appendix I: Technical Specifications.....	22
Appendix II: Parts List	23

1 Instructions

1.1 General Description

This camera, a digital trail camera with MMS function, is a surveillance camera working automatically. It can be triggered at once by any movement of human (or animals) in a certain region of interested (ROI) monitored by a high sensitive Passive Infrared (PIR) motion sensor, and then automatically captures high quality pictures (up to 12M pixels) or records HD video clips (1080P or 720P). Then it can send the pictures instantly to your mobile device via GPRS network. You'll be alerted just when something has happened.

At sunrise the unit begins to take color photos and video until there is insufficient light (dusk) when it begins to take infrared (monochrome) photos and video.

It is easy to use, because there is a 2 inch colorful LCD display on camera and a sound recorder, speaker embedded in the camera. A laser pointer is used to help target the photo area of the camera. And it supports MMS/SMS/E-mail via GPRS Network.

It is resistant against water and snow for outside uses. Furthermore, the camera can be used as a portable digital camera.

1.2 Camera Body Interface

The camera has the following I/O interfaces: USB connector, SD-card slot, TV output and external DC power connector.

On the back of camera, there is a lock for theft-proof and an adjuster to change the tilt when mounting on an irregular interface e.g. tree.

Take a few moments to familiarize yourself following the camera controls and displays. It is helpful to

bookmark this section and refer to it as you read through the rest of the manual.

1.3 Camera components and features

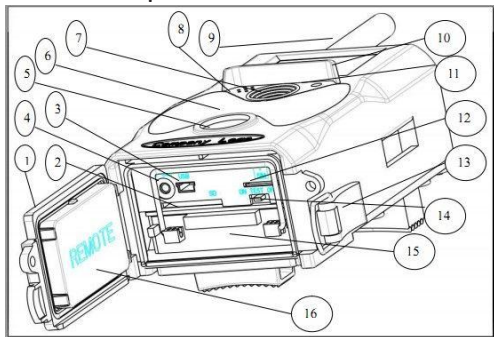

1) Bottom Cover

2) SD-Card Slot

3) USB Connector

4) TV Out connector

5) PIR

6) Infrared Flash

7) Lens

8) Microphone

9) GSM Antenna

10) 2 inch color LCD Display

11) Sound recorder

12) SIM card slot

13) Lock

14) Power switch

15) Battery Depot

16) Portable remote controller

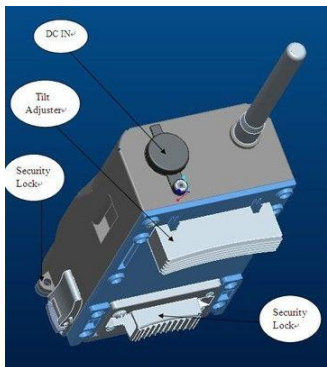

1.4 Remote Control

The remote control is an input device of the camera and is primarily used for customer settings and password input. This is an infrared type wireless remote control. The maximum remote distance is 9 meters. There are fifteen buttons on the remote control.

Note: (Remote control is inside of the camera)



1.4.1 Navigating

Press UP or DOWN to select or highlight the menu item, while press LEFT or RIGHT to select the option of each item and press OK to make selection.

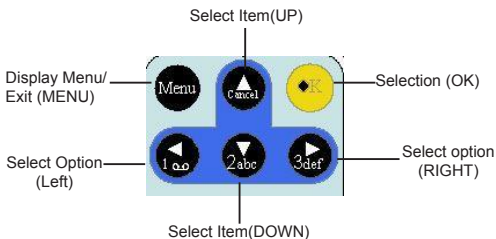

1.4.2 Characters

Press the punctuation “*” for laser pointer.

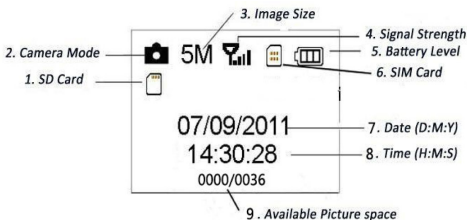

1.5 Shooting Information Display

When the camera is turned on (the power switch is slid to ON or TEST position), the shooting information will be displayed in the monitor.



1.6 MMS function

This camera can send pictures instantly to your mobile device via the GPRS network. You'll be alerted only when something has happened; The MMS through GPRS to send, so before using this function you need to make the settings in the txt file for mms. Review to related information, please refer to section 4.1 setting menu table "MMS mode" and 4.1.15 MMS settings.

SIM card Icon: There are two SIM card icons.  It means the SIM card is inserted and it works well.  It means can't work correctly because of low signal strength or other communications issues such as entering incorrect settings of your mobile carrier parameters.

There are 5 submenu settings about the MMS function. Including: APN, MMSC, WAP Gateway, MMS Phone, MMS Mail (refer to 4.1 table). MMS Set means to have the right MMS setting parameters according to your network. Send to means to input the phone number or email address which you want to send. All 5 submenus must have correct settings.

1.7 Supported Format

Item	Format
Photo	JPG
Video	AVI
File Format	FAT32

Here are some important notices. You don't need to concern about the file system format of the camera unless you have problems with reading the SD-card by your other equipment. If this happened, please format the SD-card in the camera or in a computer at first and then reinsert the card into your camera to make a try.

2 Cautions

The working voltage of the camera is 6V. The camera is supplied by four or eight AA batteries.

Please install batteries according to shown polarity.

Please unlock the write-protect before inserting the SD-card.

Please insert the SD-card when the power switch is at OFF position before testing the camera.

Please do not insert or take out the SD-card when the power switch is at ON position.

It is recommended to format the SD-card by the camera when used at the first time.

The camera will be in USB mode when connected to a USB port of a computer. In this case, the SD-card functions as a removable disk.

Please ensure sufficient power when having firmware upgrade, otherwise the upgrade process could be interrupted incorrectly. If any fault occurs after improper upgrading process, the camera may stop function properly.

As communications networks may vary reasons we can't guarantee 100% success by sending and receiving MMS.



3 Easy Operation

3.1 Power Supply

To supply power for the camera, four or eight AA size batteries are needed.

Open the bottom cover. Confirm that the power switch is at the OFF (Right) position, pull out the battery depot. Load the fully charged batteries into the depot according to the polarities sign shown below. Push back the battery compartment to the battery chamber.

The following batteries with 1.5V output can be used:

1. High-density and high-performance alkaline batteries (Recommended)

2. Rechargeable alkaline batteries

3. Rechargeable NiMH batteries

There are four battery slots. Slot 1 and 2 form one group ("1" will mark on depot), while slot 3 and 4 form the other group ("2" will mark on depot) where each group can supply the power individually.

When in low-battery state, camera will be automatically shut down. Please change the batteries in time. If you have set the MMS function, it will send you a SMS or Email to indicate the low battery situation.

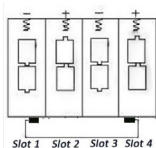

3.2 Insert the SD-card and the SIM-card

Open the bottom cover. Insert SD-card into the card slot with unmarked side upwards.

Please note that the SD-card can only be plugged in one direction. Make sure that the write-protect switch of the SD-card is on the "write" position otherwise the camera cannot be switch on. When use MMS/SMS/E-mail function, be sure to insert SIM-card into the SIM-

card slot with angle in the upper left.

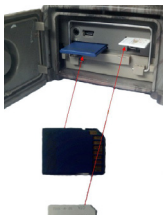

3.3 Power on and Enter into the ON Mode

Before switching on, please pay attention to the following:

1. Avoid temperature and motion disturbances that could be construed as animals or humans such as trees that are exposed to direct sunlight for much of the day or any other heat source. These may cause false triggers

2. The height from ground for placing the camera should 1 meter with the object. For example for deer waste height is good size appropriately. In general, one to two meters are preferred.

Slide the power switch to the ON position (Left) to power on the camera and enter into the ON mode. Before entering into the ON mode, you can adjust the camera the target area by laser pointer. Related information, please refer to section 4.3.

After switching on the camera, the motion indication LED (red) will blink for about 20s. The 20s is a buffering time before automatic capturing photos or videos, e.g. for closing and locking the bottom cover, fixing the camera on a tree and walk away.

In ON mode, it is unnecessary to use the remote control. The camera will take pictures or videos automatically according to the default settings or previous custom settings. The camera has the sound recording function, so the sound will be embedded in the video clip while capturing a video.

3.4 Enter into the TEST Mode

Slide the power switch to the TEST position (Middle) to enter into the TEST mode. There are some functions in TEST mode: Custom settings, manual capture, preview or send MMS manually.

3.4.1 Custom Settings

Press MENU on the remote control to enter into menu setting. The camera can be taken over control to manually customize the camera settings which display on the camera or external TV monitor. The detailed operations will be described in “Advanced Operations” chapter.

3.4.2 Manual Capturing

You can press OK to manually capture photos or recording video.

3.4.3 View Images or Videos

There are two ways to view the captured images or videos:

1. LCD screen on camera

2. TV monitors which connects to camera with TV cable

Press Right to view images, the latest image will be shown in the LCD screen on camera or TV monitor. Press UP to view the previous image and press DOWN for the next. The detailed operations like deleting images or videos will be described in “Advanced Operations” chapter.

3.4.4 Send MMS

The MMS function will be available after MMS Mode is set as “Instant”, any of 1-99 photos is optical for sending one day by GPRS network.

3.5 Power Off

Slide the power switch to OFF position (Right) to power off the camera. Please note that even in the OFF mode, the camera still consumes certain power at μA level.

Therefore, please remove the battery if the camera will not be used for a long time.

4 Advanced Operations

From the basic operations of the camera in previous chapter, we know that the camera has three basic operation modes:

1. OFF mode: Power switch is at OFF position (Right).
2. ON mode: Power switch is at ON position (Left).
3. TEST mode: Power switch is at TEST position (Middle).

In the above three modes, the OFF mode is the specified safe mode when replacing the SD-card or batteries and transporting the camera.

This chapter explains the advanced operations for customizing the camera settings. The settings can only be customized in TEST mode and the remote control is needed.

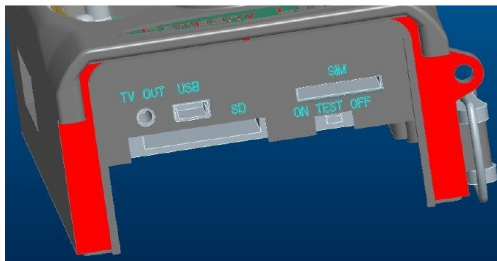

4.1 Settings Menu

To view the camera settings menu, press MENU in the TEST mode (called settings menu in this chapter). The settings menu will be shown on the LCD on camera or the external TV monitor.

4.1.1 Photo Setting:

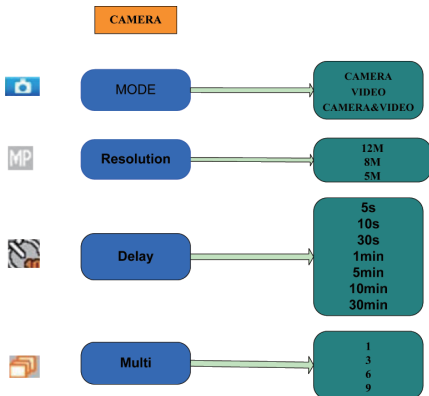

4.1.2 Video Setting:

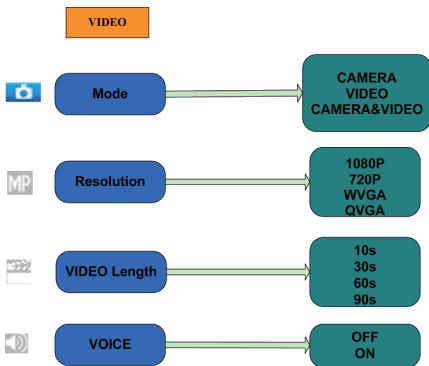

4.1.3 System Setting:

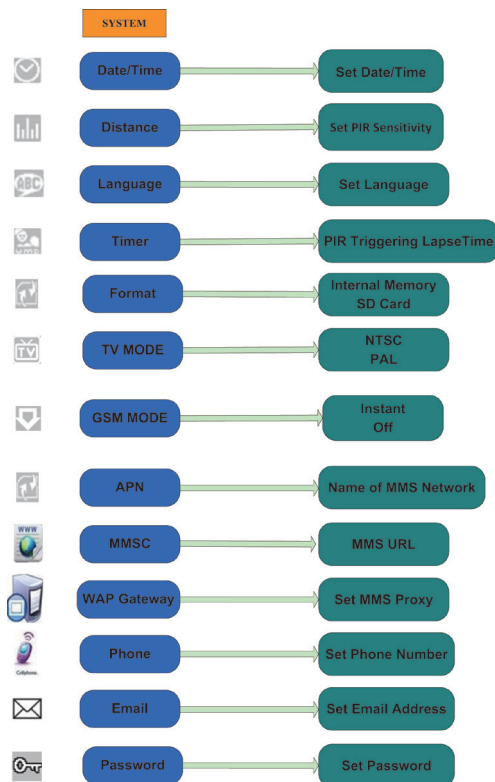

4.1.4 Default

Default Settings are listed as below:

Setting	Default	Items
Mode	Camera	Camera, Video, Camera & Video
Resolution (Camera)	12M	12M, 8M, 5M
Delay	5 Seconds	5-30 Seconds, 1-30 Minute
Multi	Single	Single, 3, 6, 9 Pictures
Resolution (Video)	1080P	1080P, 720P, WVGA, QVGA
Video Length	10s	10s, 30s, 60s, 90s
Voice	On	Off, On
Date/Time	1/1/2010 0:0:0 DD/MM/YY	YY/MM/DD, MM/DD/YY, DD/MM/YY Adjust
Distance	High	High, Normal, Low
Language	English	English, Deutsch
Timer	0 0 0 to 23 59 59	Adjust
Format	Internal Memory	Internal Memory, SD Card
TV Mode	NTSC	NTSC, PAL
GSM Mode	Instant (99)	Instant, Off
APN	"CMwap"	
MMSC	http://mmsc.monternet.com	
WAP Gateway	"10.0.0.172", 80	
MMS Phone		
MMS Email		
Password	Off	Off, On

4.1.5 General Settings

The operating steps are suitable for following menu items: Camera Mode, Photo Size, Video Size, Multi, Video Length, Delay, Timer and GSM Mode

4.1.6 Set Camera Mode

There are two camera modes: Camera or Video. The way to set the camera mode is via setting menu.

The following shows how to set camera mode to Video, provided that the previous option is Photo:

- Press MENU to display the setting menu.
- Press DOWN to select Mode.
- Press RIGHT to select Video.
- Press OK to save the current setting.

Press MENU to cancel setting and return to info

display.

4.1.7 Format SD-Card

The system will delete all images or videos stored in the SD-card after formatting, make sure that you have made a backup of important data.

- a) Press MENU to display the setting menu.
- b) Press RIGHT to select System setting.
- c) Press DOWN to select Format.
- d) Press RIGHT to select SD Card.
- e) Press OK to choose Enter to enter into submenu.
- f) Press RIGHT to select OK. OK will be highlighted.
- g) Press OK to start formatting the SD-card. During formatting, the display screen will show a message "Please Wait" as below.

Press MENU to cancel setting and return to info display.

Please Wait!

4.1.8 Set Photo Size

This parameter has three values:12MP, 8MP and 5MP. The default value is 12 mega pixels. The following shows how to set pixel size as 8M Pixel:

- a) Press MENU to display the setting menu.
- b) Press DOWN to select Resolution
- c) Press Right to select Photo Size.
- d) Press DOWN to select 8 M Pixel.
- e) Press OK to save the current setting, then press menu to return to info display.

Resolution

12M
8M
5M

Press MENU to cancel setting and return to info display.

4.1.9 Set Video Size

This parameter also has four values: 1080P, 720P, WVGA, QVGA.

The default value is 1080P,the following shows how to set 720P video size as provided that the previous option is at 1080P :

- a) Press MENU to display the setting menu.
- b) Press DOWN to select Resolution.
- c) Press RIGHT to select 720P.
- d) Press OK to save the current setting, then press menu to return to info display.

Press MENU to cancel setting and return to info display.

4.1.10 Set Date and Time

You can change the date and time of the device by setting this parameter when necessary, e.g., after every battery change. The date format is day/month/year, the time format is hour: minute: second. The valid value for year is between 2010 and 2050.

Provided that the date and time are needed to be set to November 15th, 2011 and half past ten, the steps are as following:

- a) Press MENU to display the setting menu.
- b) Press right button enter into "system"
- c) Press DOWN to select Date/Time. Date/Time
- d) Press Right Button to Display Date/Time Interface, Press UP and DOWN to change the Value
- e) Press OK to save all current setting, then press MENU to return to info display.

Press MENU to cancel setting and return to info display.

4.1.11 Set Multi

This parameter affects the number of pictures taken for each triggering in the camera mode. It has four values: "1 Photo" "3 Photos" and "3 Photos and 9 photos". Its default value is "1 Photo". The following shows how to set photo burst to 3 Photos , provided that the previous option is 1 Photo:

- a) Press MENU to display the setting menu.
- b) Press DOWN to select Multi.
- c) Press RIGHT to select 3 pictures.
- d) Press OK to save the current setting, then

Multi

press MENU to return to info display

Press MENU to cancel setting and return to info display

4.1.12 Set Video Length

The following shows how to set video length to 30 Seconds, provided that the previous value is 10 Seconds:

a) Press MENU to display the setting menu.

b) Press DOWN to select Video Length

c) Press RIGHT to select 30S.

VIDEO LENGTH

d) Press OK to save the current setting,
then press MENU to return to info display

Press MENU to cancel setting and exit.

4.1.13 Set Video Sound

The following shows how to turn off the sound of the video:

a) Press MENU to display the setting menu.

b) Press DOWN to select Voice.

VOICE

c) Press RIGHT to display the VOICE setting
Interface.

d) Press UP to select "OFF"

e) Press OK to save the current setting, then press
MENU to return to info display.

Press MENU to cancel setting and return to info display

4.1.14 Set PIR Triggering Interval Time

This parameter means that how long the PIR (Passive Infrared motion sensor) will be disabled after each triggering in ON mode. During this time the PIR of the device will not react to the motion of human (or animals). The minimum interval is 5 seconds, it means the PIR works all the time and media is taken almost continuously. The maximum interval is 30 minutes, it means the PIR will be disabled for 30 minutes after each triggering. The default value is 5 seconds.

The following shows how to set PIR Triggering Interval Time as 1 minute provided that previous option is 5

seconds.

- a) Press MENU to display the setting menu. **DELAY**
- b) Press DOWN to select Delay.
- c) Press RIGHT to enter in to the interval setting.
- d) Press DOWN to select 1 minute.
- e) Press OK to save the current setting, then press

MENU to return to info display.

Press MENU to cancel setting and return to info display.

4.1.15 Set PIR Sensitivity

This parameter defines the sensitivity of the PIR. There are three parameters: High, Normal, and Low. The default value is "Normal". The higher degree indicates that the Camera is more easily triggered by motion, taking more pictures or recording more videos. It is recommended to use high sensitivity indoors or in an environment with little interference, and to use lower sensitivity for outdoor or environment with lots of Interference like hot wind, smoke, near window etc. Furthermore, the sensitivity of the PIR is strongly related to the temperature. Higher temperature leads to lower sensitivity. Therefore it is suggested to set a higher sensitivity for high temperature environment.

The following shows how to set PIR sensitivity as Low provided that the previous option is High.

- a) Press MENU to display the setting menu.
- b) Press Down to select Distance **Distance**
- c) Press RIGHT to enter selection
- d) Press DOWN to select "LOW".
- e) Press OK to save the current setting, then press

MENU to return to info display.

Press MENU to cancel setting and return to info display.

4.1.16 Set Timer

This parameter defines a certain time lapse in a day when The Camera can be triggered. In the rest of the

time the device is shut off. The effective value of the hour ranges from 0 to 23 while the minute ranges from 0 to 59.

Provided that the camera should work from eight a.m. to five p.m., the steps are as follows:

a) Press MENU to display the setting menu. Timer

b) Press DOWN to select Timer.

e) Press RIGHT to select item, press UP or DOWN to change the value until the start time changes to 8 and the stop time changes to 17.

f) Press OK to save all current setting, then press MENU to return to info display.

Press MENU to return to previous menu.

4.1.17 MMS Settings

There are some settings to be entered, the steps are as follows:

1. Edit the file ' gsm_info.txt ' in the computer to set the MMS parameters, then save it to SD card, below is for reference:



```
gsm_info - 记事本
文件(F) 编辑(E) 格式(O) 查看(V) 帮助(H)
MMS_APN:"APN", "User", "Password"
MMS_MMSC:http://mmsc.monternet.com
MMS_GATEWAY:"10.0.0.172", 80
MMS_PHONE:number1; number2; number3, number4
MMS_EMAIL:email1; email2; email3; email4
```

Please note that this is only an example, for more details please contact your network service provider, and 3 network provider parameters needs to be edited, PHONE and EMAIL could be added up to 4.

2. Load the fully charged batteries.

3. Insert SD card with the txt file.

4. Insert SIM card.

5. Power on and entering into the TEST Mode.

4.1.18 Set MMS Mode

The following shows how to set the GSM mode to Off provided that the previous option is Instant:

a) Press MENU to display the setting menu.

- b) Press DOWN to select GSM Mode.
- c) Press RIGHT to select Off.
- d) Press OK to save the current setting, then press MENU to return to info display.

Press MENU to cancel setting and return to info display.

If you choose “Instant”, you need to select how many MMS you want to send for economy consideration. You can choose 0 to 99 pictures.

4.1.19 Enter Password

If the password setting is selected as On, after switching on the camera, the LCD screen on camera will prompt to enter password. The default password is off. It can be changed where the steps are as following:

- a) Press MENU to display the setting menu.
- b) Press DOWN to select Password.
- c) Press DOWN to select On, then press Right to select 4 numbers as password
- d) Press OK to save the current setting, then press MENU to return to info display.
- f) The LCD screen will prompt to enter password next time you switch on the camera.

Press MENU to cancel setting and return to previous menu.

4.2 Playback

In playback mode, images or videos can be viewed, deleted. The images and videos can be viewed on: LCD screen on camera and TV monitor which connect to camera with TV cable. For simplicity, operations with PC won't be introduced here.

4.2.1 Viewing Photo or Video

- a) Switch to TEST mode and enter into info display.
- b) Press Right to view the latest picture (or video) in LCD screen on camera, TV monitor or Image viewer with TV-in connector.
- c) Press Left to start playing the video when viewing

d) Press Left again to stop playing the video.

e) Press UP to view the previous picture (or video) and DOWN for the next.

f) Press OK to return to info display.

When viewing images, the total number of all images in the SD-card and the index of the displaying image will be shown respectively.

4.2.2 Delete Photo or Video

The operations are as following:

a) Press Right to display Photos and Videos.

b) Press Menu to select Delete.

c) Press Right to select delete current or delete all.

d) Press OK, Cancel and OK are prompted.

e) Press OK to delete the image or video.

Press cancel to cancel, then press MENU and OK to return to info display

Please note that after deleting a picture or a video file, the deleted files can't be restored! Furthermore, in order to delete all the images and video clips in the SD-card, it is suggested to format the SD-card, please refer to 4.1.7.

4.3 Laser Pointer

The laser pointer can be turned on and is especially useful when it is somewhat dark as an additional function for pointing to an object or a certain region of interested (ROI).

Press* to turn on the laser light in TEST mode and use the tilt adjuster on the back of camera to adjust the angle of capturing direction.

NOTE: Please note that the laser could be harmful to the eyes if pointed at other person.

4.4 File Numbering

Images and videos are separately saved in the pre-named folder (104MEDIA). File numbering continues by adding one to the last number for each new image or video. The saving name is like PTDC0001.JPB or

PTDC0001.AVI.Through the suffix you can distinguish whether the file is an image(with suffix.jpg)or a video(with suffix.avi).

4.5 Firmware Upgrade

This camera is equipped with an automatic upgrade function for you. Upgrading is needed only when an improved firmware is available. The operations are as following:

- 1.Unzip the update file
- 2.Copy the FW18NA.bin to SD card.
- 3.Insert the SD card into the camera.
- 4.Power on the camera(in Test mode).
- 5.The camera will read it and update itself automatically. When updating the camera, its screen is black.
- 6.The screen will light on after being finished
- 7.Plug out the SD card, then insert it into pc, delete the FW18NA.bin in the SD card.(If you don't do this, the camera will enter update mode when power on again).
- 8.Insert the SD card into the camera for its working.

Appendix I: Technical Specifications

Image sensor	5MP Color CMOS
Lens	F/NO=3.0, FOV(Field of View)=60°
IR Flash	65feet/20m
LCD Display	2" TFT
Memory Card	From 20 MB to 32 GB
Picture Resolution	12M = 4000x3000 , 8M = 3200x2400, 5M = 2592x1944
Video Resolution	1080P (15fps),720P (30fps)
Video length	10s – 90s
Camera+video	First take Picture then Video
PIR sensor	Multi zone
PIR sensing distance	65feet/20m(Below 77°F/25°C at the Normal Level)
PIR sensing Angle	65°
PIR Sensitivity	Adjustable (High/Normal/Low)
Operation mode	CAMERA, VIDEO,CAMERA&VIDEO
Trigger Time	1.1s
Trigger interval	5sec. - 30min; Programmable
Timer	Time Lapse Programmable
Time stamp	Date and Time
Photo Burst	1, 3, 6, 9
Power Supply	8×AA or 4×AA or solar power supply
Stand-by Current	< 0.25 mA (<6mAh/Day)
Power Consumption	400 videos(interval=5min,video length=10s); >500 MMS(use 8*AA batteries)
Microphone/speaker	Available
Low Battery SMS Alert	Send "Low Battery"
Mounting	Rope/Belt/Python lock
Dimensions	145x80 x55 mm
Weight	0.3KG
Waterproof grade	IP54
Operation temperature	-20 - +60°C / -30 - +70°C
Operation humidity	5% ~ 95%
Security authentication	FCC, CE, RoHS

Appendix II: Parts List

Part Name	Quantity
Digital Camera	1
Wireless Remote	1
USB Cable	1
TV cable	1
Belt One	1
User Manual	1
Antenna One	1
SD card	Optional
Black 940NM IR flash	Optional
Battery	Not included
Solar power supply	Optional

