

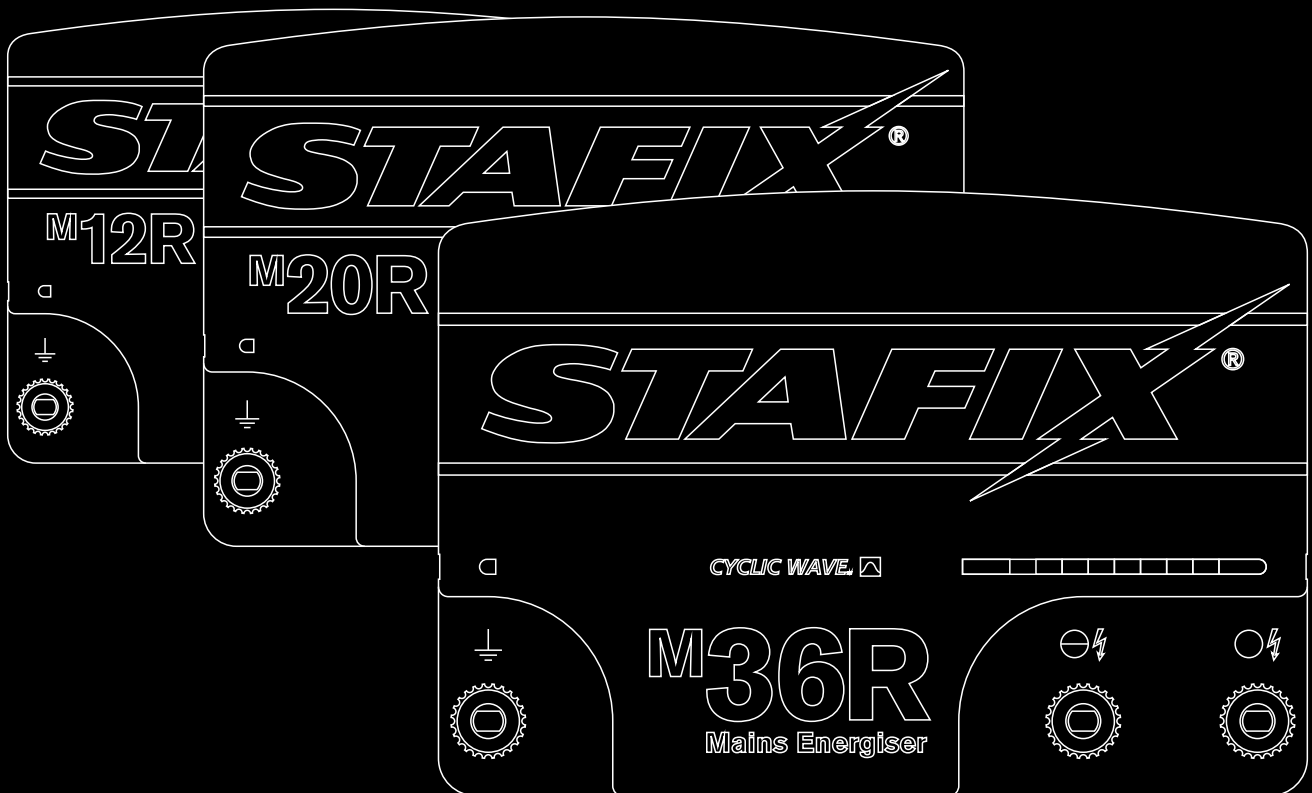

User Manual

M12R M20R M36R Mains Energiser

M12R / M12RS / M12RE / M12RSE
M20R / M20RS / M20RE / M20RSE
M36R / M36RS / M36RE / M36RSE



100-240 V



Warning: Read all instructions
Save these instructions

innovation

technology

performance

power

Contents

| | |
|--|---|
| Electric fencing and your Stafix energiser..... | 1 |
| Parts of the energiser | 1 |
| Installation | 1 |
| Operation | 2 |
| The Remote Control Fence Compass..... | 2 |
| Communication between the energiser and the Remote Control Fence Compass | 4 |
| Building a permanent electric fence..... | 5 |
| Safety considerations..... | 6 |
| Frequently asked questions/ Troubleshooting | 8 |
| Servicing..... | 9 |

© Tru-Test Limited, 2003-2005. All rights reserved.

Stafix, M12R, M20R, M36R, Remote Control Fence Compass and Cyclic Wave are trademarks of Tru-Test Corporation Limited.

No part of this publication may be photocopied, reproduced, stored in a retrieval system, or transmitted in any form or by any means, electronic, mechanical, photocopying, recording or otherwise without the prior written permission of Tru-Test Limited. Product specifications may change without prior notice.

For more information about the Stafix range of quality products, see www.stafix.com.
806259 Issue 1 4/05

Product specifications

Dimensions

| | |
|-----------------|--|
| Energiser | 350 x 240 x 115 mm (14 x 9½ x 4½") WxHxD |
| Packaged Weight | 8.0 kg (17 lb, 10 oz) |

| | M12R and M12RS | M20R and M20RS | M36R and M36RS |
|------------------------|--|--|--|
| Power Consumption | 20 W | 33 W | 52 W |
| Maximum Output Voltage | up to 9000 V open circuit up to 9000 V at 500 Ω | up to 9500 V open circuit up to 8400 V at 500 Ω | up to 9500 V open circuit up to 8400 V at 500 Ω |
| Maximum Output Energy | up to 14.6 J at 75 Ω up to 5.8 J at 500 Ω | up to 22.0 J at 50 Ω up to 7.3 J at 500 Ω | up to 36.5 J at 50 Ω up to 6.7 J at 500 Ω |
| Stored Energy | 20 J | 34 J | 54 J |

| Europe only | M12RE and M12RSE | M20RE and M20RSE | M36RE and M36RSE |
|------------------------|--|--|--|
| Power Consumption | 20 W | 33 W | 52 W |
| Maximum Output Voltage | up to 6400 V open circuit up to 6400 V at 500 Ω | up to 6700 V open circuit up to 6600 V at 500 Ω | up to 6700 V open circuit up to 6600 V at 500 Ω |
| Maximum Output Energy | up to 14.6 J at 75 Ω up to 4.9 J at 500 Ω | up to 22.0 J at 50 Ω up to 4.9 J at 500 Ω | up to 36.5 J at 50 Ω up to 4.96 J at 500 Ω |
| Stored Energy | 20 J | 34 J | 54 J |

Electric fencing and your Stafix energiser

Congratulations on your purchase of a Stafix energiser. This product has been constructed using the latest technology and construction techniques. It has been engineered to give superior performance and many years of service.

It is important to read these instructions carefully and thoroughly. They contain important safety information and will assist you in ensuring that your electric fencing system gives maximum performance and reliability.

Warning!

- *USA and Canada:* To reduce the risk of electric shock, the energiser has a polarised plug (one blade is wider than the other). This plug will fit in a polarised outlet one way. If the plug does not fit fully in the outlet, reverse the plug. If it still does not fit, contact a qualified electrician to install the proper outlet. Do not change the plug in any way.
- Switch the energiser off before installation or performing any work on the fence.
- Read all of the safety instructions in this manual carefully before installing the energiser.
- Check your installation to ensure that it complies with all local safety regulations.
- The energiser must be located in a shelter, and the power supply cable must not be handled when the temperature is below 5 °C.
- Do not connect simultaneously to a fence and to any other device such as a cattle trainer or a poultry trainer. Otherwise, lightning striking your fence will be conducted to all other devices.

Note: This product has been designed for use with electric animal fences.

Which energiser do I have?

This user manual covers several models of energisers: M12RS, M20RS and M36RS energisers. Remote System (RS) energisers are supplied with a Remote Control Fence Compass.

M12RSE, M20RSE and M36RSE energisers. These energisers are the European equivalent of the RS energisers.

M12R, M20R and M36R energisers. Remote Ready (R) energisers are not equipped with a Remote Control Fence Compass. You can configure these energisers to accept commands from a Remote Control Fence Compass if you already own one, or you decide to buy one at a later date.

M12RE, M20RE and M36RE energisers. These energisers are the European equivalent of the R energisers.

What's inside the box?

- Stafix M12R, M20R or M36R energiser
- Product warranty card
- Customer service card
- User manual

If you have purchased a M12RS/RSE, M20RS/RSE, or M36RS/RSE, you will also find a:

- Remote Control Fence Compass
- Leather pouch with a clip for the remote control

How does an electric fence work?

An electric fence system comprises an energiser and an insulated fence. The energiser puts very short pulses of electricity onto the fence line. These pulses have a high voltage, but are of very short duration (less than 3/10,000ths of a second). However, a shock from an electric fence pulse is very uncomfortable and animals quickly learn to respect electric fences. An electric fence is not only a physical barrier, but is also a strong psychological barrier.

What are the benefits of an electric fence?

An electric fence has many benefits over conventional fencing:

- Requires less labour and material to construct than conventional fencing.
- Flexibility to change or add paddocks when required. The use of strip grazing techniques can allow temporary fencing to be quickly and easily erected or removed.
- Controls a broader range of animals.
- Minimises damage to expensive livestock when compared with other fencing mechanisms, for example barbed wire.

Parts of the energiser



Explanation of symbols that may be on your energiser



Indicates that, to reduce the risk of electric shock, the energiser should be opened or repaired only by qualified Stafix-appointed personnel.



Read full instructions before use.



Indicates that the energiser is of a double-insulated construction.

Installation

- Mount the energiser close to a power outlet.
- Mount the energiser out of reach of children.
- Use the template printed on the back page of this manual to mount the energiser onto a wall or vertical beam.
- Connect the Fence earth terminal to a separate earth system that is at least 10 m (33') from other earth systems.
- Connect the Fence output terminal to the fence. Use either the low voltage (yellow) or high voltage (red) fence output terminal.

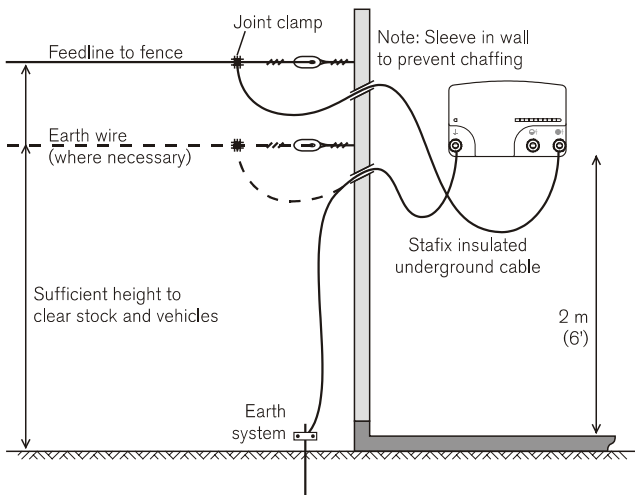

Energiser fence output terminals

The energiser has two Fence output terminals – high voltage (red) and low voltage (yellow). Although the low voltage terminal produces a lower voltage than the high voltage terminal, it *delivers the same amount of energy*.

The low voltage terminal is used in dry areas, where sparks from a higher voltage may cause a fire, or when special fire department regulations are in force. This terminal can also be used to configure a three-wire bi-polar fencing system.

Operation

- Turn on the power supply.

Reading voltage

The LED display shows the voltage at the output terminals of the energiser.

When first connected to the power source, all light segments on the LED display illuminate. They then illuminate separately from left to right and back again. This indicates that the energiser is operating normally. The LED display, then, briefly displays a light sequence that identifies the address setting of the energiser.

After three seconds, the energiser starts pulsing. Each of the light segments on the LED display represent an increment of approximately 1 kV (1000 V) of output voltage. For example, if the first 4 segments are illuminated at each pulse, the output voltage is approximately 4 kV (4000 V). (For the M12RE/RSE, M20RE/RSE and M36RE/RSE, this increment is approximately 800 V).



If you see only red lights at each pulse and no green lights, this means that your fence line is very heavily loaded, and you need to look for faults on the fence line. See *Using the fault finder* on page 3.

Full-power mode (M36R energisers only)

While the energiser is pulsing, if the large, green light segment on the right is lit up continuously, it is operating in full-power mode. The energiser switches to full-power mode when there is a heavy load on the fence.



The Remote Control Fence Compass

The Remote Control Fence Compass is three tools in one. It acts as a:

- Remote control – Switching the energiser on or off from a remote location anywhere on the electric fence system
- Fault finder – Assisting in the location of faults anywhere on the fence system
- Volt meter – Providing instant feedback on fence performance (voltage and current)

Parts of the Remote Control Fence Compass

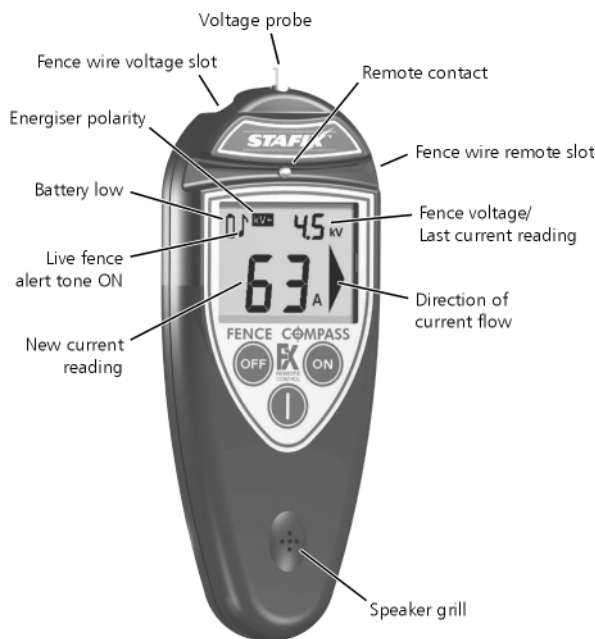

Using the remote control

To turn on the fence:

- 1 Press **⏻** to switch on the remote control.
- 2 Insert the fence wire into the Fence wire remote slot, ensuring that the fence wire touches the Remote contact.
- 3 Press **⏻** to power the fence. The remote control will beep with each pulse of the energiser.

Tip: If the remote control doesn't work, the fence wire has probably rusted or oxidised. Try rubbing the Remote contact against the fence wire to break through the layer of rust or oxidation.

To turn off the fence:

- 1 Press **⏻** to switch on the remote control.
- 2 Insert the fence wire into the Fence wire remote slot, ensuring that the fence wire touches the Remote contact.
- 3 Press **⏻**.

Warning!

- Do not touch the fence until the beeping has stopped.
- The energiser is designed to automatically reactivate following an interruption to the input power supply. This will occur even if it was deactivated using the remote control before the power failed. For this reason, it is strongly recommended that if you are working on a section of fence for an extended period, you should either safely isolate the section with a cut-out switch, or unplug the energiser from the power outlet.

Using the fault finder

Current flows through the path of least resistance. If the fence has a short circuit, more current will flow. Large flows of current load the energiser and fence causing lower voltage readings.

The fault finder is designed to direct the user to the strongest current flow. The current will flow towards a leak much like water draining from a bath and serves as a guide to point to the leak or fault.

Single electric wire

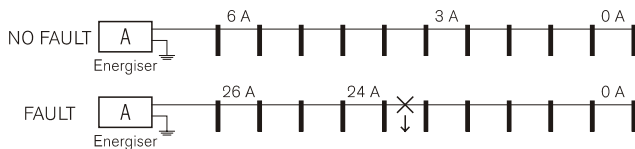

Earth wire return

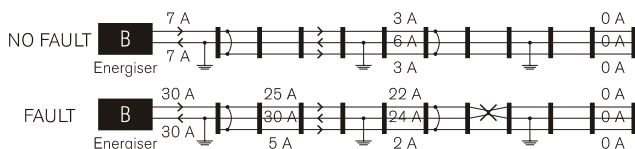

If voltage has dropped on the fence system, it is necessary to identify the cause. (See *Frequently asked questions/Troubleshooting* on page 8.) Possible causes of poor fence performance are short circuits or arcing faults. Location and repair of these faults is often difficult. The fault finding function has been developed to reduce the amount of time spent in locating fence line faults. Regular use of the fault finder will increase your familiarity with the fence system.

Reading the screen

For currents over 1 ampere, an arrow appears on the screen next to the current reading showing the direction of the current flow. The arrow always indicates the direction of the strongest current flow. Follow the fence in the direction of the arrow, taking readings at regular intervals. A large drop in the current reading indicates that you've gone past a fault.

When you switch on the fault finder, the last current reading measured will be briefly displayed at the top right of the screen before changing to the fence voltage.

Finding faults

- 1 Start close to where the energiser lead-out wires connect to the fence. Press **ON** to switch on the fault finder.
- 2 Insert the fence wire into the Fence wire voltage slot, ensuring that the fence wire touches the Voltage probe. Note the reading (in amps).
- 3 Work down the fence line taking readings at regular intervals and at all junction points. The previous reading is displayed briefly at the top right of the screen for comparison.
- 4 At a junction, follow the branch that indicates an abnormally high reading. A sudden reduction in current between one point and the next will indicate the presence of a fault between these two points.
- 5 Move back in the direction of the previous reading until the fault is located.

Notes:

- Higher than normal current readings indicate short circuit faults. Lower than normal current readings with the same voltage readings will most probably indicate arcing faults, faulty insulators, a poor connection or broken wire.
- On an earth wire-return fence, readings taken on the earth wire will show the current direction flowing towards the energiser.

Live fence alert tone

When the fence wire is in the Fence wire voltage slot or the Fence wire remote slot, the Remote Control Fence Compass beeps each time the energiser pulses to indicate that the fence is live. The pitch of the alert tone rises with the magnitude of the current pulse. This is particularly useful when measuring currents in different branches at a junction point, and when the display cannot be seen. If the power supply to the fence has been switched off, the Remote Control Fence Compass will not beep.

Enabling and disabling the live fence alert tone

- 1 Press and hold **ON**, then press **ON** to enter the Set-up mode.
- 2 Press **ON** once to scroll to the flashing note (🎵). **OFF** now acts as a toggle to switch the alert tone on or off.
- 3 Do one of the following:
 - To enable the live fence alert tone, press **OFF** until ON appears on the screen.
 - To disable the live fence alert tone, press **OFF** until OFF appears on the screen.
- 4 Press **ON** to move to the next setting – Polarity (**kV**).
- 5 Press **ON** to switch off the Remote Control Fence Compass.

Backlight

The remote control has a backlight for better screen visibility when there is not enough daylight. If required, this feature can be turned off to conserve battery life.

Enabling and disabling the backlight

- 1 Press and hold **ON**, then press **ON** to enter the Set-up mode.
- 2 The backlight option will now be flashing (bL). **OFF** now acts as a toggle to switch the backlight on or off.
- 3 Do one of the following:
 - To enable the backlight, press **OFF** until ON appears on the screen.
 - To disable the backlight, press **OFF** until OFF appears on the screen.
- 4 Press **ON** to switch off the Remote Control Fence Compass.

Battery

The remote control battery must be replaced when you see the  symbol on the screen.

To replace the battery:

- 1 Unscrew the case back.
- 2 Unclip the old battery, and replace with a new PP3, 9 V, alkaline battery.
- 3 Screw the case back into place, taking care not to trap the battery leads under the screws or in the case assembly.

Caring for the Remote Control Fence Compass

- Do not leave the Remote Control Fence Compass in direct sunlight, for instance on a vehicle dashboard.
- Use only a damp cloth to clean the remote control.
- If the Remote Control Fence Compass gets wet, wipe it dry and place it face down to allow any water to run out of the speaker grill. The Remote Control Fence Compass is water-resistant and should require no further attention.

Communication between the energiser and the Remote Control Fence Compass

Understanding address settings

The energiser communicates with the Remote Control Fence Compass using a channel. The channel has a unique address setting.

A Remote System (RS) energiser has its address preset to one of 16 possible addresses and comes with a Remote Control Fence Compass configured to match it.

A Remote Ready (R) energiser has its address preset to 0 (zero). This means that it will not recognise or act on commands from a remote control.

You may want to change the address setting of your energiser:

- If you buy a Remote Control Fence Compass separately and you want to configure your Remote Ready energiser to accept commands from it.
- If you are using more than one remote-controlled energiser on your property and you want each remote control to operate one energiser only.
- If an adjacent property has an energiser that is operating at the same address setting.
- If your energiser turns off unexpectedly quite often.

Different address settings for each energiser prevents unintentional activation or deactivation of fence lines.

Reading the energiser's address setting

When first connected to the power source, all light segments on the LED display illuminate. They then illuminate separately from left to right and back again. This indicates that the energiser is operating normally. The LED display then displays a light sequence, for three seconds, that identifies the address setting of the energiser.

To identify your energiser's address setting, match the illustration with what you see on the display.

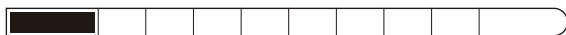

| | Address |
|--|---------|
|  | 1 |
|  | 2 |
|  | 3 |
|  | 4 |
|  | 5 |
|  | 6 |
|  | 7 |
|  | 8 |
|  | 9 |
|  | 10 |
|  | 11 |
|  | 12 |
|  | 13 |
|  | 14 |
|  | 15 |

Note: If only the large, red light segment on the left is illuminated, your energiser is set to address zero.







This means that you have a Remote Ready energiser.

Changing the energiser's address settings

To switch to the Standby mode:

- 1 Switch off the power supply to the energiser and wait for the red power light to stop illuminating, then switch on the power supply again.
- 2 Press  to switch on the remote control.
- 3 Hold the remote control within 150 to 300 mm (6 to 12") of the energiser and press . The energiser will stop pulsing (may take up to 2 seconds) and only the large, green light on the right will continue flashing.
- 4 Press  to switch off the remote control.



To change the energiser's address:

- 1 Switch to the Standby mode. See the procedure above.
- 2 Press and hold , then press  to enter the Set-up mode.
- 3 Press and hold  to scroll through the list of available options.
- 4 Select the Address (Ad) option, and press  until the number you want is displayed.
- 5 Hold the remote control within 150 to 300 mm (6 to 12") of the energiser and press  to transmit the new setting to the energiser.

A moving arrow on the remote control screen indicates that the command is being sent to the energiser. The large, red light on the left illuminates for 6 seconds as the energiser receives the command. The energiser then resumes in Standby mode with only the large, green light on the right flashing.

- 6 Press  to switch off the remote control.

To exit the Set-up mode without changing the energiser's address:

- Instead of pressing , which transmits the new setting, press . This switches off the remote control.

Tip: Make a note of the address setting of the energiser to save time should the address be accidentally changed, or if an additional remote control is required in the future.

To reduce the risk of accidental address changes, the energiser has been built with the following safeguards:

- It will accept a new address only *within four minutes* of the power supply being switched on.
- It will accept a new address only when in Standby mode (that is, when the energiser is not pulsing).



Activating the remote control function of a Remote Ready energiser



An energiser purchased as Remote Ready will not respond to commands sent by the Remote Control Fence Compass until the remote control function has been activated.

Before activating the remote control function:

- Switch off the power supply to the energiser and wait for the red power light to stop illuminating, then switch on the power supply again.

To activate the function:

- 1 Press and hold , then press  to enter the Set-up mode.
- 2 Press and hold  to scroll through the list of available options.

- 3 Select the Address (Ad) option, and press  until the number you want is displayed.
- 4 Hold the remote control within 150 to 300 mm (6 to 12") of the energiser and press  to transmit the new setting to the energiser.
A moving arrow on the remote control screen indicates that the command is being sent to the energiser. The large, red light on the left illuminates for 6 seconds as the energiser receives the command. The energiser then resumes in Standby mode with only the large, green light on the right flashing.
- 5 Press  to switch off the remote control.

Tip: Make a note of the address setting of the energiser to save time should the address be accidentally changed, or if an additional remote control is required in the future.

Building a permanent electric fence

Components of an electric fence

An electric fence system comprises the following elements:

- An energiser.
- An earth system. This comprises a number of metal rods inserted into the ground, which are connected to the Fence earth terminal on the energiser.
- Stafix insulated underground cables. Used to connect the energiser to the earth and fence.
- An insulated fence. Connected to the Fence output terminal of the energiser. Fences can be made to a variety of designs (see below).

Other useful components that can be added:



Cut-out switches. Installed at regular intervals, these allow you to isolate sections of the fence for repair.



Lightning diverter kit. Used to minimise the damage to your energiser from lightning conducted down the fence line.

Standard installation

The animal receives a shock when it completes a circuit between the fence and the earth system. The fence below has all live wires and requires conductive soils. These fences are often referred to as 'all-live' or 'earth-return' fences.

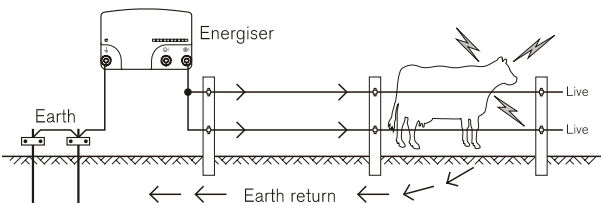

Alternative installation

For poor conductivity soils (dry or sandy), a 'fence-return' or 'earth-wire-return' system is recommended. On these fences the Fence earth terminal is connected directly to at least one of the fence wires. The animal gets maximum shock from touching a live and earth wire at the same time.

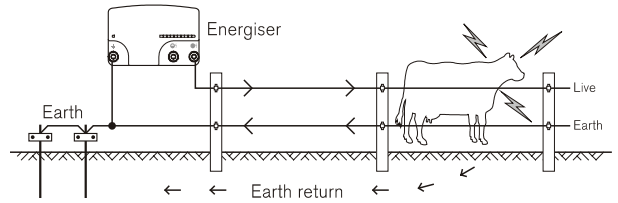

Fence designs

Fences can be constructed to suit the type of livestock and materials available. Discuss with your Stafix distributor which design best suits your needs. Some suggested fence configurations are below.

Cattle and horses

10-15 m (33-49') spacing, posts only

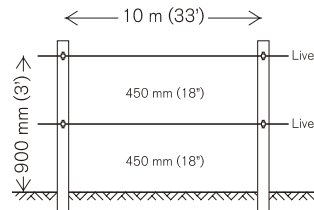

15-20 m (49-65') spacing with droppers

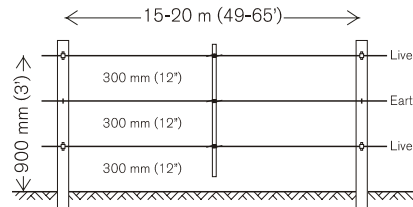

Sheep, goats, cattle and horses

10 m (33') spacing, posts only

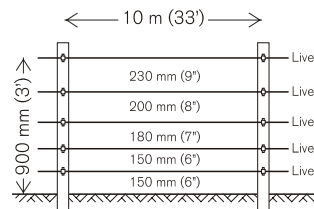

15 m (49') spacing with droppers

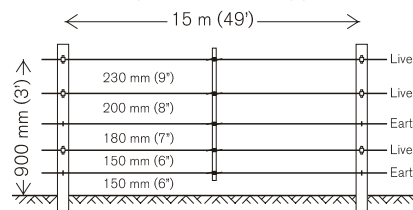

Wild animals

7 wire, 10 m (33') spacing with droppers

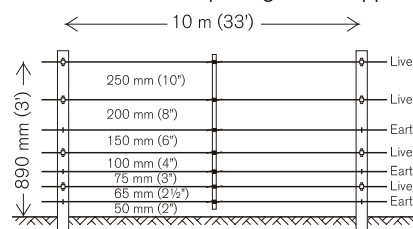

End assemblies

Angle stay

Suitable for field gate, high-tension strainer.

After firmly setting the footed strainer in the ground, dig in the stay block just below ground level, at a distance to ensure the angle stay will be held snugly in position. The stay can be levered into position with a spade.

All-live system

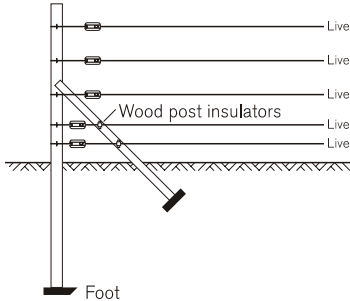

Earth-wire return system

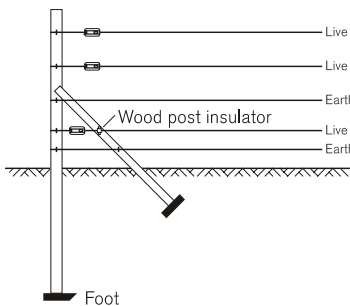

Horizontal stay

Suitable for field gate, high-tension strainer.

Very simple to erect and most suitable as a high tension strainer, excellent in areas where the soil gets very wet or where heavy frost occurs.

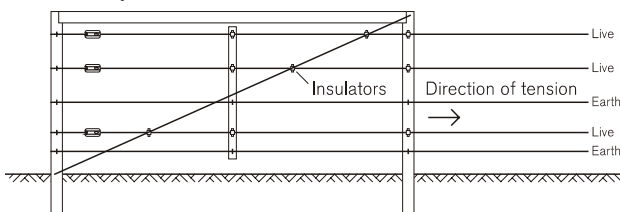

Installing and testing an earth system

Select a suitable site for the earth system. Sites need to be:

- At least 10 m (33') from other earth systems (e.g. telephone, mains power or the earth system from another energiser).
- Away from stock or other traffic that could interfere with the installation.
- At a site that can be easily observed for maintenance.
- Ideally at a site that has damp soil (e.g. a shaded or swampy location). Note that the earth does not need to be directly adjacent to the energiser installation.

Drive Stafix earth rods into the ground. Use high-voltage, insulated cable and earth clamps to continuously connect the earth rods and the energiser's Fence earth terminal. Make sure the insulation is stripped back to ensure good contact between the wire and the earth rod.

The number of earth rods used will vary with the soil conditions. For larger energisers, at least six 2 m (6'6") earth rods are required. To ensure that an adequate number of

earth rods have been used, test the earth system using the following procedure:

- 1 Turn off the energiser.
- 2 At least 100 m (330') away from the energiser, short circuit the fence by laying several steel rods or lengths of pipe against the fence. For best results, the fence voltage should be lowered to 2000 V or less. In dry or sandy conditions, it may be necessary to drive the rods up to 300 mm (12") into the earth.
Note: It is not acceptable to short circuit a fence return system to the earth wire of the fence.
- 3 Turn the energiser back on.
- 4 Using a Stafix Digital Voltmeter (FSTDV2P), ensure that the fence voltage is below 2 kV.
- 5 *Check your earth system.* Insert the voltmeter's earth probe into the ground at the full extent of the lead, and hold the hook against the last earth rod. The tester should not read more than 0.3 kV. Anything higher than this indicates that better earthing is required. Either add more earth rods or find a better ground area to drive in the earth rods.

Notes:

- The Remote Control Fence Compass may also be used to check voltage. See *Using the fault finder* on page 3 for more information.
- When earthing energisers located in dairies, earth at least 20 m (65') away from the dairy using double-insulated wire to avoid touching the dairy building or equipment.

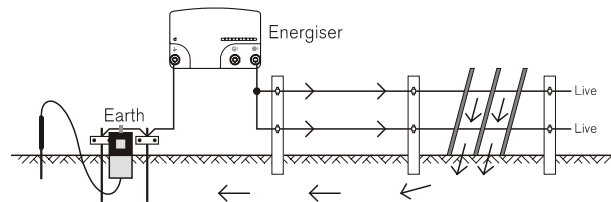

Safety considerations

Definition of special terms

Electric fence energiser – An appliance that is intended to periodically deliver voltage impulses to a fence connected to it.

Fence – A barrier for animals or for the purpose of security, comprising one or more conductors such as metal wires, rods or rails.

Electric fence – A barrier which includes one or more electric conductors, insulated from earth, to which electric pulses are applied by an energiser.

Fence circuit – All conductive parts or components within an energiser that are connected or are intended to be connected, galvanically, to the output terminals.

Earth electrode – Metal structure that is driven into the ground near an energiser and connected electrically to the output Fence earth terminal of the energiser, and that is independent of other earthing arrangements.

Connecting lead – An electric conductor, used to connect the energiser to the electric fence or the earth electrode.

Electric animal fence – An electric fence used to contain animals within or exclude animals from a particular area.

Electric security fence – A fence used for security purposes which comprises an electric fence and a physical barrier electrically isolated from the electric fence.

Physical barrier – A barrier not less than 1.5 m (5') high intended to prevent inadvertent contact with the pulsed

conductors of the electric fence. Physical barriers are typically constructed from vertical sheeting, rigid vertical bars, rigid mesh, rods or chainwire mesh.

Public access area – Any area where persons are protected from inadvertent contact with pulsed conductors by a physical barrier.

Pulsed conductors – Conductors which are subjected to high voltage pulses by the energiser.

Secure area – The side of an electric security fence where a person may come into contact with the electric fence, without the protection of a physical barrier.

Requirements for electric animal fences

Electric animal fences and their ancillary equipment shall be installed, operated and maintained in a manner that minimises danger to persons, animals or their surroundings.

This energiser is not intended for use by young children or infirm persons unless they have been adequately supervised by a responsible person to ensure that they can use the energiser safely.

Young children should be supervised to ensure that they do not play with the energiser.

Electric animal fence constructions that are likely to lead to the entanglement of animals or persons shall be avoided.

An electric animal fence shall not be supplied from two separate energisers or from independent fence circuits of the same energiser.

For any two separate electric animal fences, each supplied from a separate energiser independently timed, the distance between the wires of the two electric animal fences shall be at least 2 m (6'6"). If this gap is to be closed, this shall be effected by means of electrically non-conductive material or an isolated metal barrier.

Barbed wire or razor wire shall not be electrified by an energiser.

A non-electrified fence incorporating barbed wire or razor wire may be used to support one or more offset electrified wires of an electric animal fence. The supporting devices for the electrified wires shall be constructed so as to ensure that these wires are positioned at a minimum distance of 150 mm (6") from the vertical plane of the non-electrified wires. The barbed wire and razor wire shall be earthed at regular intervals.

Follow our recommendations regarding earthing. See *Installing and testing an earth system* on page 6.

A distance of at least 10 m (33') shall be maintained between the energiser earth electrode and any other earthing system connected parts such as the power supply system protective earth or the telecommunication system earth.

Connecting leads that are run inside buildings shall be effectively insulated from the earthed structural parts of the building. This may be achieved by using insulated high voltage cable.

Connecting leads that are run underground shall be run in conduit of insulating material or else insulated high voltage cable shall be used. Care must be taken to avoid damage to the connecting leads due to the effects of animal hooves or vehicle wheels sinking into the ground.

Connecting leads shall not be installed in the same conduit as the mains supply wiring, communication cables or data cables.

Connecting leads and electric animal fence wires shall not cross above overhead power or communication lines.

Crossings with overhead power lines shall be avoided wherever possible. If such a crossing cannot be avoided it shall

be made underneath the power line and as nearly as possible at right angles to it.

If connecting leads and electric animal fence wires are installed near an overhead power line, the clearances shall not be less than those shown in the table below.

Minimum clearances from power lines for electric animal fences

| Power line voltage | Clearance |
|--------------------|-----------|
| ≤1000 V | 3 m (10') |
| >1000 ≤33,000 V | 4 m (13') |
| >33,000 V | 8 m (27') |

If connecting leads and electric animal fence wires are installed near an overhead power line, their height above the ground shall not exceed 3 m (10'). This height applies to either side of the orthogonal projection of the outermost conductors of the power line on the ground surface, for a distance of:

- 2 m (6'6") for power lines operating at a nominal voltage not exceeding 1000 V.
- 15 m (50') for power lines operating at a nominal voltage exceeding 1000 V.

Electric animal fences intended for deterring birds, household pet containment or training animals such as cows need only be supplied from low output energisers to obtain satisfactory and safe performance.

In electric animal fences intended for deterring birds from roosting on buildings, no electric fence wire shall be connected to the energiser earth electrode. A warning sign shall be fitted to every point where persons may gain ready access to the conductors.

Where an electric animal fence crosses a public pathway, a non-electrified gate shall be incorporated in the electric animal fence at that point or a crossing by means of stiles shall be provided. At any such crossing, the adjacent electrified wires shall carry warning signs.

Any part of an electric animal fence that is installed along a public road or pathway shall be identified at frequent intervals by warning signs securely fastened to the fence posts or firmly clamped to the fence wires.

- The size of the warning sign shall be at least 100×200 mm (4×8").
- The background colour of both sides of the warning sign shall be yellow. The inscription on the sign shall be black and shall be either:

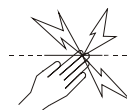

or the substance of "CAUTION: Electric animal fence".

- The inscription shall be indelible, inscribed on both sides of the warning sign and have a height of at least 25 mm (1").

Ensure that all mains-operated, ancillary equipment connected to the electric animal fence circuit provides a degree of isolation between the fence circuit and the supply mains equivalent to that provided by the energiser.

Protection from the weather shall be provided for the ancillary equipment unless this equipment is certified by the manufacturer as being suitable for use outdoors, and is of a type with a minimum degree of protection IPX4.

Frequently asked questions/ Troubleshooting

What voltage is required to control animals?

4 kV is widely accepted as the recommended minimum voltage to control animals. However, you also require a well constructed fence system to ensure that animals cannot push through electrified wires.

The fence voltage is below 4 kV. How do I increase the voltage?

Check the energiser. Disconnect the energiser from the fence and earth system. Measure the voltage across the energiser terminals with a Stafix Fence Compass, DVM or Lite Tester. If the voltage is less than 6 kV, request your Stafix service agent to check the energiser.

Check the energiser earthing. Use the procedure described in *Installing and testing an earth system* on page 6.

Check your fence system for faults. The most common source of low voltage is faults on the fence line.

If the fence, earth and energiser are in good condition and the voltage is still below 4 kV, talk to your Stafix distributor. They will help you identify whether recent extensions to your fence, a poor fence layout, or soil conditions may be causing inadequate voltage.

How do I locate faults?

If you have purchased a M12RS/RSE, M20RS/RSE, or M36RS/RSE, use the Remote Control Fence Compass to locate faults. See *Using the fault finder* on page 3. If you have a M12R/RE, M20R/RE, or M36R/RE, the recommended tool for locating faults is the Stafix Fence Compass. This combined voltage and current meter allows you to rapidly locate sources of current leakage. Alternatively, use a Stafix DVM or Lite Tester. Use cut-out switches to turn off the power to different sections of the farm. If the voltage on the fence increases when a section of the farm is turned off, then investigate that section for possible faults.

There are no lights flashing on the energiser.

Check the power supply. Ensure that the power is switched on. If the energiser still does not operate, ask your Stafix service agent to check the energiser.

The energiser does not respond to commands from the Remote Control Fence Compass.

- Ensure that the remote contact on the Remote Control Fence Compass is in contact with the fence wire before pressing **ON** or **OFF**. (Holding the button down for an extended period will not make the remote control work better.) After pressing **ON** or **OFF**, wait for two seconds for the ON or OFF message to disappear from the display, as the energiser may send out a final pulse after receiving the signal to deactivate. Similarly, allow two seconds for the energiser to send out its first pulse after receiving the command to reactivate.
- If the  symbol is displayed on the Remote Control Fence Compass, replace the 9 V alkaline battery and try again.
- Rusty or oxidised wire can hamper the quality of the signal you receive. To obtain a clear signal, rub the Remote contact against the fence wire to break through the layer of rust or oxidation.
- Ensure that no spring gates or cut-out switches have been left open. Sometimes the remote control will work in spite of minor breaks in the wire, although reliable operation under such conditions is not guaranteed.
- Check for spark gaps and loose wire joints in the fence. Severe or multiple spark gaps reduce the effectiveness of the remote control.

- Use the fault finding function to locate faults in the fence line. See *Using the fault finder* on page 3.
- Check all connections to the fence and the earth system. Ensure that the energiser is connected to the power supply and the fence system and that the energiser is switched on.
- Try turning the energiser on and off by holding the Remote contact against the lead-out wire, or by holding the remote control close to the energiser (within 150 to 300 mm [6 to 12"]). If the energiser still doesn't respond, then the remote control and energiser may have different address settings. See *Changing the energiser's address settings* on page 4 and *Activating the remote control function of a Remote Ready energiser* on page 4.

The energiser sometimes turns off unexpectedly

- An adjacent property may have an energiser operating at the same address setting. Change the energiser's address setting. See *Changing the energiser's address settings* on page 4. If the problem persists, seek advice from your Stafix distributor.

Identifying faults using the LED display

What do the light sequences on the LED display mean?

Different light sequences indicate different things. But there are certain light sequences that you must pay attention to more than others.

| If ... | This means that ... |
|--|---|
| M36R energisers only - The energiser is pulsing, and the 10th light segment is illuminated. | The energiser has switched to the full-power mode, because there is a heavy load on the fence. See <i>Full-power mode (M36R energisers only)</i> on page 2 for more information. |
| At each pulse, you see only red lights (no green lights). | The fence may be heavily loaded [voltage below or around 3 kV (3000 V)], Look for faults, e.g. short circuit or arcing faults. If no faults can be found, disconnect the energiser from the fence to see if the green lights illuminate on the energiser. If the green lights are visible, then the energiser is operating normally. This may indicate that the energiser is not sufficient for the length of the fence. Try subdividing the fence. |
| The 10th light segment flashes rapidly, a few other light segments are illuminated, and the energiser doesn't work. | The energiser has diagnosed a fault and should be returned to the service centre for repair. |
| The 10th light segment flashes rapidly, a few other light segments are illuminated, but the energiser resumes pulsing after some time, and this happens quite often. | The energiser has diagnosed a fault and should be returned to the service centre as soon as possible. |
| The 10th light segment flashes rapidly, and the 3rd and 6th light segments are illuminated. | The energiser is too hot to operate safely. This generally happens in places that experience high day-time temperatures. The energiser will resume normal operation when the temperature cools down sufficiently. |

Servicing

This energiser contains no user serviceable parts. It must be returned to a Stafix-appointed service agent for repair. If the supply cord is damaged it must only be replaced by a Stafix-appointed service agent, as a special cord is required.

This energiser uses Double Insulation, where two systems of insulation are provided instead of grounding. No equipment grounding means is provided in the supply cord of a double-insulated energiser, nor should a means for equipment grounding be added to the energiser. Servicing a double-insulated energiser requires extreme care and knowledge of the system and should only be done by qualified service personnel. Replacement parts for a double-insulated energiser must be identical to the parts they replace. A double-insulated energiser is marked with the words DOUBLE INSULATION or DOUBLE INSULATED and/or the symbol below.

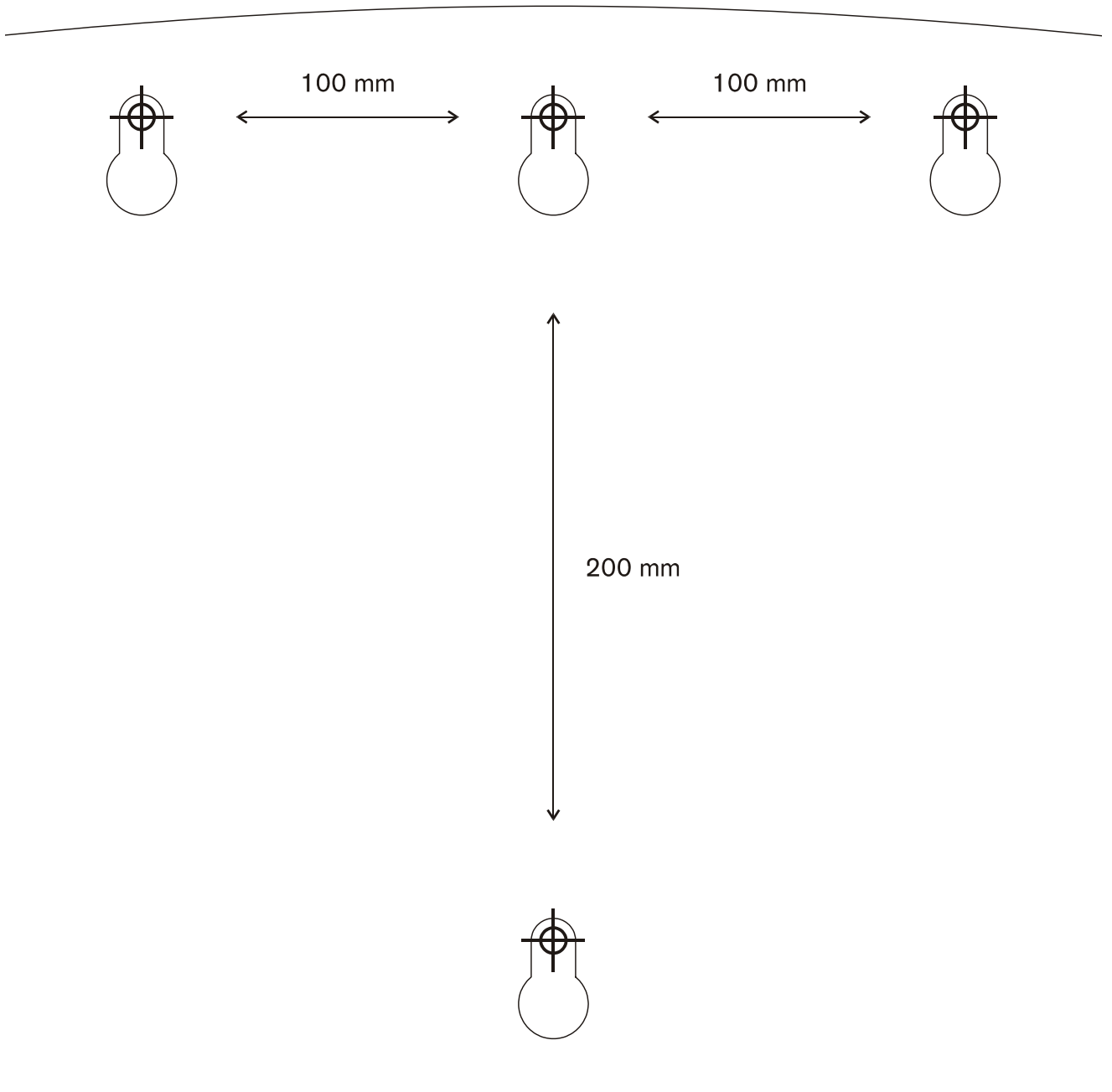



www.stafix.com



Warning: Read all instructions
Save these instructions