

■ THREE PHASE POWER QUALITY ANALYSER

C.A 8332B

C.A 8334B



ENGLISH

User's manual

MEANING OF SYMBOLS USED IN THE INSTRUMENT



: WARNING ! Please refer to the User's Manual before using the instrument.
In this User's Manual, the instructions preceded by the above symbol, should they not be carried out as shown, can result in a physical accident or damage the instrument and the installation.



: Earth



: Double insulation



: Conform to WEEE 2002/96/EC standard

Thank you for acquiring a **C.A 8332B** or **C.A 8334B** three phase power quality analyser.

To obtain the best possible service from your instrument :

- **read** these operating instructions carefully,
- **comply** with the precautions for use.

⚠ PRECAUTIONS FOR USE ⚠

- Read carefully all the notes preceded by ⚠ symbol.
- If you don't use this instrument according the user's manual, you can compromise the safety, and you can go in dangerous situation.
- The safety of all the system which include this instrument is the system owner responsibility.
- For your safety, use only tests leads delivered with the instrument : they are conform to EN 61010-031 (2002) standard.
- Before each use, check the good state of test leads.
- For your safety, use only accessories delivered with the instrument or approved by the supplier.
- Respect the climatic conditions for use (see § 6).
- This instrument can be used on category-IV installations for voltages not exceeding 600V (AC or DC) in relation to the earth (as per EN 60664-1).
- The use of accessorie (sensor) with lower category (CAT III for example) reduce the set use (Instrument with sensor) at this category (CAT IV begin CAT III for example).
- Ensure the measurement leads and sensors are disconnected before removing the battery.
- Use battery packs supplied by the maker.

INSTALLATION CATEGORIES

Definition of installation categories (cf IEC 664-1 publication) :

CAT III : CAT III circuits are power supply circuits that can support major transient overvoltage.

Example : industrial unit or machine power supply.











CAT IV : CAT IV circuits can support very high transient overvoltage.

Exemple : power input.

WARRANTY

Our guarantee is applicable for **three years** after the date on which the equipment is made available (extract from our General Conditions of Sale, available on request).

CONTENTS

1. INTRODUCTION	4
2. PRESENTATION	4
2.1 Unit	4
2.2 Display	5
2.3 Presentation of the different battery states	6
3. INITIAL OPERATION	7
3.1 Configuration of the instrument 	7
4. DISPLAY MODES	12
4.1 Waveforms Mode 	12
4.2 Harmonics Mode 	15
4.3 Power / Energy Mode 	17
4.4 Transient mode  (on C.A 8334B only)	19
4.5 Alarms Mode 	21
4.6 Recording Mode 	22
4.7 Screen Memorisation 	25
4.8 Printing 	26
4.9 Help 	26
4.10 Logiciel "QualistarView"	26
5. GENERAL SPECIFICATIONS	27
5.1 Dimensions and weight	27
5.2 Power supply	27
5.3 Climatic conditions	27
5.4 Compliance with international standards	27
6. FUNCTIONAL CHARACTERISTICS	28
6.1 Reference conditions	28
6.2 Electrical specifications	28
6.3 Specifications of the sensors (with C.A 8332B/34B)	32
7. MAINTENANCE	37
7.1 Recharging the battery	37
7.2 Cleaning the housing	37
7.3 Calibration testing	37
7.4 Repairs	37
8. TO ORDER	38
9. APPENDIX	40
9.1 Front view of the instrument	40
9.2 Mathematical formulae used to compute the various parameters	41
9.3 Setup DPU 414 printer	47

1. INTRODUCTION

C.A 8332B and C.A 8334B are three phase power quality analysers which are compact and shock-resistant. Their ergonomic design and the simplicity of their user interface make their use pleasant and intuitive.

They not only enable the user to obtain an instant image of a network's principal characteristics but also to monitor their variation over a period of time. Their multi-task measurement system simultaneously handles all the measurement functions of the various magnitudes, detection, continuous recording: and their display without any constraints.







They are intended for the technicians and engineers of the test and maintenance teams working in industry and the administration, for measurements, enabling them to carry out checks and diagnostic work on single phase, two phase or three phase low voltage networks.

The principal measurements made are:

- Measurement of AC rms voltages up to 480V (phase-to-neutral) or 960V (phase-to-phase) for two-wire, three-wire or four-wire networks.
- Measurement of alternating RMS currents up to 6500A rms.
- Measurement of the frequency of 50Hz, 60Hz (10Hz to 70Hz) networks.
- Calculation of neutral current by vector summing of phase current for star configurations.
- Calculation of peak factors for currents and voltages.
- Calculation of the K factor for currents (transformers).
- Calculation of short-term flicker for voltages.
- Calculation of the phase unbalance for voltage and current (three-phase networks only).
- Measurement of harmonic angles and rates (with respect to fundamental value) for voltage, current or power (C.A 8334B only), up to level 50. Calculation of overall harmonic distortion factors.
- Measurement of active, reactive and apparent power per phase and their aggregate.
Calculation of the power, shift and tangent factor .
Total amount of energy generated and received from a moment chosen by the operator.
- Monitoring of the average value of any parameter, calculated over a period running from 1 sec to 2 hours. Storage of values over an unlimited period in the instrument memory.
- Recording, time stamping and characterisation of disturbance: Swells, dips and interruptions, overrun of power and harmonic thresholds...
- Detection of transients and recording of the associated waveforms (C.A 8334B only).

2. PRESENTATION

2.1 Unit (see § 9. Appendix)

- ① Display on a LCD colour screen with graphic representation of network parameters in the mode chosen using the keys ⑤ (see § 2.2).
- ② 6 variable function keys to modify the current display mode
- ③ 4 keys which allow the user to:
 -  access the instrument configuration parameters (see § 3.1)
 -  memorise the current screen and access screens already stored in the memory
 -  print the measurement results on an external printer (see "To order" paragraph)
 -  obtain assistance on the current display mode functions in the language chosen by the user
- ④ ON / OFF key
- ⑤ Keys for choosing the display mode at any time:
 -  Transients: display of waveforms, motor startup current (Inrush) and interruption (C.A 8334B only).
 -  Harmonics: - representation of the harmonic ratios of voltage, current and power (C.A 8334B only), order by order,
- determination of harmonic current produced by non-linear loads,
- analysis of the problems caused by harmonics according to their order (heating of neutrals, conductors and motors, etc.) (C.A 8334B only)
 -  Waveforms : representation of voltage and current waveforms or vector representation (Fresnel diagram) used for:
 - the identification of signal distortion signatures,
 - the display of amplitude and phase unbalance for voltage and current
 - the checking of connections in the correct phase order



Power / Energy: - the display of power levels and the associated parameters (power factor, displacement and tangent),
 - energy metering,
 - Four quadrants measurement to discern produced /consumed active energies and inductive / capacitive reactive energies.



Recording: - time-related representation as bar charts or curves, of mean power levels or of the mean value of any other parameter,
 - mains voltage stability check,
 - management of power consumed and generated (most economical choice with energy distributor),
 - monitoring of harmonic variations,



Alarms: - a list of the alarms recorded according to the thresholds programmed during configuration,
 - logging of supply network interruption with half-period resolution (V_{rms} , A_{rms} , U_{rms}),
 - determination of energy consumption overruns,
 - checking of compliance with energy supply quality contract.

- ⑥ 4 keys: and which enable movement of the cursor, browsing or the selection of data.
- ⑦ Validation key
- ⑧ Network supply connector
- ⑨ IR RS232 bidirectional optical output for transferring data to a PC (bidirectional) or printing to a dedicated printer (DPU 414 - SEIKO).
- ⑩ 4 voltage inputs situated on the top of the instrument
- ⑪ 3 current inputs on the top of the instrument to enable the use of ammeter sensors (MN clamp, C clamp, Amp**FLEX**, PAC clamp.)
- ⑫ Protective case

2.2 Display

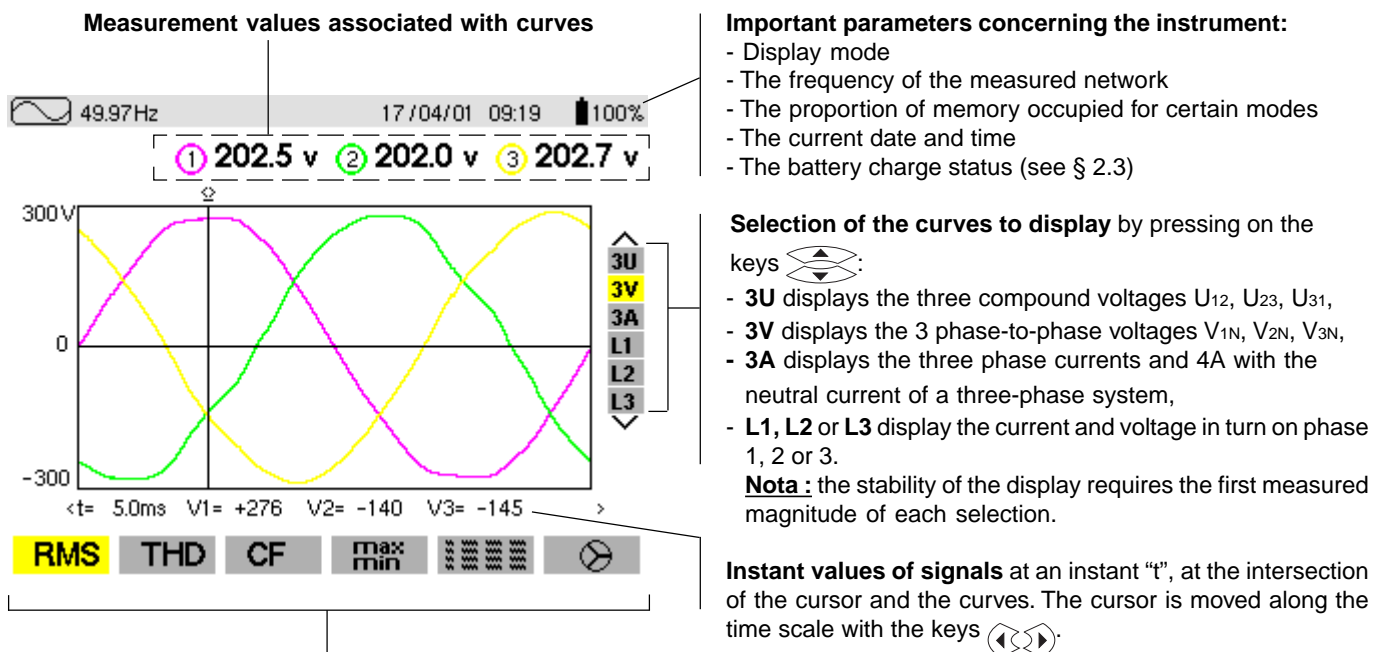

Selection of the measurement type using the variable function keys ②, situated below the screen:

RMS True RMS measurement

THD Overall harmonic distortion factor

CF Crest factor

max/min Extreme and average values



Simultaneous display of the various measurements



Fresnel diagram of signals

⚠ The calculation of the DPF, Tan, KF, ϕ , UNB, Min, Max, VAR, Harmonics, PST, and DF parameters and the frequency measurement can only be performed if Ch 1, with voltage V1, is connected to the network.

2.3 Presentation of the different battery states

1. Battery charging

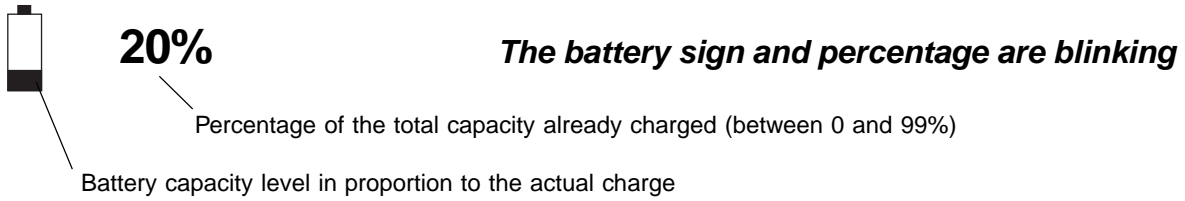

2. Battery full (End of charge or begin of discharge)



3. Battery discharging

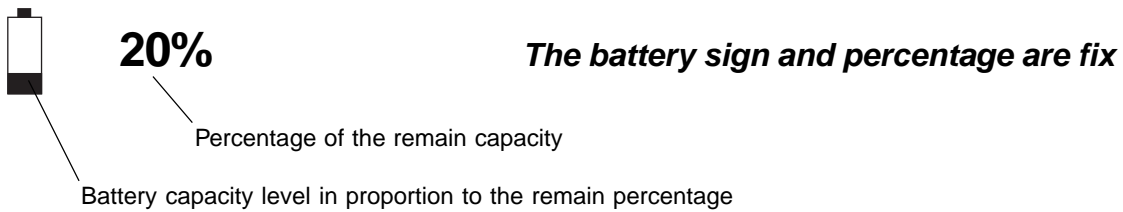

4. Battery empty discharging



5. New battery charging

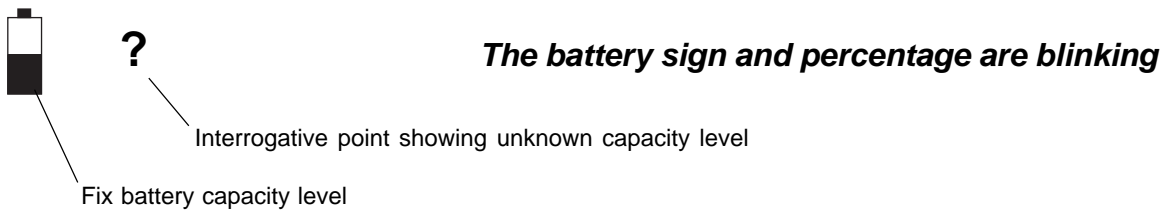

6. New battery discharging

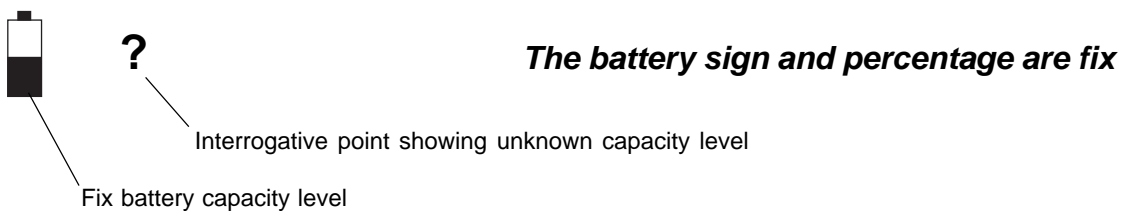

3. INITIAL OPERATION



The instrument is initially started up by pressing on the  key, the startup screen indicates the instrument software version and its serial number.

If there is no AC mains supply, the instrument can operate with batteries only, provided they are correctly charged.

The instrument's batteries are charged when it is connected to the AC mains supply.

Note: When the equipment is stopped using the  key, a confirmation is requested if the equipment is in the process of recording.

3.1 Configuration of the instrument

 **The instrument must be configured the first time it is used** and then whenever necessary. The configuration is saved in the non-volatile memory when the instrument is switched off (with  key).

When the  key is pressed, the following choices appear:

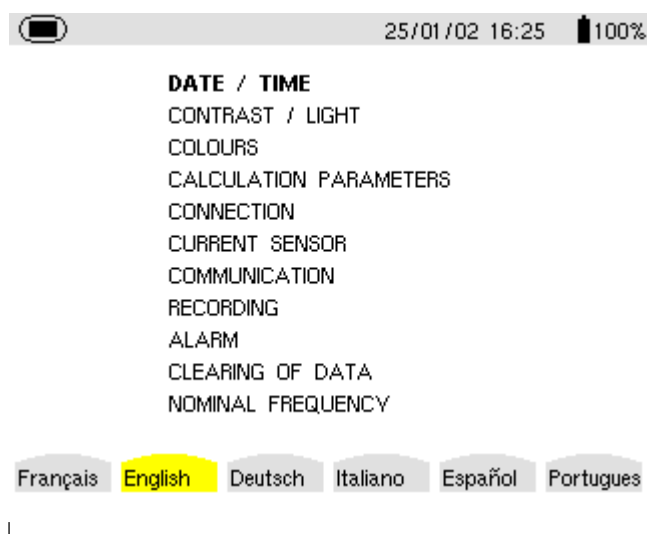

- Choose the language used with the variable function keys , situated just below the screen.

- Select the other configuration settings with the  keys

- Validate with the key 

The settings available are presented in the following paragraphs.

3.1.1 Date /Time

10/10/2000 16:45

- Select the number to be modified with the  keys, it will appear in bold type.

- Modify the value of the number selected with the  keys

- Validate the setting with the  key, the Configuration menu will once again be displayed on the screen.

Note: The time and date systems may be chosen by the user.

3.1.2 Light / Contrast

Two bargraphs appear in this display







- Choose Light or Contrast with the  keys

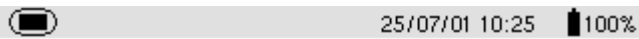

- The setting is chosen with the  keys and the setting level indicated on the bargraph.

- Validate the setting with the  key, the Configuration menu will once again be displayed on the screen.

3.1.3 Colours





Phase voltage	1	<		>
Phase current	1	<		>
Phase voltage	2	<		>
Phase current	2	<		>
Phase voltage	3	<		>
Phase current	3	<		>
Neutral current		<		>

- Choose the channel concerned with the  keys
- Choose the colour with the  keys
- Validate the setting with the  key, the Configuration menu will once again be displayed on the screen.

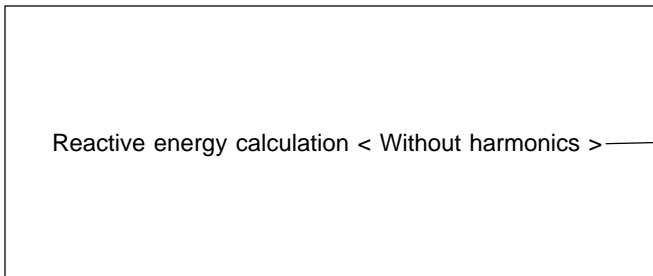
3.1.4 Calculation parameters



Choice of calculation with or without harmonics

- Choose the method with the  keys
- Validate the setting with the  key, the Configuration menu will once again be displayed on the screen.

3.1.5 Connection

25/07/01 10:26 100%

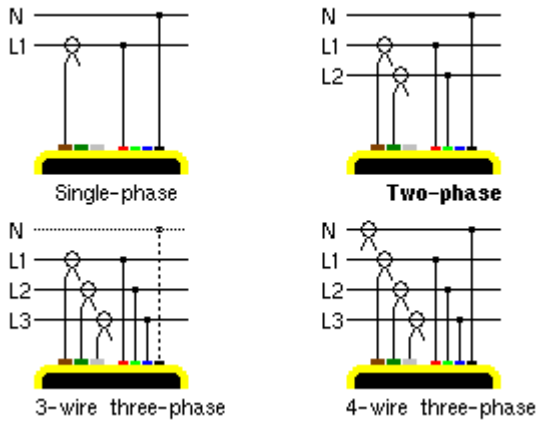

- Choose the connection with the and keys
Validate the setting with the key, the Configuration menu will once again be displayed on the screen.

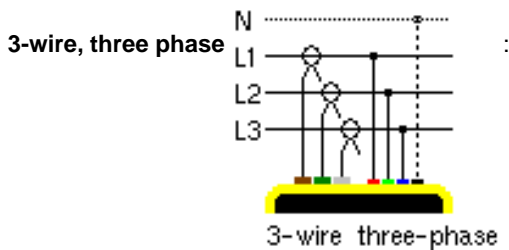
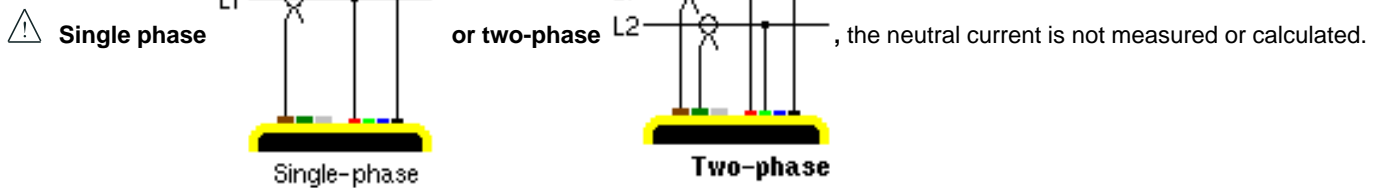

1. Three phase, triangle network: only power totals are representative of the actual situation
2. Three-phase star network: the neutral current is not calculated. It is necessary to connect neutral to obtain representative power levels per phase.

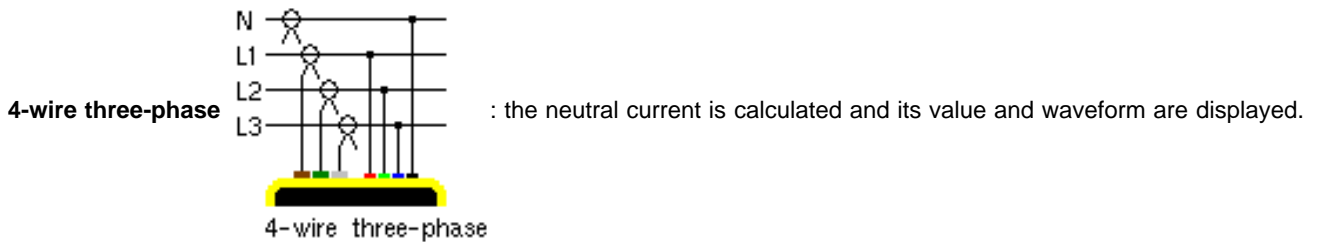

V1 must be connected in any type of connection since the display is synchronised from V1 and the network frequency measured by V1.

■ Synchronisation of the display of curves in “Waveform” mode

Display selection (vertical right menu)	Reference channel for synchronisation
3U	U1
3V	V1
4A / 3A	A1
L1	V1
L2	V2
L3	V3

3.1.6 Current sensor

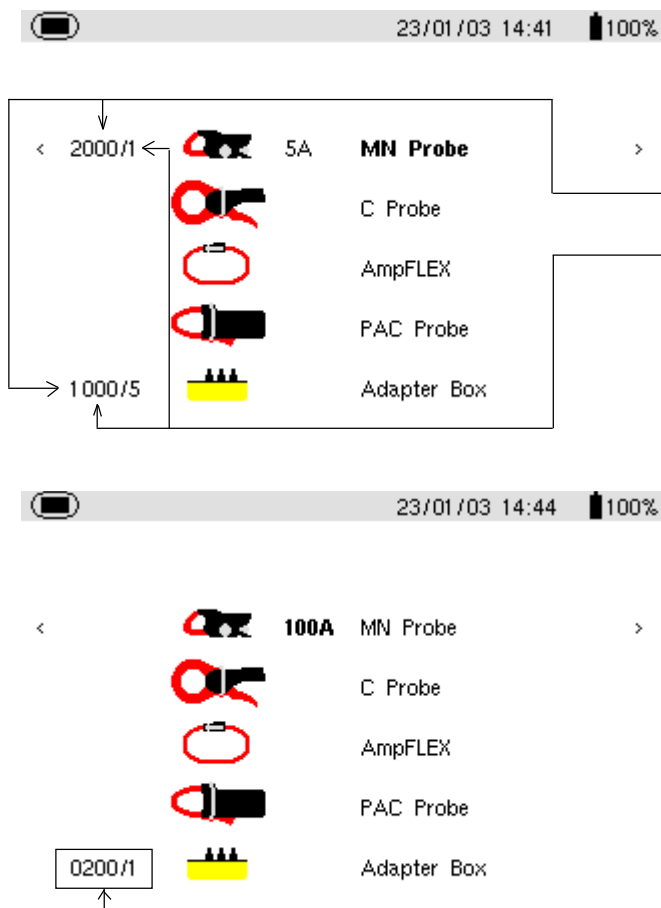

- Choose the sensor with the keys
- Validate the setting with the key, the Configuration menu will once again be displayed on the screen.

From 1 to 2999A, nominal value of primary current
Secondary current value (5A or 1A)

- make the cursor appear/disappear and move.
- allow the current required to be determined.

Current transducer ratio

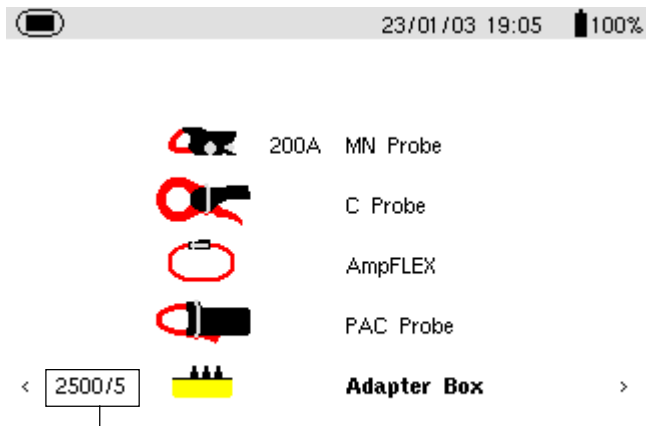

3.1.7 Communication

Transmission speed **57600** BDS

- Choose from the values: 300, 2400, 4800, 9600, 19200, 38400, 57600 or 115200 bauds with the keys
- Validate the setting with the key, the Configuration menu will once again be displayed on the screen.

For the transfer of data between Qualistar and a PC, the communication speeds must be identical at both ends.

3.1.8 Recording

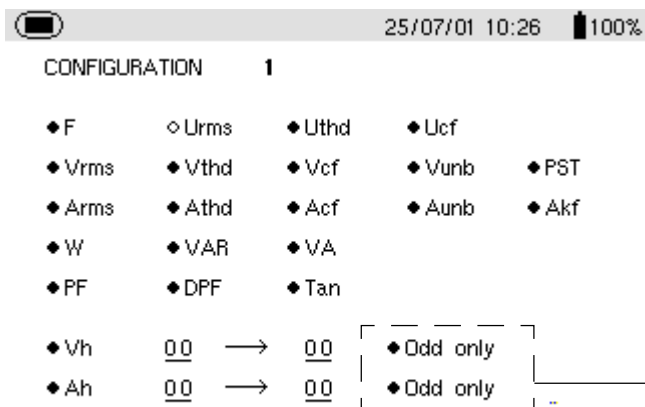

1. Choose the recording configuration using the keys
2. Move through the chosen field using the keys and validate the parameters using the keys; the field to be modified is shown in bold
3. Validate the setting with the key, the Configuration menu will once again be displayed on the screen.

If these lines are not validated, all the harmonic orders will be recorded.

Four different recording configurations can be stored

3.1.9 Alarm

A programmed alarm must be set to ON to be taken into account (general activation or deactivation of alarms is generated in mode).

■ Alarm programming

Choose the parameters associated with an alarm from the parameters proposed; phases survey, threshold value and minimum duration filtering can be programmed

NB: The programmed hysteresis is common to all alarms.

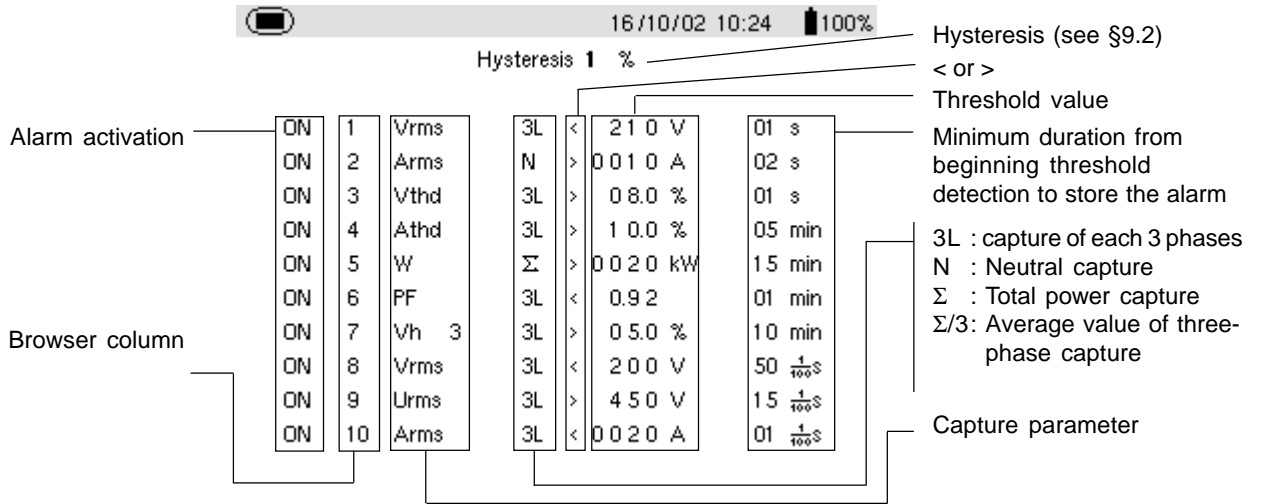

1. Select the modifiable field using the keys.
2. Activate or adjust the threshold values using the keys; the field to be modified appears in bold
3. Validate the setting with the key, the Configuration menu will once again be displayed on the screen.

NB : When an alarm is "OFF":

- 1) The parameters previously used are kept in the memory and reappear if the alarm is selected again.
- 2) To move quickly from one programmed alarm to another: simply position the cursor on the alarm numbers column and use .

Modifying one or several characteristics of an alarm set to ON switches it automatically to OFF.

NOTA : Only alarms on V_{RMS} , U_{RMS} and A_{RMS} (except for neutral current) can be programmed with a minimum threshold overrun duration of up to 1/100s.

3.1.10 Recorded data delete

When data delete is selected, the following question is displayed:

Are you sure you want to delete all the data?

Yes No

- Choose the relevant answer with the keys
- Validate the setting with the key

When the data is deleted, the instrument configuration returns to the default setting (maker's configuration) and the following are deleted:

- all detected alarms,
- all screen photos taken,
- all the captured transient states (on C.A 8334B only),
- and all recordings made.

The instrument will automatically switch itself off once the data have been deleted.

3.1.11 Rated frequency

Rated frequency of network: 50 Hz or 60 Hz

This parameter determines the correction coefficients used for calculating power and energy, with AmpFlex sensor.

- Choose the rated frequency using the keys
- Validate the adjustment using the key: the screen displays the "Configuration" menu again.

4. DISPLAY MODES

4.1 Waveforms Mode

- Press on the display mode key 
- The following screen is displayed:

■ Measurement of rms voltage on a three phase system:

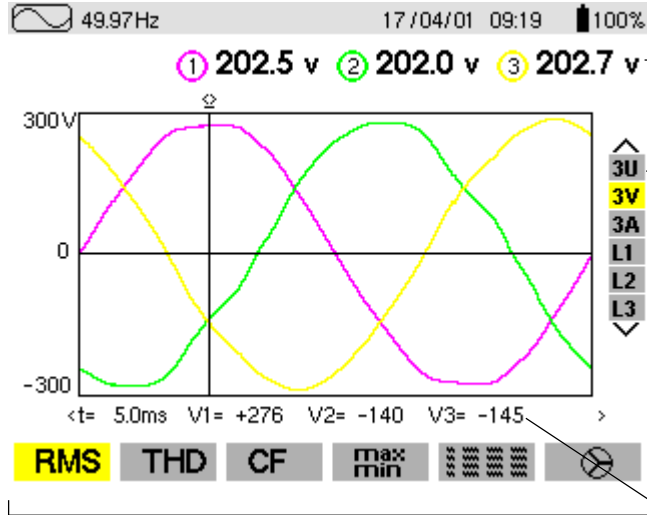

Values measured for each curve every second (same colour), according to the measurement type chosen with the variable function keys ②, situated directly below the screen.

The curves to be displayed are selected by pressing on the  keys:

- **3U** displays the three phase-phase voltages of a three phase system,
 - **3V** displays the three single voltages of a three phase system,
 - **3A** displays the three phase currents of a three-wire, three phase system,
- ⚠ **The neutral current is not a direct measurement but the resulting total of the 3 currents measured.**
- **L1, L2 and L3** respectively display the current and voltage on phases 1, 2 and 3.

Instant values of signals at an instant "t", at the intersection of the cursor and the curves. The cursor is moved along the time scale with the  keys.

The measurement type is selected using the variable function keys ②, located beneath the screen.

All these measurements are valid in 3U, 3V, 3A, L1, L2, L3

Important: The choice of curves to be displayed ( keys) depends on the type of connection (see § 3.1.5):

- 4-wire, three phase: 3U, 3V, 4A, L1, L2, L3
- 3-wire, three phase: 3U, 3V, 3A, L1, L2, L3
- Two-phase: 2V, 3A, L1, L2
- Single phase: No choice (L1)

This comment is valid for all display modes.

■ Measurement of phase to phase RMS voltages on the 3 phases

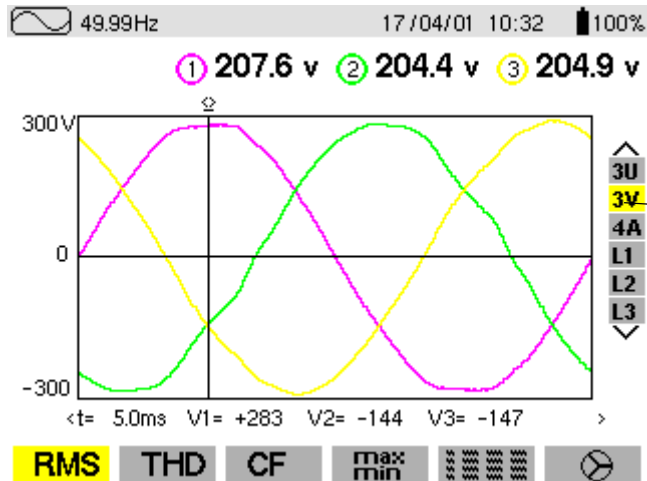

Selection of 3 V

■ Measurement of RMS current on the 3 phases and the neutral of a 4-wire three phase system

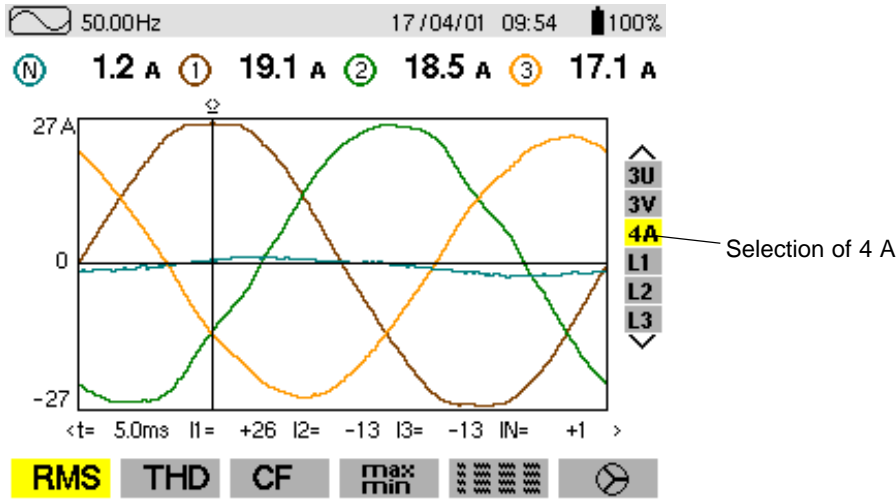

■ Measurement of overall harmonic distortion factors for voltage

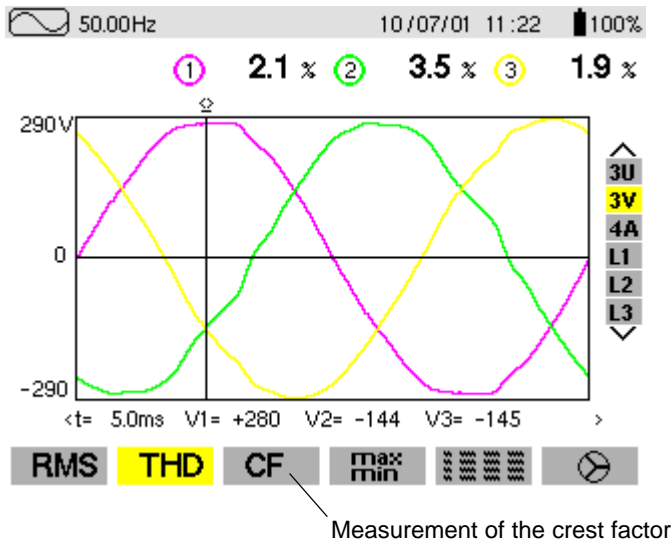

■ Measurement of extreme and average current values

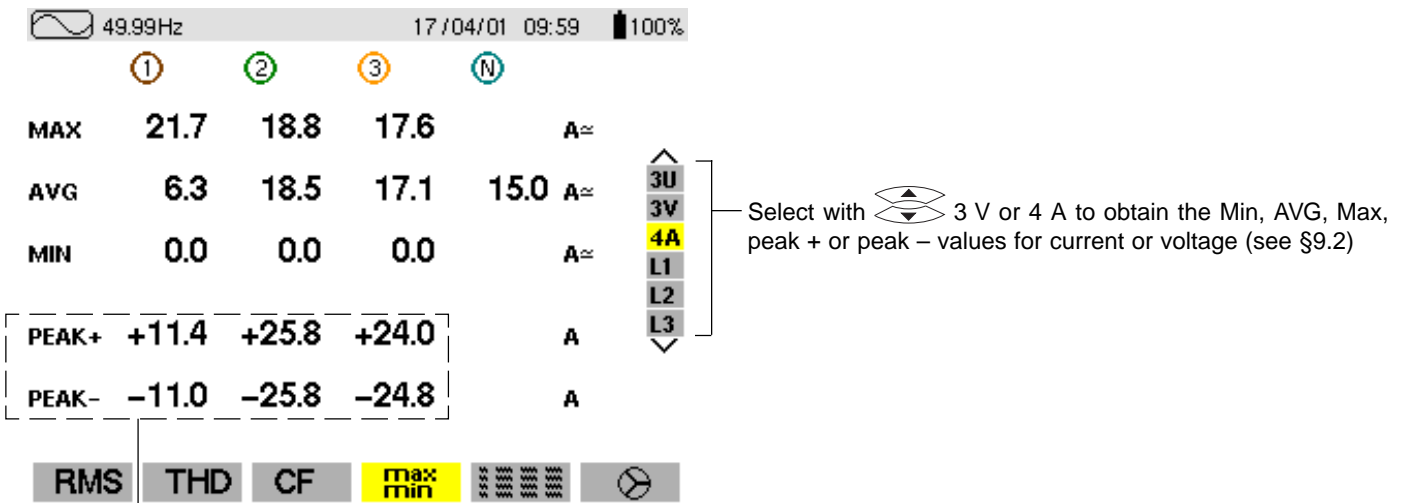

Peak values refreshed every 250ms but calculated every second.

⚠ Max and Min values are measured from the power on or the last key pressed

Nota : The Max and Min measurements are calculated every half period (e.g. : every 10ms for a 50Hz signal). The Avg measurements are calculated every second. However, the Max, Avg and Min measurements are refreshed every 250ms.

■ Simultaneous display of all the different current measurements

Summary of RMS, DC, THD, CF and KF parameters

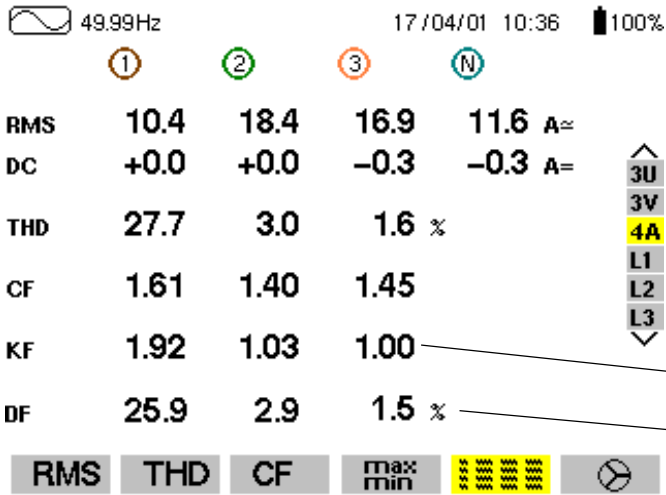

Calculation of the K factor for transformer downgrade

Distortion factor

Note: The K factor only concerns current.
 Similarly, the flicker value only concerns voltage.
 3V → PST, flicker calculated on short term
 3A and 4A → KF factor
 L1, L2 and L3 flicker and KF factor
 DC current values only for the PAC 93 clamp

■ Display of the Fresnel diagram or vector diagram

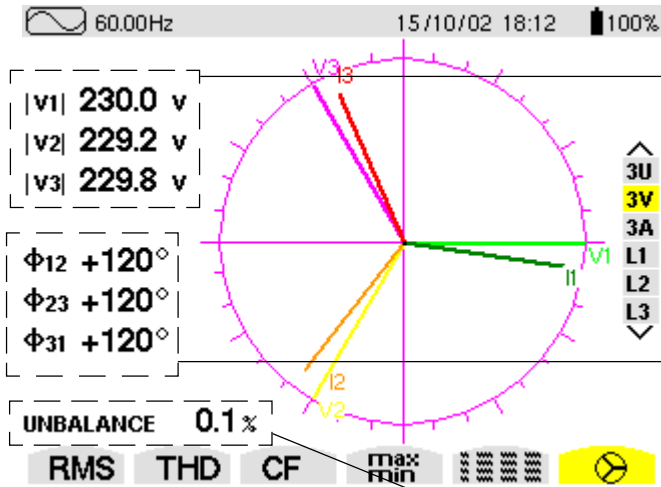

Absolute value or modulus of voltage of current at fundamental frequency.

Select the Fresnel diagram display choice

Φ12 corresponds to the phase shift of channel 1 compared to 2
 Φ23 corresponds to the phase shift of channel 2 compared to 3
 Φ31 corresponds to the phase shift of channel 3 compared to 1

NB: This is valid for current (4A and 3A) and for single voltage (3V).

When the user chooses to look at a specific phase (L1, L2 or L3) ΦVA is the phase angle of V in relation to A.

Current unbalanced ratio:
 For this 3 V selection, it is the voltage unbalanced value.

On each phase L1, L2, L3: display of Vn and An on a Fresnel diagram.



Display Filter (RH vertical menu)	Reference vector for the Fresnel diagram
3U	U1
3V / 2V	V1
4A / 3A / 2A	A1
L1	A1
L2	A2
L3	A3

4.2 Harmonics Mode

- Press on the display mode key 
- The following screen is displayed:

Selection of harmonic analysis measurement using the variable function keys located directly under the screen:

V	Single phase voltage analysis
A	current analysis
VA	apparent energy analysis
U	Phase to phase voltage analysis

The  and  keys allow the user to zoom in both directions (2%, 5%, 10%, 20%, 50% and 100%)

1. Harmonic analysis of the phase-phase or single voltages of the three phases of a three phase network **V** or **U**

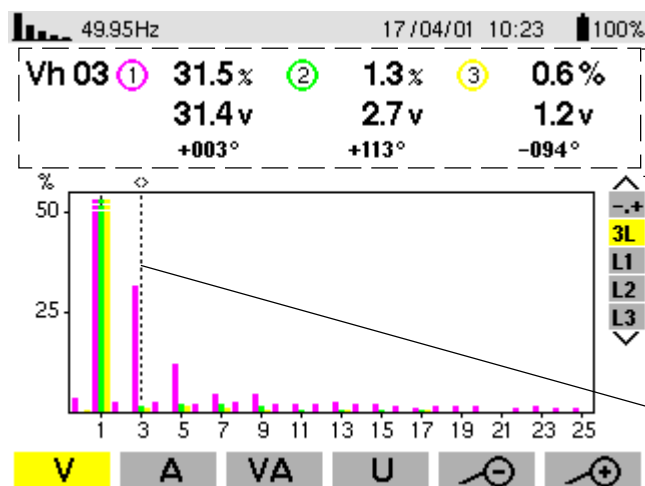

Values measured for each phase (harmonic N°3: Vh03):

- Percentage in relation to the fundamental
- RMS value,
- Phase angle in relation to the fundamental, according to the measurement type chosen (V) with the variable function keys situated just below the screen.

Selection of expert mode **-0+** (see 4. in § 4.2), for the three phases **3L** or **L1**, **L2** or **L3** by pressing on the  keys.

Cursor enabling selection up to harmonic order 50, with the  keys, as soon as order 25 is reached, the 25 to 50 range appears (order 0 represents the DC component).

2. Harmonic analysis of the current of one of the phases of a three phase network **A**

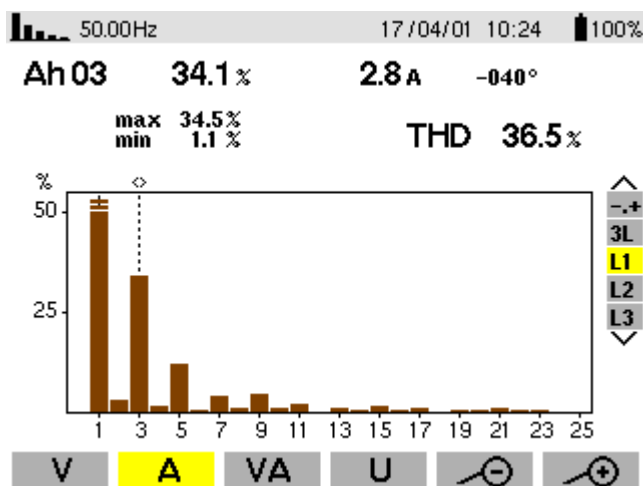

On phases L1, L2, L3 display of:

- the THD,
- and the parameters concerning the harmonic order under consideration:
 - percentage in relation to the fundamental
 - RMS value and phase angle in relation to the fundamental component
 - MIN and MAX values of the percentage to fundamental

 Min and Max values are reset each time the cursor position is changed.

3. Harmonic analysis of the power of one of the phases of a three phase network **VA** (C.A 8334B only).

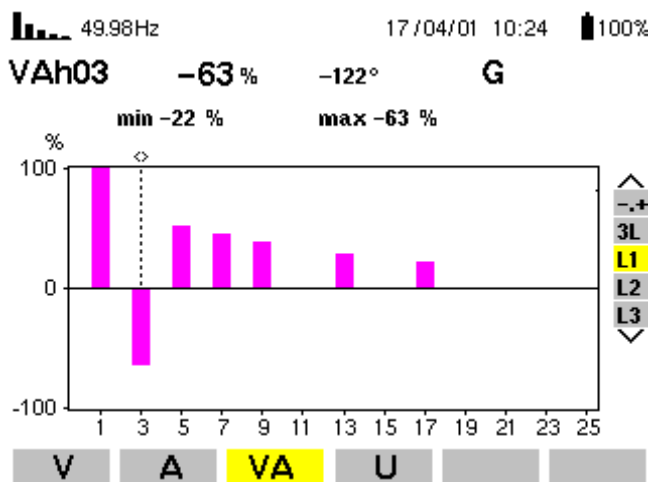

The bars representing the harmonics have signs.

Since the bar selected is negative, pictogram **G** indicates that it is a harmonic emitted (by convention, positive harmonics are received and negative harmonics emitted). The sign is only available in harmonic power measurement.

4. Harmonic analysis in expert mode (C.A 8334B only)

Press on the key to select "-.+" and on the variable function key **V**; the following is displayed (ditto for **A**):

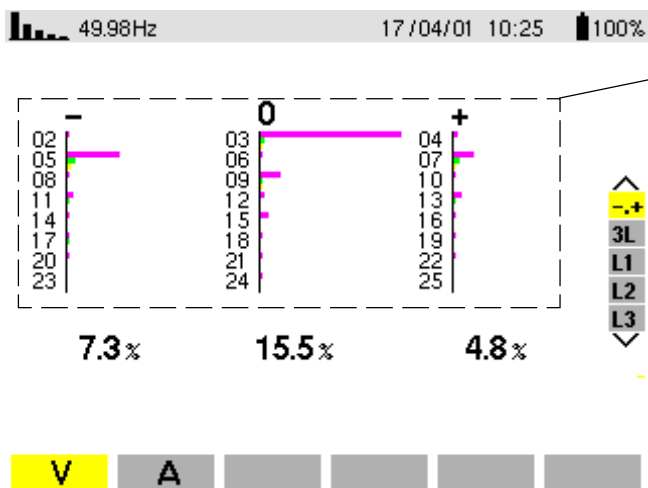

Note:

- in the first column, the harmonics inducing a negative sequence are indicated,
- in the second column, those inducing a nil sequence (added into the neutral)
- in the third column, those inducing a positive sequence.

The influence of harmonics on heating of the neutral or on rotating machines can thus be analysed.

Expert function is possible in **V** and **A**

4.3 Power / Energy Mode W

- Press on the display mode key **W**

The instrument enables:

- Active energy measurement : produced and consumed (negative and positive)
- Measurement of reactive power: capacitive or inductive
- Measurement of apparent power:

- To start energy aggregation, press , the date and time appear on the top, left of the screen

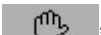
- To stop energy aggregation, press , the date and time appear on the top, right of the screen

- To reset the counters to zero, press on 

■ Starting and stopping energy aggregation

The following screen presents the principal values characterising power and energy

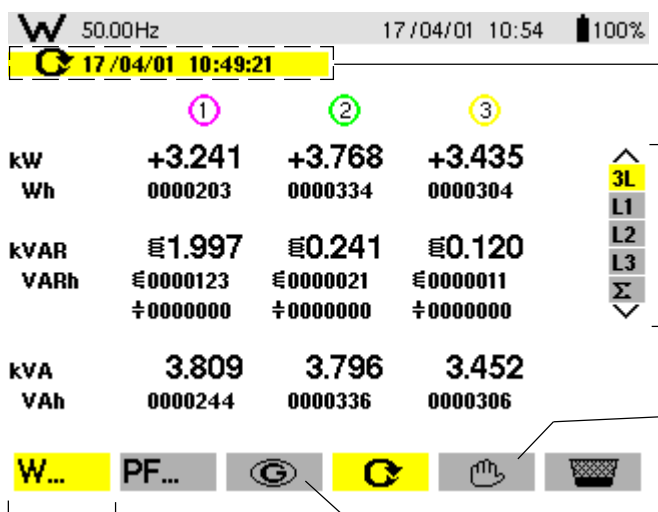

Start of energy aggregation with date/time indication

After pressing a  key the indication of the date and time of accumulation start appears.

Selection of the three phases - **3L** - or one in particular - **L1**, **L2** or **L3** - by pressing on the  keys.

Energy accumulation stoppage.

Displays the generated or consumed energy

Choice of power parameters

	1	2	3
kW	+3.241	+3.768	+3.435
Wh	0000203	0000334	0000304
kVAR	€1.997	€0.241	€0.120
VARh	€0000123	€0000021	€0000011
	‡0000000	‡0000000	‡0000000
kVA	3.809	3.796	3.452
VAh	0000244	0000336	0000306



Note: The display is automatically adjusted for a display in W, VA, VAR or kW, kVA, kVAR
It is possible to switch to other display modes without stopping the aggregation.

■ Key

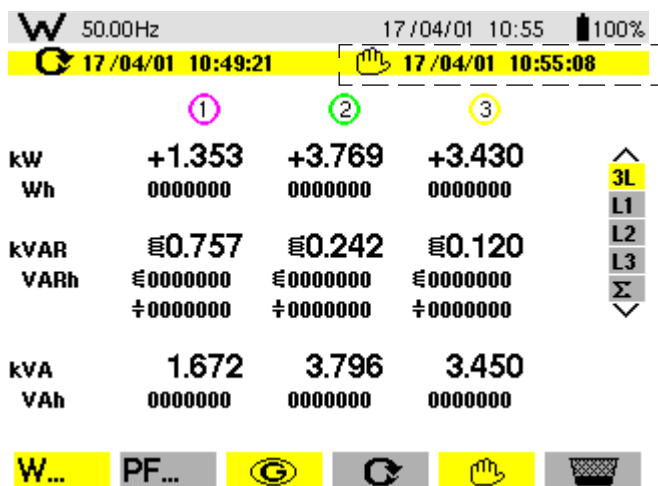
This function key is used to display produced or consumed power or energy on each type: active, reactive and apparent.



After a key  is pressed, the indication of the date and time of accumulation stoppage appears, the energy values are then frozen for once and for all.

It will necessary to press the  key again to recover the possibility of starting another accumulation of energy (by pressing the  key).

	1	2	3
kW	+1.353	+3.769	+3.430
Wh	0000000	0000000	0000000
kVAR	€0.757	€0.242	€0.120
VARh	€0000000	€0000000	€0000000
	‡0000000	‡0000000	‡0000000
kVA	1.672	3.796	3.450
VAh	0000000	0000000	0000000

If the  key is pressed, the energy is produced (from load to source); otherwise, the energy consumed is produced (from source to load). The accumulated energy is therefore given on 8 different meters (per channel) :

- active energy consumed
- reactive inductive energy consumed
- reactive capacitive energy consumed
- apparent energy consumed
- active energy produced
- reactive inductive energy produced
- reactive capacity energy produced
- apparent energy produced

■ Key **PF...**

In **3L** display mode, the PF, DPF (Displacement Power Factor) or $\cos \varphi$ values and the tangent can be displayed by pressing on the **PF** function key phase by phase (on all 3) and total.

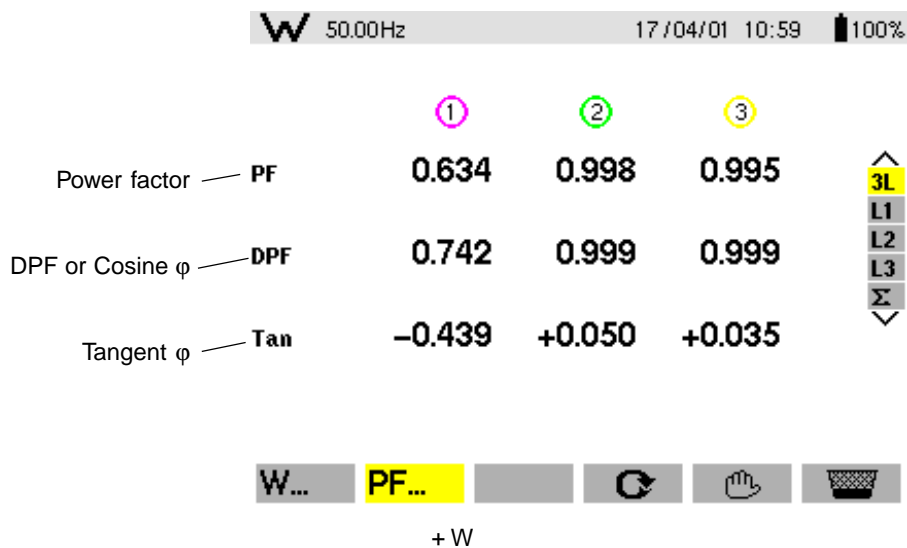

Nota:
Four quadrants power diagram

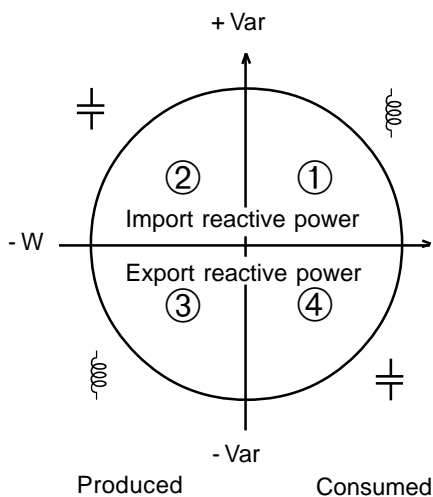

 When the active energy is negative the reactive energy polarity generates "inverted" physical behaviour (inductive or capacitive).



4.4 Transient mode (on C.A 8334B only)



Press on the display mode key 

Transient states can be displayed as curves. All the channels (6) are stored in memory for each transient state (irrespective of the connection configuration).

It is possible to capture up to a maximum of 50 transient states.

The function keys enable the user to:

- capture search programming for a new transient with 
- display a captured transient with 
- delete a captured transient with 

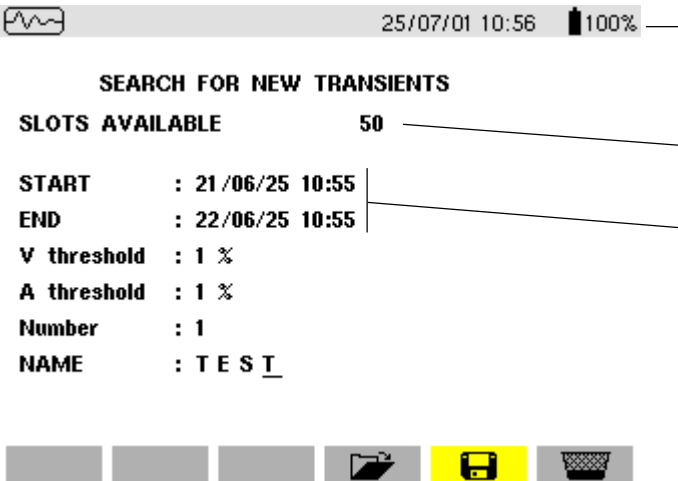

■ The screen below, accessed with the  key, shows the programming to capture a new transient (if a search is currently in process, the user can stop it by pressing on )





When scanning for transient states, a progression bar is displayed, indicating the ratio between the number of transient states already found and the programmed number of transient states.

Number of transient states that can still be recorded (refreshed in real time).

Transient search start and end time

Press on the  keys to select the parameters and on the  keys to modify them.

- Setting trigger thresholds : 1%, 2%, 5%, 10%, 20%, 50%, 100%, for voltage and current.
- Choice of the name and number of transients with the keys:
 -  selection of the character place (a maximum of 7 characters)
 -  selection of the alphanumeric value
- Validate with the  key

If tripping is on current, a recording of the voltage and current waveform is made on all the measurement channels (6 in all).

	THRESHOLD							
	100%	50%	20%	10%	5%	2%	1%	
MN 200A clamp meter	200	100	40	20	10	4	2	
MN 100A clamp meter	100	50	20	10	5	2	1	
Clamp meter C	1000	500	200	100	50	20	10	
AmpFLEX	2900	1400	580	290	140	58	29	
Clamp meter PAC	1000	500	200	100	50	20	10	
Clamp meter MN 5A	[(Primary × 5) ÷ (Secondary)] × (Percentage ÷ 100)							
Adaptator 5A								
Voltage	480	240	96	48	24	9,6	4,8	

■ The screen below can be accessed with the  key and displays a transient previously stored in the memory.







Displays the memory occupied by transients stored

SELECTION OF TRANSIENT

C6	05/07/01	14:31:41
C5	05/07/01	14:31:41
C3	05/07/01	14:31:21
C2	05/07/01	14:31:04
C1	05/07/01	14:31:04

Transient time and date recording

Press on the  keys to select the transient and validate with the  key

The  keys are also used to select a transient to be deleted (); then validate with .



■ **Storing trigger**

The threshold T in percent, define an envelope width over and under the last cycle of signal V and A.

Let $S(t)$ depend on a T-periodic signal and L be the half-width of the selected tube.

The sample having value $S(t_0)$ is then considered to be “transient state recording triggering” if and only if

$S(t_0) \notin] S(t_0-T) - L; S(t_0-T) + L [$ and the apparatus is not already processing a transient state.

■ The screen below displays the transient selected on the previous screen:



17/04/01 11:22:33

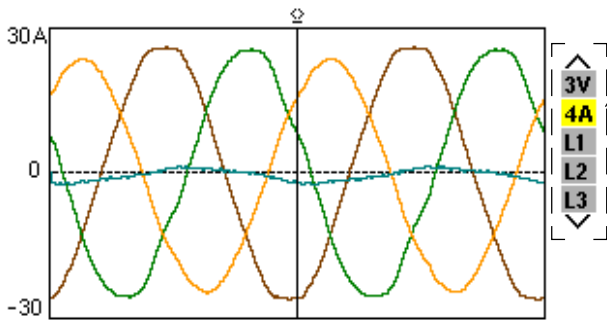

- Representation on the screen of 4 periods of 256 counts/periods with 1 cycle before the trigger and 3 cycles after
- Display of the date and time the transient was recorded

The curves to be displayed are selected by pressing on the  keys:

- 3V displays the three single voltages during the transient,
- 4A displays the three currents and the neutral current during the transient,
- L1, L2 or L3 display the single current and voltage in turn on phase 1, 2 or 3.

Instant values of signals at an instant “t”, in relation to the cursor on the time scale with the  keys

NB : The “Trigger” sample is included within the time interval $[0 ; T/8[$ (where T is the signal period).

■ **After selecting 3V**



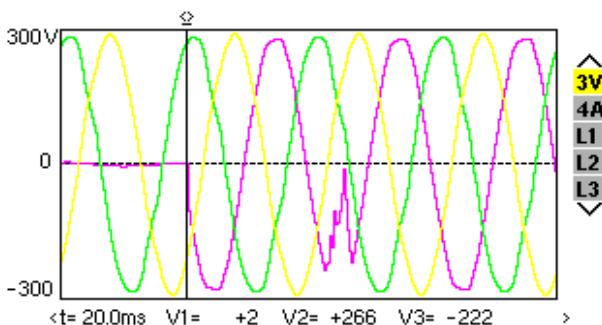

17/04/01 11:22:33

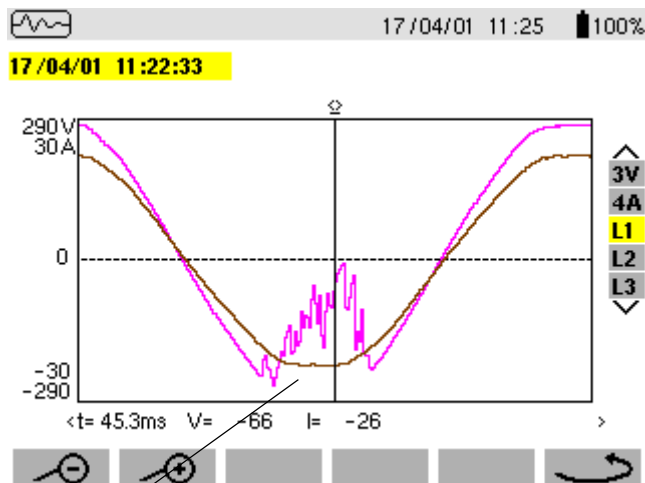
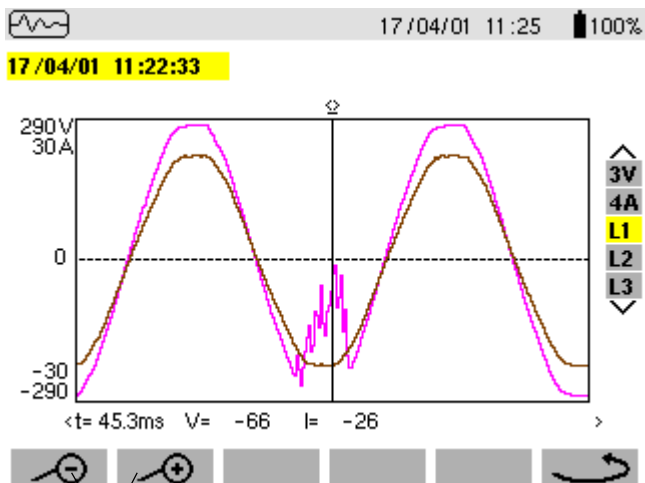

This key allows the user to return to the transient selection screen

■ After selecting L1





These keys allow the user to change the time scale (screen display of 4, 2 or 1 periods) centered on the cursor, which can be moved with the $\leftarrow \rightarrow$ keys, giving, for example, the next screen by pressing on .

All the transients stored can be exported to a PC equipped with the “QualiStarView” operating software.

4.5 Alarms Mode

- Press on the display mode key 
- The next screen presents the various alarms stored.

Note: The threshold values must first have been programmed in the  mode

-  GO launches alarm capture
-  stop alarm capture
-  poub deletes all stored alarms

Alarm memory status

Time	Target	Parameter	Value	Duration
11:27	L1	Vthd	23.1%	2s
	L1	Vrms	0V	1s24 ¹ / ₁₀₀₀ s
	L1	Vthd	34.3%	1s
	L1	Vthd	35.0%	1s
	L1	Arms	1A	1s5 ¹ / ₁₀₀₀ s
11:28	L2	Arms	1A	1s3 ¹ / ₁₀₀₀ s
	L1	Arms	0A	1s9 ¹ / ₁₀₀₀ s
11:29	L2	Arms	0A	1s9 ¹ / ₁₀₀₀ s
	L3	Arms	0A	1s8 ¹ / ₁₀₀₀ s
	L1	Vrms	109V	3s37 ¹ / ₁₀₀₀ s
	L1	Vthd	35.1%	3s

2/2

Alarm target
measurement parameter surveyed
maximum or minimum amplitude
Alarm duration

Selection of alarms with the  keys

Display of alarms within a period of time with the $\leftarrow \rightarrow$ keys

Note: All the alarms recorded can be exported to a PC with the operating software. Up to 4096 alarms can be captured.



 The alarm values recorded in **W**, **VAR**, **PF**, **DPF** and **Tan?** are in absolute values.

Note: The type of connection selected in the  mode has no influence on the possibilities of choosing the alarm target and monitored parameter. The user is responsible for making pertinent choices.

4.6 Recording Mode

This mode enables all the parameters previously configured in the  mode to be recorded.

The function keys available in this mode enable:

- a new record to be made with 
- an record to be displayed with 
- an record to be deleted with 





■ Saving selected parameters



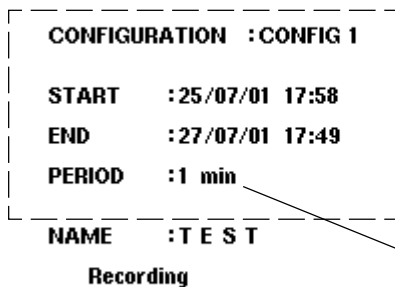





This scale allows a current record to be displayed

NEW RECORDING



Press on the   keys to select the parameters and on the   keys to modify them.

- Modification of the configuration number with the   keys (CONFIG 1, 2, 3 or 4)
 - Modification of the dates with the   keys
 - Entering of the record name with the   keys which scroll through the alphabet and numbers
- Validate with the  key



Stop recording

The possible recording integration periods are: 1s, 5s or 20s and 1, 2, 5, 10 or 15min

Note: the start and end dates are adjusted according to the chosen recording integration period.

"PERIOD" does not refer to a sampling period but to an integration period (average).

Note : The device calculates in real time the storage needs of the recording and if necessary displays the message "Not enough memory".

■ Selecting or deleting a record

Press the  mode key:

The screen below can be accessed with the  key and displays a record previously stored in the memory.





Displays the memory occupied by previous records





SELECTION OF RECORDING

TEST	25/07/01 17:58	> In progress
AIM110	18/07/01 11:24	> 18/07/01 11:45
KI	12/07/01 14:41	> 12/07/01 16:40

To select:

Press on the   keys to select the record required and validate with the  key

or to delete:

select the record to be deleted with the   keys and press on , validate with 

Tip!: It is possible to display a measurement being recorded by selecting the name of the recording. To refresh the screen, press the mode key  (caution: loss of cursor position and zoom).

The following screen opened using a key, is a way of consulting a recording previously stored in memory.

The device makes an automatic correction if the programming dates and times do not match:

- the current date
- the current time
- the set recording integration period (it is advisable to set times that are multiples of the integration period).

Note: the instrument automatically corrects the start and end time in order to improve the readability of the time scales of the recording mode (graph representation).

■ **Selecting a graphic display for recorded measurements**

Recordings of measurements are displayed in graphic form

Selecting the "TEST" record (see "selecting a record") gives access to the screen below which allows the selection of the measurement to be displayed:

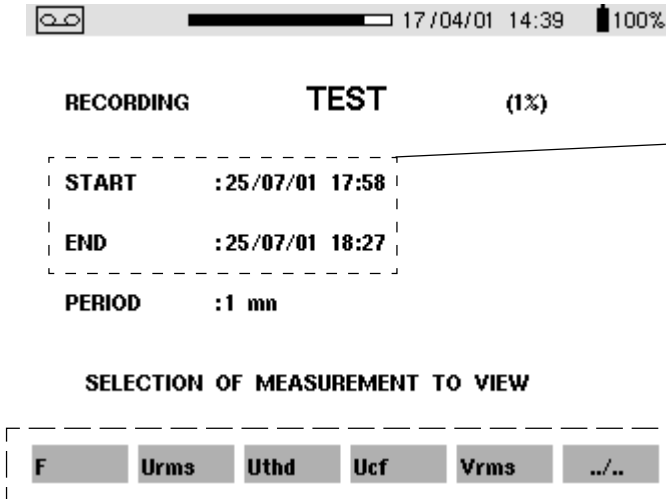

Indication of recording conditions

These keys enable direct selection of the measurement to be displayed.
A series of short presses on the "..../.." key enables the user to scroll through the measurements selected when this record was programmed.

Note : It is possible to scroll through the measurements using the keys.

■ **An example of the graphic display of V RMS measurements**

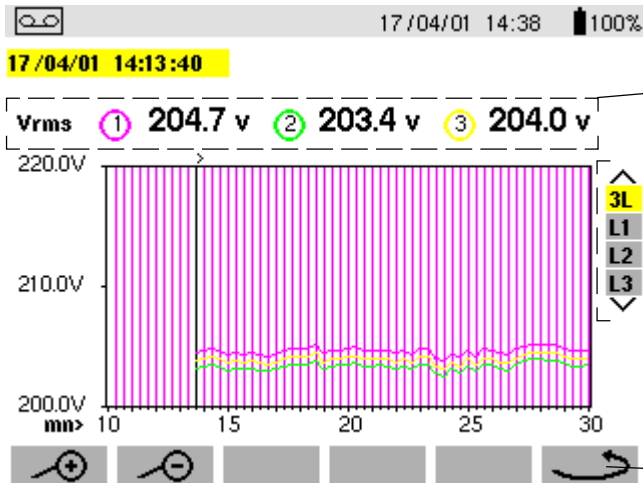

- When the **V RMS** key is pressed, the following screen is displayed:

Display of the average voltage for each of the 3 voltages, hour-by-hour by moving the cursor with the keys.

3 phases or each individual phase can be selected using the keys

Returns the user to the screen where the measurement to be displayed is selected

- When the **L1** phase is selected, the following screen is displayed:

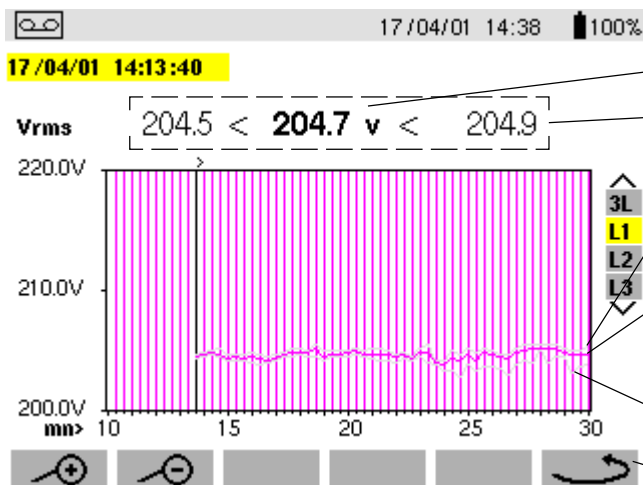

The average value is calculated for the display integration period

Extremes and average values over the display integration period

Max. value

Average value

Min. value

Returns the user to the "Selection of the measurement to view"

⚠ When the display integration period is different from the recording integration period:

- The displayed **Avg** value is the average of the measurements for each recording integration period in a display integration period
- The extreme values are the minimum and maximum recording integration periods in a display integration period.

Graphic display of average power

After returning to the "Selection of the measurement to view" screen with the **./.** key and pressing on the **W** key, the user obtains:

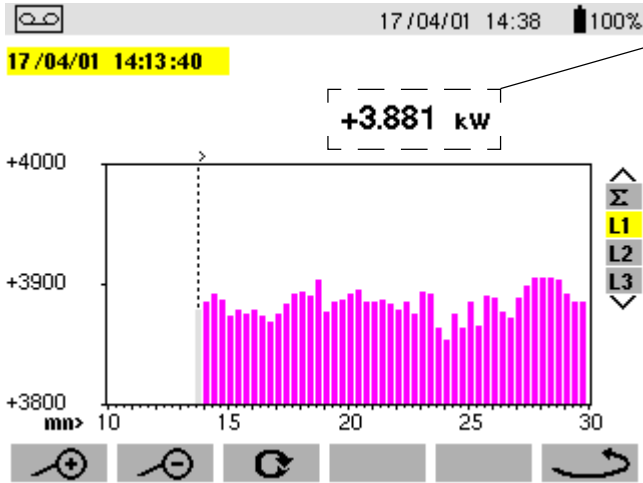

Average value of the active power on the **L1** phase, by moving the cursor with the **◀▶** keys:

Note: Hold the selected key down to switch to fast forward

Energy measurement for a determined period

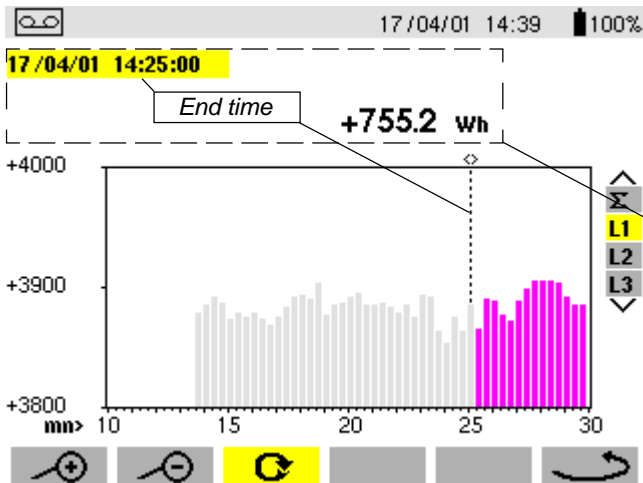

The energy over a selected period can be deduced from the average power records:

- Press on the **↻** function key when the cursor is positioned on the start instant of the energy calculation
- Move the cursor with the **◀▶** keys to select the end instant

The energy value is displayed, with **end dates and times**.

In this way, it is possible to make an energy measurement over several recording ranges in the 4 quadrants.

Note: All the data concerning a recording campaign can be exported to a PC using the software «QualiStarView».

Note: The **+** and **-** keys are used for changing the display integration period of the displayed measurement and the time scale of the graphics.

Display integration period	Graph scale
2 hours	over 5 days
1 hour	over 2 1/2 days
15 minutes	over 15 hours
10 minutes	over 10 hours
5 minutes	over 5 hours
1 minute	over 1 hour
20 seconds	over 20 minutes
5 seconds	over 5 minutes
1 second	over 1 minute

Note: The minimum display integration period is limited by the recording integration period. The recording integration period of 2 minutes is a special case. In this case, only the following display integration periods are possible: 10 minutes, 1 hour and 2 hours.

4.7 Screen Memorisation

The  key allows 8 or 12 displays to be saved (according to the instrument model) for recall or display later on.

■ **A long press** (about 3 s) on this key freezes the current screen:

The  icon is displayed as soon as the operation has finished.



This icon is replaced by  if there is no space left in the memory to record the photo.

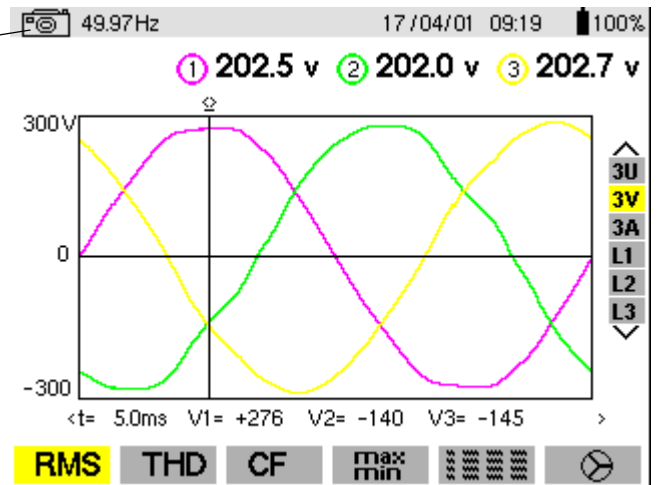

Note: These screens can be stored on a PC via the QualiStartView operating software.





■ **A short press** (about 1 s) on this key gives access to the menu of screens already saved:



The selection of the screen to be displayed (or erased) is carried out using the  and  keys

To display the screen selected, press on  then on the validation  key.

To delete the screen selected, press on  then on the validation  key.







To exit from the display of the recorded screen and return to the display of the recorded screen menu, press the  key again.

Important note: the various storage spaces of **C.A 8332B** and **C.A 8334B** are of a fixed size and are completely independent of one another (partitioned). There are **4** spaces for **C.A 8334B** (alarms, photographs, transient states and recordings) versus **3** for **C.A 8332B** (less the transient states).

4.8 Printing

The  key allows a screen to be printed immediately on a dedicated printer connected to output ⑨

In the example opposite, one press on the  key freezes the current screen, in this case, the  icon replaces , a bargraph indicates the progress of the data being transferred. The original  icon reappears when the operation has finished.

The current operation can be stopped – in the event of an error, for example – by pressing on the  key again during the data transfer process.

Note:

It will take a few seconds for the  icon to appear.



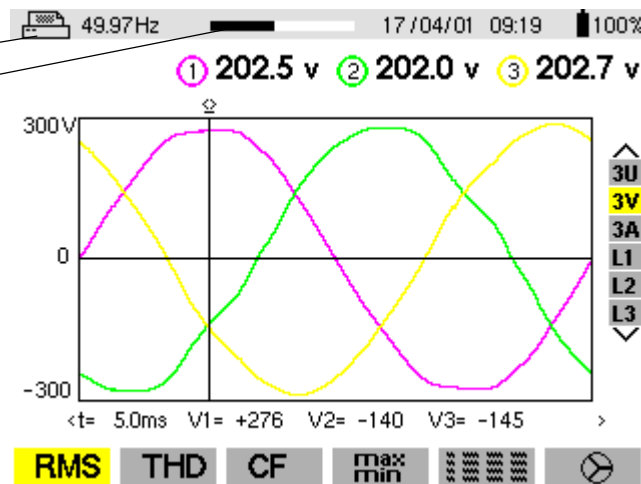

The fixed print transmission speed is 19.2 kbps.





The dedicated printer for the Qualistar is "DPU 414 - SEIKO" (see § 9.3)

4.9 Help

The  key allows the user to obtain help in the selected language for the current display mode.

Icon	Description
	27/07/01 15:34 100%
PF...	Display of PF, DPF and Tan
W	Active power
Wh	Active energy consumed
VAR	Reactive power
VARh	Reactive energies consumed
VA	Apparent power
VAh	Apparent energy consumed
	Start of cumulated energy metering
	End of cumulated energy metering
	Reinitialization of cumulated energy metering
	Choice of measurement target (3L,L1,L2,L3,Sigma)

Example:

While the  display is in use, one press on the  key displays the information opposite.

4.10 QualistarView software

The QualistarView software is running on Windows 9x, NT4, Me, 2000 and XP.

Run Setup.exe

Setup of serial communication:

- On Qualistar (**Setup** mode)
- On the software "**Qualistar View**" (Submenus : Options > Communication)

Nota: the communication speed must be the same on the Qualistar and the "QualistarView" software.

Once the speed has been configured start retrieving the **Qualistar** configuration (Submenu: Options > Setup **Qualistar**) to see how the serial communication works.

The data imports from **Qualistar** (to the PC) generate backups of files specific to **Qualistar View** of which the extensions are as follows:

- ".mon" (for a recording)
- ".trs" (for a transient state)
- ".bmp" (for a screenshot)
- ".ala" (for a complete or customized alarms log)
- ".per" (for the recording of a measurement and a data channel to which a display integration period is assigned other than the recording integration period of **Qualistar**)
- ".trt" (for a recording to which a voltage transformer ratio of 1 to 2999 has been applied)

5. GENERAL SPECIFICATIONS

5.1 Dimensions and weight

- 240 x 180 x 55mm
- 2,1kg with batteries

5.2 Power supply

■ AC mains supply

With an internal mains adaptor

Range for use: 85-265V 50/60Hz

Max. power: 40VA

■ Battery power

Allows the instrument connected to the AC supply to be used in the event of a power interruption.

Type: NiMH 4000 mAh

Output: 4-wire (2 for temperature probe)

Rated voltage: 9.6V

Charge time: approx. 5hrs

Temperature for use : 0°...+50°C

Recharging temperature : +10°...+40°C

Storage temperature : **-20°C...+50°C** (duration ≤ 30 days) **-20°C...+40°C** (duration from 30 to 90 days) **-20°C...+30°C** (duration from 90 days to 1 year).

The battery starts to charge when the mains supply adaptor is connected.

When the battery is charged, the instrument uses the current supplied via the mains supply without drawing on the battery.

5.3 Climatic conditions

5.3.1 Environmental conditions

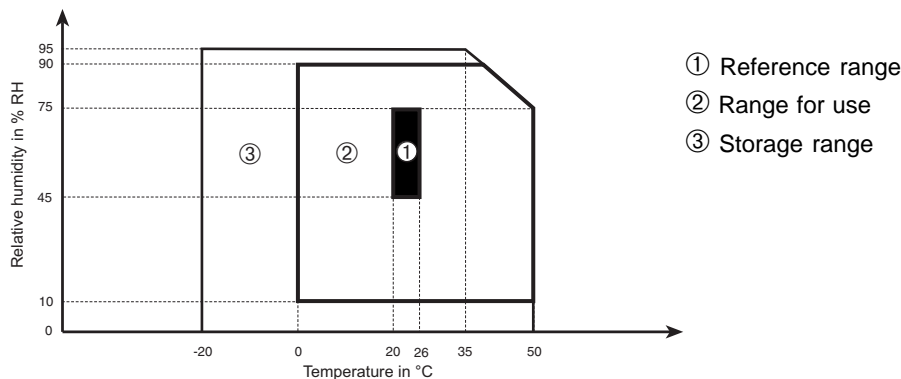

5.3.2 Altitude

Use: 0..0.2000 m

Storage: 0...10 000 m

5.4 Compliance with international standards

5.4.1 Electrical safety (as per NF EN 61010-1 : 2001)

- Double insulation:
- Measurement category: IV
- Pollution level: 2
- Assigned voltage: 600 V RMS
- Inside use

5.4.2 Electromagnetic compatibility

- Immunity: as per NF EN 61236 - 1 : 2006
- Influence THD at 10V/M : 4.5%
- Radiation field resistance: as per IEC 1000-4-3
- Electric shock resistance: as per IEC 1000-4-5
- Voltage interruption as per IEC 1000-4-11
- Electrostatic discharges: as per IEC 1000-4-2
- Emission as per NF EN 61236 - 1 : 2006
- Fast transients resistance: as per IEC 1000-4-4
- Conducted RF interference: as per IEC 1000-4-6

5.4.3 Mechanical protection

- Operating position: Indifferent
- If dropped: as per NF EN 61010-1
- Impermeability: IP 50 as per NF EN 60529 A1 (*electrical IP2X for the terminals*)
- Rigidity: as per NF EN 61010-1

6. FUNCTIONAL CHARACTERISTICS

6.1 Reference conditions

Influence parameter	Reference conditions
Ambient temperature	23°C ± 3K
Humidity	45% RH
Atmospheric pressure	860 to 1060 hPa
Phase voltage	230 V rms and 110 V rms ±2% without DC
Current circuit input voltage other than AmpFlex	0.03 V ≤ I ≤ I _n = 1 V rms without DC (< 0.5%)
AmpFlex current circuit input voltage	11.8mV ≤ I ≤ I _n = 118 mV rms without DC (< 0.5%)
Frequency of electricity network	50 and 60 Hz ±0.1 Hz
V/I phase shift	0 degree or 90 degrees
Harmonics	< 0.1%

The uncertainties given for power and energy measurements are maximum for $\cos \varphi = 1$ or $\sin \varphi = 1$ and are typical for the other phase shifts.

6.2 Electrical specifications

Sampling frequency: 12.8 kHz per channel at 50 Hz (256 samples per period)

6.2.1 Voltage inputs

- Operating range: - phase – phase: 960 V RMS
- phase – neutral: 480 V RMS
- Input impedance : 340 kΩ between phase and neutral
- Admissible overload : 1.2 V_n permanently
2 V_n for 1 sec

6.2.2 Current inputs

- Operating range: 0- 1 V
- Input impedance: 100 kΩ for the circuit other than AmpFlex and 12.4 kΩ for circuit AmpFLEX
- Admissible overload: 1.7 V

6.2.3 Characteristics of the device alone (without the current sensors)

Measurement		Measuring Range		Display Resolution	Error in the reference range
		Minimum	Maximum		
Frequency		40Hz	69Hz	0,01Hz	±(0,01Hz)
Single TRMS Voltages		6V	480V	0,1V	±(0,5%+0,2V)
TRMS Composite Voltages		10V	960V	0,1V	±(0,5%+0,2V)
DC Voltages		6V	680V	0,1V	±(1%+0,5V)
TRMS Current	Other than AmpFLEX	I _{nom} ÷ 1000 [A]	1,2 × I _{nom} [A]	0,1A I < 1000A	±(0,5%+0,2A)
				1A I ≥ 1000A	±(0,5%+1A)
	AmpFLEX	10A	6500A	0,1A I < 1000A	±(0,5%+1A)
				1A I ≥ 1000A	
DC Currents (clamp meter PAC)		1A	1700A ⁽¹⁾	0,1A I < 1000A	±(1%+1A)
				1A I ≥ 1000A	

$$(1) 1,2 \times 1000 \times \sqrt{2} = 1700A$$

Measurement		Measuring range		Display Resolution	Error in the reference range
		Minimum	Maximum		
Peak Current	Other than AmpFLEX	0A	$1,7 \times I_{nom}$ [A] ⁽¹⁾	0,1A $I < 1000A$	$\pm(1\%+1A)$
	AmpFLEX		9190A ⁽²⁾	1A $I \geq 1000A$	
TRMS half period current ⁽⁵⁾	Other than AmpFLEX	$I_{nom} \div 100$ [A]	$1,2 \times I_{nom}$ [A]	0,1A $I < 1000A$	$\pm(1\%+0,5A)$
				1A $I \geq 1000A$	$\pm(1\%+1A)$
	AmpFLEX	100A	6500A	0,1A $I < 1000A$	$\pm(1,5\%+4A)$
				1A $I \geq 1000A$	
Single Peak voltages		6V	680V ⁽³⁾	0,1 V	$\pm(1\%+0,5V)$
Peak composite voltage		10V	1360V ⁽⁴⁾	0,1V $U < 1000V$	$\pm(1\%+0,5V)$
				1V $U \geq 1000V$	
TRMS half period phase to phase voltage ⁽⁵⁾		6V	480V	0,1V	$\pm(0,8\%+0,5V)$
TRMS half period phase to ground voltage ⁽⁵⁾		10V	960V	0,1V	$\pm(0,8\%+0,5V)$
Peak factor		1	9,99	0,01	$\pm(1\%+0,02)$

1) $1.2 \times I_{nom} \times \sqrt{2} = 1.7 \times I_{nom}$

2) $6500 \times \sqrt{2} = 9190A$

3) $480 \times \sqrt{2} = 680V$

4) $960 \times \sqrt{2} = 1360V$

5) Caution : The absolute offset value must not exceed 14% of the peak amplitude.

In other words, $s(t) = S \times \sin(\omega t) + O$, giving us $|O| \leq 0.14 \times S$ (with positive S).

The half period values are the MAX and MIN values of the waveform mode and the V_{RMS} , U_{RMS} and A_{RMS} values (other than the neutral current) are used in the Alarm mode.

Measurement		Etendue de mesure		Résolution d'affichage	Erreur dans le domaine de référence
		Minimum	Maximum		
Active Powers	Other than AmpFLEX	0W	9999kW	4 digits	$\pm(1\%)$ $\text{Cos } \phi \geq 0,8$
					$\pm(1,5\%+10\text{pts})$ $0,2 \leq \text{Cos } \phi < 0,8$
	AmpFLEX	0W	9999kW	4 digits	$\pm(1\%)$ $\text{Cos } \phi \geq 0,8$
					$\pm(1,5\%+10\text{pts})$ $0,5 \leq \text{Cos } \phi < 0,8$
Reactive Powers	Other than AmpFLEX	0VAR	9999kVAR	4 digits	$\pm(1\%)$ $\text{Sin } \phi \geq 0,5$
					$\pm(1,5\%+10\text{pts})$ $0,2 \leq \text{Sin } \phi < 0,5$
	AmpFLEX	0VAR	9999kVAR	4 digits	$\pm(1,5\%)$ $\text{Sin } \phi \geq 0,5$
					$\pm(2,5\%+20\text{pts})$ $0,2 \leq \text{Sin } \phi < 0,5$
Apparent power		0	9999kVA	4 digits	$\pm(1\%)$
Power factor		-1	1	0,001	$\pm(1,5\%)$ $\text{Cos } \phi \geq 0,5$
					$\pm(1,5\%+0,01)$ $0,2 \leq \text{Cos } \phi < 0,5$
Tangent $\text{VA} \geq 50\text{VA}$		-32,76	32,76	0,001 $\text{Tan } \phi < 10$	$\pm(1^\circ)$ sur ϕ
				0,01 $\text{Tan } \phi \geq 10$	

Measurement		Measuring range		Display Resolution	Error in the reference range
		Minimum	Maximum		
Active energy	Other than AmpFLEX	0Wh	9999MWh	4 digits	$\pm(1\%)$ $\text{Cos } \phi \geq 0,8$
					$\pm(1,5\%)$ $0,2 \leq \text{Cos } \phi < 0,8$
	AmpFLEX	0Wh	9999MWh	4 digits	$\pm(1\%)$ $\text{Cos } \phi \geq 0,8$
					$\pm(1,5\%)$ $0,5 \leq \text{Cos } \phi < 0,8$
Energies réactives	Other than AmpFLEX	0VARh	9999MVARh	4 digits	$\pm(1\%)$ $\text{Sin } \phi \geq 0,5$
					$\pm(1,5\%)$ $0,2 \leq \text{Sin } \phi < 0,5$
	AmpFLEX	0VARh	9999MVARh	4 digits	$\pm(1,5\%)$ $\text{Sin } \phi \geq 0,5$
					$\pm(2,5\%)$ $0,2 \leq \text{Sin } \phi < 0,5$
Apparent energy		0VAh	9999MVAh	4 digits	$\pm(1\%)$
Unbalance (three phase system)		0%	100%	0,1%	$\pm(1\%)$
Phase angle		-179°	180°	1°	$\pm(2^\circ)$

Measurement	Measuring range		Display Resolution	Error in the reference range
	Minimum	Maximum		
Harmonics ratios $(V_{RMS} > 50V)$ $(I_{RMS} > I_{nom} \div 100)$ rang $\in [1 ; 50]$	0%	999%	0,1%	$\pm(1\%+0,5\%)$
Harmonics angles $(V_{RMS} > 50V)$ $(I_{RMS} > I_{nom} \div 100)$	-179°	-180°	↑	$\pm(3^\circ)$ rang $\in [1 ; 25]$
				$\pm(10^\circ)$ rang $\in [26 ; 50]$
Total harmonics ration rang $\in [1 ; 50]$	0%	999%	0,1%	$\pm(1\%+0,5\%)$
Factor K	1	99,99	0,01	$\pm(5\%)$

6.2.4 Nominal range of use

Frequency : 40 to 70Hz

Harmonics: THD (I) : 0 to 40%

THD (U) : 0 to 20%

Magnetic field: 0 to 400A/m

Electrical field: 0 to 3V/m

Relative humidity : 10 to 90%, free of condensation.

6.3 Specifications of the sensors (with C.A 8332B/34B)

■ Sensor characteristics C193 (Accessories)

- Nominal range: 1000A AC for $f \leq 1\text{kHz}$
- Measurement range: 3A to 1200A AC ($I > 1000\text{A}$ not permanent)
- Input/Output ratio: 1mV AC/ A AC
- Maximum clamping capacity: 52mm
- NF EN 61010-2-032, 600V CAT IV, POL 2
- Reference conditions

Ambiant temperature	23°C ± 3 K
Humidity	20% to 75% of RH
Frequency	48...65Hz
Distortion factor	< 1% without superimposed DC current
Magnetic field of external origin	< 40A/m (earth's magnetic field)

■ Error in the reference conditions *

Primary current (in A AC)	3...10A	10...100A	100...1200A
Precision (in % of the input signal)	$\leq 0.8\%$	$\leq 0.3\%$	$\leq 0.2\%$
Phase shift (in °)	$\leq 1^\circ$	$\leq 0.5^\circ$	$\leq 0.3^\circ$

* Make a logarithmic interpolation between each specified value

■ Variations in the nominal field of use (to be added to the error under reference conditions)

Ambient temperature from -10°C to +50°C	≤ 200 ppm/K or 0.2% per 10K
Humidity from 10 to 90%	< 0.1%
Frequency in relation to accuracy	30...48Hz : < 0.5% 65...1000Hz : < 1% 1...5kHz : < 2%
Positions of the cable in the jaws	< 0.1% for f ≤ 400Hz
Adjacent conductor carrying a 50Hz AC current	≤ 0.5mA/A
Distortion of crest factor ≤ 6 and current ≤ 3000A peak	< 1%
Distortion DC current ≤ 15A superimposed on the nominal current	< 1%

■ Overloads : Frequency derating beyond 1kHz :

$$I_{max} \leq 1000A \times \frac{1}{f \text{ (kHz)}}$$

■ Specifications of the AmpFLEX A193 (accessories)

- Nominal range : 3000A AC
- Measurement range : 10A to 6500A AC
- Input/Output ratio : 140mV AC/3000A AC at 50Hz
Note : the output is proportional to the amplitude and the frequency of the measured current
- Diameter of the sensor: 140mm Ø / length 450mm or 250mm Ø / length 800mm
- NF EN 61010-1 and 2 (electrical safety) 1000V CAT III or 600V CAT IV, POL 2
- Reference conditions

Ambient temperature	18°C à 28°C
Humidity	20% to 75% of RH
Position of conductor in the sensor	centered
Continuous magnetic field	< 40A/m (earth's magnetic field)
External alternative magnetic field	none present
External electric field	none present
Frequency	from 10Hz to 100Hz
Type of signal measured	sinusoidal

■ Error in the reference conditions

Primary current (in A AC)	10A...100A	100A...6500A
Precision (in % of the input signal)	≤ 3%	≤ 2%
Phase shift at 50 Hz (in °)	≤ 1°	≤ 0.5°

■ Variations in the nominal working range (to be added to the error under reference conditions)

Influencing factors	Influence range	Error
Temperature	-20°C to +60°C	0.2% per 10 K
Relative humidity	10% to 90% RH	0.5%
Frequency response	10Hz...20kHz	0.5%
Position of conductor in clamp	Any position on the internal perimeter of the undeformed sensor	2% (4% near the latching system)
Adjacent conductor carrying an AC current	Conductor in contact with the sensor	1% (2% near the latching system)

■ Characteristics of PAC93 sensors (accessories)

- Rated calibre: 1000A AC, 1400A DC
- Measurement range: 10A to 1000A AC, 10A to 1400A_{PEAK} AC+DC
- Input/output ratio: 1mV/A
- Maximum clamping capacity: one 39 mm Ø cable (two 25 mm Ø cables), a 50 x 12 mm busbar section
- NF EN 61010-2, 600V CAT III, POL 2 or 300V CAT IV, POL 2

⚠ Using C.A 8332B / C.A 8334B (600V CAT IV) with PAC 93 sensors (600V CAT III or 300V CAT IV) involve the set 600V CAT III or 300V CAT IV.

■ Reference conditions

Temperature	18°C to 28°C
Relative humidity ratio	20% to 75% RH
Battery voltage	9V ±0.1V
Position of the conductor in the sensor	centered on the clamp marks
Magnetic field	DC magnetic field
AC external magnetic field	none
External electrical field:	none
Frequency range	≤ 65Hz
Type of signal measured	sinusoidal

■ Error in the reference range

Primary current	10...100A	100...800A	800...1000A AC 800...1400A PEAK
Accuracy	≤ 1.5% +1A	≤ 3%	≤ 5%

Primary current	10...100A	100...1000A
Phase angle	≤ 2°	≤ 1.5°

■ Variation in the rated utilisation range (to be added to the reference range error)

Influence parameter	Influence range	Error
Temperature for use	18°C...28°C	ZERO: ≤ 0.2A/K SCALE: ≤ 300ppm/K or 0.3%/10K
Battery voltage	6.5V to 10V	≤ 1A/V
Position of a 20 mm Ø 20 conductor	10% and 90% RH DC at 440Hz DC at 1Hz DC at 2Hz DC at 5Hz	≤ 0.5% of the reading < 0.5% of the reading < 1% of the reading < 3% of the reading < 10% of the reading
Live adjacent conductor	50 and 60Hz	< 10mA/A AC (23 mm from the clamp)
External field	400A/m	< 1.3A
Rejection in common mode (in AC)	50 to 400Hz	> 65dB
Remanence in DC	+1400A DC at -1400A DC	< 4mA/A
Frequency of the measurement signal	65Hz to 440Hz 440Hz to 1kHz 1kHz to 10kHz	-2% -5% -4dB

■ OVERLOADS

Derating in frequency beyond 1kHz
 $I_{max} \leq 1000A \times 1 / f \text{ (kHz)}$

■ Specifications of the MN93A sensors (accessories)

- Maximum clamping capacity: 20 mm
- NF EN 61010-2-032, 600V CAT III, POL 2 or 300V CAT IV, POL 2

⚠ Using C.A 8332B / C.A 8334B (600V CAT IV) with MN 93A sensors (600V CAT III or 300V CAT IV) involve the set 600V CAT III or 300V CAT IV.

■ Reference conditions

Ambiant temperature	23°C ±3 K
Humidity	20% to 75 % of RH
Frequency	from 48...65 Hz
Distortion factor	< 1% (without superimposed DC current)
Magnetic field of external origin	< 40 A/m (earth's magnetic field)
Position of the cable	Centered

■ Error in the reference conditions

Calibre 100A

- Nominal current : 100A AC
- Measurement range : 100mA to 120A AC
- Input / Output ratio : 10mV AC / A AC

Primary current (A AC)	100mA...1A	1A...120A
Accuracy (as % of the input signal)	≤ 0.7% + 2mA	≤ 0.7%
Phase shift	≤ 1.5°	≤ 0.7°

Calibre 5A

- Nominal current : 5A AC
- Measurement range : 5mA to 6A AC
- Input / Output ratio : 200mV AC / A AC

Primary current (A AC)	5mA...50mA	50mA...500mA	500mA...6A
Accuracy (as % of the input signal)	≤ 1% + 0.1mA	≤ 1%	≤ 0.7%
Phase shift	≤ 1.7°	≤ 1°	≤ 1°

■ Variation in the nominal working range (to be added to the error under reference conditions)

Influencing factor	Measurement influencing
Ambiant temperature	≤ 200ppm/K or 0.2%/10K
Humidity (10 ... 90%)	< 0.2%
Frequency (40Hz ... 1kHz)	< 0.7%
Frequency (1kHz ... 3kHz)	< 2%
Position of conductor in clamp	< 0.5% to 50/60Hz
Adjacent conductor carrying a 50Hz AC current	< 15mA/A

- Overloads : Continuous maximum current from 100A to frequency ≤ 1kHz
Frequency derating beyond 1 kHz :

$$I_{max} \leq 100 \text{ A} \times \frac{1}{f \text{ (kHz)}}$$

Output maximal voltage (saturated secondary) from 8V max. peak.

■ Specifications of the adapter box 5A (accessories)

- Nominal range : 5 A
- Measurement range : 1 mA to 6 A
- Input / Output ratio : 0,2 mV AC / mA AC
- NF EN 61010-2, 300V CAT III or 150V CAT IV, POL 2



Using C.A 8332B / C.A 8334B (600V CAT IV) with adapter box 5A (300V CAT III or 150V CAT IV) involve the set 300V CAT III or 150V CAT IV.

- Reference of conditions

Ambiant temperature	23°C ± 3K
Humidity	50% to 85% of HR
Frequency	48 to 500 Hz
Magnetic field of external origin	< 40 A /m (earth's magnetic field)
Other channels	No connected

- Error in the reference conditions

Primary current (A AC)	1mA ... 50mA	50mA ... 6A
Accuracy (as % of the input signal)	≤ 1%	≤ 0,5%
Phase shift	≤ 1°	≤ 0,2°

- Variation in the nominal working range (to be added to the error under reference conditions)

Influencing factor	Measurement influencing
Ambient temperature	≤ 0,1% / 25K
Frequency (30 Hz ... 48 Hz)	< 0,2% + 0,2°
Frequency (48 Hz ... 500 Hz)	< 0,1% + 0,1°
Frequency (500 Hz ... 1 kHz)	< 0,3% + 0,2°
Frequency (1 kHz ... 5 kHz)	< 0,5% + 1°

- Permanent Overload : 10 A

■ **Specifications of the MN93 sensors (accessories)**

- Nominal range: 200A AC for f ≤ 1kHz
- Measurement range: 2A to 240A AC (I > 200A not permanent)
- Input/Output ratio: 5mV AC/ A AC
- Maximum clamping capacity: 20mm
- NF EN 61010-2-032, 600V CAT III or 300V CAT IV, POL 2

⚠ Using C.A 8332B / C.A 8334B (600V CAT IV) with MN 93 sensors (600V CAT III or 300V CAT IV) involve the set 600V CAT III or 300V CAT IV.

- Reference conditions

Ambiant temperature	23°C ±3 K
Humidity	20% to 75 % of RH
Frequency	48...65 Hz
Distortion factor	< 1% without superimposed DC current
Magnetic field of external origin	< 40 A/m (earth's magnetic field)

- Error in the reference conditions

Primary current (in A AC)	2...10 A	10...100 A	100...240 A
Accuracy (as % of the input signal)	≤ 3% +1A	≤ 2.5% +1A	≤ 1% +5 mV
Phase shift (in °)	≤ 6°	≤ 3°	≤ 2°

- Variations in the nominal working range (to be added to the error under reference conditions)

Ambiant temperature from -10°C to +50°C	≤150 ppm/K or 0.15% per 10 K
Humidity from 10 to 90%	<0.2%
Frequency in relation to accuracy	40 Hz...1 kHz : < 3% 1...10 kHz : < 12%
Positions of the cable in the jaws	<0.5% to 50/60 Hz
Adjacent conductor carrying a 50 Hz AC current	≤ 15 mA/A
Distortion DC current < 20 A superimposed on the nominal current	< 5%
Distortion of crest factor ≤ 3 and peak current = 200 A	≤ 3%

- Overloads : Frequency derating beyond 1 kHz :

$$I_{\max} \leq 1000 \text{ A} \times \frac{1}{f \text{ (kHz)}}$$





■ MAINTENANCE AND CALIBRATION OF CAPTORS

- Clean with a sponge moistened with soapy water and rinse in the same way with clean water, then dry it quickly.
- Keep the jaw gaps of the clamps (MN93A, MN93, C193 and PAC 93) perfectly clean using a cloth; slightly oil the visible metal parts to avoid rust.
- Check the calibration every 2 years.

7. MAINTENANCE

 For maintenance, use only specified spare parts. The manufacturer will not be held responsible for any accident occurring following a repair done other than by its After Sales Service or approved repairers.

7.1 Recharging the battery

-  The instrument's batteries are charged when it is connected to the AC mains supply.
-  **For safety and trouble-free operation of the charger, the battery must be changed when de-energised with the equipment turned off and there must be a delay of at least one minute without the battery being connected.**
-  **Do not dispose of the battery on a fire.**
-  **Do not expose the battery to heat exceeding 100°C.**
- Do not short circuit the battery terminals.**

7.2 Cleaning the housing

- Clean the unit with a cloth and a little soapy water. Clean off with a damp cloth.
-  **Do not use solvents.**

7.3 Metrological check

-  **Like all measuring or testing devices, the instrument must be checked regularly.**
- This instrument should be checked at least once a year. For checks and calibrations, contact one of our accredited metrology laboratories (information and contact details available on request), at our Chauvin Arnoux subsidiary or the branch in your country.

7.4 Repairs

For all repairs before or after expiry of warranty, please return the device to your distributor.

8. TO ORDER

■ **Power Quality Analyser :**

C	A	8	3	3	2
C	A	8	3	3	4

 B

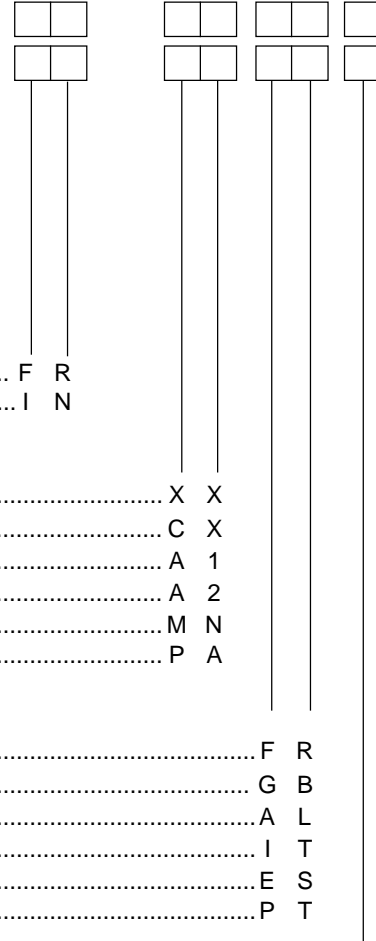

Instrument comes complete (as per grill) with:

- 1 QualiStarView software
- 1 DB9F standard optical lead
- 4 x 3m leads fitted with banana plugs
- 4 crocodile clips
- 1 mains lead
- and these operating instructions

■ **Versions**

French F R
International I N

■ **Current sensors in a shoulder bag**

None X X
Set of 3 x C 193 clamps (1000 A - Ø 52 mm) C X
Set of 3 x Amp**FLEX** A 193 (3000 A - Ø 140 mm / 450 mm long) A 1
Set of 3 x Amp**FLEX** A 193 (3000 A - Ø 250 mm / 800 mm long) A 2
Set of 3 x MN 93A clamps (100 A - 5 A - Ø 20 mm) M N
Set of 3 x PAC 93 clamps (1400 A - Ø 42 mm) P A

■ **Languages of operating instructions**

French F R
English (by default) G B
German A L
Italian I T
Spanish E S
Portuguese P T

■ **Mains lead 2P**

French, German or Spanish (by default) F
English G
Italian I
Swiss C

Or:

Power Quality Analyser C.A 8332-F with MN clamp P01160501B
Power Quality Analyser C.A 8334-F with MN clamp P01160601B
Power Quality Analyser C.A 8332-F with Amp**FLEX** P01160502A
Power Quality Analyser C.A 8334-F with Amp**FLEX** P01160602A
Power Quality Analyser C.A 8332-Int with MN clamp P01160503B
Power Quality Analyser C.A 8334-Int with MN clamp P01160603B
Power Quality Analyser C.A 8332-Int with Amp**FLEX** P01160504A
Power Quality Analyser C.A 8334-Int with Amp**FLEX** P01160604A

■ **Accessories**

Set of 3 x C 193-F clamps P01120327B
Set of 3 x MN 93A-F clamps P01120431B
Set of 3 Amp**FLEX** A193 - F Ø 450 mm P01120535B
Set of 3 Amp**FLEX** A193 - F Ø 800 mm P01120536B
Set of 3 x PAC 93-F clamps P01120076B
Set of 3 x C 193-Int clamps P01120321B
Set of 3 x MN 93A-Int clamps P01120432B
Set of 3 Amp**FLEX** A 193 - Int Ø 450 mm P01120523B
Set of 3 Amp**FLEX** A 193 - Int Ø 800 mm P01120524B
Set of 3 x PAC 93-Int clamps P01120077B
5A C.A 833x adaptor unit P01101959
5A C.A 833x segura adaptor unit P01101990
Shoulder bag for N°6 cable P01298051
Shoulder bag for instrument N°21 P01298055

■ Spare parts

4 Leads with banana plug RD + BL + GN + YE	P01295191
4 Leads with banana plugs RG + NR + BL + BC	P01295133
Crocodile clips RD + BL + GN + YE	P01101962
Crocodile clips RG + NR + BL + BC + VJ	P01101849A
Carrying bag N°22	P01298056
C.A 833x strap	P01298057
C 193 RD clamp	P01120322B
C 193 BK clamp	P01120323B
C 193 GN clamp	P01120324B
C 193 YE clamp	P01120325B
C 193 BL clamp	P01120326B
MN 93A RD clamp	P01120433B
MN 93A BK clamp	P01120434B
MN 93A GN clamp	P01120435B
MN 93A YE clamp	P01120436B
MN 93A BL clamp	P01120437B
MN 93 RD clamp	P01120424B
MN 93 BK clamp	P01120425B
MN 93 GN clamp	P01120426B
MN 93 YE clamp	P01120427B
MN 93 BL clamp	P01120428B
PAC 93 RD clamp	P01120078B
PAC 93 BK clamp	P01120079B
PAC 93 GN clamp	P01120080B
PAC 93 YE clamp	P01120081B
PAC 93 BL clamp	P01120082B
Amp FLEX A193 Ø 450 mm RD	P01120525B
Amp FLEX A193 Ø 450 mm BK	P01120526B
Amp FLEX A193 Ø 450 mm GN	P01120527B
Amp FLEX A193 Ø 450 mm YE	P01120528B
Amp FLEX A193 Ø 450 mm BL	P01120529B
Amp FLEX A193 Ø 800 mm RD	P01120530B
Amp FLEX A193 Ø 800 mm BK	P01120531B
Amp FLEX A193 Ø 800 mm GN	P01120532B
Amp FLEX A193 Ø 800 mm YE	P01120533B
Amp FLEX A193 Ø 800 mm BL	P01120534B
RS232 DB9F optical lead	P01295190
Ni-MH 4 Ah battery pack	P01296024
2P EUR mains lead	P01295174
Printer DPU 414 - SEIKO	P01102903A

9. APPENDIX

9.1 Front view of the instrument



9.2 Mathematical formulae used to compute the various parameters

■ Half-period voltage and current RMS values

$$V_{dem} [i] = \sqrt{\frac{1}{NechDemPer} \cdot \sum_{n: \text{Zéro}}^{\text{Zéro suivant}} V[i] [n]^2} \quad \text{Single rms voltage half-period } i + 1 \text{ phase}$$

$$U_{dem} [i] = \sqrt{\frac{1}{NechDemPer} \cdot \sum_{n: \text{Zéro}}^{\text{Zéro suivant}} U[i] [n]^2} \quad \text{Compound rms voltage half-period } i + 1 \text{ phase}$$

$$A_{dem} [i] = \sqrt{\frac{1}{NechDemPer} \cdot \sum_{n: \text{Zéro}}^{\text{Zéro suivant}} A[i] [n]^2} \quad \text{Rms current half-period } i + 1 \text{ phase}$$

NechDemPer : number of samples in the "lobe" in question (between two consecutive zeros)
n : sample (0; 255) i : phase (0; 1; 2)

■ Min / max values for voltage and current

$$V_{max} [i] = \max (V_{dem} [i]), V_{min} [i] = \min (V_{dem} [i]),$$

$$U_{max} [i] = \max (U_{dem} [i]), U_{min} [i] = \min (U_{dem} [i]),$$

$$A_{max} [i] = \max (A_{dem} [i]), A_{min} [i] = \min (A_{dem} [i]), \text{ (Avg calculation over 1 s : cf "1s rms values...")}$$

■ Peak values for voltage and current (updated on each waveform refresh)

$$V_{pp} [i] = \max (V [i] [n]), V_{pm} [i] = \min (V [i] [n]) \quad n \in [0 \dots NECHPER-1]$$

$$U_{pp} [i] = \max (U [i] [n]), U_{pm} [i] = \min (U [i] [n]) \quad n \in [0 \dots NECHPER-1]$$

$$A_{pp} [i] = \max (A [i] [n]), A_{pm} [i] = \min (A [i] [n]) \quad n \in [0 \dots NECHPER-1]$$

■ Peak factors for current and voltage.

$$V_{cf} [i] = \frac{\max (V_{pp} [i], V_{pm} [i])}{\sqrt{\frac{1}{NECHPER} \cdot \sum_{n=0}^{NECHPER-1} V[i] [n]^2}} \quad \text{Peak factor single voltage } i + 1 \text{ phase}$$

$$U_{cf} [i] = \frac{\max (U_{pp} [i], U_{pm} [i])}{\sqrt{\frac{1}{NECHPER} \cdot \sum_{n=0}^{NECHPER-1} U[i] [n]^2}} \quad \text{Peak factor phase-phase voltage } i + 1 \text{ phase}$$

$$A_{cf} [i] = \frac{\max (A_{pp} [i], A_{pm} [i])}{\sqrt{\frac{1}{NECHPER} \cdot \sum_{n=0}^{NECHPER-1} A[i] [n]^2}} \quad \text{Peak factor current } i + 1 \text{ phase}$$

■ 1 sec RMS values for voltage and current

$$V_{rms} [i] = \sqrt{\frac{1}{NechSec} \times \sum_{n: \text{Zéro}}^{NechSec-1} V[i] [n]^2} \quad \text{Single rms voltage } i + 1 \text{ phase; } V_{avg} [i] = V_{rms} [i]$$

$$U_{rms} [i] = \sqrt{\frac{1}{NechSec} \times \sum_{n: \text{Zéro}}^{NechSec-1} U[i] [n]^2} \quad \text{Compound rms voltage } i + 1 \text{ phase; } U_{avg} [i] = U_{rms} [i]$$

$$\text{Arms} [i] = \sqrt{\frac{1}{\text{NechSec}} \times \sum_{n: \text{Zéro}}^{\text{NechSec} - 1} A[i] [n]^2} \quad \text{Effective current phase } i + 1; \text{Aavg} [i] = \text{Arms} [i]$$

$$\text{Arms} [3] = \sqrt{\frac{1}{\text{NechSec}} \times \sum_{n: \text{Zéro}}^{\text{NechSec} - 1} (A[0] [n] + A[1] [n] + A[2] [n])^2} \quad \text{Neutral rms current; Aavg} [3] = \text{Arms} [3]$$

■ Voltage and current unbalance

$$V_+ = \frac{1}{3} (VF [0] + a \cdot VF [1] + a^2 \cdot VF [2]) \quad \text{Direct voltage (complex notation } a = e^{j \frac{2\pi}{3}})$$

$$V_- = \frac{1}{3} (VF [0] + a^2 \cdot VF [1] + a \cdot VF [2]) \quad \text{Reverse voltage}$$

$$V_{unb} = \frac{|V_{rms_}|}{|V_{rms_+}|}, \quad A_{unb} = \frac{|Arms_|}{|Arms_+|}$$

■ Calculation of the total harmonic distortion factor (THD)

$$V_{thd} [i] = \frac{\sqrt{\sum_{n=2}^{50} V_{harm} [i] [n]^2}}{V_{harm} [i] [1]}, \quad U_{thd} [i] = \frac{\sqrt{\sum_{n=2}^{50} U_{harm} [i] [n]^2}}{U_{harm} [i] [1]}, \quad A_{thd} [i] = \frac{\sqrt{\sum_{n=2}^{50} A_{harm} [i] [n]^2}}{A_{harm} [i] [1]}$$

i : phase (0; 1; 2) n : rang (2...50)

■ Calculation of harmonic bins (see p 11 FT/2)

By FFT (16 bits) 1024 samples on 4 cycles without windowing (CEI 1000-4-7). From real and imaginary parts, each bin ratio is calculated on each phase $V_{harm}[3][51]$, $U_{harm}[3][51]$ and $A_{harm}[3][51]$ in proportion to the fundamental value and the phase angles $V_{ph}[3][51]$, $U_{ph}[3][51]$ et $A_{ph}[3][51]$ between each bin and the fundamental.

This calculation is done with the following principle:

$$\text{module in \% : } \text{mod}_k = \frac{C_k}{C_1} \times 100 \quad \text{angle in degree: } \varphi_k = \arctan \left(\frac{a_k}{b_1} \right)$$

$$\text{with } \begin{cases} c_k = |b_k + ja_k| = \sqrt{a_k^2 + b_k^2} \\ b_k = \frac{1}{512} \sum_{s=0}^{1024} F_s \times \sin \left(\frac{k\pi}{512} s + \varphi_k \right) \\ a_k = \frac{1}{512} \sum_{s=0}^{1024} F_s \times \cos \left(\frac{k\pi}{512} s + \varphi_k \right) \\ c_0 = \frac{1}{1024} \sum_{s=0}^{1024} F_s \end{cases}$$

c_k is the amplitude of frequency component $f_k = \frac{k}{4} f_1$

F_s sampled signal

c_0 is the DC component

k is the ordinal number (spectral bin)

Multiplying the voltage harmonic factor with the current harmonics factor gives the power harmonic factor. Differentiating voltage harmonic phase angle with current harmonic phase angle gives power harmonic phase angle.

VAharm[3][51], VAph[3][51]

Nota : Available only for C.A 8334B

■ Distortion factor calculation (DF)

Two global values giving the relative quantity of harmonics are computed: the THD in proportion to the fundamental and the DF in proportion to the RMS value.

$$Vdf [i] = \frac{\sqrt{\sum_{n=2}^{50} Vharm[i] [n]^2}}{Vrms [i]}, \quad Udf [i] = \frac{\sqrt{\sum_{n=2}^{50} Uharm[i] [n]^2}}{Urms [i]}, \quad Adf [i] = \frac{\sqrt{\sum_{n=2}^{50} Aharm[i] [n]^2}}{Arms [i]}$$

■ K factor

$$Akf [i] = \frac{\sum_{n=1}^{n=50} n^2 \cdot Aharm [i] [n]^2}{\sum_{n=1}^{n=50} Aharm [i] [n]^2} \quad \text{K factor for the } i + 1 \text{ phase}$$

■ Different power levels 1 sec

$$W [i] = \frac{1}{NechSec} \cdot \sum_{n=0}^{NechSec-1} V[i] [n] \cdot A [i] [n] \quad \text{Active power } i + 1 \text{ phase}$$

$$VA [i] = Vrms [i] \cdot Arms [i] \quad \text{Apparent power } i + 1 \text{ phase}$$

$$VAR [i] = \frac{1}{NechSec} \cdot \sum_{n=0}^{NechSec-1} VF[i] [n - NECHPER / 4] \cdot AF [i] [n] \quad \text{Reactive power } i + 1 \text{ phase}$$

$$\text{ou } VAR [i] = \sqrt{VA [i]^2 - W [i]^2} \quad \text{if computation method with harmonics}$$

$W [3] = W [0] + W [1] + W [2]$	Total active power
$VA [3] = VA [0] + VA [1] + VA [2]$	Total apparent power
$VAR [3] = VAR [0] + VAR [1] + VAR [2]$	Total reactive power

■ Various ratios

$$PF [i] = \frac{W [i]}{VA [i]} \quad i + 1 \text{ phase power factor}$$

$$DPF [i] = \cos (\phi [i]) \quad i + 1 \text{ phase displacement factor}$$

$$\tan [i] = \tan (\phi [i]) \quad i + 1 \text{ phase tangent}$$

$$\cos (\phi [i]) = \frac{\sum_{n=0}^{NechSec-1} VF[i] [n] \cdot AF[i] [n]}{\sqrt{\sum_{n=0}^{NechSec-1} VF[i] [n]^2} \cdot \sqrt{\sum_{n=0}^{NechSec-1} AF[i] [n]^2}} \quad \text{Cosine angle between voltage fundamental and } i + 1 \text{ phase current}$$

$$PF [3] = \frac{PF [0] + PF [1] + PF [2]}{3} \quad \text{Total power factor}$$

$$DPF [3] = \frac{DPF [0] + DPF [1] + DPF [2]}{3} \quad \text{Total shift factor}$$

$$\text{Tan } [3] = \frac{\text{Tan } [0] + \text{Tan } [1] + \text{Tan } [2]}{3} \quad \text{Total tangent}$$

■ Various types of energy

1st case : consumed energies ($W[i] \geq 0$)

$$Wh [0] [i] = \sum_{Tint} \frac{W [i]}{3600} \quad \text{Active energy consumed } i + 1 \text{ phase}$$

$$VAh [0] [i] = \sum_{Tint} \frac{VA [i]}{3600} \quad \text{Apparent energy consumed } i + 1 \text{ phase}$$

$$VARhL [0] [i] = \sum_{Tint} \frac{VAR [i]}{3600} \quad \text{for } VAR [i] > \text{ or } = \text{ to } 0 \quad \text{Reactive inductive energy consumed } i + 1 \text{ phase}$$

$$VARhC [0] [i] = \sum_{Tint} \frac{-VAR [i]}{3600} \quad \text{for } VAR [i] < \text{ or } = \text{ to } 0 \quad \text{Reactive capacitive energy consumed } i + 1 \text{ phase}$$

Total active energy consumed

$$Wh [0] [3] = Wh [0] [0] + Wh [0] [1] + Wh [0] [2]$$

Total apparent energy consumed

$$VAh [0] [3] = VAh [0] [0] + VAh [0] [1] + VAh [0] [2]$$

Total reactive capacitive energy consumed

$$VARhC [0] [3] = VARhC [0] [0] + VARhC [0] [1] + VARhC [0] [2]$$

Total reactive inductive energy consumed

$$VARhL [0] [3] = VARhL [0] [0] + VARhL [0] [1] + VARhL [0] [2]$$

2nd case : generated energies ($W[i] \geq 0$)

$$Wh [1] [i] = \sum_{Tint} \frac{W [i]}{3600} \quad \text{Active energy generated } i + 1 \text{ phase}$$

$$VAh [1] [i] = \sum_{Tint} \frac{VA [i]}{3600} \quad \text{Apparent energy generated phase } i + 1$$

$$VARhL [1] [i] = \sum_{Tint} \frac{-VAR [i]}{3600} \quad \text{for } VAR [i] < \text{ or } = \text{ to } 0 \quad \text{Reactive inductive energy generated phase } i + 1$$

$$VARhC [1] [i] = \sum_{Tint} \frac{VAR [i]}{3600} \quad \text{for } VAR [i] > \text{ or } = \text{ to } 0 \quad \text{Reactive capacitive energy generated phase } i + 1 \text{ phase}$$

Total active energy generated

$$Wh[1][3] = Wh[1][0] + Wh[1][1] + Wh[1][2]$$

Total apparent energy generated

$$VAh[1][3] = VAh[1][0] + VAh[1][1] + VAh[1][2]$$

Total reactive capacitive energy generated

$$VARhC[1][3] = VARhC[1][0] + VARhC[1][1] + VARhC[1][2]$$

Total reactive inductive energy generated

$$VARhL[1][3] = VARhL[1][0] + VARhL[1][1] + VARhL[1][2]$$

■ **Hysteresis**

Hysteresis is a filter principle often used after threshold detection stage. A correct setting of hysteresis value avoid repeated state changing when the measure is varying close to the threshold.

The event detection is activate when the measure is going over the threshold but it can only be deactivated if the measure goes under the threshold minus the value of the hysteresis.

The default hysteresis value is 2% of the reference voltage but it may be set in the range of [1%, 5%] depending of the voltage stability on the network.

- **Swell detection**

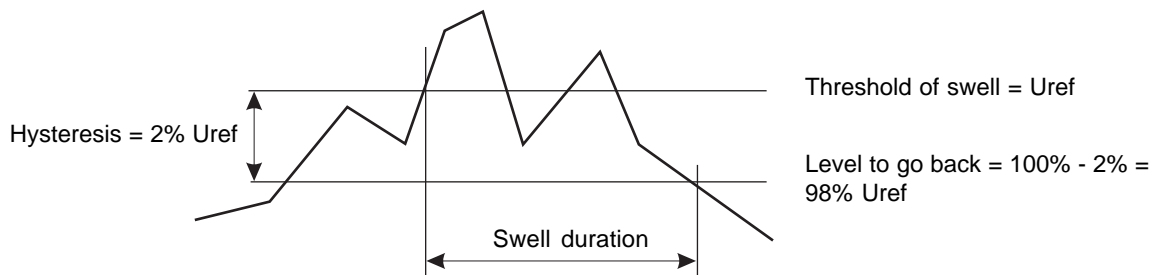

- Sag or interruption detection

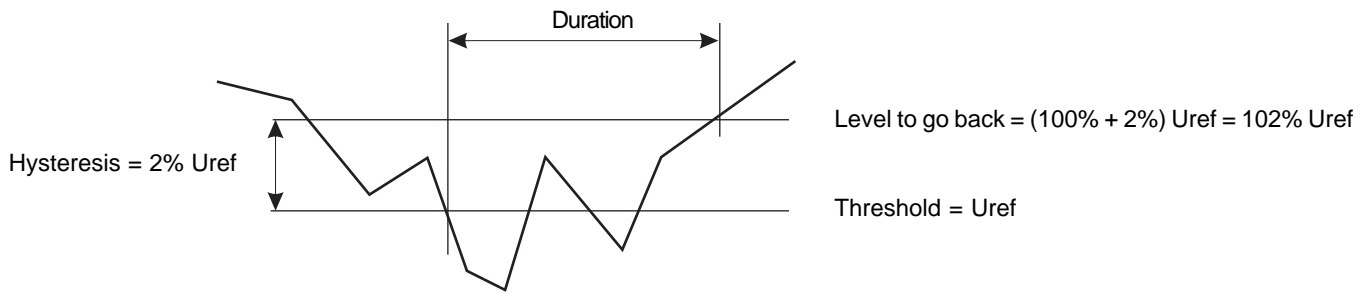

Minimum scale values (in waveform mode) and minimum displayed values.

Current sensor type	Minimum displayed current value[A]	Minimum current scale value [A]
AmpFLEX 3000A	9	60
1000A PAC clamp	1	10
1000A C clamp	0,5	10
200A MN 93 clamp	0,5	2
100A MN 93A clamp	0,2	1
5A MN 93A clamp	$(\text{Primary} \times 5) \div (\text{Secondary} \times 1000)$	$(\text{Primary} \times 5 \times 10) \div (\text{Secondary} \times 1000)$
5AAdaptor	$(\text{Primary} \times 5) \div (\text{Secondary} \times 1000)$	$(\text{Primary} \times 5 \times 10) \div (\text{Secondary} \times 1000)$

For all types of current sensors :

$$A_{RMS} \leq [\text{Minimum value of displayed current}] \Rightarrow A_{RMS} = 0$$

For the MN93A clamp (rating 5A) and adaptor 5A :

- **Primary** ∈ [1 ; 2999]
- **Secondary** ∈ {1 ; 5}

$$[\text{Minimum displayed current value}] \leq 0,2 \Rightarrow [\text{Minimum displayed current value}] = 0,2$$

$$[\text{Minimum current scale value}] \leq 1 \Rightarrow [\text{Minimum current scale value}] = 1$$

The minimum displayed voltage value is 5V

$$V_{RMS} \leq 5V \Rightarrow V_{RMS} = 0$$

$$U_{RMS} \leq 5V \Rightarrow U_{RMS} = 0$$

9.3 Setup DPU 414 printer

To setup the DPU414 printer, press ON and On Line at the same time.

Continue ? : Push 'On-line SW'
Write ? : Push 'Paper feed SW'

DIP SW-1

- 1 (OFF) : Input = Serial
- 2 (ON) : Printing Speed = High
- 3 (ON) : Auto Loading = ON
- 4 (OFF) : Auto LF = OFF
- 5 (ON) : Setting Command = Enable
- 6 (OFF) : Printing
- 7 (ON) : Density
- 8 (ON) : = 100 %

Continue ? : Push 'On-line SW'
Write ? : Push 'Paper feed SW'

DIP SW-2

- 1 (ON) : Printing Columns = 40
- 2 (ON) : User Font Back-up = ON
- 3 (ON) : Character Select = Normal
- 4 (ON) : Zero = Normal
- 5 (ON) : International
- 6 (OFF) / Character
- 7 (ON) : Set
- 8 (ON) : = France

Continue ? : Push 'On-line SW'
Write ? : Push 'Paper feed SW'

DIP SW-3

- 1 (ON) : Data Length = 8 bits
- 2 (ON) : Parity Setting = No
- 3 (OFF) : Parity Condition = Even
- 4 (ON) : Busy Control = H/W Busy
- 5 (OFF) : Baud
- 6 (ON) : Rate
- 7 (ON) : Select
- 8 (OFF) : = 19200 bps

Continue ? : Push 'On-line SW'
Write ? : Push 'Paper feed SW'

DIP SW setting complete !!



03 - 2011
Code 689142E01 - Ed 5

DEUTSCHLAND - Chauvin Arnoux GmbH
Straßburger Str. 34 - 77694 Kehl / Rhein
Tel: (07851) 99 26-0 - Fax: (07851) 99 26-60

ESPAÑA - Chauvin Arnoux Ibérica SA
C/ Roger de Flor N° 293, Planta 1
08025 Barcelona
Tel: +34 902 20 22 26 - Fax: +34 934 59 14 43

ITALIA - Amra SpA
Via Sant'Ambrogio, 23/25 - 20050 Bareggia di Macherio (MI)
Tel: 039 245 75 45 - Fax: 039 481 561

ÖSTERREICH - Chauvin Arnoux Ges.m.b.H
Slamastrasse 29/2/4 - 1230 Wien
Tel: +43 1 61 61 961 - Fax: +43 1 61 61 961-61

SCANDINAVIA - CA Mätsystem AB
Box 4501 - SE 18304 TÄBY
Tel: +46 8 50 52 68 00 - Fax: +46 8 50 52 68 10

SCHWEIZ - Chauvin Arnoux AG
Moosacherstrass 15 - 8804 AU / ZH
Tel: +41 44 727 75 55 - Fax: +41 44 727 75 56

UNITED KINGDOM - Chauvin Arnoux Ltd
Unit 1 Nelson Court - Flagship Square-Shaw Cross Business Park
DEWSBURY - West Yorkshire - WF12 7TH
Tel: +44 1924 460 494 - Fax: +44 1924 455 328

MIDDLE EAST - Chauvin Arnoux Middle East
P.O. BOX 60-154 - 1241 2020 JAL EL DIB (Beirut) - LEBANON
Tel: +961 1 890 425 - Fax: +961 1 890 424

CHINA - Shanghai Pu-Jiang - Enerdis Instruments Co. Ltd
3 F, 3 rd Building - N° 381 Xiang De Road - 200081 SHANGHAI
Tel: +86 21 65 21 51 96 - Fax: +86 21 65 21 61 07

USA - Chauvin Arnoux Inc - d.b.a AEMC Instruments
200 Foxborough Blvd. - Foxborough - MA 02035
Tel: +1 (508) 698-2115 - Fax: +1 (508) 698-2118

www.chauvin-arnoux.com

190, rue Championnet - 75876 PARIS Cedex 18 - FRANCE
Tél.: +33 1 44 85 44 85 - Fax : +33 1 46 27 73 89 - info@chauvin-arnoux.fr
Export : Tél. : +33 1 44 85 44 86 - Fax : +33 1 46 27 95 59 - export@chauvin-arnoux.fr