

USER' S MANUAL

Contents

Prior To Use	1
Congratulations	1
Safety Precautions	1
Unpacking	3
Phone Layout and Keys Function	4
Keys Description	7
LCD Window Icons Description	9
Installing Batteries	10
Installation Instruction	12
Charging Handset	14
Turning Handset On/Off	15

<i>Part One: Cordless Phone</i>	16
Basic Functions	16
Making a call	16
Receiving a call	17
Muting the Microphone	18
Adjusting Audio Volume	18
Ringer Setting	19
Last Number Redial	20
CID Book	22
Key Lock	24
Selecting a Language	24
HS Name	25
Auto Answer	25
Paging	26
Dial Mode	26
Handsfree	27
Flash Signal	27

Contents

Advanced Functions	28
Menu Navigation	28
Menu Map	29
Phone Book	30
BS Settings	33
HS Settings	35
Registration	39
Calling with more than one Handset	40
Caller ID on call waiting	42

Part Two: Wireless Doorbell **43**

Feature List	46
Troubleshooting	47

Technical Specifications	48
About the Noise Filter	49



If you subscribe to a DSL service

Please attach a noise filter (contact your DSL provider) to the telephone line between the base unit and the telephone line jack in the event of the following:

- Noise is heard during conversations.
- Caller ID features do not function properly.

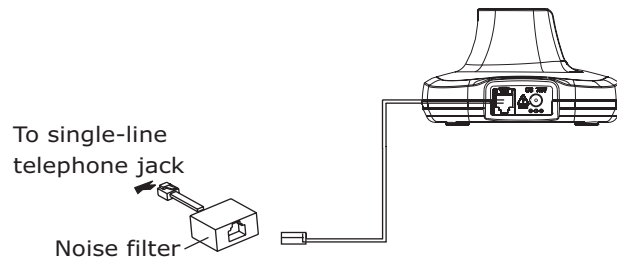

Technical Specifications

Frequency Range	1.88~1.90GHz
Channels	120 Duplex channels
Carrier Power	<250mW
Modulation	GFSK
Frequency Stability	< \pm 50 KHz
Charging time	15 hours
Ambient temperature	Normal: 15°C ~ 35°C, Extreme: 0°C ~ 40°C
Humidity	0%~90%
Dimensions (mm)	Indoor phone: (Base): 132.1 x 132.1 x 68.5; (Handset): 159.3 x 48.4 x 28.9; Outdoor station: 176.5 x 60 x 34
Power Supply	Indoor phone (Base) input: 7.5V, 300mA; (Handset) input: Ni-MH 1.2V x 2, 600mAh Outdoor station input: 2 C size alkaline batteries

 **Design and specifications are subject to change without notice.**

Prior To Use

■ Congratulations

on purchasing our high quality product.

Please read the manual carefully before installing your system and follow all of the directions to ensure proper installation.

■ Safety Precautions

To reduce the risk of electrical shock and injury, please follow these basic safety precautions before using the phone.

1. Carefully read and observe the instructions in this manual.
2. Follow all warnings marked on the unit.
3. When cleaning, unplug the phone first, then use a damp cloth to wipe. Do not use liquid or aerosol cleaners.
4. Do not place objects on the line cord that may cause damage.
5. Do not use this phone in wet surroundings or environments where there is a risk of explosion.
6. Avoid spilling of any liquid on the phone.

7. Unplug this phone from the wall outlet and refer servicing to qualified service personnel only.
8. Pay attention to the polarity of the batteries, insert the rechargeable batteries in accordance with polarity symbols (this instruction is found in the installing batteries section.)
9. Use only **the batteries indicated in the User's Manual**. Never use other ordinary batteries or conventional alkaline batteries. Otherwise this may not only cause personal injuries but also damage to the unit.
10. Do not mix exhausted batteries with full batteries. Exhausted batteries shall not be disposed of with the usual household waste or in a fire.
11. If you are sure you will not be going to use the handset over a month, please take out the batteries from the battery compartment.
12. Use only **the power supply indicated in the User's Manual**.
13. Keep the phone out of the reach of children.
14. Use the phone only in the described manner.
15. Stop using the phone if it becomes damaged.

Troubleshooting

Symptom	Check & Remedy
No operation	<ul style="list-style-type: none"> • Check that the power adapter is properly connected. • Check that the telephone line cord is properly connected. • Check that the handset batteries in full power. • Check that the handset batteries are installed properly.
No dial tone	<ul style="list-style-type: none"> • Check that the telephone line cord is properly connected. • Check that the power adapter is properly connected.
Nothing appears on the display	<ul style="list-style-type: none"> • Check that the handset batteries are installed properly. • Check that the handset batteries in full power. • Check that the handset is on.
Handset seems to have very short battery life	<ul style="list-style-type: none"> • Check the charge contacts. • Consistently short battery life may indicate that replacement of the batteries is necessary. • Make sure the right batteries be used.
Caller's number is not displayed	<ul style="list-style-type: none"> • Make sure you have subscribed to a Caller ID service via your network provider. • The caller may have withheld their details. • Let the phone ring a couple of times as there may be a delay in receiving the Caller ID information.

Feature List

Indoor phone

- 1.8GHz DECT technology with GAP
- Up to 5 handsets for optional for one base
- Up to 4 bases for optional for one handset
- Phonebook with up to 50 entries
- 9 VIP ring tones setting for phonebook entries
- Redial book with up to 10 entries
- 10 ring tones and volume selectable (5 levels+off)
- Key tone ON/OFF selectable
- Full handsfree speakerphone
- Internal call
- Call transfer
- 3-way conference call
- Receiver/Speaker volume adjustable (5 levels)
- PIN protection
- Predialing
- Redial, Flash, Pause, Mute
- TONE/PULSE dialing mode selectable
- FLASH time selectable

- Call duration display
- Real time clock (set time)
- Keypad lock
- 13 languages selectable
- Auto answer ON/OFF selectable
- Alarm clock include snooze option
- Handset Name setting
- LCD backlight

Caller ID

- FSK and DTMF dual system Caller ID
- Caller ID / Call Waiting
- Caller ID list with up to 40 entries
- Incoming calls can be called back/added to phonebook/deleted

Outdoor station

- Compatible with audio indoor phone
- Calling indoor phone and setting up a conversation
- Unlocking (optional)

Unpacking

Once you have unpacked your door phone, make sure that all the parts shown below are available. If any pieces are missing or broken, please promptly call your dealer.

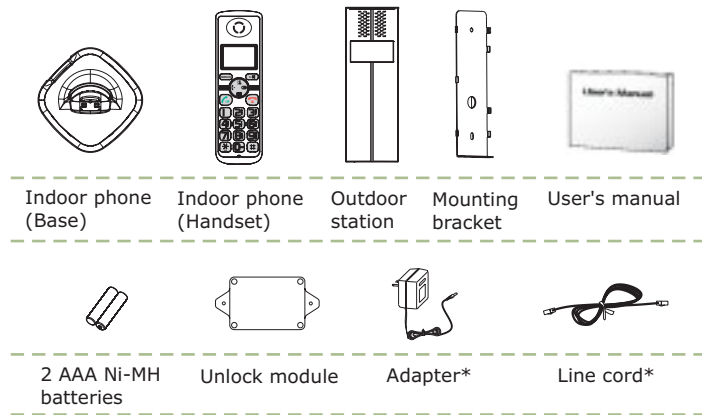

*The shape of the plugs can vary according to each country's specification.

Phone Layout and Keys Function

Indoor phone (Handset)

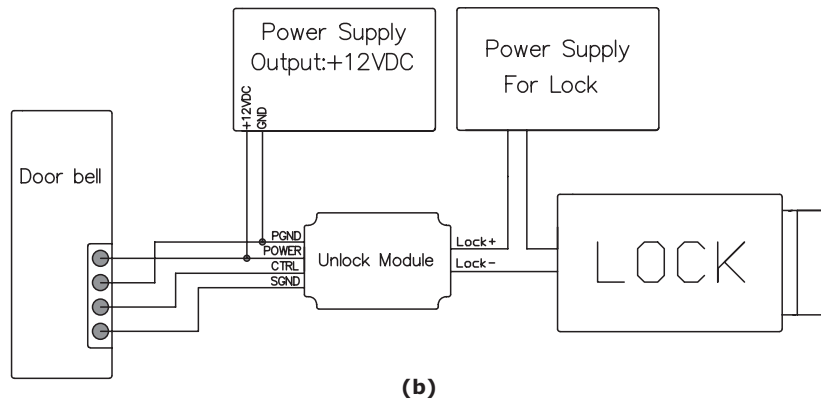
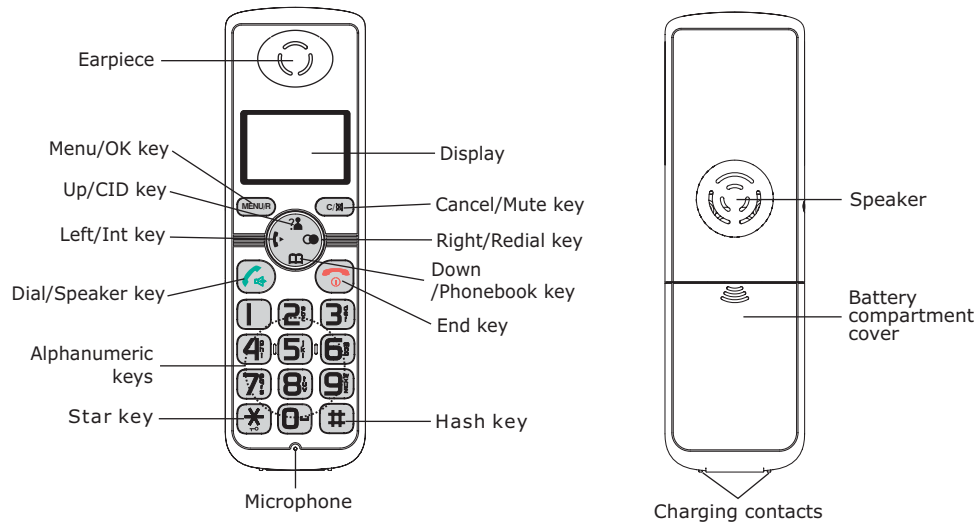



Notes:

- The conversation can be up to 2 minutes. After 2 minutes, the line will be disconnected automatically.
- The ring will continue for about a minute if the indoor handset does not respond with it.

2. To call

When the visitor presses the **Call** button on the outdoor station, the internal ring will sound to indicate the host. If the called handset is on an external line, the handset user will hear prompt tones, which allows he/she to hang up and wait for the ring to sound again.

3. Talking

The host can press the  key on the handset to talk with the visitor. Press the  key to complete the conversation.

4. Unlocking (optional)

During the conversation, the host can press and hold the # key to unlock the door.

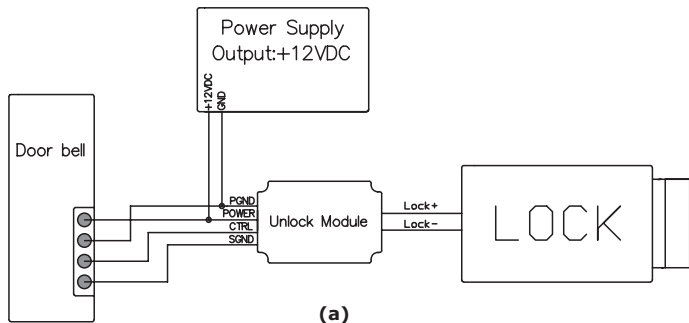

Phone Layout and Keys Function (continued)

Indoor phone (Base)

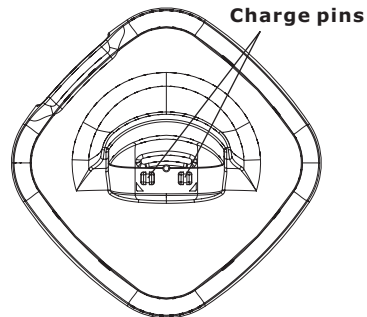

Rear and bottom View

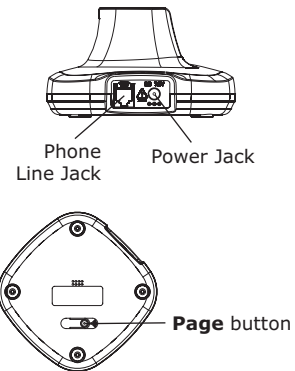

■ Phone Layout and Keys Function (continued)

Outdoor station

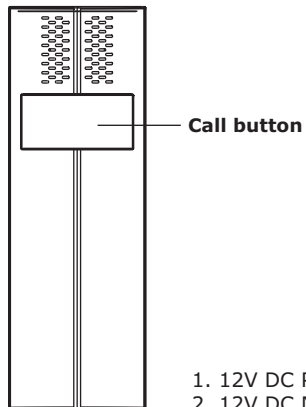

1. 12V DC Positive input
2. 12V DC Negative input
3. Unlock control positive terminal
4. Unlock control negative terminal
5. Silica gel plug

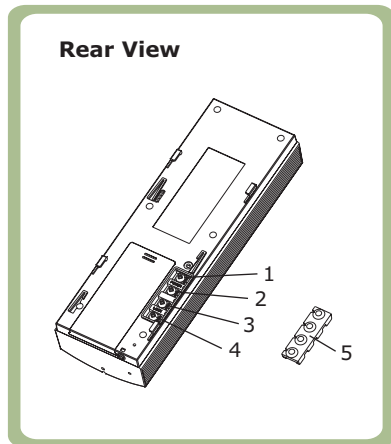

Part Two: Wireless Doorbell

1. To register

Before using the outdoor station, you should first register it to the base unit. First, you should hold the  key on the bottom of the base for 5 seconds or longer then release it. Second, please press the **Call** button of the outdoor bell then hold the **Register** key on the back of the outdoor unit for 5 seconds or longer then release. Please remember to remove the small rubber case which is stuck on the **Register** key of outdoor station. If you still can not register successfully, you can try to turn off the power of the base and remove the batteries from the outdoor unit before you hold the **Register** key then turn on the power, install the batteries and then try again. After you hear a prompt tone, the station has been registered to the base successfully. Please see the figure below for details.

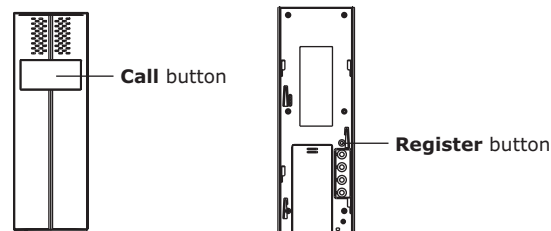

■ Caller ID on call waiting



When you subscribe to Call Waiting service from your local telephone company, the telephone will display the name and number of the second caller while you are having a conversation.

Caller ID info displayed

Caller 1
4361234

Caller two's information is displayed

Caller 1
4
Caller 2
2915678

1. When you are on the line, the telephone will automatically display the name and number of the second caller.
2. Press the  key to answer the second caller.
3. When you have finished, press the  key to continue with your conversation with the first caller.

Note:

- *If you have transferred an external call to another handset, you cannot use the call waiting function via the second handset.*

■ Keys Description



Dial/Speaker key

Make/Answer a call.

Activates the speakerphone if pressed during a call.



End/Power key

End a call.

Long press to activate power on/off, as described in page 15.



Navigation key:

Up/CID key

Scroll up through lists and menu options.

Increase the earpiece/speakerphone volume during a call.

Enter the CID book, as described in page 22.

Down/Phonebook key

Scroll down through lists and menu options.

Decrease the earpiece/speakerphone volume during a call.

Enter the Phonebook, as described in page 31.

INT key

Set up an internal call to another handset.

Transfer an incoming call to another handset.

Set up a conference call with an external line and an internal handset.

■ Keys Description (continued)



Redial key

Enter the redial book, as described in page 20.
Insert a pause when pre-dialing a number.



Menu/OK key (left)

Enter the menu functions in standby mode.
Confirm selections & actions.
Performs "Flash" function.



Cancel/Mute key (right)

Return to the previous menu.
Enter to mute during a call.
Delete an incorrect character/digit.







Star key

Press and hold to turn on/off keypad lock function.
Set up a conference call, as described in page 41.

Setting up a 3-way conference call

When you have both an external call and an intercom call in progress, you can set up a three-way conference call, like this:

1. During an external call, press the  key and then input the number of the handset you want to join the 3-way call.
2. The called party press  key to answer.
3. The calling party can press the  key to start the 3-way call.
4. Either of the two internal handsets can press the  key to leave the conference call at any time.

Note:

- *If one of the handsets drops the conference call, the remaining handsets will continue the conference.*



■ Calling with more than one Handset

If you have more than one handset registered to the same base, you can make internal calls and transfer an external call between the registered handsets.

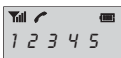

Making an internal call

1. Press the  key, the LCD displays as follows, then input the number of the handset you want to call.





2. If the handset entered is valid, the called handset will ring and display **HSX CALLING**. The handset user can press the  key to answer the internal call.
3. At the end of your conversation, press the  key.

Note:

- During the internal call, if an external call comes in, the LCD will show the caller's number. You should press the  key to end the internal call first then press the  key to answer the call.

Call transfer between handsets

You can transfer an external call between the handsets those are registered to the same base.

1. During an external call, press the  key then input the number of the handset you want to transfer the call to.
2. If the called party can answer your call, he/she can press the  key to talk with you. At this time you can inform him/her of the incoming call.
3. When the called handset answers, press the  key or replace the handset to the base to complete the transfer.

■ LCD Window Icons Description



New Call

Indicates you have missed one or more calls.



Off Hook

Indicates the line is engaged.



Hands-free

Indicates the handsfree function is enabled.



Battery Icon

Indicates battery charge level.



Signal Icon

Indicates whether the current signal exists or not. If the handset is too far from the base, this icon will blink on the LCD.



Keypad Lock

This icon appears when the keypad is locked.

■ Installing Batteries

Indoor phone

The rechargeable Ni-MH batteries (AAA size) come with your phone. Install the battery before using your phone.

1. Slide the battery cover in the direction of the arrow and pull it out.

2. Insert new batteries as indicated, matching correct polarity (+,-).

3. To replace the battery cover, slide the cover up until it snaps in place.

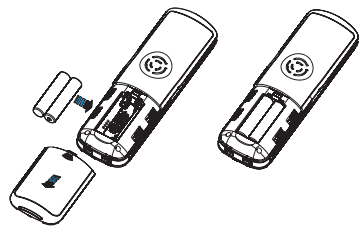









Notes:

- Reversing the orientation may damage the handset.
- The batteries need to be replaced if they do not recover their full storage capacities after recharging.
- When replacing the batteries, always use good quality Ni-MH rechargeable batteries. Never use other batteries or conventional alkaline batteries.

■ Registration

The supplied handset is already registered with the number 1. You can register up to 5 handsets (include an outdoor station) to the same base in order to share the same line with other people.











Before registering a handset to the base, you should press and hold the  key on the bottom of the base for about 5 seconds then release it.

1. Press the  key.
2. Press  or  key repeatedly to choose **REGISTER**, then press the  key.
3. Use  or  key to scroll through the Base names list, press the  key to choose a base to your necessary. The handset will search for the requested base and the relevant information will flash on the LCD.

4. If the base is found, and the handset is successfully registered, you will be prompted to enter the PIN code (the default one is 0000). On validation of the PIN code, the Registration tone will sound and the Base assigns a number to the handset. If the PIN code entered is invalid, a warning tone will sound, and the handset will return to the previous registration state.
5. If the base is not found, the handset will behave according to the Out of Range condition.









Selecting a Base

This function allows you to select a base from those already registered to the handset. You can access the options by scrolling the menu.

1. Press the  key.
2. Press  or  key repeatedly to choose **HS SETTING** menu, then press the  key.
3. Press  or  key to choose the **SELECT BS**, press the  key.
4. You can use  or  key to select the base you want, then press the  key. If you select a non-existent base, the handset will sound a warning tone.
5. The display will show **SELECT BS X**. Press the  key to confirm. A confirm tone will be heard.

HS Reset

This function allows you to reset the handset settings to the factory default.

1. Press the  key.
2. Press  or  key repeatedly to choose **HS SETTING** menu, then press the  key.
3. Press  or  key to choose the **HS DEFAULT** menu, press the  key. You will be prompted to enter the PIN code.
4. Enter the PIN code (the default one is 0000), then press the  key. If the PIN code is validated all handset settings will return to the factory default, otherwise a warning tone will be heard and the settings will remain.

Result: After resetting, the handset will return to standby mode.

Installing Batteries (continued)

Outdoor station

You can install two C size batteries (not supplied) before using the outdoor station.

1. Slide the battery cover in the direction of the arrow and pull it out.
2. Insert new batteries as indicated, matching correct polarity (+,-).
3. To replace the battery cover, slide the cover up until it snaps in place.

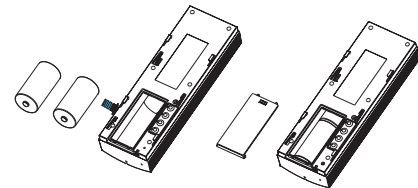

Notes:

- Reversing the orientation may damage the unit.
- When replacing the batteries, always use good quality C size alkaline batteries.
- If you have installed the batteries, you do not need to connect the DC positive input and negative input.

■ Installation Instruction

Indoor phone

1. Connect one end of the phone line cord to the phone line jack of the base, and the other end to a standard phone wall outlet.
2. Connect the modular end of the AC power adapter to the power jack of the base, then plug the AC adapter into a standard AC wall outlet.

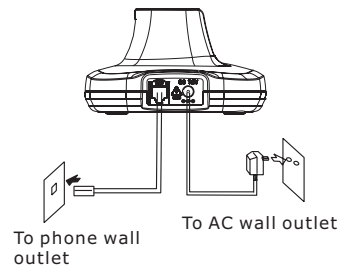

Outdoor station

1. Choose a proper location for the outdoor station. Be sure to consider the average height of visitors.
2. Fix up the iron mounting bracket on the wall, then drill the screws in it.
3. Pull downward outdoor station and finish the installation.
4. If you do not install two batteries, you should connect the DC positive input and negative input. Moreover, if unlocking function is necessary, you also need to connect other two terminals.

Setting Date & Time

1. Date Format

1. Press the key.
2. Press or key repeatedly to choose **HS SETTING** menu, then press the key.
3. Press or key to choose **DATE & TIME**, press the key.
4. Press the key to choose **DATE FORM**.
5. You can use or key to choose the Date format (**DD-MM/MM-DD**), press the key to save.

2. Setting date & time

1. Press the key.
2. Press or key repeatedly to choose **HS SETTING** menu, then press the key.
3. Press or key to choose **DATE & TIME**, press the key.













4. Press or key to choose **SET DATE** or **SET TIME** menu, press the key.
5. Enter the current date or time by numeric keypad and press the key to save and exit.

Note:

- At step 5 you need to enter the time in 24-Hour format.











Audio Setup

You can also use the menu to adjust the audio volume.

1. Press the  key.
2. Press  or  key repeatedly to choose **HS SETTING** menu, then press the  key.
3. Press the  key to choose **AUDIO SETUP**, press the  key.
4. Use  or  key to choose **SPEAKER VOL** or **EARPIECE V**, press  key.
5. The display shows the current setting. Use the  or  key to choose the volume level (VOLUME 1-VOLUME 5), press the  key.

Key Tone

Every time you press a key, your handset acknowledges it with a key tone. You can disable the key tones for a silent use. In certain error conditions, a warning tone will sound when an incorrect key is pressed.

1. Press the  key.
2. Press  or  key repeatedly to choose **HS SETTING** menu, then press the  key.
3. Use  or  key to choose **tone SETUP** menu, press the  key.
4. Press the  key again to choose **KEY TONE**.
5. You can use  or  key to choose **ON** or **OFF** to enable or disable the function.
6. Press the  key.

Note:

- For normal use, we recommend you leave the key tone enabled. This makes the phone easier to use.

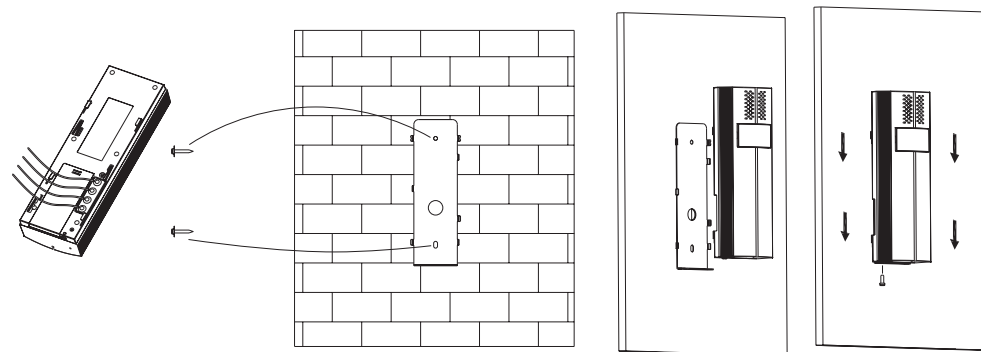

Note:

- The silica gel plug on the rear of the outdoor station is used to prevent the screws from rusting. You should remove this plug before connecting the line. But after the connection, remember to cover it again.

Unlock module (optional)

Connect the wire between the outdoor station and the unlock module, please see the figure on the right.

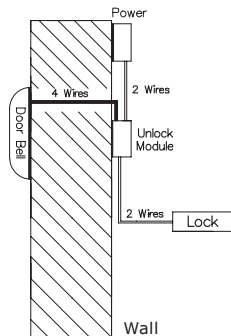

Charging Handset

! Important Note: Before initial operation, **YOU SHOULD FULLY CHARGE THE HANDSET** for about **15 hours**.

To charge the handset, you should place it on the base.

Result: When you place the handset on the base, the handset automatically turns on.

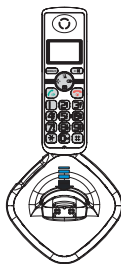

HS Settings

Setting Alarm

You are able to set the alarm on the handset and adjust the alarm settings.

1. Press the **MENU** key.
2. Press **?** or **☐** key repeatedly to choose **HS SETTING** menu, then press the **MENU** key.
3. Press the **MENU** key again to choose **ALARM**.
4. The display shows the current set. Use the **?** or **☐** key to select **ON/OFF**, press the **MENU** key.
5. If you select **ON**, the display indicates you to enter the time in **HH:MM** format.









6. Press the **MENU** key, a beep sounds and the display shows **SNOOZE ON/OFF**, you can press **?** or **☐** key to enable or disable the snooze function on the alarm and press the **MENU** key.
7. When the alarm sounds, press any key to switch it off.

Notes:

- At step 5 you need to enter the time in 24-Hour format.
- If you press any key at the right time the alarm to ring, the alarm will be silent.
- If you choose **SNOOZE ON**, the alarm will ring at regular intervals of 10 minutes.









Modify PIN

This function allows you to change the PIN number of the currently active Base. The default PIN is 0000.

1. Press the  key.
2. Press  or  key repeatedly to choose **BS SETTING** menu, then press the  key.
3. Use  or  key to choose **MODIFY PIN** menu, press the  key.
4. The display shows "**PIN?**" to prompt you to enter the old PIN. If the old PIN code is validated, you will be prompted to enter a new PIN code. If the old PIN is not validated, a warning beep will sound and you will be returned to the **MODIFY PIN** menu.
5. Enter the new PIN, press the  key. You will be requested to confirm the PIN code. Enter the new PIN again then press the  key to confirm and exit.

BS Reset

This function allows you to reset the Base setting to the factory default.

1. Press the  key.
2. Press  or  key repeatedly to choose **BS SETTING** menu, then press the  key.
3. Press  or  key to choose **BS DEFAULT**, press the  key. You will be prompted to enter the PIN code.
4. Enter the PIN code (the default PIN is 0000), then press the  key. If the PIN code is validated all Base settings will be returned to the factory default, otherwise the settings will remain.

Result: After resetting, the handset will return to standby mode.

Turning Handset On/Off

If the handset is in power off mode, when you place the handset on the base, it automatically turns on. To turn the handset on or off in standby mode, follow these steps:

1. To turn on the handset when it's off, press and hold the  key until you switch the display on. On power up, the handset will enter subscription mode and search for a registered base. A message as shown below will be displayed to the user, and the signal icon will flash.



2. To turn off the handset, keep the  key pressed until the display disappears.

If the handset is successful in finding a base, the handset will enter the standby mode, the display will show handset number or the handset name (if you have one saved as described on page 25), signal icon, battery icon and current time. If the handset is unsuccessful in finding a base, the handset will behave according to the Out of Range condition.

Note:

- When battery power is very low, if you place the handset on the base, the display will show as below. **YOU SHOULD FULLY CHARGE THE HANDSET BEFORE USING.**

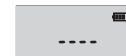



Part One: Cordless Phone

Basic Functions

All descriptions in this manual assume that the handset is in standby mode. Set the telephone to standby mode by pressing the  key.

Making a Call

1. Pick up the handset and press the  key.

Result: The  icon appears on the LCD.

2. Dial a telephone number.
3. To end the call, either press the  key or replace the handset on the base.

Note:

- To make a call to the last number you dialed, use the **Redial** feature. For details, see page 20.

You can enter the desired phone number in standby mode, which allows you to make corrections before dialing. Follow these steps:

1. Enter a telephone number (up to 32 digits). Check it. You can also use the  key to insert a pause.

Note:









- If you make a mistake while entering a number, press the  key to clear the last digit.

2. When the number appears correctly, press the  key.

BS Settings











Terminate HS

This function allows you to delete a handset registration from the base.

1. Press the  key.
2. Press  or  key repeatedly to choose **BS SETTING** menu, then press the  key.
3. Press the  key again to choose **TERMINATE HS**. The display shows "PIN?" to prompt you to enter the PIN Code (The default PIN Code is "0000"). Then press the  key.
4. Use the  or  key to select a handset. If you select the current handset or a non-existent handset, a warning tone will be heard.
5. Press the  key to confirm, and the selected handset will behave according to the unregistered condition.

Flash Time













You can select to change the Flash time by the following steps:

1. Press the  key.
2. Press  or  key repeatedly to choose **BS SETTING** menu, then press the  key.
3. Use  or  key to choose the **FLASH TIME** menu. Press the  key.
4. The display shows the current setting. Use the  or  key to select **SHORT/LONG**, press the  key.















Dialing a Number from Phone book

Find out the number you want to dial. Refer to "Viewing the Phone book Entries". Then press the  key to dial out the number.

Editing the Phone book Entries

1. Press the  key.
2. Press the  key to choose **PHONE BOOK**, press the  key.
3. Press the  key to choose **CHANGE ENTRY** menu, press the  key.
4. Press  or  key repeatedly until the entry you want to edit displays, press the  key to confirm.
5. If necessary, press the  key to clear the digit(s) then enter the desired name and number, press the  key to save.
6. Use  or  key to select the ring you like to associate with the number, press the  key to confirm.

Deleting the Phone book Entries

1. Press the  key.
2. Press the  key to choose **PHONE BOOK**, press the  key.
3. Press  or  key to choose **DELETE ENTRY**. Press the  key.
4. Press  or  key repeatedly until the name you want to delete displays, then press the  key. The display shows "**CONFIRM ?**". You can press the  key to delete it or press the  key to exit.
5. At step 3, if you choose **DELETE ALL** menu and press the  key, the display will show "**CONFIRM ?**". You can press the  key to delete all the entries or press the  key to exit.



PB Status

The PB Status shows the number of phone book entries already stored. When the **PB STATUS** shows on the LCD, press the  key to enter it.

Receiving a Call



When a new call is received, the call information will appear on the LCD.

If the caller can be identified, the caller's phone number is displayed.

1. To answer the call, press the  key. If you have activated the Auto Answer function, when the handset is on the base, simply lift it up to answer.
2. To end the call, either press the  key or replace the handset on the base.

Result: After you hang up, the LCD displays the call duration.

Notes:

- You can select the ringer volume by using  or  key when the phone rings with an incoming call.
- If the polyphonic ring tone is set, the ring tone may continue for 4 seconds after the caller's hang-up or after the parallel phone had answered the call.

Muting the Microphone



During a conversation, you can temporarily switch your phone's microphone off, so that the other party cannot hear you.

Example: You want to say something to another person in the room but do not want the other party to hear you.

To mute your microphone, press the  key during the conversation. The "CALL MUTED" appears on the LCD.









To unmute the microphone, press the  key again. You will restore the normal condition.

Adjusting Audio Volume

During a conversation, you can use the  or  key to adjust the level of the earpiece (or the handsfree speakerphone one, if activated) volume from **VOL1** to **VOL5**. The selected volume will be displayed on the LCD.



You can also select the earpiece volume or the speaker volume by the **AUDIO SETUP** in Menu under **HS SETTING**, as described in page 36.

Adding the Phone book Entries

1. Press the  key.
2. Press the  key to choose **PHONE BOOK**, press the  key.
3. Press  key again to choose **ADD ENTRY**.
4. The display shows "**NAME ?**". Enter the name you want to use, then press the  key to confirm. The display shows "**NUMBER ?**". Enter the desired number (up to 20 digits), press the  key.
- 5.*Use  or  key to select the ring you like to associate with the number, press the  key to confirm.
6. Repeat if necessary.

* If you want to set a VIP number, you should select a special ring tone for it. The ring tone should be different from the external ring you have set. You can set up to 9 VIP ring tones associate with 9 VIP numbers/groups.





Note:

- If you make a mistake while entering a number, use the  key to correct it. Each time you press the key, the last digit is deleted. To clear all digits, press and hold the  key.

Using a Pause

A pause is useful when you access an interactive voice response system, such as an automated banking system. A pause provides a delay of 3 seconds. If you want to insert a pause when you dial a number in standby mode or store a number in memory, press the  key. The letter **P** will appear at the pause entry.

Viewing the Phone book Entries

1. In the standby mode, press the  key.
2. Press  or  key repeatedly until the desired name is displayed.
3. Press the  key to show the relevant number.

■ Phone Book

The phonebook built in your cordless phone allows you to store frequently used numbers so that you can easily make a call without having to remember or enter the phone number.













Character Map

To enter a specific alphanumeric character, press one or more times the relevant key for the required character according to the following table: once for the first character, twice for the second and so on.

Key	Characters in the displayed order
0	(spc) 0 & / .
1	- 1 @ _
2	A b C 2
3	d E F 3
4	G H I 4
5	J K L 5
6	M N O 6
7	P q R S 7
8	T U V 8
9	W X y Z 9

■ Ringer Setting

You can select your own external (from the telephone Network) or internal (from other handsets registered to the same base) ring tone and adjust the volume.

1. Press the  key.
2. Press  or  key repeatedly to choose **HS SETTING** menu, then press the  key.
3. Press  or  key to choose **RING SETUP**, and press the  key.
4. Use  or  key to choose **INT RING/EXT RING**, press the  key.
5. Press  or  key to choose **MELODY** or **VOLUME**, press the  key.

Result: You can select the ring tone from Melody 1 to 10 or adjust the volume from Volume 1 to 5, or off. When you adjust the ring tone or volume, the phone plays the selected melody or sounds the selected loudness.

6. Press the  key to confirm.

Last Number Redial





1. Press the  key in standby mode.

Result: The LCD displays the last number you dialed.

2. Press the  key to dial out the number.

Your phone allows you to retrieve the last 10 numbers you have dialed and recall them quickly.

Search for and dial a number in Redial Book





1. Press the  key in standby mode.
2. If you want to scroll through the memory, press  or  key repeatedly until you find out the number you want to dial.
3. Press the  key to dial out the number.

Notes:

- If no numbers are found, "EMPTY" is displayed.
- When the redial book is full, each time you dial a new number, the oldest number stored in the redial book is automatically erased.

Use Redial Book options

Using the redial book options, you can add a number to phone book or delete a number in the redial book.

1. Press the  key.
2. Scroll to the desired number by using the  or  key.
3. When the number appears on the display, press the  key to choose the desired option:

Menu Map

1. CID BOOK (see page 22)

2. PHONE BOOK

- ADD ENTRY (see page 31)
- CHANGE ENTRY (see page 32)
- DELETE ENTRY (see page 32)
- DELETE ALL (see page 32)
- PB STATUS (see page 32)

3. BS SETTING

- TERMINATE HS (see page 33)
- DIAL MODE (see page 26)
- FLASH TIME (see page 33)
- MODIFY PIN (see page 34)
- BS DEFAULT (see page 34)





4. HS SETTING

- ALARM (see page 35)
- AUDIO SETUP (see page 36)
- RING SETUP (see page 19)
- tone SETUP (see page 36)
- LANGUAGE (see page 24)
- HS LABEL (see page 25)
- AUTO ANSWER (see page 25)
- DATE & TIME (see page 37)
- SELECT BS (see page 38)
- HS DEFAULT (see page 38)

5. REGISTER (see page 39)

■ Menu Navigation

To access a menu option:

1. To display menu items, press the  key.
2. To scroll through menu options, press the  or  key repeatedly.
3. To select a menu, press the  key when the desired menu appears on the LCD.
4. Repeat if necessary.

To return to standby mode:



If you press the  key from any menu (not in the number or text input mode), the phone returns to the previous screen.

To return to standby mode, press the  key.



Also, the phone will automatically return to standby mode from any menu if no key is pressed in the next 40 seconds.

- **ADD TO PB:** allows you to add the number to the phone book. Complete storing the entry by starting from step 4 described in par."Adding the Phone Book Entries" (obviously, you will find the number already entered in the appropriate field).
 - **DELETE:** allows you to delete the selected number.
 - **DELETE ALL:** allows you to delete the whole redial book.
4. To exit, press the  key.

Note:

- *At step 3, when you select **DELETE** or **DELETE ALL** options, a message "**CONFIRM ?**" will further ask you to confirm the deletion. To confirm press  key, to escape press the  key.*







CID Book

When you receive a call, if the caller's information is transmitted from the network on which the call was made (and the caller doesn't hide it), the caller's phone number is displayed. Moreover, if you missed one or more calls, the  icon will appear on the LCD. If the CID memory is full, the  icon will flash on the LCD.





OUT OF AREA - This message will display when someone calls from an area where the telephone company is not offering the caller identification services or is not yet providing number delivery to your area.

PRIVATE - If the caller has exercised the option to prevent his name and number from being sent, the message will show on the LCD.

View and dial any of the CID numbers



1. Press the  key.
2. Press the  key again to choose the **CID BOOK**, and if available, the numbers are displayed. (You can also access the CID book directly by pressing the  key in standby mode.)
3. Use  or  key to view the numbers, you can make a call by a press of the  key. You can also add the entry to the phonebook.



Add CID Number to Phone Book

1. Press the  key.
2. Press the  key again to choose the **CID BOOK**, and if available, the numbers are displayed.
3. Use  or  key to view the numbers. When the desired number displays on the LCD, press the  key to enter **ADD TO PB** menu.

Handsfree

During a call, you may turn on the speakerphone built in the handset. In this mode you can simply put your handset on a surface (e.g. a desk) and enjoy the comfort of the handsfree conversation.

To turn the feature on, press the  key during a call (line engaged). The  icon appears on the LCD.

To turn the feature off, and keep on talking in normal mode, press the  key again. The  icon will disappear.

Notes:

- Before putting the handset near your ears, be sure you have turned the speakerphone off.
- To adjust the speakerphone volume, see page 18 or page 36.

Flash Signal

When the line is engaged, pressing the  key sends the Flash signal. This key is used in conjunction with special services (e.g. call waiting) which can be available in your phone network. For further details please contact your network telephone company.

To use the said special services, just press the  key while the line is engaged: the display will show **R**.

Paging

You can page the handset from the base unit making it ring with a special tone. It's useful to locate a lost handset.

Press the  key on the bottom of the base (less than 5 seconds), all the handsets registered to the base will ring for about 60 seconds.







To stop paging, press the  key on the base again or any key on the handset.



Note:

- *On a long  key press, more than or equal to 5 seconds, the base will enter subscription mode. For details, see page 39.*

Dial Mode





You can select to change the dial mode by the following steps:

1. Press the  key.
2. Press  or  key repeatedly to choose **BS SETTING**, and press the  key.
3. Press the  key to choose the **DIAL MODE**, then press the  key.





4. You can press  or  key to select the required dial mode options (**TONE/PULSE**) and press the  key. A confirm beep will be heard.



Note:

- *If you are not sure which dialing mode should be selected, please contact your local service provider.*







4. Press the  key, you are prompted to enter the name.
5. Enter the name and press the  key, then you can modify the number you want to store.
6. Press the  key, you are able to select the ring tone from Melody 1 to Melody 10, press the  key to confirm and exit, you will hear a confirm beep.

Delete a number in the CID Book

1. Press the  key.
2. Press the  key again to choose **CID BOOK**, and if available, the numbers are displayed.
3. Scroll to the number you want to delete by using  or  key.
4. When the desired number appears on the display, press the  key.

5. Use  or  key to choose **DELETE**, press the key. The display will show "**CONFIRM ?**". Press the  key to confirm, you will hear a beep and the LCD shows the next number.



Delete all numbers in the CID Book



1. Press the  key.
2. Press the  key again to choose **CID BOOK**, and if available, the numbers are displayed.
3. Press the  key and use  or  key to choose **DELETE ALL** menu, then press the  key.
4. The display shows "**CONFIRM ?**", press the  key to confirm.

Result: You hear a beep and the phone returns to the standby mode after clearing all the CID numbers.

■ Key Lock

If you turn on this feature, all keys will be locked. You can answer calls by using the  key. But when you hang up, the phone returns to the locked mode. This feature is useful to avoid pressing keys by mistake.

To lock the keys, in the standby mode just keep the  key pressed till the display shows "**HS LOCKED**" and the  icon.





To unlock the keys, keep the  key pressed again till the key lock icon  disappears from the display.







Note:

- In locked mode, if you press any key, the phone will generate a warning tone, and the "**HS LOCKED**" message will be redisplayed.

■ Selecting a Language





The handset supports multiple predefined languages. You can change the language used to display the menu messages.

1. Press the  key.
2. Press  or  key repeatedly to choose **HS SETTING**, press the  key.

3. Use  or  key to choose the **LANGUAGE**, then press the  key.
4. The languages will be displayed. Use  or  key to scroll through the options. Each language will be displayed in its own native translation.
5. Press the  key to select the required language and you will hear a confirm beep.





■ HS Name





"HS N" is the default name of the handset after registration of handset. The handset number N= 1 to 5 reflects the handset is the Nth handset, which is registered to the base. The HS Label is displayed in the standby mode. You can modify it by the following steps:







1. Press the  key.
2. Press  or  key repeatedly to choose **HS SETTING**, press the  key.

■ Auto Answer

With this feature, you can answer a call by just picking up the handset from the base without pressing any key.

1. Press the  key.
2. Press  or  key repeatedly to choose **HS SETTING**, press the  key.

3. Use  or  key to choose **HS LABEL**, then press the  key.
4. You can enter the handset name (up to 6 characters) by using the alphanumeric keys (use the  key to delete the previous character if necessary), then press  key to confirm and exit. The handset name will be modified.

3. Use  or  key to choose **AUTO ANSWER**, then press the  key.
4. Use  or  key to choose **ON/OFF** to enable/ disable the function, then press the  key, you will hear a confirm beep.